

DEVELOPMENT REVIEW BOARD MEETING
APRIL 10, 2023
6:30 PM

Public Hearing:

2. **Resolution No. 413. Precision Countertops Project.** The applicant is requesting approval of a Stage 1 Preliminary Plan, Stage 2 Final Plan, Site Design Review, Waiver, Class 3 Sign Permit, and Type C Tree Removal Plan for development of a 66,000 square foot corporate headquarters and fabrication facility on property located at 25540 SW Garden Acres Road.

Case Files:

DB22-0011 Precision Countertops

- Stage 1 Preliminary Plan (STG122-0006)
- Stage 2 Final Plan (STG222-0007)
- Site Design Review (SDR22-0007)
- Waiver (WAIV22-0003)
- Class 3 Sign Permit (SIGN22-00011)
- Type C Tree Removal Plan (TPLN22-0006)

**DEVELOPMENT REVIEW BOARD
RESOLUTION NO. 413**

A RESOLUTION ADOPTING FINDINGS AND CONDITIONS OF APPROVAL, APPROVING A STAGE 1 PRELIMINARY PLAN, STAGE 2 FINAL PLAN, SITE DESIGN REVIEW, WAIVER, CLASS 3 SIGN PERMIT, AND TYPE C TREE REMOVAL PLAN FOR DEVELOPMENT OF A 66,000 SQUARE FOOT CORPORATE HEADQUARTERS AND FABRICATION FACILITY ON PROPERTY LOCATED AT 25540 SW GARDEN ACRES ROAD.

WHEREAS, an application, together with planning exhibits for the above-captioned development, has been submitted by authorized representative MDG Architecture/Interiors on behalf of the owner/applicant, PCT NW Properties OR, LLC, dba Precision Countertops, Inc., in accordance with the procedures set forth in Section 4.008 of the Wilsonville Code, and

WHEREAS, the subject site is located at 25540 SW Garden Acres Road on Tax Lot 500, Section 2C, Township 3 South, Range 1 West, Willamette Meridian, City of Wilsonville, Washington County, Oregon, and

WHEREAS, the Planning Staff has prepared the staff report on the above-captioned subject dated April 3, 2023, and

WHEREAS, said planning exhibits and staff report were duly considered by the Development Review Board Panel A at a scheduled meeting conducted on April 10, 2023, at which time exhibits, together with findings and public testimony were entered into the public record, and

WHEREAS, the Development Review Board considered the subject and the recommendations contained in the staff report, and

WHEREAS, interested parties, if any, have had an opportunity to be heard on the subject.

NOW, THEREFORE, BE IT RESOLVED that the Development Review Board of the City of Wilsonville does hereby adopt the staff report dated April 3, 2023, attached hereto as Exhibit A1, with findings and recommendations contained therein, and authorizes the Planning Director to issue permits consistent with said recommendations for:

DB22-0011 Precision Countertops: Stage 1 Preliminary Plan (STG122-0006), Stage 2 Final Plan (STG222-0007), Site Design Review (SDR22-0007), Waiver (WAIV22-0003), Class 3 Sign Permit (SIGN22-0011) and Type C Tree Removal Plan (TPLN22-0006).

ADOPTED by the Development Review Board of the City of Wilsonville at a regular meeting thereof this 10th day of April, 2023, and filed with the Planning Administrative Assistant on _____. This resolution is final on the 15th calendar day after the postmarked date of the written notice of decision per *WC Sec 4.022(.09)* unless appealed per *WC Sec 4.022(.02)* or called up for review by the Council in accordance with *WC Sec 4.022(.03)*.

Jean Svadlenka, Chair - Panel A
Wilsonville Development Review Board

Attest:

Shelley White, Planning Administrative Assistant



Exhibit A1
Staff Report
Wilsonville Planning Division
Precision Countertops
Development Review Board Panel 'A'
Quasi-Judicial Public Hearing

Hearing Date:	April 10, 2023
Date of Report:	April 3, 2023
Application No.:	DB22-0011 Precision Countertops
Request/Summary:	The requests before the Development Review Board include a Stage 1 Preliminary Plan, Stage 2 Final Plan, Site Design Review, Waiver, Class 3 Sign Permit, and Type C Tree Removal Plan.
Location:	25540 SW Garden Acres Road. The property is specifically known as Tax Lot 500, Section 2C, Township 3 South, Range 1 West, Willamette Meridian, Washington County, Oregon
Owner/Applicant:	PCT NW Properties OR, LLC, dba Precision Countertops, Inc. (Contact: Robert Hausserman)
Authorized Representative:	MDG Architecture/Interiors (Contact: Simone O'Halloran)
Comprehensive Plan Designation:	Industrial
Zone Map Classification (Current):	Future Development 20 Acre (FD-20; Washington County)
Zone Map Classification (Proposed):	Planned Development Industrial-Regionally Significant Industrial Area (PDI-RSIA)
Staff Reviewers:	Cindy Luxhoj AICP, Associate Planner Amy Pepper, Development Engineering Manager Kerry Rappold, Natural Resources Program Manager

Staff Recommendation: **Approve with conditions** the requested Stage 1 Master Plan, Stage 2 Final Plan, Site Design Review, Waiver, Class 3 Sign Permit, and Type C Tree Removal Plan. Approval of these applications is contingent upon City Council approval of the Annexation and Zone Map Amendment requests currently under review.

Applicable Review Criteria:

<u>Development Code:</u>	
Section 4.008	Application Procedures-In General
Section 4.009	Who May Initiate Application
Section 4.010	How to Apply
Section 4.011	How Applications are Processed
Section 4.014	Burden of Proof
Section 4.031	Authority of the Development Review Board
Subsection 4.035 (.04)	Site Development Permit Application
Subsection 4.035 (.05)	Complete Submittal Requirement
Section 4.110	Zones
Section 4.118	Standards Applying to Planned Development Zones
Section 4.117 and 4.135.5	Planned Development Industrial - RSIA Zone and Industrial Standards
Section 4.134	Coffee Creek Industrial Design Overlay District
Section 4.140	Planned Development Regulations
Section 4.154	On-site Pedestrian Access and Circulation
Section 4.155	Parking, Loading, and Bicycle Parking
Section 4.167	Access, Ingress, and Egress
Section 4.171	Protection of Natural Features and Other Resources
Section 4.175	Public Safety and Crime Prevention
Section 4.176	Landscaping, Screening, and Buffering
Sections 4.199.20 through 4.199.60	Outdoor Lighting
Sections 4.300 through 4.320	Underground Utilities
Sections 4.400 through 4.440 as applicable	Site Design Review
Sections 4.600-4.640.20	Tree Preservation and Protection
<u>Other Planning Documents:</u>	
Wilsonville Comprehensive Plan	
Coffee Creek Master Plan	
Coffee Creek Industrial Design Overlay District Pattern Book	

Vicinity Map



Background:

The subject area has long been rural/semi-rural adjacent to the growing City of Wilsonville. Metro added the +/-216 gross acre area now known as the Coffee Creek Industrial Area to the Urban Growth Boundary in 2002 to accommodate future industrial growth. To guide development of the area, the City of Wilsonville adopted the Coffee Creek Industrial Master Plan in 2007. In 2018, the City adopted the Coffee Creek Industrial Area Form-based Code and accompanying Pattern Book to establish clear and objective regulations and guidelines for the street design and connectivity, site design, circulation, building form and architecture, and landscaping for future development in Coffee Creek. As part of this adoption, the Development Code was amended to enable administrative review of applications meeting all of the Form-based Code standards. Projects requesting one or more waivers are reviewed by the Development Review Board. The City also modified procedures governing City Council review of annexations and Zone Map amendments in Coffee Creek, allowing for City Council review of these requests without prior review or recommendation by the Development Review Board. This modification allows for the concurrent processing of the annexation and Zone Map amendment requests with the other related development permit applications.

The applicant, PCT NW Properties OR, LLC, dba Precision Countertops, Inc., proposes to construct a 65,800 square foot headquarters and countertop fabrication facility with a showroom, office space, storage, and fabrication spaces. The proposed development will occupy approximately 4.73 acres of the overall 9.33-acre site (after 0.30 acre right-of-way dedication for SW Garden Acres Road), leaving the eastern portion of the site undeveloped at this time with the

possibility of future expansion. Operations will primarily include receiving, unloading, storing, cutting, and delivering kitchen countertops. The proposed development is the fourth to be reviewed under the Coffee Creek standards.

The Development Review Board will review these land use applications since the applicant is requesting a waiver to Form-based Code standards. City Council held public hearings for the annexation (ANNX22-0004) and Zone Map amendment (ZONE22-0005) requests on March 20, 2023, adopting ordinances approving these requests on first reading. Second reading of these ordinances will occur on April 3, 2023. The annexation and Zone Map amendment ordinances will expire 120 days from City Council adoption if the Stage 2 Final Plan application is not approved by the Development Review Board.

Summary:

Stage 1 Preliminary Plan

The Stage 1 Preliminary Plan proposes a corporate headquarters/fabrication facility for Precision Countertops, Inc. The overall development and layout are consistent with the Coffee Creek Master Plan, Industrial Design Overlay District and Pattern Book.

Stage 2 Final Plan

The proposed Stage 2 Final Plan reviews the function and design of the Precision Countertops project, including assuring the proposal meets all the performance standards of the PDI-RSIA Zone and the Coffee Creek Industrial Design Overlay District.

Site Design Review

The proposed building is consistent with the building design standards in the Coffee Creek Industrial Design Overlay District, with an exception as noted in the waiver request. The applicant proposes a corporate headquarters/fabrication facility that contains a showroom and office space on the front façade of the building facing SW Garden Acres Road. The project will provide landscape plantings to create a natural character along the SW Garden Acres Road, including an industrial wayside in the west central part of the site consistent with the Coffee Creek Industrial Design Overlay District requirements.

Waivers

As shown in the table below, the applicant requests a waiver from Section 4.134 (.11) Development Standards Table CC-3 Site Design.

Waiver Request	
Waiver 1: Table CC-3 1. Parcel Access/Parcel Driveway Width/Supporting Streets	
Standard: 24 feet maximum, or complies with Supporting Street Standards; allowed adjustment: 10%	Request: The applicant proposes to increase the width of the east driveway to 40 feet to accommodate truck turning movements into the site from the Supporting Street, exceeding the maximum allowed width.

Class 3 Sign Permit

The subject property has frontage on SW Garden Acres Road (to west) and a public building entrance and parking area on the west side of the building. One (1) building sign is proposed on the west sign-eligible elevation of the building. No ground-mounted sign is proposed on the site.

Type C Tree Removal Plan

The subject property is generally flat, with trees located on the northwest part of the site where a house and outbuildings were located and in the north central and southeast, with numerous mature trees on the south property boundary both on and off site. A discussion of proposed tree removal is included in the Discussion Points – Verifying Compliance with the Standards section, below.

Public Comments:

No public comments were received during the comment period for the project.

Discussion Points – Verifying Compliance with Standards:

This section provides a discussion of key clear and objective development standards that apply to the proposed applications. The Development Review Board will verify compliance of the proposed applications with these standards. The ability of the proposed applications to meet these standards may be impacted by the Development Review Board’s consideration of discretionary review items as noted in the next section of this report.

Coffee Creek Land Use Review Process

Development Code Section 4.134 (Coffee Creek Industrial Design Overlay District) was written to contain clear and objective standards intended to result in automatic project approval if all criteria are met. The standards were written to allow for limited adjustments to some of the

building and site design standards. Projects meeting these standards, including any limited adjustments, are reviewed and approved by the Planning Director under the Class 2 Administrative Review Process (Clear and Objective Track). The Development Code acknowledges there may be instances where proposed development is generally consistent with the goals of the Coffee Creek Industrial Design Overlay District, but flexibility may be desired by the applicant for one or more of the clear and objective standards. In this instance, applicants may elect to request waivers to these standards, which are then reviewed by the Development Review Board (Waiver Track). When choosing the Waiver Track the applicant must demonstrate that the waiver request is consistent with the intent of the Coffee Creek Industrial Design Pattern Book and the guidelines contained therein. As this project meets all other standards intended to be clear and objective, the primary focus of the Development Review Board’s review should be the waiver requested by the applicant.

Traffic

The Traffic Impact Analysis (see Exhibit B1) performed by the City’s consultant, DKS Associates, identifies the most probable used intersections for evaluation as:

- SW Garden Acres Road/SW Ridder Road/SW Clutter Street
- SW Ridder Road/SW 95th Avenue

The Level of Service (LOS) D standard will continue to be met by existing street improvements at the studied intersections with existing, planned, and this proposed development as follows:

TABLE 3: EXISTING 2021 STUDY INTERSECTION OPERATIONS

INTERSECTION	OPERATING STANDARD	PM PEAK HOUR		
		V/C	DELAY	LOS
UNSIGNALIZED				
SW GARDEN ACRES ROAD/SW RIDDER ROAD/SW CLUTTER STREET*	LOS D	0.29	9.8	A/A
SIGNALIZED				
SW RIDDER ROAD/SW 95TH AVENUE	LOS D	0.69	21.0	C
*TWO-WAY STOP INTERSECTIONS: Delay = Average Stopped Delay per Vehicle (sec) at Worst Movement LOS = Level of Service of Major Street/Minor Street v/c = Volume-to-Capacity Ratio of Worst Movement		SIGNALIZED INTERSECTION: Delay = Average Intersection Delay (secs) v/c = Total Volume-to-Capacity Ratio LOS = Total Level of Service		

TABLE 5: FUTURE INTERSECTION OPERATIONS

INTERSECTION	OPERATING STANDARD	EXISTING + PROJECT PM			EXISTING + STAGE II PM			EXISTING + STAGE II + PROJECT PM		
		V/C	DELAY	LOS	V/C	DELAY	LOS	V/C	DELAY	LOS
UNSIGNALIZED										
SW GARDEN ACRES RD/SW RIDDER RD/SW CLUTTER ST*	LOS D	0.31	10.3	A/B	0.29	9.8	A/A	0.31	10.3	A/B
SIGNALIZED										
SW RIDDER ROAD/SW 95TH AVENUE	LOS D	0.72	21.2	C	0.72	22.0	C	0.74	22.2	C

***TWO-WAY STOP INTERSECTIONS:**

Delay = Average Stopped Delay per Vehicle (sec) at Worst Movement
 LOS = Level of Service of Major Street/Minor Street
 v/c = Volume-to-Capacity Ratio of Worst Movement

SIGNALIZED INTERSECTION:

Delay = Average Intersection Delay (secs)
 v/c = Total Volume-to-Capacity Ratio
 LOS = Total Level of Service

The project will add an additional 43 PM peak hour trips (13 in, 30 out) with a total of 294 daily trips. Of the additional trips, 19 new PM peak hour trips are estimated to pass through the I-5/Elligsen Road interchange area and 2 PM peak hour trips through the I-5/Wilsonville Road interchange area.

TABLE 4: VEHICLE TRIP GENERATION

LAND USE	LAND USE CODE	SIZE (KSF ^A)	PM PEAK HOUR			DAILY TRIPS
			ENTER TRIPS	EXIT TRIPS	TOTAL TRIPS	
MANUFACTURING ^B	140	18.0	5	9	14	86
OFFICE	710	7.8	4	16	20	126
FURNITURE STORE ^B	890	3.0	1	1	2	19
WAREHOUSE/STORAGE ^B	150	37.0	3	4	7	63
TOTAL		65.8	13	30	43	294

^A KSF = 1,000 square feet

^B Number of trips is based on the average rate.

Industrial Performance Standards

The PDI-RSIA zone prohibits development not meeting an extensive list of performance standards including wholly enclosed operations, no off-site vibrations, no off-site odors, screened outdoor storage, no heat or glare, no dangerous substances, no waste storage attracting pests, sewer conveyance meeting City standards, no noise violating the City’s noise ordinance, no electrical disturbances, limits on air pollution, and no open burning. The proposed development can meet all the performance standards.

Vehicular and Bicycle Parking

The Precision Countertops project requires a minimum of 62 vehicle parking spaces and, as it contains a planned manufacturing component, no maximum limit exists for the number of spaces. The applicant proposes 71 stalls, 15 in the west parking area at the front of the building and 56 in the east parking area for employees, the exceeding the minimum amount required.

Required bicycle parking is calculated as the sum of the requirements for the individual primary uses. The applicant proposes 13 bicycle parking spaces, six (6) at the front of the building and seven (7) long-term spaces inside the warehouse portion of the building, which is three (3) fewer than the minimum required for the project. A condition of approval has been included to ensure 16 spaces are provided consistent with the standard.

Tree Removal and Replacement

Of 22 inventoried on-site trees, four (4) are stumps, two (2) are dead, nine (9) in the west part of the site are proposed for removal, and seven (7) will be retained on the east side of the site where development is expected to occur in the future. Of an additional 57 inventoried trees along the south property boundary, most are off-site, but some have not been determined to be on-site or off-site. All 57 trees are proposed to be retained and protected during construction (see Exhibit B6). The Tree Removal Plan in the applicant's plan set (Sheet L1.1 in Exhibit B2 and Exhibit B6) includes tree protection fencing around the root protection zone of the retained trees in the development area (west half of the site) for the current application to protect them during construction.

Discussion Points – Discretionary Review:

This section provides a discussion of discretionary review requests that are included as part of the proposed applications. The Development Review Board may approve or deny items in this section based upon a review of evidence submitted by the applicant.

Waiver to Coffee Creek Industrial Design Overlay District Standards

The applicant requests to waive the driveway width standards from the Coffee Creek Design Overlay District for the east site access from the Supporting Street. This driveway is proposed to be 40 feet wide to accommodate truck turning movements into the site from the Supporting Street. This requires a waiver from Subsection 4.134 (.11) Table CC-3 1. Parcel Access/Parcel Driveway Width/Supporting Streets, which allows a driveway width of 24 feet maximum or compliance with the Supporting Street standards. This is the only waiver requested by the applicant to the Coffee Creek Design Overlay District standards. The waiver request is outlined in the Summary section, above, and discussed in detail under Request D, later in this staff report.

Conclusion and Conditions of Approval:

Staff has reviewed the applicant's analysis of compliance with the applicable criteria. The Staff Report adopts the applicant's responses as Findings of Fact except as noted in the Findings. Based on the Findings of Fact and information included in this Staff Report, and information received from a duly advertised public hearing, staff recommends that the Development Review Board approve, with the conditions below, the proposed Stage 1 Preliminary Plan, Stage 2 Final Plan, Site Design Review, Waiver, Class 3 Sign Permit, and Type C Tree Plan (DB22-0011).

Planning Division Conditions:

Request A: Stage 1 Preliminary Plan (STG122-0006)

<p>PDA 1. <u>General:</u> Minor changes in an approved preliminary development plan may be approved by the Planning Director through the Class 1 Administrative Review Process if such changes are consistent with the purposes and general character of the development plan and other changes as authorized by the Development Code to be reviewed through a Class 2 Administrative Review Process. All other modifications, including extension or revision of the staged development schedule, shall be processed in the same manner as the original application and shall be subject to the same procedural requirements.</p>

Request B: Stage 2 Final Plan (STG222-0007)

<p>PDB 1. <u>General:</u> The approved final plan and staged development schedule shall control the issuance of all building permits and shall restrict the nature, location and design of all uses. Minor changes in an approved final development plan may be approved by the Planning Director through the Class 1 Administrative Review Process if such changes are consistent with the purposes and general character of the development plan and other changes as authorized by the Development Code to be reviewed through a Class 2 Administrative Review Process. All other modifications, including extension or revision of the staged development schedule, shall be processed in the same manner as the original application and shall be subject to the same procedural requirements.</p>
--

<p>PDB 2. <u>Prior to Final Occupancy:</u> All exterior, roof and ground mounted, mechanical and utility equipment shall be screened from ground level off-site view from adjacent streets or properties. See Finding B40.</p>

<p>PDB 3. <u>Prior to Non-Grading Building Permit Issuance:</u> The applicant shall provide an additional three (3) bicycle parking spaces, one (1) of which shall be long-term, in addition to the 13 spaces shown on the site plans, to comply with the required 16 spaces based on proposed mix of uses within the building. The applicant shall provide details of the long-term (interior) bicycle racks and demonstrate how the racks will meet dimensional, spacing, and anchoring standards. See Findings B81 through B90.</p>

<p>PDB 4. <u>Prior to Final Occupancy:</u> All travel lanes shall be constructed to be capable of carrying a twenty-three (23) ton load. See Finding B113.</p>

Request C: Site Design Review (SDR22-0007)

<p>PDC 1. <u>Ongoing:</u> Construction, site development, and landscaping shall be carried out in substantial accord with the DRB-approved plans, drawings, sketches, and other documents. Minor revisions may be approved by the Planning Director through administrative review pursuant to Section 4.030.</p>
<p>PDC 2. <u>Prior to Temporary Occupancy:</u> All landscaping required and approved by the DRB shall be installed prior to occupancy of the proposed development unless security equal to one hundred and ten percent (110%) of the cost of the landscaping as determined by the Planning Director is filed with the City assuring such installation within six (6) months of occupancy. "Security" is cash, certified check, time certificates of deposit, assignment of a savings account or such other assurance of completion as shall meet with the approval of the City Attorney. In such cases the developer shall also provide written authorization, to the satisfaction of the City Attorney, for the City or its designees to enter the property and complete the landscaping as approved. If the installation of the landscaping is not completed within the six-month period, or within an extension of time authorized by the DRB, the security may be used by the City to complete the installation. Upon completion of the installation, any portion of the remaining security deposited with the City will be returned to the applicant. See Finding C27.</p>
<p>PDC 3. <u>Ongoing:</u> The approved landscape plan is binding upon the applicant/owner. Substitution of plant materials, irrigation systems, or other aspects of an approved landscape plan shall not be made without official action of the Planning Director or DRB, pursuant to the applicable sections of Wilsonville's Development Code. See Findings C28 and C30.</p>
<p>PDC 4. <u>Ongoing:</u> All landscaping shall be continually maintained, including necessary watering, weeding, pruning, and replacing, in a substantially similar manner as originally approved by the DRB, unless altered as allowed by Wilsonville's Development Code. See Finding C29.</p>
<p>PDC 5. <u>Prior to Temporary Occupancy:</u> The following requirements for planting of shrubs and ground cover shall be met:</p> <ul style="list-style-type: none">• Non-horticultural plastic sheeting or other impermeable surface shall not be placed under landscaping mulch.• Native topsoil shall be preserved and reused to the extent feasible.• Surface mulch or bark dust shall be fully raked into soil of appropriate depth, sufficient to control erosion, and shall be confined to areas around plantings.• All shrubs shall be well branched and typical of their type as described in current AAN Standards and shall be equal to or better than 2-gallon containers and 10- to 12-inch spread.• Shrubs shall reach their designed size for screening within 3 years of planting.• Ground cover shall be equal to or better than the following depending on the type of plant materials used: gallon containers spaced at 4 feet on center

	<p>minimum, 4-inch pot spaced 2 feet on center minimum, 2-1/4-inch pots spaced at 18 inches on center minimum.</p> <ul style="list-style-type: none"> • No bare root planting shall be permitted. • Ground cover shall be sufficient to cover at least 80% of the bare soil in required landscape areas within 3 years of planting. • Appropriate plant materials shall be installed beneath the canopies of trees and large shrubs to avoid the appearance of bare ground in those locations. • Compost-amended topsoil shall be integrated in all areas to be landscaped, including lawns. See Finding C36.
PDC 6.	<u>Prior to Temporary Occupancy:</u> All trees shall be balled and burlapped, and conform in grade to “American Standards for Nursery Stock” current edition. Tree size shall be a minimum of two (2)-inch caliper. See Finding C37.
PDC 7.	<u>Prior to Temporary Occupancy:</u> Plant materials shall be installed and irrigated to current industry standards and be properly staked to ensure survival. Plants that die shall be replaced in kind, within one growing season, unless appropriate substitute species are approved by the City. See Finding C42.
PDC 8.	<u>Prior to Non-Grading Building Permit Issuance:</u> Final review of the proposed building lighting’s conformance with the Outdoor Lighting Ordinance will be determined at the time of Building Permit issuance. See Findings C45 through C53.

Request D: Waiver (WAIV22-0003)

No conditions for this request

Request E: Class 3 Sign Review (SIGN22-0011)

PDE 1.	<u>Ongoing:</u> The approved sign shall be installed in a manner substantially similar to the plans approved by the DRB and stamped approved by the Planning Division.
PDE 2.	<u>Prior to Sign Installation/Ongoing:</u> The applicant/owner of the property shall obtain all necessary building and electrical permits for the approved sign, prior to installation, and shall ensure that the sign is maintained in a commonly-accepted, professional manner.
PDE 3.	<u>Prior to Sign Installation/Ongoing:</u> The applicant/owner of the property shall apply for a Class 1 Sign Permit to determine compliance of the proposed wall sign with the standard for placement within a definable sign band, fascia, or architectural feature that allows a definable space between the sign and the top and bottom of the sign band, fascia, or architectural feature; and with the standard for allowed area, based on length of the west building façade, use of the individual elements measurement method, and Site Design Review standards. See Findings E8, E9 and E12.

Request F: Type C Tree Removal Plan (TPLN22-0006)

PDF 1.	General: This approval for removal applies only to the nine (9) on-site trees identified in the applicant's submitted materials. All other trees on the property and off-site along the south property boundary shall be maintained unless removal is approved through separate application.
PDF 2.	Prior to Grading Permit Issuance: The applicant shall submit an application for a Type 'C' Tree Removal Permit, together with the applicable fee. In addition to the application form and fee, the applicant shall provide the City's Planning Division an accounting of trees to be removed within the project site, corresponding to the approval of the DRB. The applicant shall not remove any trees from the project site until the tree removal permit, including the final tree removal plan, have been approved by Planning Division staff.
PDF 3.	Prior to Temporary Occupancy/Ongoing: The permit grantee or the grantee's successors-in-interest shall cause the replacement trees to be staked, fertilized and mulched, and shall guarantee the trees for two (2) years after the planting date. A "guaranteed" tree that dies or becomes diseased during the two (2) years after planting shall be replaced. See Findings F10 through F12.
PDF 4.	Prior to Commencing Site Grading: Prior to site grading or other site work that could damage trees, the applicant/owner shall install 6-foot-tall chain-link fencing around the drip line of preserved trees. Removal of the fencing around the identified trees shall only occur if it is determined the trees are not feasible to retain. The fencing shall comply with Wilsonville Public Works Standards Detail Drawing RD-1230. Fencing shall remain until authorized in writing to be removed by Planning Division. See Finding F13.

The following Conditions of Approval are provided by the Engineering, Natural Resources, or Building Divisions of the City's Community Development Department or Tualatin Valley Fire and Rescue, all of which have authority over development approval. A number of these Conditions of Approval are not related to land use regulations under the authority of the Development Review Board or Planning Director. Only those Conditions of Approval related to criteria in Chapter 4 of Wilsonville Code and the Comprehensive Plan, including but not limited to those related to traffic level of service, site vision clearance, recording of plats, performance standards, and concurrency, are subject to the Land Use review and appeal process defined in Wilsonville Code and Oregon Revised Statutes and Administrative Rules. Other Conditions of Approval are based on City Code chapters other than Chapter 4, state law, federal law, or other agency rules and regulations. Questions or requests about the applicability, appeal, exemption or non-compliance related to these other Conditions of Approval should be directed to the City Department, Division, or non-City agency with authority over the relevant portion of the development approval.

Engineering Division Conditions:

PFA 1.	<u>Prior to Issuance of Public Works Permit:</u> Public Works Plans and Public Improvements shall conform to the “Public Works Plan Submittal Requirements and Other Engineering Requirements” in Exhibit C1.
PFA 2.	<u>Prior to Issuance of Public Works Permit:</u> Submit site plans to Engineering showing street improvements including the driveway approach along SW Garden Acres Road, public water main and hydrants, and stormwater facilities. Improvements shall be constructed in accordance with the Public Works Standards.
PFA 3.	<u>With the Public Works Permit:</u> The construction drawings shall show all necessary temporary water line looping to avoid long dead-end water lines.
PFA 4.	<u>Prior to the Issuance of Public Works Permit:</u> A final stormwater report shall be submitted for review and approval. The stormwater report shall include information and calculations to demonstrate how the proposed development meets the treatment and flow control requirements.
PFA 5.	<u>Prior to Issuance of any City Permits:</u> Applicant shall obtain an NPDES 1200C permit from the Oregon Department of Environmental Quality and a Local Erosion Control Permit from the City of Wilsonville. All erosion control measures shall be in place prior to starting any construction work, including any demolition work. Permits shall remain active until all construction work is complete and the site has been stabilized.
PFA 6.	<u>With the Building Permit:</u> The construction drawings shall show the location of any existing septic system(s). <u>Prior to Final Building Certificate of Occupancy:</u> Submit documentation that any existing on-site septic system(s) were properly decommissioned per the requirements of OAR 340-071-0185.
PFA 7.	<u>With the Building Permit:</u> The construction drawings shall show the location of the existing well(s). <u>Prior to Final Building Certificate of Occupancy:</u> Submit documentation that the existing well serving this property was properly abandoned in accordance with OAR 690-240 and the Water Resources Department requirements.
PFA 8.	<u>Prior to Final Building Certificate of Occupancy:</u> The applicant shall record a public access and utility easement agreement over the Supporting Street.
PFA 9.	<u>Prior to Final Building Certificate of Occupancy:</u> The applicant shall dedicate all necessary 15-foot water line easements. All fire hydrants and water lines serving those fire hydrants shall be publicly owned. Any portion of that system that is located outside of the right-of-way shall be located in a 15-foot easement.
PFA 10.	<u>Prior to Issuance of Any Occupancy Permits:</u> All public infrastructure improvements including but not limited to street, stormwater drainage, water quality and flow control, sanitary sewer, and water facilities shall be substantially complete with approval from the Community Development Director pursuant to Section 4.220 of the Development Code.
PFA 11.	<u>Prior to Issuance of Final Building Certificate of Occupancy:</u> The applicant shall provide a site distance certification by an Oregon Registered Professional Engineer for all driveway access per the Traffic Impact Study.

PFA 12. Prior to Issuance of Final Building Certificate of Occupancy: A 12-inch public water main extension along the Supporting Street shall be constructed and completed. Oversized water mains larger than 8 inches are eligible for System Development Charge (SDC) Credits. When eligible, SDC credits will be issued in accordance with City Code Section 11.110.

PFA 13. Prior to Any Paving: Onsite stormwater facilities must be constructed and vegetated facilities planted. **Prior Issuance of Final Building Certificate of Occupancy:** The applicant must execute and record with the County a Stormwater Maintenance and Access Easement Agreement with the City.

Master Exhibit List:

Entry of the following exhibits into the public record by the DRB confirms its consideration of the application as submitted. The exhibit list below includes exhibits for Planning Case File DB22-0011 and reflects the electronic record posted on the City's website and retained as part of the City's permanent electronic record. Any inconsistencies between printed or other electronic versions of the same Exhibits are inadvertent and the version on the City's website and retained as part of the City's permanent electronic record shall be controlling for all purposes.

Planning Staff Materials

- A1. Staff report and findings (this document)
- A2. Staff's Presentation Slides for Public Hearing (to be presented at Public Hearing)
- A3. Staff Memorandum to Development Review Board Dated March 27, 2023

Materials from Applicant

- B1. **Applicant's Narrative and Materials** – *Available Under Separate Cover*
 - Land Use Application Form
 - Land Use Narrative
 - Development Schedule
 - Stage 1 Site Plan
 - Materials Board
 - Drainage Analysis and Geotechnical Report
 - Letter Regarding Maintenance of Stormwater Facility
 - Memorandum Regarding Gravel Access Road
 - Transportation Impact Study
 - Republic Services Provider Letter
 - TVF&R Permit
 - Inventory of South Boundary Trees
- B2. **Applicant's Drawings and Plans** – *Available Under Separate Cover*
- B3. Incompleteness Response Dated November 9, 2022
- B4. Compliance Response Dated January 6, 2023
- B5. 120-day Waiver Request Dated 02.09.2023
- B6. Memorandum with Supplemental Information Dated April 3, 2023

Development Review Team Correspondence

- C1. Public Works Plan Submittal and Other Engineering Requirements

Other Correspondence

None Received

Procedural Statements and Background Information:

1. The statutory 120-day time limit applies to this application. The application was received on July 8, 2022. Staff conducted a completeness review within the statutorily allowed 30-day review period and found the application to be incomplete on August 5, 2022. The applicant submitted additional materials on November 14, 2022. Staff conducted a second completeness review within the statutorily allowed 30-day review period and deemed the application complete on December 14, 2022. Based on this completeness date, the 120-day period within which the City must render a final decision for the request, including any appeals, was April 13, 2023. However, on February 9, 2023, the applicant requested a waiver of the 120-day rule to allow additional time for the City to process their land use application, extending the review period to and through May 3, 2023.

2. Surrounding land uses are as follows:

Compass Direction	Zone:	Existing Use:
North:	FD-20 (Washington County)	Rural Residential
East:	FD-20	Rural Residential
South:	PDI	Rural Residential
West:	FD-20	Rural Residential and Contractors' Establishment

3. Previous Planning Approvals:

- ANN22-0004 Annexation (under concurrent review by City Council; Ordinance No. 875)
- ZONE22-0005 Zone Map Amendment (under concurrent review by City Council; Ordinance No. 876)

4. The applicant has complied with Sections 4.008 through 4.011, 4.013-4.031, 4.034 and 4.035 of the Wilsonville Code, said sections pertaining to review procedures and submittal requirements. The required public notices have been sent and all proper notification procedures have been satisfied.

Findings of Fact:

NOTE: Pursuant to Section 4.014 the burden of proving that the necessary findings of fact can be made for approval of any land use or development application rests with the applicant in the case.

General Information

Application Procedures-In General

Section 4.008

The application is being processed in accordance with the applicable general procedures of this Section.

Initiating Application

Section 4.009

The application has been submitted on behalf of the property owner, PCT NW Properties OR, LLC, dba Precision Countertops, Inc., and is signed by an authorized representative.

Pre-Application Conference

Subsection 4.010 (.02)

A pre-application conference was held on July 22, 2021 (PA21-0019) in accordance with this subsection.

Lien Payment before Approval

Subsection 4.011 (.02) B.

No applicable liens exist for the subject property. The application can thus move forward.

General Submission Requirements

Subsection 4.035 (.04) A.

The applicant has provided all of the applicable general submission requirements contained in this subsection.

Zoning-Generally

Section 4.110

This proposed development is in conformity with the applicable zoning district and City review uses the general development regulations listed in Sections 4.150 through 4.199.

Request A: Stage 1 Preliminary Plan (STG122-0006)

As described in the Findings below, the request meets the applicable criteria or will by conditions of approval.

Planned Development Regulations

Planned Development Purpose & Lot Qualifications
Subsections 4.140 (.01) and (.02)

A1. The property is of sufficient size to be developed in a manner consistent the purposes and objectives of Section 4.140. The subject property is greater than 2 acres and is designated for industrial development in the Comprehensive Plan. Concurrent with the request for a Stage 1 Preliminary Plan, the applicant has requested annexation of the property and rezoning to PDI-RSIA (Planned Development Industrial-Regionally Significant Industrial Area). These requests were approved on 1st Reading by the City Council on March 20, 2023, and are scheduled for 2nd Reading on April 3, 2023 (Ordinances No. 875 (ANNX22-0004) and No. 876 (ZONE22-0005)). The property will be developed as a planned development in accordance with this subsection.

Ownership Requirements
Subsection 4.140 (.03)

A2. All the land subject to change under the proposal is under a single ownership.

Professional Design Team
Subsection 4.140 (.04)

A3. As can be found in the applicant's submitted materials, appropriate professionals have been involved in the planning and permitting process. Simone O'Halloran, with MDG Architecture/Interiors, is the applicant's representative.

Planned Development Permit Process
Subsection 4.140 (.05)

A4. The subject property is greater than two (2) acres, is designated for industrial development in the Comprehensive Plan, and is proposed to be zoned Planned Development Industrial-Regionally Significant Industrial Area (PDI-RSIA); see Finding A1. The property will be developed as a planned development in accordance with this subsection.

Consistency with Comprehensive Plan and Other Applicable Plans
Subsection 4.140 (.06) and 4.140 (.09) J. 1.

A5. The proposed project, as found elsewhere in this report, complies with the Planned Development Industrial-Regionally Significant Industrial Area zoning designation, which implements the Comprehensive Plan designation of Industrial for this property.

Application Requirements

Subsection 4.140 (.07)

A6. Review of the proposed Stage 1 Preliminary Plan has been scheduled for a public hearing before the Development Review Board, in accordance with this subsection, and the applicant has met all the applicable submission requirements as follows:

- The property affected by the Stage 1 Preliminary Plan is under the sole ownership of PCT NW Properties OR, LLC, dba Precision Countertops, Inc., and the application has been signed by the property owners.
- The application for a Stage 1 Preliminary Plan has been submitted on a form prescribed by the City.
- The professional design team and coordinator have been identified. See Findings A3 and B3.
- The applicant has stated the various uses involved in the Stage 1 Preliminary Plan and their locations.
- The boundary affected by the Stage 1 Preliminary Plan has been clearly identified and legally described.
- Sufficient topographic information has been submitted.
- Information on the land area to be devoted to various uses has been provided.
- Any necessary performance bonds will be required.
- Waiver information has been submitted.

Planned Development Industrial-Regionally Significant Industrial Area (PDI-RSIA) Zone

Purpose of PDI-RSIA

Subsection 4.135.5 (.01)

A7. The uses proposed in the Stage 1 Preliminary Plan area are limited to industrial uses allowed in the PDI-RSIA zone, supporting the purpose stated in this subsection.

Uses Typically Permitted

Subsection 4.135.5 (.03)

A8. The proposed development consists of a corporate headquarters/fabrication facility where the intended uses include showroom, office, storage, and fabrication spaces for receiving, unloading, storing, cutting, and delivering kitchen countertops. These uses are consistent with the uses typically permitted in the PDI-RSIA zone and are, therefore, allowed uses.

Prohibited Uses

Subsection 4.135.5 (.04)

A9. No prohibited uses are proposed by the applicant. Performance standards will be required to be met as part of the Stage 2 Final Plan review.

Block and Access Standards

Subsections 4.135.5 (.05) and 4.131 (.03)

A10. The subject property is located within the Coffee Creek Design Overlay District and, therefore, subject to the Regulating Plan in Figure CC-1, which identifies SW Garden Acres Road as “Existing/Planned Addressing Street” and “Required Supporting Streets” along the property’s north and east boundaries. No additional required Supporting Streets are identified abutting the subject property. Therefore, no additional streets are required at this location to satisfy the applicable block and access standards.

PDI -RSIA Performance Standards

Industrial Performance Standards

Subsections 4.135 (.06) A. through N.

A11. The Stage 1 Preliminary Plan enables conformance with the industrial performance standards. Final compliance will be reviewed with the Stage 2 Final Plans. See Finding B26.

Other Standards for PDI -RSIA Zone

Lot Size

Subsections 4.135.5 (.07) A.

A12. Nothing in the Stage 1 Preliminary Plan would prevent lot size requirements from being met.

Setbacks

Subsections 4.135.5 (.07) C. through E.

A13. Nothing in the Stage 1 Preliminary Plan would prevent setback requirements from being met.

Coffee Creek Industrial Design Overlay District

Purpose of Coffee Creek Industrial Design Overlay District – High Quality Site Design

Subsection 4.134 (.01) A.

A14. The proposed development features a high-quality industrial building as a corporate headquarters/fabrication facility for a single tenant. The proposed site plan responds to the existing site by orienting the building and circulation areas to occupy roughly the western half of the subject site, maintaining the eastern half in its undeveloped state until it is developed in the future. Proposed high quality landscaping is consistent with the Coffee Creek Design Overlay District by providing a dense planted area along SW Garden Acres Road, along with a wayside area that has been designed to connect with the public sidewalk system and provide sightlines into the seating area for additional safety. Dense landscaping along the Supporting Street helps to soften the profile of the building along the street and obscure views of the truck maneuvering and loading berth area located on the east side of the proposed building.

Purpose of Coffee Creek Industrial Design Overlay District – Multi-Modal Transportation Network

Subsection 4.134 (.01) B.

A15. Street improvements, including sidewalks and a buffered bike lane providing multi-modal access to the site, were recently constructed on the east side of SW Garden Acres Road as part of a City-funded capital improvement project. The applicant proposes on-site landscaping and circulation that integrate with these improvements consistent with the SW Garden Acres Road cross-section as prescribed in the Coffee Creek Industrial Design Pattern Book. The applicant also proposes Supporting Street improvements on the north side of the property to the eastern extent of the developed area in two phases, including an interim driveway access on SW Garden Acres Road that will transition to a driveway off the Supporting Street when the property to the north develops in the future. The proposed Supporting Street cross-section is consistent with that prescribed in the Coffee Creek Industrial Design Pattern Book. The east half of the Supporting Street along the north property boundary and the Supporting Street along the east boundary will be constructed when the remainder of the site is developed in the future.

Purpose of Coffee Creek Industrial Design Overlay District – Preservation of Natural Features

Subsection 4.134 (.01) C.

A16. The site contained a house and outbuildings for residential and agricultural use on the western portion of the property; however, these structures have since been demolished by the property owner. There is an open area in the center and mature trees in the western and eastern parts of the property. As described in the applicant’s narrative, in an effort to maintain and create habitat-friendly development, the applicant has elected to leave more than half the overall site in a natural grassy state until future development occurs and maintained existing trees where possible, concentrated in the site’s southeast corner.

Purpose of Coffee Creek Industrial Design Overlay District – Minimize Adverse Impacts

Subsection 4.134 (.01) D.

A17. The proposed development will meet the required buffering and screening requirements and industrial performance standards, thereby minimizing impacts on adjacent properties.

Purpose of Coffee Creek Industrial Design Overlay District – Minimize Visibility of Parking and Circulation Areas

Subsection 4.134 (.01) E.

A18. The applicant has minimized the visibility of parking, circulation, and loading areas to the greatest extent possible by including plantings along SW Garden Acres Road and the Supporting Street. Vehicular parking areas have been provided along the west and east sides of the property and are screened by landscaping from adjacent properties.

Purpose of Coffee Creek Industrial Design Overlay District – Pleasant and Functional Industrial District

Subsection 4.134 (.01) F.

A19. The proposed landscaping, wayside, pedestrian pathways, and parking screening will contribute toward the creation of a pleasant and functional industrial district for employees and visitors.

Purpose of Coffee Creek Industrial Design Overlay District – Timely and Predictable Process

Subsection 4.134 (.01) G.

A20. The proposed application is being reviewed consistent with the procedures identified in the Development Code and Coffee Creek Industrial Design Pattern Book.

Applicability of Coffee Creek Industrial Design Overlay District

Subsection 4.134 (.02) A.-D.

A21. The proposal is for the construction of a new building, therefore, the regulations of Section 4.134 apply.

Exceptions to Coffee Creek Industrial Design Overlay District

Subsection 4.134 (.03) A.-D.

A22. The proposed development does not include any activities subject to these exceptions.

Uses Typically Permitted

Subsection 4.134 (.04)

A23. The proposed use as a corporate headquarters/fabrication facility is permitted per Section 4.135.5 (.03). See Finding A8.

Prohibited Uses

Subsection 4.134 (.05)

A24. The proposed use is not prohibited per Subsection 4.135.5 (.03).

Request B: Stage 2 Final Plan (STG222-0007)

As described in the Findings below, the request meets the applicable criteria or will by conditions of approval.

Planned Development Regulations-Generally

Planned Development Purpose and Lot Qualifications

Subsections 4.140 (.01) and (.02)

B1. The proposed Stage 2 Final Plan is consistent with the Planned Development Regulations and is of sufficient size to be developed in a manner consistent with the purposes and objectives of Section 4.140. The subject property is greater than two (2) acres and is

designated for industrial development in the Comprehensive Plan. Concurrently with the request for a Stage 2 Final Plan, the applicant proposes to rezone the property to PDI-RSIA (Planned Development Industrial-Regionally Significant Industrial Area); see Finding A1. The property will be developed as a planned development in accordance with this subsection.

Ownership Requirements

Subsection 4.140 (.03)

- B2.** The land included in the proposed Stage 2 Final Plan is under the ownership of PCT NW Properties OR, LLC, dba Precision Countertops, Inc. and the application has been signed by an authorized representative.

Professional Design Team

Subsection 4.140 (.04)

- B3.** As can be found in the applicant's submitted materials, appropriate professionals have been involved in the planning and permitting process. Simone O'Halloran, with MDG Architecture/Interiors, has been designated the coordinator for the planning portion of the project.

Planned Development Permit Process

Subsection 4.140 (.05)

- B4.** The subject property is greater than two (2) acres, is designated for industrial development in the Comprehensive Plan, and is intended to be zoned PDI-RSIA. The property will be developed as a planned development in accordance with this subsection.

Stage 2 Final Plan Submission Requirements and Process

Timing of Submission

Subsection 4.140 (.09) A.

- B5.** The applicant is requesting both Stage 1 Preliminary Plan and Stage 2 Final Plan approval, together with Site Design Review, as part of this application. The Stage 2 Final Plan provides sufficient information regarding conformance with both the Stage 1 Preliminary Plan and Site Design Review.

Development Review Board Role

Subsection 4.140 (.09) B.

- B6.** The Development Review Board (DRB) is considering all applicable permit criteria set forth in the Planning and Land Development Code and staff is recommending the DRB approve the application with conditions of approval.

Stage 1 Conformance, Submission Requirements
Subsection 4.140 (.09) C.

- B7.** The Stage 2 Final Plan substantially conforms to the proposed Stage 1 Preliminary Plan, which has been submitted concurrently. The applicant has provided the required drawings and other documents showing all the additional information required by this subsection.

Stage 2 Final Plan Detail
Subsection 4.140 (.09) D.

- B8.** The applicant has provided sufficiently detailed information to indicate fully the ultimate operation and appearance of the development, including a detailed site plan, landscape plans, and elevation drawings.

Submission of Legal Documents
Subsection 4.140 (.09) E.

- B9.** No additional legal documentation is required for dedication or reservation of public facilities.

Expiration of Approval
Subsection 4.140 (.09) I. and Section 4.023

- B10.** The Stage 2 Final Plan approval, along with other associated applications, will expire two (2) years after approval, unless an extension is approved in accordance with these subsections. The applicant intends to construct the proposed building in one (1) implementation phase promptly after land use approval, and well within the allotted time period.

Consistency with Plans
Subsection 4.140 (.09) J. 1.

- B11.** As documented in the applicant's materials, the proposed development of a corporate headquarters/fabrication facility is consistent with the planned economic uses and activities and the form of development the City's planning work has been designed to foster and support. This project is the fourth project in the Coffee Creek Master Plan area that is being reviewed with the Coffee Creek Industrial Design Overlay District and Pattern Book. The property is intended to be zoned Planned Development Industrial-Regionally Significant Industrial Area (PDI-RSIA) consistent with the Industrial designation in the Comprehensive Plan. To staff's knowledge, the location, design, size, and uses are consistent with other applicable plans, maps, and ordinances, or will be by specific conditions of approval.

Traffic Concurrency

Subsection 4.140 (.09) J. 2.

- B12.** As shown in Traffic Impact Study, included in Exhibit B1, the LOS D standard will continue to be met by existing street improvements at the studied intersections with existing, planned, and this proposed development as follows:
- SW Garden Acres Road/SW Ridder Road/SW Clutter Street: LOS A/B, Volume-to-Capacity Ratio 0.31
 - SW Ridder Road/SW 95th Avenue: LOS C, Volume-to-Capacity Ratio 0.74

Facilities and Services Concurrency

Subsection 4.140 (.09) J. 3.

- B13.** The proposed development will be adequately served by existing or immediately planned facilities and services as required by this standard. Frontage improvements were previously completed as part of the SW Garden Acres capital improvement project and right-of-way dedications in SW Garden Acres Road and the new Supporting Street along the north property boundary are required by Engineering conditions of approval consistent with City design sections for these streets. These facilities will provide access to the site consistent with access spacing requirements that apply to SW Garden Acres Road and will enable the property to the north and east to obtain access via the Supporting Street without adding driveways on this SW Garden Acres Road. Utility services capable of serving the site are in place in SW Garden Acres Road. Extensions and connections will be made pursuant to Public Works standards and permitting.

Adherence to Approved Plans

Subsection 4.140 (.10) A.

- B14.** A condition of approval ensures adherence to approved plans except for minor revisions by the Planning Director.

Standards Applying in All Planned Development Zones

Additional Height Guidelines

Subsection 4.118 (.01)

- B15.** Staff does not recommend the Development Review Board require a height less than the applicant proposes as the building height provides for fire protection access, does not abut a low density zone, and does not impact scenic views of Mt. Hood or the Willamette River.

Underground Utilities

Subsection 4.118 (.02)

- B16.** All utilities on the property are required to be underground.

Waivers

Subsection 4.118 (.03)

- B17.** The applicant is requesting one (1) waiver, see Request D.

Other Requirements or Restrictions

Subsection 4.118 (.03) E.

- B18.** No additional requirements or restrictions are recommended pursuant to this subsection. Performance standards and requirements of the PDI-RSIA zone address potential impacts from noise, odor, glare, etc.

Impact on Development Cost

Subsection 4.118 (.04)

- B19.** In staff's professional opinion, the determination of compliance or attached conditions of approval do not unnecessarily increase the cost of development, and no evidence has been submitted to the contrary.

Requiring Tract Dedications

Subsection 4.118 (.05)

- B20.** No additional tracts are being required. A public access and utility easement agreement is required over the Supporting Street per Engineering conditions of approval.

Habitat Friendly Development Practices

Subsection 4.118 (.09)

- B21.** Grading will be limited to that needed for the proposed improvements, no significant native vegetation would be retained by an alternative site design, the City's stormwater standards will be met limiting adverse hydrological impacts on water resources, and no impacts on significant wildlife corridors or fish passages have been identified.

Planned Development Industrial-Regionally Significant Industrial Area (PDI-RSIA) Zone

Purpose of PDI-RSIA

Subsection 4.135.5 (.01)

- B22.** The proposed development consists of a corporate headquarters/fabrication facility where the intended uses include showroom, office, storage, and fabrication spaces for receiving, unloading, storing, cutting, and delivering kitchen countertops. This meets the purpose statement of the PDI-RSIA zone as it provides for a regionally significant industrial operation and employment opportunities on an underutilized industrial site.

Uses Typically Permitted

Subsection 4.135.5 (.03)

- B23.** A corporate headquarters/fabrication facility with showroom, office, storage, and fabrication spaces is consistent with the permitted uses in the PDI-RSIA zone.

Prohibited Uses

Subsection 4.135.5 (.04)

B24. The applicant is not requesting approval for any prohibited use.

Block and Access Standards

Subsections 4.135.5 (.05) and 4.131 (.03)

B25. The subject property is in the Coffee Creek Industrial Design Overlay District and, therefore, subject to the Regulating Plan in Figure CC-1, which identifies SW Garden Acres as an existing/planned Addressing Street. The regulating plan also identifies future required Supporting Streets bordering the subject property along its north and east boundaries.

PDI -RSIA Performance Standards

Industrial Performance Standards

Subsections 4.135 (.06) A. through N.

B26. The proposed project meets the performance standards of this subsection as follows:

- **Pursuant to Standard A** (enclosure of uses and activities), all non-parking/loading activities and uses are completely enclosed within the proposed building.
- **Pursuant to Standard B** (vibrations), there is no indication that the proposed development will produce vibrations detectable off site without instruments; as described by the applicant, fabrication cutting tools will be installed on raised sleepers and sound dampeners to ensure vibration or sound of machinery is not detectable off-site.
- **Pursuant to Standard C** (emissions), there is no indication that odorous gas or other odorous matter will be produced by the proposed use; as described in the applicant's narrative, water used to assist with cutting will reduce particles going airborne.
- **Pursuant to Standard D** (open storage), there are no open storage areas proposed.
- **Pursuant to Standard E** (operations and residential areas), no residential districts exist within 100 feet of building openings and proposed loading zones and, as described by the applicant, operations will be limited to typical business hours of 9:00 am to 4:00 pm.
- **Pursuant to Standard F** (heat and glare, exterior lighting), per the applicant's narrative, the proposed building has been designed with exterior materials chosen and incorporated to eliminate heat or glare; operations are wholly enclosed and will not produce glare or heat impacting the surrounding area; exterior lighting is required to meet outdoor lighting standards as is not expected to produce light on adjacent properties.
- **Pursuant to Standard G** (dangerous substances), there are no prohibited dangerous substances expected on the development site.
- **Pursuant to Standard H** (liquid and solid wastes), there is no evidence that the standards for liquid and solid waste will be violated.
- **Pursuant to Standard I** (noise), there is no evidence that noise generated from the proposed operations will violate the City's Noise Ordinance. Noises produced in

violation of the Noise Ordinance would be subject to the enforcement procedures established in Wilsonville Code (WC) 6.204 for such violations.

- **Pursuant to Standard J** (electrical disturbances), no functions or construction methods are proposed that would interfere with electrical systems, and any construction activity that may require temporary electrical disruption for safety or connection reasons will be limited to the project site and coordinated with appropriate utilities.
- **Pursuant to Standard K** (discharge of air pollutants), there is no evidence that any prohibited discharge will be produced by the proposed project.
- **Pursuant to Standard L** (open burning), no open burning is proposed on the development site.
- **Pursuant to Standard M** (outdoor storage), no outdoor storage is proposed on the development site.
- **Pursuant to Standard N** (unused area landscaping), the west portion of the subject property will be completely developed with buildings, circulation areas, and landscaping; the east portion of the property, which is not proposed for development in the current application, will be maintained through the applicant's landscape maintenance program until future development occurs.

Other Standards for PDI-RSIA Zone

Lot Size

Subsections 4.135.5 (.07) A.

- B27.** The existing parcel is less than 50 acres. The applicant has not submitted a request for land division, therefore, this subsection is not applicable.

Setbacks and Corner Vision

Subsections 4.135.5 (.07) C. through F.

- B28.** The proposed building is setback at least 30 feet on all sides of the property. The Supporting Street required by the Coffee Creek Regulating Plan (Figure CC-1) will be constructed in a public access and utility easement along the north property boundary rather than in a public right-of-way. The northwest property corner is an identified intersection, and landscape plantings and maintenance practices at this location will ensure that adequate sight distances are maintained for safe operations. See Finding B40 for additional information on setbacks within the Coffee Creek Industrial Design Overlay District.

Coffee Creek Design Overlay District Standards

Regulating Plan

Subsection 4.134 (.06) A.

- B29.** As shown below, the proposed development, indicated with a red star, fronts on SW Garden Acres Road (primary frontage), which is classified as an Addressing Street on the Regulating Plan. A Required Supporting Street is proposed along the north boundary of the property to the east extent of the developed area as an access easement providing connection to SW Garden Acres Road for the subject property and the one to the north. The

remainder of this Supporting Street and a second Supporting Street on the property's east boundary will be constructed in the future when the eastern part of the property is developed.



Figure CC-1 - Regulating Plan

Connectivity Standards
 Subsection 4.134 (.06) B. 1.-2.

B30. The proposed development has primary frontage on SW Garden Acres Road, an Addressing Street. There are two required Supporting Streets on the north and east sides of the property, and no Through Connections shown on Figure CC-4 adjacent to the property.

Review Process
 Subsection 4.134 (.07)

B31. The applicant has addressed provisions of Sections 4.197, 4.700, and 4.140, as applicable, for the proposed development.

Waivers
 Subsection 4.134 (.08) A. 1.-3.

B32. The applicant requests one (1) waiver in accordance with this subsection. See Request D.

Coffee Creek Design Overlay District Regulating Plan

Addressing Streets

Subsection 4.134 (.09) A. 1.

B33. The project abuts SW Garden Acres Road on west, which is designated an Addressing Street on the Regulating Plan, and the building's designated primary frontage faces this street.

Overlay District

Subsection 4.134 (.09) A. 2.

B34. The subject property is located within the Coffee Creek Industrial Design Overlay District and is subject to the Connectivity Standards shown on Figures CC-4 and Table CC-1.

Connectivity Standards

Subsection 4.134 (.10) A.

B35. The subject property is not located within the area shown on Figure CC-1 bounded by Addressing Streets; however, it must meet the connectivity standards for Addressing and Supporting Streets in the Regulating Plan. It is bounded on the west by Addressing Street SW Garden Acres Road. Pursuant to this standard, Figure CC-1 and Figure CC-2, the applicant will construct a Supporting Street within a public access and utility easement along the north boundary of the site, to the east extent of the site development area. Initially the Supporting Street will include an interim driveway access on SW Garden Acres Road; this will transition to a driveway off the Supporting Street when the property to the north develops in the future, meeting the minimum driveway spacing and curb-to-curb distance requirements on the primary frontage and creating the planned intersection at SW Garden Acres Road and the Supporting Street. The Supporting Street will be extended in the future to intersect with a second Supporting Street on the site's east boundary when that half of the property is developed.

Street Types

Subsection 4.134 (.10) A. 1.-2.

B36. The subject property abuts Addressing Street SW Garden Acres Road and two (2) required Supporting Streets along the north and east property boundaries. Frontage improvements meeting Addressing Street requirements already have been constructed along the SW Garden Acres Road frontage. The Supporting Street requirements along the north boundary of the site to the east extent of the development area also will be met.

Planned Pathways

Subsection 4.134 (.10) B.

B37. The subject property is not located near a planned pathway as shown in the Transportation System Plan or Figure CC-1 – Regulating Plan.

Maximum Connection Spacing

Subsection 4.134 (.10) C.

B38. A Supporting Street on the north property boundary is proposed that meets the maximum connection spacing requirements as shown in Finding B40.

Connectivity Master Plan Requirement

Subsection 4.134 (.02) D.

B39. The applicant's site plans (Sheet A1.1 and A1.2 in Exhibit B2) provide the information necessary to determine compliance with applicable connectivity requirements. Frontage improvements have already been made along the east side of SW Garden Acres Road, along the property's west boundary, including interim driveway access to existing rural residential development that may not meet driveway spacing standards for this arterial street. This driveway will be closed and access taken from the proposed Supporting Street as development occurs in the future. As the fourth project within the Coffee Creek Industrial Design Overlay District, there are no existing walkways, waysides or other features located near the subject property.

Development Standards

Subsection 4.134 (.11)

B40. The proposed development is bounded by Addressing Street SW Garden Acres Road on the west, with a Supporting Street proposed along the north property boundary and required in the future along the east boundary, and is designated as a parcel subject to the Development Standards in Tables CC-1 through CC-4. Responses to the applicable criteria in Tables CC-1 through CC-4 are shown in the tables below.

Table CC-1 Street Design and Connectivity		
	Addressing Streets	Supporting Streets
General	Development Standards within this table are not adjustable.	
<u>Response:</u> The applicant does not propose any adjustments to the standards within Table CC-1 Street Design and Connectivity.		
Connection Spacing	Not applicable, Addressing Streets exist or are planned	600 feet, maximum, centerline to centerline. Supporting Streets and Through Connections shall intersect with Garden Acres Road as shown on Figure CC-1, Regulating Plan; or if the Addressing Street is Day Road, no less than 1,000 feet apart, centerline to centerline.
<u>Response:</u> The proposed development abuts Addressing Street SW Garden Acres Road and the connection spacing standards are not applicable to this street. The proposed development also abuts Required Supporting Streets along its north and east sides consistent with the connections and intersection spacing shown on Figure CC-1.		
Connection Type	Addressing Streets are Day Road, Grahams Ferry Road, Cahalin Road, Garden Acres Road, Garden Acres Road, and "Future" Street.	Supporting Streets are those meeting Specifications, Figure CC-2. A Required Supporting Street is one that intersects with an Addressing Street. The exact location and design of these connections will be determined at the time of development review.
<u>Response:</u> The proposed development abuts Addressing Street SW Garden Acres Road on its west side, and Required Supporting Streets on its north and east sides, consistent with Figure CC-1.		
Connection Hierarchy and Primary Frontage	If one of the streets or connections bounding a parcel is an Addressing Street, the Addressing Street shall be the Primary Frontage. If none of the bounding streets or connections is an Addressing Street, a Supporting Street shall be the Primary Frontage. See Figure CC-5.	
<u>Response:</u> The building is designed to face Addressing Street SW Garden Acres Road as the primary frontage. The Required Supporting Street on the property's north side provides a connection to this Addressing Street as well as driveway access to the interior of the site and, in the future, to a second Required Supporting Street on the property's east boundary.		

Table CC-2 District Wide Planning and Landscaping		
	Addressing Streets	Supporting Streets
General	The following provisions apply: <ul style="list-style-type: none"> • Section 4.176 for landscaping standards • Section 4.610.10 for tree removal, relocation or replacement. • Section 4.610.10 (.01) C. for consideration of development alternatives to preserve wooded areas & trees. 	
<p><u>Response:</u> The applicant has addressed the above provisions in responses to the applicable code criteria. The project’s planting plan meets or exceeds the General Landscaping standard along SW Garden Acres Road, and provides a range of Low Screen to High Screen landscaping along this Addressing Street and the Supporting Street on the north side of the property. See Request F for the Type C Tree Removal Plan.</p>		

Table CC-3 Site Design		
	Addressing Streets	Supporting Streets
1. Parcel Access		
General	Unless noted otherwise below, the following provisions apply: <ul style="list-style-type: none"> • Section 4.177 (.02) for street design; • Section 4.177 (.03) to (.10) for sidewalks, bike facilities, pathways, transit improvements, access drives & intersection spacing. The following Development Standards are adjustable: <ul style="list-style-type: none"> • Parcel Driveway Spacing: 20% • Parcel Driveway Width: 10% 	
<p><u>Response:</u> Two (2) driveways are proposed on the northern Supporting Street, near the northwest and northeast corners of the building. Each of the driveways is designed with a location, width, and configuration suitable to accommodate turning movements by all types of vehicles, including trucks via the east driveway at the back of the building. The applicant has requested a waiver to address proposed width of the east driveway. With the requested waiver, the project complies. See Request D.</p>		
Parcel Driveway Access	Not applicable	Limited by connection spacing standards Parcel Driveway Access may be employed to meet required connectivity, if it complies with Supporting Street Standards for Connection Spacing and Connection Type, see Figure CC-6. Subject to approval by City Engineer

Table CC-3 Site Design		
	Addressing Streets	Supporting Streets
<p><u>Response:</u> Two (2) driveways are proposed on the northern Supporting Street, therefore, this standard applies.</p>		
Parcel Driveway Spacing	Not applicable	150 feet, minimum See Figure CC-6
<p><u>Response:</u> The two (2) proposed driveways on the northern Supporting Street are spaced approximately 425 feet apart, which exceeds this standard.</p>		
Parcel Driveway Width	Not applicable	24 feet, maximum or complies with Supporting Street Standards
<p><u>Response:</u> As discussed above, two (2) driveways are proposed on the northern Supporting Street. The applicant has requested a waiver to increase the width of the east driveway to accommodate truck turning movements to access the loading area on the east side of the building. With the requested waiver, the project complies. See Request D.</p>		
2. Parcel Pedestrian Access		
General	<p>Unless noted otherwise below, the following provisions apply:</p> <ul style="list-style-type: none"> Section 4.154 (.01) for separated & direct pedestrian connections between parking, entrances, street right-of-way & open space Section 4.167 (.01) for points of access 	
<p><u>Response:</u> General parcel pedestrian access standards are addressed in this staff report in Findings B54-63.</p>		
Parcel Pedestrian Access Spacing	No restriction	
<p><u>Response:</u> There is approximately 100 feet between parcel pedestrian access points at the north and center of the site on the primary frontage on SW Garden Acres Road. As there is no spacing restriction, this standard is met.</p>		
Parcel Pedestrian Access Width	8 feet wide minimum	
<p><u>Response:</u> The applicant provides one 8-foot-wide pedestrian access from the sidewalk at SW Garden Acres Road into the site at the center front of the building (west of the main entry) and from the sidewalk of the Supporting Street north of the main building entry, consistent with this requirement.</p>		

Table CC-3 Site Design		
	Addressing Streets	Supporting Streets
Parcel Pedestrian Access to Transit	Provide separated & direct pedestrian connections between transit stops and parking, entrances, street right-of-way & open space.	
<p><u>Response:</u> Walkways between the public sidewalk and the main building entrance fronting on SW Garden Acres Road are located at the center and northwest corner of the building. Routing avoids conflict with driveways and provides drive aisle crossings at locations near the primary building entrance that have good visibility for safety. These connections provide direct and separated pedestrian access to SW Garden Acres Road, which connects to the closest existing transit service in SW Grahams Ferry Road, as well as to any other transit stops that may serve the area in the future.</p>		
3. Parcel Frontage		
Parcel Frontage, Defined	Parcel Frontage shall be defined by the linear distance between centerlines of the perpendicular Supporting Streets and Through-Parcel Connections. Where Parcel Frontage occurs on a curved segment of a street, Parcel Frontage shall be defined as the linear dimension of the Chord.	
<p><u>Response:</u> The distance along the primary frontage, SW Garden Acres Road, between the centerline of the Supporting Street on the property's north side and south property boundary is approximately 330 feet.</p>		
Primary Frontage, Defined	The Primary Frontage is the Parcel Frontage on an Addressing Street. If the parcel is not bounded by Addressing Streets, it is the Parcel Frontage on a Supporting Street. See Figure CC-5.	
<p><u>Response:</u> The site has Addressing Street SW Garden Acres Road on its west side, which is designated as the Primary Frontage.</p>		
Parcel Frontage Occupied by a Building	<p>A minimum of 100 feet of the Primary Frontage shall be occupied by a building.</p> <p>The maximum Primary Frontage occupied by a building shall be limited only by required side yard setbacks.</p>	No minimum
<p><u>Response:</u> The proposed building is sited with its short axis parallel to the Addressing Street, SW Garden Acres Road, and its long access parallel to the Supporting Street along its north boundary. Its front (primary) façade is roughly 240 feet long, with the west wall of the proposed building extending practically the full available length of the frontage, except to the extent needed to provide landscaping and emergency access, parking, and circulation around the building.</p>		
4. Parking Location and Design		

Table CC-3 Site Design		
	Addressing Streets	Supporting Streets
General	<p>Unless noted otherwise below, the following provisions apply:</p> <ul style="list-style-type: none"> • Section 4.155 (03) Minimum and Maximum Off-Street Parking Requirements • Section 4.155 (04) Bicycle Parking • Section 4.155 (06) Carpool and Vanpool Parking Requirements • Section 4.176 for Parking Perimeter Screening and Landscaping - permits the parking landscaping and screening standards as multiple options <p>The following Development Standards are adjustable:</p> <ul style="list-style-type: none"> • Parking Location and Extent: up to 20 spaces permitted on an Addressing Street 	
<p><u>Response:</u> The proposed 15 passenger vehicle parking stalls shown on the site plan along the Addressing Street SW Garden Acres Road frontage are within the allowance for up to 20 spaces to be located in this area.</p>		
Parking Location and Extent	Limited to one double-loaded bay of parking, 16 spaces, maximum, designated for short-term (1 hour or less), visitor, and disabled parking only between right-of-way of Addressing Street and building.	Parking is permitted between right-of-way of Supporting Street and building.
<p><u>Response:</u> The parking area near the northwest corner of the building, generally between the Primary Building Entrance and SW Garden Acres Road, an Addressing Street, provides 15 of the site's 71 proposed parking spaces in a double-loaded bay designated for short-term, visitor, and disabled parking.</p>		
Parking Setback	20 feet minimum from the right-of-way of an Addressing Street.	15 feet minimum from the right-of-way of a Supporting Street.
<p><u>Response:</u> The west parking area near the Primary Building Entrance (northwest), between the building and Addressing Street SW Garden Acres Road is set back 20 feet from the right-of-way line, and the east parking area on the south side of the Supporting Street is set back more than 15 feet from the right-of-way, consistent with the standard.</p>		
Parking Lot Sidewalks	Where off-street parking areas are designed for motor vehicles to overhang beyond curbs, sidewalks adjacent to the curbs shall be increased to a minimum of seven (7) feet in depth.	Where off-street parking areas are designed for motor vehicles to overhang beyond curbs, planted areas adjacent to the curbs shall be increased to a minimum of nine (9) feet in depth.

Table CC-3 Site Design		
	Addressing Streets	Supporting Streets
<p><u>Response:</u> The parking bays adjacent to the public entrance of the proposed building on Addressing Street SW Garden Acres Road and one bay of parking in the east parking area adjacent to the Supporting Street are locations where motor vehicles may overhang beyond the curb. The sidewalk shown adjacent to parking spaces at the front of the building is eight (8) feet deep, which exceeds the seven (7)-foot minimum depth. The landscape area adjacent to parking spaces along the Supporting Street in the east parking area is 17 feet deep, which exceeds the nine (9) foot minimum.</p>		
Parking Perimeter Screening and Landscaping	<p>Screen parking area from view from Addressing Streets and Supporting Streets by means of one or more of the following:</p> <ul style="list-style-type: none"> a. General Landscape Standard, Section 4.176 (.02) C. b. Low Berm Standard, Section 4.176 (.02) E., except within 50 feet of a perpendicular Supporting Street or Through Connection as measured from the centerline. 	
<p><u>Response:</u> The proposed project includes dense landscape plantings to screen parking areas from view from Addressing Street SW Garden Acres Road. One exception is that low screening is proposed where high screening would conflict with the Design Standard requiring a direct line of sight to the Primary Building Entrance at the northwest corner of the building. The Supporting Street will meet the requirements of Low and High Screen Landscape Standards in accordance with Section 4.176 (.02) D. The criteria have been addressed under Findings B105-110 and C32-44.</p>		
Off-Street Loading Berth	<p>One loading berth is permitted on the front façade of a building facing an Addressing Street. The maximum dimensions for a loading berth are 16 feet wide and 18 feet tall. A clear space 35 feet, minimum is required in front of the loading berth.</p> <p>The floor level of the loading berth shall match the main floor level of the primary building. No elevated loading docks or recessed truck wells are permitted.</p> <p>Access to a Loading Berth facing an Addressing Street may cross over, but shall not interrupt or alter, a required pedestrian path or sidewalk. All transitions necessary to accommodate changes in grade between access aisles and the loading berth shall be integrated into adjacent site or landscape areas.</p>	<p>No limitation. Shall meet minimum standards in Section 4.155(.05).</p>

Table CC-3 Site Design		
	Addressing Streets	Supporting Streets
	Architectural design of a loading berth on an Addressing Street shall be visually integrated with the scale, materials, colors, and other design elements of the building.	
<p><u>Response:</u> The front façade (west elevation) of the building faces SW Garden Acres Road and does not propose loading berths. All loading berths are located at the rear (east side) of the building, parallel to the Supporting Street.</p>		
Carpool and Vanpool Parking	No limitation	
<p><u>Response:</u> Of the four (4) proposed ADA accessible parking spaces, one (1) is designated to be van accessible; however, none of the other proposed passenger vehicle parking spaces is or required to be designated for vanpool/carpool parking.</p>		
5. Grading and Retaining Walls		
General	<p>The following Development Standards are adjustable:</p> <ul style="list-style-type: none"> Retaining Wall Design: 20% 	
<p><u>Response:</u> No retaining walls are needed as the site is fairly flat and does not require substantial grading.</p>		
Maximum height	<p>Where site topography requires adjustments to natural grades, landscape retaining walls shall be 48 inches tall maximum.</p> <p>Where the grade differential is greater than 30 inches, retaining walls may be stepped.</p>	
Required Materials	<p>Materials for retaining walls shall be unpainted cast-in-place, exposed-aggregate, or board-formed concrete; brick masonry; stone masonry; or industrial-grade, weathering steel plate.</p>	
Retaining Wall Design	<p>Retaining walls longer than 50 linear feet shall introduce a 5-foot, minimum horizontal offset to reduce their apparent mass.</p>	
<p><u>Response:</u> No retaining walls are proposed.</p>		
6. Planting		
General	<p>Unless noted otherwise below, the following provisions apply:</p> <ul style="list-style-type: none"> Section 4.176 Landscaping and Screening Standards 	

Table CC-3 Site Design		
	Addressing Streets	Supporting Streets
Landscaping Standards Permitted	General Landscape Standard, Section 4.176 (.02) C. Low Berm Standard, Section 4.176 (.02) E., except within 50 feet of a perpendicular Supporting Street or Through Connection as measured from the centerline	General Landscape Standard, Section 4.176(.02)C. Low Screen Landscape Standard, Section 4.176(.02)D. Screen loading areas with High Screen Landscaping Standard, Section 4.176(.02)F., and High Wall Standard, Section 4.176(.02)G.
<p><u>Response:</u> The applicant has prepared landscaping plans that comply with or exceed the General Landscape or Low Screen Landscape standard along SW Garden Acres Road and the Required Supporting Street. Loading berths will be screened with High Screen Landscaping or, where located indoors, to the High Wall standard.</p>		
<p>7. Location and Screening of Utilities and Services</p>		
General	<p>Unless noted otherwise below, the following provisions apply:</p> <ul style="list-style-type: none"> Sections 4.179 and 4.430. Mixed Solid Waste and Recyclables Storage in New Multi-Unit Residential and Non-Residential Buildings 	
<p><u>Response:</u> The applicant has addressed the standards for trash/recycling storage and provided correspondence from Republic Services supporting the proposed configuration. See Findings B111 – B112 and C20-C24.</p>		
Location and Visibility	Site and building service, equipment, and outdoor storage of garbage, recycling, or landscape maintenance tools and equipment is not permitted	Site and building service, utility equipment, and outdoor storage of garbage, recycling, or landscape maintenance tools and equipment is not permitted within the setback
<p><u>Response:</u> The proposed trash/recycling area is located at the back (east side) of the building and not visible from Addressing Street SW Garden Acres Road or within the setback from the Supporting Street on the property's north side.</p>		
Required Screening	Not permitted	High Screen Landscaping Standard, Section 4.176(.02)F. and/or High Wall Standard, Section 4.176 (.02) G.
<p><u>Response:</u> The trash/recycling area at the back (east side) of the building is screened to the High Screen Landscaping or High Wall standard consistent with this requirement.</p>		

Table CC-4 Building Design		
	Addressing Streets	Supporting Streets
1. Building Orientation		
Front Façade	<p>Buildings shall have one designated front façade and two designated side façades. If one of the streets or connections bounding a parcel is an Addressing Street, the front façade of the building shall face the Addressing Street.</p> <p>If two of the streets or connections bounding a parcel are Addressing Streets, the front façade of the building may face either Addressing Street, except when one of the Addressing Streets is Day Road. In that case, the front façade must face Day Road.</p> <p>If none of the bounding streets or connections is an Addressing Street, the front façade of the building shall face a Supporting Street.</p> <p>See Figure CC-5.</p>	
<p><u>Response:</u> The front façade of the proposed building faces Addressing Street SW Garden Acres Road and the north side of the proposed building faces a Required Supporting Street. The south and east sides of the building face rural residential or undeveloped land.</p>		
Length of Front Façade	<p>A minimum of 100 feet of the Primary Frontage shall be occupied by a building. The maximum Primary Frontage occupied by a building shall be limited only by required side yard setbacks.</p>	
<p><u>Response:</u> The building frontage faces Addressing Street SW Garden Acres Road and is roughly 240 feet long, which is well in excess of the minimum standard of 100 feet.</p>		
Articulation of Front Façade	<p>Applies to a Front Façade longer than 175 feet that has more than 5,250 square feet of street-facing façade area:</p> <p>At least 10% of the street-facing façade of a building facing an Addressing Street must be divided into façade planes that are offset by at least 2 feet from the rest of the façade. Façade area used to meet this standard may be recessed behind, or project out from, the primary façade plane.</p>	
<p><u>Response:</u> The front façade of the proposed building is approximately 240 feet long with roughly 7,400 sf of street-facing façade area. The office area, which is most forward portion of the building, occupies roughly 3,500 sf or 47% of the front façade area. The building entry and showroom, with about 1,500 sf or 20% of the front façade area, is recessed by about 4.5 feet behind the office area. The fabrication and warehouse area, which is roughly 2,300 sf or 31% of the front façade, is recessed behind the building entry and showroom by 60 feet and the office area by 65 feet. The front building plane, comprised of the entry/showroom and office occupy a total of roughly 5,000 sf or 67% of façade area, demonstrating compliance with this standard.</p>		

Table CC-4 Building Design		
	Addressing Streets	Supporting Streets
2. Primary Building Entrance		
General	<p>The following Development Standards are adjustable:</p> <ul style="list-style-type: none"> • Required Canopy: 10% • Transparency: 20% 	
<p><u>Response:</u> The proposed Primary Building Entrance is at the northwest corner of the proposed building facing Addressing Street SW Garden Acres Road. The entrance area is designed to meet the required horizontal dimensions for canopy coverage (i.e., width and depth) as well as the transparency requirement, without adjustment.</p>		
Accessible Entrance	<p>The Primary Building Entrance shall be visible from, and accessible to, an Addressing Street (or a Supporting Street if there is no Addressing Street frontage). A continuous pedestrian pathway shall connect from the sidewalk of an Addressing Street to the Primary Building Entrance with a safe, direct and convenient path of travel that is free from hazards and provides a reasonably smooth and consistent surface consistent with the requirements of Americans with Disabilities Act (ADA).</p> <p>The Primary Building Entrance shall be 15 feet wide, minimum and 15 feet tall, minimum.</p>	
<p><u>Response:</u> A continuous pedestrian pathway from the sidewalk in SW Garden Acres Road to the primary building entrance is safe, direct and convenient with good visibility for pedestrian safety. A second pathway from the Supporting Street also provides access to the primary building entrance. The primary building entrance is 20.5 ft wide and 16 ft tall, exceeding the standard.</p>		
Location	150 feet, maximum from right-of-way of an Addressing Street, see Figure CC-7.	150 feet, maximum from right-of-way of a Supporting Street, if there is no Addressing Street Frontage, see Figure CC-7.
<p><u>Response:</u> The Primary Building Entrance, at the northwest building corner, is within 150 feet from SW Garden Acres Road, an Addressing Street.</p>		
Visibility	Direct line of sight from an Addressing Street to the Primary Building Entrance.	
<p><u>Response:</u> The proposed public entrance is visible from points along the SW Garden Acres Road frontage.</p>		
Accessibility	Safe, direct, and convenient path from adjacent public sidewalk.	
<p><u>Response:</u> Proposed paths provide direct connections from the sidewalk to the primary building entrance.</p>		

Table CC-4 Building Design		
	Addressing Streets	Supporting Streets
Required Canopy	Protect the Primary Building Entrance with a canopy with a minimum vertical clearance of 15 feet and an all-weather protection zone that is 8 feet deep, minimum and 15 feet wide, minimum.	
<u>Response:</u> The canopy over the main entry doorways will cover the minimum 8-foot by 15-foot horizontal area at the Primary Building Entrance with a canopy height of 16 feet.		
Transparency	Walls and doors of the Primary Building Entrance shall be a minimum of 65% transparent.	
<u>Response:</u> The applicant's plans (Sheet A3.2) indicate glazing provided at the primary building entrance of 256 sf, which is 80% of the wall area of 320 sf, exceeding the requirement.		
Lighting	The interior and exterior of the Primary Building Entrance shall be illuminated to extend the visual connection between the sidewalk and the building interior from day to night. Pathway lighting connecting the Primary Building Entrance to the adjacent sidewalk on an Addressing Street shall be scaled to the needs of the pedestrian. Comply with Outdoor Lighting, Section 4.199	
<u>Response:</u> Per the applicant's narrative, the interior and exterior of the primary building entrance will be illuminated with a variety of lighting types to provide visual connection between the entry plaza and public sidewalk and entry lobby. The lighting design includes bollard lighting, pathway lighting, and wall mounted lighting. The lighting design will promote nighttime safety, security, enjoyment, and commerce while minimizing glare, light islands, and spotlighting. The plan will also preserve dark night sky to protect natural environments and habitat. The proposed lighting plan is designed to comply with the outdoor lighting requirements of Section 4.199; see Findings C45 – C53.		
3. Overall Building Massing		
General	The following Development Standards are adjustable: <ul style="list-style-type: none"> • Required Minimum Height: 10% • Ground Floor Height: 10% • Base, Body, and Top Dimensions: 10% • Base Design: 10% • Top Design: 10% 	
<u>Response:</u> As noted below, the proposed building elevations meet the requirements for Overall Building Massing without the need for adjustments.		
Front Setback	30 feet, minimum, except as provided below	30 feet maximum

Table CC-4 Building Design		
	Addressing Streets	Supporting Streets
<p><u>Response:</u> Proposed setbacks range from approximately 30 feet from the south property boundary, to 50 feet on the north, 85 feet on the west and in excess of 800 feet from the east property. All setbacks either meet or are well in excess of the 30 feet minimum requirement.</p>		
<p>Allowance of Primary Building Entrance</p>	<p>Where the Primary Building Entrance is located on an Addressing Street it may extend into the required front yard setback by 15 feet maximum provided that:</p> <ul style="list-style-type: none"> a. It has a two-story massing with a minimum height of 24 feet; b. The Parcel Frontage on the Addressing Street is limited to 100 feet; c. The building extension is 65% transparent, minimum; d. The entrance is protected with a weather-protecting canopy with a minimum vertical clearance of 15 feet; and <p>The standards for site design and accessibility are met.</p>	<p>Not applicable</p>
<p><u>Response:</u> This section is not applicable as the building does not extend into the front setback.</p>		
<p>Required Minimum Height</p>	<p>30 feet minimum.</p>	
<p><u>Response:</u> The proposed building height 30 feet to the office area parapet and 36 feet to the roof peak of the manufacturing/fabrication area, exceeding the 30-foot height minimum. Height to the parapet of the entry/showroom area is 27 feet, which is within the allowed adjustment of 10% of the required minimum height.</p>		
<p>Ground Floor Height</p>	<p>The Ground Floor height shall measure 15 feet, minimum from finished floor to finished ceiling (or 17.5 feet from finished floor to any exposed structural member).</p>	
<p><u>Response:</u> The proposed building meets or exceeds the ground floor height standard of 15 feet.</p>		
<p>Base, Body, and Top Dimensions</p>	<p>Buildings elevations shall be composed of a clearly demarcated base, body and top.</p> <ul style="list-style-type: none"> a. For Buildings 30 feet in height (unless lower by adjustment): <ul style="list-style-type: none"> i. The base shall be 30 inches, minimum. 	

Table CC-4 Building Design		
	Addressing Streets	Supporting Streets
	<ul style="list-style-type: none"> ii. The body shall be equal to or greater than 75% of the overall height of the building. iii. The top of the building shall be 18 inches, minimum. b. For Buildings between 30 feet and 5 stories in height: <ul style="list-style-type: none"> i. The base shall be 30 inches, minimum; 2 stories, maximum. ii. The body shall be equal to or greater than 75% of the overall height of the building. iii. The top of the building shall be 18 inches, minimum. c. For Buildings greater than 6 stories in height: <ul style="list-style-type: none"> i. The base shall be 1 story, minimum, 3 stories, maximum. ii. The body shall be equal to or greater than 75% of the overall height of the building. iii. The top of the building shall be 18 inches, minimum. 	
<p><u>Response:</u> The proposed building height varies from 27 feet at the entry/showroom (with allowed adjustment) to 30 feet at the offices area and 36 feet to the roof peak (or roughly 31 feet to the mid-point of the gable) of the fabrication/warehouse area. Therefore, subparagraph b. is applicable to the development. With respect to subparagraph b.i., a 30-inch base of insulated metal panel with granistone surfacing is provided at the base of the front façade on Addressing Street SW Garden Acres Road and the side façade facing the Supporting Street. With respect to subparagraph b.ii., the body height, which ranges from 22.5 feet on the front façade to 24 feet on the north side, calculates to approximately 75% to 83% of the overall building height, meeting or exceeding the required 75%. In compliance with subparagraph b.iii., the entry/showroom has a top of metal cap flashing 24 inches wide, there is a similar 5-foot-wide cap flashing top to the office area, and the sloped roof along the north side of the building provides a top element 9.5 feet wide, exceeding the minimum 18-inch requirement.</p>		
Base Design	<p>The design of the building Base shall:</p> <ul style="list-style-type: none"> a. Use a material with a distinctive appearance, easily distinguished from the building Body expressed by a change in material, a change in texture, a change in color or finish; b. Create a change in surface position where the Base projects beyond the Body of the building by 1 -1/2 inches, minimum; and/ or c. Low Berm Landscape Standard, Section 4.176 (.02) E. 	
<p><u>Response:</u> The base of insulated metal panel with granistone surfacing in a medium gray provides a distinctive color, material, and texture change consistent with subparagraph a., and the base projects 1.5 inches from the wall surface creating a change in surface position, consistent with subparagraph b.</p>		

Table CC-4 Building Design		
	Addressing Streets	Supporting Streets
Top Design	Building Tops define the skyline. The design of the Building Top shall: <ol style="list-style-type: none"> a. Use a material with a distinctive appearance, easily distinguished from the building Body expressed by a change in material, a change in texture, a change in color or finish; and/ or b. Create a change in surface position where the Top projects beyond, or recesses behind, the Body of the building by 1 -1/2 inches, minimum. 	
<p><u>Response:</u> The metal cap flashing at the top of the entry/showroom and offices areas on the front façade provides a change in material and color from the walls, consistent with subparagraph a., and the flashing projects 2 inches from the wall surface, consistent with subparagraph b. On the north facing side of the building, the metal cap flashing wraps the corner of the entry/showroom area, while the eave of the sloped roof of the fabrication/warehouse area projects from the building wall and the roof surface slopes away from the wall surface toward the roof peak, providing a distinctive appearance through change in materials and color, as well as surface position, consistent with subparagraphs a. and b.</p>		
Required Screening of Roof-mounted Equipment	Screen roof-mounted equipment with architectural enclosures using the materials and design of the building Body and/ or the building Top. No roof-mounted equipment shall be visible from an Addressing Street or Supporting Street.	
<p><u>Response:</u> As noted in the applicant’s narrative, the building elevations illustrate that the design incorporates a series of pitched roof assemblies and parapets, thus the roof-mounted equipment is wholly within the structure of the building and not visible from the adjacent Addressing or Supporting Streets. A condition of approval ensures any rooftop mechanical equipment will be screened in compliance with this standard.</p>		

Waysides

Waysides Purpose
 Subsection 4.134 (.12) A.

B41. The proposed wayside complies with the purpose of Industrial Waysides by providing a passive recreation destination that is visually accessible from SW Garden Acres Road, an Addressing Street. The design is inviting and provides attractive landscaping features and seating areas with well-placed lighting features. The materials proposed for the wayside are durable and allow for easy maintenance.

Waysides Applicability
 Subsection 4.134 (.12) B.

B42. The site is located within the Coffee Creek Master Plan area, therefore this section applies to the proposed development.

Table CC-5: Waysides			
Parcel Area	Required Wayside Area	Number of Waysides	Enhanced Transit Plaza ‡
Greater than 8.0 acres, less than or equal to 13.0 acres	600 square feet, minimum	One	Not permitted
Response: The net site area (less right-of-way) is 9.33 acres, therefore the provisions that apply to the site require a 600 square foot minimum wayside area. The proposed wayside is rectangular in design, measuring roughly 20 feet by 30 feet, providing 600 sf of passive recreation space. It is located at the front of the building on the south side of the pedestrian path between the primary building entrance and the east sidewalk of SW Garden Acres Road.			
‡ In the future when SMART serves Coffee Creek, Industrial Waysides may comply with the standards for Enhanced Transit Plazas. See Table CC-5 in Subsection 4.134 (.12) B. for sites greater than 13.0 acres in size.			

Development Standards Applying to Waysides
 Subsection 4.134 (.12) C. 1.-2.

B43. The proposed wayside is exclusive of the required landscape screening and has at least one minimum dimension of 20 feet.

Waysides – Criteria

Perimeter Landscaping
 Subsection 4.134 (.12) D. 1.

B44. The wayside is landscaped on the west, south, and east sides, with the north side opening onto the pedestrian pathway from the sidewalk in SW Garden Acres Road to the primary building entrance. Dense landscaping is provided on the north side of the pedestrian pathway to visually screen the parking area at the northwest corner of the site for users of the wayside. The plantings are designed to visually define and enclose the wayside, while not obscuring views of the wayside, thus allowing visual access into the wayside for safety.

Visibility
 Subsection 4.134 (.12) D. 2.

B45. The proposed wayside abuts Addressing Street SW Garden Acres Road and is visible and accessible from the frontage, consistent with this standard.

Accessible Pathway

Subsection 4.134 (.12) D. 3.

- B46.** The pedestrian pathway on the north side that connects the wayside to the public sidewalk along SW Garden Acres Road is a concrete-paved walking surface 8 feet wide, exceeding the minimum width requirement of 5 feet for wayside access.

Accessible Surface

Subsection 4.134 (.12) D. 4.

- B47.** The wayside provides an accessible surface between benches that is roughly 24.5 feet by 16.5 feet, or 400 sf, exceeding the minimum 100 sf area and 10 feet length dimensions.

Required Amenities

Subsection 4.134 (.12) D. 5.

- B48.** The wayside is required to include one (1) linear foot of seating for each 40 sf of plaza; therefore, the 600-sf wayside in the current application requires 15 linear feet of seating. As shown in the plans, the wayside includes four (4) freestanding benches, each six (6) feet long, providing 24 linear feet of seating area, exceeding the requirement. The wayside is landscaped on three sides as required, and illumination is provided by bollards on the east and west sides. A waste/recycling receptacle is located near the northeast corner of the plaza.

Installation and Maintenance

Subsection 4.134 (.12) D. 6.

- B49.** As required, per the applicant's narrative, the wayside will be installed and maintained at the owner's expense, and the landscaped areas of the property will be placed under a maintenance and repair schedule to keep the property organized and free from waste and unsanitary conditions.

Solar Access

Subsection 4.134 (.12) D. 7.

- B50.** The applicant provided a sunlight study (Sheet LT3.0 in Exhibit B2) showing that the wayside will receive partial to full sun exposure from 10:00 am – 5:00 pm throughout the year, consistent with this standard.

Lighting

Subsection 4.134 (.12) D. 8.

- B51.** Four (4) bollard lights are included in the wayside in close proximity to the benches on the east and west sides of the plaza to permit reasonable use, utility, security, and nighttime safety. As shown in the lighting cut sheets (Sheet LT2.0 in Exhibit B2), the 42-inch-tall bollards are L-shaped with downward facing lights on the underside of the light arm, and arranged and shielded so as not to shine into adjacent areas or cause any undue glare or reflection on adjoining streets or property.

Optional Amenities

Subsection 4.134 (.12) E.

B52. No optional amenities, such as picnic tables, arbors, drinking fountains, works of art, bicycle repair stations, exercise stations, or pet waste stations are proposed as part of the wayside.

Signs

Signs – General Requirements

Subsection 4.134 (.13) B.

B53. The proposed development contains one (1) wall-mounted sign on the front façade facing SW Garden Acres Road. No monument signs are proposed. Signage is addressed in the staff report in Request E.

On-site Pedestrian Access and Circulation

Conformance with Standards

Section 4.154 (.01) B. 1.

B54. All of the on-site pedestrian access and circulation standards are being applied to the proposed development.

Continuous Pathway System

Section 4.154 (.01) B. 1.

B55. A continuous pathway system will connect from the proposed public sidewalk improvements on SW Garden Acres Road with two (2) pedestrian paths to the primary building entrance: one from the SW Garden Acres Road sidewalk and a second from the Supporting Street sidewalk. Internal walkways connect to adjacent sidewalks and extend throughout the development site on all sides of the proposed building.

Safe, Direct, and Convenient

Section 4.154 (.01) B. 2.

B56. The plans show the two (2) pedestrian connections from SW Garden Acres Road and the Supporting Street to the primary building entrance. The pathways are reasonably direct and convenient. Lighting is shown along the pathways ensuring safety for all users.

Free from Hazards/Smooth Surface

Section 4.154 (.01) B. 2. a.

B57. The proposed pathways are planned to be free from hazards and will be a smooth hard surface.

Reasonably Direct

Section 4.154 (.01) B. 2. b.

- B58.** Proposed pathways provide a direct connection to the primary building entrance and do not involve a significant amount of unnecessary out-of-direction travel.

Building Entrance Connectivity/Meets ADA

Section 4.154 (.01) B. 2. c.

- B59.** Direct pathways connect the visitor parking area at northwest corner of the site and the sidewalks in SW Garden Acres Road and the Supporting Street to the primary building entrance and are consistent with ADA requirements.

Vehicle/Pathway Separation

Section 4.154 (.01) B. 3.

- B60.** All pedestrian facilities, besides crosswalks, are raised to provide vertical separation or horizontally separated by landscaping.

Crosswalks

Section 4.154 (.01) B. 4.

- B61.** Where pathways cross parking areas or drives contrasting material and striping is proposed to clearly mark the crosswalks.

Pathway Width and Surface

Section 4.154 (.01) B. 5.

- B62.** All internal proposed pathways are constructed of concrete and have a minimum width of six (6) feet. As required by the Coffee Creek standards, a parcel pedestrian access width of eight (8) feet is provided on the primary building frontage from the sidewalk in SW Garden Acres Road and the sidewalk in the Supporting Street to the primary building entrance.

Pathway Signs

Section 4.154 (.01) B. 6.

- B63.** No pathways needing directional signage are proposed.

Parking Area Design Standards

Minimum and Maximum Parking

Subsection 4.155 (.03) G.

- B64.** The proposed project requires a minimum of 62 parking spaces and, because the project contains one use without a parking maximum, there are no limits on maximum parking spaces. The applicant proposes 71 parking spaces, exceeding the minimum. The calculation of parking spaces is as follows:

Use and Parking Standard	Square Feet	Minimum Off-street Spaces Required	Maximum Off-street Spaces Allowed	Proposed Off-street Spaces	Minimum Bicycle Parking Spaces	Proposed Bicycle Parking Spaces
Manufacturing (Fabrication)	15,600 sf	1.6 per 1,000 = 25	No limit	--	1.0 per 10,000 sf (min 6) = 6	--
Warehouse	39,800 sf	0.3 per 1,000 = 12	0.5 per 1,000 = 20	--	1.0 per 20,000 sf (min 2) = 6	--
Retail/Showroom	3,000 sf	1.67 per 1,000 = 5	6.2 per 1,000 = 19		1.0 per 8,000 sf (min 2) = 2	
Office	7,400 sf	2.7 per 1,000 = 20	4.1 per 1,000 = 30		1.0 per 5,000 sf (min 2) = 2	
Total	65,800 sf	62	No limit	71	16	12

Other Parking Area Design Standards
Subsections 4.155 (.02) and (.03)

B65. The applicable standards are met as follows:

Standard	Met	Explanation
Subsection 4.155 (.02) General Standards		
B. All spaces accessible and usable for parking	<input checked="" type="checkbox"/>	Standard parking lot design
I. Parking lot screen of at least 6 feet adjacent to residential district.	<input checked="" type="checkbox"/>	Parking is not adjacent to a residential district
J. Sturdy bumper guards or curbs of at least 6 inches to prevent parked vehicles crossing property line or interfering with screening or sidewalks.	<input checked="" type="checkbox"/>	Parking area is surrounded by a six (6)-inch curb
K. Surfaced with asphalt, concrete or other approved material.	<input checked="" type="checkbox"/>	Surfaced with asphalt
Drainage meeting City standards	<input checked="" type="checkbox"/>	Drainage is professionally designed and being reviewed to meet City standards
L. Lighting will not shine into adjoining structures or into the eyes of passers-by.	<input checked="" type="checkbox"/>	Lighting is proposed to be fully shielded and subject to the City's Outdoor Lighting Ordinance
N. No more than 40% of parking compact spaces.	<input checked="" type="checkbox"/>	Eight (8) of 71 proposed parking spaces are compact, or 11%, are compact, which is less than the allowed maximum

O. Where vehicles overhand curb, planting areas at least 7 feet in depth.	<input checked="" type="checkbox"/>	All parking area planting areas are at least 7 feet in depth
Subsection 4.155 (.03) General Standards		
A. Access and maneuvering areas adequate.	<input checked="" type="checkbox"/>	Access to the parking areas is adequate and maneuvering area is plentiful
A.1. Loading and delivery areas and circulation separate from customer/employee parking and pedestrian areas.	<input checked="" type="checkbox"/>	Applicant proposes employee parking at east side of building. ADA and short-term parking is proposed along front (west side) of building away from loading and delivery areas.
Circulation patterns clearly marked.	<input checked="" type="checkbox"/>	No markings needed to clarify circulation
A.2. To the greatest extent possible, vehicle and pedestrian traffic separated.	<input checked="" type="checkbox"/>	Vehicle and pedestrian traffic are clearly delineated and separated except for crosswalks
C. Safe and Convenient Access, meet ADA and ODOT Standards.	<input checked="" type="checkbox"/>	The proposed parking and access allow ADA and ODOT standards to be met
For parking areas with more than 10 spaces, 1 ADA space for every 50 spaces.	<input checked="" type="checkbox"/>	The applicant proposes four (4) ADA parking spaces and 67 standard spaces, eight (8) of which are compact spaces
D. Where possible, parking areas connect to adjacent sites.	<input checked="" type="checkbox"/>	New parking area is part of a single development
Efficient on-site parking and circulation	<input checked="" type="checkbox"/>	Proximity to destination and pedestrian connections, and adequate maneuvering area make circulation efficient

Other Parking Standards and Policies and Procedures

Parking Variances and Waivers

Subsection 4.155 (.02) A. 1.-2.

B66. The applicant has not requested variances or waivers pursuant to this subsection.

Multiple Use Parking Calculations

Subsection 4.155 (.02) D.

B67. The review considers all proposed uses including retail/showroom, office, manufacturing (fabrication), and warehousing for the purpose of parking calculations.

Shared Parking

Subsection 4.155 (.02) E.

B68. The review only considers the proposed new use and no shared parking as described by this subsection is proposed.

Off-Site Parking Allowance

Subsection 4.155 (.02) G.

B69. No off-site parking was used for calculating the parking spaces provided.

Non-Parking Use of Parking Areas

Subsection 4.155 (.02) H.

B70. All parking areas are expected to be maintained and kept clear for parking unless a temporary use permit is granted or the Stage 2 Final Plan approval is revised. Particularly no container or other storage is permitted in the parking areas.

Parking for Uses Not Listed

Subsection 4.155 (.02) M.

B71. The parking calculation is based on the listed uses of retail/showroom, office, manufacturing (fabrication), and warehousing.

On-Street Parking for Parking Calculations

Subsection 4.155 (.03) F.

B72. The parking calculations do not include any on-street parking.

Electrical Vehicle Charging Stations

Subsection 4.155 (.03) H.

B73. The applicant does not propose electrical charging stations; however, as required by Oregon Administrative Rules (OAR) 918-460-0200, the applicant has included electric vehicle charging infrastructure adjacent to parking spaces in parking areas on the west and east sides of the building.

Substituting Motorcycle Parking for Vehicle Parking

Subsection 4.155 (.03) I.

B74. The applicant does not propose motorcycle parking.

Parking Area Landscaping

Minimizing Visual Dominance of Parking

Subsection 4.155 (.03) B.

B75. As described by the applicant and illustrated on Sheet L1.0 (Exhibit B2), the site's landscaping seeks to minimize the visual dominance of the parking and loading areas. Overall site landscaping of 55,509 square feet, or 26.9%, of the 206,217-square-foot site development area is provided, which exceeds the 15% landscaping standard. As indicated in the applicant's materials, the west parking area is roughly 5,936 square feet in area of which 1,569 square feet (26.4%) is landscaped. Approximately 3,054 square feet (18.8%) of the east parking area of 16,197 square feet is landscaped. Parking area landscaping has been counted as contributing to overall site landscaping, consistent with this provision. The visual appearance of the parking and circulation areas is sufficiently minimized by the proposed landscaping.

10% Parking Area Landscape Requirement

Subsection 4.155 (.03) B. 1.

B76. As stated above, the landscaping provided within the parking areas is 4,623 square feet, which is 20.9% of the 22,133 square feet of the site dedicated to parking area.

Landscape Screening of Parking

Subsection 4.155 (.03) B. 1.

B77. Proposed landscaping will substantially shield the parking area from view from the public right-of-way.

Tree Planting Area Dimensions

Subsection 4.155 (.03) B. 2.

B78. All tree planting areas meet or exceed the 8-foot minimum width and length.

Parking Area Tree Requirement

Subsection 4.155 (.03) B. 2. and 2. a.

B79. For a parking lot with a total of 71 parking spaces, one (1) tree per eight (8) parking spaces is required for a total of 8.9 rounded to 9 total trees. Fifteen (15) trees are shown within the landscaped islands within the parking areas, which exceeds the requirement.

Parking Area Tree Clearance

Subsection 4.155 (.03) B. 2. b.

B80. All trees planting in the parking area are varieties that could typically be maintained to provide a 7-foot clearance.

Bicycle Parking-General Provisions

Determining Minimum Bicycle Parking

Subsection 4.155 (.04) A. 1.

B81. As shown in the parking calculations table in Finding B64, above, the proposed building will include retail/showroom, office, manufacturing (fabrication), and warehousing uses. Table 5 indicates that retail/showroom uses require one (1) bicycle space per 8,000 square feet with a minimum of two (2) spaces, office uses required one (1) bicycle space per 5,000 square feet with a minimum of two (2) spaces, manufacturing (fabrication) uses require one (1) bicycle space per 10,000 square feet with a minimum of six (6) spaces, and warehousing uses require one (1) bicycle space per 20,000 square feet with a minimum of six (6) spaces. Based on the proportion of these uses within the proposed building, 16 bicycle parking spaces are required, of which 50% or eight (8) spaces must be long-term, secure spaces. The applicant proposes six (6) short-term bicycle parking spaces south of the primary building entrance and seven (7) long-term spaces inside the north wall adjacent to one of the access doors to the warehouse portion of the building (see Sheet A1.1 in Exhibit B2) for a total of 13 spaces, which is three (3) fewer than the required 16. A condition of approval will ensure the requirement is met.

Bicycle Parking for Multiple Uses

Subsection 4.155 (.04) A. 3.

B82. As noted in Finding B81, the required bicycle parking is the sum of the requirements for all uses on site. Based on this, a total of 16 spaces is required and 13 spaces are provided. A condition of approval will ensure the requirement is met.

Bicycle Parking Waivers

Subsection 4.155 (.04) A. 4.

B83. The applicant proposes no waivers to bicycle parking.

Bicycle Parking Standards

Bicycle Parking Space Dimensions

Subsection 4.155 (.04) B. 1.

B84. The bicycle parking details (see Sheet A1.3 in Exhibit B2) demonstrate that short-term spaces comply with the two (2) foot by six (6) foot spacing dimension for short-term parking. However, a detail is not provided for the long-term parking racks inside the building. Therefore, a condition of approval ensures the long-term bicycle parking spaces provide the appropriate spacing.

Access to Bicycle Parking Spaces

Subsection 4.155 (.04) B. 1.

B85. All short-term bicycle parking spaces provide adequate space to be accessible without moving another bicycle. A detail is not provided for long-term spaces; therefore, a condition of approval ensures these spaces provide adequate accessible space.

Bicycle Maneuvering Area

Subsection 4.155 (.04) B. 2.

B86. An aisle at least five (5) feet wide is shown behind the required short-term bicycle parking to allow room for bicycle maneuvering. Long-term bicycle parking spaces are located on the north wall of the open warehouse area and, therefore, provide adequate space for maneuvering.

Spacing of Bicycle Racks

Subsection 4.155 (.04) B. 3.

B87. Both short-term and long-term bicycle parking, as shown on the site plan (Sheet A1.1 in Exhibit B2), provide enough space between the racks and any obstructions to use the space property.

Bicycle Racks and Lockers Anchoring

Subsection 4.155 (.04) B. 4.

B88. The bicycle parking details (see Sheet A1.3 in Exhibit B2) demonstrate that short-term spaces will be securely anchored. However, a detail is not provided for the long-term parking racks inside the building. Therefore, a condition of approval ensures the long-term bicycle parking racks are securely anchored.

Bicycle Parking Location

Subsection 4.155 (.04) B. 5.

B89. As shown on the site plan (Sheet A1.1 in Exhibit B2), the short-term bicycle parking is located within 30 feet of the main building entrance, and long-term parking is provided inside the building in a location that is easily accessible for bicyclists.

Long-term Bicycle Parking

Required Long-term Bicycle Parking

Subsection 4.155 (.04) C. 1. and 2.

B90. As the proposed building includes retail/showroom and office uses and requires six (6) or more bicycle parking spaces, 50% of the required spaces must be provided in a weather-protected, secure place for employees. As discussed in Finding B81, the applicant proposes seven (7) long-term bicycle parking spaces inside the north wall of the warehousing portion of the building. As 16 bicycle parking spaces are required, at least eight (8) must be provided as long-term spaces; therefore, at least one (1) additional long-term space must be provided. A condition of approval ensures this requirement is met.

Minimum Off-Street Loading Requirements

Determining Required Loading Berths

Subsection 4.155 (.05) A. 1.-2.

B91. The proposed development is an industrial development with 65,800 square feet of floor area, therefore, a minimum of two (2) loading berths is required. The applicant proposes at least two (2) loading berths at the back (east side) of the building, exceeding the standard.

Loading Berth Dimensions

Subsection 4.155 (.05) A. 3.

B92. As shown in the applicant's plan set, no loading berths are proposed on the front façade of the building facing SW Garden Acres Road. All proposed loading berths, as well as roll-up delivery doors, are located at the back (east side) of the building. As shown in the table below from the applicant's narrative and demonstrated in Sheets A2.1 and A3.1 (Exhibit B2), at least two (2) of the loading berths meet the minimum dimensional standards of 12 feet wide by 35 feet long with a height clearance of 14 feet.

Proposed Loading Berths		
Loading area	Size (Length, width, height)	Meets Standards
2	16x40x16'	Yes
3	12x53x14'	Yes
1	9x40x10'	No

Existing Loading Berths

Subsection 4.155 (.05) A. 4.

B93. There are no existing uses or loading berths on the subject property.

Use of Off-Street Parking Areas for Loading

Subsection 4.155 (.05) A. 5.

B94. Off-street parking areas are not proposed to be used for loading and unloading operations.

Exception for On-Street Loading

Subsection 4.155 (.05) B.

B95. No loading area adjacent to or within a street right-of-way is proposed.

Access, Ingress, and Egress

Access at Defined Points

Subsection 4.167 (.01)

B96. As illustrated on the applicant’s plans, the site will initially take access from the existing driveway on SW Garden Acres Road at the northwest corner of the site, which connects to two (2) driveways from the Supporting Street at the northwest and northeast parts of the site. When the property to the north develops and the Supporting Street is fully constructed, the driveway on SW Garden Acres Road will be closed and access limited to the two (2) driveways from the Supporting Street (see Sheets A1.1 and A1.2 in Exhibit B2). All driveways are at defined access points approved by the City.

Health, Safety, and Welfare

Subsection 4.167 (.01)

B97. By virtue of meeting applicable standards of Chapter 4, as well as being required to meet Public Works Standards, the access points will be consistent with the public’s health, safety and general welfare.

Approval of Access Points

Subsection 4.167 (.01)

B98. The Engineering Division is reviewing and approving all points of access to public streets.

Other Development Standards

Double-Frontage Lots

Section 4.169

B99. The site is not a double-frontage lot, no homeowners association is appropriate for this industrial property, and the applicant intends to comply with all applicable landscaping and maintenance regulations.

Natural Features and Other Resources

Section 4.171

B100. The subject property is not located in a regulated flood hazard area. It is generally flat, sloping gently from the west and east toward the center of the site by approximately six (6) feet in elevation. Removal of on-site trees will not result in unstable slopes or other erosive impacts. Tree removal is being limited to the extent possible and trees in the southeastern part of the site, which will not be developed with the current application, are being retained. No hillsides, power line easements, or other resources needing protection exist on the site.

Public Safety and Crime Prevention

Design for Public Safety

Subsection 4.175 (.01)

B101. The proposed site plan is designed to provide visibility of active use parts of the building from points in SW Garden Acres Road and the Supporting Street right-of-ways. This facilitates surveillance by law enforcement, and also enables citizens passing by on the public streets to observe activity within the site. Security fencing around the loading dock area on the east side of the building and lighting throughout the site, including in parking/circulation areas and along pedestrian pathways, contribute to safety during hours of darkness.

Addressing and Directional Signing

Subsection 4.175 (.02)

B102. Addressing will be as required by Tualatin Valley Fire and Rescue.

Surveillance and Access

Subsection 4.175 (.03)

B103. As discussed in Finding B101, the proposed site plan is designed to facilitate surveillance and access. Further, by locating the loading and docking area where it can be surveilled from the Supporting Street, and proposing a wrought iron fence that is visually permeable, the design facilitates routine surveillance by police without requiring them to enter and circulate within the secure area of the site. Parking areas, located on the west and east sides of the building, can be observed from points along SW Garden Acres Road and the Supporting Street, and all parts of the site are easily accessible from both right-of-ways.

Lighting to Discourage Crime
Subsection 4.175 (.04)

B104. Lighting has been designed in accordance with the City’s outdoor lighting standards, which will provide sufficient lighting to discourage crime.

Landscaping Standards

Landscaping Standards Purpose
Subsection 4.176 (.01)

B105. In complying with the various landscape standards in Section 4.176, the applicant has demonstrated the Stage 2 Final Plan is in compliance with the landscape purpose statement.

Landscape Code Compliance
Subsection 4.176 (.02) B.

B106. No waivers or variances to landscape standards have been requested. Thus all landscaping and screening must comply with standards of this section.

Intent and Required Materials
Subsections 4.176 (.02) C. through I.

B107. As shown on Sheet L1.0 (Exhibit B2), landscape areas are located on all sides of the proposed building. The project’s landscape plan meets or exceeds the General Landscaping standard along SW Garden Acres Road, and provides a range of Low Screen to High Screen landscaping along this Addressing Street and the Supporting Street on the north side of the property to screen parking and loading areas. Required materials will be provided as follows.

- **Area Description:** Along all sides of the subject property
- **Landscaping Standard:** General, Low Screen, High Screen (west, central east)
- **Comments on Intent:** Screens development from adjoining sites and Addressing Street right-of-way
- **Required Materials:** General Standard: shrubs, trees every 30 feet or one tree per 800 square feet of area. Low Screen: three-foot hedge 95% opaque year round, trees every 30 feet or as required to provide canopy over landscape area. High Screen: six-foot hedge 95% opaque year round, trees every 30 feet or as required to provide canopy over landscape area.
- **Materials Provided:** Tree and understory plantings. Predominant new tree species include maple (along SW Garden Acres Road), Alaskan cedar, dogwood (as street trees on the Supporting Street), tupelo (in west parking area, along loading area and parking on Supporting Street), cherry, and Zelkova (in east parking area). No trees are proposed along the south property boundary along the south side of the building as numerous mature off-site trees, including Ponderosa pine, Douglas-fir, grand fir, madrone, and giant sequoia, which will be retained, reduce the likelihood that newly planted trees will grow or thrive in the understory of these

trees. Shrubs include a variety of species such as abelio, rockrose, myrtle, nandina, pieris, spirea, yew, and viburnum. Groundcover includes reed and maiden grass kinnick, lily turf, honeysuckle, Oregon grape, and amber rose. A condition of approval ensures specific code requirements are met.

Landscape Area and Locations

Subsection 4.176 (.03)

B108. Landscaping is proposed in more than three (3) distinct areas within the site, including the wayside area, surrounding the parking lot and circulation areas, along the SW Garden Acres and Supporting Street right-of-ways, and perimeter landscaping on the south side of the building. Overall site landscaping of 55,509 square feet, or 26.9%, of the 206,217-square-foot site development area is provided, which exceeds the 15% landscaping standard.

Buffering and Screening

Subsection 4.176 (.04)

B109. The subject property's location in the Coffee Creek Industrial Area, with industrially-zoned neighboring properties, does not require buffering and screening to protect adjacent sensitive uses. The building's parapet-roof design provides screening of rooftop mechanical equipment from view from adjacent streets or properties and the site plan does not include any outdoor storage areas. To secure the loading area on the east side of the building, an 8-foot-high wrought iron fence and access-control gates is proposed (see details on Sheet A1.3 in Exhibit B2). As described in Findings B40 and B105, the applicant has prepared landscaping plans that comply with or exceed the General Landscape standard along SW Garden Acres Road and the Supporting Street.

Landscape Plans

Subsection 4.176 (.09)

B110. Sufficient information has been provided regarding landscaping and a condition of approval ensures final construction landscape plans meet the City's objective landscape standards.

Mixed Solid Waste and Recyclables Storage

DRB Review of Adequate Storage Area, Minimum Storage Area

Subsections 4.179 (.01)

B111. As described by the applicant, the proposed development has 65,800 square feet of gross floor area (GFA), of which warehouse/manufacturing is the primary use. Other uses include office and retail/showroom, but these uses do not make up 20% of the overall building square footage. Therefore, the project requires at least 405 square feet of solid waste/recyclables storage area (10 square feet plus $65,800/1,000 \times 6$ square feet = 404.8 square feet). The proposed storage area is at the back of the building as shown on the site plan (Sheets A1.0-A1.1 and G3.0 in Exhibit B2), contained within a covered area located on the east side of the building.

Review by Franchise Garbage Hauler
Subsection 4.179 (.07).

B112. The applicant's Exhibit B1 includes a letter from Republic Services indicating coordination with the franchised hauler, and that the proposed storage area and site plan meets Republic Services requirements.

Other Development Standards

Access Drives and Travel Lanes
Subsection 4.177 (.01) E.

B113. These criteria are satisfied or will be satisfied by conditions of approval:

- All access drives are designed to provide a clear travel lane, free from obstructions.
- All travel lanes will be asphalt. A condition of approval will ensure they are capable of carrying a 23-ton load.
- Emergency access lanes are improved to a minimum of 12 feet and the development design has been reviewed and approved by Tualatin Valley Fire and Rescue (Sheet FS1.0 in Exhibit B2).

Outdoor Lighting
Sections 4.199.20 through 4.199.60

B114. The proposal is required to meet the Outdoor Lighting Standards. See Findings C45 through C53.

Underground Installation
Sections 4.300-4.320

B115. Utilities will be installed underground.

Request C: Site Design Review (SDR22-0007)

As described in the Findings below, the request meets the applicable criteria or will by conditions of approval.

Site Design Review

Excessive Uniformity, Inappropriateness Design
Subsection 4.400 (.01) and Subsection 4.421 (.03)

C1. Staff summarizes the compliance with this subsection as follows:

- **Excessive Uniformity:** The proposed development is unique to the particular development context and does not create excessive uniformity.
- **Inappropriate or Poor Design of the Exterior Appearance of Structures:** The proposed corporate headquarters/fabrication facility is attractively designed with emphasis on the office and retail/showroom areas at the front of the building and provides color and material changes to add interest to all visible sides of the

building.

- **Inappropriate or Poor Design of Signs:** One (1) building sign is proposed. The sign is designed to visually fit in with the building architecture and appropriately sized.
- **Lack of Proper Attention to Site Development:** The appropriate professional services have been used to design the site, demonstrating appropriate attention being given to site development.
- **Lack of Proper Attention to Landscaping:** Landscaping is provided exceeding the area requirements, has been professionally designed by a landscape architect, and includes a variety of plant materials, all demonstrating appropriate attention being given to landscaping.

Objectives of Site Design Review

Proper Functioning of the Site

Subsection 4.400 (.02) A. and Subsection 4.421 (.03)

- C2. The applicant does not propose any functional site changes affecting proper function of the site as part of this application.

High Quality Visual Environment

Subsection 4.400 (.02) A. and Subsection 4.421 (.03)

- C3. A professionally designed building, landscaping, and a professional, site-specific layout supports a high-quality visual environment.

Encourage Originality, Flexibility, and Innovation

Subsection 4.400 (.02) B. and Subsection 4.421 (.03)

- C4. The applicant proposes a corporate headquarters/fabrication facility that contains office and retail/showroom on the front façade (west side of the building). This adds significantly more visual interest and originality than a typical industrial development, thus providing a flexible and innovative design.

Discourage Inharmonious Development

Subsection 4.400 (.02) C. and Subsection 4.421 (.03)

- C5. The project is the fourth development within the Coffee Creek Industrial Area to be reviewed under the Coffee Creek Industrial Design Overlay District and Pattern Book. This project will continue the positive design precedent set by the Coffee Creek Logistics Center and Black Creek Group Industrial developments in the area to encourage future harmonious industrial development.

Proper Relationships with Site and Surroundings

Subsection 4.400 (.02) D. and Subsection 4.421 (.03)

- C6. The applicant's proposed building and site improvements have been designed with thoughtful consideration of their relationship with the environment. As described by the applicant and shown on the site plan (Sheets A1.0-A1.1 in Exhibit B2), the building is

located at the northwest corner of the site, close to the intersection of SW Garden Acres Road and future Supporting Street. This is the most urbanized area of the site, where, according to the Coffee Creek DOD Connectivity Plan, an Addressing Street intersects with a Supporting Street. The rest of the site, including the entire eastern half, is allowed to remain in its undeveloped state. The building is set back from SW Garden Acres Road to provide space for the large LIDA planters that will treat the site's stormwater. The site does not contain any steep slopes or other significant wildlife habitat areas. The lot to the south is wholly undeveloped at this time. To buffer that lot from the proposed development, the majority of the site activity, including access, the building main entrance, loading and most of the parking, are oriented as far north as possible on the subject site.

Attention to Exterior Appearances

Subsection 4.400 (.02) D. and Subsection 4.421 (.03)

- C7.** The applicant used appropriate professional services to design the exterior of the building. See also Finding B40 for Coffee Creek standards relating to building design.

Protect and Enhance City's Appeal

Subsection 4.400 (.02) E. and Subsection 4.421 (.03)

- C8.** The proposal adds future jobs to the City and enhances the appeal of SW Garden Acres Road by providing a high quality industrial development in the Coffee Creek Industrial Area.

Stabilize Property Values/Prevent Blight

Subsection 4.400 (.02) F. and Subsection 4.421 (.03)

- C9.** The site is located on SW Garden Acres Road, and adding services and amenities with a quality design add value to the Coffee Creek Industrial Area properties and prevent blight.

Adequate Public Facilities

Subsection 4.400 (.02) G. and Subsection 4.421 (.03)

- C10.** Adequate public facilities will be provided as part of development.

Pleasing Environments and Behavior

Subsection 4.400 (.02) H. and Subsection 4.421 (.03)

- C11.** Adding a new industrial development to the Coffee Creek Industrial Area with a quality design and wayside area will provide a pleasing environment and much needed pedestrian amenities.

Civic Pride and Community Spirit

Subsection 4.400 (.02) I. and Subsection 4.421 (.03)

- C12.** Adding a new development with a high quality design and creating additional jobs in the community will enhance SW Garden Acres Road and contribute to civic pride and community spirit.

Favorable Environment for Residents
Subsection 4.400 (.02) J. and Subsection 4.421 (.03)

C13. Adding a new industrial development with a quality design will create jobs, improve the Coffee Creek Industrial Area, and provide a favorable environment to residents and potential employees.

Jurisdiction and Power of the DRB for Site Design Review

Development Must Follow DRB Approved Plans
Section 4.420

C14. A condition of approval ensures construction, site development, and landscaping are carried out in substantial accord with the Development Review Board approved plans, drawings, sketches, and other documents.

Design Standards

Harmony of Proposed Buildings to Environment
Subsection 4.421 (.01) B.

C15. The proposed site design preserves off-site trees along the south property boundary and at the southeast corner of the project site, integrating to the extent possible with existing tree groves, and provides additional landscaping features that harmonize with the surrounding natural environment. See also Finding C6.

Advertising Features Do Not Detract
Subsection 4.421 (.01) F.

C16. No advertising features are proposed as part of the development. The building sign is sized and located appropriately to not detract from the design of the proposed structure and existing development on surrounding properties. See also Request E.

Design Standards Apply to All Buildings, Structures, Signs, and Features
Subsection 4.421 (.02)

C17. The project does not include any accessory structures on site.

Conditions of Approval to Ensure Proper and Efficient Function
Subsection 4.421 (.05)

C18. Staff does not recommend any additional conditions of approval to ensure the proper and efficient functioning of the development.

Color or Materials Requirements
Subsection 4.421 (.06)

C19. As described by the applicant and illustrated in their materials and renderings (Sheets G2.0 through G2.2, and A3.1-3.2 in Exhibit B2), the proposed development presents an alternative approach to industrial building design, utilizing an architectural palette of

materials that provides a more approachable, enjoyable aesthetic experience than what is typically seen in nearby industrial spaces. The project will incorporate wood accent siding, and accent slats over glazing elements. The exterior components of the project are shown in four different colors that blend with the natural landscape: Cool Dark Bronze (roof, lobby area walls, wall accent panels), Cool Zinc Gray (office area walls, walls at manufacturing and storage area), Teton Gray (wall base), and Dark Bronze (door and window frames, canopies, parapet cap, flashing). The colors and materials chosen are appropriate for the development. Staff does not recommend any additional requirements or conditions related to colors and materials.

Standards for Mixed Solid Waste and Recycling Areas

Mixed Solid Waste and Recycling Areas Colocation

Subsection 4.430 (.02) A.

C20. The proposal provides the required storage area for solid waste and recyclables located at the back (east side) of the proposed building in the loading/receiving area.

Exterior vs Interior Storage, Fire Code, Number of Locations

Subsections 4.430 (.02) C.-F.

C21. The applicant proposes a single location on the east side of the building. The area is appropriately screened. Review of the Building Permit will ensure that the building and fire code standards are met.

Collection Vehicle Access, Not Obstruct Traffic or Pedestrians

Subsections 4.430 (.02) G.

C22. The letter from Republic Services, included in the applicant's materials in Exhibit B1, indicates the location and arrangement is accessible to collection vehicles. The location of the storage area does not impede sidewalks, parking area aisles, or public street right-of-way.

Dimensions Adequate to Accommodate Planned Containers

Subsections 4.430 (.03) A.

C23. Pursuant to the letter from Republic Services, the dimensions are adequate to accommodate the planned containers.

6-Foot Screen, 10-Foot Wide Gate

Subsections 4.430 (.03) C.

C24. The solid waste and recyclables storage area is screened by a wall and landscaping in the loading area on the east side of the building and exceeds the minimum standards (Sheet G3.0 in Exhibit B2).

Site Design Review Submission Requirements

Submission Requirements

Section 4.440

C25. The applicant submitted a site plan drawn to scale, digital renderings and physical materials illustrating proposed finishes and paint colors.

Time Limit on Site Design Review Approvals

Void after 2 Years

Section 4.442

C26. The applicant plans to develop the proposed project within two (2) years and understands that the approval will expire after two (2) years unless the City grants an extension.

Installation of Landscaping

Landscape Installation or Bonding

Subsection 4.450 (.01)

C27. A condition of approval will assure installation or appropriate security equal to one hundred and ten percent (110%) of the cost of the landscaping as determined by the Planning Director is filed with the City assuring such installation within six (6) months of occupancy.

Approved Landscape Plan

Subsection 4.450 (.02)

C28. A condition of approval will ensure that substitution of plant materials, irrigation systems, or other aspects of an approved landscape plan will not be made without official action of the Planning Director or DRB and provide ongoing assurance the criterion is met.

Landscape Maintenance and Watering

Subsection 4.450 (.03)

C29. A condition of approval will ensure landscaping is continually maintained in accordance with this subsection.

Modifications of Landscaping

Subsection 4.450 (.04)

C30. A condition of approval will provide ongoing assurance that this criterion is met by preventing modification or removal of landscaping without appropriate City review.

Natural Features and Other Resources

Protection

Section 4.171

C31. The proposed design of the site provides for protection of natural features and other resources consistent with the proposed Stage 2 Final Plan for the site, as well as the purpose and objectives of Site Design Review.

Landscaping

Landscape Standards Code Compliance

Subsection 4.176 (.02) B.

C32. No waivers or variances to landscape standards have been requested. Thus all landscaping and screening must comply with the standards of this section.

Intent and Required Materials

Subsections 4.176 (.02) C. through I.

C33. The minimum or higher standard has been applied throughout different landscape areas of the site and landscape materials are proposed to meet each standard in the different areas. Site Design Review is being reviewed concurrently with the Stage 2 Final Plan, which includes a thorough analysis of the functional application of the landscaping standards.

Landscape Area and Locations

Subsection 4.176 (.03)

C34. As indicated in the applicant's narrative and plan set, overall site landscaping of 55,509 square feet, or 26.9%, of the 206,217-square-foot site development area is provided, which exceeds the 15% landscaping standard. In addition, the landscaping provided within the parking areas is 4,623 square feet, which is 20.9% of the 22,133 square feet of the site dedicated to parking area.

Buffering and Screening

Subsection 4.176 (.04)

C35. Consistent with the proposed Stage 2 Final Plan, adequate screening is proposed.

Shrubs and Groundcover Materials

Subsection 4.176 (.06) A.

C36. All of the proposed shrubs on the applicant's Landscape Plans (Sheet L1.0 in Exhibit B2) meet the required two (2)-gallon minimum. A condition of approval will ensure that the detailed requirements of this subsection are met.

Plant Materials-Trees
Subsection 4.176 (.06) B.

C37. Not all trees in the applicant's landscape plan (Sheet L1.0) are proposed to be two (2)-inch caliper (deciduous); therefore, a condition of approval will ensure the requirement is met. Conifers as proposed to be eight (8) feet in height, exceeding the six (6)-foot requirement of this subsection. A condition of approval will require all trees to be balled and burlapped (B&B), well-branched and typical of their type as described in current American Association of Nurserymen (AAN) Standards.

Plant Materials-Buildings Larger than 24 Feet in Height or Greater than 50,000 Square Feet in Footprint Area
Subsection 4.176 (.06) C.

C38. The proposed building, as shown on Sheets A3.1-A3.2 (Exhibit B2), is 36 feet tall to the roof peak of the warehouse/fabrication area and exceeds 50,000 square feet in footprint area, which meets the threshold for requiring larger or more mature plant materials as defined by this subsection. However, the design provides architectural interest by using a variety of materials in landscape areas surrounding the building. In addition, the applicant's plans propose to include numerous trees in the parking areas and around the site perimeter that soften views of the building from surrounding areas. It is staff's professional opinion that larger or more mature plant materials are not needed to achieve the intent of this subsection.

Types of Plant Species
Subsection 4.176 (.06) E.

C39. The applicant has provided sufficient information in their landscape plans showing the proposed landscape design meets the standards of this subsection.

Tree Credit
Subsection 4.176 (.06) F.

C40. The proposed number of trees in the landscape plans exceeds the minimum landscaping requirements and the applicant has not applied eligible tree credits.

Exceeding Plant Standards
Subsection 4.176 (.06) G.

C41. The selected landscape materials do not violate any height or vision clearance requirements.

Landscape Installation and Maintenance
Subsection 4.176 (.07)

C42. Conditions of approval ensure that installation and maintenance standards are or will be met including that plant materials be installed to current industry standards and properly staked to ensure survival, and that plants that die are required to be replaced in kind, within

one (1) growing season, unless appropriate substitute species are approved by the City. Notes on the applicant's Sheet L1.0 (Exhibit B2) provide for an irrigation system.

Landscape Plans
Subsection 4.176 (.09)

C43. The applicant's submitted plans provide the required information.

Completion of Landscaping
Subsection 4.176 (.10)

C44. The applicant has not requested to defer installation of plant materials.

Outdoor Lighting

Applicability
Sections 4.199.20 and 4.199.60

C45. An exterior lighting system is being installed for the proposed new development. The Outdoor Lighting standards thus apply.

Outdoor Lighting Zones
Section 4.199.30

C46. The project site is within LZ 2 and the proposed outdoor lighting systems will be reviewed under the standards of this lighting zone.

Optional Lighting Compliance Methods
Subsection 4.199.40 (.01) A.

C47. The applicant has elected to comply with the Prescriptive Option.

Wattage and Shielding
Subsection 4.199.40 (.01) B. 1.

C48. Based on the applicant's submitted materials, all proposed lighting is below the maximum wattage. A condition of approval will ensure that the requirements of the Outdoor Lighting Ordinance are met at the time of building permit issuance.

Table 7: Maximum Wattage And Required Shielding				
Lighting Zone	Fully Shielded	Shielded	Partly Shielded	Unshielded
LZ 2	100	35	39	Low voltage landscape lighting 50 watts or less

Compliance with Oregon Energy Efficiency Specialty Code
Subsection 4.199.40 (.01) B. 2.

C49. The applicant is complying with the Oregon Energy Efficiency Specialty Code.

Mounting Height

Subsection 4.199.40 (.01) B. 3.

- C50.** All exterior mounted lighting on the building is less than 40 feet high as shown on Sheets LT1.0 and LT1.2 in Exhibit B2. Pole-mounted fixtures are at 30 feet above grade and wall-mounted fixtures are at 14 feet above the building's finish floor elevation (FFE) to maintain a consistent level on all sides of the building. The maximum pole or mounting height complies with Table 8. A condition of approval will ensure the requirements of the Outdoor Lighting Ordinance are met at the time of building permit issuance.

Table 8: Maximum Lighting Mounting Height In Feet			
Lighting Zone	Lighting for private drives, driveways, parking, bus stops and other transit facilities	Lighting for walkways, bikeways, plazas and other pedestrian areas	All other lighting
LZ 2	40	18	8

Luminaire Setback

Subsection 4.199.40 (.01) B. 4.

- C51.** The subject property is bordered by the same base zoning and the same lighting zone on all sides. Staff understands the three (3) times mounting height setback to only apply where the property abuts a lower lighting district. A condition of approval will ensure the requirements of the Outdoor Lighting Ordinance are met at the time of building permit issuance.

Lighting Curfew

Subsection 4.199.40 (.02) D.

- C52.** As stated by the applicant, the proposed development will comply with the curfew requirements to either initiate operation at dusk and extinguish lighting one (1) hour after close or at the curfew time of 10:00 pm specified in Table 10; or reduce lighting intensity one (1) hour after close or at the curfew time to not more than 50% of the requirements set forth in the OEESC unless waived by the DRB; and to extinguish or reduce lighting on holidays as required except for Building Code lighting, lighting of pedestrian ramps, steps, and stairs, or due to special circumstances requiring the business to operate continuously or periodically after curfew.

Standards and Submittal Requirements

Sections 4.199.40 and 4.199.50

- C53.** All required materials have been submitted.

Request D: Waiver (WAIV22-0003)

Waiver: Parcel Driveway Width on Supporting Street

Waiver of Typical Development Standards
Subsections 4.134 (.08) and 4.118 (.03) A.

- D1.** The applicant requests to waive the parcel driveway width standards from the Coffee Creek Design Overlay District for the east site access from the Supporting Street. This driveway is proposed to be 40 feet wide to accommodate truck turning movements into the site from the Supporting Street. This requires a waiver from Subsection 4.134 (.11) Table CC-3 1. Parcel Access/Parcel Driveway Width/Supporting Streets, which allows a driveway width of 24 feet maximum or compliance with the Supporting Street standards. The applicant states the rationale for requesting this waiver as follows: the 40-foot-wide driveway is necessary to accommodate truck operations for turning requirements, movement, circulation, and safety considerations. This is the only waiver requested by the applicant to the Coffee Creek Design Overlay District standards.

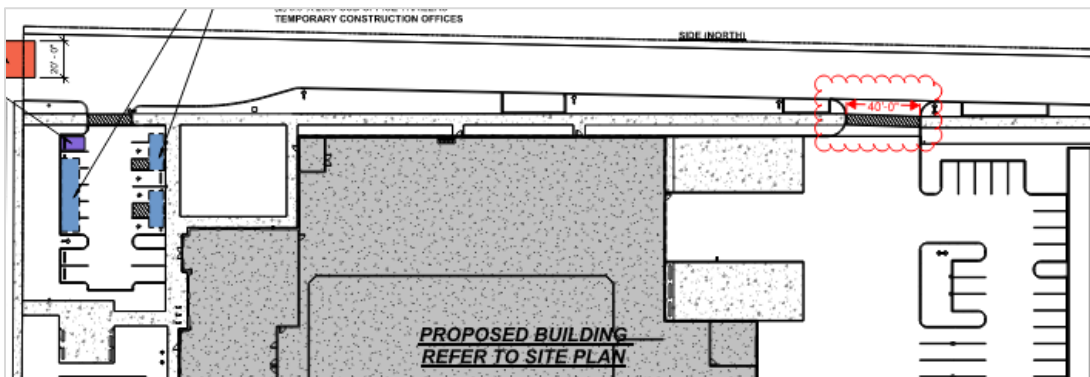

Purpose and Objectives of Planned Development Regulations
Subsection 4.140 (.01) B.

- D2.** Pursuant to Subsection 4.118 (.03) A., waivers must implement or better implement the purpose and objectives listed in this subsection. The project is designed to conform to the Regulating Plan with Addressing Street SW Garden Acres Road on the west and a Supporting Street on the north property boundary. As the Coffee Creek Design Overlay District standards do not allow driveways on Addressing Streets, the site must take access from the Supporting Street. To accommodate truck traffic and turning movements at the east driveway, it must be wider than the allowed 24-foot maximum. A narrower driveway would constrain truck turning movements leading to congestion in the Supporting Street from wide turns and/or queuing as trucks wait to enter the driveway. A wider driveway allows the site to achieve its function efficiently, practically, and safely for its intended industrial use. Therefore, the applicant specifically requests this waiver to allow flexibility in the design that responds to site-specific features and conditions of the project site.

Request E: Class 3 Sign Permit (SIGN22-0011)

As described in the Findings below, the request meets the applicable criteria or will by conditions of approval.

Sign Review and Submission

Class 2 Sign Permits Reviewed by DRB

Subsection 4.031 (.01) M. and Subsection 4.156.02 (.03)

- E1.** The application qualifies as a Class 3 Sign Permit subject to Development Review Board review.

What Requires Class 3 Sign Permit Review

Subsection 4.156.02 (.06)

- E2.** The request involves a single tenant in a development subject to Site Design Review by the Development Review Board, thus a Class 3 Sign Permit is required.

Signs Exempt from Sign Permit Requirements

Subsection 4.156.05 (.01) C.

- E3.** Flags displayed from permanently-located freestanding or wall-mounted flag poles that are designed to allow raising and lowering of flags are exempt from permit requirements of the Code and do not require sign permit. One (1) site may have up to two (2) exempt flags and no exempt flag may be more than 30 feet in height. The applicant proposes two (2) flag poles near the building entrance on the west elevation at a height of 20 feet, which meets the standard.

Class 3 Sign Permit Submission Requirements

Subsection 4.156.02 (.06) A.

- E4.** As indicated in the table below the applicant has satisfied the submission for Class 3 sign permits, which includes the submission requirements for Class 2 sign permits:

Requirement	Submitted	Waiver Granted		Condition of Approval	Not Applicable	Additional Findings/Notes
		Info Already Available to City	Info Not Necessary for Review			
Completed Application Form	<input checked="" type="checkbox"/>	<input type="checkbox"/>	<input type="checkbox"/>	<input type="checkbox"/>	<input type="checkbox"/>	
Sign Drawings or Descriptions	<input checked="" type="checkbox"/>	<input type="checkbox"/>	<input type="checkbox"/>	<input type="checkbox"/>	<input type="checkbox"/>	
Documentation of Tenant Spaces Used in Calculating Max. Sign Area	<input type="checkbox"/>	<input type="checkbox"/>	<input type="checkbox"/>	<input type="checkbox"/>	<input checked="" type="checkbox"/>	
Drawings of Sign Placement	<input checked="" type="checkbox"/>	<input type="checkbox"/>	<input type="checkbox"/>	<input type="checkbox"/>	<input type="checkbox"/>	
Project Narrative	<input checked="" type="checkbox"/>	<input type="checkbox"/>	<input type="checkbox"/>	<input type="checkbox"/>	<input type="checkbox"/>	
Information on Any Requested Waivers or Variances	<input type="checkbox"/>	<input type="checkbox"/>	<input type="checkbox"/>	<input type="checkbox"/>	<input checked="" type="checkbox"/>	

Class 3 Sign Permit and Waiver Review Criteria

Class 2 Sign Permit Review Criteria: Generally and Site Design Review
Subsection 4.156.02 (.05) F.

E5. As indicated in Findings below, the proposed signs will satisfy the sign regulations for the applicable zoning district and the relevant Site Design Review criteria.

Class 2 Sign Permit Review Criteria: Compatibility with Zone
Subsection 4.156.02 (.05) F. 1.

E6. The applicant is proposing one (1) sign on the west façade of the building facing SW Garden Acres Road. The proposed sign is generally typical of, proportional to, and compatible with development in the PDI-RSIA zone. No evidence has been presented, nor testimony received, demonstrating the subject sign would detract from the visual appearance of the surrounding development.

Class 2 Sign Permit Review Criteria: Nuisance and Impact on Surrounding Properties
Subsection 4.156.02 (.05) F. 2.

E7. There is no evidence, and no testimony has been received, suggesting the proposed sign would create a nuisance or negatively impact the value of surrounding properties.

Class 2 Sign Permit Review Criteria: Items for Special Attention
Subsection 4.156.02 (.05) F. 3.

E8. The sign does not conflict with the design or placement of other site elements, landscaping, or building architecture reviewed as part of this application. The appropriate placement of the signs will be ensured by conditions of approval.

Sign Measurement

Measurement of Individual Element Signs
Subsection 4.156.03 (.01) B.

E9. The sign measurements use individual elements, as allowed by this subsection. However, the calculations of sign area shown on the applicant’s sign plan Sheet A3.3 in Exhibit B2 are incorrect. The standard requires that a sign constructed of individual elements such as letters, figures, etc., attached to a building wall be measured using the summed area of up to three squares, rectangles, circles, or triangles drawn around all sign elements. The applicant has measured the area of each individual letter rather than using three or fewer rectangles drawn around the letters or words in the sign. A condition of approval ensures that the sign will be measured correctly and adjusted as needed to comply with the standard as the time of application for sign approval.

Freestanding and Ground Mounted Signs in the PDC, TC, PDI , and PF Zones

General Allowance
Subsection 4.156.08 (.01) A.

E10. The subject site has frontage on SW Garden Acres Road of sufficient length to be sign eligible; however, the applicant does not proposed a freestanding or ground mounted sign in the current application.

Building Signs in the PDC, PDI , and PF Zones

Establishing whether Building Facades are Eligible for Signs
Subsection 4.156.08 (.02) A.

E11. All facades of the proposed building are sign eligible as follows:

Façade	Sign Eligible	Criteria Making Sign Eligible
North	Yes	Frontage on a street
East	No	
South	No	
West	Yes	Entrance open to the general public, frontage on a street, façade adjacent to primary parking area for building

The proposed building is anticipated to have up to one (1) tenant and the building design has one (1) entrance open to the general public. The primary building entrance faces

Addressing Street SW Garden Acres Road on the west façade in the northwest building corner.

Building Sign Area Allowed

Subsection 4.156.08 (.02) B. 1.

E12. The west façade of the proposed office and retail/showroom of the building is roughly 170 feet (ft) in length, with the entire west facing building elevation being 240 linear ft. For facades greater than 72 linear ft, the allowed sign area is 36 square feet (sf) plus 12 sf for each 24 linear feet or portion thereof greater than 72 ft up to a maximum of 200 sf. Therefore, the allowed sign area is 36 sf plus 84 sf ($240\text{ft} - 72\text{ft} = 168\text{ft} / 24\text{ft} \times 12\text{sf} = 84\text{sf}$), or a total of 120 sf. As shown on the sign plan (Sheet A3.2 in Exhibit B2), the proposed sign area measured in two rectangles is 125 sf ($50\text{sf} + 75\text{sf} = 125\text{sf}$), which is five (5) square feet more than the allowed area. A condition of approval has been added to require the applicant to reduce the size of the sign area by five (5) sf consistent with the standard.

Building Sign Length Not to Exceed 75 Percent of Façade Length

Subsection 4.156.08 (.02) C.

E13. The overall building sign length is approximately 59 feet, which is 35% of the office and retail/showroom façade and 25% of the entire west facing façade length, which does not exceed 75% of the length of the façade.

Building Sign Height Allowed

Subsection 4.156.08 (.02) D.

E14. The proposed building sign is within a definable architectural feature; however, it is unclear whether there is a definable space between the sign and the top and bottom of the architectural feature. A condition of approval ensures the standard is met.

Building Sign Types Allowed

Subsection 4.156.08 (.02) E.

E15. The proposed building sign is a fascia sign, which is an allowed sign type in this subsection.

Site Design Review

Excessive Uniformity, Inappropriate Design

Subsection 4.400 (.01)

E16. With quality materials and design, the proposed sign will not result in excessive uniformity, inappropriateness or poor design, and the proper attention has been paid to site development.

Purpose and Objectives

Subsection 4.400 (.02) and Subsection 4.421 (.03)

E17. The sign is scaled and designed appropriately related to the subject site and the appropriate amount of attention has been given to visual appearance. The sign will provide local emergency responders and other individuals reference for the location of this development.

Design Standards

Subsection 4.421 (.01)

E18. The proposed location and approximate size of proposed sign and detail about design, color, texture, lighting, or materials is included in the applicant's sign plan Sheet A3.3 in Exhibit B2. The sign is proposed to be white letters held 3.5 inches off the building face that will be backlit, which will complement the design of the proposed building and surrounding properties, consistent with the design standards of this section.

Design Standards and Signs

Subsection 4.421 (.02)

E19. Design standards have been applied to the proposed signs, as applicable, see Findings E16-E18, above.

Color or Materials Requirements

Subsection 4.421 (.06)

E20. As stated under Finding E18, above, information about the proposed coloring of the signs is included in the applicant's materials, and appear appropriate for the sign.

Site Design Review-Procedures and Submittal Requirements

Section 4.440

E21. The applicant has submitted a sign plan as required by this section.

Request F: Type C Tree Removal Plan (TPLN22-0006)

As described in the Findings below, the request meets the applicable criteria or will by conditions of approval.

Type C Tree Removal-General

Exception from Tree Removal Permit Requirement

Subsection 4.600.40 (.01) A.

F0. The applicant is not requesting exemptions from tree removal permit requirements.

Review Authority

Subsection 4.610.00 (.03) B.

- F1.** The requested removal is connected to Site Design Review by the Development Review Board for new development. The tree removal is thus being reviewed by the DRB.

Conditions of Approval

Subsection 4.610.00 (.06) A.

- F2.** No additional conditions are recommended pursuant to this subsection.

Completion of Operation

Subsection 4.610.00 (.06) B.

- F3.** It is understood the tree removal will be completed by the time development of the proposed facility is completed, which is a reasonable time frame for tree removal.

Security for Permit Compliance

Subsection 4.610.00 (.06) C.

- F4.** No bond is anticipated to be required to ensure compliance with the tree removal plan as a bond is required for overall landscaping.

Tree Removal Standards

Subsection 4.610.10 (.01)

- F5.** The standards of this subsection are met as follows:
- Standard for the Significant Resource Overlay Zone: The proposed tree removal is not within the Significant Resource Overlay Zone.
 - Preservation and Conservation: The applicant has taken tree preservation into consideration, and has limited tree removal to trees that are necessary to remove for development. Several trees in the southeast part of the site, which is not proposed for development in the current application, will be retained, as well as numerous off-site trees along the property's south boundary. Removal of some of the south boundary trees may be necessary; however, their removal is contingent upon agreement between the applicant and owners of the neighboring property to the south.
 - Development Alternatives: No significant wooded areas or trees would be preserved by practical design alternatives.
 - Land Clearing: The applicant has limited clearing of land to areas necessary for the construction of buildings, structures and other site improvements.
 - Residential Development: The proposed activity does not involve residential development, therefore this criteria does not apply.
 - Compliance with Statutes and Ordinances: The necessary tree replacement and protection is planned according to the requirements of the tree preservation and protection ordinance.

- Relocation or Replacement: The applicant proposes to plant 47 trees as replacement for the nine (9) on-site trees proposed for removal, exceeding the one-for-one (1:1) replacement requirement.
- Limitation: Tree removal is limited to where it is necessary for construction or to address nuisances or where the health of the trees warrants removal.
- Tree Survey: A tree survey has been provided.

Review Process

Subsection 4.610.40 (.01)

F6. The proposed Type C Tree Plan is being reviewed concurrently with the Stage 2 Final Plan.

Tree Maintenance and Protection Plan

Section 4.610.40 (.02)

F7. The applicant has submitted the necessary copies of a Tree Maintenance and Protection Plan. See the applicant's Sheet L1.1 in Exhibit B2.

Replacement and Mitigation

Tree Replacement Requirement

Subsection 4.620.00 (.01)

F8. As noted in Finding F5, the applicant is planting 47 trees, substantially exceeding the one-to-one ratio required by this subsection.

Basis for Determining Replacement

Subsection 4.620.00 (.02)

F9. The applicant proposes removing nine (9) trees and potentially an additional seven (7) trees on the south property boundary, for a total of 16 trees, and planting 47 trees. Replacement trees will meet the minimum caliper requirement or will be required to by condition of approval.

Replacement Tree Requirements

Subsection 4.620.00 (.03)

F10. A condition of approval will ensure the relevant requirements of this subsection are met.

Replacement Tree Stock Requirements

Subsection 4.620.00 (.04)

F11. A condition of approval will ensure the relevant requirements of this subsection are met.

Replacement Trees Locations

Subsection 4.620.00 (.05)

F12. The applicant is proposing tree planting along SW Garden Acres Road as part of screening and the wayside area, as well as along the Supporting Street, and in the parking areas on the west and east sides of the site. The applicant is also planting trees in parking lot islands

in accordance with the requirements of Section 4.155. The proposed tree locations are appropriate for the development.

Protection of Preserved Trees

Tree Protection During Construction

Section 4.620.10

F13. Tree protection is required. All trees required to be protected must be clearly labeled as such, and suitable barriers to protect remaining trees must be erected, maintained, and remain in place until the City authorizes their removal or issues a final certificate of occupancy. A condition of approval will ensure the applicable requirements of this section are met.



Planning Division Memorandum

From: Cindy Luxhoj AICP, Associate Planner
To: Development Review Board Panel B
Date: March 27, 2023
RE: DB22-0011 Precision Countertops – Request to Reschedule Public Hearing

The DB22-0011 Precision Countertops application includes the following requests:

- Stage 1 Preliminary Plan (STG122-0006)
- Stage 2 Final Plan (STG222-0007)
- Site Design Review (SDR22-0007)
- Waiver (WAIV22-0003)
- Class 3 Sign Permit (SIGN22-0011)
- Type C Tree Removal Plan (TPLN22-0006)

This application was originally scheduled for public hearing before Development Review Board (DRB) Panel B on March 27, 2023. In reviewing the applicant's materials during preparation of the DRB staff report, City staff identified issues with the proposed site plan and met with the applicant on March 9, 2023, to address these concerns. Because achieving compliance with the Code will result in revisions to the submitted materials, delaying the DRB public hearing to a future date is necessary to provide adequate time for changes to be made.

The applicant previously requested to extend the 120-day review period on this application to May 3, 2023. However, if needed, the review period could be extended to December 14, 2023, which is 365 days from to date the application was deemed complete. Therefore, rescheduling the DRB public hearing to a future date is well within the extended 120-day review period.



Project Memorandum

Precision Countertop Building
Site Design and Architectural Design
Application Numbers: AR22-0008 Precision Countertops

Proposal: Annexation, Zone Map Amendment, Stage 1 Master Plan, Stage 2 Final Plan, Site Design Review, Type C Tree Plan.

Location/Legal: 25540 SW Garden Acres Road. Tax Lot 500, Section 2C, Township 3 South, Range 1 West, Willamette Meridian, Washington County, Oregon

This memorandum addresses responses to the missing items 1-15 highlighted under the Incompleteness Letter dated August 5, 2022.

1. *Indicate proposed future expansion area on Stage 1 Master Plan diagram.*

Response: The project will not have a future expansion nor future phasing at this time. The approach for the remaining land holdings is undetermined. The proposed project will not be seeking a land partition of the eastern-most portion of the property.

2. *Provide phased development schedule.*

Response: There will only be one phase of the project. Please refer to the Development Schedule provided by PHI Construction, illustrating the pre-construction planning schedule, starting from Land Feasibility to 100% Construction Set Drawings in 2024.

3. *Provide physical materials/color board (or samples) displaying specifications of type, color, and texture of exterior surfaces of proposed architectural features of the building.*

Response: The project team has provided physical materials and color board samples displaying specification of type, color, and texture of exterior surfaces of proposed architectural features of the building. The team has include all samples with labels.

4. *Clearly indicate on plans the location of proposed fences on the site.*

Response: The proposed fence is clearly indicated in blue color on Sheet A1.1 and labeled <SP-031>. The fence will be ornamental black bar at 6'-0" in height and have

one ornamental gate that is 20' clear width and two pedestrian doors. The location of the Knox box will be coordinated with the Fire Marshal. The proposal has included details of the fence design on sheet A1.3.

5. *Clearly indicate on plans how proposed on-site improvements integrate with recently constructed public right-of-way frontage improvements on SW Garden Acres Road*

Response: Please reference sheet A1.2 Site Plan. This exhibit illustrates the on-site improvements of Garden Acres and future Java Road and how the public right-of-way frontage improvements will be constructed. The site plan shows how the proposed development will establish pedestrian connections and pathways from the proposed building to the Addressing Street and how the development will reconcile the intersection of Garden Acres Road and the future Java Road, including parking access and landscaping design.

6. *Provide a sign plan and cut sheets of proposed design, material, color and methods of illumination of all exterior signs*

Response: The application includes a sign plan and cut sheets of the proposed sign design, including design, material, color, and methods of illumination of building sign. See refer to sheet A3.3 for the building signage detail and section through the signage. The building signage will be 170 linear feet and 36 square feet in area. Please refer to sheet A3.2 for sign location on the building. Please refer to sheet G2.0 for a perspective image of the building sign installation.

7. *Indicate conformance method used for outdoor lighting and provide drawings/cut sheets with details of luminaire type, mounting method, height, watts, shielding, etc., and calculations demonstrating compliance with Oregon Energy Efficiency Specialty Code, Exterior Lighting. Demonstrate how light spill-over to adjacent properties will be minimized*

Response: Please refer to sheet LT1.0 and LT1.2 Lighting Plans, Statistics, Schedules, LT2.0, and LT2.1 Lighting Cut Sheets illustrating the conformance method used for outdoor lighting, including luminaire type, mounting method, height recommendation, wattage, shielding, and code compliance. The photometric plan also demonstrates how light spill-over to adjacent properties will be minimized.

8. *Include the Tree Removal Plan and inventory in the combined plan set, and indicate, for all trees in survey table in Arborist Report, whether each tree will be removed or retained.*

Response: Please reference sheet L1.1 Tree Removal Plan and inventory indicating all trees in Arborist Report and survey table that shall be removed and retained. The sheet includes the Arborist Tree Survey and tree protection fencing approach.

9. *Indicate on plans how pathways crossing parking areas or driveways will be clearly marked with contrasting paint or paving materials*

Response: Please reference sheet A1.2 Site Plan. The proposed development will provide high contrasted pedestrian pathways across the driveways marked with paint. These areas occur at two locations where new pedestrian crossings will be installed.

10. Calculate bicycle parking using the same mix of uses as for passenger vehicle parking spaces (Fabrication, Warehouse, Retail, Office). Indicate locations and dimensions of maneuvering areas for proposed bicycle parking on plans

Response: The Cover Sheet indicates the calculation of bicycle parking using the mix of uses as for passenger vehicle parking spaces. The table outlines the number of required parking spaces and the number of proposed parking based on Fabrication, Warehouse/Storage, Retail/Showroom, and Office use. The proposed development includes 6 short term and 6 long term bicycle parking. Please reference sheet A1.1 locating the 6 short term bicycle parking located directly outside the building entry. The reference detail is on sheet A1.3 indicating the dimensions of maneuvering areas for the proposed bicycle parking on the site plan.

11. Indicate dimensions of all loading berths on plans

Response: Please reference sheet A1.1 Enlarged Site Plan for dimensions of all loading berths.

12. Include the approved site plan attachment with the Service Provider Letter from Republic Services. Provide cut sheets of dimensions, design, and materials of commingled recyclables area

Response: Please reference sheet G3.0 Recycling Flow & Details illustrating location, dimensions, design, and materials of the commingled recycling area.

13. Provide sufficient findings and materials addressing standards of the Coffee Creek Industrial DOD including, but not limited to, the following:

a. Provide additional renderings of building architecture, wayside area, and landscaping along the Addressing and Supporting Streets to demonstrate compliance with requirements of Coffee Creek Industrial Design Overlay District (DOD).

Response: Please reference sheet G2.0 and G2.1 Renderings for additional renderings of the building architecture, wayside areas, and landscape design along both the Addressing Street and Supporting Street.

b. Table CC-3 Site Design, 1. Parcel Access, Parcel Driveway Width. Demonstrate how the 24-foot maximum driveway width from the proposed Supporting Street is met. Staff notes that the plans show a west driveway width of 30 feet and east driveway width of 40 feet, which exceeds the maximum.

Response: The driveway width will be the only waiver of the proposed development. Please reference sheet A1.1 for the driveway width. There are two access points from the future Java Road; the first is 24'-0" and is within the allowable drive access width; however, the second driveway access width is 40'0". The increased width is proposed in order to accommodate truck maneuvering and safe access.

c. Table CC-3 Site Design, 2. Parcel Pedestrian Access, General. Explain how required pedestrian access from the Supporting Street right-of-way will be provided to the site in the first phase of the project (before the street is fully built). Staff notes that no direct connection to the Supporting Street is shown in the first phase of development.

Response: Please reference sheet A1.2 Site Plan. This sheet illustrates how pedestrian access from the future Java Road will be constructed. Note that there is only one phase of this development.

- d. *Table CC-3 Site Design, 2. Parcel Pedestrian Access, Parcel Pedestrian Access Width. Demonstrate how the minimum 8-foot walkway width from the Addressing and Supporting Streets is met. Staff notes that the plans show a walkway width of 7 feet at the sidewalk on the Addressing Street and no direct access to the Supporting Street.*

Response: Please reference sheet A1.1. This sheet illustrates how the minimum 8-foot walkway width from Garden Acres Road and the future Java Road are met. The proposed development includes an 8'-0" sidewalk from Garden Acres road to the building entrance. The proposed development also includes an 8'-9" wide sidewalk from the future Java Road to the building entrance.

- e. *Table CC-3 Site Design, 4. Parking Location and Design, Parking Setback. Demonstrate how the 15-foot minimum parking setback from the right-of-way of the Supporting Street is met. Staff notes the setback appears to be less than 15 feet for both the front and rear parking areas; however, it is difficult to determine the actual extent of right-of-way in relation to the parking areas.*

Response: Please reference sheet A1.0 illustrating the parking setback dimension from the right-of-way of Garden Acres Road and future Java Road. The parking setback dimension along the Addressing Street is 33'-0". The parking setback along future Supporting Street is greater than 15'-0".

- f. *Table CC-3 Site Design, 4. Parking Location and Design, Parking Lot Sidewalks. Demonstrate how the minimum 9-foot depth for planted areas adjacent to off-street parking areas is met. Staff notes that landscape areas adjacent to parking along the Supporting Street appear to be less than 9 feet wide.*

Response: Please reference sheet A1.1 illustrating a 11'-8" depth of planting area adjacent to the off-street parking areas along Garden Acres Road and a 15'-0" depth of planning and stormwater facilities adjacent to the off-setter parking areas along future Java Road.

- g. *Table CC-3 Site Design, 6. Planting, Landscaping Standards Permitted. Demonstrate how loading areas at the east side of the building that are along the Supporting Street are screened to the High Screen or High Wall Standard.*

Response: Please reference sheet A1.1 illustrating a 6ft screening located on the north side of the building's loading areas along the Supporting Street. Sheet G2.1 rendering (loading dock view – future Java Road condition) illustrates the 6ft high screen wall.

- h. *Table CC-3 Site Design, 7. Location and Screening of Utilities and Services, Required Screening. Demonstrate how the commingled recycling area is screened to the High Screen or High Wall Standard.*

Response: Please reference sheet A1.1 illustrating a 6ft screening located on the north side of the building's recycling areas along the Supporting Street. Sheet G2.1

rendering (loading dock view – future Java Road condition) illustrates the 6ft high screen wall.

- i. *Table CC-4 Building Design, 2. Primary Building Entrance, Visibility. Demonstrate how direct line of sight from the Addressing Street to the Primary Building Entrance is achieved. Staff notes that it appears that landscaping between the street and entry may partially obscure view of the entry.*

Response: Please reference sheet A4.1 Building Sections demonstrating how the design ensures direct line of sight from Garden Acres Road to the building's entrance. Please reference sheet G2.0 renderings illustrating how the design protects the line of sight from Garden Acres Road.

- j. *Table CC-4 Building Design, 3. Overall Building Massing, Base, Body, and Top Dimensions; Base Design; Top Design. Demonstrate how a clearly demarcated base, body, and top of the building on the Addressing and Supporting Streets is achieved. Include an additional drawing of these elevations that defines the base, body, and top dimensions as defined in the Coffee Creek Industrial DOD. Demonstrate how the base and top create a change in surface position related to the body of the building.*

Response: Please reference sheet A3.2 and detail No. 5 and No. 2 illustrating how the building design clearly demarcated base, body, and top of the building on the Addressing and Supporting Streets. The building base (WB1), building wall body (WP1), and the top of building (WP3) demarcate unique materials and create a change in surface position related to the body of the building. Please reference the physical materials provided.

- k. *Table CC-3 Building Design, 3. Overall Building Massing, Required Screening of Roof-mounted Equipment. Demonstrate that any roof-top mechanical equipment will be screened from ground-level view from rights-of-way or adjacent properties at the property line. Demonstrate that no roof-top mechanical equipment will be visible from an Addressing and Supporting Streets.*

Response: Please reference sheet A4.1, section No. 2 illustrating how the building will screen the roof-top mechanical equipment from ground-level view and from the public right of way. Please also reference sheet G2.0 renderings showing how the building design will screen all mechanical units.

- l. *Waysides: Demonstrate how all required wayside amenities including seating, landscaping, lighting, and recycling/waste receptacle are provided. Staff notes that seating and landscaping are shown; however lighting and a receptacle are not included. Provide cut sheets/details of all required and optional amenities. Demonstrate how solar access and exposure to sunlight between the hours of 10 am and 2 pm is achieved. Staff notes that the narrative lists a steel trellis as an optional amenity in the wayside; however, the plans do not include a trellis.*

Response: Please reference sheet A1.1 Site Plan and G2.0 renderings illustrating seating, landscape design, lighting, and receptacles provided in key locations of the building entrance and entry plaza. Reference sheet L3.0 Wayside Sunlight Study illustrating how the design ensures solar access and sunlight exposure during the hours of 10am and 2pm throughout the year.

- m. *Request waivers, as appropriate, for all proposed deviations from development standards and/or DOD standards and adjustment allowances. Please note that if waivers are requested, the application will no longer be eligible for Administrative Review and will require review by the Development Review Board.*

Response: The proposed development will be requesting a waiver for an increased driveway width dimension, noted on sheet A1.1. The eastern-most driveway access off future Java Road will need to be 40'-0" for safety and maneuvering of trucks.

14. *Address how upstream stormwater will be handled in the Stormwater Report. Incorporate design elements necessary to address source control issues (hydraulically isolated loading dock, etc.).*

Response: Revised plans and drainage analysis include inlets and piping to collect storm runoff from adjacent parcel to north and from future east site development area. Separate inlets have been provided in the various truck docks to collect runoff from a 3 ft. width along the building. This runoff is directed to the site sanitary sewer system

15. *Incorporate stormwater facilities throughout the design, rather than in one large facility as proposed. Staff notes that it is unclear why facilities were not incorporated into the Supporting Street improvements in the landscaping areas and/or into the landscaping areas in the parking lot. The Geotech Report states that groundwater was shallow but did not identify a depth. The infiltration tests must be performed in the location and to the base depth of the proposed facility (only shallow infiltration testing performed).*

Response: Based on several discussions with staff, the storm treatment and flow control facilities have been reconfigured to provide four LID rain gardens along the northern portion of the development area, a LID planter at the east side of the development area and a LID planter west of the proposed building. Staff has indicated this configuration is acceptable. Staff has not indicated further infiltration testing is required.

Planning Comments

- A. *The project narrative document has comments in it by/for the applicant; these should be removed when the document is resubmitted. Please provide both Word and PDF versions of the narrative with the resubmittal.*

Response: The narrative has been updated.

- B. *The rendering of the front of the building shows two flag poles. If flag poles are proposed, indicate this on the site plan and provide dimensions and sign drawing details in the sign plan.*

Response: Please reference sheet A1.1 Site Plan and G2.0 renderings illustrating the location and height of the building's two flag poles.

- C. *It would facilitate staff's review to separate the site plan from the fire service plan, which are combined on sheet A1.0 in the plan set. Engineering and Natural Resources Comments (in addition to incomplete items included above)*

Response: Please reference sheet FS1.0 Fire Service Site Plan illustrating pedestrian path connections, fire apparatus access, gate access, hydrant locations, driveway and aisle width, etc.

Engineering and Natural Resources Comments

- D. *The water system shall be looped to the extent feasible. There is an existing stub to the south and to the north of the property that should be used to serve this property. This can be resolved during Building Permit review. The property shall be served by separate irrigation, domestic and fire suppression lines.*

Response: As staff has mandated significant changes to the storm and sanitary systems, the final configuration requires two storm pipes and two sanitary sewer pipes virtually along the entirety of the development area south boundary, sufficient additional width is not available for a second public water main along the south property boundary (in addition to the public water main mandated in the private drive along the north property boundary).

- E. *Applicant should evaluate whether depth of sewer is adequate to serve future phases by gravity when the eastern portion of the property develops.*

Response: A separate private sanitary sewer pipe is shown along the development area south property boundary to serve future development at the east portion of the property.

Building Comments

- G. *Effective July 1, 2022, new commercial buildings are required to comply with electric vehicle charging infrastructure requirements for parking areas in accordance with OAR 918-460-0200.*

Response: Please reference sheet A1.1 Site Plan locating electric vehicle charging infrastructure per OAR 918-460-0200. Keynote <SP-041>

Project Memorandum

City of Wilsonville, Oregon

Development Review Application –Comment Response to City Comments and Corrections

Precision Countertop Building
Site Design and Architectural Design
Application Numbers: DB22-0011 Precision Countertops

Proposal:

Annexation (ANNX22-0004), Zone Map Amendment (ZONE22-0005), Stage 1 Master Plan (STG122-0006), Stage 2 Final Plan (STG222-0007), Site Design Review (SDR22-0007), Waiver (WAIV22-0003), Type C Tree Plan (TPLN22-0006), Class 3 Sign Plan (SIGN22-0011)

Location/Legal:

25540 SW Garden Acres Road. Tax Lot 500, Section 2C, Township 3 South, Range 1 West, Willamette Meridian, Washington County, Oregon.

This memorandum addresses comments and corrections related to compliance to be addressed in the final set of application material:

Planning Comments

- A. Revise Development Permit Application form to show correct property owner and have the owner sign and date the form before resubmittal. Staff notes that the form on file shows the property owner as Glen Wetzel, while the narrative and other materials show the owner/applicant as PCT NW Properties OR LLC.

Response: *The team have revised the Development Permit Application form to show correct property owner and includes the property owner's signature.*

- B. Include a column in the tree survey table on Sheet L1.1 that indicates for each tree whether it will be removed or retained.

Response: Sheet L1.1 includes the Tree Inventory Table from the Arborist Tree Survey. The table now includes a column indicating whether the tree is slated for remove or to be retained.

- C. Provide sufficient findings and materials addressing standards of the Coffee Creek Industrial DOD including, but not limited to, the following:
 - a. Table CC-3 Site Design, 2. Parcel Pedestrian Access, General. Explain how separate and direct pedestrian connections between parking, entrances, and street right-of-way are provided along the Supporting Street between the Addressing Street and the east portion of the site not currently proposed for development. Staff notes that the sidewalk along the Supporting Street doesn't directly connect to the Addressing Street right-of-way or extend to the east past the proposed development area.

Response: The following excerpt from the proposed site plan illustrates the extension of the sidewalk past the proposed development area to the east. An additional pedestrian connection has been added along the supporting street to allow direct access to the addressing street right-of-way. A painted pedestrian path has been added where the connection crosses the west parking lot drive aisle.



- b. Table CC-3 Site Design, 4. Parking Location and Design, Parking Setback. Demonstrate how the 20-foot minimum parking setback from the right-of-way of the Addressing Street is met; the measurement is from the edge of right-of-way, not the edge of pavement as shown on Sheet A1.1. Demonstrate how the 15-foot minimum parking setback from the right-of-way of the Supporting Street is met; the edge of right-of-way is unclear on Sheets A1.1 and A1.2, thus it is difficult to determine the actual extent of right-of-way in relation to the parking area.

Response: The Dimension of 20' parking setback from ROW from addressing street has been added to A1.1. Dimension of 15' parking setback from ROW of Supporting Street has been added to A1.1. The following exhibit illustrates a setback up to 23ft from the parking area to the right-of-way of the Supporting Street. This also includes 9'-0" of landscaping between the parking area and the 6ft pedestrian sidewalk.

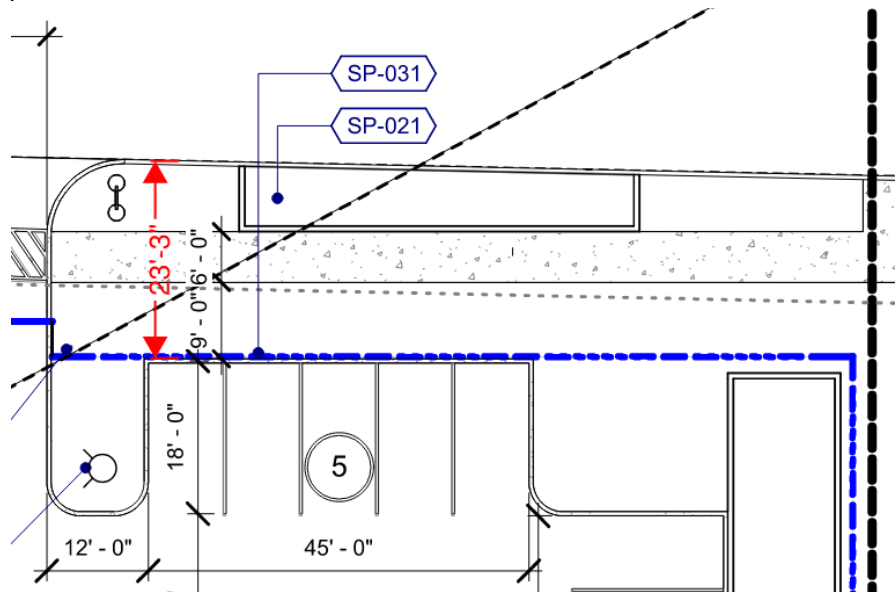

- c. Table CC-3 Site Design, 4. Parking Location and Design, Parking Lot Sidewalks and Parking Perimeter Screening and Landscaping. Demonstrate how the minimum 9-foot depth for planted areas adjacent to off-street parking areas and the General Landscape Standard or Low Berm Standard (see Section 4.176 (.02) C. and F.) are met for the east parking area on the Supporting Street. There doesn't appear to be any landscaping to screen parking from the Supporting Street in this area, as the sidewalk is curb-tight to the parking.

Response: The proposed development includes a 9ft landscaped planted area adjacent to the northeast parking area on the

Supporting Street. Dimension has been added to A1.1 noting the depth of landscaped area. The following exhibit shows that all General Landscaping standard have been met.

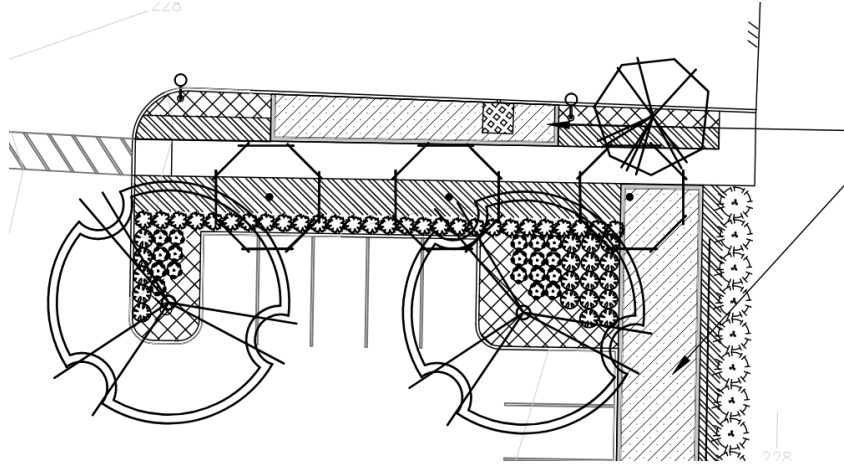

- d. Table CC-3 Site Design, 5. Grading and Retaining Walls, Maximum Height, Required Materials, Retaining Wall Design. Demonstrate how the standards are met for the retaining wall along the Supporting Street shown on Sheet C3.0.

Response: *The proposed development has been revised, removing all retaining walls along the Supporting Street. Requirement no longer applied.*

- e. Table CC-3 Site Design, 6. Planting, Landscaping Standards Permitted. Demonstrate how loading areas at the east side of the building that are along the Supporting Street are screened to the High Screen or High Wall Standard. Staff notes that both standards include landscaping trees and groundcover as part of the required materials (see Section 4.176 (.02) F. and G.).

Response: *The revised Landscape Plan addresses the screening provision as much as possible; however, the proposed development does not incorporate High Screen landscaping, because visual separation is not required between uses and developments. This is accomplished through distance from potential development north of the Supporting Street and the other landscaping provided that meets the standards of this code.*

- f. Table CC-4 Building Design, 3. Overall Building Massing, Base, Body, and Top Dimensions; Base Design; Top Design. Demonstrate how a clearly demarcated base and top that meets the standards are provided on the west and north elevations of the entry/showroom portion of the building. Clarify whether the roof is considered the top along the north elevation of the building and explain how it meets the standard.

Response: The revised development proposal demarcates base, middle, and top of the building’s massing and material. Along the Supporting Street, the roof meets all criteria of Table CC-4, Building Design, Top Design. The roofing panel is a different color and change in texture and rib pattern than the wall panel which satisfies portions of top design. The roof creates a change in surface position as it slopes back away from the plane of the wall, by at least 1½”, which satisfies the portions of the top design.

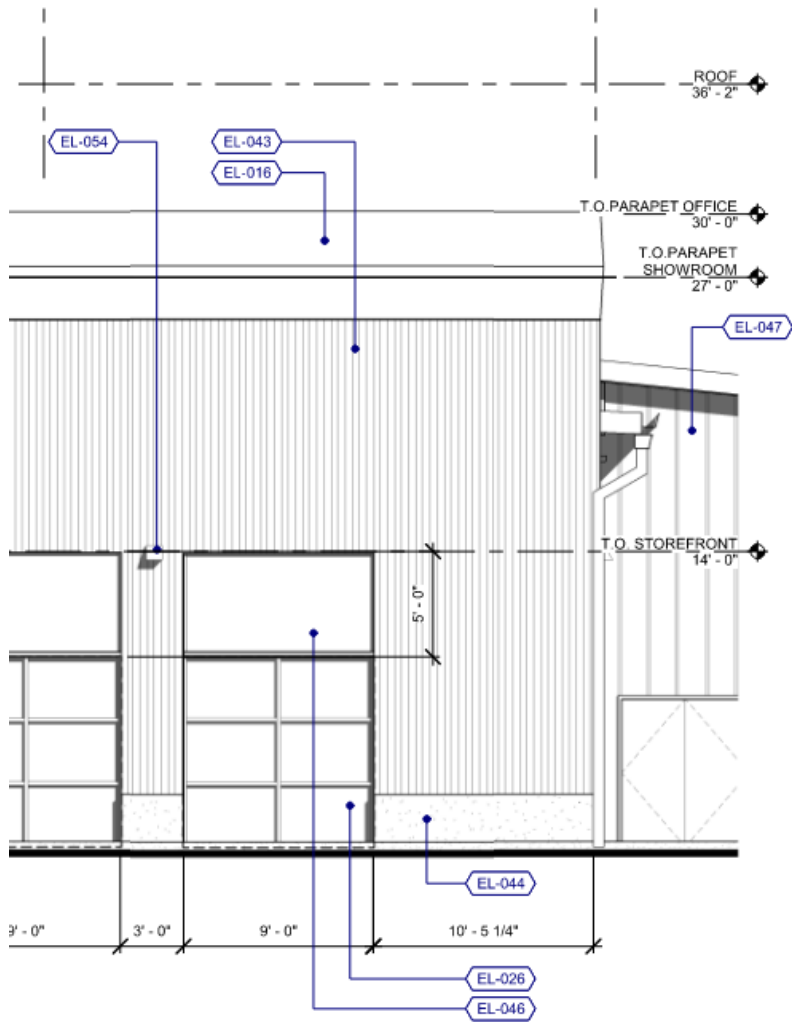

- g. Waysides: Provide cut sheet/detail of the proposed trash receptacle; staff notes that keynote SP-058 on Sheet A1.1 directs to Detail 8/A1.3, however the detail isn't included on the plan sheet. Explain how the perimeter landscaping on three sides of the wayside meets the Low Screen, Low Berm, or High Screen Landscaping standard (Section 4.176 (.02) D., E., or F.) to a depth of 20 feet, minimum.

Response: The following cut sheets has been added to 8/A1.3 for the trash receptacle. The proposed development revisions

incorporate landscaping that now meet the 'low screen' standard along street lot lines for Garden Acres Road and Java Road, including additional dimension and landscaping on either side of the sidewalk along the Supporting Street. Per our conversation, the sidewalk along the Supporting Street has now been located to allow more landscape features on either side of the pedestrian pathway; the landscaping will soften the impact of the development upon entry and from neighboring developments. In addition, low screen is implemented between each of the two parking areas and Java Road. The landscape plan also uses low shrubs to help screen portion of the building operations.



D. Request additional waivers, as appropriate, for all proposed deviations from development standards and/or Coffee Creek Industrial DOD standards and adjustment allowances and provide supporting Code response narrative. Staff notes that a waiver has already been requested for driveway width on the Supporting Street.

Response: *There are no additional requests for waivers.*

E. Correct inconsistencies in the plans with respect to sidewalk placement on the north elevation of the building along the Supporting Street. While the majority of plans show the sidewalk immediately adjacent to the building with no landscape separation, the Fire Service Site Plan (Sheet FS1.0), Lighting Plans (Sheets LT1.0 and LT1.2), and Recycling Flow &

Details (Sheet G3.0) all show a landscape area between the building and sidewalk.

Response: *The Sheets FS1.0, LT1.0, LT1.2, G3.0 have been updated and are consistent with respects to all design elements, including sidewalk placement, setbacks, building floor plan, dimensions, access, etc.*

- F. Staff notes there are two person doors on the north elevation of the building that open onto the sidewalk immediately adjacent, which leaves only 2.5 feet of clearance on the sidewalk when the doors are opened. Explain what measures will be taken to ensure that this isn't a safety hazard for people using the sidewalk along the Supporting Street.

Response: *The Reference re-designed frontage along the supporting street, the sidewalk has been pushed 6'-0" away from the building which allow for landscaping along the building and clearance for the doors to open.*

Engineering and Natural Resources Comments

- G. Demonstrate how the sidewalk along the Supporting Street is separated from the building in accordance with Figure CC-2 (Section 4.134(.10)). Demonstrate how required street trees are provided on the Supporting Street. Consider using narrower stormwater planters in lieu of proposed rain gardens along the Supporting Street as they allow the sidewalk to be separated from the building with landscaping. Extend the sidewalk to the east boundary of the developed area of the site in addition to extending it to the parking area as shown on the plans.

Response: The proposed development has been revised to address Figure CC-2, Section 4.134 through reconfiguring the stormwater planters in lieu of rain gardens. This approach allows for more dimension for street trees and separated sidewalk along the Supporting Street.

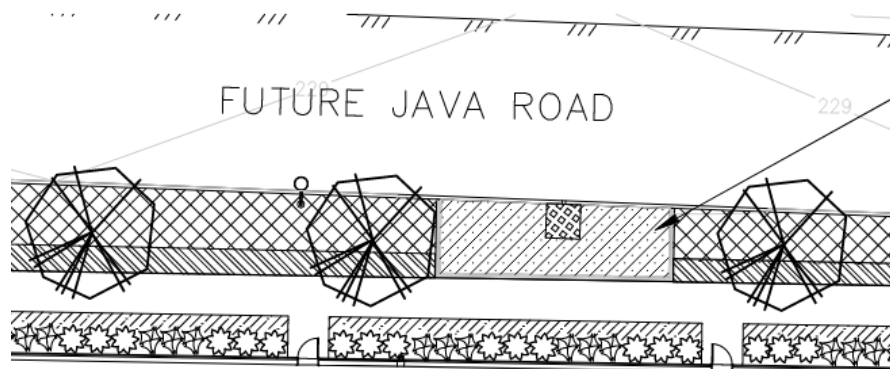

- H. Demonstrate how the water system is looped to the extent feasible. Staff notes that there are existing stubs to the south and north of the property that should be used to serve this property. Demonstrate how the

property is served by separate irrigation, domestic, and fire suppression lines.

Response: *Additional public water main has been added south of the building and connected to system in supporting street, creating the requested loop. One of the existing stubs is north of the north property boundary and on an adjacent parcel and consequently not available to this development, therefore, the previously shown new connection to the existing water main in Garden Acres Road remains shown on the plans. Plans continue to show separate fire and domestic service connections to the new public water main in the supporting street. An irrigation service and meter have been added, also connected to the proposed new public water main in the supporting street.*

- I. Demonstrate how loading dock areas, which staff notes are shown as hydraulically isolated with a catch basin connected to sewer, will be covered in accordance with the Source Control section of the Public Works Standards to prevent stormwater from entering the sewer system. All storm facilities must be a minimum of 10 feet from foundations of the building. All stormwater facilities should have a high flow overflow in addition to perf pipe connection to the storm system. Explain how all-weather access, at a minimum to within 10 feet of inlet and outlet structures, will be provided for maintenance of the stormwater facility at the southwest corner of the project.

Response: *Architectural plans show canopies over the area of the docks. The surface of the dock paving will continue to be shown to drain to the previously shown isolation areas. All storm treatment and flow control facilities are a minimum of 10 ft, from the building. Plans continue to show the City of Wilsonville drawings ST 6005, 6020, and 6120, which show the planter and rain garden overflow outlet structures, with high flow outlets. The plans also continue to show curb outlets for secondary overflow along the curb of the supporting street or parking area (planters and NW rain garden) or overland (west rain garden). Secondary overflow is ultimately overland, following historic flow paths, generally southwest to Garden Acres Road. Plans show a graveled access to the west rain garden. This alignment and proximity to the rain garden has been reviewed and approved by staff. Gravel paving design has been provided by the project geotechnical engineer, demonstrating the gravel surfacing will provide all weather access for a 30-ton maintenance vehicle.*

Building Comments

- J. Correct inconsistencies in the plans with respect to location of hydrants and FDC as shown on the Grading Plan (Sheet C2.0) and Fire Service Site Plan (Sheet FS1.0)

Response: *Please see revised C2.0 and FS1.0 that reflect the proposed locations of hydrants and the FDC.*



APPLICANT REQUEST FOR WAIVER OF 120-DAY RULE (ORS 227.178(5))

Precision Countertops

Project Name, Description

Robert Hausserman

Applicant's Name

DB22-0011

City of Wilsonville File Number

I have a pending land use application with the City for the file number identified above. I request a waiver of the 120-day rule to allow additional time for the City to process my land use application, as allowed by ORS 227.178. As a result, I am giving the City the period of time through and including the date of May 3rd, 2023¹ to make a final decision on my land use application. Unless, an additional waiver is given by me, I understand the City will make a final decision on my land use application on or before the date specified in this letter.

Robert Hausserman

Applicant's Signature

February 9th, 2023

Date



City of Wilsonville
Exhibit B5 DB22-0011

¹ In no event may the total amount of time, including all extensions, exceed 365 days from the date the application is deemed complete. Example: an application deemed complete on March 1, 2020, cannot be extended beyond March 1, 2021, and the City must make a final decision on or before March 1, 2021.

Project Memorandum

412 NW Couch St. #405
Portland, Oregon 97209
t: 503-764-9692
www.firstfortyfeet.com

City of Wilsonville, Oregon

Development Review Application –Comment Response to City Comments and Corrections

Precision Countertop Building
Site Design and Architectural Design
Application Numbers: DB22-0011 Precision Countertops

Proposal:

Annexation (ANNX22-0004), Zone Map Amendment (ZONE22-0005), Stage 1 Master Plan (STG122-0006), Stage 2 Final Plan (STG222-0007), Site Design Review (SDR22-0007), Waiver (WAIV22-0003), Type C Tree Plan (TPLN22-0006), Class 3 Sign Plan (SIGN22-0011)

Location/Legal:

25540 SW Garden Acres Road. Tax Lot 500, Section 2C, Township 3 South, Range 1 West, Willamette Meridian, Washington County, Oregon.

This memorandum addresses comments and corrections related to compliance to be addressed in the final review of the proposed development:

Planning Comments & Questions

- A. Are the proposed lighting specifications developed under a ‘prescriptive’ or ‘performance’ criteria?

Response: *The proposed lighting specifications and design standards have been developed under a prescriptive specifications methodology and criteria, per the municipal code requirements and guidelines.*

- B. Please confirm all trees to be removed along the southern property line.

Response: *The team have updated and confirmed the number of trees slated for removal. All trees on the adjacent property will remain and a select number of trees will be removed per the Arborist recommendations. Please see drawing exhibit –*



Planning
Urban Design
Place Strategy

412 NW Couch St. #405
Portland, Oregon 97209
t: 503-764-9692
www.firstfortyfeet.com

C. *Please include the existing trees from the survey on the final landscape plan to allow the reviewers to understand the context of the tree inventory.*

Response: *The landscape plan (L1.1) has been updated to illustrate the existing trees from the survey and trees to remain.*

D. *Please include the 'drip line' on the tree inventory report.*

Response: *The drip line for each tree to remain has been included in the tree inventory report and exhibits.*

PLANT LIST: GENERAL LANDSCAPING

SYMBOL	#	LATIN/COMMON NAME TREES	SIZE	SPACING	WATER USE
TREES					
	9	ACER RUBRUM 'ARMSTRONG' Armstrong Red Maple	2" cal.	As shown	Moderate
	3	CHAMAECYPARIS NOOT 'GLAUCA PENDULA' Blue Weeping Alaskan Cedar	8' ht.	As shown	Low
	8	CORNUS 'EDDIE'S WHITE WONDER' Eddies White Wonder Dogwood	1-1/2" cal.	As shown	Moderate
	12	NYSSA SYLVATICA Black Tupelo	1-1/2" cal.	As shown	Moderate
	9	PRUNUS SERRULATA 'MOUNT FUJI' Mount Fuji Flowering Cherry	1-1/2" cal.	As shown	Moderate
	6	ZELKOVA SERRATA 'GREEN VASE' Green Vase Zelkova	2" cal.	As shown	Low

PLANT LIST: GENERAL LANDSCAPING

SYMBOL	#	LATIN/COMMON NAME TREES	SIZE	SPACING	WATER USE
SHRUBS (WITH MIN. 10"-12" SPREAD)					
	28	ABELIA 'LUCKY LOTS' Twist of Lime Abelia	5 gal.	4' o.c.	Low
	44	CISTUS LADANIFER Crimson Spot Rockrose	5 gal.	5' o.c.	Low
	125	MYRICA CALIFORNICA Pacific Wax Myrtle	5 gal.	5' o.c.	Low
	74	NANDINA DOMESTICA 'GULF STREAM' Gulf Stream Nandina	2 gal.	3' o.c.	Low
	71	PIERIS JAPONICA 'CABERNET' Enchanted Forest Pieris	5 gal.	4' o.c.	Low
	42	SPIRAEA X BUM. "GOLDMOUND" Goldmound Spiraea	2 gal.	3' o.c.	Low
	24	TAXUS BACCATA 'STRICTA' Irish Yew	5 gal.	4' o.c.	Low
	64	VIBURNUM DAVIDII David Viburnum	2 gal.	3' o.c.	Moderate
	75	VIBURNUM TINUS 'SPRING BOUQUET' Spring Bouquet Viburnum	5 gal.	4' o.c.	Moderate
GRASSES					
	37	CALAMAGROSTIS 'KARL FOERSTER' Feather Reed Grass	1 gal.	2' o.c.	Low
	20	MISCANTHUS SINENSIS 'YAKUSHIMA' Dwarf Maiden Grass	2 gal.	3' o.c.	Low

PLANT LIST: GENERAL LANDSCAPING

SYMBOL	#	LATIN/COMMON NAME TREES	SIZE	SPACING	WATER USE
GROUNDCOVER					
	561	ARCTOSTAPHYLOS UVA-URSI "MASS." Massachusetts Kinnikinnick	1 gal.	3' o.c.	Low
	320	LIRIOPE MUSCARI Big Blue Lily Turf	1 gal.	2' o.c.	Moderate
	160	LONICERA PILEATA Box Honeysuckle	1 gal.	4' o.c.	Low
	263	MAHONIA REPENS Creeping Oregon Grape	1 gal.	30" o.c.	Low
	119	ROSA 'FLOWER CARPET AMBER' Flower Carpet Amber Rose	2 gal.	3' o.c.	Moderate
OTHER					
		FINE LAWN SEED MIX See Specifications			Moderate
		STORMWATER FACILITY PLANTING Per City of Wilsonville Standards			Moderate



PROPOSED BENCHES

MANUFACTURER: FORMS + SURFACES
MODEL: 6' HUDSON BENCH, SURFACE MOUNT

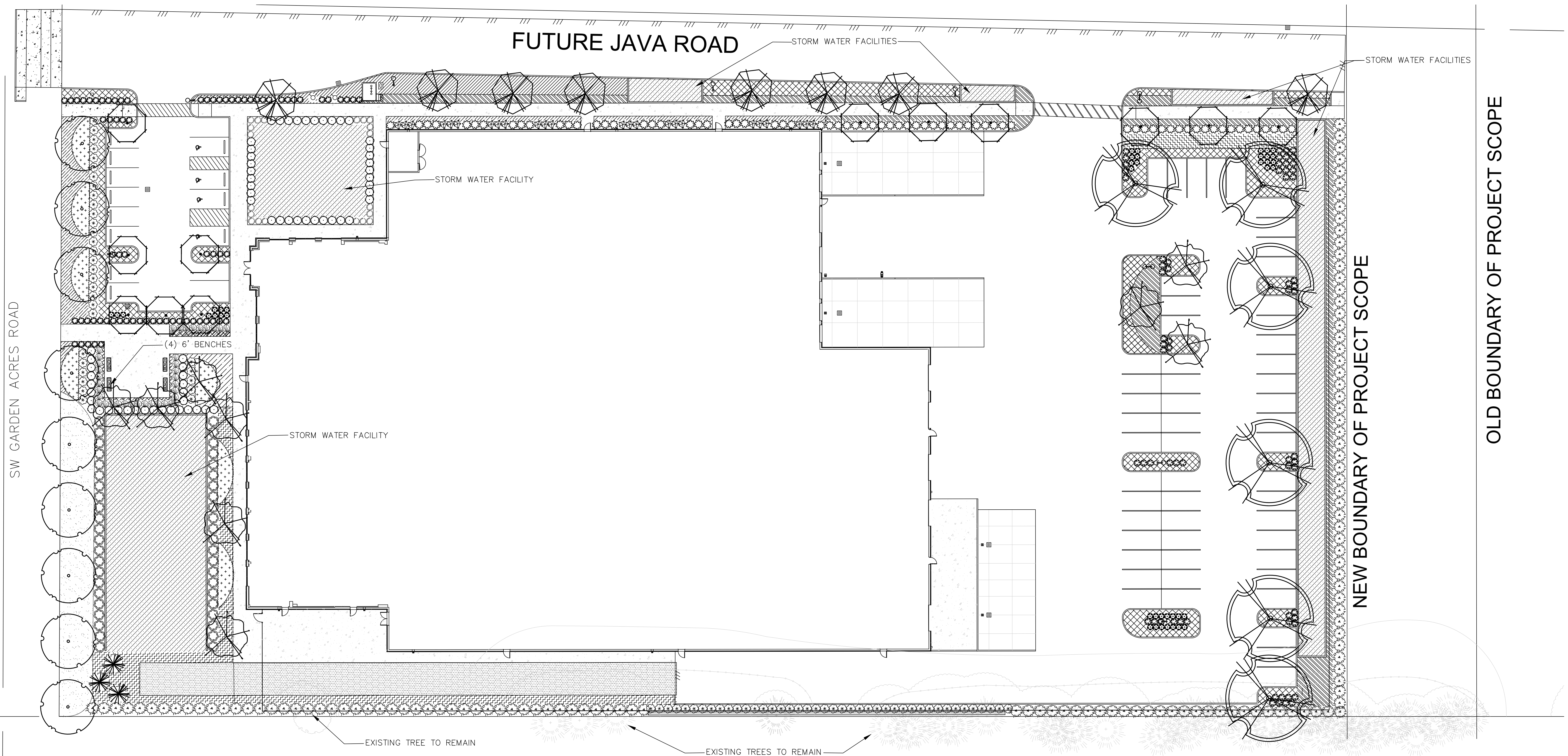

GENERAL NOTES:

- Contractor is to verify all plant quantities.
- Adjust plantings in the field as necessary.
- Project is to be irrigated by an automatic, underground system, which will provide full coverage for all plant material. System is to be design/ build by Landscape Contractor. Guarantee system for a minimum one year. Show drip systems as alternate bid only.
- All plants are to be fully foliated, well branched and true to form.
- Contractor is to notify Landscape Architect or Owner's Representative of any site changes or unforeseen conditions that may be detrimental to plant health, or cause future problems to any structural elements of the project.

LANDSCAPE PLAN

SCALE 1" = 20'-0"

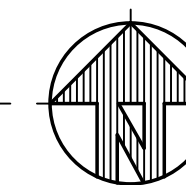

DESIGN REVIEW SET 03/20/2023

MDG

ARCHITECTURE | INTERIORS
4875 SW Griffin Drive Suite 300
Beaverton, OR, 97005
(503) 244-0552

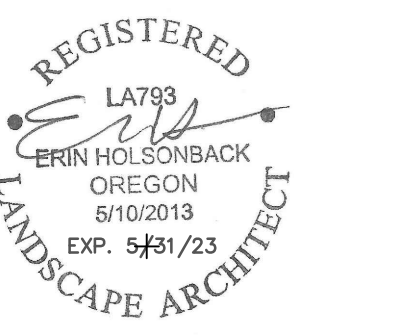

OITEN + ASSOCIATES
LANDSCAPE ARCHITECTURE
3933 South Kelly Avenue, Suite B
Portland, OR, 97239
(503) 972-0311
www.oitena.com

Client/ Owner:

Project:
**PRECISION
COUNTERTOP**

25540 SW Garden Acres
Road
Wilsonville OR 97140

Sheet Title:
**LANDSCAPE
PLAN**

Revisions:

#	Description	Date

MDG, P.C. 2022. ALL RIGHTS RESERVED ©

THESE DRAWINGS ARE THE PROPERTY OF MDG, P.C. AND ARE NOT TO BE USED OR REPRODUCED IN ANY MANNER, EXCEPT WITH THE PRIOR WRITTEN PERMISSION OF MDG, P.C.

Date: 04/03/2023

Job Number: 121036

Sheet

L1.0

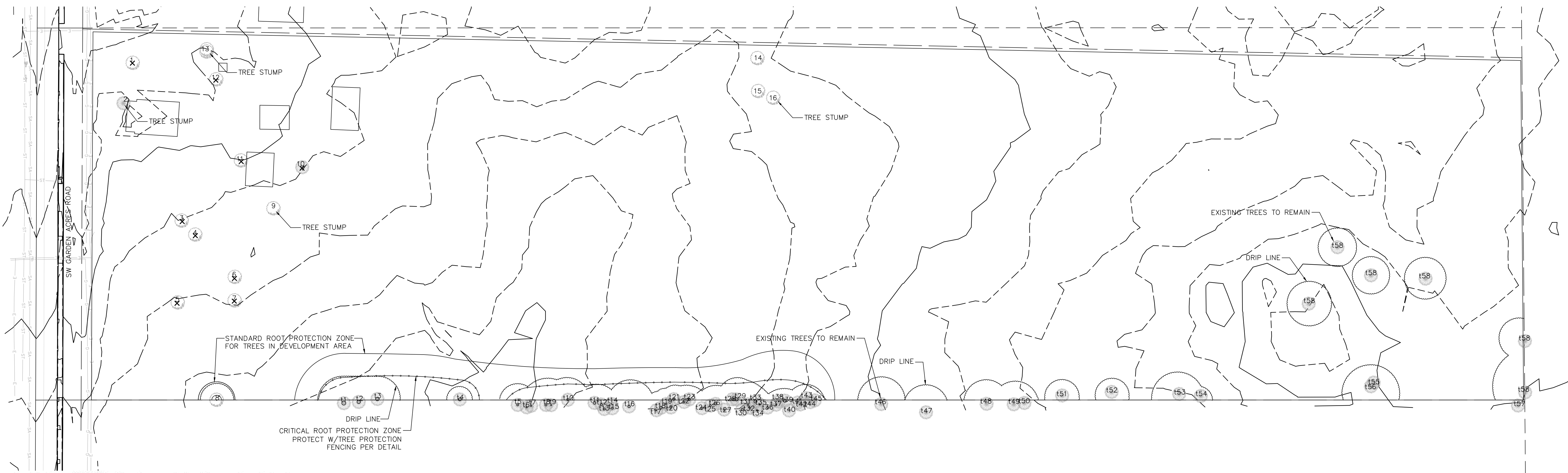

TREE REMOVAL AND PROTECTION PLAN

X TREES TO BE REMOVED

SCALE 1" = 40'-0"

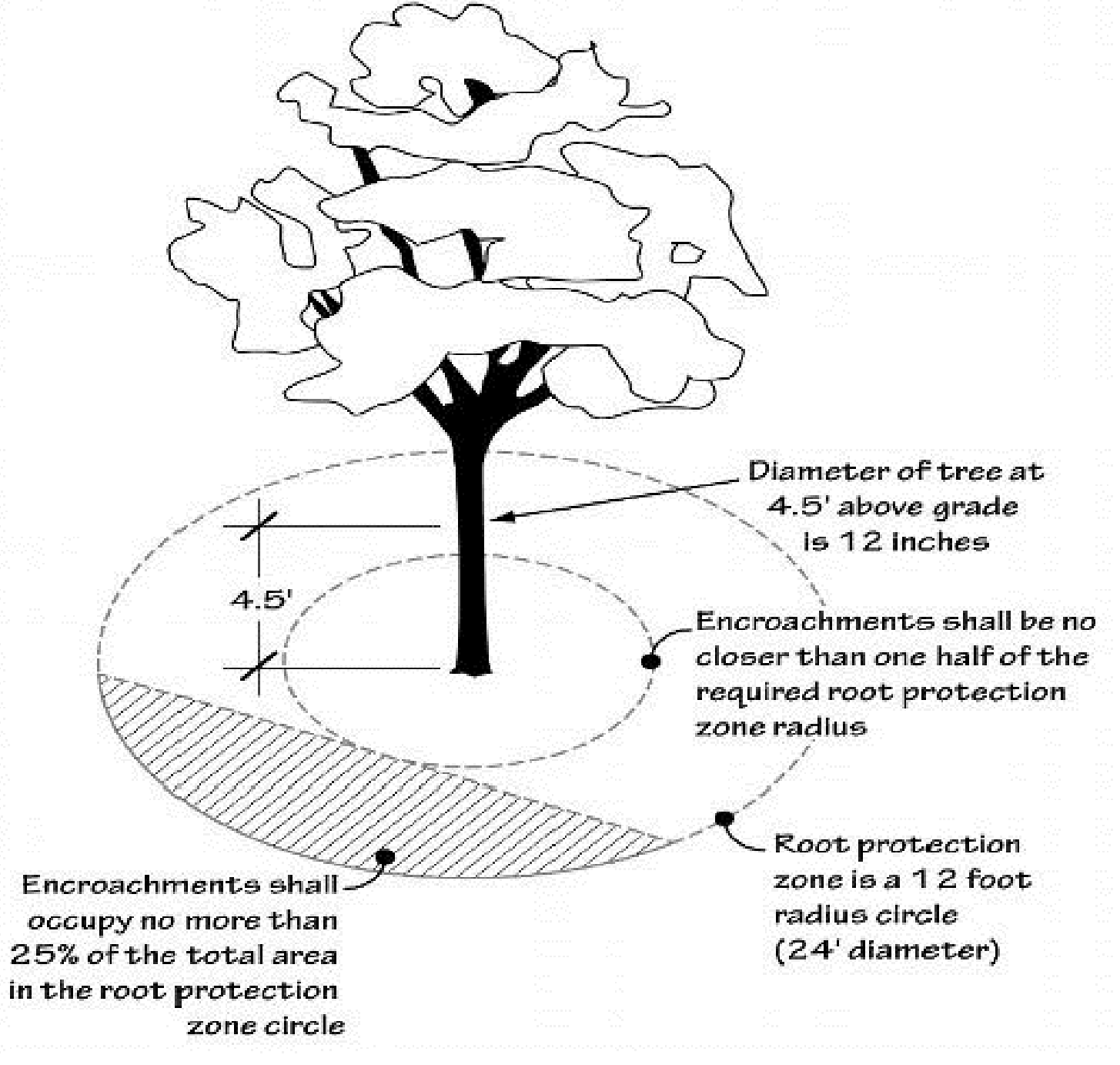
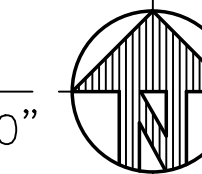

TREE ROOT ZONE DETAIL

N.T.S.

- NOTES:**
- ALL EXISTING TREES DESIGNATED TO BE PRESERVED SHALL BE PROTECTED BY FENCING, AS ILLUSTRATED.
 - INSTALL TREE PROTECTION FENCE AT TREE DRIP LINE OR AT EDGE OF DISTURBED AREA, AS SHOWN ON PLANS, OR PER ARBORIST DIRECTION.
 - AVOID DAMAGE TO CRITICAL ROOT ZONE. DO NOT DAMAGE OR SEVER LARGE ROOTS WHEN INSTALLING POSTS.
 - THERE SHALL BE NO CONSTRUCTION ACTIVITY OR STORAGE OF MATERIAL WITHIN THE BOUNDARIES OF THE TREE PROTECTION FENCING.
 - TREE PROTECTION FENCING SHALL BE INSTALLED PRIOR TO CONSTRUCTION AND MAINTAINED THROUGHOUT THE DURATION OF THE PROJECT.
 - SIGNAGE DESIGNATING THE TREE PROTECTION ZONE SHALL BE SECURED IN A PROMINENT LOCATION ON EACH PROTECTION FENCE.
 - PROJECT ARBORIST TO BE ON SITE WHEN DIGGING OCCURS WITHIN STANDARD ROOT ZONE SOUTH GRAVEL ROAD AND PARKING LOT.
 - SEE ARBORIST REPORT FOR FURTHER TREE PROTECTION SPECIFICATIONS.
 - ALL ATTEMPTS WILL BE MADE TO PRESERVE EXISTING TREES. ANY TREE NEGATIVELY IMPACTED BY DEVELOPMENT WILL BE MITIGATED.

Tree Inventory - 25540 SW Garden Acres Rd, Sherwood, OR 97140
Conducted on 9/21/2021

Tree No.	Common Name	Botanical Name	DBH* (in)	Crown Radius (ft)	Health**	Structural Condition**	Comments
1	bigleaf maple	<i>Acer macrophyllum</i>	32	25	Good	Good	
2	incense cedar	<i>Calocedrus decurrens</i>	32	0	Dead	Dead	
3	apple	<i>Malus domestica</i>	12	12	Fair	Fair	Thin, deadwood.
4	apple	<i>Malus domestica</i>	26	20	Poor	Poor	Diameter measured at 2.5', codominant leaders at 4', deadwood, thin.
5	English walnut	<i>Juglans regia</i>	15	20	Good	Fair	Diameter measured at 2.75', multiple leaders at 4', grafted.
6	plum	<i>Prunus sp.</i>	13	12	Fair	Poor	Codominant leaders 8.8; split trunk, decay, broken branches.
7	plum	<i>Prunus sp.</i>	15	15	Good	Poor	Codominant leaders: 11.9, 6; stem decay, broken branches, wounds.
8	Norway maple	<i>Acer platanoides</i>	7	5	Fair	Fair	Blackened bark, heavy sapsucker holes, deadwood.
9	onesced hawthorn	<i>Crataegus monogyna</i>	15	10	Good	Poor	Diameter at ground level, multiple leaders 2.3" in diameter at 1' above ground level.
10	western redcedar	<i>Thuja plicata</i>	36	20	Poor	Very poor	Codominant leaders at 15'; dead top, broken top, thin.
11	Douglas fir	<i>Pseudotsuga menziesii</i>	49	28	Good	Fair	Large 3x1' mechanical damage on west side of trunk.
12	spruce	<i>Picea pungens</i>	17	12	Good	Good	
13	cherry	<i>Prunus sp.</i>	23	8	Poor	Poor	Codominant leaders: 18.15; twist trunk, dead top.
14	Douglas fir	<i>Pseudotsuga menziesii</i>	46	0	Dead	Dead	
15	Douglas fir	<i>Pseudotsuga menziesii</i>	49	0	Dead	Dead	
16	Douglas fir	<i>Pseudotsuga menziesii</i>	44	0	Dead	Dead	
17	Douglas fir	<i>Pseudotsuga menziesii</i>	38	18	Good	Fair	Sweeping trunk, lost and regrow top.
18	Douglas fir	<i>Pseudotsuga menziesii</i>	36	18	Good	Good	
19	Douglas fir	<i>Pseudotsuga menziesii</i>	38	20	Good	Good	
20	Douglas fir	<i>Pseudotsuga menziesii</i>	39	20	Good	Good	
21	Douglas fir	<i>Pseudotsuga menziesii</i>	36	22	Good	Fair	Unbalanced to the west.
22	Douglas fir	<i>Pseudotsuga menziesii</i>	37	20	Good	Fair	Unbalanced to the west.

*DBH (Diameter at Breast Height): The trunk diameter measured at industry standard, 4.5 feet above ground.
**Health and Structural Condition ratings range from Good, Fair, Poor, Very Poor, to Dead.

Survey Number	Common and Scientific Name	DBH	Condition Health	Condition Structure	Field Notes/ Comments
t 1	Pinus palustris	42	Good	Good	
t 2	Pinus palustris	36	Good	Good	
t 3	Pinus palustris	38	Good	Good	low canopy
t 4	Pinus palustris	32	Good	Good	
t 5	Pinus palustris	20	Good	Good	
t 6	Pinus palustris	13	Good	Good	
t 7	Pinus palustris	13	Good	Good	
t 8	Pinus palustris	22	Good	Good	
t 9	Douglas-fir (Pseudotsuga menziesii)	10	Good	Good	
t 10	Douglas-fir (Pseudotsuga menziesii)	25	Good	Good	
t 11	Douglas-fir (Pseudotsuga menziesii)	29	Fair	Fair	
t 12	Douglas-fir (Pseudotsuga menziesii)	24	Fair	Poor	
t 13	Douglas-fir (Pseudotsuga menziesii)	21	Fair	Poor	
t 14	madrone (Arbutus menziesii)	8	Fair	Poor	
t 15	Douglas-fir (Pseudotsuga menziesii)	21	Fair	Poor	
t 16	Douglas-fir (Pseudotsuga menziesii)	27	Fair	Poor	
t 17	Douglas-fir (Pseudotsuga menziesii)	12	Fair	Poor	heavy lean
t 18	Douglas-fir (Pseudotsuga menziesii)	27	Fair	Poor	
t 19	Douglas-fir (Pseudotsuga menziesii)	16	Fair	Fair	
t 20	grand-fir (Abies grandis)	19	Fair	Fair	
t 21	grand-fir (Abies grandis)	27	Fair	Fair	
t 22	Douglas-fir (Pseudotsuga menziesii)	11	Fair	Fair	
t 23	Douglas-fir (Pseudotsuga menziesii)	24	Fair	Fair	
t 24	grand-fir (Abies grandis)	22	Fair	Fair	poison oak
t 25	grand-fir (Abies grandis)	20	Fair	Fair	
t 26	grand-fir (Abies grandis)	23	Fair	Fair	
t 27	madrone (Arbutus menziesii)	14	Fair	Poor	
t 28	grand-fir (Abies grandis)	26	Fair	Fair	
t 29	grand-fir (Abies grandis)	17	Fair	Fair	
t 30	grand-fir (Abies grandis)	23	Fair	Fair	
t 31	grand-fir (Abies grandis)	16	Fair	Fair	
t 32	Douglas-fir (Pseudotsuga menziesii)	16	Fair	Fair	
t 33	Douglas-fir (Pseudotsuga menziesii)	31	Fair	Fair	
t 34	grand-fir (Abies grandis)	16	Fair	Fair	
t 35	grand-fir (Abies grandis)	16	Dead/Dying	Failed/Failing	
t 36	grand-fir (Abies grandis)	18	Fair	Fair	
t 37	grand-fir (Abies grandis)	10	Fair	Failed/Failing	broken top
t 38	Douglas-fir (Pseudotsuga menziesii)	8	Fair	Failed/Failing	broken top
t 39	giant-sequoia (Sequoiadendron giganteum)	34	Good	Good	
t 40	grand-fir (Abies grandis)	18	Fair	Poor	heavy lean
t 41	grand-fir (Abies grandis)	16	Good	Good	
t 42	grand-fir (Abies grandis)	16	Good	Good	
t 43	grand-fir (Abies grandis)	24	Good	Good	
t 44	grand-fir (Abies grandis)	17	Fair	Fair	
t 45	red pine (Pinus resinosa)	20	Poor	Poor	
t 46	grand-fir (Abies grandis)	29	Fair	Fair	
t 47	Douglas-fir (Pseudotsuga menziesii)	40	Fair	Fair	
t 48	Douglas-fir (Pseudotsuga menziesii)	36	Fair	Fair	
t 49	Douglas-fir (Pseudotsuga menziesii)	36	Fair	Fair	
t 50	Douglas-fir (Pseudotsuga menziesii)	24	Fair	Fair	
t 51	Douglas-fir (Pseudotsuga menziesii)	36	Fair	Fair	
t 52	Douglas-fir (Pseudotsuga menziesii)	28	Fair	Fair	
t 53	Douglas-fir (Pseudotsuga menziesii)	18	Fair	Fair	
t 54	Douglas-fir (Pseudotsuga menziesii)	42	Fair	Fair	
t 55	Douglas-fir (Pseudotsuga menziesii)	24	Fair	Fair	
t 56	Douglas-fir (Pseudotsuga menziesii)	46	Fair	Fair	
t 57	Douglas-fir (Pseudotsuga menziesii)	34	Fair	Fair	
t 58	Douglas-fir (Pseudotsuga menziesii)	40	Fair	Fair	
t 59	Douglas-fir (Pseudotsuga menziesii)	40	Fair	Fair	
t 60	Douglas-fir (Pseudotsuga menziesii)	38	Fair	Fair	
t 61	Douglas-fir (Pseudotsuga menziesii)	38	Fair	Fair	
t 62	Douglas-fir (Pseudotsuga menziesii)	38	Fair	Fair	
t 63	Douglas-fir (Pseudotsuga menziesii)	38	Fair	Fair	

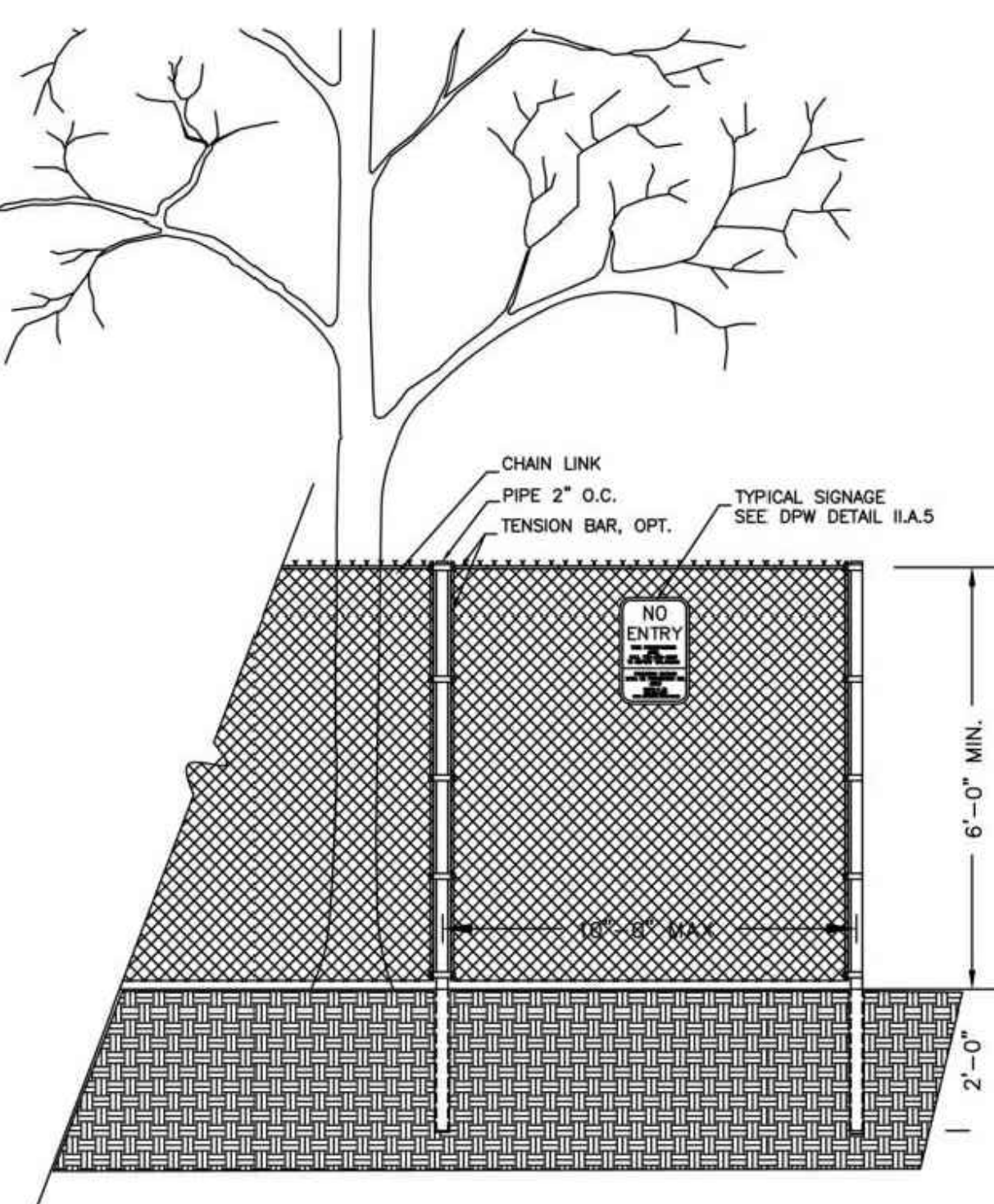

TREE PROTECTION FENCING

N.T.S.

ARBORIST TREE SURVEY

Client/ Owner:

Project:
PRECISION COUNTERTOP

25540 SW Garden Acres Road
Wilsonville OR 97140

Sheet Title:

TREE REMOVAL AND PROTECTION PLAN

Revisions:

#	Description	Date
---	-------------	------

OUTLINE SPECIFICATIONS PLANTING AND SEEDING:

GENERAL: All plants shall conform to all applicable standards of the latest edition of the "American Association of Nurserymen Standards", A.N.S.I. Z60.1 - 1973. Meet or exceed the regulations and laws of Federal, State, and County regulations, regarding the inspection of plant materials, certified as free from hazardous insects, disease, and noxious weeds, and certified fit for sale in Oregon.

The apparent silence of the Specifications and Plans as to any detail, or the apparent omission from them of a detailed description concerning any point, shall be regarded as meaning that only the best general practice is to prevail and that only material and workmanship of first quality are to be used. All interpretations of these Specifications shall be made upon the basis above stated.

Landscape contractor shall perform a site visit prior to bidding to view existing conditions.

PERFORMANCE QUALITY ASSURANCE: Use adequate numbers of skilled workmen who are thoroughly trained and experienced in the necessary horticultural practices and who are completely familiar with the specified requirements and methods needed for the proper performance of the work of this section.

NOTIFICATION: Give Landscape Architect minimum of 2 days advance notice of times for inspections. Inspections at growing site does not preclude Landscape Architect's right of rejection of deficient materials at project site. Each plant failing to meet the above mentioned "Standards" or otherwise failing to meet the specified requirements as set forth shall be rejected and removed immediately from the premises by the Contractor and at his expense, and replaced with satisfactory plants or trees conforming to the specified requirements.

SUBSTITUTIONS: Only as approved by the Landscape Architect or the Owner's Representative.

GUARANTEE AND REPLACEMENT: All plant material shall be guaranteed from final acceptance for one full growing season or one year, whichever is longer. During this period the Contractor shall replace any plant material that is not in good condition and producing new growth (except that material damaged by severe weather conditions, due to Owner's negligence, normally unforeseen peculiarities of the planting site, or lost due to vandalism). Guarantee to replace, at no cost to Owner, unacceptable plant materials with plants of some variety, age, size and quality as plant originally specified. Conditions of guarantee on replacement plant shall be same as for original plant.

Landscape Contractor shall keep on site for Owner's Representative's inspection, all receipts for soil amendment and topsoil deliveries.

PROTECTION Protect existing roads, sidewalks, and curbs, landscaping, and other features remaining as final work. Verify location of underground utilities prior to doing work. Repair and make good any damage to service lines, existing features, etc. caused by landscaping installation.

PLANT QUALITY ASSURANCE: Deliver direct from nursery. Maintain and protect roots of plant material from drying or other possible injury. Store plants in shade and protect them from weather immediately upon delivery, if not to be planted within four hours.

Nursery stock shall be healthy, well branched and rooted, formed true to variety and species, full foliated, free of disease, injury, defects, insects, weeds, and weed roots. Trees shall have straight trunks, symmetrical tips, and have an intact single leader. Any trees with double leaders will be rejected upon inspection. All Plants: True to name, with one of each bundle or lot tagged with the common and botanical name and size of the plants in accordance with standards of practice of the American Association of Nurserymen, and shall conform to the Standardized Plant Names, 1942 Edition.

Container grown stock: Small container-grown plants, furnished in removable containers, shall be well rooted to ensure healthy growth. **Grow container plants in containers a minimum of one year** prior to delivery, with roots filling container but not root bound. Bare root stock: Roots well-branched and fibrous. Balled and burlapped (B&B): Ball shall be of natural size to ensure healthy growth. Ball shall be firm and the burlap sound. No loose or made ball will be acceptable.

TOPSOIL AND FINAL GRADES: Landscape Contractor is to supply and place 12" of topsoil in planting beds and 6" in lawn areas. Landscape Contractor is to verify with the General Contractor if the on-site topsoil is or is not conducive to proper plant growth. The topsoil shall be a sandy loam, free of all weeds and debris inimical to lawn or plant growth. Furnish soil analysis by a qualified soil testing laboratory stating percentages of organic matter, gradation of sand, silt and clay content; cation exchange capacity; deleterious material; pH; and plant nutrient content of the topsoil. Report suitability of topsoil for plant growth and recommended quantities of nitrogen, phosphorus and potash nutrients and soil amendments (including compost) to be added to produce satisfactory topsoil. If stockpiled topsoil on site is not conducive to proper plant growth, the Landscape Contractor shall import the required amount.

Landscaping shall include finished grades and even distribution of topsoil to meet planting requirements. Grades and slopes shall be as indicated. Planting bed grades shall be approximately 3" below adjacent walks, paving, finished grade lines, etc., to allow for bark application. Finish grading shall remove all depressions or low areas to provide positive drainage throughout the area.

PLANTING SPECIFICATIONS:

HERBICIDES: Prior to soil preparation, all areas showing any undesirable weed or grass growth shall be treated with Round-up in strict accordance with the manufacturer's instructions.

SOIL PREPARATION: Work all areas by rototilling to a minimum depth of 8". Remove all stones (over 1 1/2" size), sticks, mortar, large clumps of vegetation, roots, debris, or extraneous matter turned up in working. Soil shall be of a homogeneous fine texture. Level, smooth and lightly compact area to plus or minus .10 of required grades.

In groundcover areas add 2" of compost (or as approved) and till in to the top 6" of soil.

PLANTING HOLE: Lay out all plant locations and excavate all soils from planting holes to 2 1/2 times the root ball or root system width. Loosen soil inside bottom of plant hole. Dispose of any "subsoil" or debris from excavation. Check drainage of planting hole with water, and adjust any area showing drainage problems.

SOIL MIX: Prepare soil mix in each planting hole by mixing:
2 part native topsoil (no subsoil)
1 part compost (as approved)

Thoroughly mix in planting hole and add fertilizers at the following rates:

Small shrubs - 1/8 lb./plant
Shrubs - 1/3 to 1/2 lb./plant
Trees - 1/3 to 1 lb./plant

FERTILIZER: For trees and shrubs use Commercial Fertilizer "A" Inorganic (5-4-3) with micro-nutrients and 50% slow releasing nitrogen. For initial application in fine seed lawn areas use Commercial Fertilizer "B" (8-16-8) with micro-nutrients and 50% slow-releasing nitrogen. For lawn maintenance use Commercial Fertilizer "C" (22-16-8) with micro-nutrients and 50% slow-releasing nitrogen. DO NOT apply fertilizer to Water Quality Swale.

PLANTING TREES AND SHRUBS: Plant upright and face to give best appearance or relationship to adjacent plants and structures. Place 6" minimum, lightly compacted layer of prepared planting soil under root system. Loosen and remove twine binding and burlap from top 1/2 of root balls. Cut off cleanly all broken or frayed roots, and spread roots out. Stagger Plants in rows. Backfill planting hole with soil mix while working each layer to eliminate voids.

When approximately 2/3 full, water thoroughly, then allow water to soak away. Place remaining backfill and dish surface around plant to hold water. Final grade should keep root ball slightly above surrounding grade, not to exceed 1". Water again until no more water is absorbed. Initial watering by irrigation system is not allowed.

STAKING OF TREES: Stake or guy all trees. Stakes shall be 2" x 2" (nom.) quality tree stakes with point. They shall be of Douglas Fir, clear and sturdy. Stake to be minimum 2/3 the height of the tree, not to exceed 8'-0". Drive stake firmly 1'-6" below the planting hole. Tree ties for deciduous trees shall be "Chainlock" (or better). For Evergreen trees use "Gro-Strait" Tree Ties (or a reinforced rubber hose and guy wires) with guy wires of a minimum 2 strand twisted 12 ga. wire. Staking and guying shall be loose enough to allow movement of tree while holding tree upright. Tree stakes shall be removed after one year.

MULCHING OF PLANTINGS: Mulch planting areas with dark, aged, medium grind fir or hemlock bark (aged at least 6 months) to a depth of 2" in ground cover areas and 2 1/2" in shrub beds. Apply evenly, not higher than grade of plant as it came from the nursery, and rake to a smooth finish. Water thoroughly, then hose down planting area with fine spray to wash leaves of plants.

FINE LAWN AREAS: In fine lawn area apply Commercial Fertilizer Mix "B" at 4.5 lbs. Per 1,000 sq.ft. and rake into soil surface. Establish an even, fine textured seeded meeting grades, surfaces and texture. Sow seed with a mechanical spreader at the uniform rates as noted below. Rake seed lightly to provide cover.

SEED: Blueoat grass seed conforming to applicable State laws. No noxious weed seeds. Submit Guaranteed analysis.

Fine Lawn Seed Mix: To contain: 50% Top Hat Perennial Ryegrass, 30% Derby Supreme Ryegrass, 20% Longfellow Chewings Fescue (Hobbs and Hopkins Pro-Time 303 Lawn Mix or as approved). Sow Seed at 5 lbs. / 1000 sq. ft.

Rough Seed Mix: To contain: 60% Perennial Ryegrass, 15% Eureka Hard Fescue, and 20% Herbaceous Plants and Clover (Hobbs and Hopkins Pro-Time 705 PDX, or approved equal). Sow at 2 lbs. Per 1,000 sq.ft.

MAINTENANCE OF SEEDED AREAS:

Fine Lawn Areas: The lawn areas shall be maintained by watering, mowing, reseeding, and weeding for a minimum of 60 days after seeding. After 30 days, or after the second mowing, apply Commercial Fertilizer Mix "C" at 5 lbs. per 1,000 sq. ft. Mow and keep at 1 1/2" to 2" in height. Remove clippings and dispose of off site.

GENERAL MAINTENANCE: Protect and maintain work described in these specifications against all defects of materials and workmanship, through final acceptance. Replace plants not in normal healthy condition at the end of this period. Water, weed, cultivate, mulch, reset plants to proper grade or upright position, remove dead wood and do necessary standard maintenance operations. Irrigate when necessary to avoid drying out of plant materials, and to promote healthy growth.

CLEAN-UP: At completion of each division of work all extra material, supplies, equipment, etc., shall be removed from the site. All walks, paving, or other surfaces shall be swept clean, mulch areas shall have debris removed and any soil cleared from surface. All areas of the project shall be kept clean, orderly and complete.

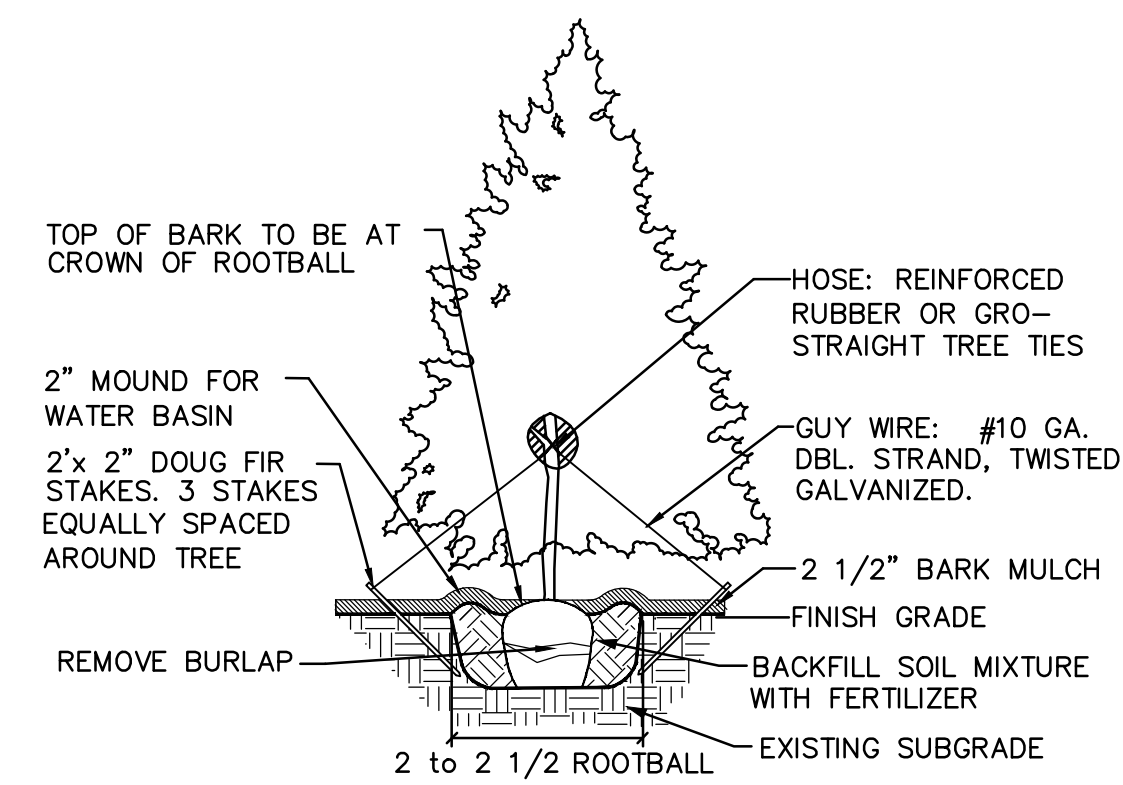

EVERGREEN TREE STAKING DETAIL

NOT TO SCALE

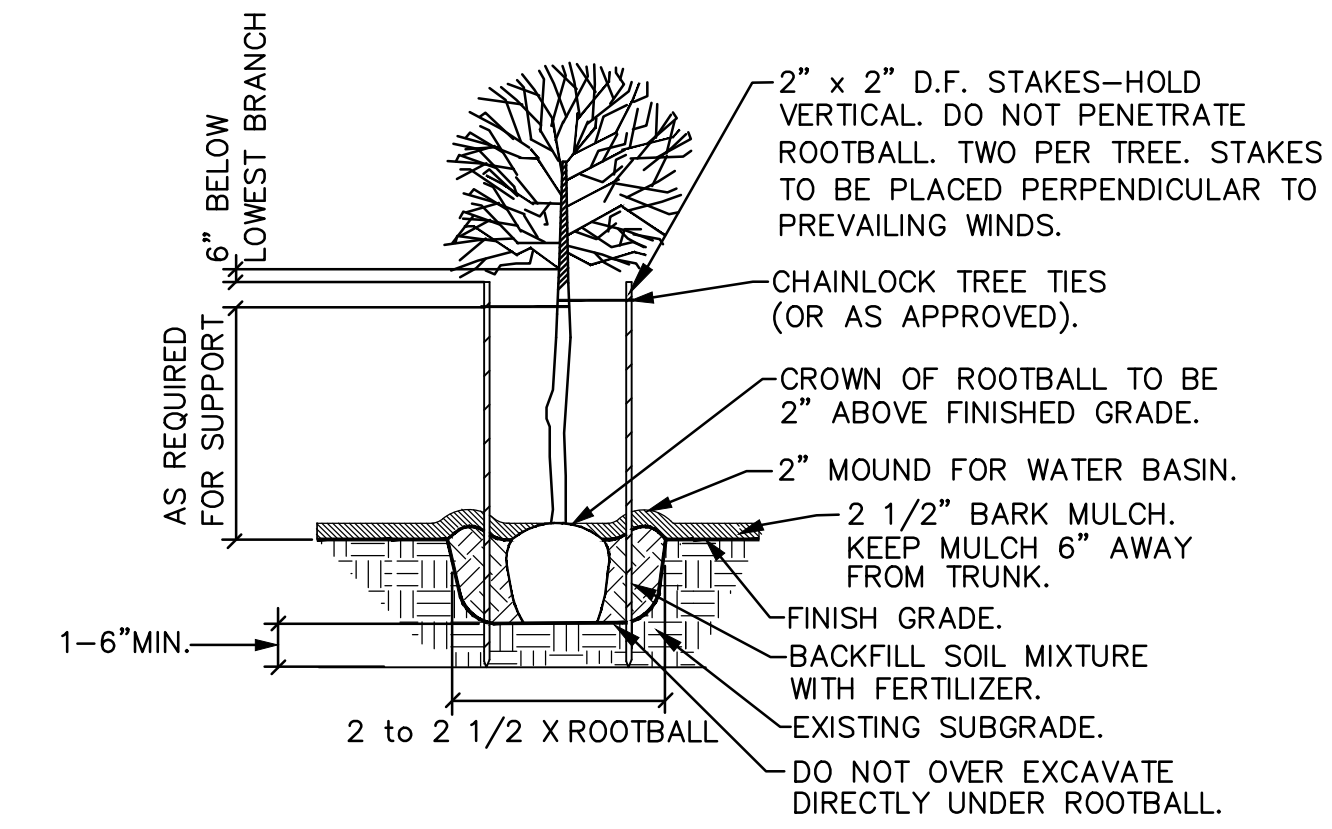

GENERAL DECIDUOUS TREE PLANTING DETAIL

NOT TO SCALE

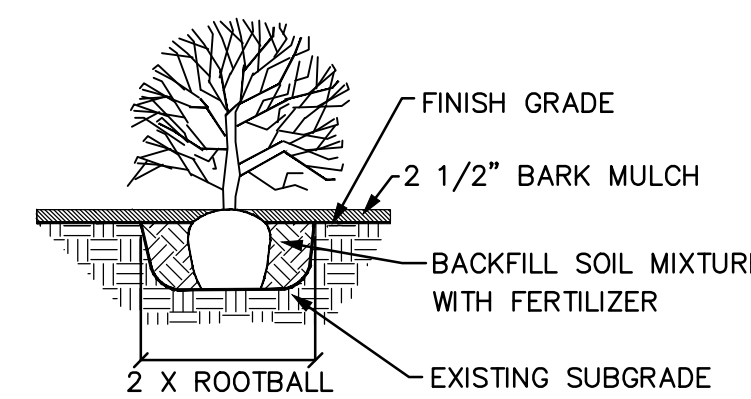

SHRUB PLANTING DETAIL

NOT TO SCALE

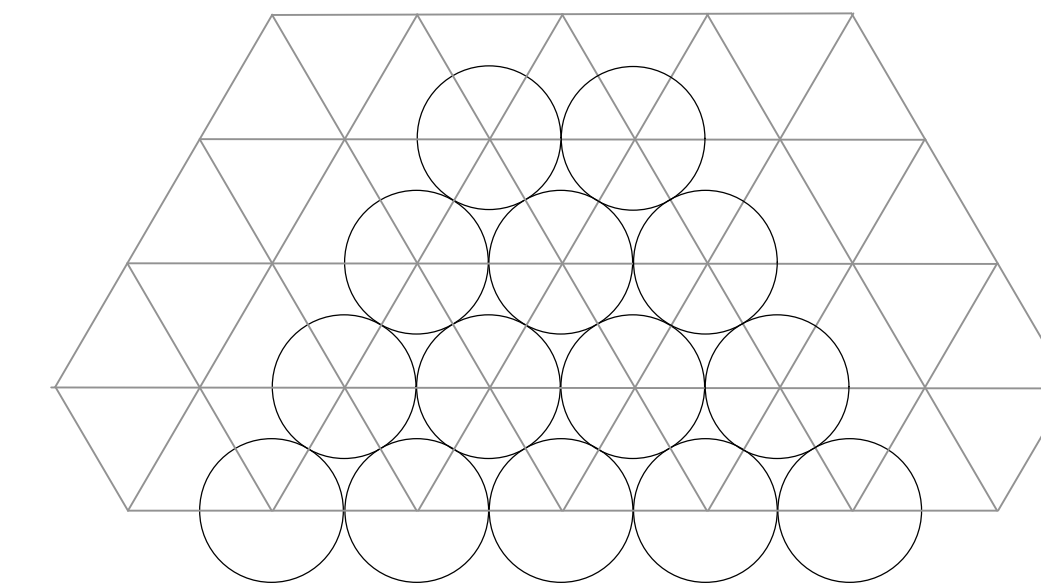

GROUNDCOVER PLANTING DETAIL

NOT TO SCALE

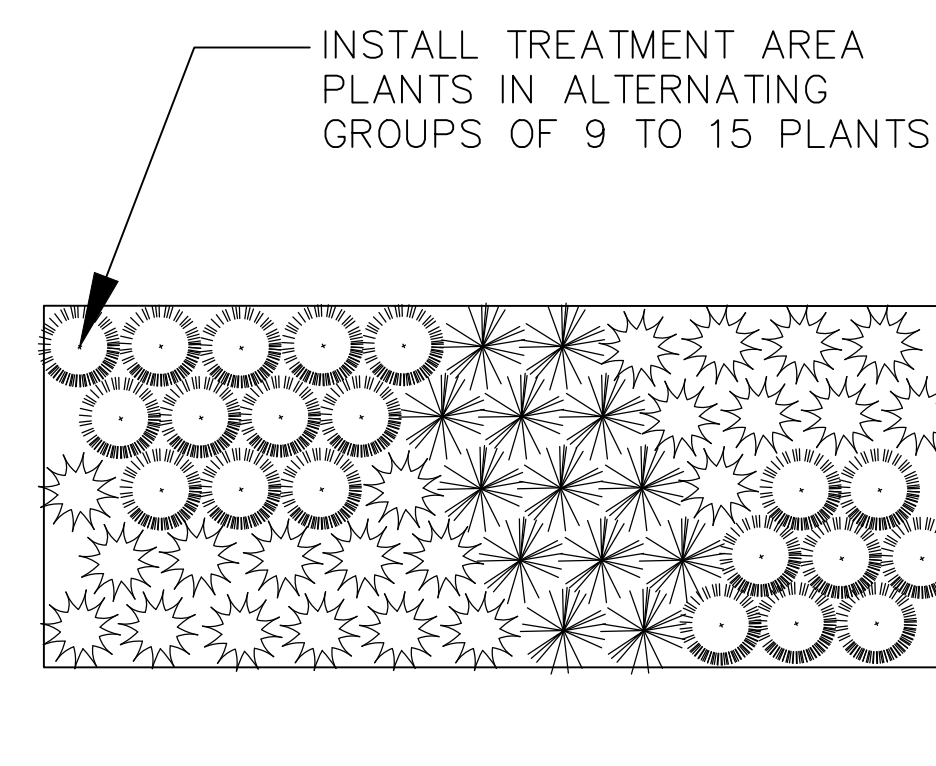

STORMWATER FACILITY PLANTING DETAIL

NOT TO SCALE

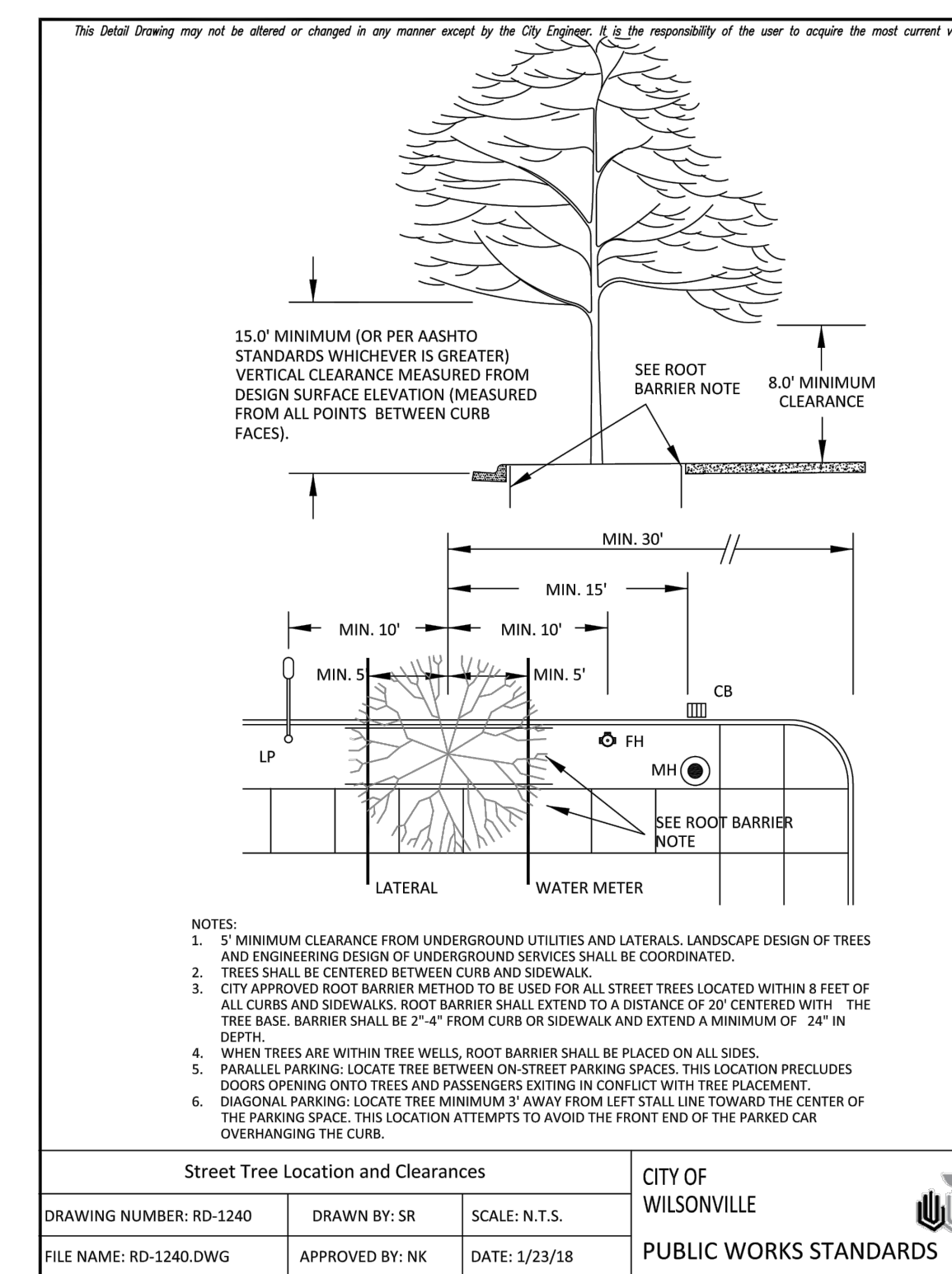

Client/ Owner:

Project:
PRECISION COUNTERTOP

25540 SW Garden Acres Road
Wilsonville OR 97140

Sheet Title:

LANDSCAPE SPECIFICATIONS & DETAILS

Revisions:

#	Description	Date
---	-------------	------

Exhibit C1
Public Works Plan Submittal Requirements
and Other Engineering Requirements

1. All construction or improvements to public works facilities shall be in conformance to the City of Wilsonville Public Works Standards - 2017.
2. Applicant shall submit insurance requirements to the City of Wilsonville in the following amounts:

Coverage (<i>Aggregate, accept where noted</i>)	Limit
<u>Commercial General Liability:</u>	
▪ General Aggregate (per project)	\$3,000,000
▪ General Aggregate (per occurrence)	\$2,000,000
▪ Fire Damage (any one fire)	\$50,000
▪ Medical Expense (any one person)	\$10,000
<u>Business Automobile Liability Insurance:</u>	
▪ Each Occurrence	\$1,000,000
▪ Aggregate	\$2,000,000
<u>Workers Compensation Insurance</u>	\$500,000

3. No construction of, or connection to, any existing or proposed public utility/improvements will be permitted until all plans are approved by Staff, all fees have been paid, all necessary permits, right-of-way and easements have been obtained and Staff is notified a minimum of 24 hours in advance.
4. All public utility/improvement plans submitted for review shall be based upon a 22" x 34" format and shall be prepared in accordance with the City of Wilsonville Public Work's Standards.
5. Plans submitted for review shall meet the following general criteria:
 - a. Utility improvements that shall be maintained by the public and are not contained within a public right-of-way shall be provided a maintenance access acceptable to the City. The public utility improvements shall be centered in a minimum 15-ft. wide public easement for single utilities and a minimum 20-ft wide public easement for two parallel utilities and shall be conveyed to the City on its dedication forms.
 - b. Design of any public utility improvements shall be approved at the time of the issuance of a Public Works Permit. Private utility improvements are subject to review and approval by the City Building Department.
 - c. In the plan set for the PW Permit, existing utilities and features, and proposed new private utilities shall be shown in a lighter, grey print. Proposed public improvements shall be shown in bolder, black print.



- d. All elevations on design plans and record drawings shall be based on NAVD 88 Datum.
 - e. All proposed on and off-site public/private utility improvements shall comply with the State of Oregon and the City of Wilsonville requirements and any other applicable codes.
 - f. Design plans shall identify locations for street lighting, gas service, power lines, telephone poles, cable television, mailboxes and any other public or private utility within the general construction area.
 - g. As per City of Wilsonville Ordinance No. 615, all new gas, telephone, cable, fiber-optic and electric improvements etc. shall be installed underground. Existing overhead utilities shall be undergrounded wherever reasonably possible.
 - h. Any final site landscaping and signing shall not impede any proposed or existing driveway or interior maneuvering sight distance.
 - i. Erosion Control Plan that conforms to City of Wilsonville Ordinance No. 482.
 - j. Existing/proposed right-of-way, easements and adjacent driveways shall be identified.
 - k. All engineering plans shall be printed to PDF, combined to a single file, stamped and digitally signed by a Professional Engineer registered in the State of Oregon.
 - l. All plans submitted for review shall be in sets of a digitally signed PDF and three printed sets.
6. Submit plans in the following general format and order for all public works construction to be maintained by the City:
- a. Cover sheet
 - b. City of Wilsonville construction note sheet
 - c. Land Use Conditions of Approval sheet
 - d. General construction note sheet
 - e. Existing conditions plan.
 - f. Erosion control and tree protection plan.
 - g. Site plan. Include property line boundaries, water quality pond boundaries, sidewalk improvements, right-of-way (existing/proposed), easements (existing/proposed), and sidewalk and road connections to adjoining properties.
 - h. Grading plan, with 1-foot contours.
 - i. Composite utility plan; identify storm, sanitary, and water lines; identify storm and sanitary manholes.
 - j. Detailed plans; show plan view and either profile view or provide i.e.'s at all utility crossings; include laterals in profile view or provide table with i.e.'s at crossings; vertical scale 1"= 5', horizontal scale 1"= 20' or 1"= 30'.
 - k. Street plans.
 - l. Storm sewer/drainage plans; number all lines, manholes, catch basins, and cleanouts for easier reference.
 - m. Stormwater LIDA facilities (Low Impact Development): provide plan and profile views of all LIDA facilities.
 - n. Water and sanitary sewer plans; plan; number all lines, manholes, and cleanouts for easier reference.

- o. Where depth of water mains are designed deeper than the 3-foot minimum (to clear other pipe lines or obstructions), the design engineer shall add the required depth information to the plan sheets.
 - p. Detailed plan for storm water detention facility (both plan and profile views), including water quality orifice diameter and manhole rim elevations. Provide detail of inlet structure and energy dissipation device. Provide details of drain inlets, structures, and piping for outfall structure. Note that although storm water detention facilities are typically privately maintained they will be inspected by engineering, and the plans must be part of the Public Works Permit set.
 - q. Detailed plan for water quality facility (both plan and profile views). Note that although storm water quality facilities are typically privately maintained they will be inspected by Natural Resources, and the plans must be part of the Public Works Permit set.
 - r. Composite franchise utility plan.
 - s. City of Wilsonville detail drawings.
 - t. Illumination plan.
 - u. Striping and signage plan.
 - v. Landscape plan.
7. Design engineer shall coordinate with the City in numbering the sanitary and stormwater sewer systems to reflect the City's numbering system. Video testing and sanitary manhole testing will refer to City's numbering system.
 8. The applicant shall install, operate and maintain adequate erosion control measures in conformance with the standards adopted by the City of Wilsonville Ordinance No. 482 during the construction of any public/private utility and building improvements until such time as approved permanent vegetative materials have been installed.
 9. Applicant shall work with City Engineering before disturbing any soil on the respective site. If 5 or more acres of the site will be disturbed applicant shall obtain a 1200-C permit from the Oregon Department of Environmental Quality. If 1 to less than 5 acres of the site will be disturbed a 1200-CN permit from the City of Wilsonville is required.
 10. The applicant shall be in conformance with all stormwater and flow control requirements for the proposed development per the Public Works Standards.
 11. A storm water analysis prepared by a Professional Engineer registered in the State of Oregon shall be submitted for review and approval by the City.
 12. The applicant shall be in conformance with all water quality requirements for the proposed development per the Public Works Standards. If a mechanical water quality system is used, prior to City acceptance of the project the applicant shall provide a letter from the system manufacturer stating that the system was installed per specifications and is functioning as designed.

13. Storm water quality facilities shall have approved landscape planted and/or some other erosion control method installed and approved by the City of Wilsonville prior to paving.
14. The applicant shall contact the Oregon Water Resources Department and inform them of any existing wells located on the subject site. Any existing well shall be limited to irrigation purposes only. Proper separation, in conformance with applicable State standards, shall be maintained between irrigation systems, public water systems, and public sanitary systems. Should the project abandon any existing wells, they shall be properly abandoned in conformance with State standards.
15. All survey monuments on the subject site, or that may be subject to disturbance within the construction area, or the construction of any off-site improvements shall be adequately referenced and protected prior to commencement of any construction activity. If the survey monuments are disturbed, moved, relocated or destroyed as a result of any construction, the project shall, at its cost, retain the services of a registered professional land surveyor in the State of Oregon to restore the monument to its original condition and file the necessary surveys as required by Oregon State law. A copy of any recorded survey shall be submitted to Staff.
16. Streetlights shall be in compliance with City dark sky, LED, and PGE Option C requirements.
17. Sidewalks, crosswalks and pedestrian linkages in the public right-of-way shall be in compliance with the requirements of the U.S. Access Board.
18. No surcharging of sanitary or storm water manholes is allowed.
19. The project shall connect to an existing manhole or install a manhole at each connection point to the public storm system and sanitary sewer system.
20. A City approved energy dissipation device shall be installed at all proposed storm system outfalls. Storm outfall facilities shall be designed and constructed in conformance with the Public Works Standards.
21. The applicant shall provide a 'stamped' engineering plan and supporting information that shows the proposed street light locations meet the appropriate AASHTO lighting standards for all proposed streets and pedestrian alleyways.
22. All required pavement markings, in conformance with the Transportation Systems Plan and the Bike and Pedestrian Master Plan, shall be completed in conjunction with any conditioned street improvements.
23. Street and traffic signs shall have a hi-intensity prismatic finish meeting ASTM 4956 Spec Type 4 standards.

24. The applicant shall provide adequate sight distance at all project driveways by driveway placement or vegetation control. Specific designs to be submitted and approved by the City Engineer. Coordinate and align proposed driveways with driveways on the opposite side of the proposed project site.
25. The applicant shall provide adequate sight distance at all project street intersections, alley intersections and commercial driveways by properly designing intersection alignments, establishing set-backs, driveway placement and/or vegetation control. Coordinate and align proposed streets, alleys and commercial driveways with existing streets, alleys and commercial driveways located on the opposite side of the proposed project site existing roadways. Specific designs shall be approved by a Professional Engineer registered in the State of Oregon. As part of project acceptance by the City the Applicant shall have the sight distance at all project intersections, alley intersections and commercial driveways verified and approved by a Professional Engineer registered in the State of Oregon, with the approval(s) submitted to the City (on City approved forms).
26. Access requirements, including sight distance, shall conform to the City's Transportation Systems Plan (TSP) or as approved by the City Engineer. Landscaping plantings shall be low enough to provide adequate sight distance at all street intersections and alley/street intersections.
27. Applicant shall design interior streets and alleys to meet specifications of Tualatin Valley Fire & Rescue and Allied Waste Management (United Disposal) for access and use of their vehicles.
28. The applicant shall provide the City with a Stormwater Maintenance and Access Easement Agreement (on City approved forms) for City inspection of those portions of the storm system to be privately maintained. Applicant shall provide City with a map exhibit showing the location of all stormwater facilities which will be maintained by the Applicant or designee. Stormwater or rainwater LID facilities may be located within the public right-of-way upon approval of the City Engineer. Applicant shall maintain all LID storm water components and private conventional storm water facilities; maintenance shall transfer to the respective homeowners association when it is formed.
29. The applicant shall "loop" proposed waterlines by connecting to the existing City waterlines where applicable.
30. Applicant shall provide a minimum 6-foot Public Utility Easement on lot frontages to all public right-of-ways. An 8-foot PUE shall be provided along Collectors. A 10-ft PUE shall be provided along Minor and Major Arterials.
31. For any new public easements created with the project the Applicant shall be required to produce the specific survey exhibits establishing the easement and shall provide the City with the appropriate Easement document (on City approved forms).

32. Mylar Record Drawings:

At the completion of the installation of any required public improvements, and before a 'punch list' inspection is scheduled, the Engineer shall perform a record survey. Said survey shall be the basis for the preparation of 'record drawings' which will serve as the physical record of those changes made to the plans and/or specifications, originally approved by Staff, that occurred during construction. Using the record survey as a guide, the appropriate changes will be made to the construction plans and/or specifications and a complete revised 'set' shall be submitted. The 'set' shall consist of an electronic copy in AutoCAD, current version, and a digitally signed PDF of the drawings.