

Updated 1/11/2019 all previous version of this form are obsolete



29799 SW Town Center Loop E, Wilsonville, OR 97070
 Phone: 503.682.4960 Fax: 503.682.7025
 Web: www.ci.wilsonville.or.us

Planning Division Development Permit Application

Final action on development application or zone change is required within 120 days per ORS 227.175 or as otherwise required by state or federal law for specific application types.

A pre application conference may be required.

The City will not accept applications for wireless communication facilities or similar facilities without a completed copy of a Wireless Facility Review Worksheet.

The City will not schedule incomplete applications for public hearing or send administrative public notice until all of the required materials are submitted.

Applicant:

Name: Seth Henderson
 Company: Level WTC-01 LLC
 Mailing Address: 7327 SW Barnes Rd #523
 City, State, Zip: Portland, OR 97225
 Phone: 503-720-3601 Fax: _____
 E-mail: jjenkins@leveldevnw.com

Authorized Representative:

Name: Chris Hodney
 Company: Hacker Architects
 Mailing Address: 555 SE MLK Blvd #5000
 City, State, Zip: Portland, OR 97214
 Phone: 503-227-1254 Fax: _____
 E-mail: chodney@hackerarchitects.com

Property Owner:

Name: Jonathan G. Dunn
 Company: Doris Marjory Rose Dunn Trust
 Mailing Address: 1578 Haddon Drive
 City, State, Zip: Hoover, AL 35226
 Phone: 205-834-3616 Fax: _____
 E-mail: ibic1111@outlook.com

Property Owner's Signature:

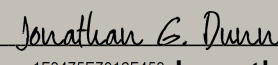
DocuSigned by:

 1F3475E7012F453...
 Printed Name: Jonathan G. Dunn Date: 3/20/2023

Applicant's Signature: (if different from Property Owner)

DocuSigned by:

 247E2F8BD07A408...
 Printed Name: Seth Henderson Date: 3/20/2023

Site Location and Description:

Project Address if Available: 29690 SW Town Center Loop W Suite/Unit _____
 Project Location: Corner of Town Center Loop & Park Place (existing Shari's restaurant)
 Tax Map #(s): T3S 1W 14DD Tax Lot #(s): 411 County: Washington Clackamas

Request:

Staff & DRB approval of new mixed-use development containing apartments & retail. Includes Stage 1, Stage 2, Site Design, Sign Plan, and Type C Tree Removal Review.

Project Type: **Class I** **Class II** **Class III**

Residential Commercial Industrial Other: _____

Application Type(s):

- | | | | |
|--|---|---|---|
| <input type="checkbox"/> Annexation | <input type="checkbox"/> Appeal | <input type="checkbox"/> Comp Plan Map Amend | <input type="checkbox"/> Parks Plan Review |
| <input type="checkbox"/> Final Plat | <input type="checkbox"/> Major Partition | <input type="checkbox"/> Minor Partition | <input type="checkbox"/> Request to Modify Conditions |
| <input type="checkbox"/> Plan Amendment | <input type="checkbox"/> Planned Development | <input type="checkbox"/> Preliminary Plat | <input checked="" type="checkbox"/> Site Design Review |
| <input type="checkbox"/> Request for Special Meeting | <input type="checkbox"/> Request for Time Extension | <input checked="" type="checkbox"/> Signs | <input checked="" type="checkbox"/> Stage II Final Plan |
| <input type="checkbox"/> SROZ/SRIR Review | <input type="checkbox"/> Staff Interpretation | <input checked="" type="checkbox"/> Stage I Master Plan | <input checked="" type="checkbox"/> Variance |
| <input checked="" type="checkbox"/> Type C Tree Removal Plan | <input type="checkbox"/> Tree Permit (B or C) | <input type="checkbox"/> Temporary Use | <input type="checkbox"/> Other (describe) |
| <input type="checkbox"/> Villebois SAP | <input type="checkbox"/> Villebois PDP | <input type="checkbox"/> Villebois FDP | |
| <input type="checkbox"/> Zone Map Amendment | <input type="checkbox"/> Waiver(s) | <input type="checkbox"/> Conditional Use | |





WTC-01 MULTIFAMILY DEVELOPMENT
Land Use Application – DB23-0003
June 23, 2023

Table of Contents

Team Information:	3
Project Narrative and Summary:	4
Background Information:	6
Proof of Ownership:	7
TVFR Permit Reduced Drawings	9
Republic Service Compliance Records:	18
Code Criteria Response Narrative:	22
Anticipated Waivers:	104

Team Information

Applicant:

Level WTC-01 LLC
Seth Henderson
7327 SW Barnes Rd., #523
Portland, OR 97225
503-720-3601

Authorized Representative:

Hacker Architects
Chris Hodney, Design Principal
555 SE MLK Jr Blvd, Suite 501
Portland, OR 97214
503-227-1254

Design Team:

Architect:

Hacker Architects
Chris Hodney, Design Principal
503-227-1254
chodney@hackerarchitects.com

Surveyor:

Lazer Site Surveying, LLC
503-581-6362

Civil Engineer:

Humber Design Group, Inc.
David Humber, PE, Principal
503-946-5370
Dave.humber@hdgpx.com

Landscape Architect:

Ground Workshop
Tommy Solomon, PLA, ASLA, Partner
971-544-7418
ts@groundworkshop.net

Arborist:

Teragan & Associates, Inc.
Peter van Oss, PN-8145A, Senior Associate
503-697-1975

Project Narrative and Summary:

Site Address:	29690 SW Town Center Loop Wilsonville, OR 97070
Taxlot:	T3S 1W 14DD Tax Lot 411
Site Area:	Approx. 1.087 acres, 47,315 sf 0.76 ac., 33,267 sf after dedications
Site Zoning:	TC-MU, Town Center Mixed Use
Proposal:	5 Stories, 92,409 gross square feet
	Multi-unit residential – 114 units
	Commercial – 3,707 sf
	53 on-site vehicle parking stalls
	118 on-site bicycle parking stalls

The proposed development comprises 114 apartments, commercial tenant space, on-site tuck-under and surface parking, and on-site stormwater treatment. The project is in the TC-MU zone, and also includes significant right-of-way dedications and right-of-way improvements per the Wilsonville Town Center Plan.

The building is 60 feet, (5) stories tall and will be constructed as fully-sprinklered (4) stories of Type VA construction over (1) story of Type IA construction. The upper stories of are entirely residential units and common amenity space, while the ground floor includes ground-floor residences and stoops at the northeast frontage, and commercial tenant space at the southeast frontage.

Stormwater treatment of the building and site is proposed within plated stormwater facilities on the property along Town Center Loop. Stormwater treatment is also provided with planted facilities within the right-of-way of the new Local Street at the northeast frontage to capture runoff from the street.

Several easements exist on and surrounding the property and are affected by the project. These are illustrated on exhibit G-102, and proposed vacations and dedications, or easements to be maintained are illustrated on exhibit C-100. A summary for each easement follows :

Easement for the purpose shown below and rights incidental thereto, as granted in a document:

Granted to: The City of Wilsonville

Purpose: Sewer

Affects: A 20 foot wide strip through the Westerly portion

Proposed: Leave as is

Granted to: The City of Wilsonville

Purpose: Underground sanitary sewer, storm drain and water pipe lines

Affects: A 15 foot wide strip through the Southwesterly portion

Proposed: Relocate sections of easement in direct conflict with new permanent structure into public right-of-way (pedestrian or furnishing zone)

Easement for the purpose shown below and rights incidental thereto as delineated or as offered for dedication on recorded PARTITION PLAT NO. 1992-24;

Purpose: Waterline

Affects: A 15 foot wide strip through the Westerly portion

Proposed: Leave as is

*Easement for the purpose shown below and rights incidental thereto, as granted in a document:
Granted to: The City of Wilsonville
Purpose: Underground sanitary sewer, storm drain and water pipe lines
Affects: A 15 foot wide strip through the Northeasterly portion
Proposed: Leave as is*

*Easement for the purpose shown below and rights incidental thereto, as granted in a document:
Granted to: Adjacent property owners
Purpose: Ingress and egress
Affects: The Northeasterly portion
Proposed: Agreement to terminate driveway easement, executed between City of Wilsonville and property owners January 2023*

Proposed dedications are as follows :

*37.0' on northeast side of property (along New Local Street)
15.0' on northwest side of property (Pedestrian Accessway)
6.75' at SW Town Center Loop W
2.17' at Park Place*

The applicant is requesting the following applications:

- Stage 1 Preliminary Plan
- Stage II Final Plan
- Site Design Review
- Master Sign Plan
- Type C Tree Removal Plan

The applicant is requesting waivers to development code as listed and described in the Anticipated Waivers section of this document.

Background Information:

Planning Context:

The proposed development sits at the prominent intersection of Town Center Loop and Park Place Blvd within the Wilsonville Town Center. The project is anticipated to be the first mixed-use development delivered under the vision of the Wilsonville Town Center Plan. Projects within the Town Center zoning are subject to the development criteria of the zone and guidelines found within the Wilsonville Town Center Plan documents. These documents provide background for the intent of the district, as well as guidelines for the building character, orientation, and network of street and pedestrian spaces surrounding the site.

The Town Center Plan describes the vision of this new district as an active and pedestrian-oriented mixed-use district, with a variety of uses and spaces that foster year-round activity. The Mixed-Use (MU) zone in which the site is located is intended to have a mix of residential, retail, office, and services; and have buildings of generally 2 to 4 stories tall. However, allowances for up to 5 stories are allowed in the development code.

The Plan describes significant and exciting right-of-way improvements on both the existing and new roads surrounding the site. An ambitious 'Park Place Promenade' redesign, or infrastructure project IN.10, is illustrated along the southeast-facing frontage of the project. This envisions the current Park Place as a pedestrian-oriented promenade, or 'woonerf' with little or no vehicle traffic. This will make this frontage one of three signature outdoor public spaces in the district.



The proposal seizes an opportunity to shape and activate a key pedestrian intersection at the future Park Place promenade and the new Local Street northeast of the site. The building orientation, design, and programming are intended to anchor this intersection and the promenade frontage with a civic-scale and active ground-floor and allow a transition to urban residential character along the northeast new Local Street. The WTC Plan anticipates the adjacent Town Center Loop will remain primarily vehicle and bicycle oriented, with improvements for pedestrian safety and traffic impacts. The proposed design follows this assumption and locates all parking and services along Town Center Loop to achieve 100% active space frontage along the other two streets.

Proof of Ownership:

See following attachments:

- Property Owner Acknowledgement

DocuSign Envelope ID: 1319938F-248E-4034-9DF5-8CC38E78FF66

	<p>PROPERTY OWNER ACKNOWLEDGEMENT FORM</p>
<p>By signing below, I certify that I am the property owner for the application in question and that the applicant, <u>Level WTC-01 LLC</u>, has my permission to submit this application for the property located at:</p> <p>Site Address: <u>29690 SW Town Center Loop W</u></p> <p>Tax Lot(s): <u>411</u> Section: <u>N/A</u></p> <p>I understand the application will not be deemed complete without this documentation. I understand that submittal of this application does not entitle the applicant to engage in the work applied for until such an application is approved, the plan approval is issued, and the specified appeal period has passed. I also understand that all work must be performed in compliance with all applicable state, federal, and local laws, ordinances and regulations.</p>	
<p>Property Owner's Signature:</p> <p><small>DocuSigned by:</small>  <small>1F3475E7012F453...</small></p> <p>Printed Name: <u>Jonathan G. Dunn</u> Date: <u>3/16/2023</u></p>	
<p>Property Owner Contact Information:</p> <p>Company (if applicable): <u>Doris Marjory Rose Dunn Trust</u></p> <p>Mailing Address: <u>1578 Haddon Drive</u></p> <p>City, State, Zip: <u>Hoover, AL 35226</u></p> <p>Phone: <u>205.834.3616</u> E-mail: <u>lbiC1111@outlook.com</u></p>	

TVFR Permit Reduced Drawings

See following attachments:

- TVFR Permit Application
- Exhibit FS-1 Fire Service Site Plan
- Exhibit FS-2 Exterior Elevations
- Exhibit FS-3 Exterior Elevations
- Flow Testing Memorandum

**FIRE CODE / LAND USE / BUILDING REVIEW
APPLICATION**



North Operating Center
11945 SW 70th Avenue
Tigard, OR 97223
Phone: 503-649-8577

South Operating Center
8445 SW Elligsen Rd
Wilsonville, OR 97070
Phone: 503-649-8577

REV 6-30-20

<p style="text-align: center;">Project Information</p> <p>Applicant Name: <u>WTC-01 LLC – Jennifer Jenkins</u></p> <p>Address: <u>7327 SW Barnes #523 Portland OR 97225</u></p> <p>Phone: <u>503-887-2143</u></p> <p>Email: <u>jjenkins@leveldevnw.com</u></p> <p>Site Address: <u>29690 SW Town Center Loop W</u></p> <p>City: <u>Wilsonville</u></p> <p>Map & Tax Lot #: <u>31W14D00411</u></p> <p>Business Name: <u>N/A</u></p> <p>Land Use/Building Jurisdiction: <u>City of Wilsonville</u></p> <p>Land Use/ Building Permit # <u>Not assigned yet</u></p> <p>Choose from: Beaverton, Tigard, Newberg, Tualatin, North Plains, West Linn, Wilsonville, Sherwood, Rivergrove, Durham, King City, Washington County, Clackamas County, Multnomah County, Yamhill County</p> <p style="text-align: center;">Project Description</p> <p style="text-align: center;">5 STORY MIXED USE RESIDENTIAL BUILDING TOTALING ~100,000 SF WITH 4 STORIES OF TYPE VA CONSTRUCTION OVER 1 STORY OF TYPE IA CONSTRUCTION.</p>	<p style="text-align: center;">Permit/Review Type (check one):</p> <p><input checked="" type="checkbox"/> Land Use / Building Review - Service Provider Permit</p> <p><input type="checkbox"/> Emergency Radio Responder Coverage Install/Test</p> <p><input type="checkbox"/> LPG Tank (Greater than 2,000 gallons)</p> <p><input type="checkbox"/> Flammable or Combustible Liquid Tank Installation (Greater than 1,000 gallons)</p> <p style="margin-left: 20px;">* Exception: Underground Storage Tanks (UST) are deferred to DEQ for regulation.</p> <p><input type="checkbox"/> Explosives Blasting (Blasting plan is required)</p> <p><input type="checkbox"/> Exterior Toxic, Pyrophoric or Corrosive Gas Installation (in excess of 810 cu.ft.)</p> <p><input type="checkbox"/> Tents or Temporary Membrane Structures (in excess of 10,000 square feet)</p> <p><input type="checkbox"/> Temporary Haunted House or similar</p> <p><input type="checkbox"/> OLCC Cannabis Extraction License Review</p> <p><input type="checkbox"/> Ceremonial Fire or Bonfire (For gathering, ceremony or other assembly)</p> <p style="text-align: center;">For Fire Marshal's Office Use Only</p> <p>TVFR Permit # <u>2023-0030</u></p> <p>Permit Type: <u>SPP - Wilsonville</u></p> <p>Submittal Date: <u>3/7/2023</u></p> <p>Assigned To: <u>McGladrey</u></p> <p>Due Date: <u>3/13/2023</u></p> <p>Fees Due: <u>\$37,719 MERRC</u></p> <p>Fees Paid: <u>\$</u></p>
---	--

<p>Approval/Inspection Conditions (For Fire Marshal's Office Use Only)</p>	
<p style="text-align: center;">This section is for application approval only</p> <p><u>McGladrey</u> <u>3/13/2023</u> Fire Marshal or Designee Date</p> <p>Conditions: <u>TVFR Final inspection required</u></p> <p style="margin-left: 40px;"><u>MERRC Fees must be paid prior to building permit issuance.</u></p> <p>See Attached Conditions: <input type="checkbox"/> Yes <input type="checkbox"/> No</p> <p>Site Inspection Required: <input checked="" type="checkbox"/> Yes <input type="checkbox"/> No</p>	<p style="text-align: center;">This section used when site inspection is required</p> <p>Inspection Comments:</p> <hr/> <p>Final TVFR Approval Signature & Emp ID _____ Date _____</p>

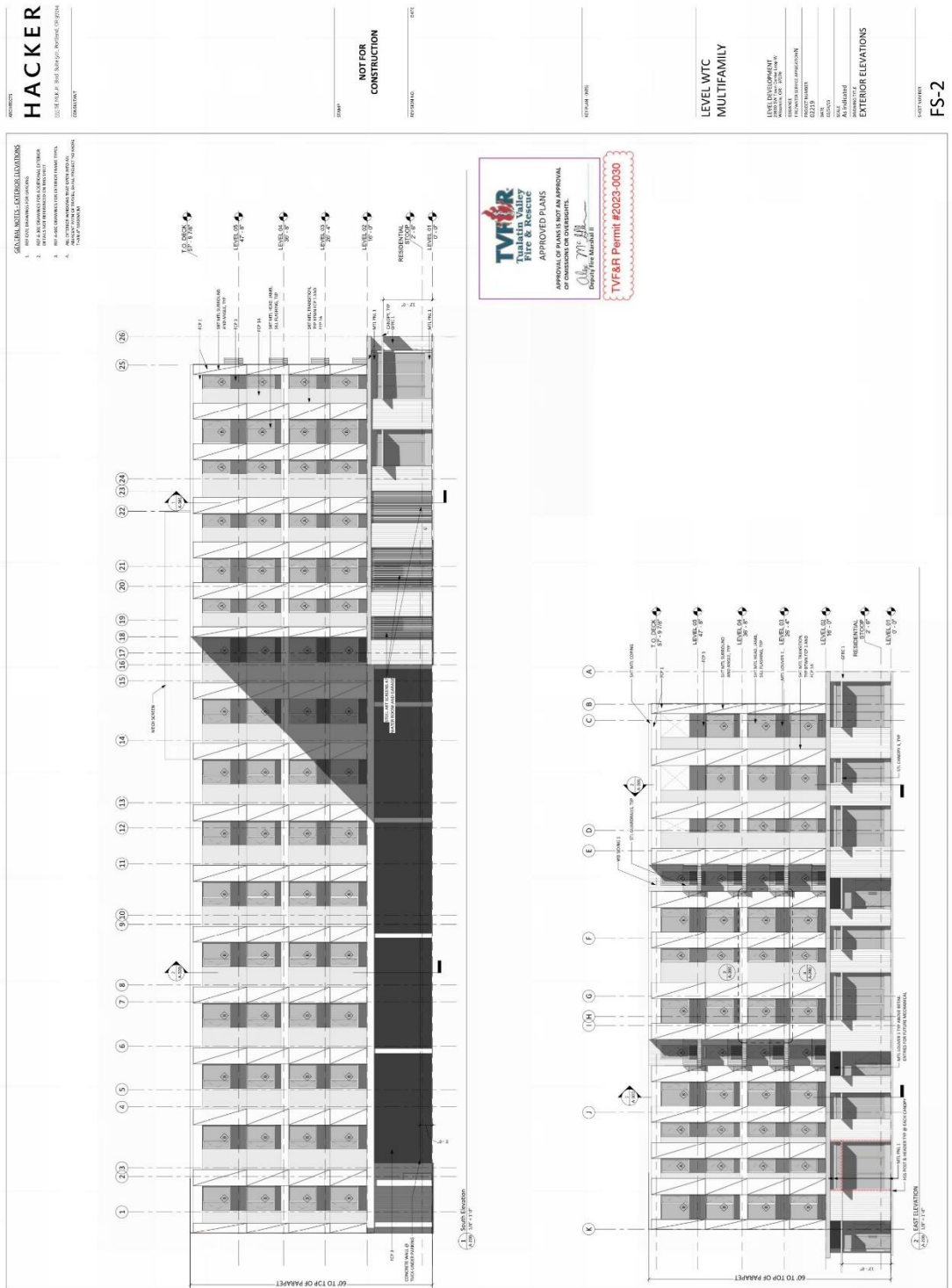



Memo

100 SW Main Street, Suite 1600
Portland, OR 97204
TEL 503.382.2266
FAX 503.382.2262
www.interfaceengineering.com

Project Number	2022-0879	Date	June 27, 2022
Project Name	City of Wilsonville Flow Testing		
To	Dan Carlson	Phone	503-227-3251
	City of Wilsonville 29799 SW Town Center Loop E Wilsonville, OR 97070		
From	Jarod Myrick, CET	@	Interface Engineering, Inc.
Distribution	Dan Carlson – Building Official, Ian Eglitis – Acting Utilities Supervisor		

Applies To Fire/Life Safety

Comments: Flow Test

A hydrant flow test was conducted for the subject project at your request. Test Results are:

Test Date and Time =	06/27/2022 @ 10:47am
Tester Names =	Jarod Myrick, Interface Engineering Randy Burnham, City of Wilsonville Water Dept. Sam Kinnaman, City of Wilsonville Supervisor Jon Scott, City of Wilsonville Building Inspector.
Witnesses =	

Test Conducted Per the National Fire Protection Association (NFPA), Recommended Practice #291.

Gauges Calibrations	Certified through February 18, 2023
Pressure Hydrant Location =	#3403 – Town Center Loop W
Pressure Hydrant is on a	<input checked="" type="checkbox"/> Circulating Main <input type="checkbox"/> Dead-End Main
Flow Hydrant #1 Location =	#3401 – Citizens Dr
Flow Hydrant #1 is on a	<input checked="" type="checkbox"/> Circulating Main <input type="checkbox"/> Dead-End Main
Test Static Pressure =	100 psig
Test Residual Pressure =	94 psig
UL Certified Orifice Plate Pressure	43 psig
Test Nozzle =	4 ½" Hose Monster, C=1.0
Corrected Flow =	2171 gpm
Calculated Available Fire Flow =	Theoretical: 8793 gpm at 20 psi. Contact City of Wilsonville for system limitations

National Fire Protection Association (NFPA) Recommended Practice #291: "To obtain satisfactory test results of theoretical calculation of expected flows or rated capacities, sufficient discharge should be achieved to cause a drop in pressure at the residual hydrant of at least 25 percent, or to flow the total demand necessary for fire-fighting purposes."

This test achieved:

- Flow of the total demand necessary for fire-fighting purposes.



EXPIRES: 12/31/23

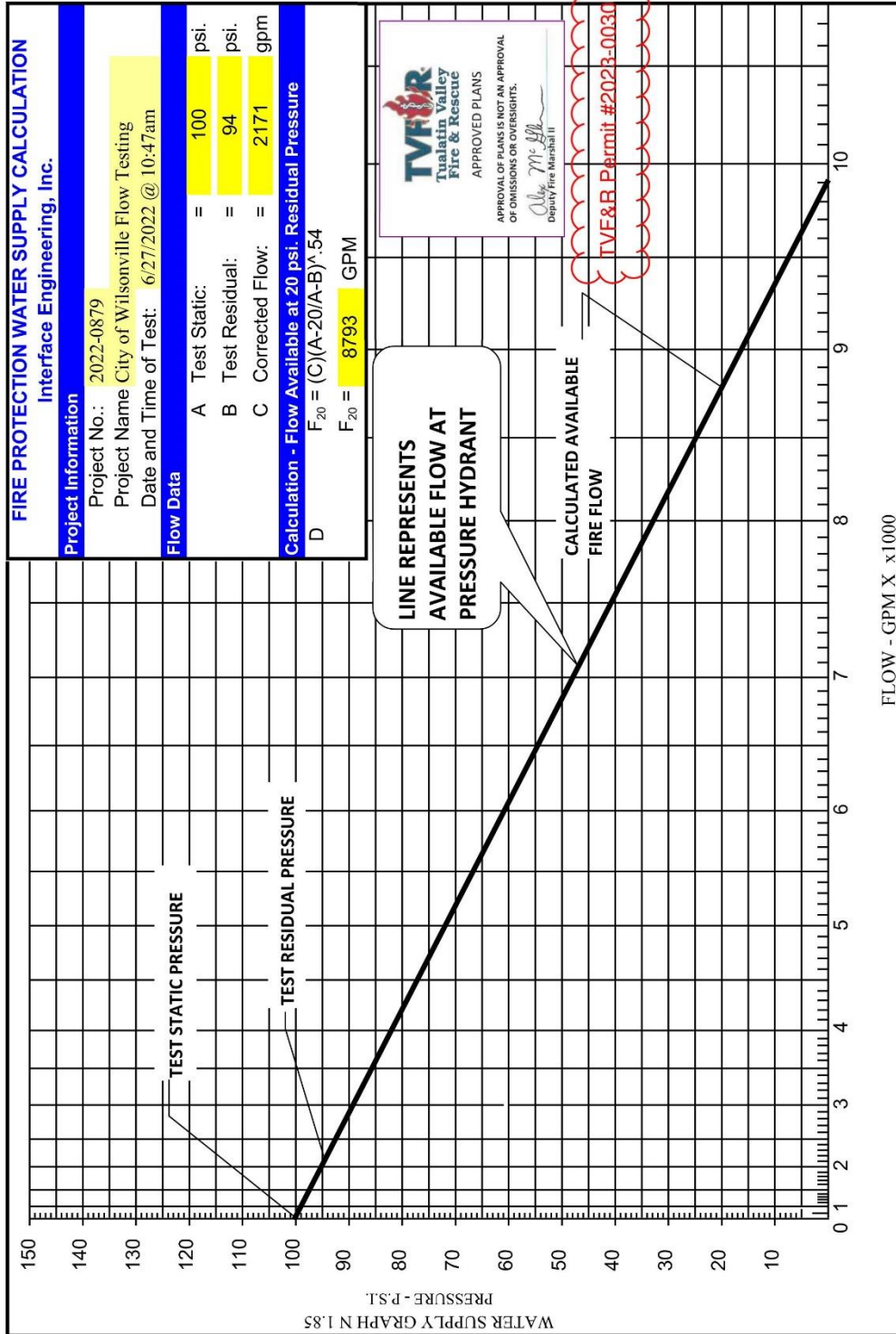

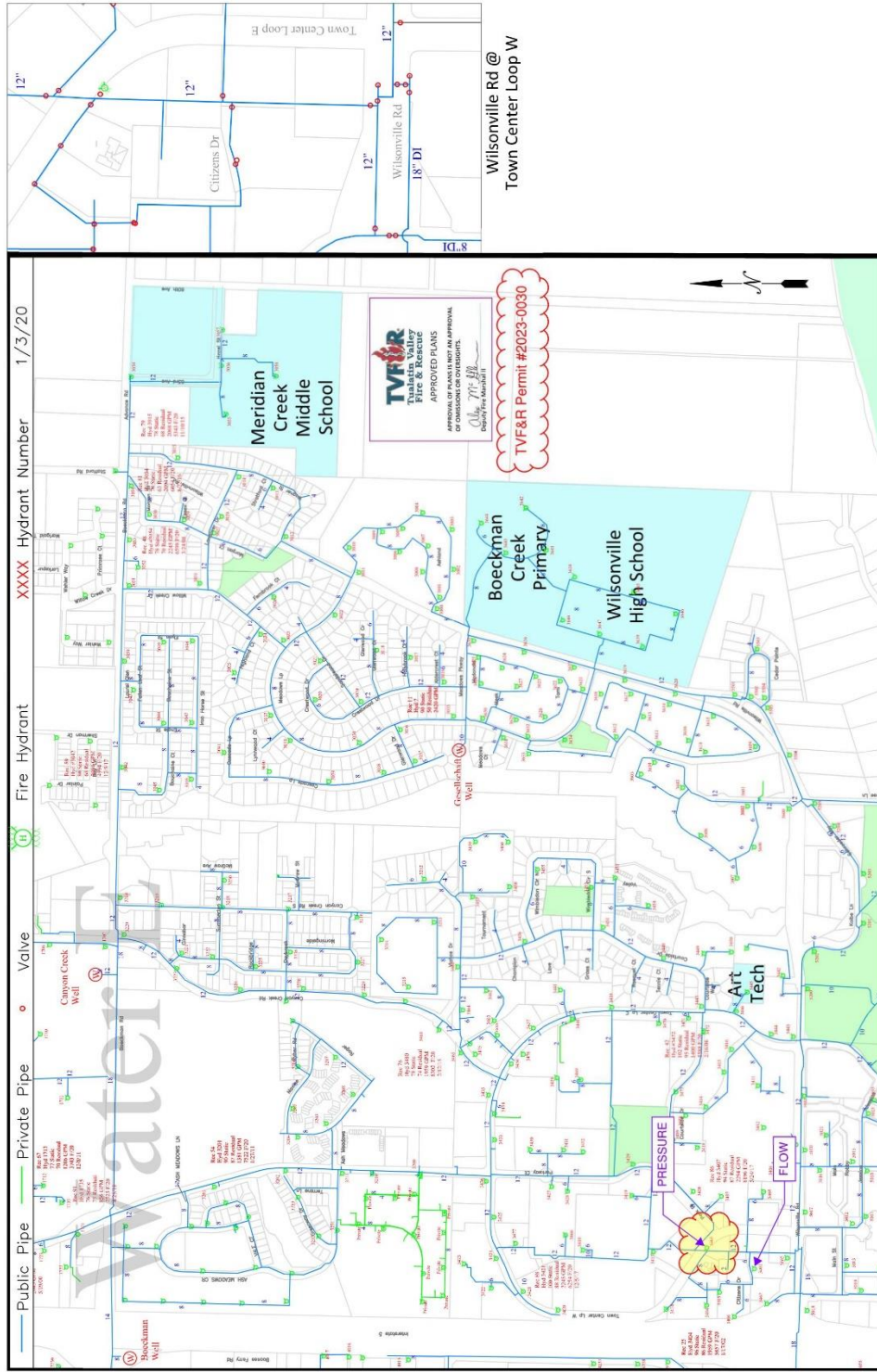

Sheet 3 of 4



HOSE MONSTER™

4" & 4 ½" CONNECTION FLOW CHART

PSI	4"		PSI	4 ½"	
	GPM	GPM		GPM	GPM
10		1047	43		2171
11		1098	44		2196
12		1147	45		2221
13		1194	46		2245
14		1239	47		2270
15		1282	48		2294
16		1324	49		2317
17		1365	50		2341
18		1405	51		2364
19		1443	52		2387
20		1481	53		2410
21		1517	54		2433
22		1553	55		2455
23		1588	56		2478
24		1622	57		2500
25		1655	58		2521
26		1688	59		2543
27		1720	60		2564
28		1752	61		2586
29		1783	62		2607
30		1813	63		2628
31		1843	64		2649
32		1873	65		2669
33		1902	66		2690
34		1930	67		2710
35		1959	68		2730
36		1986	69		2750
37		2014	70		2770
38		2041	71		2790
39		2068	72		2809
40		2094	73		2829
41		2120	74		2848
42		2146	75		2867

FLOW TEST

The readings on this chart are based on the orifice plate diameter. It is the user's responsibility to verify that the correct chart and column is being used.

- 4" Use this column if the connection to the Hose Monster is 4".
- 4 ½" Use this column if the connection to the Hose Monster is 4 ½".

This chart is FM Approved for flow rate accuracy. Please call us or instruct the Authority Having Jurisdiction to call us if there are any questions. Additional copies of flow charts are available at: www.hosemonster.com



TVF&R
Tualatin Valley
Fire & Rescue
APPROVED PLANS

APPROVAL OF PLANS IS NOT AN APPROVAL OF OMISSIONS OR OVERSIGHTS.

Alex McElle
Deputy Fire Marshal II

MANU
The H
(888)
(847) 434-0073 Fax
Service @ FlowTest.com
www.HoseMonster.com



HOSE MONSTER
COMPANY™

Republic Service Compliance Records:

See following reduced attachments:

- Service Provider Letter dated 4/07/2023
- 'A-101 Trash Room Updates' Diagram
- '230403_Trash Loading Sketch_hacker (003).pdf'



10215 SW 2nd Street, Roseburg, Oregon, OR 97530
503-526-0900, 503-526-9807, republicservices.com

April 7, 2023

Daniel Childs
Hacker Architects

Re: Wilsonville Town Center Development
Town Center Loop West
Wilsonville OR, 97070

Dear Daniel,

My Company: Republic Services of Clackamas and Washington Counties has the franchise agreement to service this area with the City of Wilsonville OR. We will provide complete commercial waste removal and recycling services as needed on a weekly basis for this location on Town Center Loop West.

We have reviewed the preliminary design plan* for the trash/recycle room received 3/20/2023 and have concluded that it is adequate in size to house the necessary equipment for this residential-retail facility.
*A-101 Trash Room Plan Updates

We have reviewed the preliminary design plan** for the designated trash/recycle "service zone" received 4/3/2023 and have concluded that it is adequate for our trucks to safely access and service the receptacles.
**230403_Trash Loading Sketch_hacker (003)

It is our understanding that the facilities property management staff will stage all the trash and recycle receptacles at the designated "service zone" on the service days agreed upon following completion of the project.

Service levels are available as follows:

- Trash – 6 days per week
- Recycle – 5 days per week
- Food Waste – 5 days per week
- Glass – 1 day per week

We look forward to reviewing the final design plans when they become available.

Sincerely,

Kelly Herrod
Operations Supervisor
Republic Services Inc.

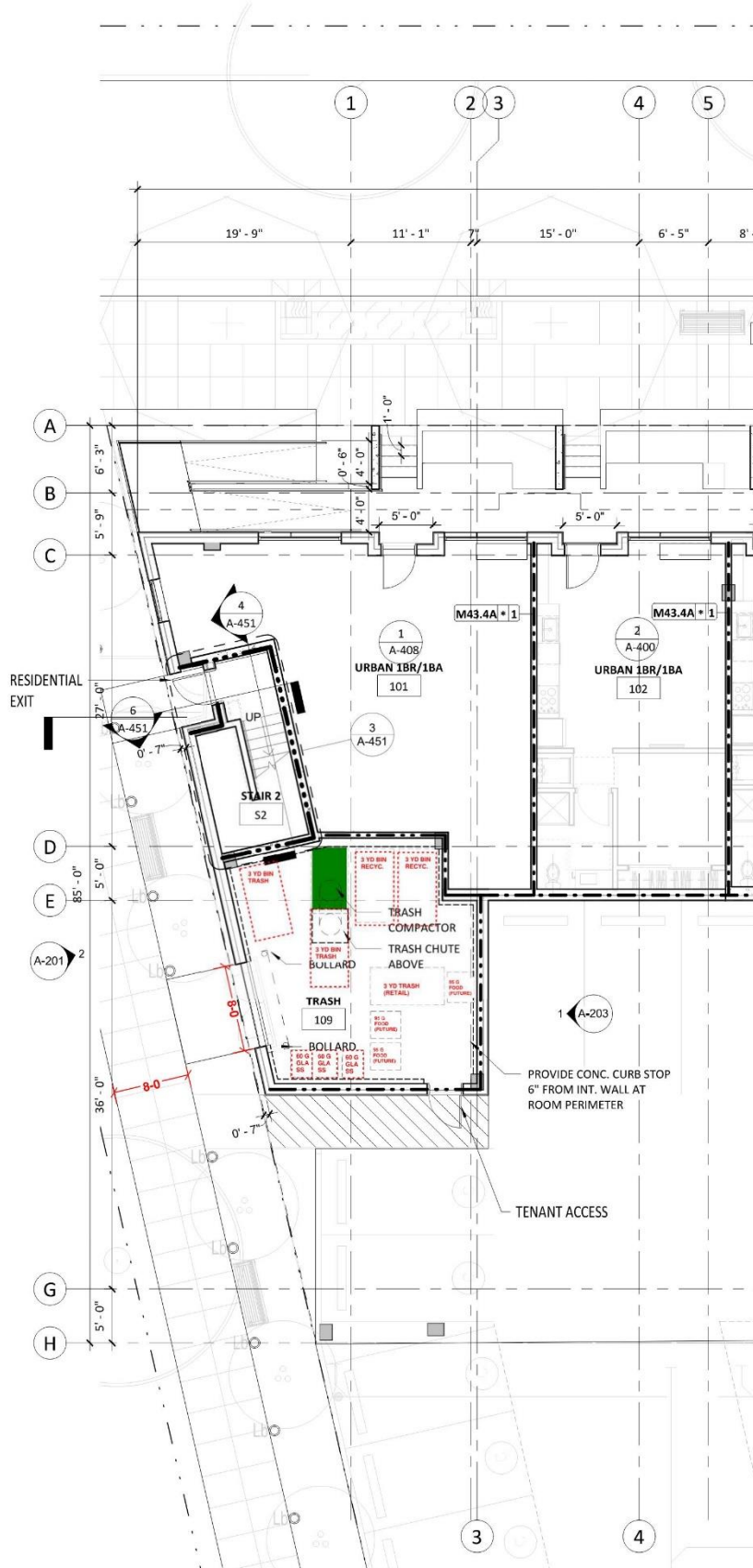

TRASH LOADING DIAGRAM

- PROVIDE ADEQUATE SPACE FOR (2) 3 YARD BINS. ROLL CARTS CAN BE LOCATED AT FLUSH CORNER CURB.
- (1) 3 YARD BIN IS LOCATED BEYOND 35' TRUCK DIMENSION TO ALLOW MANEUVERING OF BIN TO PROPER LOCATION ON STREET.
- REPUBLIC CAN MOVE BIN AS FAR WEST AS NECESSARY TO ENSURE TRUCK DOES NOT NEED TO BACK UP IN TO NEIGHBORING DRIVE AISLE.
- COMPACTED BIN ONLY REQUIRED TO BE MOVED ~10'-15' BY REPUBLIC.
- R- WILL REQUIRE A SMALL REDUCTION IN LANDSCAPE/STORMWATER AREA THAT DESIGN TEAM WILL NEED TO ADDRESS.
- FLUSH CURB AT CORNER CAN BE USED TO HOLD CARTS IF TWO BINS ARE SET OUT TO CURB.
- CIVIL WILL NEED TO ADDRESS GRADING AND DRAINAGE FOR FLUSH CURB DURING LATER HALF OF DESIGN DEVELOPMENT.

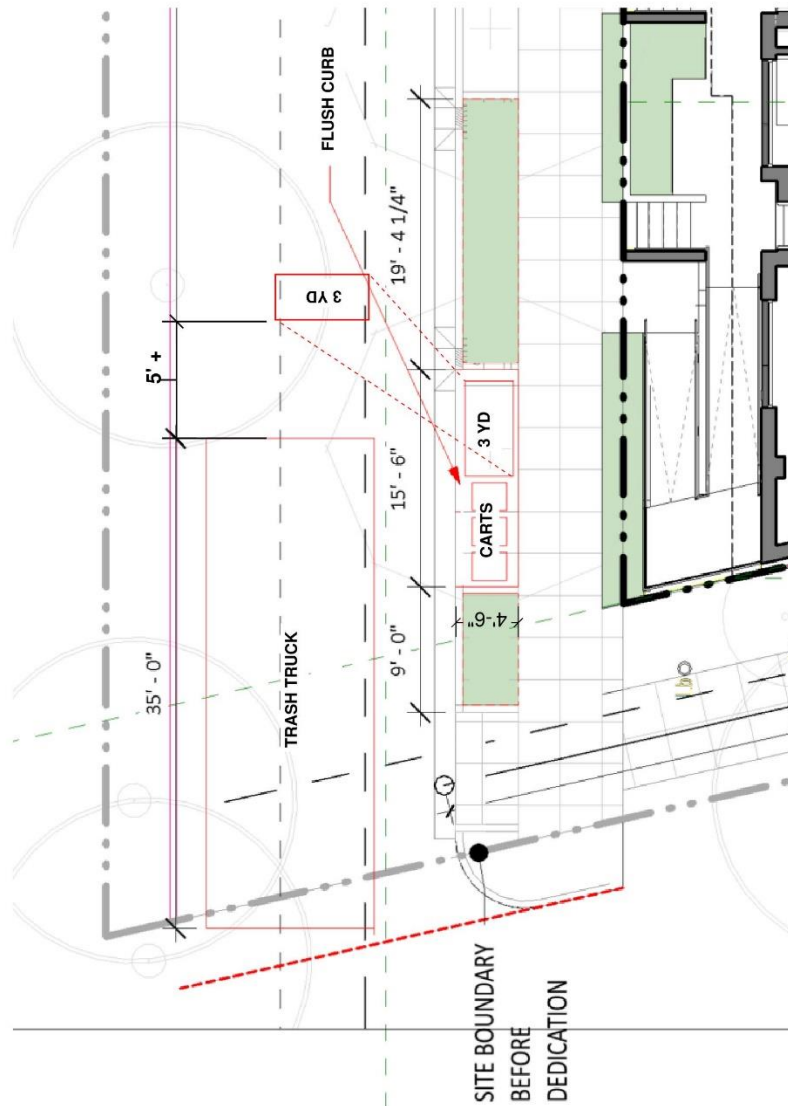

Code Criteria Response Narrative:

The proposal site is located within the TC-MU subarea of the Town Center (TC) zone. Applicable code sections of the Wilsonville Development Code and Zoning Code are as follows:

- 4.118 Standards Applying to all Planned Development Zones
- 4.132 Town Center Zone
- 4.140 Planned Development Regulations
- 4.154 On-Site Pedestrian Access and Circulation
- 4.155 Parking, Loading, and Bicycle Parking
- 4.156.01 through 4.156.11 Signs
- 4.171 Protection of Natural and Other Features
- 4.175 Public Safety and Crime Prevention
- 4.176 Landscaping, Screening, and Buffering
- 4.177 Street Improvement Standards
- 4.179 Mixed Solid Waste and Recycling
- 4.199 Outdoor Lighting
- 4.300 Underground Utilities
- 4.400 through 4.450 Site Design Review
- 4.600 through 4.640.20 Tree Preservation and Protection
- 4.001 Definition of Terms

The applicant's written criteria response to relevant development standards and guidelines is included in the following pages.

Section 4.132. Town Center Zone

4.132(.02)

Uses permitted anywhere in the TC Zone:

- A. Open space.
- B. Multiple-family Dwelling Units, except in areas immediately adjacent to I-5 as noted in Subsection [4.132](.03)A. below within the Commercial-Mixed Use District.
- C. Public or private parks, playgrounds, recreational and community buildings and uses.
- D. Commercial recreation.
- E. Religious institutions.
- F. Retail sales and service of retail products, under a footprint of 30,000 square feet per use.
- G. Office, including medical facilities.
- H. Personal and professional services.
- I. Child and/or day care.
- J. Food service (e.g. restaurants, food carts, food cart pods).
- K. Beverage service (e.g. cafes, brewpubs, bars).
- L. Any of the above in mixed-use buildings.

Response: The site is a mixed-use development within the TC Zone and is not immediately adjacent to I-5. The proposal includes allowed uses of multi-family dwelling units, and commercial leasable space. 3,707 sf of leasable commercial space is anticipated to be retail sales, office, food service, or beverage service and will be permitted in future Tenant Improvement permits.

The criterion is met.

4.132(.03)

Permitted and Prohibited uses in specific sub-districts. Figure 1, Land Use Sub-Districts, illustrates subareas of the Town Center where certain regulations apply. Below are use-related regulations for the sub-districts.

C. Mixed Use (MU):

- 1. Additional permitted uses—Single-user commercial or retail (e.g. grocery store or retail establishment) may exceed 30,000 square feet if located on more than one story of a multi-story building.
- 2. Uses with drive-through facilities—New uses with drive-through facilities (e.g. fast food, banks, car wash) are permitted in the MU sub-district, provided that they meet design and development standards for the TC Zone. Existing drive-through uses and facilities may be continued consistent with Section 4.189.

Response: Per Figure 1, the site is in the Mixed Use – MU Sub-District of the TC Zone. 3,707 sf of leasable commercial space is anticipated to be retail sales, office, food service, or beverage service and will be permitted in future Tenant Improvement permits. No drive-through facilities are proposed on site.

Therefore, the criterion is met.

4.132(.04)

Consistency with Street Network and Multi-modal Network:

- A. All development will be consistent with the Street Network and Multi-modal Network, shown in Figures 2 and 3. Street and multi-modal facility locations are approximate and will be finalized as part of the development review process. The purpose of these plans are to support the creation of a highly connected and walkable Town Center where there are options for travel. The Development Review Board (DRB) may approve variations from Figures 2 and/or 3, if:
1. Existing development restricts the connection from being developed;
 2. Existing natural resources and/or open space would be adversely affected by construction of the facility and mitigation of those impacts is not feasible.
- B. If a street or other multimodal connection varies from Figures 2 and/or 3, equivalent connectivity and multi-modal travel options shall be provided as determined in a Transportation Impact Analysis prepared per Section 4.140 and approved by the City Engineer.
- C. All development shall provide transportation facilities consistent with the cross-sections in the Wilsonville Town Center Plan and applicable provisions of the Wilsonville Transportation System Plan subject to variations approved by the City Engineer.
- D. All franchise utilities shall be located underground within the public sidewalk.

Response: Figure 2 Street Network shows Town Center Loop bordering the south corner and southwestern edge of the site, and is designated as an 'Existing, Local Street'. Park Place borders the southeaster edge, and is outlined, however is given no designation of Street Hierarchy. New 'Local Street(s)' are shown as Proposed along the northeastern, and northwestern borders of the site.

Figure 3 Multimodal Network overlays open space, and pedestrian and bike system information over the Street Network of Figure 2. Park Place is shown as a Proposed Open Space and Proposed Multi-Use Path. Town Center Loop is shown as a Proposed Cycle Track (2-way).

In the Wilsonville Town Center Plan, project IN.8 Town Center Loop W Modifications, and the associated Appendix D document reference a cross-section for 'Local Street Option 2', with a 60-foot overall right-of-way, with 12-foot sidewalks. This 'Local Street Option 2' cross-section also illustrates the intent for the new local streets at the northeast and northwest site boundaries.

Infrastructure project 'IN.10 Park Place Promenade Redesign references that Park Place will become a pedestrian-oriented linear park feature, and references the 'Woonerf-style local street cross-section' in Appendix D. The 'Local Street Option 3' cross-section in Appendix D shows a woonerf-style shared roadway section, with a 54-foot right-of-way, with a 12-foot sidewalk, and 14-foot sidewalk. Table 5.1 states that IN.10 Park Place Promenade Redesign will occur in the medium and long-range timeline.

Drawing A-000 Land Use Site Plan illustrates the proposed street and right-of-way improvements in the project. The proposal maintains the existing curb along Town Center Loop and provides a 6.75-foot right-of-way dedication in order to provide a 12-foot-wide sidewalk for the entire southwestern site edge. This is consistent with the project description 'IN.8 Town Center Loop W Modifications', and the 'Local Street Option 2' street section. The proposal maintains the existing curb along Park Place, and provides a 2.17-foot right-of-way dedication to allow a 12-foot-wide sidewalk for the entire southeaster frontage. This is

consistent with the 'Local Street Option 3' cross-section and allows for the future project IN.10 Park Place Promenade Redesign.

(cont'd) A partial new 'Local Street' is provided in the proposal along the northeastern site edge. The Response: applicant has received preliminary approval from City staff to provide a functional interim street section in lieu of the 60-foot right-of-way shown in Appendix D until neighboring lots are developed. The proposed 37-foot right-of-way dedication allows a 20-foot two-way drive aisle, measured from an existing northeast curb, and a 12-foot sidewalk. Planted stormwater facilities are provided within the amenity zone of the sidewalk to accommodate runoff from the new Local Street. Future neighboring development will be required to dedicate property and construct the remaining 23 feet of on-street parking, asphalt, restriping, and sidewalk to complete the 60-foot right-of-way illustrated in the 'Local Street Option 2' cross-section. The proposed modification is consistent with the intent of the Appendix D.

The applicant has received preliminary approval from City Staff to provide a partial Pedestrian and Bicycle Connection in lieu of a new Local Street along the northwest site edge connecting Town Center Loop to the new Local Street at the northeast. The proposal provides a 15-foot dedication for the entire northwestern edge between the existing neighboring drive-through facility and planting. A 6-foot pedestrian path, and 9-feet of landscaped planting zone provide functional interim pedestrian and bicycle connection until the neighboring lot is redeveloped and completes the anticipated 30-foot wide right-of-way.

Drawing C-300 UTILITY PLAN illustrates the proposed utilities for the project. Existing power lines, communication lines, and storm lines remain located underground within the sidewalk along Town Center Loop. Existing easements along Town Center Loop will be vacated and utilities aligned to run within the right-of-way.

Existing easements for sanitary and water cross the northwest site boundary and are not proposed to be adjusted as they provide services to other existing development that are not planned to be redeveloped.

The proposed right-of-way improvements are consistent with the street classifications and cross-sections in Figure 2, Figure 3, The Wilsonville Town Center Plan, and Appendix D.

Therefore, the criterion is met.

4.132(.05)

Consistency with Open Space Network:

A. *All development will be consistent with the Open Space Network, shown in Figure 4. The open space sizes and locations on Figure 4 are approximate and will be finalized as part of the development review process. The purpose of the plan is to create open spaces that are linked and serve as attractive amenities for Town Center. The Development Review Board may approve variations from Figure 4 if needed to accommodate existing development or physical constraints, and/or, preserve natural resources and open space. If an open space is varied, equivalent open space and open space linkage shall be provided.*

B. *The Development Review Board may specify the method of assuring the long-term protection and maintenance of open space and/or recreational areas. Where such protection or maintenance are the responsibility of a private party or homeowners' association, the City Attorney shall review any pertinent bylaws, covenants or agreements prior to recordation.*

Response: Figure 4 Open Space Network lists Park Place adjacent to the southeast site boundary as a Proposed Open Space. The redesign of Park Place as a pedestrian oriented linear park is described in project IN.10 Park Place Promenade Redesign in the Wilsonville Town Center Plan (WTCP) which references the 'Local Street Option 3' cross-section and woonerf-style street in the WTCP Appendix D. This cross-section shows an overall 54 foot right-of-way for Park Place at this location. Table 5.1 of the WTCP states that IN.10 Park Place Promenade Redesign will occur in the medium and long-range timeline, or between 6 and 20 years from the plan's adoption in 2019.

The existing right-of-way width is 80 feet and the existing sidewalk along the property's southeastern boundary is 10 feet wide. Although the existing right-of-way width of Park Place exceeds the 54 foot width of the woonerf-style 'Local Street Option 3' shown in the WTCP Appendix D, the final design and location of the pedestrian path is unknown due to the schedule for IN.10. The proposal provides a 2.17-foot right-of-way dedication along the entire Park Place frontage to provide a 12-foot sidewalk width including the existing curb. This provides a consistent open space size and location as illustrated in Figure 4 and other relevant WTCP documents.

Therefore the criterion is met.

4.132(.06)B.

Design and Development Standards:

B. Building/Street Frontage Requirements. Building and street frontage requirements in this section are intended to create an active pedestrian environment through sidewalk-facing ground floors and entryways with protection from the elements for pedestrians.

Table 1. Building/Frontage Design Standards (Local Roads)

Objective : Provides local access to adjacent development with pedestrian design focus. Local roads should also provide access to parking and service entrances

Response: Town Center Loop, Park Place and the future Park Place Promenade, and the new Local Street at the northeast site boundary are all classified as Local Roads in Figure 2. The new right-of-way along the northwest site boundary has been preliminarily approved by City staff to be modified to a Pedestrian Accessway.

The proposed design is consistent with and matches the approximate size, location, and character of Town Center Loop and Park Place per the Wilsonville Town Center Plan and WTCP Appendix D. The first-floor layout and site plan maintain an active and pedestrian-focused frontage along the entirety of Park Place and the new northeaster Local Street. On-site parking, and building services and utilities are accessed off Town Center entirely with the exception of the trash and recycling room. Due to the high amount of traffic on Town Center Loop, Republic Services requires the trash and recycling room to be serviced from the new northeastern Local Street. The proposal has located the trash room to the north corner of the building and accessed off the new Pedestrian Accessway. This allows convenient access for service and for residents while allowing a continuous frontage of active and inhabited spaces along the new Local Street.

Therefore the criterion is met.

Cont'd.
4.132(.06)B.

Table 1. Building/Frontage Design Standards (Local Roads)
Sidewalks : Required. Separated from curb by planting strip, tree wells, or rain gardens.

Response: Town Center Loop, Park Place and the future Park Place Promenade, and the new Local Street at the northeast site boundary are all classified as Local Roads in Figure 2. The new right-of-way along the northwest site boundary has been preliminarily approved by City staff to be modified to a Pedestrian Accessway.

As illustrated in drawings A-000 and C-100 the proposal provides 12-foot-wide sidewalks along Town Center Loop, Park Place, and the new northeastern Local Street. The pedestrian walkway of all three proposed sidewalks is separated from the curb by a 4-foot-wide amenity zone comprised of street trees in tree wells, and street furnishings. Additionally, the amenity zone of the sidewalk along the new northeastern Local Street includes rain gardens between the tree wells.

Therefore, the criterion is met.

Cont'd.
4.132(.06)B.

Table 1. Building/Frontage Design Standards (Local Roads)
Sidewalk Width : 12-14 feet, depending on local street option.

Response: Town Center Loop, Park Place and the future Park Place Promenade, and the new Local Street at the northeast site boundary are all classified as Local Roads in Figure 2. The new right-of-way along the northwest site boundary has been preliminarily approved by City staff to be modified to a Pedestrian Accessway. Town Center Loop requires a 12-foot sidewalk width per both 'Local Street Options 1 and 2' in the WTCP Appendix D. Park Place requires either a 12-foot or 14-foot sidewalk according to 'Local Street Option 3' in the WTCP Appendix D. It is not clear from the cross-section what side of the street should have the 12-foot width. However, given that the existing right-of-way is 80 feet, and the illustrated cross-section shows a 54-foot right-of-way, additional room exists for wider sidewalks as project IN.10 is designed. As illustrated in drawings A-000 and C-200, the proposal provides 12-foot-wide sidewalks along Town Center Loop, Park Place, and the new northeastern Local Street. This is consistent with the required sidewalk width illustrated in all relevant Local Street cross-sections in the WTCP Appendix D.

Therefore, the criterion is met.

Cont'd.
4.132(.06)B.

Table 1. Building/Frontage Design Standards (Local Roads)
Landscaping Type : Street trees and plantings, including rain gardens, rooftop gardens, plazas.

Response: As illustrated in drawings A-000, C-200, and L-200 the proposal provides landscaping both on-site and within the right-of-way. On-site landscaping of trees and plantings screen the parking from the pedestrian areas along Town Center Loop and the new northwest Pedestrian Accessway. Street trees separate pedestrians from the curb on Town Center Loop, Park Place, and the new northeastern Local Street. Rain gardens provide street runoff treatment in the amenity zone of the northeast new Local Street. A fifth-floor open-air terrace is located on the east corner of the building and includes moveable tree and planted boxes.

Therefore, the criterion is met.

Cont'd.
4.132(.06)B.

Table 1. Building/Frontage Design Standards (Local Roads)

On-street parking : Dependent on local road design (see cross section options). Parallel parking on both sides, or diagonal parking on one side, depending on ROW availability and street cross-section.

Response: Town Center Loop, Park Place and the future Park Place Promenade, and the new Local Street at the northeast site boundary are all classified as Local Roads in Figure 2. The new right-of-way along the northwest site boundary has been preliminarily approved by City staff to be modified to a Pedestrian Accessway. Per the WTCP Appendix D drawings, Town Center Loop requires either parallel parking on both sides of the street in 'Local Street Option 1', or no on-street parking in 'Local Street Option 2'. 'Local Street Option 1' is assumed as the requirement for the new northeastern Local Street. Park Place requires parallel parking on one side of the street per 'Local Street Option 3' in the WTCP Appendix D. It is not clear from the cross-section what side of the street should have the parallel parking. Drawing A-000 illustrates the proposed right-of-way design for each relevant street. Vehicular lanes, a planted median, and bike lanes already exist on Town Center Loop. With the proposed 6.75-foot dedication along Town Center Loop, the resulting right-of-way width will be 78.5 feet – exceeding the 6-foot width illustrated in 'Local Street Option 1 and Option 2'. Therefore the proposal exceeds the required roadway width, allowing for the on-street parking of 'Local Street Option 1' if that option is selected in the future design of IN.9. The proposed improvements of Park Place are limited to the 12-foot sidewalk from the existing curb to the new face of building. The final design of IN.10 Park Place Promenade Redesign has not been completed. However, given that the existing right-of-way is 80 feet, and the illustrated cross-section shows a 54-foot right-of-way, additional room exists to locate the on-street parking as project IN.10 is planned. Therefore, the proposed design is consistent with the parking requirements of 'Local Street Option 3'. A partial new 'Local Street' is provided in the proposal along the northeastern site edge. The applicant has received preliminary approval from City staff to provide a functional interim street section in lieu of the 60-foot right-of-way shown in Appendix D until neighboring lots are developed. The proposed 37-foot right-of-way dedication allows a 20-foot two-way drive aisle, measured from an existing northeast curb, and a 12-foot sidewalk. Future neighboring development will be required to dedicate property and construct the remaining 23 feet of right-of-way improvements, including re-stripping of the drive lanes and parallel parking on both sides of the street, to complete the 60-foot right-of-way illustrated in the 'Local Street Option 2' cross-section.

Therefore, the criterion is met.

Cont'd.
4.132(.06)B.

Table 1. Building/Frontage Design Standards (Local Roads)

Number of Lanes : Two

Response: Drawing A-000 illustrates the proposed right-of-way design for each relevant street. Two lanes, separated by a planted median, already exist along Town Center Loop and will be maintained with the proposal. Two lanes, separated by a planted median, exist along Park Place as well and will be maintained by the proposal. A partial new 'Local Street' is provided in the proposal along the northeastern site edge. The applicant has received preliminary approval from City staff to provide a functional interim street section in lieu of the 60-foot right-of-way shown in Appendix D until neighboring lots are developed. The proposed 37-foot right-of-way dedication allows a 20-foot wide, two-lane road, measured from an existing northeast curb, and a 12-foot sidewalk. Future neighboring development will be required to dedicate property and construct the remaining 23 feet of right-of-way improvements, including re-striping of the drive lanes to add parallel parking on both sides of the street, to complete the 60-foot right-of-way illustrated in the 'Local Street Option 2' cross-section. Therefore, the criterion is met.

Cont'd.
4.132(.06)B.

Table 1. Building/Frontage Design Standards (Local Roads)
Bicycle Facilities: Varies by local street option.

Response: Town Center Loop, Park Place and the future Park Place Promenade, and the new Local Street at the northeast site boundary are all classified as Local Roads in Figure 2. The new right-of-way along the northwest site boundary has been preliminarily approved by City staff to be modified to a Pedestrian Accessway. Per the WTCP Appendix D drawings, Town Center Loop is described in IN.9 as either 'Local Street Option 1' or 'Option 2'. Only "Option 2" requires a buffered bike lane on both sides of the street. 'Local Street Option 1' requires no bike lanes and is assumed as the requirement for the new northeastern Local Street. Park Place and project IN.10 Park Place Promenade Redesign shown bike lanes within the shared woonerf-style roadway as illustrated in 'Local Street Option 3'. A 6-foot bike lane and 2-foot buffer exists along Town Center Loop adjacent to the site and is maintained by the proposed right-of-way improvements as shown on drawing A-000. Project IN.10 Park Place Promenade Redesign has not yet been designed, however the existing 80-foot right of way width exceeds the 54 feet required per 'Local Street Option 3', therefore it can be assumed that the bike lanes in the woonerf roadway will be accommodated in the proposed design. No bike lanes are required or proposed along the new northeastern Local Street. Therefore, the criterion is met.

Cont'd.
4.132(.06)B.

Table 1. Building/Frontage Design Standards (Local Roads)
Minimum % of building along street frontage (see Figures 5.A through 5.D for typical site designs) :
Minimum 50% of building facing a local street. Buildings to be placed at corners.

Response: Town Center Loop, Park Place and the future Park Place Promenade, and the new Local Street at the northeast site boundary are all classified as Local Roads in Figure 2. The new right-of-way along the northwest site boundary has been preliminarily approved by City staff to be modified to a Pedestrian Accessway. Figures 5.C and 5.D both show building placement and location of parking where two Local Streets intersect. Figure 5.D most closely resembles the proposed condition, where a single parking area is entered off one local street only, parking is screened from the adjacent sidewalk by landscaped area, and the parking is limited to 50% of the street frontage. The building is required to be located at the corner of the intersection and maintain 50% of building frontage located on the street.

All the reference figures illustrate a site that is bounded only on two sides by local streets, whereas the proposal site is a full block and bound on all sides. From figures 5.C through 5.D, it can be interpreted that the intent of this code section only applies to a single corner, or two frontages, where the property is surrounded on all sides by right-of-way.

The proposed design is illustrated on A-000, with the building located at the corners of Park Place and the new Local Street, and of Park Place and Town Center Loop.

The required minimum building frontage for each Local Street frontage is 50%. After dedications, the frontage along Town Center Loop is 203.7 feet; the frontage along Park Place is 145.3 feet; and the frontage along the new Local Street is 239.1 feet.

The building frontage required along Town Center Loop is 101.9 feet, and 80.9 feet is provided. The requirement along Park Place is 72.7 feet and 145.3 feet is provided. The requirement along the new Local Street is 119.6 feet and 239.1 feet is provided. The requirement along the Pedestrian Accessway is 85.7 feet and 77 feet is provided. The proposal exceeds the standard along Park Place and the new NE Local Street.

Therefore, the criterion is met.

Cont'd.
4.132(.06)B.

Table 1. Building/Frontage Design Standards (Local Roads)

Location of Parking : On street when allowed, behind or to the side of the building. Off street parking is not permitted along main street frontage. Off-street parking prohibited at corners of public streets.

Response: Town Center Loop, Park Place and the future Park Place Promenade, and the new Local Street at the northeast site boundary are all classified as Local Roads in Figure 2. The new right-of-way along the northwest site boundary has been preliminarily approved by City staff to be modified to a Pedestrian Accessway. Therefore, the project is not adjacent to any Main Streets.

The proposed site plan is illustrated on drawing A-000. The building is located at the intersection of Park Place and the new northeastern Local Street. The building anchors the entire frontages of Park Place and the new Local Street. An open-air, tuck-under parking lot is located at the west corner of the lot and vehicle access is located from the west corner off of Town Center Loop. The building separates the intersection of Park Place and Town Center Loop from the parking with a 54.25-foot-long frontage along Town Center Loop. Therefore, the criterion is met.

Cont'd.
4.132(.06)B.

Table 1. Building/Frontage Design Standards (Local Roads)
Parking access: Parking access provided via local access street or alley.

Response: Town Center Loop, Park Place and the future Park Place Promenade, and the new Local Street at the northeast site boundary are all classified as Local Roads in Figure 2. The new right-of-way along the northwest site boundary has been preliminarily approved by City staff to be modified to a Pedestrian Accessway.
The proposed site plan is illustrated on drawing A-000. An open-air, tuck-under parking lot is located at the west corner of the lot and vehicle access is provided in the west corner off of Town Center Loop.
Therefore, the criterion is met.

Cont'd.
4.132(.06)B.

Table 1. Building/Frontage Design Standards (Local Roads)
Driveway spacing standards: 100 foot minimum

Response: The proposed site plan is illustrated on drawing A-000. The proposed driveway located along Town Center Loop and is separated from the current intersection of Park Place and Town Center Loop 204.5 feet to the northwest. An existing access further to the northwest is currently used as access to the neighboring northwest property. This access road is anticipated to become a future Local Road in the Wilsonville Town Center Plan documents. The proposed driveway is separated from this access drive by 150 feet.
Therefore, the criterion is met.

Cont'd.
4.132(.06)B.

Table 1. Building/Frontage Design Standards (Local Roads)
Block Length : Maximum block length is 400 ft. The maximum distance to a pedestrian mid-block crossing shall be 250 ft. to provide pedestrian and parking access. Maximum mid-block crossing width up to 30 feet.

Response: As illustrated on A-000, after right-of-way dedications at Park Place, Town Center Loop, and the new northwestern Pedestrian Accessway, the total property perimeter along Town Center Loop and resulting block length is 203.75 feet. Additionally after these dedications, the total property perimeter along the northeastern Local Street and resulting block length is 239 feet.
Therefore, the criterion is met.

Cont'd.
4.132(.06)B.

Table 1. Building/Frontage Design Standards (Local Roads)
Typical Vehicle Speed : 20-25 mph

Response: There are no privately owned streets in the proposal, therefore the criterion is not relevant.

4.132(.06)C.

Design and Development Standards:
C. Development Standards. Development standards apply to all new development within the Town Center boundary.

Table 2. Town Center Development Standards (MU Sub-District)
Front and Rear Setbacks: Minimum – 0 feet; Maximum [2] – 20 feet.
[2] For commercial development, the maximum front and street side yard setback is 10 feet. For mixed-use and residential only development, the maximum front

setback is 20 feet. Front setbacks are permitted provided they are used for seating or other uses that encourage pedestrian activity and active ground floor uses. A variety of building setbacks are encouraged.

Side facing street and Side Setbacks: Minimum – 0 feet; Maximum [2] – 10 feet.

Response: The proposed site plan is illustrated on drawing A-000. The building maintains a 0-foot setback along Park Place and Town Center Loop at the ground-level, and steps back at the above floors 7 feet as required by 4.132(.06) M.2.b.ii. Along the northeast new Local Street, the building maintains a 0-foot setback at the common and entry area, and then sets back 8'-11" feet at the ground level, and 8 feet at the upper floors for the remainder of the frontage. The building is set back 0 feet along the new northwest Pedestrian Accessway. The design is allowed a minimum of 0 feet, and a maximum of 10 feet setback on all frontages. Therefore, the criterion is met.

Cont'd.
4.132(.06)C.

Table 2. Town Center Development Standards (MU Sub-District)
Building Height (Stories/feet) [4]: Minimum – 2; Maximum – 4 [4]
[3] – Second stories or higher in buildings must be useable. No false front buildings are permitted
[4] – Within the MSD, MU, and C-MU sub-districts, the maximum number of buildings stories may be increased by one story if a minimum of 25 percent of the units of the bonus floor area are affordable, with rental rates / mortgage restrictions for a minimum of ten years, to households earning at or below 80 percent of median family income in Wilsonville.

Response: As illustrated on drawings A-200 and A-300, the proposed building is 5 stories tall. This meets the criterion for minimum (two) stories in the MU Sub-District but exceeds the maximum (four) stories standard. The applicant requests a Waiver to the Development Standard per 4.132(.06) D to allow the maximum stories be increased to 5. See section 4.132(.06) D in following pages.

Cont'd.
4.132(.06)C.

Table 2. Town Center Development Standards (MU Sub-District)
Ground floor height minimum [5]: 12 feet
[5] This standard does not apply to residential-only buildings

Response: As illustrated on drawings A-200 and A-300, the proposed ground-floor height is 17 feet and exceeds the required standard of 12-feet minimum. Therefore, the criterion is met.

Cont'd.
4.132(.06)C.

Table 2. Town Center Development Standards (MU Sub-District)
Ground floor uses: N/A

Response: The criterion is not applicable.

Cont'd.
4.132(.06)C.

Table 2. Town Center Development Standards (MU Sub-District)
Building site coverage maximum: 90%

Response: The total site area after dedications is 33,265 sf as noted on drawing C-100. The resulting allowable building site coverage is 29,938 sf. The total building footprint and site coverage is noted on drawing A-000 as 20,052 sf, which is 60.2% of the site area after dedication. Therefore, the criterion is met.

Cont'd.
4.132(.06)C.

Table 2. Town Center Development Standards (MU Sub-District)
*Minimum Landscaping : 15% (*Corrected to 10% per City review)*

Response: City staff has clarified that the requirement should be corrected to 10% of the site area after dedications due to conflicts with other portions of the Town Center Zone code. Staff has also clarified that site area should reflect 'project area', including all right-of-way improvements other than vehicular surface (on-street parking or street).

A-000 shows that the total site area after dedications is 33,267 sf, and the total project area is 43,142 sf. The resulting minimum landscaped area is 4,314 sf.

The proposal provides 4,563 sf, or 10.6%, landscaping, and relies on a combination of on-site landscaping and planted area within the right-of-way or 'project area' to meet the 10% Landscaping standard. As illustrated on A-000, 2,778 sf of planted area is located within the right-of way building zone, amenity zone or tree wells, and screening along the Pedestrian Accessway. An additional 80 sf of planting is included in stormwater facilities in the amenity zone along the new Local Street. Therefore, the criterion is met.

Cont'd.
4.132(.06)C.

Table 2. Town Center Development Standards (MU Sub-District)
Minimum Building Frontage : 50%

Response: The required minimum building frontage for each right-of-way frontage is 50%. After dedications, the frontage along Town Center Loop is 203.7 feet; the frontage along Park Place is 145.3 feet; the frontage along the new Local Street is 239.1 feet; and the frontage along the new Pedestrian Accessway is 171.4'.

While not required for these other site frontages, as illustrated on A-000, the 50% building frontage required along Town Center Loop is 101.9 feet, and 80.9 feet is provided. The measurement along Park Place is 72.7 feet and 145.3 feet is provided. The measurement along the new Local Street is 119.6 feet and 239.1 feet is provided. Along the Pedestrian Accessway is 85.7 feet and 77 feet is provided.

From figures 5.C through 5.D, the code applies to two frontages of a full-block property. The proposal exceeds the standard along Park Place and the new NE Local Street.

Therefore, the criterion is met

Cont'd.
4.132(.06)C.

Table 2. Town Center Development Standards (MU Sub-District)
Residential density (units per acre): Minimum – 40, Maximum – None/No Limit

- *Minimum residential density applies to residential-only development. There is no minimum for mixed-use development.*

Response: A-000 shows that the total site area after dedications is 33,267 sf, or 0.76 acres. Minimum dwelling units per acre density does not apply to mixed-use development, so there is no

minimum requirement. There is no maximum limit to dwelling unit density with the MU Sub-District. The proposal provides 114 dwelling units and 3,707 square feet of leasable commercial tenant space.

Therefore, the criterion is met.

Cont'd.
4.132(.06)D.

D. Waivers to Development Standards. Development standards apply to all new development within the Town Center boundary.

The Development Review Board (DRB) may approve waivers to the size of the ground floor of a building floorplate and/or the number of stories of a building within the MU and C-MU sub-districts, consistent with the provisions of Section 4.118 (.03) if one item from each of the two following menus are met in a manner to clearly go substantially above and beyond Code requirements and typical building and site design to create a sense of place and mitigate negative impacts of the project related to the reason for the waiver. Items chosen from the menus shall account for need based on adjacent sites or the surrounding area:

Menu One:

- 1. Public amenities, such as a plaza or other community gathering space, incorporated into the building design. Public plaza or other gathering spaces located in a prominent, visible location adjacent to a public street and include movable furniture that is functional and visually interesting.*
- 2. Public community meeting space provided within the building.*
- 3. Provision of ground floor facades that include additional supporting storefronts. The primary entrance of all businesses shall be located on the primary street frontage.*
- 4. Provision of incubator space on site, either within or adjacent to the development that provides below market lease rates for small businesses.*
- 5. Provision of affordable housing on the development site, consistent with the provisions of Table 2, footnote 4.*

Menu Two:

- 1. Innovative building techniques, such as rainwater harvesting, graywater systems, green roofs, or other environmental systems, shall be incorporated into the building design to significantly reduce impact to the environment.*
- 2. Building architecture that creates a distinctive community landmark exemplifying the preferred materials and form for Town Center described in Subsection 4.132(.06)M. and discussed in the Town Center Plan.*
- 3. Pedestrian-oriented and creative lighting incorporated into landscape features and plazas and/or interior window retail displays that are lit at night.*
- 4. Achievement of LEED certification, Earth Advantage, or another recognized environmental certification.*
- 5. Installation of public art, consistent with the provisions of Subsection 4.132(.06)K. for art within plaza areas.*

Response: The applicant has requested waivers to the development standards and responded to the criteria for Section 4.118(.03) for each individual waiver. Refer to the criteria response for each anticipated waiver in the ‘Anticipated Waivers’ section of this narrative.

4.132(.06)E

E. Building Placement. Buildings shall meet the following standards:
 1. *Main Streets and Local Streets. Where parcels are bounded by a main street and perpendicular street, buildings shall be located at the street intersection. For parcels with frontage only on one street or if a building is already located at the street intersection, the new building shall be located immediately adjacent to existing building to create a continuous building façade with adjacent buildings. Street frontage requirements for main street are a minimum of 70 percent of the lot frontage. Off-street parking shall be located behind buildings fronting main street, either on surface or tuck under lot, parking structure, or at a central off-site parking facility located within the TC boundary.*

Response: The proposal site is bounded on three frontages by Local Streets at Town Center Loop, Park Place, and the new northeast Local Street. There is no existing building to remain on the parcel.

The building is located at the east corner of the site, at the intersection of Park Place Blvd, and the new northeast Local Street the applicant is constructing. Additionally, the building provides 100% frontage for both streets. Off-street parking is behind the building from these streets, and is accessed via Town Center Loop, which is a local street.

Therefore, the criterion is met and exceeded.

**Cont’d.
4.132(.06)E.**

2. If a parcel fronts two or more different street design classifications, the primary building entrance shall front the following in order of priority: main street, local street, collector street.

Response: The proposal site is bounded on three frontages by Local Streets, and one frontage by a Pedestrian Accessway.

The proposal site plan is illustrated in drawing A-000. The primary building entrance to the residential lobby is located along the new northeast Local Street, and setback from the corner of Park Place by 40 feet. Additionally, primary entries to all commercial tenant spaces directly front Park Place.

Therefore, the criterion is met.

**Cont’d.
4.132(.06)E.**

3. Minimum building frontage requirements for a local street shall be 25 percent if the development also fronts main street.

Response: The proposal site is bounded on three frontages by Local Streets, and one frontage by a Pedestrian Accessway. There is no main street frontage.

Therefore, the criterion is not applicable

Cont'd.
4.132(.06)E.

4. *Minimum building frontage requirements for a local street shall be 50 percent if the development fronts another local street.*

Response: The required minimum building frontage for each right-of-way frontage is 50%. After dedications, the frontage along Town Center Loop is 203.7 feet; the frontage along Park Place is 145.3 feet; and the frontage along the new Local Street is 239.1 feet.

As illustrated on A-000, the 50% building frontage required along Park Place is 72.7 feet and 145.3 feet is provided. The requirement along the new Local Street is 119.6 feet and 239.1 feet is provided.

From figures 5.C through 5.D, the code applies to two frontages of a full-block property. Therefore, the proposal exceeds the standard along Park Place and the new NE Local Street, and the criterion is met

Cont'd.
4.132(.06)E.

5. *For parcels that do not front a main street or a local street, the minimum building frontage shall occupy a minimum 50 percent of the lot frontage.*

Response: The proposal site is bounded on three frontages by Local Streets, and one frontage by a Pedestrian Accessway.

Therefore, the criteria are not applicable

Cont'd.
4.132(.06)E.

6. *The Development Review Board may approve variations from building placement standards if existing development, physical constraints, or site circulation and access are infeasible. If the Development Review Board determines that a variation from building placement standards is required, building placement should be prioritized as follows:*

- a. *If the development is adjacent to main street, the primary frontage of the building shall remain on main street with variation from this standard occurring on a side street.*
- b. *If the development is adjacent to the main streets (e.g. Park Place and Courtyard Drive) the primary frontage shall be on Park Place with the variation occurring on Courtyard Drive.*
- c. *If the development is adjacent to two local streets, the primary frontage shall be on the north/south local street with the variation occurring on east/west local street.*

Response: The response to previous criteria to 4.132(.06)E.1, and 4.132(.06)E.2 state that figures 5.C and 5.D and building placement standards apply to two street frontages for properties that are bounded by streets on additional sides. Therefore, those criteria are met, and a variation is not triggered in this case.

In addition, as illustrated on the architectural site plan on A-100, the north/south local street is Park Place, and the east/west local streets are the new northeast Local Street, and Town Center Loop. The building frontage along Park Place and along the new Local Street is 100%. Therefore, this project also meets (6)c if it was applicable.

4.132(.06)F.

F. Building Setbacks. The minimum building setback from public street rights-of-way shall be zero feet; the maximum building setback shall be 20 feet for MSD and N-MU districts. The maximum setback shall be ten feet for all other districts. No off-street vehicle parking or loading is permitted within the setback. Bicycle parking is permitted within the setback.

Response: The proposal is in the MU sub-district, and is bounded on the northeast, southeast, and southwest by street rights-of-way. The applicable minimum setbacks are zero feet, and maximum setbacks are 10 feet.

As illustrated on the architectural site plan, A-000, the building setback along the southeast frontage along Park Place is zero feet at the ground level. Levels two through five are set back 7 feet along this frontage. Along the new northeast Local Street, the ground-floor building is set back zero feet at the residential lobby entry, and 8'-11" at the ground-floor residences. The upper levels are set back from the property line between 6 feet and 8 feet at this frontage. The portion of the building that fronts Town Center Loop is set back zero feet at the ground level, and 6 feet at the upper levels. There is no vehicle parking within any of the setbacks. Bicycle parking is provided within the cover of the building at the residential lobby entry.

All setbacks are greater than 0 feet and less than 20 feet, therefore the criterion is met on all frontages.

4.132(.06)G.

G. Front Yard Setback Design. Landscaping, water quality treatment, seating areas, an arcade, or a hard-surfaced expansion of the pedestrian path must be provided between a structure and a public street or accessway. If a building abuts more than one street, the required improvements shall be provided on all streets. Hard-surfaced areas shall be constructed with scored concrete or modular paving materials. Benches and other street furnishings are encouraged.

Response: The proposal site is bounded on three frontages by Local Streets, and one frontage by a Pedestrian Accessway.

Ground-level treatments are illustrated on the architectural site plan A-000, and the landscape materials plan L-200. The building fronts the Park Place right-of-way with a zero-foot setback. Storefront windows and entries are recessed 1 foot and 3.5 feet to articulate the façade. The concrete pedestrian path is extended into these recesses. A similar façade treatment and extension of the sidewalk wraps onto a portion of Town Center Loop. The remainder of the Town Center Loop right-of-way is abutted with at-grade landscaping and planted stormwater facility except for the parking lot entry drive.

The new northeast Local Street right-of-way is treated in a similar way to Park Place for the far east portion abutting the sidewall of retail, and residential lobby and entry. The ground-level steps back at the remainder of the frontage to provide separation for the ground-level residences. The right-of-way here is lined with a series of at-grade and 2.5-foot tall planters, private concrete steps, and scored concrete patios.

At the Pedestrian Accessway the building abuts the right-of-way at the northern portion, with landscaping and concrete access paths abutting the pedestrian path. The remainder of the

frontage is abutted by landscaped screening within the right-of-way adjacent to open-air parking.

Therefore, the criterion is met.

4.132(.06)H.

H. Walkway Connection to Building Entrances. A walkway connection is required between a building's entrance and a public street or accessway. This walkway must be at least six feet wide and be paved with concrete or modular paving materials. Building entrances at a corner adjacent to a public street intersection are encouraged.

Response: The building entrances and site materials are illustrated on the land use site plan A-000 and L-200. The primary building entrance is located along the new northeast Local Street and separated from Park Place by 45.5 feet to allow continuous retail frontage along Park Place. An 11-foot-wide concrete pedestrian walkway extends from the right-of-way directly to the entry doors which are recessed onto the property by 6 feet. Additional entrances to retail spaces along Park Place are also directly connected to the adjacent sidewalk with 7.5-foot-wide concrete pathways.

Therefore, the criterion is met.

4.132(.06)I.

*I. Parking Location and Landscape Design:
1. Parking for buildings adjacent to public street rights-of-way must be located to the side or rear of newly constructed buildings, except for buildings fronting main street, where parking must be located behind the building, either surface, tuck under or structured (above or below grade). For locations where parking may be located to the side of the building, parking is limited to 50 percent of the street frontage and must be behind a landscaped area per Section 4.176.*

Response: The proposal site is bounded on three sides by Local Streets and one side by a Pedestrian Accessway. The standards are applicable to two frontages of a site that is bounded by three or more street rights-of-way.

The building fronts the entirety of Park Place and the new northeast Local Street. The parking lot is a combination of tuck-under and surface parking and is located behind the building and completely separated from these two street rights-of-way.

Therefore, the criterion is met.

**Cont'd
4.132(.06)I.**

2. Within off-street parking lots, all parking spaces, except for those designated for ADA accessible space or deliveries, shall be shared spaces. Designation for individual uses is not permitted.

Response: The applicant has requested a waiver to the standard. See the Anticipated Waivers section of this narrative. The proposal's off-street parking is illustrated on A-100 and show 52 parking stalls and 2 ADA accessible stalls for resident parking. All parking stalls are unbundled and will be for rent by individual tenants, therefore they must be designated for individual residents. The priority will be given to residents needing the accessible stalls. Because this criterion refers to a general category of "off street parking lots" it is inapplicable in this case. Instead, here we have a

mixed-use development that does not otherwise have a minimum parking requirement. Parking is provided in a “tuck under” configuration with some surface parking. Unlike a general “off street parking lot” that can be utilized for a variety of uses in a shared parking arrangement, this lot is designated for residential use and accessory to the residential units. Further, to reduce parking demand, and consistent the climate friendly amendments to the TPR, these spaces are unbundled and are therefore targeted for rental to the building’s residents. Therefore, these residential spaces are not general spaces in an off-street lot and must be designated for individual use. The proposed design and use of the parking spaces meets the purpose and intended character of the Town Center Plan.

Cont’d
4.132(.06)I.

3. *Within off-street parking lots, time limitations may be placed on parking spaces to encourage parking turnover. This includes time limitations to pickup and drop off of goods from area businesses (e.g. drycleaner, bank ATM etc.).*

Response: The proposal’s off-street parking is illustrated on A-100 and shows 52 parking stalls and 2 ADA accessible stalls for resident parking. This criterion is permissive and states that time limitations “may” be placed on parking spaces. While that may be appropriate with non-residential uses, because these 52 spaces will be tenant rented residential spaces, no time limitations are anticipated with this application.

4.132(.06)J.

J. *Parking Garages and Off-street Parking Access. Parking garages must meet all building standards identified within this section. Off street access to a parking lot or garage should be located to minimize conflicts with pedestrians and must be provided from an alley or local street.*

Response: The off-street parking and access of the proposal is illustrated on A-100. The surface parking is buffered from the pedestrian rights-of-way along Town Center Loop and the new Pedestrian Accessway with landscaped screening complying with Section 4.176. Parking is accessed via a 20-foot wide, two-way driveway off Town Center Loop which is a Local Street.

Therefore, the criterion is met.

4.132(.06)K.

K. *Plaza Areas. The following plaza design standards are intended to enhance the overall site layout and ensure that plaza areas are designed as an accessible amenity.*

Response: No Plaza Areas area proposed in the project.

Therefore, the criterion is not applicable.

4.132(.06)L.

L. *Drive Through Facilities. A drive-through facility shall be subject to the following standards:*

Response: No Drive Through Facilities are proposed in the project.

Therefore, the criterion is not applicable.

4.132(.06)M.

M. *Building Design Standards:*
1. *General Provisions:*

- a) *The first-floor façade of all buildings, including structured parking facilities, shall be designed to encourage and complement pedestrian-scale interest and activity through the use of elements such as windows, awnings, and other similar features.*
- b) *Building entrances shall be clearly marked, provide weather covering, and incorporate architectural features of the building.*
- c) *Architectural features and treatments shall not be limited to a single façade. All visible sides of a building from the street, whether viewed from public or private property, shall display a similar level of quality and architectural interest, with elements such as windows, awnings, murals, a variety of exterior materials, reveals, and other similar features.*
- d) *Green building techniques are encouraged, which could include the use of green roofs, gray water and water harvesting, and/or LEED certification of buildings.*

Response: The proposed first floor façade design is illustrated on A-200, A-201, and in renderings on A-900. The design provides pedestrian-oriented design for 100% of the frontages along Park Place, and the new northeast Local Street.

A 16-foot-tall ground floor façade, with large storefront windows and entries, and grand 5-foot-deep canopies runs the entire length of the Park Place frontage and leads pedestrians to the residential entry and lobby off the new Local Street. The façade is constructed of highly durable and timeless materials, such linear architectural brick and factory-finished composite metal panels for the walls, aluminum storefront windows and doors, and permanent steel canopies for weather protection and signage. Entrances to commercial tenant spaces are differentiated with a varied width of canopy and are recessed 3'-1" into the façade. Lighting at each entry will mark them at night, and future tenant signage will be located in the vicinity of each entry. The intent for signage is illustrated on exhibit A-004.

Along the new Local Street, scale, interest, and activity is provided with an urban typology of ground-level residences and entry patios. Eight units are proposed, and each is entered from the street directly. The finish floor of all the units is raised 2 feet above the adjacent sidewalk to provide vertical separation from the public right-of-way. The units are set back 8'-11" from the sidewalk, and layered buffering of varied planting and 6'-6" deep private patios add to the livability and the pedestrian experience. An additional layer of 18" at-grade planting is provided within the right-of-way building zone. All units are provided with individual entry stairs, unit identification plaques, and entries recessed 1-foot into the façade for differentiation. Lighting is provided at each stair, and each entry door which is illustrated on A-021. The project is pursuing green building certification through the Green Globes program.

Therefore, the criteria are met.

Cont'd
4.132(.06)M.

2. *Design Standards:*
[a.] *All buildings, including parking garages, shall comply with the following design standards. Building facade windows are required on all street-facing facades (see Figure 7), as follows:*

<i>Ground Story: Mixed Use and Non-Residential</i>	<i>60% of facade</i>
<i>Upper Stories: Mixed Use</i>	<i>30% of facade</i>
<i>Ground Story: Residential Only</i>	<i>30% of facade</i>

Response: The street-facing facades of the building are along the new northeast Local Street, Park Place to the southeast, and a portion along Town Center Loop. These three facades are illustrated in Building Façade and Window Area Diagrams on drawing A-205.

The ground floor along the northeast façade provides 38% glazing at the portion adjacent to ground floor residential, and 60% at the portion adjacent to commercial space and the design exceeds the requirement for both. The upper floor facades provide 30% glazing and meet the requirement.

At the southeast façade along Park Place, the ground floor is entirely commercial use, and 60% glazing is provided. The upper floor facades along Park Place provide 30% glazing and meet the requirement.

Along Town Center Loop, the ground floor façade is a combination of commercial space, and parking or building service screening. At the portion adjacent to commercial space, 60% glazing is provided and meets the requirement. At the portion adjacent to building service and parking, 60% of the wall area is proposed as a metal screening to buffer the parking and provide visual interest to pedestrians. Upper floors of this façade provide 30% glazing and meet the requirement.

Therefore, the criteria are met.

Cont'd
4.132(.06)M.

[a.] ii. Required windows shall be clear glass and not mirrored or frosted, except for bathrooms. Clear glass within doors may be counted toward meeting the window coverage standard.

Response: Proposed areas of Building Façade Windows are illustrated in diagrams on sheet A-205. All windows and door counted towards the standard are noted as clear glass.

Therefore, the criterion is met.

Cont'd
4.132(.06)M.

[a.] iii. Ground floor windows. All street-facing elevations within the building setback (zero to 20 feet) along public streets shall include a minimum of 60 percent of the ground floor wall area with windows, display areas or doorway openings. The ground floor wall area shall be measured from two feet above grade to ten feet above grade for the entire width of the street-facing elevation. The ground floor window requirement shall be met within the ground floor wall area and for glass doorway openings to ground level. Up to 50 percent of the ground floor window requirement may be met on an adjoining elevation as long as the entire requirement is located at a building corner.

Response: As the previous response to 4.132(.06) M.2.a. states, ground floor windows are illustrated on A-205. All three street-facing facades meet or exceed the 60% requirement, measured for the wall and glazing area between two feet and ten feet above grade. The full area of storefront windows, and the glass lights within doors, are counted towards the standard.

Cont'd
4.132(.06)M.

[a.] iv. Street-facing facades that contain vehicle parking, such as a parking structure, do not have to provide windows but shall provide facade openings that meet the minimum

required window area. If required facade openings do not contain glass, they may contain architectural elements that are no more than 30 percent sight-obscuring.

Response: As the previous response to 4.132(.06) M.2.a. states, ground floor windows are illustrated on A-205. The ground floor windows requirement for the portion of the southwest façade which is adjacent to vehicle parking is met with a metal screen in lieu of windows. Precedent images on A-900 illustrate the intent.

Cont'd
4.132(.06)M.

[b.] Building Facades:

i. Facades that face a public street shall extend no more than 50 feet without providing at least one of the following features: (a) a variation in building materials; (b) a building offset of at least one foot; (c) a wall area that is entirely separated from other wall areas by a projection, such as an arcade; or (d) by other design features that reflect the building's structural system (See Figure 8). No building façade shall extend for more than 250 feet without a pedestrian connection between or through the building (see Figure 11).

Response: The proposed building facades are illustrated on drawings A-200 and A-201. The building facades face streets at the southeast along Park Place, and the northeast along the new Local Street. A portion of the building façade also fronts the southwest along Town Center Loop at the intersection with Park Place.

The upper floors of all building facades are differentiated in material and set back from the ground-level façade in varying distances of 1.25 feet, 6 feet, and 7 feet. The upper facades are articulated with a rhythm of 4-foot wide fiber cement piers and varied-width windows which vary to represent the unit and room types inside. An accent panel and material change is provided at the side of windows to provide additional visual interest and meet the criterion b.i.(a.). Additionally, stacks of recessed balconies break the building facades at the northeast and at the southeast street-facing facades.

The ground-level façade facing Park Place is 142'-3" long overall and is articulated with a rhythm of wide storefront windows, and retail entry doors. Each of the three retail entries is 7'-6" wide, and is recessed 3'-6" from the primary façade plane. The storefront windows are each 16'-0" wide, and recessed 1'-0" from the primary façade plane. The primary façade walls between the storefront and door openings vary between 4 feet and 7 feet wide. The upper floors of the building façade facing Park Place is set back 7 feet from the ground-level and is 130'-3" in total length. The façade is articulated by two recessed stacks of balconies which are each 6 feet wide and 4 feet deep. The recessed stacks break the overall façade into façade planes of 46'-6", 26'-1", and 46'-6" widths. Therefore the criterion is met on the Park Place facing façade.

A 67'-6" long portion of the building directly faces Town Center Loop at the south corner of the site. The remainder of the building façade is 62'-0" back from the street and is not considered street facing.

The upper floors are setback 6 feet from the ground-level façade. The overall ground-level façade length is 80'-11", and the façade is articulated in a similar rhythm to the Park Place facade width varied width storefront windows recessed 1'-0" into primary façade planes. The maximum width of unarticulated façade between the recesses is 7'-0", therefore the criterion is met for the ground-level façade. The upper floors façade is 67'-6" long, and is articulated by a rhythm of varied width windows and piers representing the units and function of rooms inside.

An accent panel material change occurs at the left side of each window and add further visual interest to the overall façade. The maximum distance of a single material on this façade is 4'-0", therefore the criterion is met at the upper floors of the applicable Town Center Loop façade.

The northeast façade facing the new Local Street is 230'-4" in total length, and the façade is articulated with a similar rhythm of 4-foot wide panels, windows, and accent panels as the upper floors facing Park Place. This façade is further articulated with 7'-0" wide recessed balcony stacks, which run from the second floor through the parapet and are open to the sky. This effectively breaks the massing from the pedestrian point of view, and creates roughly a 40-foot rhythm of separated massings while using a consistent architectural language. The ground floor is articulated from the upper floors through a stepback at the second floor at the retail and residential lobby, and through raised residential stoops, entry stairs, and front doors to ground-level units.

Cont'd
4.132(.06)M.

[b.] ii. Buildings more than three stories are required to step back six feet from the building facade at the beginning of the fourth story.

Response: The proposed building step back is illustrated on drawings A-300, A-200, and A-201. The street-facing facades are the southeast along Park Place, the northeast along the new Local Street, and a portion of the building along Town Center Loop. The building is 5 stories tall, with the required upper stories setback at street facing facades occurring at the second floor. The applicant has requested a Development Waiver to this criterion in the Anticipated Waivers section of this narrative.

Cont'd
4.132(.06)M.

- c. Weather Protection (for non-residential and mixed-use buildings):
 - I. A projecting facade element (awning, canopy, arcade, or marquee) is required on the street-facing façade. Within the MSD sub-district, weather protection shall be provided across the entire length of the building frontage.
 - II. All weather protection must comply with the Oregon Structural Specialty Code in effect at the time of application for projections or encroachments into the public right-of-way.
 - III. Weather protection shall be maintained and in good condition.
 - IV. Marquees shall have a minimum ten-foot clearance from the bottom of the marquee to the sidewalk. Canopies and awnings shall have a minimum eight-foot clearance from the bottom of the awning or canopy to the sidewalk.
 - V. The projecting façade element shall not extend into amenity zone or conflict with street lights. If the projecting façade element blocks light shed from adjacent street lights, exterior lighting shall be located on the building.
 - VI. Awnings shall match the width of storefronts or window openings.
 - VII. Internally lit awnings are not permitted.
 - VIII. Awnings shall be made of glass, metal, or a combination of these materials. Fabric awnings are not permitted.

Response: The proposed building facades are illustrated on drawings A-200, and A-201. The building facades face streets at the southeast along Park Place, and the northeast along the new Local

Street. A portion of the building façade also fronts the southwest along Town Center Loop at the intersection with Park Place.

Steel canopies are provided at the primary retail frontage at all storefront window and retail entry openings along the Park Place frontage. The canopies are 11'-6" above the sidewalk, extend into the right-of-way by 5'-0", and are the full width of each storefront or retail entry opening. The canopies are continued around the south corner along Town Center Loop for the portion of the façade adjacent to commercial use. A single canopy is provided on the new northeast Local Street at the primary residential building entry. The remainder of the ground-level façade is residential use. Each of the ground-level residences at the northeast are provided weather protection by being recessed 2'-0" from the walls above. Therefore criterion c.i. is met.

All canopies comply with the anticipated adopted 2022 edition of the Oregon Structural Specialty Code Chapter 32 Encroachments Into The Public Right-Of-Way. This code section requires canopies and other similar encroachments to be 8 feet or more above grade, and canopies between 8 feet and 15 feet above grade shall not extend into the R.O.W. more than two-thirds the width of the sidewalk. The sidewalk on all abutting streets is 12'-0" and therefore an encroachment of 8 feet is allowed for canopies so long as they are 8 feet above the sidewalk. The proposed canopies encroach into the right-of-way by 5 feet and are 11.5 feet above the sidewalk. Therefore, the criteria c.ii., and c.iv. are met. The amenity zone for each surrounding 12'-0" sidewalk will be 7.5' from the building face, therefore the 5 foot encroachment will not be in the amenity zone and criterion c.v. is met.

No awnings are proposed on the project, therefore criteria c.iv, c.vi, c.vii, and c.viii are not applicable.

Cont'd
4.132(.06)M.

d. Building Materials. Plane concrete block, plain concrete, T-111 or similar sheet materials, corrugated metal, plywood, sheet press board or vinyl siding may not be used as exterior finish materials. Foundation material may be plain concrete or plain concrete block where the foundation material is not revealed for more than two feet. Use of brick and natural materials (wood) is encouraged.

Response: The proposed building facades are illustrated on drawings A-200, A-201, and renderings and materials are shown on A-900.

Primary exterior building materials are fiber cement panels, linear architectural brick, metal composite panels, and architectural concrete stem-walls and site walls at the ground. Composite wood siding and metal composite panels are utilized as accent materials. Window openings are constructed of commercial-grade vinyl windows at the upper floors, and commercial grade aluminum storefront at the ground-level. All openings are flashed with pre-finished steel flashings and trim. Plain concrete is proposed at portions of the foundation; however it is not revealed for more than two feet and is largely located in the tuck-under parking area and away from the pedestrian rights-of-way.

Therefore, the criterion is met.

Cont'd
4.132(.06)M.

e. Roofs and roof lines. Except in the case of a building entrance feature, roofs shall be designed as an extension of the primary materials used for the building and should respect

the building's structural system and architectural style. False fronts and false roofs are not permitted.

Response: The proposed building facades and roof lines are illustrated on drawings A-200, A-201.

The proposed design employs a low-slope roof structure with a flat parapet at Level 2 and at the Roof level. This is consistent with the modern and urban architectural style, and common in multi-story, urban, multifamily buildings of all eras. No false fronts or false roofs are proposed. Parapets extend beyond the structural roof deck and are limited to the height necessary to capture roofing insulation and terminate roofing with standard construction practices.

Therefore, the criterion is met.

Cont'd
4.132(.06)M.

- f. Rooftop features/equipment screening:
 - i. The following rooftop equipment does not require screening:
 - a. Solar panels, wind generators, and green roof features;
 - b. Equipment under two feet in height.
 - ii. Elevator mechanical equipment may extend above the height limit a maximum of 16 feet provided that the mechanical shaft is incorporated into the architecture of the building.
 - iii. Satellite dishes and other communications equipment shall be limited to ten feet in height from the roof, shall be set back a minimum of five feet from the roof edge and screened from public view to the extent possible.
 - iv. All other roof-mounted mechanical equipment shall be limited to ten feet in height, shall be set back a minimum of five feet from the roof edge and screened from public view and from views from adjacent buildings.
 - v. On all structures exceeding 35 feet in height, roofs shall have drainage systems that are architecturally integrated into the building design.
 - vi. Any external stairwells, corridors and circulation components of a building shall be architecturally compatible with the overall structure, through the use of similar materials, colors, and other building elements.
 - vii. Required screening shall not be included in the building's maximum height calculation

Response: Rooftop features are shown on A-106 and include: an elevator overrun; a fire-access roof hatch; rooftop mechanical units for the residential corridors and common spaces; and mechanical units for up to four future commercial tenants. The applicant has also illustrated the zones that solar panels may be installed if it becomes beneficial to the development in the future. Cut sheets of all roof-top equipment has also been provided on A-106 to illustrate anticipated heights.

The solar panels would not require screening if installed, therefore, if installed they will be meet the standard.

The elevator overrun is dimensioned 4'-8" beyond the building parapet, and is less than the allowed 16 feet of projection. The overrun is set back 22'-6" from the parapet along the

northeast Local Street, and 36'-1" from Park Place parapet.. Therefore, it meets the screening criteria.

Cut sheets for rooftop mechanical equipment on A-106 show that no mechanical equipment will exceed 10 feet in height, and locations of the equipment are set back greater than 5' from the parapet. Therefore, all mechanical equipment meets the criteria.

Internal roof drains are shown in the center of the floor plate on A-106, and run vertically through the inside of the building to underground storm utilities onsite.

There are no external stairwells, corridors, or circulation components.

Cont'd
4.132(.06)M.

g. General Screening. Utility meters shall be located on the back or side of a building, screened from view from a public street to the greatest extent possible, and shall be painted a color to blend with the building façade.

Response: Electrical meters will be installed within the enclosed main electrical room, as located on a-000 and A-101. They will be inside the building, and not visible from public streets and accessed through the parking area.

Gas meters are located behind metal screens within the façade articulation along Town Center Loop and accessed through the parking area. A gas regulator is located just northwest of the meters and outside of the shadow of the building as required by the gas company. The regulator is concealed from the adjacent sidewalk and right-of-way by landscape, and by an exterior 'wing wall' which also screens the parking.

Cont'd
4.132(.06)M.

h. Primary Entry.

i. For commercial/institutional/mixed-use buildings:

- *At least one entry door is required for each business with a ground floor frontage.*
- *Each entrance shall be covered, recessed, or treated with a permanent architectural feature in such a way that weather protection is provided.*
- *All primary ground-floor common entries shall be oriented to the street or a public space directly facing the street, or placed at an angle up to 45 degrees from an adjacent street. Primary ground-floor common entries shall not be oriented to the interior or to a parking lot.*
- *Courtyards, plazas and similar entry features may be utilized to satisfy the building entrance requirement when these features are designed to connect the adjacent street edge to the main building entrance.*

Response: The proposed building entries are illustrated on drawing A-000 Land Use Site Plan. The proposal is a mixed-use building of multi-family residential and commercial tenant space. Up to three commercial tenants are anticipated within the ground-floor adjacent to Park Place. 7'-6" wide entries to each future tenant are oriented towards Park Place and are recessed 3'-6" so that door swings do not conflict with the public right-of-way. The primary residential entry is located along the new northeast Local Street, and is oriented towards the street and setback for weather protection. Therefore, the criteria are met.

Cont'd
4.132(.06)M.

i. Building projections. Building projections are allowed as follows (see Figure 9):

- I. Architectural elements such as eaves, cornices and cornices may project up to one foot from the face of the building.
- II. Bay windows and balconies may project up to four feet from the face of the building. Balconies that project into the right-of-way shall have a minimum vertical clearance of 12 feet from sidewalk grade or be mounted at the floor elevation, whichever is greater.
- III. See also Subsection 4.132(.06)M.2.C. for standards related to weather protection.

Response: The criteria apply to projections into the right-of-way. The only proposed building projections or encroachments into the right-of-way are steel canopies located along Park Place, and the eastern portions of Town Center Loop, and the new northeaster Local Street. While several projecting balconies are proposed, none project into the right-of-way due to the upper floor step back. Steel canopies at the ground-level project 5 feet beyond the face of building and into the rights-of-way. Each canopy is located 11'-6" above the sidewalk, exceeding the allowable 8'-0" minimum for canopies allowed in Figure 9. Criterion iii. is met in the narrative response to 4.132(.06)M.2.C. above. Therefore, the criteria are met.

4.132(.06)N.

N. Off Street Parking and Loading. Parking standards are identified in Section 4.155.

Response: See the written response to the criteria of Section 4.155 in later pages.

4.132(.06)O.

O. Parking within a Building or Structure:

- 1. *Parking structures shall be designed to allow reuse of the building for non-parking uses, such as office or residential uses.*

Response: All proposed parking is illustrated on A-000 Land Use Site Plan, and includes open-air tuck-under, and surface parking on-site. No parking is proposed within a building or structure. Therefore, the criterion is not applicable.

4.132(.06)P.

P. Street Connectivity:

3. Transportation Facility Standards:

- a. *Intersection design and spacing:*
 - i. *Transportation facilities shall be designed and constructed in conformance to the applicable section of the City Development Code and to the City's Public Works Standards.*
 - ii. *Street intersections shall have curb extensions to reduce pedestrian crossing distances unless there are other standards that apply, such as areas with flush curbs.*
 - iii. *New street intersections, including alleys, are subject to approval by the City Engineer.*

Response: All proposed street alignments and design standards are in compliance with the Town Center Plan and associated appendices. The project includes work on one side of the street at two

intersections: Park Place and Town Center Loop; and Park Place and the new northeastern Local Street. Park Place is to be reconstructed in the future into a pedestrian-oriented woonerf or Promenade as described in IN.10 in the Town Center Plan. No design is provided currently. Therefore, it is not possible to provide curb extensions of the pedestrian crossing at either intersection. The project provides right-of-way dedications at Park Place and Town Center Loop to provide a 12-foot-wide sidewalk at each street, measured from the existing curb. This provides the ability for the future road construction to allow pedestrian crossing extensions to be built.

Cont'd
4.132(.06)P.

b. Transportation network connectivity:
i. Minimum required transportation improvements are identified in the Wilsonville Town Center Plan. Alleys are encouraged but not required. Private streets are prohibited.

Response: Transportation improvements are provided in compliance with the Town Center Plan documents. No alleys or private streets are proposed.

Cont'd
4.132(.06)P.b.

b. ii. Bicycle and pedestrian connections are required where the addition of a connection would link the end of a permanent turnaround to an adjacent street or provide a midblock connection through a long block. A mid-block connection is required where at least one block face is 400 feet or more in length (see Figure 11). A required connection must go through the interior of the block and connect the block face to its opposite block face. The mid-block crossing shall be demarcated with paving, signage, or design that clearly demarcates the crossing is designated for pedestrian and bicycle crossings.

Response: As illustrated on exhibit A-000, Land Use Site Plan, the longest resulting frontage is 239 feet along the new northeast Local Street. Therefore, no connection longer than 400 feet is created, and the criterion is not applicable.

Cont'd
4.132(.06)P.b.

iii. Streets shall be extended to the boundary lines of the proposed development where necessary to give access to or allow for future development of adjoining properties.

- Any required or proposed new streets through or along the boundary of the proposed development shall be accompanied by a future street plan. The future street plan shall show that it is feasible to extend all required or proposed new streets onto adjoining properties to the satisfaction of the City Engineer.*
- Temporary turnarounds shall be constructed for street stubs in excess of 150 feet in length.*
- Street stubs to adjoining properties shall not be considered permanent turnarounds, unless required and designed as permanent turnarounds, since they are intended to continue as through streets when adjoining properties develop.*
- Reserve strips may be required in order to ensure the eventual continuation or completion of a street.*

Response: Proposed streets are illustrated on exhibit A-000, Land Use Site Plan. All three streets (Town Center Loop, Park Place, and a new Local Street) extend completely up to the proposed

property lines, and align with future locations for those streets as illustrated in the Town Center Plan documents. Therefore, this criterion is met.

Cont'd
4.132(.06)P.b.

iv. Permanent dead end streets are not allowed except where no opportunity exists for creating a through street connection. Dead end streets shall meet all fire code access requirements and shall only be used where topographical constraints, protected natural resource areas, existing development patterns, or strict adherence to other City requirements precludes a future street connection. The lack of present ownership or control over abutting property shall not be grounds for a dead end street.

Response: Existing streets are illustrated on G-102 Survey, and proposed streets are illustrated on drawing A-000 Land Use Site Plan. Street function on Park Place and Town Center Loop will remain. An existing access easement for the northeast portion of the site, and the adjacent property to the northwest, are to become a new Local Street right-of-way per the Wilsonville Town Center Plan documents. This proposal dedicates a portion of the northeast frontage to provide an interim, functioning Local Street and maintain through-way public access to the neighboring lot. No permanent dead end streets will result from the proposal, and existing traffic patterns are maintained or improved. Therefore, the criterion is met.

Cont'd
4.132(.06)P.b.

v. Street design. All streets are subject to the standards illustrated in the Wilsonville Town Center Plan.

Response: Figure 2 Street Network shows Town Center Loop bordering the south corner and southwestern edge of the site, and is designated as an 'Existing, Local Street'. Park Place borders the southeaster edge, and is outlined, however is given no designation of Street Hierarchy. New 'Local Street(s)' are shown as Proposed along the northeastern, and northwestern borders of the site. Figure 3 Multimodal Network overlays open space, and pedestrian and bike system information over the Street Network of Figure 2. Park Place is shown as a Proposed Open Space and Proposed Multi-Use Path. Town Center Loop is shown as a Proposed Cycle Track (2-way). In the Wilsonville Town Center Plan, project IN.8 Town Center Loop W Modifications, and the associated Appendix D document reference a cross-section for 'Local Street Option 2', with a 60-foot overall right-of-way, with 12-foot sidewalks. This 'Local Street Option 2' cross-section also illustrates the intent for the new local streets at the northeast and northwest site boundaries. Infrastructure project 'IN.10 Park Place Promenade Redesign references that Park Place will become a pedestrian-oriented linear park feature, and references the 'Woonerf-style local street cross-section' in Appendix D. The 'Local Street Option 3' cross-section in Appendix D shows a woonerf-style shared roadway section, with a 54-foot right-of-way, with a 12-foot sidewalk, and 14-foot sidewalk. Table 5.1 states that IN.10 Park Place Promenade Redesign will occur in the medium and long-range timeline. Drawing A-000 Land Use Site Plan illustrates the proposed street and right-of-way improvements in the project. The proposal maintains the existing curb along Town Center Loop, and provides a 6.75-foot right-of-way dedication in order to provide a 12 foot-wide sidewalk for the entire southwestern site edge. This is consistent with the project description 'IN.8 Town Center Loop W Modifications', and the 'Local Street Option 2' street section.

The proposal maintains the existing curb along Park Place, and provides a 2.17-foot right-of-way dedication to allow a 12-foot wide sidewalk for the entire southeaster frontage. This is consistent with the 'Local Street Option 3' cross-section and allows for the future project IN.10 Park Place Promenade Redesign.

Cont'd A partial new 'Local Street' is provided in the proposal along the northeastern site edge. The applicant has received preliminary approval from City staff to provide a functional interim street section in lieu of the 60-foot right-of-way shown in Appendix D until neighboring lots are developed. The proposed 37-foot right-of-way dedication allows a 20-foot two-way drive aisle, measured from an existing northeast curb, and a 12-foot sidewalk. Planted stormwater facilities are provided within the amenity zone of the sidewalk to accommodate runoff from the new Local Street. Future neighboring development will be required to dedicate property and construct the remaining 23 feet of on-street parking, asphalt, restriping, and sidewalk to complete the 60-foot right-of-way illustrated in the 'Local Street Option 2' cross-section. The proposed modification is consistent with the intent of the Appendix D. The applicant has received preliminary approval from City Staff to provide a partial Pedestrian and Bicycle Connection in lieu of a new Local Street along the northwest site edge connecting Town Center Loop to the new Local Street at the northeast. The proposal provides a 15-foot dedication for the entire northwestern edge between the existing neighboring drive-through facility and planting. A 6-foot pedestrian path, and 9-feet of landscaped planting zone provide functional interim pedestrian and bicycle connection until the neighboring lot is redeveloped and completes the anticipated 30-foot wide right-of-way. The proposed right-of-way improvements are consistent with the street classifications and cross-sections in Figure 2, Figure 3, The Wilsonville Town Center Plan, and Appendix D. Therefore, the criterion is met.

Cont'd
4.132(.06)P.b.

vi. Street trees shall be required along all street frontages. The minimum number of required street trees shall be determined by dividing the length (in feet) of the proposed development's street frontage by 30 feet. When the result is a fraction, the number of street trees required shall be the nearest whole number.

Response: All bounding streets are classified as Local Streets in the plan. The frontage for the new northeast Local Street is 239'-1" and requires 8 trees. The proposal provides 8 trees and meets the requirement. The frontage along Park Place is 145'-4" and requires 5 trees at 30 feet. The proposal provides 4 trees spaced at 30 feet, 1 less than the requirement but complying with the spacing standard. The Wilsonville Town Center Streetscape Plan document allows 30-40-foot range for Local Streets. Therefore, the criterion is met along Park Place. The frontage along Town Center Loop is 203.75 feet and requires 7 trees at 30 feet. The proposal provides 6 trees roughly at 30 feet spacing and meets the spacing required in the TC Streetscape Plan. Therefore, the criterion is met along Town Center Loop.

Cont'd
4.132(.06)P.b.

x. Sidewalks shall have a minimum unobstructed width of six feet for pedestrian through travel. Permanent structures or utilities within the required pedestrian through-travel area are restricted unless approved by the City Engineer. Sidewalk area outside of the required through-travel area may be used for landscaping, pedestrian amenities such as permanent street furniture, bicycle parking, trash cans, and drinking fountains.

Response: Proposed sidewalks are illustrated on drawing A-000 Land Use Site Plan and L-200 Materials Plan. 12-foot sidewalks are provided at Town Center Loop, Park Place, and the new northeast Local Street. Each sidewalk comprises a 6-foot pedestrian walkway; a 4 foot amenity zone and 6 inch curb; and a 1.5 foot building zone. Proposed street trees and landscaped areas are located within the amenity and building zones and clear of the pedestrian path. Site furnishings such as benches and trash cans are also shown within the amenity zone. A 7-foot-wide clear pedestrian path is shown within the west Pedestrian Accessway dedication. Planted areas are provided on either side with no site furnishings proposed. Therefore, the criterion is met.

Cont'd
4.132(.06)P.b.

xi. Temporary placement of customer seating, merchandise display, temporary A-frame signs or other uses by businesses adjacent to the street shall be placed within the amenity or building zone in front of the business (see Figure 12). The building zone may be extended into the pedestrian zone in front of the building if a minimum of four feet is provided for the pedestrian through area. Placement of any temporary uses requires a temporary right-of-way use permit and approval by the City Engineer.

Response: Temporary customer seating and merchandise display or temporary signage will be submitted with future commercial tenant improvement permits. Proposed intent for permanent and building-mounted signage is included in this application under a Class 3 Sign Permit. Therefore, the criterion is not applicable.

Cont'd
4.132(.06)P.b.

xii. Temporary signs, such as A-Frames, are permitted within Town Center provided the temporary sign meets the following standards:

- One temporary sign is allowed per public entrance to buildings.*
- Temporary signs may be up to 12 square feet in area. Only one side of a portable sign will be counted. The vertical dimension of the sign including support structure may be no greater than 42 inches.*
- Signs may be placed in front of the building only during business hours.*
- Electrical signs and changing image sign features are prohibited.*

Response: Temporary signage will be submitted with future commercial tenant improvement permits. Proposed intent for permanent and building-mounted signage is included in this application under a Class 3 Sign Permit. Therefore, the criterion is not applicable.

Cont'd
4.132(.06)P.b.

xi. Off street paths shall meet the City's path standards identified in the Transportation system plan, unless noted otherwise in the Wilsonville Town Center Plan. The location and type of facility shall be consistent the trail and open space, and street cross section illustrated in the Wilsonville Town Center Plan. Trail widths may be reduced where constrained by existing development, protected natural resource areas, or topography as determined by the City Engineer.

Response: An off-street path is proposed within the western Pedestrian Accessway right-of-way dedication as illustrated on A-000 Land Use Site Plan. The proposed Pedestrian Accessway includes a 7-foot-wide pedestrian path connecting the sidewalk at Town Center Loop to the new sidewalk at the northeast Local Street. Therefore, the criterion is met.

Section 4.154 On-site Pedestrian Access and Circulation**4.154(.01).B**

B. Standards. Development shall conform to all of the following standards:

1. Continuous Pathway System. A pedestrian pathway system shall extend throughout the development site and connect to adjacent sidewalks, and to all future phases of the development, as applicable.

Response: The proposal is a single-phase development, and the pedestrian pathway system is illustrated on drawing A-000 Land Use Site Plan. The project is bounded on all sides by two existing rights-of-way, and two rights-of way which are being dedicated and built as part of the project. All rights-of-way bounding the site include pedestrian sidewalks and pathways complying with the Town Center Plan and including, at minimum, and 6-foot-wide clear pedestrian pathway. All sidewalks are connected directly to one another. All building entrances are directly oriented and adjacent to the bounding sidewalks, therefore the criterion is met.

4.154(.02).B

2. Safe, Direct, and Convenient. Pathways within developments shall provide safe, reasonably direct, and convenient connections between primary building entrances and all adjacent parking areas, recreational areas/playgrounds, and public rights-of-way and crosswalks based on all of the following criteria:

- a. Pedestrian pathways are designed primarily for pedestrian safety and convenience, meaning they are free from hazards and provide a reasonably smooth and consistent surface.*
- b. The pathway is reasonably direct. A pathway is reasonably direct when it follows a route between destinations that does not involve a significant amount of unnecessary out-of-direction travel.*
- c. The pathway connects to all primary building entrances and is consistent with the Americans with Disabilities Act (ADA) requirements.*
- d. All parking lots larger than three acres in size shall provide an internal bicycle and pedestrian pathway pursuant to Section 4.155(.03)B.3.d.*

Response: Pedestrian pathways and grading are illustrated on drawings A-000 Land use Site Plan, and C-200 Grading Plan. The proposal is bound on all sides by three sidewalks and a pedestrian accessway, each of which includes a minimum 6-foot-wide clear pedestrian pathway. The primary residential building entry is located along the new northeast Local Street and is immediately adjacent to the sidewalk and right-of way. C-200 notes that a 1.5% maximum slope is maintained from the building entry to the sidewalk, complying with ADA requirements. Secondary entries to each commercial tenant space are located immediately adjacent to the sidewalk at Park Place and are also limited to 1.5% slope. The proposal includes eight ground-floor residential units along the northeast Local Street which are accessible only from exterior entry doors at each unit. The finish floor of these units is raised 28 inches above the adjacent sidewalk. A shared ramp is provided at the north corner of the site, providing ADA-compliant accessibility to the units, and creating residential stoops as well. The proposal includes two ADA-accessible parking stalls within the on-site parking lot. These are graded with a maximum 1.5% slope on C-200, and an accessible path is provided from the access aisle between the stalls directly to the secondary residential entry. Therefore, the criterion is met.

4.154(.01)B.

3. *Vehicle/Pathway Separation. Except as required for crosswalks, per subsection 4, below, where a pathway abuts a driveway or street it shall be vertically or horizontally separated from the vehicular lane. For example, a pathway may be vertically raised six inches above the abutting travel lane, or horizontally separated by a row of bollards.*

Response: Relevant data is illustrated on A-000 Land Use Plan, C-200 Grading Plan, and L-200 Materials Plan. The proposed project is bounded on three sides by rights-of-way comprising 12-foot-wide sidewalks, and one frontage by a 15 foot wide dedication and Pedestrian Accessway. The pedestrian pathways surrounding the site are within 12-foot-wide sidewalk construction which abut vehicular lanes at Town Center Loop, Park Place, and the new northeast Local Street. At these frontages, the 6-foot-wide pedestrian pathway is separated by vehicular streets by the 4 foot wide amenity zone of the sidewalk, and a 6 inch curb which is raised 6 inches above the vehicular street. Therefore, the criterion is met.

4.154(.01)B.

4. *Crosswalks. Where a pathway crosses a parking area or driveway, it shall be clearly marked with contrasting paint or paving materials (e.g., pavers, light-color concrete inlay between asphalt, or similar contrast).*

Response: The proposal includes one accessible pathway which crosses a drive aisle within the tuck-under portion of the on-site parking. This is illustrated on A-000 Land Use Site Plan and connects the access aisle between the two accessible van and car parking stalls to the building lobby entry from the parking lot. A-000 illustrates that this pathway will be marked with contrasting paint and lit with emergence egress lighting as required by the OSSC code. Therefore, this criterion is met.

4.154(.01)B.

5. *Pathway Width and Surface. Primary pathways shall be constructed of concrete, asphalt, brick/masonry pavers, or other durable surface, and not less than five feet wide. Secondary pathways and pedestrian trails may have an alternative surface except as otherwise required by the ADA.*

Response: Pedestrian pathways locations and dimensions are illustrated on drawing A-000; materials are illustrated on L-200; and grading is illustrated on C-200. Primary pathways are situated within the three sidewalks and one pedestrian accessway rights-of-way which bound the site. The three 12-foot-wide sidewalks include a 6 foot wide concrete sidewalk meeting the streetscape design standards of the Town Center Plan. The pedestrian accessway includes a 7-foot-wide concrete pathway which is scored with as similar pattern as the 12 foot wide sidewalks. Secondary pathways occur within the on-site parking area, which is noted on L-200 as asphalt surfacing. Therefore, the criterion is met.

4.154(.01)B.

6. *All pathways shall be clearly marked with appropriate standard signs.*

Response: All code-required signs will be provided and clearly marked and submitted with drawings and specifications during building permit review.

Section 4.155 General Regulations – Parking, Loading, and Bicycle Parking**4.155(.02)A.**

A. *The provision and maintenance of off-street parking spaces is a continuing obligation of the property owner. The standards set forth herein shall be considered by the Development Review Board as minimum criteria.*

1. *The Board shall have the authority to grant variances or planned development waivers to these standards in keeping with the purposes and objectives set forth in the Comprehensive Plan and this Code.*
2. *Waivers to the parking, loading, or bicycle parking standards shall only be issued upon a finding that the resulting development will have no significant adverse impact on the surrounding neighborhood, and the community, and that the development considered as a whole meets the purposes of this section.*

Response: The proposal anticipates no variances or development waivers to the parking, loading, or bicycle parking standards. The applicant has been directed by City staff that minimum off-street parking will not be mandatory in accordance with state law and the implementation of the Climate-Friendly and Equitable Communities (CFEC) legislation. The applicant is providing off-street parking for residents at a ratio of 0.46 stalls to 1 unit to meet the anticipated market demand for residential units.

4.155(.02)B.

B. *No area shall be considered a parking space unless it can be shown that the area is accessible and usable for that purpose, and has maneuvering area for the vehicles, as determined by the Planning Director.*

Response: Parking spaces and drive aisles are illustrated and dimensioned on drawing A-000 Land Use Site Plan. Standard parking stalls are dimensioned 9 feet wide and 18 feet deep meeting the definition in Section 4.001. Compact parking stalls are dimensioned 8 feet wide and 16 feet deep and exceed the requirements in Section 4.001. Two accessible stalls (one van and one car) are each 9 feet wide by 18 feet deep, with an 8-foot-wide access aisle between. These dimensions meet the requirements in OSSC Chapter 11. Two-way drive aisles provide access and maneuvering to all parking spaces and vary from 20 feet wide to 22 foot 2 inches wide.

4.155(.02)C.

C. *In cases of enlargement of a building or a change of use from that existing on the effective date of this Code, the number of parking spaces required shall be based on the additional floor area of the enlarged or additional building, or changed use, as set forth in this Section. Current development standards, including parking area landscaping and screening, shall apply only to the additional approved parking area.*

Response: No enlargement of a building or change of existing use is proposed. The criterion is not applicable.

4.155(.02)D.

D. *In the event several uses occupy a single structure or lot, the total requirement for off-street parking shall be the sum of the requirements of the several uses computed separately, except as modified by subsection "E," below. Within the TC Zone, the cumulative number of parking spaces required by this subsection may be reduced by 25 percent.*

Response: This criterion is met per the response to 4.155(.03) below

4.155(.02)E.

E. Owners of two or more uses, structures, or lots may utilize jointly the same parking area when the peak hours of operation do not overlap, provided satisfactory legal evidence is presented in the form of deeds, leases, or contracts securing full and permanent access to such parking areas for all the parties jointly using them.

Response: No shared parking agreement is proposed with this application. Therefore, the criterion is met.

4.155(.02)F.

F. Off-street parking spaces existing prior to the effective date of this Code may be included in the amount necessary to meet the requirements in case of subsequent enlargement of the building or use to which such spaces are necessary.

Response: No existing off-street parking spaces are proposed to be maintained with this application. Therefore, the criterion is not applicable.

4.155(.02)G.

G. Off-Site Parking. Except for single-family dwellings and middle housing, the vehicle parking spaces required by this Chapter may be located on another lot, provided the lot is within 500 feet of the use it serves and the DRB has approved the off-site parking through the Land Use Review. The distance from the parking area to the use shall be measured from the nearest parking space to the main building entrance, following a sidewalk or other pedestrian route. Within the TC Zone there is no maximum distance to an off-site location provided the off-site parking is located within the TC Zone. The right to use the off-site parking must be evidenced in the form of recorded deeds, easements, leases, or contracts securing full and permanent access to such parking areas for all the parties jointly using them. Within the TC zone, there is no maximum distance to an off-site location provided the off-site parking is located within the TC Zone.

Response: No shared parking agreement is proposed with this application. Therefore, the criterion is met.

4.155(.02)H.

H. The conducting of any business activity shall not be permitted on the required parking spaces, unless a temporary use permit is approved pursuant to Section 4.163.

Response: All parking spaces in the proposal are for residential use. Therefore, the criterion is not applicable.

4.155(.02)I.

I. Where the boundary of a parking lot adjoins or is within a residential district, such parking lot shall be screened by a sight-obscuring fence or planting. The screening shall be continuous along that boundary and shall be at least six feet in height.

Response: The boundary of the parking lot does not adjoin with a residential district. Therefore, the criterion is not applicable.

4.155(.02)J.

J. Parking spaces along the boundaries of a parking lot over 650 square feet in area, excluding access areas, shall be provided with a sturdy bumper guard or curb at least six

inches high and located far enough within the boundary to prevent any portion of a car within the lot from extending over the property line or interfering with required screening or sidewalks.

Response: The proposed parking lot is illustrated in drawing A-000 Land Use Site Plan. The parking area (including drive aisles) on-site is 16,317 square feet. Each parking space is provided a 6-inch-tall x 10 inch wide concrete bumper guard, located 2 feet from the nose of the parking space.

4.155(.02)K.

K. All areas used for parking and maneuvering of cars shall be surfaced with asphalt, concrete, or other surface, such as pervious materials (i. e. pavers, concrete, asphalt) that is found by the City's authorized representative to be suitable for the purpose. In all cases, suitable drainage, meeting standards set by the City's authorized representative shall be provided.

Response: The proposed site materials are noted in drawing L200 Materials Plan. The proposed parking area is noted as asphalt surface on drawing L200 Materials Plan, therefore the criterion is met.

4.155(.02)L.

L. Artificial lighting which may be provided shall be so limited or deflected as not to shine into adjoining structures or into the eyes of passers-by.

Response: Proposed outdoor lighting is illustrated on A-020. Tuck-under portions of the parking area are lighted by surface-mounted fixtures (fixture type L.4). Portions of the parking that are open to the sky are lighted with pole-mounted fixtures (fixture type L.1). Cut sheets for both fixture types are illustrated on A-021, and both have lighting angles which do not shine onto adjoining structures or rights-of-way. Therefore, the criterion is met.

4.155(.02)M.

M. Off-street parking requirements for types of uses and structures not specifically listed in this Code shall be determined by the Development Review Board if an application is pending before the Board. Otherwise, the requirements shall be specified by the Planning Director, based upon consideration of comparable uses.

Response: All proposed uses and structures are specifically listed in this Code. Therefore, the criterion is not applicable.

4.155(.02)N.

N. Up to 40 percent of the off-street spaces may be compact car spaces as identified in Section 4.001 - "Definitions," and shall be appropriately identified.

Response: The proposal provides 53 off-street parking stalls in an open-air and tuck-under parking lot. The allowable compact stalls is 21. The proposal contains 19 compact stalls. Therefore, the criterion is met.

4.155(.02)O.

O. Where off-street parking areas are designed for motor vehicles to overhang beyond curbs, planting areas adjacent to said curbs shall be increased to a minimum of seven feet in depth. This standard shall apply to a double row of parking, the net effect of which shall be to create a planted area that is a minimum of seven feet in depth.

Response: The proposed parking area is illustrated on drawing A-000 Land Use Site Plan. All parking stalls are provided wheel-stops mounted 2 feet from the nose of the parking stall, and designed so that vehicles will not overhang beyond the parking stall. Therefore, the criterion is met.

4.155(.02)P.

P. Parklets are permitted within the TC Zone on up to two parking spaces per block and shall be placed in front of the business. Placement of parklet requires a temporary right-of-way use permit and approval by the City Engineer.

Response: No parklets are proposed with this application. Therefore, the criterion is not applicable.

4.155(.02)Q.

Q. Residential garages shall not count towards minimum parking requirements unless all of the following criteria are met:

- 1. The garage contains an area, clear of any obstructions, equal to a standard size parking space (nine feet by 18 feet) for each counted parking space within the garage;*
- 2. Nine square feet is provided either in the garage or in a screened area of the lot per container provided by the franchise hauler (solid waste, recycling, yard debris, etc.) to ensure they are not placed in the parking spaces;*
- 3. A deed restriction is placed on the property requiring the space stay clear except for identified exceptions such as 30 days before and after a change of tenant or an equivalent restriction within the development's CC&R's;*

Response: No residential garages are proposed with this application. Therefore, the criterion is not applicable.

4.155(.02)R.

R. Public sidewalks, public sidewalk easements or other public non-vehicle pedestrian easement areas shall not be counted towards the area of parking spaces or used for parking.

Response: The proposed parking area is illustrated on A-000 Land Use Site Plan. All proposed parking spaces are off-street and no proposed parking spaces overlap the adjacent sidewalks or pedestrian areas. Therefore, the criterion is met.

4.155(.02)S.

S. Shared visitor parking in certain residential areas:

- 1. In order to provide visitor parking in non-multi-family residential areas with limited parking, lot size and/or required open space may be reduced equal to the area of standard-sized parking spaces as described in 2. below if all the following criteria are met:*
 - a. Ten percent or more of lots in the development do not have at least one adjacent on-street parking space that is at least 22 feet long.*
 - b. Shared parking spaces are within 250 feet of a lot without an on-street parking space.*

- c. Shared parking spaces will be owned by an HOA and have enforceable covenants in place to ensure spaces are managed for visitor parking and not storage of extra vehicles or overflow parking of residents. This may include time limits on parking, limits on overnight parking, or other similar limits.
- 2. When shared visitor parking is provided that meets the standards of 1. above, lot size or open space area for the development may be reduced as provided below. The same visitor parking spaces cannot be used to reduce both lot size and open space area. To achieve both reductions, adequate visitor parking space must be provided to offset both lot size and open space area reductions.
 - a. Individual lot size may be reduced by up to 2.5 percent of the minimum lot size for the zone to allow an equal area to be developed as shared parking, as long as the shared parking space is within 250 feet of the reduced lot.
 - b. Open space required under Subsection 4.113 (.01) may be reduced by up to 2.5 percent of gross development area (from 25 percent down to as low as 22.5 percent) to allow an area equal to the reduced open space as shared parking. No more than 50 percent of the reduced open space area may be from the required usable open space. In the RN zone, the ten percent Open Space requirement for Small-Lot Subdistrict may be reduced to eight percent.
 - c. In order to reduce stormwater runoff and the need for stormwater facilities, shared visitor parking areas are encouraged to be constructed of pervious surfaces.

Response: No on-street parking spaces are proposed in the application; therefore the criteria are not applicable.

4.155(.03)A.

- A. Parking and loading or delivery areas shall be designed with access and maneuvering area adequate to serve the functional needs of the site and shall:
 - 1. Separate loading and delivery areas and circulation from customer and/or employee parking and pedestrian areas. Circulation patterns shall be clearly marked.
 - 2. To the greatest extent possible, separate vehicle and pedestrian traffic.

Response: The proposed parking lot is illustrated on drawing A-000 Land Use Site Plan. The parking area is entirely for the residents of the building. The parking stalls are accessed via two-way drive aisles which vary in clear width from 20'-0" to 22'-2". BuildiFng entry is provided to the residential lobby through the drive aisle as is typical with a private, multifamily parking lot. One accessible van, and one accessible car stall are provided adjacent to the lobby entry. An access aisle is provided and marked on the pavement from between the two stalls directly to the lobby entry, as required by code.

4.155(.03)B.

B. Parking areas over 650 square feet, excluding access areas, and loading or delivery areas shall be landscaped to minimize the visual dominance of the parking or loading area, as follows:

- 1. Landscaping of at least ten percent of the parking area designed to be screened from view from the public right-of-way and adjacent properties. This landscaping shall be considered to be part of the 15 percent total landscaping required in Section 4.176.03 for the site development.*

Response: The proposed parking lot is illustrated in drawing A-000 Land Use Site Plan. The parking area (including drive aisles) on-site is 16,317 square feet with 8,005 sf of this area open to the sky. Staff has concluded that this criterion applies to the parking area open to the sky. It has also been clarified that site landscaping which buffers the parking from adjacent rights-of-way meets this standard.

The criterion requires 10% of this area, or 800 sf, of landscaping be designed to screen the parking from adjacent rights-of-way. The right-of-way along Town Center Loop is buffered from the parking area by landscaping varying in width from 4'-1" to 15'-5" and including 886 sf of planting. The right-of-way of the new Pedestrian Accessway is buffered from the parking by a 5'-10" deep, 619 sf planted area. Both planted buffers provide in total 1,505 sf of landscaped area to screen the parking. Therefore, the criterion is met.

4.155(.03)B.

2. Landscape tree planting areas shall be a minimum of eight feet in width and length and spaced every eight parking spaces or an equivalent aggregated amount.

- a. Trees shall be planted in a ratio of one tree per eight parking spaces or fraction thereof, except in parking areas of more than 200 spaces where a ratio of one tree per six spaces shall be applied as noted in subsection [4.155](.03)B.3. A landscape design that includes trees planted in areas based on an aggregated number of parking spaces must provide all area calculations.*
- b. Except for trees planted for screening, all deciduous interior parking lot trees must be suitably sized, located, and maintained to provide a branching minimum of seven feet clearance at maturity.*

Response: Landscaping surrounding the parking area and buffering the parking from adjacent rights-of-way and pedestrian paths meets the landscaped area standard within the parking area. The combined planted area and the overhanging building buffer effectively screens the parking area as intended. Therefore, no trees or 8-foot wide planted areas are required within the parking area itself.

Therefore, the criterion is met.

4.155(.03)B.

3. Due to their large amount of impervious surface, new development with parking areas of more than 200 spaces that are located in any zone, and that may be viewed from the public right-of-way, shall be landscaped to the following additional standards:

Response: The proposal includes 54 on-site parking spaces, therefore criterion is not applicable.

4.155(.03)C.

C. Off Street Parking shall be designed for safe and convenient access that meets ADA and ODOT standards. All parking areas which contain ten (10) or more parking spaces, shall for every 50 standard spaces, provide one ADA-accessible parking space that is constructed to building code standards, Wilsonville Code 9.000.

Response: As illustrated on A-000, the proposal includes 54 parking spaces within the off-street parking area. 52 stalls are non-accessible, and 2 are accessible. All parking spaces are constructed to building code standards. Therefore, the criterion is met.

4.155(.03)D.

D. Where possible, parking areas shall be designed to connect with parking areas on adjacent sites so as to eliminate the necessity for any mode of travel of utilizing the public street for multiple accesses or cross movements. In addition, on-site parking shall be designed for efficient on-site circulation and parking.

Response: The proposal includes a single on-site parking area which is accessed directly from the right-of-way at Town Center Loop. Therefore, the criterion is not applicable.

4.155(.03)E.

E. In all multi-family dwelling developments, there shall be sufficient areas established to provide for parking and storage of motorcycles, mopeds and bicycles. Such areas shall be clearly defined and reserved for the exclusive use of these vehicles.

Response: Parking for vehicles and bicycles is illustrated and calculated on drawing A-000. The proposal provides on-site parking for 54 vehicles in an open-air parking area, and 114 bicycle parking stalls within the building. The applicant is providing sufficient vehicle parking on-site to meet the anticipated market demand. A significant need for motorcycles and mopeds is not anticipated, however parking stalls can be converted in the future as resident needs change.

4.155(.03)F.

F. Except for single-family dwelling units and middle housing, on-street parking spaces, directly adjoining the frontage of and on the same side of the street as the subject property, may be counted towards meeting the minimum off-street parking standards.

Response: No on-street parking stalls are included with this application. Therefore, the criterion is not applicable.

4.155(.03)G.

G. Tables 5 shall be used to determine the minimum and maximum parking standards for various land uses. The minimum number of required parking spaces shown on Tables 5 shall be determined by rounding to the nearest whole parking space. For example, a use containing 500 square feet, in an area where the standard is one space for each 400 square feet of floor area, is required to provide one off-street parking space. If the same use contained more than 600 square feet, a second parking space would be required. Structured parking and on-street parking are exempted from the parking maximums in Table 5.

Response: Table 5 requires 1 off-street parking stall per dwelling unit in the TC zone for multi-family developments exceeding ten units. Table 5 states there is no minimum requirement for commercial retail of 1,501 sf or more when the aggregate quantity of commercial retail is less than 5,000 sf in a mixed-use building. Thus, there is no minimum required commercial parking. Under the CFEC, there will be no minimum residential parking requirement on this site.

The proposal provides 53 off-street parking stalls in an open-air and tuck-under parking lot. Section 4.155(.02) N allows up to 40%, or 21 of the off-street spaces to be compact spaces. The proposal provides 32 standard stalls, 19 compact stalls, and 2 accessible car and van stalls.

Therefore, the criteria are met.

4.155(.03)H.

H. *Electrical Vehicle Charging Stations:*

1. *Parking spaces designed to accommodate and provide one or more electric vehicle charging stations on site may be counted towards meeting the minimum off-street parking standards.*
2. *Modification of existing parking spaces to accommodate electric vehicle charging stations on site is allowed outright.*

Response: Accommodations for electric vehicle charging stations will be provided with the project in compliance with the CFEC ruling. Stations will likely be installed at a later date; however the applicant is deferring the decision to after building permit to respond to market demand.

4.155(.03)I.

I. *Motorcycle parking:*

1. *Motorcycle parking may substitute for up to five spaces or five percent of required automobile parking, whichever is less. For every four motorcycle parking spaces provided, the automobile parking requirement is reduced by one space.*
2. *Each motorcycle space must be at least four feet wide and eight feet deep. Existing parking may be converted to take advantage of this provision.*

Response: No motorcycle parking is proposed with this application.

4.155(.04)A.

(.04) *Bicycle Parking:*

A. *Required Bicycle Parking—General Provisions:*

1. *The required minimum number of bicycle parking spaces for each use category is shown in Table 5, Parking Standards.*
2. *Bicycle parking spaces are not required for accessory buildings. If a primary use is listed in Table 5, bicycle parking is not required for the accessory use.*
3. *When there are two or more primary uses on a site, the required bicycle parking for the site is the sum of the required bicycle parking for the individual primary uses.*
4. *Bicycle parking space requirements may be waived by the Development Review Board per Section 4.118(.03)A.9. and 10.*

Response: Bicycle parking is illustrated and calculated on drawing A-000 Land Use Site Plan. Cut sheets and diagrams for each proposed bike rack type is also provided on A-000. The ground floor bike room contains two types of bike racks commonly used in urban mixed-use development: 16 wall-hung bike racks and 10 stacked horizontal bikes. The wall-hung bike racks stagger bikes vertically and provide a 2-foot-wide space for each bike within a 14-inch horizontal spacing. Each rack is 3 feet and 4 inches deep. The stacked horizontal bikes are placed one over the other and offset, allowing for two bikes within a 3-foot spacing. There is a pneumatic lift system for the upper-level bikes, and an access aisle of 7 feet and 4 inches is provided between the two rack systems, which exceeds the 5-foot requirement. Additionally, four horizontal bike spaces measuring 2 feet by 4 feet are available next to the residential lobby entry for added convenience. At Levels 3-5, a residential storage room holds 15 secure active-gear lockers. Each locker is 2'-6" wide by 4'-0" deep and is large enough to hold a vertically hung bicycle. An 8'-10" aisle is provided between lockers and exceeds the 5-foot requirement. All lockers will be securely anchored to the floor, the rear wall, and to each other. Therefore, the criteria are met.

4.155(.04)B.*B. Standards for Required Bicycle Parking:*

1. *Each space must be at least two feet by six feet in area and be accessible without moving another bicycle.*
2. *An aisle at least five feet wide shall be maintained behind all required bicycle parking to allow room for bicycle maneuvering. Where the bicycle parking is adjacent to a sidewalk, the maneuvering area may extend into the right-of-way.*
3. *When bicycle parking is provided in racks, there must be enough space between the rack and any obstructions to use the space properly.*
4. *Bicycle lockers or racks, when provided, shall be securely anchored.*
5. *Bicycle parking shall be located within 30 feet of the main entrance to the building or inside a building, in a location that is easily accessible for bicycles. For multi-tenant developments, with multiple business entrances, bicycle parking may be distributed on-site among more than one main entrance.*
6. *With Planning Director approval, on street vehicle parking can also be used for bicycle parking.*

Response: Bicycle parking is illustrated and calculated on drawing A-000 Land Use Site Plan. Bicycles within the first-floor bike room utilize two types of racks commonly used in urban mixed-use development. 16 Wall-hung bike racks stagger bikes vertically from one another, allowing a 2'-0" wide space for each bike within a 14" spacing. Each of these is 3'-4" deep. 10 Stacked Horizontal Bikes provide two bikes within a 3-foot spacing due to stacking one bike over and offset from the next. These provide convenient access to both spaces without lifting the bicycle with a pneumatic lift system for the upper-level bikes. A 7'-4" access aisle is provided between these two rack systems and exceeds the 5-foot requirement. 4 horizontal bike spaces dimensioned 2'-0" x 4'-0" are provided adjacent to the residential lobby entry. At Levels 3-5, a residential storage room holds 15 secure active-gear lockers. Each locker is 2'-6" wide by 4'-0" deep and is large enough to hold a vertically hung bicycle. An 8'-10" aisle is provided between lockers and exceeds the 5-foot requirement. All lockers will be securely anchored to the floor, the rear wall, and to each other.

Space will be provided in units for an additional 45 in-unit bike racks. These bike racks will be provided and installed by the owner in the future at resident request. Therefore, the criteria are met.

4.155(.04)C.*C. Long-term Bicycle Parking:*

1. *Long-term bicycle parking provides employees, students, residents, commuters, and others who generally stay at a site for several hours a weather-protected place to park bicycles.*
2. *For a proposed multi-family residential, retail, office, or institutional development, or for a park and ride or transit center, where six or more bicycle parking spaces are required pursuant to Table 5, 50% of the bicycle parking shall be developed as long-term, secure spaces. Required long-term bicycle parking shall meet the following standards:*
 - a. *All required spaces shall meet the standards in subsection (B.) above, and must be covered in one of the following ways: inside buildings, under roof overhangs or permanent awnings, in bicycle lockers, or within or under other structures.*
 - b. *All spaces must be located in areas that are secure or monitored (e.g., visible to employees, monitored by security guards, or in public view).*
 - c. *Spaces are not subject to the locational criterion of [subsection] B.5.*

Response: Bicycle parking is illustrated and calculated on drawing A-000 Land Use Site Plan. The proposal includes multi-family residential and commercial tenant space, and Table 5 requires 114 parking spaces for the residential units only. All required parking is provided in secure rooms or lockers within the building, and in 4 covered exterior spaces near the building entry. All 118 provided parking spaces meet the requirements for Long-term Bicycle parking, and therefore exceed the requirement for 59.

4.155(.05)A.*(.05) Minimum Off-Street Loading Requirements:*

- A. *Every building that is erected or structurally altered to increase the floor area, and which will require the receipt or distribution of materials or merchandise by truck or similar vehicle, shall provide off-street loading berths on the basis of minimum requirements as follows:*
 1. *Commercial, industrial, and public utility uses which have a gross floor area of 5,000 square feet or more, shall provide truck loading or unloading berths in accordance with the following tables:*
 2. *Restaurants, office buildings, hotels, motels, hospitals and institutions, schools and colleges, public buildings, recreation or entertainment facilities, and any similar use which has a gross floor area of 30,000 square feet or more, shall provide off-street truck loading or unloading berths in accordance with the following table:*
 3. *A loading berth shall contain space 12 feet wide, 35 feet long, and have a height clearance of 14 feet. Where the vehicles generally used for loading and unloading exceed these dimensions, the required length of these berths shall be increased to accommodate the larger vehicles.*

- 4. *If loading space has been provided in connection with an existing use or is added to an existing use, the loading space shall not be eliminated if elimination would result in less space than is required to adequately handle the needs of the particular use.*
- 5. *Off-street parking areas used to fulfill the requirements of this Ordinance shall not be used for loading and unloading operations except during periods of the day when not required to meet parking needs.*

Response: The proposed project and parking area are illustrated and summarized on drawing A-000. The project includes 114 residential apartments, and 3,707 sf of commercial tenant space. Therefore, the criterion is not applicable.

4.155(.06)A.

(.06) Carpool and Vanpool Parking Requirements:

- A. *Carpool and vanpool parking spaces shall be identified for the following uses:*

Response: The proposed project and parking area are illustrated and summarized on drawing A-000. The project provides 54 parking spaces which is less than the threshold of 75 in the standard. Therefore, no carpool or vanpool parking is required or proposed.

4.155(.07)A.

(.07) Parking Area Redevelopment. The number of parking spaces may be reduced by up to ten percent of the minimum required parking spaces for that use when a portion of the existing parking area is modified to accommodate or provide transit-related amenities such as transit stops, pull-outs, shelters, and park and ride stations.

Response: The proposed project and parking area are illustrated and summarized on drawing A-000. No existing parking area is proposed to be retained. Therefore, the criterion is not applicable.

Section 4.156 Sign Regulations

4.156.02(.02)

(.02) Sign Permits and Master Sign Plans. Many properties in the City have signs pre-approved through a Master Sign Plan. For the majority of applications where a Master Sign Plan has been approved the applicant need not consult the sign requirements for the zone, but rather the Master Sign Plan, copies of which are available from the Planning Division. Signs conforming to a Master Sign Plan require only a Class I Sign Permit.

Response: The proposal includes up to three commercial tenants and per 4.156.02(.03) requires a Master Sign Plan for this review. All signage will be designed and permitted under future tenant improvements as Class 1 Sign Permits. Drawings and documents required for the Master Sign Plan review are provided below, and in exhibit A-004 Signage Plan.

4.156.02(.03)

(.03) Classes of Sign Permits, Master Sign Plans, and Review Process. The City has three classes of sign permits for permanent signs: Class I, Class II, and Class III. In addition, non-residential developments with three or more tenants require a Master Sign Plan. Class I sign permits are reviewed through the Class I Administrative Review Process as outlined in Subsection 4.030(.01)A. Class II sign permits are reviewed through the Class II Administrative Review Process as outlined in Subsection 4.030 (.01)B. Class III Sign Permits and Master Sign Plans are reviewed by the Development Review Board (DRB) as outlined in Section 4.031.

Response: The proposal includes up to three commercial tenants and per 4.156.02(.03) requires a Master Sign Plan for this review. All signage will be designed and permitted under future tenant improvements as Class 1 Sign Permits. Drawings and documents required for the Master Sign Plan review are provided below, and in exhibit A-004 Signage Plan.

4.156.02(.06)

(.06) Class III Sign Permit. Sign permit requests shall be processed as a Class III Sign Permit when associated with new development, except as noted in Subsection 4.156.02(.05)C., or redevelopment requiring DRB review, and not requiring a Master Sign Plan; when a sign permit request is associated with a waiver or non-administrative variance; or when the sign permit request involves one or more freestanding or ground mounted signs greater than eight feet in height in a new location.

- A. *Class III Sign Permit Submission Requirements. Ten paper and electronic copies of the submission requirements for Class II Sign Permits plus information on any requested waivers or variances in addition to all required fees.*
- B. *Class III Sign Permit Review Criteria: The review criteria for Class II Sign Permits plus waiver or variance criteria when applicable.*

Response: Per 4.156.02(.03), the proposal includes three commercial tenants and therefore requires a Master Sign Plan review. All signage is deferred and will be designed and permitted under future Class 1 Sign Permits. Therefore the criterion is not applicable.

4.156.02(.07)A

(.07) Master Sign Plans. A Master Sign Plan is required for non-residential developments with three or more tenants. In creating a Master Sign Plan thought should be given to needs of initial tenants as well as the potential needs of future tenants.

- A. *Master Sign Plan Submission Requirements. Applications for Master Sign Plans shall include ten paper and electronic copies of all the submission requirements for Class II and III Sign Permits and the following in addition to all required fees:*

1. A written explanation of the flexibility of the Master Sign Plan for different potential tenant space configurations over time;
2. A written explanation of the extent to which different sign designs, including those incorporating logos, stylized letters, multiple lines of text, non-straight baselines, or different materials and illumination will be allowed and if allowed how the flexibility of the master sign plan will allow these different sign designs over time;
3. A written explanation of how the sign plan provides for a consistent and compatible sign design throughout the subject development.

Response: Proposed master signage guidelines are illustrated and narrated in exhibit A-004 Signage Plan. Proposed, flexible locations are illustrated in plan and elevation, and all guidelines for materials, format, font, and lighting are provided in the narrative on A-004. As stated in the 'Master Sign Plan' portion of the narrative on A-004, the guidelines are established to allow tenants to "highlight their product or service while reinforcing the design excellence of WTC-01 as a whole". Signage and logo design should "express a refined urban sophistication through the use of clean and contemporary shapes and forms". Allowable materials are intended to harmoniously blend with the exterior materials of the building. Signage is anticipated in the zones shown in plan and elevation on A-004, and is primarily limited to the retail frontage along Park Place (and the future promenade). The guidelines provide numerous examples of 'clean and contemporary' signage, graphics, materials, and formats to meet a variety of commercial tenant and business needs and changes over time that remain consistent with the overall building character.

4.156.02(.07)B

- B. Master Sign Plan Review Criteria. In addition to the review criteria for Class II and Class III Sign Permits, Master Sign Plans shall meet the following criteria:*
1. The Master Sign Plan provides for consistent and compatible design of signs throughout the development; and
 2. The Master Sign Plan considers future needs, including potential different configurations of tenant spaces and different sign designs, if allowed.

Response: Proposed master signage guidelines, and locations in plan and elevation are illustrated and narrated in exhibit A-004 Signage Plan. The Master Sign Plan documentation on exhibit A-004 sets the intent of the design and function of all future commercial tenant signage, and provides multiple, flexible design examples and material options or methods to ensure that a wide variety of needs can be met within a compatible design for the entire development over time. Current CC&R's for the site will limit the quantity of commercial tenants to (3) maximum at one time. However the building provides (4) entries along Park Place to allow flexibility in sizing of the retail spaces, as well as flexibility in signage for each tenant.

4.156.02(.07)C

- C. Modifications of a Master Sign Plan. Modifications of a Master Sign Plan, other than Minor and Major Adjustments, shall be reviewed the same as a new Master Sign Plan.*

Response: No modification of a Master Sign Plan are included in this application. Therefore, the criterion is not applicable.

Section 4.171 General Regulations – Protection of Natural Features and Other Resources

4.171(.02)A.

(.02) General Terrain Preparation:

A. All developments shall be planned, designed, constructed and maintained with maximum regard to natural terrain features and topography, especially hillside areas, floodplains, and other significant landforms.

Response: The existing site of the proposal is a relatively flat surface parking lot and does not contain any significant topography, natural terrain features, or floodplains. Therefore, the criterion is not applicable.

4.171(.02)B.

B. All grading, filling and excavating done in connection with any development shall be in accordance with the Uniform Building Code.

Response: The development will be planned, designed, and constructed to the applicable codes.

4.171(.02)C.

C. In addition to any permits required under the Uniform Building Code, all developments shall be planned, designed, constructed and maintained so as to:

- 1. Limit the extent of disturbance of soils and site by grading, excavation and other land alterations.*
- 2. Avoid substantial probabilities of: (1) accelerated erosion; (2) pollution, contamination, or siltation of lakes, rivers, streams and wetlands; (3) damage to vegetation; (4) injury to wildlife and fish habitats.*
- 3. Minimize the removal of trees and other native vegetation that stabilize hillsides, retain moisture, reduce erosion, siltation and nutrient runoff, and preserve the natural scenic character.*

Response: The development will be planned, designed, and constructed to the applicable codes.

4.171(.03)

(.03) Hillsides. All developments proposed on slopes greater than 25 percent shall be limited to the extent that:

Response: The site of the proposal is not sloped greater than 25 percent. Therefore, the criterion is not applicable.

4.171(.04)

(.04) Trees and Wooded Areas

Response: The site of the proposal does not contain trees or wooded areas. Therefore, the criterion is not applicable.

4.171(.05)

(.05) High Voltage Powerline Easements and Right-of-Way and Petroleum Pipeline Easements:

A. Due to the restrictions placed on these lands, no residential structures shall be allowed within high voltage powerline easements and rights-of-way and petroleum pipeline

easements, and any development, particularly residential, adjacent to high voltage powerline easements and rights-of-way and petroleum pipeline easements shall be carefully reviewed.

B. Any proposed non-residential development within high voltage powerline easements and rights-of-way and petroleum pipeline easements shall be coordinated with and approved by the Bonneville Power Administration, Portland General Electric Company or other appropriate utility, depending on the easement or right-of-way ownership.

Response: No high voltage powerline easements, right-of-way, or petroleum pipeline easements exist adjacent to the site or are proposed in the project. Therefore, the criterion is not applicable.

4.171(.06)

(.06) Hazards to Safety: Purpose.

Response: The development poses no hazards to safety. The criterion is not applicable.

4.171(.07)

(.07) Standards for Earth Movement Hazard Areas:

Response: The project is not within any Earth Movement Hazard Areas. The criterion is not applicable.

4.171(.08)

(.08) Standards for Soil Hazard Areas:

Response: The project is not within Soil Hazard Areas. The criterion is not applicable.

4.171(.09)

(.09) Historic Protection: Purpose.

Response: No historic or cultural resources existing on the site of the proposal. Therefore, the criterion is not applicable.

4.171(.10)

(.10) Alteration and Development Criteria.

Response: No historic or cultural resources existing on the site of the proposal. Therefore, the criterion is not applicable.

4.171(.11)

(.11) Cultural Resource Designation Criteria. A cultural resource may be designated and placed on the Cultural Resources Inventory if it meets the following criteria:

Response: No historic or cultural resources existing on the site of the proposal. Therefore, the criterion is not applicable.

Section 4.175 Public Safety and Crime Prevention

4.175(.01)

(.01) All developments shall be designed to deter crime and insure public safety.

Response: The proposed site plan is illustrated on exhibit A-000. With 114 new residences and ground floor active commercial space, the project is designed to greatly increase the “eyes on the street” in this multi-modal pedestrian friendly area. With more residents in the area for more hours of the day, together with street improvements and active commercial space, the project is designed to deter crime and ensure public safety. Exterior lighting is provided to illuminate all areas of the site and is illustrated on the Site Lighting Plan, exhibit A-021. In addition, the landscape design (see exhibit L-510) provides low lying landscape with interspersed trees to create open views and transparency and reduce areas of hidden refuge. With this design, the project will deter crime and ensure public safety.

4.175(.02)

(.02) Addressing and directional signing shall be designed to assure identification of all buildings and structures by emergency response personnel, as well as the general public.

Response: Code-required signage, such as fire department connection signage, and building address signage will be designed in accordance with applicable building and fire codes and coordinated through the permitting process with the relevant jurisdictions. Proposed signage is provided on exhibit A-004 and is being reviewed under a Sign Permit with this application.

4.175(.03)

(.03) Areas vulnerable to crime shall be designed to allow surveillance. Parking and loading areas shall be designed for access by police in the course of routine patrol duties.

Response: The proposed site plan is illustrated on exhibit A-000. Street-lighting in the rights-of-way, 114 upper floor residences, and active commercial spaces provide eyes on the street for all street frontages. The on-site parking area is illuminated throughout both the surface and tuck-under portions, and the surrounding landscaping is low lying with interspersed trees to provide transparency and view to reduce areas of hidden refuge and deter crime. Security surveillance systems will be provided at all building entries and any hidden or vulnerable portions of the on-site parking area.

4.175(.04)

(.04) Exterior lighting shall be designed and oriented to discourage crime.

Response: The proposed Site Lighting Plan is illustrated on exhibit A-021. The frontages of Park Place, the new northeast Local Street, and the southern end of Town Center Loop are illuminated by street-lighting in the rights-of-way, light coming from the ground-floor retail, and residential use at all hours of the evening. Lighting is provided at each retail entry along Park Place and will remain on throughout the night outside of business hours. The new Local Street is illuminated by two types of lighting at each ground-floor residential stoop. Light fixture L.3 illuminates the foot path and unit addresses and will remain on at all hours of the night. Fixture L.4 will be resident operated and combined with lighting spilling out from the interior residences, will add further illumination. The entire Pedestrian Accessway is lighted with site bollard lights to illuminate the ground plane. The proposed site lighting and building-mounted lighting, combined with the interior lighting of the 114 residences and active ground-floor commercial space will discourage crime at all hours.

Section 4.176 Landscaping, Screening, and Buffering**4.176(.02)D***D. Low Screen Landscaping Standard:*

1. *Intent. The Low Screen Landscaping Standard is a landscape treatment that uses a combination of distance and low screening to separate uses or developments. It is intended to be applied in situations where low screening is adequate to soften the impact of one use or development on another, or where visibility between areas is more important than a total visual screen. The Low Screen Landscaping Standard is usually applied along street lot lines or in the area separating parking lots from street rights-of-way.*
2. *Required materials. The Low Screen Landscaping Standard requires sufficient low shrubs to form a continuous screen three feet high and 95 percent opaque, year-round. In addition, one tree is required for every 30 linear feet of landscaped area, or as otherwise required to provide a tree canopy over the landscaped area. Ground cover plants must fully cover the remainder of the landscaped area. A three foot high masonry wall or a berm may be substituted for the shrubs, but the trees and ground cover plants are still required. When applied along street lot lines, the screen or wall is to be placed along the interior side of the landscaped area. (See Figure 22: Low Screen Landscaping).*

Response: The overall development and site plan is illustrated on drawing A-000 Land Use Site Plan, and proposed planting is illustrated on L-510 Planting Plan. The area of development relative to this code section is at the southwestern, and northwestern frontages where the off-street parking area abuts the right-of-way. Contiguous planted buffer lines the adjacent pedestrian path and buffers it from the parking area along Town Center Loop, and along the new Pedestrian Accessway.

As shown on L-510, the planted area screening the parking from the Town Center Loop pedestrian path includes on-site trees, 36-inch-tall shrubs, and grasses and groundcover. Additional screening of the right-of-way is provided by street trees in the right-of-way. A small portion of the parking area is screened from the Town Center Loop pedestrian path by an extension of the ground-floor facade and a proposed steel art screen in lieu of a masonry wall.

Screening of the Pedestrian Accessway right-of-way is provided with on-site trees, shrubs, and grasses and groundcover. Existing trees and shrubs are maintained along the northwest property line on the adjacent property to provide screening of the parking area to the neighboring lot. Two existing easements run diagonally across the west corner of the site and hinder the ability to provide trees at 30 lineal feet spacing. The proposal includes 36-inch-tall shrubs and contiguous grasses or ground cover in this area to provide a continuous evergreen screening. Ground cover plants fully cover the area as well to meet the standard for this area.

4.176(.03)

(.03) Landscape Area. Not less than 15 percent of the total lot area, shall be landscaped with vegetative plant materials. The ten percent parking area landscaping required by section 4.155.03(B)(1) is included in the 15 percent total lot landscaping requirement. Landscaping shall be located in at least three separate and distinct areas of the lot, one

of which must be in the contiguous frontage area. Planting areas shall be encouraged adjacent to structures. Landscaping shall be used to define, soften or screen the appearance of buildings and off-street parking areas. Materials to be installed shall achieve a balance between various plant forms, textures, and heights. The installation of native plant materials shall be used whenever practicable. (For recommendations refer to the Native Plant List maintained by the City of Wilsonville).

Response: The applicant has received clarification that the required landscaping in the TC-MU subdistrict should be 10%, and the parking area landscaping for the proposal can be met within the screening planted area at the abutting rights-of-way. The site plan and landscaped area calculations are shown on drawing A-000, and proposed planting is shown on L-510. The proposal provides 4,637 sf of landscaping and exceeds the requirement per the response to 4.132(.06) C. As illustrated on A-000 and L-510, an 18" portion of the rights-of-way in the amenity zone is planted along Town Center Loop and the new Local Street to soften the appearance of the building and differentiate these frontages from the retail frontage on Park Place. Planted materials and spacings are described on L-510 and provide a wide variety of sizes, species, and heights. The sizes of the landscaped areas and intended urbanized context precludes an exclusively native planting palette. All propose plant materials are either native or acclimatized to our region with native plant materials being located where appropriate and to the extent practical.

4.176(.04)

(.04) Buffering and Screening. Additional to the standards of this subsection, the requirements of the Section 4.137.5 (Screening and Buffering Overlay Zone) shall also be applied, where applicable.

A. All intensive or higher density developments shall be screened and buffered from less intense or lower density developments.

B. Activity areas on commercial and industrial sites shall be buffered and screened from adjacent residential areas. Multi-family developments shall be screened and buffered from single-family areas.

C. All exterior, roof and ground mounted, mechanical and utility equipment shall be screened from ground level off-site view from adjacent streets or properties.

D. All outdoor storage areas shall be screened from public view, unless visible storage has been approved for the site by the Development Review Board or Planning Director acting on a development permit.

E. In all cases other than for industrial uses in industrial zones, landscaping shall be designed to screen loading areas and docks, and truck parking.

F. In any zone any fence over six feet high measured from soil surface at the outside of fence line shall require Development Review Board approval.

Response: The site is surrounded on all sides by zoning of equal or greater intensity of development. No single-family residential or low-density development exists immediately adjacent to the site. All roof-mounted mechanical and utility equipment is screened as described in the response to section 4.132(.06) M.2.f. Site utilities are illustrated on drawings C-300 and A-000, and plantings are illustrated on L-510. Ground-mounted utilities include an pad-mounted electrical transformer and vault, a

gas service regulator, and gas meters along the Town Center Loop right-of way. The electrical transformer and gas regulator are within a contiguous planted area and screened by a minimum of 4-foot-deep planting which includes 36-inch-tall shrubs and groundcover to meet the low-screen standard.

The proposed gas meters are within the parking area and screened from the right-of-way by an extension of the ground-floor façade.

No outdoor storage areas are proposed. Resident storage occurs within the building at all floors, and waste and recycling storage occurs within an enclosed room at the west corner of the parking area. No fences are proposed with this application.

4.176(.05)

(.05) Sight-Obscuring Fence or Planting. The use for which a sight-obscuring fence or planting is required shall not begin operation until the fence or planting is erected or in place and approved by the City. A temporary occupancy permit may be issued upon a posting of a bond or other security equal to 110 percent of the cost of such fence or planting and its installation. (See Sections 4.400 to 4.470 for additional requirements.)

Response: No fences or sight-obscuring planting is proposed. Therefore, the criterion is not applicable.

4.176(.06)A

A. Shrubs and Ground Cover. All required ground cover plants and shrubs must be of sufficient size and number to meet these standards within three years of planting. Non-horticultural plastic sheeting or other impermeable surface shall not be placed under mulch. Native topsoil shall be preserved and reused to the extent feasible. Surface mulch or bark dust are to be fully raked into soil of appropriate depth, sufficient to control erosion, and are confined to areas around plantings. Areas exhibiting only surface mulch, compost or barkdust are not to be used as substitutes for plant areas.

1. Shrubs. All shrubs shall be well branched and typical of their type as described in current AAN Standards and shall be equal to or better than 2-gallon containers and ten inches to 12 inches spread.

2. Ground cover. Shall be equal to or better than the following depending on the type of plant materials used: gallon containers spaced at four feet on center minimum, four inch pot spaced two feet on center minimum, two one-fourth inch pots spaced at 18 inch on center minimum. No bare root planting shall be permitted. Ground cover shall be sufficient to cover at least 80 percent of the bare soil in required landscape areas within three years of planting. Where wildflower seeds are designated for use as a ground cover, the City may require annual re-seeding as necessary.

3. Turf or lawn in non-residential developments. Shall not be used to cover more than ten percent of the landscaped area, unless specifically approved based on a finding that, due to site conditions and availability of water, a larger percentage of turf or lawn area is appropriate. Use of lawn fertilizer shall be discouraged. Irrigation drainage runoff from lawns shall be retained within lawn areas.

4. *Plant materials under trees or large shrubs. Appropriate plant materials shall be installed beneath the canopies of trees and large shrubs to avoid the appearance of bare ground in those locations.*
5. *Integrate compost-amended topsoil in all areas to be landscaped, including lawns, to help detain runoff, reduce irrigation and fertilizer needs, and create a sustainable, low-maintenance landscape.*

Response: Proposed planting is illustrated on drawing L-510. A planting schedule lists species, size, spacing, and water need for all proposed Street Trees, On-Site Trees, Shrubs, and Ground Cover.

All proposed shrubs are specified to be a minimum 3-gallon at installation. All ornamental grasses, perennials, herbaceous perennials, and groundcovers are specified to be a minimum of 1-gallon at installation. No turf or lawn is specified as part of this development. All new landscape beds are to receive imported and amended topsoil.

4.176(.06)B

- B. Trees. All trees shall be well-branched and typical of their type as described in current American Association of Nurserymen (AAN) Standards and shall be balled and burlapped. The trees shall be grouped as follows:*
1. *Primary trees which define, outline or enclose major spaces, such as Oak, Maple, Linden, and Seedless Ash, shall be a minimum of two inch caliper.*
 2. *Secondary trees which define, outline or enclose interior areas, such as Columnar Red Maple, Flowering Pear, Flame Ash, and Honeylocust, shall be a minimum of 1¾ inch to 2 inch caliper.*
 3. *Accent trees which, are used to add color, variation and accent to architectural features, such as Flowering Pear and Kousa Dogwood, shall be 1¾ inch minimum caliper.*
 4. *Large conifer trees such as Douglas Fir or Deodar Cedar shall be installed at a minimum height of eight feet.*
 5. *Medium-sized conifers such as Shore Pine, Western Red Cedar or Mountain Hemlock shall be installed at a minimum height of five to six feet*

Response: Proposed planting is illustrated on drawing L-510. A planting schedule lists species, size, spacing, and water need for all proposed Street Trees, On-Site Trees, Shrubs, and Ground Cover.

A mix of medium and large-scale trees are proposed to outline the site along each street frontage. These species are specified to be 2-inch caliper at installation. Small trees are proposed to define interior spaces. These spaces are intended to be multi-stem trees and are specified to be 10-12' height at installation.

4.176(.05)C

- C. Where a proposed development includes buildings larger than 24 feet in height or greater than 50,000 square feet in footprint area, the Planning Director or the Development Review Board, as applicable, may require larger or more mature plant materials.*
1. *At maturity, proposed trees shall be at least one-half the height of the building to which they are closest, and building walls longer than 50 feet shall require tree groups located no more than 50 feet on center, to break up the length and height of the façade.*

2. *Either fully branched deciduous or evergreen trees may be specified depending upon the desired results. Where solar access is to be preserved, only solar-friendly deciduous trees are to be used. Where year-round sight obscuring is the highest priority, evergreen trees are to be used.*
3. *The following standards are to be applied:*
 - a. *Deciduous trees:*
 - i. *Minimum height of ten feet; and*
 - ii. *Minimum trunk diameter (caliper) of two inches (measured at four and one-half feet above grade).*
 - b. *Evergreen trees: Minimum height of 12 feet.*

Response: Proposed planting is illustrated on drawing L-510. A planting scheduled lists species, size, spacing, and water need for all proposed Street Trees, On-Site Trees, Shrubs, and Ground Cover. The proposed building is 60'-0" tall.

The proposal includes 18 street trees within right-of-way improvements and in accordance with relevant street design standards for the new Local Street, Town Center Loop, and Park Place.

Proposed street trees are specified to have a two-inch caliper at the time of planting which exceeds the requirement for local street classifications. Per the Oregon State department of horticulture (<https://landscapeplants.oregonstate.edu/>) and J. Frank Schmidt & Son Co. tree nursery (<https://jfschmidt.com/resources/reference-guide/>), the specified street trees have the expected heights at maturity:

- Acer rubrum 'Armstrong' 45' ht.
- Liriodendron tulipifera 'Fastigiata' 50' ht.
- Rhamnus purshiana 50' ht.

Proposed trees on site are specified as multi-stem trees with a minimum height of 10-12' at installation.

Building footprint and existing/proposed easements preclude installation of large-scale trees on site.

4.176(.05)D.1

D. Street Trees. In order to provide a diversity of species, the Development Review Board may require a mix of street trees throughout a development. Unless the Board waives the requirement for reasons supported by a finding in the record, different types of street trees shall be required for adjoining blocks in a development.

1. All trees shall be standard base grafted, well branched and typical of their type as described in current AAN Standards and shall be balled and burlapped (b&b). Street trees shall be planted at sizes in accordance with the following standards:

- a. *Arterial streets—Three inches minimum caliper*
- b. *Collector streets—Two inches minimum caliper.*
- c. *Local streets or residential private access drives—1¾ inches minimum caliper.*
- d. *Accent or median tree—1¾ inches minimum caliper.*

Response: The street trees specified on L-510 were derived from the lists contained within the Wilsonville Town Center Streetscape Plan. The specified species meet the intended code related street tree diversity goals and are well suited for an urban context. The specified trees are located in a manner to enhance architectural features (such as allowing to capitalize on natural light) for the new development while fitting into the existing context by matching existing street tree species along Town Center Loop where trees are to be replaced.

Proposed street trees are specified to have a two-inch caliper at the time of planting which exceeds the requirement for local street classifications.

4.176(.05)D.2

2. *The following trees and varieties thereof are considered satisfactory street trees in most circumstances; however, other varieties and species are encouraged and will be considered:*
 - a. *Trees over 50 feet mature height: Quercus garryana (Native Oregon White Oak), Quercus rubra borealis (Red Oak), Acer Macrophyllum (Native Big Leaf Maple), Acer nigrum (Green Column Black Maple), Fraxinus americanus (White Ash), Fraxinus pennsylvannica 'Marshall' (Marshall Seedless Green Ash), Quercus coccinea (Scarlet Oak), Quercus pulustris (PinOak), Tilia americana (American Linden).*
 - b. *Trees under 50 feet mature height: Acer rubrum (Red Sunset Maple), Cornus nuttallii (NativePacific Dogwood), Gleditsia triacanthos (Honey Locust), Pyrus calleryana 'Bradford' (Bradford Pear), Tilia cordata (Little Leaf Linden), Fraxinus oxycarpa (Flame Ash).*
 - c. *Other street tree species. Other species may be specified for use in certain situations. For instance, evergreen species may be specified where year-round color is desirable and no adverse effect on solar access is anticipated. Water-loving species may be specified in low locations where wet soil conditions are anticipated.*

Response: The street trees specified on L-510 were derived from the lists contained within the Wilsonville Town Center Streetscape Plan. The specified species meet the intended code related street tree diversity goals and are well suited for an urban context. The specified trees are located in a manner to enhance architectural features (such as allowing to capitalize on natural light) for the new development while fitting into the existing context by matching existing street tree species along Town Center Loop where trees are to be replaced.

4.176(.06)E.1

- E. *Types of Plant Species:*
 1. *Existing landscaping or native vegetation may be used to meet these standards, if protected and maintained during the construction phase of the development and if the plant species do not include any that have been listed by the City as prohibited. The existing native and non-native vegetation to be incorporated into the landscaping shall be identified.*

Response: No existing plant material is designated for retention onsite. Therefore, the criterion is not applicable.

4.176(.06)E.2

E. *Types of Plant Species:*
 2. *Selection of plant materials. Landscape materials shall be selected and sited to produce hardy and drought-tolerant landscaping. Selection shall be based on soil characteristics, maintenance requirements, exposure to sun and wind, slope and contours of the site, and compatibility with other vegetation that will remain on the site. Suggested species lists for street trees, shrubs and groundcovers shall be provided by the City of Wilsonville.*

Response: All proposed plant material on site is either native or acclimatized and is situated within site specific microclimates that are appropriate for each species.

4.176(.06)E.3

3. *Prohibited plant materials. The City may establish a list of plants that are prohibited in landscaped areas. Plants may be prohibited because they are potentially damaging to sidewalks, roads, underground utilities, drainage improvements, or foundations, or because they are known to be invasive to native vegetation.*

Response: No prohibited plant materials are proposed, all invasive plant materials are to be removed prior to installation of new landscape materials per notes on sheet L-510.

4.176(.06)F

F. *Tree Credit. Existing trees that are in good health as certified by an arborist and are not disturbed during construction may count for landscaping tree credit as follows (measured at four and one-half feet above grade and rounded to the nearest inch):*

Response: Existing trees and trees proposed to be preserved are illustrated on L-500. Trees intended for preservation do not meet the threshold for applicable tree credits, therefore this criterion is not applicable.

4.176(.07)A

A. *Installation. Plant materials shall be installed to current industry standards and shall be properly staked to assure survival. Support devices (guy wires, etc.) shall not be allowed to interfere with normal pedestrian or vehicular movement.*

Response: All plant material shall be installed in accordance with industry standards.

4.176(.07)B.

B. *Maintenance. Maintenance of landscaped areas is the on-going responsibility of the property owner. Any landscaping installed to meet the requirements of this Code, or any condition of approval established by a City decision-making body acting on an application, shall be continuously maintained in a healthy, vital and acceptable manner. Plants that die are to be replaced in kind, within one growing season, unless appropriate substitute species are approved by the City. Failure to maintain landscaping as required in this Section shall constitute a violation of this Code for which appropriate legal remedies, including the revocation of any applicable land development permits, may result.*

Response: Proposed landscaped areas will be maintained in accordance with City requirements and conditions of approval for this application.

4.176(.07)C.

C. Irrigation. The intent of this standard is to assure that plants will survive the critical establishment period when they are most vulnerable due to a lack of watering and also to assure that water is not wasted through unnecessary or inefficient irrigation. Approved irrigation system plans shall specify one of the following:

Response: All new planting areas are to receive a permanent, built-in, high efficiency automatic irrigation system.

4.176(.07)D.

D. Protection. All required landscape areas, including all trees and shrubs, shall be protected from potential damage by conflicting uses or activities including vehicle parking and the storage of materials.

Response: All plant material shall be situated to prevent damage from conflicting uses, including vehicle parking.

4.176(.08)

(.08) Landscaping on Corner Lots. All landscaping on corner lots shall meet the vision clearance standards of Section 4.177. If high screening would ordinarily be required by this Code, low screening shall be substituted within vision clearance areas. Taller screening may be required outside of the vision clearance area to mitigate for the reduced height within it.

Response: Proposed landscaping is illustrated on A-000 and L-510. No landscaping is proposed within the vision clearance areas. All landscaping will adhere to the requirements of Section 4.177.

4.176(.09)

(.09) Landscape Plans. Landscape plans shall be submitted showing all existing and proposed landscape areas. Plans must be drawn to scale and show the type, installation size, number and placement of materials. Plans shall include a plant material list. Plants are to be identified by both their scientific and common names. The condition of any existing plants and the proposed method of irrigation are also to be indicated. Landscape plans shall divide all landscape areas into the following categories based on projected water consumption for irrigation:

Response: Proposed landscaping is illustrated on L-510. Plans are drawn to 1"=10'-0" scale and include type, installation size, number and placement of various plant materials, anticipated water usage, and a plant material schedule listing common name and scientific name.

Section 4.177 Street Improvement Standards**4.177(.02)A.1***(.02) Street Design Standards:**A. All street improvements and intersections shall provide for the continuation of streets through specific developments to adjoining properties or subdivisions.**1. Development shall be required to provide existing or future connections to adjacent sites through the use of access easements where applicable. Such easements shall be required in addition to required public street dedications as required in Section 4.236(.04).*

Response: Connection to adjacent sites is provided in this development through rights-of-way by Town Center Loop, Park Place, and the new Local Street. Therefore, the criterion is met.

4.177(.02)B*B. The City Engineer shall make the final determination regarding right-of-way and street element widths using the ranges provided in Chapter 3 of the Transportation System Plan and the additional street design standards in the Public Works Standards.*

Response: Proposed street widths at Town Center Loop and Park Place are widened through dedications with the proposal to allow a 12-foot-wide sidewalk from the existing curb at each street. The resulting rights-of-way widths exceed the required widths illustrated in the Town Center Plan appendices and allow for the envisioned design at each street. The new Local Street at the northeast frontage of the site is proposed as an interim street, and relies on dedications from future development of the neighboring site to complete the required street width and design. The proposed interim design provides the 12-foot-wide sidewalk, and 20-foot-wide drive lanes taken from an existing curb. Refer to the Land Use Site Plan on A-000.

4.177(.02)C*C. Rights-of-way:**1. Prior to issuance of a Certificate of Occupancy Building permits or as a part of the recordation of a final plat, the City shall require dedication of rights-of-way in accordance with the Transportation System Plan. All dedications shall be recorded with the County Assessor's Office.**2. The City shall also require a waiver of remonstrance against formation of a local improvement district, and all non-remonstrances shall be recorded in the County Recorder's Office as well as the City's Lien Docket, prior to issuance of a Certificate of Occupancy Building Permit or as a part of the recordation of a final plat.**3. In order to allow for potential future widening, a special setback requirement shall be maintained adjacent to all arterial streets. The minimum setback shall be 55 feet from the centerline or 25 feet from the right-of-way designated on the Master Plan, whichever is greater.*

Response: The project includes right-of-way dedications on all four frontages, as noted on the Land Use Site Plan A-000. The three streets are classified as Local Streets, and the northwest property is dedicated as a Pedestrian Accessway. The required documents will be provided to the County for recording after final confirmation of the dedication widths has been given. The required waiver of remonstrance will be recorded at the same time. No arterial streets are adjacent to the development, therefore that criterion is not applicable.

4.177(.02)D*D. Dead-end Streets.*

Response: No dead end streets are proposed or result from the proposed development. Therefore, the criterion is not applicable.

4.177(.02)E.1*E. Corner or clear vision area:*

1. *A clear vision area which meets the Public Works Standards shall be maintained on each corner of property at the intersection of any two streets, a street and a railroad or a street and a driveway. However, the following items shall be exempt from meeting this requirement:*
 - a. *Light and utility poles with a diameter less than 12 inches.*
 - b. *Trees less than six inch d.b.h., approved as a part of the Stage II Site Design, or administrative review.*
 - c. *Except as allowed by b., above, an existing tree, trimmed to the trunk, ten feet above the curb.*
 - d. *Official warning or street sign.*
 - e. *Natural contours where the natural elevations are such that there can be no cross-visibility at the intersection and necessary excavation would result in an unreasonable hardship on the property owner or deteriorate the quality of the site.*

Response: The proposed site plan and adjacent right-of-way improvements are illustrated on the Land Use Site Plan, A-000. Clear vision area is provided at the intersection of Town Center Loop and Park Place, and the intersection of Park Place and the new Local Street. Light poles with diameters less than 12 inches are proposed within the clear vision area. Therefore, the criteria are met.

4.177(.02)F*F. Vertical clearance. A minimum clearance of 12 feet above the pavement surface shall be maintained over all streets and access drives.*

Response: No private streets, or structures above streets, are proposed with this development. Access drives through the on-site parking area are illustrated on A-000, and in drawings 1 and 3 on exhibit A-201. A portion of the access drives are under the footprint of the upper building. A-201 illustrates that the floor to floor height at this location is 16'-0", with a resulting clear height at the parking access drives of 14'-0". Therefore, the criterion is met.

4.177(.02)G*G. Interim improvement standard. It is anticipated that all existing streets, except those in new subdivisions, will require complete reconstruction to support urban level traffic volumes. However, in most cases, existing and short-term projected traffic volumes do not warrant improvements to full Master Plan standards. Therefore, unless otherwise specified by the Development Review Board, the following interim standards shall apply.*

1. *Arterials 24 foot paved, with standard sub-base. Asphalt overlays are generally considered unacceptable, but may be considered as an interim improvement based on the recommendations of the City Engineer, regarding adequate structural quality to support an overlay.*

2. *Half-streets are generally considered unacceptable. However, where the Development Review Board finds it essential to allow for reasonable development, a half-street may be approved. Whenever a half-street improvement is approved, it shall conform to the requirements in the Public Works Standards:*

3. *When considered appropriate in conjunction with other anticipated or scheduled street improvements, the City Engineer may approve street improvements with a single asphalt lift. However, adequate provision must be made for interim storm drainage, pavement transitions at seams and the scheduling of the second lift through the Capital Improvements Plan.*

Response: Street improvements proposed in this development are in accordance with the relevant street sections and streetscape designs in the Town Center Plan and accompanying documents.

4.177(.03)

(.03) Sidewalks. Sidewalks shall be provided on the public street frontage of all development. Sidewalks shall generally be constructed within the dedicated public right-of-way, but may be located outside of the right-of-way within a public easement with the approval of the City Engineer.

A. *Sidewalk widths shall include a minimum through zone of at least five feet. The through zone may be reduced pursuant to variance procedures in Section 4.196, a waiver pursuant to Section 4.118, or by authority of the City Engineer for reasons of traffic operations, efficiency, or safety.*

B. *Within a Planned Development, the Development Review Board may approve a sidewalk on only one side. If the sidewalk is permitted on just one side of the street, the owners will be required to sign an agreement to an assessment in the future to construct the other sidewalk if the City Council decides it is necessary.*

Response: All proposed sidewalks maintain a 6-foot-wide clear pedestrian path and are designed in accordance with the Town Center Plan documents. The development affects 1 side of each street, and therefore includes only one sidewalk on one side of each street. Sidewalks on the other side of each street are maintained and will be required to be maintained or improved by neighboring developments.

4.177(.04)

(.04) Bicycle Facilities. Bicycle facilities shall be provided to implement the Transportation System Plan, and may include on-street and off-street bike lanes, shared lanes, bike boulevards, and cycle tracks. The design of on-street bicycle facilities will vary according to the functional classification and the average daily traffic of the facility.

Response: No bicycle facilities are provided with this development. Existing bike lanes on Town Center Loop are preserved. The preferred cross section for the new Local Street, and the future Park Place Promenade have not been selected. The project provides interim street improvements that do not inhibit the future development of the Local Street and Promenade to include bike lanes if desired.

4.177(.05)

(.05) Multiuse Pathways. Pathways may be in addition to, or in lieu of, a public street. Paths that are in addition to a public street shall generally run parallel to that street, and shall be designed in accordance with the Public Works Standards or as specified by the City Engineer. Paths that are in lieu of a public street shall be considered in areas only where no other public street connection options are feasible, and are subject to the following standards.

- A. Paths shall be located to provide a reasonably direct connection between likely pedestrian and bicyclist destinations. Additional standards relating to entry points, maximum length, visibility, and path lighting are provided in the Public Works Standards.*
- B. To ensure ongoing access to and maintenance of pedestrian/bicycle paths, the City Engineer will require dedication of the path to the public and acceptance of the path by the City as public right-of-way; or creation of a public access easement over the path.*

Response: No Multiuse Pathways are proposed; therefore, the criterion is not applicable.

4.177(.06)

(.06) Transit Improvements. Development on sites that are adjacent to or incorporate major transit streets shall provide improvements as described in this section to any bus stop located along the site's frontage, unless waived by the City Engineer for reasons of safety or traffic operations. Transit facilities include bus stops, shelters, and related facilities. Required transit facility improvements may include the dedication of land or the provision of a public easement.

Response: The development is not adjacent to or incorporate major transit streets, therefore the criterion is not applicable.

4.177(.07)A

(.07) Residential Private Access Drives. Residential Private Access Drives shall meet the following standards:

Response: No Residential Private Access Drives are proposed. Therefore, the criterion is not applicable.

4.177(.08)A.

(.08) Access Drive and Driveway Approach Development Standards:

- A. An access drive to any proposed development shall be designed to provide a clear travel lane free from any obstructions.*

Response: Refer to the Land Use Site Plan, A-000. The access driveway and access drive throughout the on-site parking area are wide enough for two-way traffic, and preserve this width throughout without any obstructions. Therefore, the criterion is met.

4.177(.08)B

B. Access drive travel lanes shall be constructed with a hard surface capable of carrying a 23-ton load.

Response: Access drive travel lanes will occur within the surrounding rights-of-way and streets at Park Place, Town Center Loop, and the new northeast Local Street. The on-site parking area will be utilized by residents only. All travel lanes within the streets will be constructed of concrete per the City's standard details. Therefore, the criterion is met.

4.177(.08)C

C. Where emergency vehicle access is required, approaches and driveways shall be designed and constructed to accommodate emergency vehicle apparatus and shall conform to applicable fire protection requirements. The City may restrict parking, require signage, or require other public safety improvements pursuant to the recommendations of an emergency service provider.

Response: Emergency vehicle access is illustrated in the TVF&R Permit documents, and specifically exhibit FS-1. All emergency vehicle access will be provided in the surrounding street rights-of-way, with apparatus staging areas available along Park Place and the new Local Street. Therefore, the criterion is met.

4.177(.08)D

D. Secondary or emergency access lanes may be improved to a minimum 12 feet with an all-weather surface as approved by the Fire District. All fire lanes shall be dedicated easements.

Response: All emergency access lanes are within surrounding street rights-of-way and are not within private property. Therefore, the 12-foot width and surface requirements are exceeded and the criterion is met.

4.177(.08)E

E. Minimum access requirements shall be adjusted commensurate with the intended function of the site based on vehicle types and traffic generation.

Response: The criterion is not applicable.

4.177(.08)F

F. The number of approaches on higher classification streets (e.g., collector and arterial streets) shall be minimized; where practicable, access shall be taken first from a lower classification street.

Response: All streets surrounding the property are classified as Local Streets. Access to the parking area is taken off of Town Center Loop, which is a Local Street. Therefore, the criterion is met.

4.177(.08)G

G. The City may limit the number or location of connections to a street, or impose access restrictions where the roadway authority requires mitigation to alleviate safety or traffic operations concerns.

Response: The proposed site access is illustrated on exhibit A-000, and is located at the western corner of the site along Town Center Loop. Only this single access is proposed.

4.177(.08)H

H. The City may require a driveway to extend to one or more edges of a lot and be designed to allow for future extension and inter-lot circulation as adjacent properties develop. The City may also require the owner(s) of the subject site to record an access easement for future joint use of the approach and driveway as the adjacent property(ies) develop(s).

Response: The proposed driveway is illustrated on the Land Use Site Plan, exhibit A-000, and is located at the western corner of the site along Town Center Loop. The driveway extends completely from the proposed property line through the sidewalk to the street. Required circulation to

all parking stalls is provided in the on-site parking area via two-way drive aisles, and ample maneuvering clearances are provided for resident vehicles. Therefore, the criterion is met.

4.177(.08)I

I. Driveways shall accommodate all projected vehicular traffic on-site without vehicles stacking or backing up onto a street.

Response: The proposed driveway is illustrated on the Land Use Site Plan, exhibit A-000, and is located at the western corner of the site along Town Center Loop. The driveway extends completely from the proposed property line through the sidewalk to the street. Required circulation to all parking stalls is provided in the on-site parking area via two-way drive aisles, and ample maneuvering clearances are provided for resident vehicles. Therefore, the criterion is met.

4.177(.08)J

J. Driveways shall be designed so that vehicle areas, including but not limited to drive-up and drive-through facilities and vehicle storage and service areas, do not obstruct any public right-of-way.

Response: The proposed driveway is illustrated on the Land Use Site Plan, exhibit A-000, and is located at the western corner of the site along Town Center Loop. The driveway extends completely from the proposed property line through the sidewalk to the street. Required circulation to all parking stalls is provided in the on-site parking area via two-way drive aisles, and ample maneuvering clearances are provided for resident vehicles. Therefore, the criterion is met.

4.177(.08)K

K. Approaches and driveways shall not be wider than necessary to safely accommodate projected peak hour trips and turning movements, and shall be designed to minimize crossing distances for pedestrians

Response: The proposed driveway is illustrated on the Land Use Site Plan, exhibit A-000, and is located at the western corner of the site along Town Center Loop. The driveway extends completely from the proposed property line through the sidewalk to the street. The width of the driveway at the pedestrian path is 20'-0" and is the minimum required for a two-way drive aisle. Therefore, the driveway is the minimum required and meets the criterion.

4.177(.08)L

L. As it deems necessary for pedestrian safety, the City, in consultation with the roadway authority, may require traffic-calming features, such as speed tables, textured driveway surfaces, curb extensions, signage or traffic control devices, or other features, be installed on or in the vicinity of a site.

Response: The criterion is not applicable.

4.177(.08)M

M. Approaches and driveways shall be located and designed to allow for safe maneuvering in and around loading areas, while avoiding conflicts with pedestrians, parking, landscaping, and buildings.

Response: The proposed driveway is illustrated on the Land Use Site Plan, exhibit A-000, and is located at the western corner of the site along Town Center Loop. The driveway extends completely from the proposed property line through the sidewalk to the street. Ample maneuvering is provided through minimum 20-foot-wide, two-way drive aisles on-site and does not conflict with pedestrians, landscaping, or buildings.

4.177(.08)N

N. Where a proposed driveway crosses a culvert or drainage ditch, the City may require the developer to install a culvert extending under and beyond the edges of the driveway on both sides of it, pursuant to applicable Public Works standards.

Response: The proposed driveway does not cross a culvert or ditch; therefore the criterion is not applicable.

4.177(.08)O

O. Except as otherwise required by the applicable roadway authority or waived by the City Engineer, temporary driveways providing access to a construction site or staging area shall be paved or graveled to prevent tracking of mud onto adjacent paved streets.

Response: Temporary access and excavation for construction activity will be designed to applicable codes at the time of building permit submittal.

4.177(.08)P

P. Unless constrained by topography, natural resources, rail lines, freeways, existing or planned or approved development, or easements or covenants, driveways proposed as part of a residential or mixed-use development shall meet local street spacing standards and shall be constructed to align with existing or planned streets, if the driveway.

- 1. Intersects with a public street that is controlled, or is to be controlled in the planning period, by a traffic signal;*
- 2. Intersects with an existing or planned arterial or collector street; or*
- 3. Would be an extension of an existing or planned local street, or of another major driveway.*

Response: The proposed driveway is illustrated on the Land Use Site Plan, exhibit A-000, and is located at the western corner of the site along Town Center Loop. The driveway connects directly to the on-site parking area and runs perpendicular to and completely through the adjacent pedestrian path along Town Center Loop to create the most direct, and shortest path to the street. The driveway is separated from the intersection of Park Place and Town Center Loop by 203'-9". Therefore the criteria are met.

4.177(.09)

(.09) Minimum street intersection spacing standards:

- A. New streets shall intersect at existing street intersections so that centerlines are not offset. Where existing streets adjacent to a proposed development do not align properly, conditions shall be imposed on the development to provide for proper alignment.*
- B. Minimum intersection spacing standards are provided in Transportation System Plan Table 3-2.*

Response: The proposed site plan and surrounding streets included in the development are illustrated on exhibit A-000. The Transportation System Plan table states that the desired intersection space should be between 100 feet minimum, and 300 feet maximum. The project includes the construction of a new Local Street along the northeast frontage. The project provides a functional two-way interim street section and relies on right-of-way dedications and improvements by the neighboring property to fulfill the street design in the Town Center Plan. The center of the proposed Local Street is spaced 211 feet from the intersection of Town Center Loop and Park Place, and therefore falls within the allowable range between 100 feet and 300 feet. In the future, the Local Street will be widened to 60 feet, and the centerline will

be moved northeast. At this time, the centerline will be roughly 250 feet northeast of the intersection with Town Center Loop and therefore will also be within the allowable range. Therefore, the criterion is met.

4.177(.09)

(.10) Exceptions and Adjustments. The City may approve adjustments to the spacing standards of subsections (.08) and (.09) above through a Class II process, or as a waiver per Section 4.118(.03)(A.), where an existing connection to a City street does not meet the standards of the roadway authority, the proposed development moves in the direction of Code compliance, and mitigation measures alleviate all traffic operations and safety concerns. Mitigation measures may include consolidated access (removal of one access), joint use driveways (more than one property uses same access), directional limitations (e.g., one-way), turning restrictions (e.g., right in/out only), or other mitigation.

Response: No exceptions or adjustments to the spacing standards are anticipated with this development.

Section 4.179 Mixed Solid Waste and Recyclables Storage in New Multi-Family Residential and Non-Residential Buildings.

4.179(.01)

(.01) All site plans for multi-family residential and non-residential buildings submitted to the Wilsonville Development Review Board for approval shall include adequate storage space for mixed solid waste and source separated recyclables.

Response: The proposed waste and recyclable storage are illustrated on the Land Use Site Plan, exhibit A-000. The proposed storage space is a shared, interior room at the northwest portion of the site labeled 'Shared Waste and Recycling'. The room has been sized in coordination with Republic Services to appropriately accommodate the anticipated wasted and recycling needs of the 114 residential units, and the proposed commercial spaces. Also refer to documentation of communication with Republic Services in previous pages of this document. Therefore, the criterion is met.

4.179(.02)

(.02) The floor area of an interior or exterior storage area shall be excluded from the calculation of building floor area for purposes of determining minimum storage requirements.

Response: The waste and recycling storage area calculation is determined based on the quantity of residential units, number of stories, and quantity and intensive use of the commercial tenant space.

4.179(.03)

(.03) The storage area requirement shall be based on the predominant use(s) of the building. If a building has more than one of the uses listed herein and that use occupies 20 percent or less of the floor area of the building, the floor area occupied by that use shall be counted toward the floor area of the predominant use(s). If a building has more than one of the uses listed herein and that use occupies more than 20 percent of the floor area of the building, then the storage area requirement for the whole building shall be the sum of the requirement for the area of each use.

Response: The project summary and ground-floor plan is illustrated on exhibit A-000, the Land Use Site Plan. The project is a total 92,397 gross square feet and is predominantly 114 residential multi-family units with 3,707 square feet of commercial tenant space. The commercial space is roughly 4 percent of the overall project; therefore the multi-family standard should be applied when calculating the commercial need for waste and recycling storage space. Given that the multi-family standard is based on a per-unit, rather than floor area standard – the applicant has provided enough wasted and storage area on-site to meet the commercial and residential standards independently. Therefore, the criterion is met.

4.179(.04)

(.04) Storage areas for multiple uses on a single site may be combined and shared.

Response: The proposal utilizes a shared waste and recycling storage room for both residential and retail as illustrated on exhibit A-000. Therefore, the criterion is met.

4.179(.05)

(.05) The specific requirements are based on an assumed storage height of four feet for solid waste/recyclables. Vertical storage higher than four feet but no higher than seven feet may be used to accommodate the same volume of storage in a reduced floor space.

Where vertical or stacked storage is proposed, the site plan shall include drawings to illustrate the layout of the storage area and dimensions for the containers.

Response: The proposed layout and quantity of storage containers is illustrated on exhibit A-000. Further detail is provided in the documented coordination with Republic Services provided in a previous section of this narrative. Therefore, the criterion is met.

4.179(.06)

(.06) The specific requirements for storage area are as follows:

- A. *multi-family residential buildings containing five-ten units shall provide a minimum storage area of 50 square feet. Buildings containing more than ten residential units shall provide an additional five square feet per unit for each unit above ten.*
- B. *Non-residential buildings shall provide a minimum storage area of ten square feet, plus:*
 - 1. *Office: Four square feet per 1,000 square feet gross floor area (GFA);*
 - 2. *Retail: Ten square feet per 1,000 square feet GFA;*
 - 3. *Wholesale/Warehouse/Manufacturing: Six square feet per 1,000 square feet GFA; and*
 - 4. *Other: Four square feet per 1,000 square feet GFA.*

Response: The development has 114 residential units and 3,707 sq. ft. of commercial tenant space (likely retail/cafe). The required on-site waste and recyclable storage area is 557 sq. ft. (520 sq. ft. for residential and 37 sq. ft. for commercial). The proposal includes a 453 sq. ft. shared waste and recycling room on the ground floor, and a 59-sq. ft trash chute room on all upper floors, providing a total of 689 sq. ft. of storage space, exceeding the criterion.

4.179(.07)

(.07) The applicant shall work with the City's franchised garbage hauler to ensure that site plans provide adequate access for the hauler's equipment and that storage area is adequate for the anticipated volumes, level of service and any other special circumstances which may result in the storage area exceeding its capacity. The hauler shall notify the City by letter of their review of site plans and make recommendations for changes in those plans pursuant to the other provisions of this section.

Response: A Service Provide Letter, Trash Room Plan Updates, and a Trash and Loading Sketch has been provided in a previous section of this narrative documenting coordination and approval from Republic Services. Architectural and Civil drawings C-200, and A-000, show designated waste and recycling rooms in the building, and designated areas within the right-of-way of the new local street for days of service. Therefore, the criterion is met.

4.179(.08)

(.08) Existing multi-family residential and non-residential developments wishing to retrofit their structures to include storage areas for mixed solid waste and recycling may have their site plans reviewed and approved through the Class I Administrative Review process, according to the provisions of Section 4.035. Site plans for retrofitting existing developments must conform to all requirements of this Section, "Mixed Solid Waste and Recyclables Storage In New Multi-Family Residential and Non-Residential Buildings," and 4.430, "Location, Design and Access Standards for Mixed Solid Waste and Recycling Areas," of the Wilsonville City Code.

Response: No existing development is proposed to be maintained with this application. Therefore, the criterion is not applicable.

Section 4.199 Outdoor Lighting.

4.199.40(.01)B.

- B. *Prescriptive Option. If the lighting is to comply with this Prescriptive Option, the installed lighting shall meet all of the following requirements according to the designated Lighting Zone.*
1. *The maximum luminaire lamp wattage and shielding shall comply with Table 7.*
 2. *Except for those exemptions listed in Section 4.199.20(.02), the exterior lighting for the site shall comply with the Oregon Energy Efficiency Specialty Code, Exterior Lighting.*
 3. *The maximum pole or mounting height shall be consistent with Table 8.*
 4. *Each luminaire shall be set back from all property lines at least three times the mounting height of the luminaire:*
 - a. *Exception 1: If the subject property abuts a property with the same base and lighting zone, no setback from the common lot lines is required.*
 - b. *Exception 2: If the subject property abuts a property which is zoned (base and lighting) other than the subject parcel, the luminaire shall be setback three times the mounting height of the luminaire, measured from the abutting parcel's setback line. (Any variance or waiver to the abutting property's setback shall not be considered in the distance calculation).*
 - c. *Exception 3: If the luminaire is used for the purpose of street, parking lot or public utility easement illumination and is located less than three mounting heights from the property line, the luminaire shall include a house side shield to protect adjoining property.*
 - d. *Exception 4: If the subject property includes an exterior column, wall or abutment within 25 feet of the property line, a luminaire partly shielded or better and not exceeding 60 lamp watts may be mounted onto the exterior column, wall or abutment or under or within an overhang or canopy attached thereto.*
 - e. *Exception 5: Lighting adjacent to SROZ areas shall be set back three times the mounting height of the luminaire, or shall employ a house side shield to protect the natural resource area.*

Response: Proposed lighting is illustrated on exhibit A-021, Outdoor Lighting Plan. The applicant has provided locations, quantity, and basis-of-design intent illustrations for all types of applicable lighting. These include site-lighting fixtures within the on-site parking area, entry fixtures at the retail entries and primary residential lobby entry, sconces and step lights at each ground-floor residential unit, landscape lights in the Pedestrian Accessway, and light fixtures at upper floor balconies. The applicant is deferring final fixture and lamp specification, and calculations for code compliance to later phases as is typical with design-

build bidding and construction. Code compliance will be demonstrated during the building permit review.

4.199.40(.01)B.

- D. Curfew. All prescriptive or performance based exterior lighting systems shall be controlled by automatic device(s) or system(s) that:*
- 1. Initiate operation at dusk and either extinguish lighting one hour after close or at the curfew times according to Table 10; or*
 - 2. Reduce lighting intensity one hour after close or at the curfew time to not more than 50 percent of the requirements set forth in the Oregon Energy Efficiency Specialty Code unless waived by the DRB due to special circumstances; and*
 - 3. Extinguish or reduce lighting consistent with 1. and 2. above on Holidays.*
- The following are exceptions to curfew:*
- a. Exception 1: Building Code required lighting.*
 - b. Exception 2: Lighting for pedestrian ramps, steps and stairs.*
 - c. Exception 3: Businesses that operate continuously or periodically after curfew.*

Response: All applicable light fixtures will be controlled by an automated system except for fixture 'L.4" at each ground-floor residential unit entry. This light fixture at this location will be resident-operated so that they may be functional and provide illumination at night, however turned off during late hours for livability. All other exterior lights will be controlled to illuminate surrounding site and right-of-way areas for security and safety.

4.199.50(.01)

- (.01) Applicants shall submit the following information as part of DRB review or administrative review of new commercial, industrial, multi-family or public facility projects:*
- A. A statement regarding which of the lighting methods will be utilized, prescriptive or performance, and a map depicting the lighting zone(s) for the property.*
 - B. A site lighting plan that clearly indicates intended lighting by type and location. For adjustable luminaires, the aiming angles or coordinates shall be shown.*
 - C. For each luminaire type, drawings, cut sheets or other documents containing specifications for the intended lighting including but not limited to, luminaire description, mounting, mounting height, lamp type and manufacturer, lamp watts, ballast, optical system/distribution, and accessories such as shields.*
 - D. Calculations demonstrating compliance with Oregon Energy Efficiency Specialty Code, Exterior Lighting, as modified by Section 4.199.40(.01)(B.)(2.)*
 - E. Lighting plans shall be coordinated with landscaping plans so that pole lights and trees are not placed in conflict with one another. The location of lights shall be shown on the landscape plan. Generally, pole lights should not be placed within one pole length of landscape and parking lot trees.*
 - F. Applicants shall identify the hours of lighting curfew.*

Response: The proposal will comply with the prescriptive performance option, and the development is within the LZ3 lighting overlay per the city map. An Outdoor Lighting Plan is provided in

exhibit A-021, and the location, and basis-of-design for each type of fixture is provided. No adjustable exterior light fixtures are proposed.

The applicant is deferring final fixture and lamp specification, and calculations for code compliance to later phases as is typical with design-build bidding and construction. Code compliance will be demonstrated during the building permit review.

4.199.50(.02) (.02) *In addition to the above submittal requirements, Applicants using the Prescriptive Method shall submit the following information as part of the permit set plan review:*
A. *A site lighting plan (items 1.A–F, above) which indicates for each luminaire the three mounting height line to demonstrate compliance with the setback requirements. For luminaires mounted within three mounting heights of the property line the compliance exception or special shielding requirements shall be clearly indicated.*

Response: The applicant is deferring final fixture and lamp specification, and calculations for code compliance to later phases as is typical with design-build bidding and construction. Code compliance will be demonstrated during the building permit review. Setback compliance and mounting heights can be provided at that time.

4.199.50(.03) (.03) *In addition to the above submittal requirements, Applicants using the Performance Method shall submit the following information as part of the permit set plan review:*

Response: The applicant will comply with the Prescriptive Method. Therefore, the criterion is not applicable.

4.199.50(.04) (.04) *In addition to the above applicable submittal requirements, Applicants for Special Permits shall submit the following to the DRB for review:*
A. *Tabulation of International Engineering Society of North America (IESNA) lighting recommendations for each task including area illuminated, recommended illumination level, actual maintained illumination level, and luminaires used specifically to achieve the indicated criteria.*
B. *Lighting plans shall be prepared by a qualified licensed engineer.*

Response: No Special Permits are included in this application; therefore, the criterion is not applicable.

4.199.50(.05) (.05) *For all calculations, the following light loss factors shall be used unless an alternative is specifically approved by the City:*

Metal halide	0.6
High pressure sodium	0.8
Compact fluorescent	0.7
Full size fluorescent	0.75
Incandescent	0.9
Halogen	0.95
Other	As approved

Response: The applicant is deferring final fixture and lamp specification, and calculations for code compliance to later phases as is typical with design-build bidding and construction. Code compliance will be demonstrated during the building permit review. Light loss factor calculations will be given at that time.

Section 4.300 Underground Utilities

4.320(.01)

(.01) The developer or subdivider shall be responsible for and make all necessary arrangements with the serving utility to provide the underground services (including cost of rearranging any existing overhead facilities). All such underground facilities as described shall be constructed in compliance with the rules and regulations of the Public Utility Commission of the State of Oregon relating to the installation and safety of underground lines, plant, system, equipment and apparatus.

Response: Existing utilities are illustrated on exhibit G-102 Existing Survey, and proposed utilities are illustrated on C-300. Three existing easements are preserved at the northeast frontage, and the northwest frontage. Existing power, communication, and water easements along Town Center Loop are proposed to be vacated, and utilities to be relocated underground and aligned to the new right-of-way, out of the footprint of the development. The applicant and the selected general contractor will make all necessary arrangements with the serving utility companies. All work will be completed in compliance with necessary codes.

4.320(.02)

(.02) The location of the buried facilities shall conform to standards supplied to the subdivider by the City. The City also reserves the right to approve location of all surface-mounted transformers.

Response: Proposed underground utilities and an above-ground transformer are illustrated on exhibit C-300.

4.320(.03)

(.03) Interior easements (back lot lines) will only be used for storm or sanitary sewers, and front easements will be used for other utilities unless different locations are approved by the City Engineer. Easements satisfactory to the serving utilities shall be provided by the developer and shall be set forth on the plat.

Response: Existing utilities are illustrated on exhibit G-102 Existing Survey, and proposed utilities are illustrated on C-300. All utility easements utilized by this development will be within street rights-of-way after completion. Two existing easements run diagonally across the southwestern corner of the site, and include sanitary sewer and water mains for neighboring properties. These easements will be unaffected and maintained by this development.

Section 4.421 Criteria and Application of Design Standards

4.421(.01)A.

(.01) The following standards shall be utilized by the Board in reviewing the plans, drawings, sketches and other documents required for Site Design Review. These standards are intended to provide a frame of reference for the applicant in the development of site and building plans as well as a method of review for the Board. These standards shall not be regarded as inflexible requirements. They are not intended to discourage creativity, invention and innovation. The specifications of one or more particular architectural styles is not included in these standards. (Even in the Boones Ferry Overlay Zone, a range of architectural styles will be encouraged.)

A. Preservation of Landscape. The landscape shall be preserved in its natural state, insofar as practicable, by minimizing tree and soils removal, and any grade changes shall be in keeping with the general appearance of neighboring developed areas.

Response: The proposed site plan is illustrated on A-000 and landscaping is illustrated on L-510. An approximately 5'-0" wide strip of existing planting and trees are to remain at the northeastern property line. Trees will be preserved and planting will be preserved to the extend practical. A small portion of existing planting will be preserved along the northwestern property line, and installed to blend with the existing neighbor planting.

4.421(.01)B.

B. Relation of Proposed Buildings to Environment. Proposed structures shall be located and designed to assure harmony with the natural environment, including protection of steep slopes, vegetation and other naturally sensitive areas for wildlife habitat and shall provide proper buffering from less intensive uses in accordance with Sections 4.171 and 4.139 and 4.139.5. The achievement of such relationship may include the enclosure of space in conjunction with other existing buildings or other proposed buildings and the creation of focal points with respect to avenues of approach, street access or relationships to natural features such as vegetation or topography.

Response: No existing steep slopes, significant vegetation, or naturally sensitive areas exist on the site or on adjacent sites. Surrounding properties will be equal or greater intensive uses per the Town Center Plan. The site plan, floor plan, and massing of the building reinforces the street network and envisioned pedestrian connectivity by activating 100% of the Park Place and New Local Street frontages with urban, active space and providing right-of-way design and screening at other frontages to preserve a pleasant pedestrian experience.

4.421(.01)C.

C. Drives, Parking and Circulation. With respect to vehicular and pedestrian circulation, including walkways, interior drives and parking, special attention shall be given to location and number of access points, general interior circulation, separation of pedestrian and vehicular traffic, and arrangement of parking areas that are safe and convenient and, insofar as practicable, do not detract from the design of proposed buildings and structures and the neighboring properties.

Response: Relevant data is illustrated on A-000 Land Use Plan, C-200 Grading Plan, and L-200 Materials Plan. The proposed project is bounded on three sides by rights-of-way comprising 12 foot wide sidewalks, and one frontage by a 15 foot wide dedication and Pedestrian Accessway. The

pedestrian path in each sidewalk is separated from vehicular traffic by the 4-foot wide amenity zone, and raised 6" curb. The drive entry to the off-street parking area is accessed in a single two-way curb-cut off of Town Center Loop which crosses perpendicular to the pedestrian path. Low-screening landscape at this area provides a clear vision angle for drivers and protects pedestrians. Additionally, the driveway is separated from the primary commercial pedestrian walkway along Park Place to mitigate interactions between pedestrians and vehicles. No dead end drive aisles exist within the parking area. Therefore, the criteria are met.

4.421(.01)D.

D. Surface Water Drainage. Special attention shall be given to proper site surface drainage so that removal of surface waters will not adversely affect neighboring properties of the public storm drainage system

Response: Site grading is illustrated on C-200, and utilities and stormwater control are illustrated on C-300.

All temporary and final grading is designed to applicable building and development codes. Surface water and building runoff is contained and treated on site. Sidewalks within the rights-of-way are drained to adjacent stormwater planters and existing stormwater facilities in the rights-of-way.

The proposed design does not drain surface waters onto the public right-of-way in an adverse way. Therefore, the criterion is met.

4.421(.01)E.

E. Utility Service. Any utility installations above ground shall be located so as to have a harmonious relation to neighboring properties and site. The proposed method of sanitary and storm sewage disposal from all buildings shall be indicated.

Response: Utilities are illustrated on exhibit C-300. An above-ground pad-mounted electrical transformer is shown adjacent to the parking area entry on Town Center Loop. The transformer is screened from the adjacent pedestrian path by low-standard landscaping, as illustrated in exhibit L-510. This location and screening treatment creates a harmonious relation to existing above-ground utilities immediate adjacent on the neighboring property to the northwest, and provides a more pleasing pedestrian character along Park Place and the new Local Street.

An above-ground gas service regulator is also located along Town Center Loop where the building façade ends. This location allows the regulator to still be screened by landscaping, and additionally concealed from pedestrians by the corner of the façade.

Therefore, the criterion is met.

4.421(.01)F.

F. Advertising Features. In addition to the requirements of the City's sign regulations, the following criteria should be included: the size, location, design, color, texture, lighting and materials of all exterior signs and outdoor advertising structures or features shall not detract from the design of proposed buildings and structures and the surrounding properties.

Response: Proposed signage is being reviewed under a Class 3 Sign Permit with this application.

Proposed sign locations and intent of building-mounted signs are illustrated on exhibit A-004. Size and location of each intended sign is provided on A-004. The final design of all signs will be deferred to Class 1 sign permits for each commercial tenant.

4.421(.01)G.

G. Special Features. Exposed storage areas, exposed machinery installations, surface areas, truck loading areas, utility buildings and structures and similar accessory areas and structures shall be subject to such setbacks, screen plantings or other screening methods as shall be required to prevent their being incongruous with the existing or contemplated environment and its surrounding properties. Standards for screening and buffering are contained in Section 4.176.

Response: None of the items listed are proposed in the development. Therefore, the criterion is not applicable.

4.421(.02)

(.02) The standards of review outlined in Sections (a) through (g) above shall also apply to all accessory buildings, structures, exterior signs and other site features, however related to the major buildings or structures.

The criterion is not applicable.

4.421(.03)

(.03) The Board shall also be guided by the purpose of Section 4.400, and such objectives shall serve as additional criteria and standards.

Response: The criterion is not applicable.

4.421(.04)

(.04) Conditional application. The Planning Director, Planning Commission, Development Review Board or City Council may, as a Condition of Approval for a zone change, subdivision, land partition, variance, conditional use, or other land use action, require conformance to the site development standards set forth in this Section.

Response: The criterion is not applicable.

4.421(.05)

(.05) The Board may attach certain development or use conditions in granting an approval that are determined necessary to insure the proper and efficient functioning of the development, consistent with the intent of the Comprehensive Plan, allowed densities and the requirements of this Code. In making this determination of compliance and attaching conditions, the Board shall, however, consider the effects of this action on the availability and cost of needed housing. The provisions of this section shall not be used in such a manner that additional conditions either singularly or accumulatively have the effect of unnecessarily increasing the cost of housing or effectively excluding a needed housing type.

Response: The criterion is not applicable.

4.421(.06)

(.06) The Board or Planning Director may require that certain paints or colors of materials be used in approving applications. Such requirements shall only be applied when site development or other land use applications are being reviewed by the City.

A. Where the conditions of approval for a development permit specify that certain paints or colors of materials be used, the use of those paints or colors shall be binding upon the applicant. No Certificate of Occupancy shall be granted until compliance with such conditions has been verified.

B. Subsequent changes to the color of a structure shall not be subject to City review unless the conditions of approval under which the original colors were set included a condition requiring a subsequent review before the colors could be changed.

Response: The criterion is not applicable.

Section 4.430 Location, Design and Access Standards for Mixed Solid Waste and Recycling Areas.

4.430(.02)

(.02) Location Standards:

- A. *To encourage its use, the storage area for source separated recyclables shall be co-located with the storage area for residual mixed solid waste.*
- B. *Indoor and outdoor storage areas shall comply with Uniform Building and Fire Code requirements.*
- C. *Storage area space requirements can be satisfied with a single location or multiple locations and can combine with both interior and exterior locations.*
- D. *Exterior storage areas can be located within interior side yard or rear yard areas. Minimum setback shall be three feet. Exterior storage areas shall not be located within a required front yard setback, including double frontage lots.*
- E. *Exterior storage areas shall be located in central and visible locations on a site to enhance security for users.*
- F. *Exterior storage areas can be located in a parking area if the proposed use provides at least the minimum number of parking spaces required for the use after deducting the area used for storage. Storage areas shall be appropriately screened according to the provisions of Section 4.430(.03), below.*
- G. *The storage area shall be accessible for collection vehicles and located so that the storage area will not obstruct pedestrian or vehicle traffic movement on the site or on public streets adjacent to the site.*

Response: Waste and recycling access and storage areas are illustrated on the Land Use Site Plan (exhibit A-000), and floor plans A-101 through A-105. Residential waste and recycling is stored with commercial waste and recycling in a shared 'waste and recycling' room inside the building at the north corner of the parking area. Additionally, a waste chute access room is provided for residents at each upper floor. Space for recycling bins at each chute access room is also provide. Therefore, criteria A., C. are met.

All indoor and outdoor storage areas will comply with applicable building and fire codes. No exterior storage areas are proposed, therefore criteria D, E, and F are no applicable. The proposed waste and recycling storage room has been located and access has been coordinated with the waste hauler, and the applicant has provided documentation of this coordination in previous pages. The waste and recycling hauler will service the site from the new Local Street. Building management staff will move full waste and recycling containers from the waste and recycling room to the sidewalk adjacent to the new Local Street on days of service. The 'staging' location of the waste and recycling trucks is located at the far northwest corner of the site, allowing convenient service and ensuring the truck will not interfere with neighboring business or traffic. Therefore, criterion G is met.

4.430(.03)

(.03) Design Standards:

- A. *The dimensions of the storage area shall accommodate containers consistent with current methods of local collection.*
- B. *Storage containers shall meet Uniform Fire Code standards and be made of or covered with waterproof materials or situated in a covered area.*

C. Exterior storage areas shall be enclosed by a sight obscuring fence, wall or hedge at least six feet in height. Gate openings for haulers shall be a minimum of ten feet wide and shall be capable of being secured in a closed or open position. In no case shall exterior storage areas be located in conflict with the vision clearance requirements of Section 4.177.

D. Storage area(s) and containers shall be clearly labeled to indicate the type of materials accepted.

Response: Waste and recycling access and storage areas are illustrated on the Land Use Site Plan (exhibit A-000), and floor plans A-101 through A-105. The applicant has also provided documentation of coordination with the local waste and recycling hauler (Republic Services) in previous pages.

The dimensions of the storage room, and quantity of containers, have been confirmed by Republic Services, and criterion A is met.

Storage containers, and the waste and recycling room and chute rooms will be designed to meet all applicable building and fire codes. Therefore, criterion B is met.

No exterior storage areas are proposed; therefore, criterion C is not applicable.

Waste and recycling containers will be clearly labeled, and rules of use and maintenance will be provided for the residents and commercial tenants.

4.430(.04)

(.04) Access Standards:

A. Access to storage areas can be limited for security reasons. However, the storage area shall be accessible to users at convenient times of the day and to collect service personnel on the day and approximate time they are scheduled to provide collection service.

B. Storage areas shall be designed to be easily accessible to collection trucks and equipment, considering paving, grade and vehicle access. A minimum of ten feet horizontal clearance and eight feet of vertical clearance is required if the storage area is covered.

C. Storage areas shall be accessible to collection vehicles without requiring backing out of a driveway onto a public street. If only a single access point is available to the storage area, adequate turning radius shall be provided to allow collection vehicles to safely exit the site in a forward motion.

Response: Waste and recycling access and storage areas are illustrated on the Land Use Site Plan (exhibit A-000), and floor plans A-101 through A-105. Access to all waste storage areas will be limited to residents and commercial tenants for security. Residents, commercial tenants, and building management staff will have convenient keyed or electronic access at all times. The location, size, and access of the ground-floor waste and recycling room has been coordinated and confirmed with the waste hauler (Republic Services). Waste trucks will not enter the site; therefore, the vertical clearance criterion is not applicable. Waste trucks will service the site from the new Local Street at the northwest corner and criterion C is met.

Section 4.600 Tree Preservation and Protection

4.610.10(.01)H. *Except where an application is exempt, or where otherwise noted, the following standards shall govern the review of an application for a Type A, B, C or D Tree Removal Permit: (Relevant subsections included).*

H. Limitation. Tree removal or transplanting shall be limited to instances where the applicant has provided completed information as required by this Chapter and the reviewing authority determines that removal or transplanting is necessary based on the criteria of this subsection.

Response: Existing trees are proposed to be removed and mitigated, or protected both on-site, and in the right-of-way improvements as part of the project. The applicant has provided an Existing Conditions Survey (exhibit G-102), a Tree Preservation and Removal Plan (L-500), and an accompanying Tree Protection Plan report by a certified arborist to document the trees to be removed and mitigated or protected in the project. The species, size, health and structure of existing on-site trees and 4 adjacent off-site trees are described in exhibit L-500 and further described in the arborist's Tree Protection Plan report.

4.610.10(.01)I. *I. Additional Standards for Type C Permits*
1. Tree survey. For all site development applications reviewed under the provisions of Chapter 4 Planning and Zoning, the developer shall provide a Tree Survey before site development as required by WC 4.610.40, and provide a Tree Maintenance and Protection plan, unless specifically exempted by the Planning Director or DRB, prior to initiating site development.

Response: The applicant has provided an Existing Conditions Survey (exhibit G-102), a Tree Preservation and Removal Plan (L-500), and an accompanying Tree Protection Plan report by a certified arborist to comply with requirements of WC 4.610.40. Refer to following narrative response to that code.

4.610.40(.02)A *The applicant must provide ten copies of a Tree Maintenance and Protection Plan completed by an arborist that contains the following information:*
A. A plan, including a topographical survey bearing the stamp and signature of a qualified, registered professional containing all the following information:
1. Property Dimensions. The shape and dimensions of the property, and the location of any existing and proposed structure or improvement.

Response: The applicant has provided an Existing Conditions Survey (exhibit G-102), a Tree Preservation and Removal Plan (L-500), and a Tree Protection Plan report by a certified arborist (see external attachment). The property shape and dimensions are illustrated on G-102, L-500, and further on the Land Use Site Plan (exhibit A-000).

4.610.40(.02)A *2. Tree survey. The survey must include:*
a. An accurate drawing of the site based on accurate survey techniques at a minimum scale of one inch equals 100 feet and which provides a) the location of all trees having six inches or greater d.b.h. likely to be impacted, b) the spread of canopy of those trees, (c)

the common and botanical name of those trees, and d) the approximate location and name of any other trees on the property.

b. A description of the health and condition of all trees likely to be impacted on the site property. In addition, for trees in a present or proposed public street or road right-of-way that are described as unhealthy, the description shall include recommended actions to restore such trees to full health. Trees proposed to remain, to be transplanted or to be removed shall be so designated. All trees to remain on the site are to be designated with metal tags that are to remain in place throughout the development. Those tags shall be numbered, with the numbers keyed to the tree survey map that is provided with the application.

c. Where a stand of 20 or more contiguous trees exist on a site and the applicant does not propose to remove any of those trees, the required tree survey may be simplified to accurately show only the perimeter area of that stand of trees, including its drip line. Only those trees on the perimeter of the stand shall be tagged, as provided in "b," above.

d. All Oregon white oaks, native yews, and any species listed by either the state or federal government as rare or endangered shall be shown in the tree survey.

Response: The applicant has provided an Existing Conditions Survey (exhibit G-102), a Tree Preservation and Removal Plan (L-500), and a Tree Protection Plan report by a certified arborist (see external attachment). All applicable trees are described and scheduled in the separate report, and on L-500. No stand of 20 or more contiguous trees exists on the site, and no Oregon white oaks or relevant Federal listed or endangered species exist.

4.610.40(.02)A

3. Tree Protection. A statement describing how trees intended to remain will be protected during development, and where protective barriers are necessary, that they will be erected before work starts. Barriers shall be sufficiently substantial to withstand nearby construction activities. Plastic tape or similar forms of markers do not constitute "barriers."

Response: The applicant has provided a Tree Protection Plan report by a certified arborist in the external attachments. Tree protection is described for 11 existing trees to remain along the northeast frontage, and the southwest frontage. These trees are illustrated on exhibit L-500, with notes referencing the arborist' Tree Protection Plan report.

4.610.40(.02)A

4. Easements and Setbacks. Location and dimension of existing and proposed easements, as well as all setbacks required by existing zoning requirements.

Response: All existing easements are illustrated on exhibit G-102, Existing Survey. All proposed easements and setbacks are illustrated on the Land Use Site Plan, A-000, and the Utility Plan, C-300.

4.610.40(.02)A

5. Grade Changes. Designation of grade changes proposed for the property that may impact trees.

Response: No significant grade exists or is proposed on the site or project area. Existing grading is included in exhibit G-102, and proposed grading is illustrated on exhibit C-200. Grading around trees marked for tree protection is not significantly altered.

4.610.40(.02)A 6. *Cost of Replacement. A cost estimate for the proposed tree replacement program with a detailed explanation including the number, size and species.*

Response: No trees are proposed to be replaced.

4.610.40(.02)A 7. *Tree Identification. A statement that all trees being retained will be identified by numbered metal tags, as specified in subsection "A," above in addition to clear identification on construction documents.*

Response: All trees to be protected will be identified on-site with numbered metal tags and marked for protection in accordance with the arborist's Tree Protection Plan report.

4.620.00(.01) *Requirement Established. A Type B or C Tree Removal Permit grantee shall replace or relocate each removed tree having six inches or greater d.b.h. within one year of removal.*

Response: Existing trees are proposed to be removed and mitigated, or protected both on-site, and in the right-of-way improvements as part of the project. The applicant has provided an Existing Conditions Survey (exhibit G-102), a Tree Preservation and Removal Plan (L-500), and an accompanying Tree Protection Plan report by a certified arborist to document the trees to be removed and mitigated or protected in the project.

Per L-500, of the 27 on-site existing trees, 20 are proposed to be removed, and 19 of those are greater than 6 inches DBH. As illustrated in exhibit L-510, 26 new trees are proposed exceeding the one-to-one replacement requirement. These new trees will be planted within one year of the removal of existing trees.

4.620.00(.02) *Basis For Determining Replacement. The permit grantee shall replace removed trees on a basis of one tree replanted for each tree removed. All replacement trees must measure two inches or more in diameter. Alternatively, the Planning Director or Development Review Board may require the permit grantee to replace removed trees on a per caliper inch basis, based on a finding that the large size of the trees being removed justifies an increase in the replacement trees required. Except, however, that the Planning Director or Development Review Board may allow the use of replacement Oregon white oaks and other uniquely valuable trees with a smaller diameter.*

Response: As illustrated on L-500, 19 trees proposed for removal meet the standard for required replacement. Per L-510, 26 trees are proposed for installation as a part of the site development, exceeding replacement requirements. Proposed single stem trees are specified to be 2" caliper at installation. Proposed multi-stem trees are specified to be of similar size and quality at installation.

4.620.00(.03) *(.03) Replacement Tree Requirements. A mitigation or replacement tree plan shall be reviewed by the City prior to planting and according to the standards of this subsection.*

A. Replacement trees shall have shade potential or other characteristics comparable to the removed trees, shall be appropriately chosen for the site from an approved tree species list supplied by the City, and shall be state Department of Agriculture Nursery Grade No. 1 or better.

B. Replacement trees must be staked, fertilized and mulched, and shall be guaranteed by the permit grantee or the grantee's successors-in-interest for two years after the planting date.

C. A "guaranteed" tree that dies or becomes diseased during that time shall be replaced.

D. Diversity of tree species shall be encouraged where trees will be replaced, and diversity of species shall also be maintained where essential to preserving a wooded area or habitat.

Response: Existing trees designated for removal are a mix of deciduous shade trees, conifers, and ornamental trees. Proposed trees are a mix of small to medium shade trees derived from recommendations in the City of Wilsonville Town Center Plan Appendix J and multi-stem ornamental trees. Of the 26 proposed trees, five different species are specified and adequately diversify tree species.

Per notes included on L-510, all trees planted as a part of site development are specified to meet the noted standards for quality and maintenance.

4.620.00(.04) (.04) All trees to be planted shall consist of nursery stock that meets requirements of the American Association of Nurserymen (AAN) American Standards for Nursery Stock (ANSI Z60.1) for top grade.

Response: Per notes included on L-510, all trees planted as a part of site development are specified to meet the noted standards for quality.

4.620.00(.05) (.05) Replacement Tree Location.

A. City Review Required. The City shall review tree relocation or replacement plans in order to provide optimum enhancement, preservation and protection of wooded areas. To the extent feasible and desirable, trees shall be relocated or replaced on-site and within the same general area as trees removed.

B. Relocation or Replacement Off-Site. When it is not feasible or desirable to relocate or replace trees on-site, relocation or replacement may be made at another location approved by the City.

Response: Per L-510 replacement trees are to be planted onsite in the same general areas as trees to be removed. Proposed trees are to be planted along the east, south, and west road frontages in intervals and locations consistent with code. Additional trees are to be planted adjacent to parking and along the pedestrian corridor to the north to enhance each of the experience for each of these site elements.

4.620.00(.06) (.06) City Tree Fund. Where it is not feasible to relocate or replace trees on site or at another approved location in the City, the Tree Removal Permit grantee shall pay into the

City Tree Fund, which fund is hereby created, an amount of money approximately the value as defined by this subchapter, of the replacement trees that would otherwise be required by this subchapter. The City shall use the City Tree Fund for the purpose of producing, maintaining and preserving wooded areas and heritage trees, and for planting trees within the City.

A. The City Tree Fund shall be used to offer trees at low cost on a first-come, first-serve basis to any Type A Permit grantee who requests a tree and registers with the City Tree Fund.

B. In addition, and as funds allow, the City Tree Fund shall provide educational materials to assist with tree planting, mitigation, and relocation.

Response: Per L-500, 19 trees proposed for removal meet the standard for required replacement. Per L-510, 26 trees are proposed for installation onsite as a part of the site development. The proposed tree planting exceeding replacement requirements and payment into the tree fund is not necessary, therefore this section does not apply.

Anticipated Waivers:

Waiver 1 – Section 4.132(.06)D. Building Height (Stories)

Table 5 limits buildings in the TC-MU sub-district to 4 stories. The applicant requests that the allowable building height in stories be increased from four to five. Criteria for approval are described in Section 4.118(.03) and Section 4.132(.06) D.

Per 4.118(.03) A, the DRB may waive the following relevant standards in order to implement the purposes and objectives of Section 4.140 :

- Height and yard requirements
- Height of buildings other than signs

The purpose of Section 4.140 Planned Development Regulations is:

(.01) Purpose:

- A. *The provisions of Section 4.140 shall be known as the Planned Development Regulations. The purposes of these regulations are to encourage the development of tracts of land sufficiently large to allow for comprehensive master planning, and to provide flexibility in the application of certain regulations in a manner consistent with the intent of the Comprehensive Plan and general provisions of the zoning regulations and to encourage a harmonious variety of uses through mixed use design within specific developments thereby promoting the economy of shared public services and facilities and a variety of complimentary activities consistent with the land use designation on the Comprehensive Plan and the creation of an attractive, healthful, efficient and stable environment for living, shopping or working.*
- B. *It is the further purpose of the following Section:*
 1. *To take advantage of advances in technology, architectural design, and functional land use design;*
 2. *To recognize the problems of population density, distribution and circulation and to allow a deviation from rigid established patterns of land uses, but controlled by defined policies and objectives detailed in the comprehensive plan;*
 3. *To produce a comprehensive development equal to or better than that resulting from traditional lot land use development.*
 4. *To permit flexibility of design in the placement and uses of buildings and open spaces, circulation facilities and off-street parking areas, and to more efficiently utilize potentials of sites characterized by special features of geography, topography, size or shape or characterized by problems of flood hazard, severe soil limitations, or other hazards;*
 5. *To permit flexibility in the height of buildings while maintaining a ratio of site area to dwelling units that is consistent with the densities established by the Comprehensive Plan and the intent of the Plan to provide open space, outdoor living area and buffering of low-density development.*
 6. *To allow development only where necessary and adequate services and facilities are available or provisions have been made to provide these services and facilities.*
 7. *To permit mixed uses where it can clearly be demonstrated to be of benefit to the users and can be shown to be consistent with the intent of the Comprehensive Plan.*
 8. *To allow flexibility and innovation in adapting to changes in the economic and technological climate.*

Additionally, The Town Center zone purposes per 4.132(.01) are:

The purposes of the TC Zone are to:

- A. *Implement the Town Center policies and implementation measures of the Comprehensive Plan.*

- B. *Implement the Wilsonville Town Center Plan recommendations for the Town Center Comprehensive Plan Map designation.*
- C. *Create a vibrant, walkable destination that inspires people to socialize, shop, live, and work.*
- D. *Support future development that transforms Town Center into the heart of Wilsonville.*
- E. *Foster active parks, civic spaces, and amenities that provide year-round, compelling experiences.*
- F. *Create a development pattern where Wilsonville residents and visitors come for shopping, dining, culture, and entertainment.*

The character of the TC-MU sub-district is described as:

- c. *Mixed Use. A variety of two- to four-story buildings throughout Town Center would provide the mix of residential, commercial and office uses the community is looking to have in Town Center. Moderate activity near Wilsonville Road would be commercially focused while the areas near Town Center Park would include more residential and mixed-use buildings.*

The code allows waivers to development standards to provide flexibility for developments to better meet the goals of the Comprehensive Plan and the Town Center Plan. Prominent and relevant goals of the Comprehensive Plan and Town Center Plan can be paraphrased as:

providing greater densities and types of housing, and a variety of shopping and employment opportunities, all within a vibrant and walkable mixed-use district that would become the “heart of Wilsonville”

The proposed design emphasizes maximizing active-use frontage along the future Promenade and the new northeast Local Street, prioritizing a successful urban pedestrian experience for both frontages. The entire Park Place frontage features ground floor commercial space to highlight the public character, while the primary residential lobby and eight urban ground floor residential units are located along the new Local Street. The building fronts 100% of both frontages, exceeding the 50% standard in the TC zone, establishing a robust precedent for neighboring development to follow suit.

The ground floor frontage along Park Place is entirely commercial tenant use, with highly glazed and durable facades, and canopies for weather protection to encourage year-round use of the sidewalk. The commercial space anchors the east intersection with the new Local Street and is situated to be a primary pedestrian gathering spot with future planned improvements in the Town Center Plan. Along the new Local Street, a similar ground floor façade leads to the primary residential lobby entry. Further northwest, the ground floor steps back 8'-11" from the property line, and the remainder of the frontage is activated by residential units which are raised above the sidewalk and provided with individual entry stoops and raised planters.

The building massing further reinforces the importance of the active and pedestrian oriented ground floor and anchors the Park Place and future Promenade frontage. The design includes a civic-scale, 17-foot-tall ground floor to promote successful and active commercial space and create a more successful typology of ground-floor residences, with finish floors raised 2 feet above and setback from the sidewalk, and tall ceilings to provide natural light and a feeling of openness to the residents. The upper floors of the building are set back 6 feet on Park Place, and 8 feet along the Local Street to give prominence to the commercial ground floor along Park Place and at the primary corner.

The waiver to allow a 5th floor permits the development to provide the envisioned density and variety of housing types while also provide the active commercial use along Park Place that will make the future Promenade successful. The design provides commercial space for the entire frontage along Park Place, increasing street-level activity at this important frontage which would typically be developed as residential

units. In doing so, the proposal meets the Comprehensive Plan goals of providing a variety of much-needed urban housing, employment, and shopping, and sets a development pattern for the promenade and new Local Street that will encourage visitors to make this the heart of Wilsonville.

Section 4.132(.06)D, states that:

D. Waivers to Development Standards. Development standards apply to all new development within the Town Center boundary.

*The Development Review Board (DRB) may approve waivers to the size of the ground floor of a building floorplate and/or the **number of stories of a building within the MU** and C-MU sub-districts, consistent with the provisions of Section 4.118 (.03) if one item from each of the two following menus are met in a manner to clearly go substantially above and beyond Code requirements and typical building and site design to create a sense of place and mitigate negative impacts of the project related to the reason for the waiver. Items chosen from the menus shall account for need based on adjacent sites or the surrounding area:*

Menu One:

- 1. Public amenities, such as a plaza or other community gathering space, incorporated into the building design. Public plaza or other gathering spaces located in a prominent, visible location adjacent to a public street and include movable furniture that is functional and visually interesting.*
- 2. Public community meeting space provided within the building.*
- 3. Provision of ground floor facades that include additional supporting storefronts. The primary entrance of all businesses shall be located on the primary street frontage.*
- 4. Provision of incubator space on site, either within or adjacent to the development that provides below market lease rates for small businesses.*
- 5. Provision of affordable housing on the development site, consistent with the provisions of Table 2, footnote 4.*

Menu Two:

- 1. Innovative building techniques, such as rainwater harvesting, graywater systems, green roofs, or other environmental systems, shall be incorporated into the building design to significantly reduce impact to the environment.*
- 2. Building architecture that creates a distinctive community landmark exemplifying the preferred materials and form for Town Center described in Subsection 4.132(.06)M. and discussed in the Town Center Plan.*
- 3. Pedestrian-oriented and creative lighting incorporated into landscape features and plazas and/or interior window retail displays that are lit at night.*
- 4. Achievement of LEED certification, Earth Advantage, or another recognized environmental certification.*
- 5. Installation of public art, consistent with the provisions of Subsection 4.132(.06)K. for art within plaza areas.*

The proposed design fulfills Menu One, Item 3 by having an active ground-floor use, storefront treatment, and ground-floor scale. The ground-floor is programmed with commercial tenant space for the entire frontage along Park Place and the storefront wraps around the corners at the north and south, resulting in high street-level activity. The commercial storefront along the future Promenade is given prominence by a 16-foot-tall ground floor and a 6-foot setback of the upper floors along Park Place, enhancing the pedestrian experience. Commercial entries and 5-foot deep, 11.5-foot-high canopies provide weather protection along the sidewalk for year-round outdoor seating and mark the public character along Park Place

The design satisfies Menu Two, Item 4 by aiming to achieve certification through the Green Globes Multifamily for New Construction program. This certification program mandates enhancements in energy efficiency, indoor

ventilation, air quality, and construction techniques, as well as product specifications to minimize waste, incorporate renewable resources, and install efficient appliances and fixtures.

Waiver 2– Section 4.132.(.06)M.2.b.ii Building Facades

The applicant requests that the required 6-foot step back at street-facing facades be allowed at the second floor. Criteria for approval are described in Section 4.118(.03) and Section 4.132(.06)D.

Per 4.118(.03)A, the DRB may waive the following relevant standards in order to implement the purposes and objectives of Section 4.140 :

- 3. Height and yard requirements
- 8. Heights of buildings other than signs
- 13. Architectural Design Standards

The purpose of Section 4.140 Planned Development Regulations is:

(.01) Purpose:

- C. *The provisions of Section 4.140 shall be known as the Planned Development Regulations. The purposes of these regulations are to encourage the development of tracts of land sufficiently large to allow for comprehensive master planning, and to provide flexibility in the application of certain regulations in a manner consistent with the intent of the Comprehensive Plan and general provisions of the zoning regulations and to encourage a harmonious variety of uses through mixed use design within specific developments thereby promoting the economy of shared public services and facilities and a variety of complimentary activities consistent with the land use designation on the Comprehensive Plan and the creation of an attractive, healthful, efficient and stable environment for living, shopping or working.*
- D. *It is the further purpose of the following Section:*
1. *To take advantage of advances in technology, architectural design, and functional land use design;*
 2. *To recognize the problems of population density, distribution and circulation and to allow a deviation from rigid established patterns of land uses, but controlled by defined policies and objectives detailed in the comprehensive plan;*
 3. *To produce a comprehensive development equal to or better than that resulting from traditional lot land use development.*
 4. *To permit flexibility of design in the placement and uses of buildings and open spaces, circulation facilities and off-street parking areas, and to more efficiently utilize potentials of sites characterized by special features of geography, topography, size or shape or characterized by problems of flood hazard, severe soil limitations, or other hazards;*
 5. *To permit flexibility in the height of buildings while maintaining a ratio of site area to dwelling units that is consistent with the densities established by the Comprehensive Plan and the intent of the Plan to provide open space, outdoor living area and buffering of low-density development.*
 6. *To allow development only where necessary and adequate services and facilities are available or provisions have been made to provide these services and facilities.*
 7. *To permit mixed uses where it can clearly be demonstrated to be of benefit to the users and can be shown to be consistent with the intent of the Comprehensive Plan.*
 8. *To allow flexibility and innovation in adapting to changes in the economic and technological climate.*

Additionally, The Town Center zone purposes per 4.132(.01) are:

The purposes of the TC Zone are to:

- A. *Implement the Town Center policies and implementation measures of the Comprehensive Plan.*
- B. *Implement the Wilsonville Town Center Plan recommendations for the Town Center Comprehensive Plan Map designation.*

- C. *Create a vibrant, walkable destination that inspires people to socialize, shop, live, and work.*
- D. *Support future development that transforms Town Center into the heart of Wilsonville.*
- E. *Foster active parks, civic spaces, and amenities that provide year-round, compelling experiences.*
- F. *Create a development pattern where Wilsonville residents and visitors come for shopping, dining, culture, and entertainment.*

The character of the TC-MU sub-district is described as:

- c. *Mixed Use. A variety of two- to four-story buildings throughout Town Center would provide the mix of residential, commercial and office uses the community is looking to have in Town Center. Moderate activity near Wilsonville Road would be commercially focused while the areas near Town Center Park would include more residential and mixed-use buildings.*

The proposed building step back is illustrated on drawings A-300, A-200, and A-201. The street-facing facades are the southeast along Park Place, the northeast along the new Local Street, and a portion of the building along Town Center Loop. The building is 5 stories tall, with the required upper stories setback at street facing facades occurring at the second floor.

The building design prioritizes retail and pedestrian frontage on Park Place and the future promenade, differentiated from the residential portions of the building along the new Local Street. A 16-foot-tall conceptual retail 'pavilion' creates a prominent ground-floor along the promenade. Step backs at the second floor along Park Place (7-foot), Town Center Loop (6-foot), and the eastern portion of the Local Street (6-foot) contribute to the 'civic scale'. Durable materials differentiate the ground-floor and complement at-grade landscaping and right-of-way furnishings. Extensive glazing, detailed storefronts, and deep canopies enhance the lively pedestrian atmosphere.

The northwestern section of the Local Street features a ground floor set back 9'11" from the property line, with raised units offering private entry stairs, patios, and layered landscaping for an urban pedestrian experience. The upper floors have a 7.75-foot setback and overhang the ground-level façade by 1.5 feet, creating differentiation and weather protection for residential private entries.

By locating the step back at the second floor rather than the fourth floor, the resulting roofline of the building is the same, and the resulting mass of the building more effectively supports the prominence of the commercial frontage and future Promenade.

Section 4.132(.06) D, states that:

D. Waivers to Development Standards. Development standards apply to all new development within the Town Center boundary.

*The Development Review Board (DRB) may approve waivers to the size of the ground floor of a building floorplate and/or the **number of stories of a building within the MU and C-MU sub-districts**, consistent with the provisions of Section 4.118 (.03) if one item from each of the two following menus are met in a manner to clearly go substantially above and beyond Code requirements and typical building and site design to create a sense of place and mitigate negative impacts of the project related to the reason for the waiver. Items chosen from the menus shall account for need based on adjacent sites or the surrounding area:*

Menu One:

- 1. Public amenities, such as a plaza or other community gathering space, incorporated into the building design. Public plaza or other gathering spaces located in a prominent, visible location adjacent to a public street and include movable furniture that is functional and visually interesting.*
- 2. Public community meeting space provided within the building.*

3. *Provision of ground floor facades that include additional supporting storefronts. The primary entrance of all businesses shall be located on the primary street frontage.*
4. *Provision of incubator space on site, either within or adjacent to the development that provides below market lease rates for small businesses.*
5. *Provision of affordable housing on the development site, consistent with the provisions of Table 2, footnote 4.*

Menu Two:

1. *Innovative building techniques, such as rainwater harvesting, graywater systems, green roofs, or other environmental systems, shall be incorporated into the building design to significantly reduce impact to the environment.*
2. *Building architecture that creates a distinctive community landmark exemplifying the preferred materials and form for Town Center described in Subsection 4.132(.06)M. and discussed in the Town Center Plan.*
3. *Pedestrian-oriented and creative lighting incorporated into landscape features and plazas and/or interior window retail displays that are lit at night.*
4. *Achievement of LEED certification, Earth Advantage, or another recognized environmental certification.*
5. *Installation of public art, consistent with the provisions of Subsection 4.132(.06)K. for art within plaza areas.*

The proposed design fulfills Menu One, Item 3 by having an active ground-floor use, storefront treatment, and ground-floor scale. The ground-floor is programmed with commercial tenant space for the entire frontage along Park Place and the storefront wraps around the corners at the north and south, resulting in high street-level activity. The commercial storefront along the future Promenade is given prominence by a 16-foot-tall ground floor and a 6-foot setback of the upper floors along Park Place, enhancing the pedestrian experience. Commercial entries and 5-foot deep, 11.5-foot-high canopies provide weather protection along the sidewalk for year-round outdoor seating and mark the public character along Park Place

The design satisfies Menu Two, Item 4 by aiming to achieve certification through the Green Globes Multifamily for New Construction program. This certification program mandates enhancements in energy efficiency, indoor ventilation, air quality, and construction techniques, as well as product specifications to minimize waste, incorporate renewable resources, and install efficient appliances and fixtures.

Waiver 3 – Section 4.132.(.06) I.2 Designated residential parking spaces.

The applicant requests parking stalls in the on-site private parking area be permitted to be designated to individual residential tenants. Criteria for approval are described in Section 4.118(.03) and Section 4.132(.06) D.

Per 4.118(.03) A, the DRB may waive the following relevant standards in order to implement the purposes and objectives of Section 4.140:

- 9. Parking space configuration and drive aisle design
- 10. Minimum number of parking or loading
- E.2 Parking ratios and areas expressed in relation to use of various portions of the property and/or building floor area

The purpose of Section 4.140 Planned Development Regulations is:

(.01) Purpose:

- E. *The provisions of Section 4.140 shall be known as the Planned Development Regulations. The purposes of these regulations are to encourage the development of tracts of land sufficiently large to allow for comprehensive master planning, and to provide flexibility in the application of certain regulations in a manner consistent with the intent of the Comprehensive Plan and general provisions of the zoning regulations and to encourage a harmonious variety of uses through mixed use design within specific developments thereby promoting the economy of shared public services and facilities and a variety of complimentary activities consistent with the land use designation on the Comprehensive Plan and the creation of an attractive, healthful, efficient and stable environment for living, shopping or working.*
- F. *It is the further purpose of the following Section:*
1. *To take advantage of advances in technology, architectural design, and functional land use design;*
 2. *To recognize the problems of population density, distribution and circulation and to allow a deviation from rigid established patterns of land uses, but controlled by defined policies and objectives detailed in the comprehensive plan;*
 3. *To produce a comprehensive development equal to or better than that resulting from traditional lot land use development.*
 4. *To permit flexibility of design in the placement and uses of buildings and open spaces, circulation facilities and off-street parking areas, and to more efficiently utilize potentials of sites characterized by special features of geography, topography, size or shape or characterized by problems of flood hazard, severe soil limitations, or other hazards;*
 5. *To permit flexibility in the height of buildings while maintaining a ratio of site area to dwelling units that is consistent with the densities established by the Comprehensive Plan and the intent of the Plan to provide open space, outdoor living area and buffering of low-density development.*
 6. *To allow development only where necessary and adequate services and facilities are available or provisions have been made to provide these services and facilities.*
 7. *To permit mixed uses where it can clearly be demonstrated to be of benefit to the users and can be shown to be consistent with the intent of the Comprehensive Plan.*
 8. *To allow flexibility and innovation in adapting to changes in the economic and technological climate.*

Additionally, The Town Center zone purposes per 4.132(.01) are:

The purposes of the TC Zone are to:

- A. *Implement the Town Center policies and implementation measures of the Comprehensive Plan.*

- B. *Implement the Wilsonville Town Center Plan recommendations for the Town Center Comprehensive Plan Map designation.*
- C. *Create a vibrant, walkable destination that inspires people to socialize, shop, live, and work.*
- D. *Support future development that transforms Town Center into the heart of Wilsonville.*
- E. *Foster active parks, civic spaces, and amenities that provide year-round, compelling experiences.*
- F. *Create a development pattern where Wilsonville residents and visitors come for shopping, dining, culture, and entertainment.*

The character of the TC-MU sub-district is described as:

- c. *Mixed Use. A variety of two- to four-story buildings throughout Town Center would provide the mix of residential, commercial and office uses the community is looking to have in Town Center. Moderate activity near Wilsonville Road would be commercially focused while the areas near Town Center Park would include more residential and mixed-use buildings.*

The proposal's off-street parking is illustrated on A-100 and shows 52 parking stalls and 2 ADA accessible stalls for resident parking. All parking stalls are unbundled and will be for rent by individual tenants., therefore they must be designated for individual residents. The priority will be given to residents needing the accessible stalls. Because this criterion refers to a general category of "off street parking lots" it is inapplicable in this case. Instead, here we have a mixed-use development that does not otherwise have a minimum parking requirement. Parking is being provided in a "tuck under" configuration with some surface parking. Unlike a general "off street parking lot" that can be utilized for a variety of uses in a shared parking arrangement, this lot is designated for residential use and accessory to the residential units. Further, to reduce parking demand, and be consistent the climate friendly amendments to the TPR, these spaces are unbundled and are therefore targeted for rental to the building's residents. Therefore, these residential spaces are not general spaces in an off-street lot and must be designated for individual use.

Under OAR 660-012-0440, this site is either within ¾ mile of a rail stop or ½ mile of a frequent transit corridor. As a result, there is no minimum parking requirement, and the City cannot enforce parking mandates.]

If a waiver is required, the waiver meets the criteria of 4.140(.01) F.2, and F.3; and 4.155(.02)A.2. To reduce parking demand and in furtherance of the CFEC legislation, the off-street parking will be offered at a lower ratio and unbundled. Because, as stated above, this is not a general off-street parking lot that can be shared by multiple users, the criterion that requires all spaces to be non-designated and shared arguably should not apply in this case. The resulting designated use parking spaces at a lower parking ratio will have no significant impact on the neighborhood. Unbundling parking is one of the identified measures to reduce parking demand and reduce carbon emissions within neighborhoods. Residents of this building will not be encouraged to utilize vehicle trips through the provision of excessive or free parking. Rather, residents will have to purchase a parking space, thereby reducing demand and reducing reliance on the single occupancy vehicle. Because the proposal will provide a low parking ratio that is consistent with climate friendly practices and the pedestrian friendly multi modal environment, the neighborhood will not be subject to excessive parking allowances or demands that would otherwise create adverse impacts. Further, because unbundling is an identified climate friendly parking measure, it should be made consistent with a local code provision that requires shared parking of off-street parking lots. To read the CFEC measures consistent with the Wilsonville code, one would conclude that the mandatory shared use provision does not apply to parking lots accessory to residential uses that are operating as unbundled.

Under the second criteria, certainly the development meets the purpose of the section regulating parking. The parking will not be excessive, will meet the identified demand, will be consistent with well managed parking

areas in mixed use areas, will be consistent with climate friendly practices and will be appropriately located on the site in compliance with the access provisions. As background to the CFEC legislation, the state found “excess parking has a significant negative impact on housing costs, business costs, the feasibility of housing development and business redevelopment, walkability, air and water pollution, climate pollution, and general community character. Parking mandates force people who don’t own or use cars to pay indirectly for other people’s parking... About one-sixth of Oregon renter households own zero vehicles.” Thus, this proposal meets the waiver criteria by reducing the parking supply and parking demand and protecting the overall health of the neighborhood and the climate.

Section 4.132(.06)D, states that:

D. Waivers to Development Standards. Development standards apply to all new development within the Town Center boundary.

*The Development Review Board (DRB) may approve waivers to the size of the ground floor of a building floorplate and/or the **number of stories of a building within the MU** and C-MU sub-districts, consistent with the provisions of Section 4.118 (.03) if one item from each of the two following menus are met in a manner to clearly go substantially above and beyond Code requirements and typical building and site design to create a sense of place and mitigate negative impacts of the project related to the reason for the waiver. Items chosen from the menus shall account for need based on adjacent sites or the surrounding area:*

Menu One:

- 6. Public amenities, such as a plaza or other community gathering space, incorporated into the building design. Public plaza or other gathering spaces located in a prominent, visible location adjacent to a public street and include movable furniture that is functional and visually interesting.*
- 7. Public community meeting space provided within the building.*
- 8. Provision of ground floor facades that include additional supporting storefronts. The primary entrance of all businesses shall be located on the primary street frontage.*
- 9. Provision of incubator space on site, either within or adjacent to the development that provides below market lease rates for small businesses.*
- 10. Provision of affordable housing on the development site, consistent with the provisions of Table 2, footnote 4.*

Menu Two:

- 6. Innovative building techniques, such as rainwater harvesting, graywater systems, green roofs, or other environmental systems, shall be incorporated into the building design to significantly reduce impact to the environment.*
- 7. Building architecture that creates a distinctive community landmark exemplifying the preferred materials and form for Town Center described in Subsection 4.132(.06)M. and discussed in the Town Center Plan.*
- 8. Pedestrian-oriented and creative lighting incorporated into landscape features and plazas and/or interior window retail displays that are lit at night.*
- 9. Achievement of LEED certification, Earth Advantage, or another recognized environmental certification.*
- 10. Installation of public art, consistent with the provisions of Subsection 4.132(.06)K. for art within plaza areas.*

The proposed design fulfills Menu One, Item 3 by having an active ground-floor use, storefront treatment, and ground-floor scale. The ground-floor is programmed with commercial tenant space for the entire frontage along Park Place and the storefront wraps around the corners at the north and south, resulting in high street-level activity. The commercial storefront along the future Promenade is given prominence by a 16-foot-tall ground floor and a 6-foot setback of the upper floors along Park Place, enhancing the pedestrian experience. Commercial entries and 5-foot deep, 11.5-foot-high canopies provide weather protection along the sidewalk for year-round outdoor seating and mark the public character along Park Place

The design satisfies Menu Two, Item 4 by aiming to achieve certification through the Green Globes Multifamily for New Construction program. This certification program mandates enhancements in energy efficiency, indoor ventilation, air quality, and construction techniques, as well as product specifications to minimize waste, incorporate renewable resources, and install efficient appliances and fixtures.

Stormwater Management Facilities

Private Stormwater Report

LEVEL WTC

HDG Job #: THA012

Prepared For: Level Development NW
7327 SW Barnes Road, #523
Portland, OR 97225

Prepared By:



**Humber
Design
Group, Inc.**

110 SE Main St. Suite 200
Portland, OR 97214
(P) 503 946 6690



RENEWAL DATE 6/30/2024

Date: March 2, 2023
Revised April 28, 2023

Table of Contents

Project Overview and Description	2
Vicinity Map	3
Methodology	4
Analysis	5
Engineering Conclusions	6

APPENDICES

Appendix A Stormwater Facility Details / Exhibits	A
Catchment Map	
Utility Map	
ADS Chamber System Detail	
LID Planter Detail	
Appendix B Support Calculations	B
HydroCAD Report	
BMP Report	
Conveyance Calculations	
Appendix C Additional Forms & Associated Reports	C
Geotechnical Report	
Infiltration Testing Information	

Project Overview and Description

Location of Project	29690 Town Center Loop W, Wilsonville, OR 97070
Site Area/Acreage	1.09
Proposed Impervious Area	30497
Nearest Cross Street	Park Place
Property Zoning	Town Center Mixed Use(TC-MU)
Existing Conditions	The existing site contains a 1-story commercial building with asphalt parking lot.
Proposed Development	The proposed site will consists of a (5) stories mixed residential and commercial building with parking lot.
Watershed Description	Willamette River
Subwatershed	Willamette River
Tax Map	31W14D
Tax Lot	411
Flood Zone	None
Permits Required	Building Permit DEQ UIC Permit Public Works Permit

Methodology

Existing Drainage

Stormwater on the site is currently conveyed to various catch basins located on the site and sent to the public 36" storm only

Infiltration Results

NV5 Inc. performed (3) falling head infiltration tests. The first was at a depth of 7.5 ft BFG with an infiltration rate of 0.4 in/hr. The second was at a depth of 13 ft BFG with an infiltration rate of 3 in/hr. The last was at a depth of 10 ft BFG with an infiltration rate of 7.2 in/hr. Please see attached infiltration testing information.

PRIVATE Proposed Stormwater Management Techniques

Stormwater will be managed with a combination of an LID planter and an underground infiltration gallery (UIC). Due to the limited infiltration at shallow depths a planter at the surface will not infiltrate the required amount of stormwater. Infiltrating at the greater depth allows the system to be appropriately sized. The system will infiltrate the entire 10 year event and will safely pass both the 25 and 100 year events through the overflow connection to the public system.

PUBLIC Proposed Stormwater Management Techniques

The new local street will be managed with (5) green street planters with orifices. Overflow from planter will be delivered to the existing 36" storm only sewer on new local street.

Due to conflicts with existing infrastructure we are proposing to size the on-site private storm system to account for the impervious areas within the ROW that are impractical to capture and treat entirely within the ROW.

Runoff from the new pedestrian walkway will be managed using a 6' wide vegetated filter strip. Overflows from the filter strip will be collected within a 4" perforate pipe and will be connected to the public system in Town center Loop.

Discharge Point

Runoff from private property will be infiltrated into the ground up to the 10 year storm event. The 25 and 100 year events will overflow with a connection the existing 18" storm only main within Town Center Loop.

Runoff from the new local street will be directed to the 36" storm only sewer.

Analysis

Computational Method Used HydroCAD models of a SBUH Type 1A Storm were used to calculate the stormwater management facility sizes for the catchment areas. See attached calculations. Below is a summary of the results.

Hydrologic Soil Group B

Hydrologic Soil Types Silt Loam

Table 1 – Curve Numbers

Predeveloped Pervious CN	79
Predeveloped Impervious CN	98
Post-Developed Pervious CN	79
Post-Developed Impervious CN	98

Table 2 – Design Storms

WQ Storm	0.83 inches
2-year	2.50 inches
10-year	3.45 inches
25-year	3.90 inches
100-year	4.50 inches

Table 3 – Time of Concentration

Predeveloped TOC	5 min
Post-Developed TOC	5 min

Stormwater Management Narrative Stormwater runoff from the 30,497 sf of proposed impervious area from the private site will be managed with a private stormwater planter and ADS chamber infiltration system. Runoff from parking area will be collected and piped to the stormwater planter for water quality only. Overflow from planter and runoff from roof will be delivered to the infiltration system. Stormwater runoff from the 3,473 SF of proposed impervious area from the Town Center Loop W and Park Place will be trade to private impervious area and managed by private stormwater planter.

Table 4 – Catchment Areas and Facility Table

Catchment/ Facility ID	Source (roof, road, etc.)	Treatment Area (sf)	Ownership (private/ public)	Facility Type/ Function	Facility Size
A	Roof	22,661	Private	Infiltration Chamber	1,845
B	Parking Lot	7,836	Private	LID Planter	175
C	Sidewalk	3,473	Public	LID Planter	145

Engineering Conclusions

The preceding methodologies and calculations presented indicate compliance with the current jurisdictional stormwater management codes and requirements. A summarized breakdown is presented below:

Water Quality

The proposed development will meet the provisions for water quality per the 2015 Stormwater & Surface Water Design & Construction Standards.

Water Quantity

The proposed development will meet the provisions for water quantity per the 2015 Stormwater & Surface Water & Design Construction Standards.

Downstream / Upstream Impacts

There are no upstream or downstream impacts created by this proposed development.

Appendix A

Stormwater Facility Details / Exhibits

Catchment Map

Utility Map

ADS Chamber System Detail

LID Planter Detail

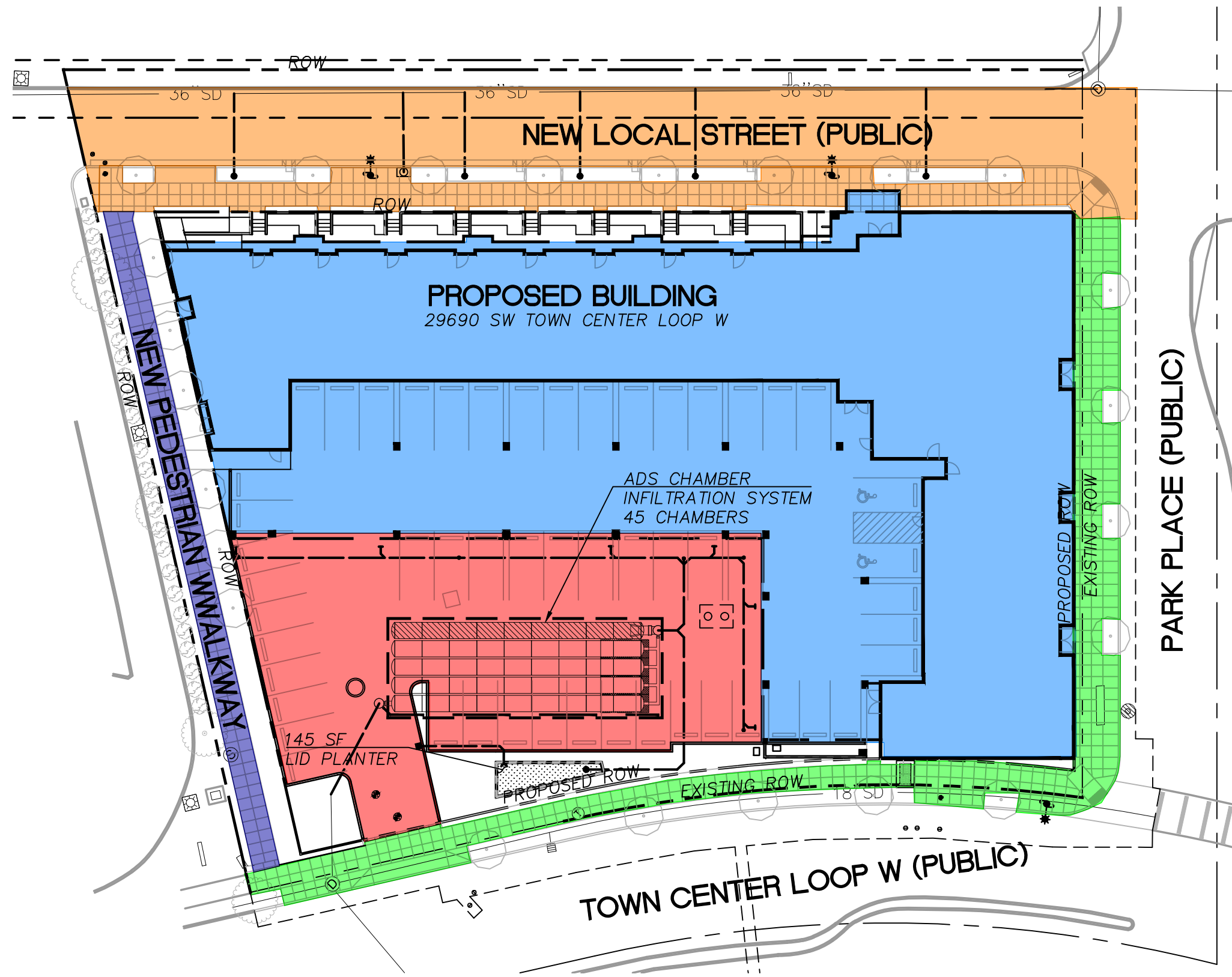

- New Impervious Area (Roof) = 22,661 SF
- New Impervious Area will be treated by LID planter for water quality = 7,836 SF
- Trading public impervious area = 3,473 SF
- New Impervious area will be treated by filter strip = 1,325 SF
- New Impervious Area will be treated by public storm planter = 8,603 SF

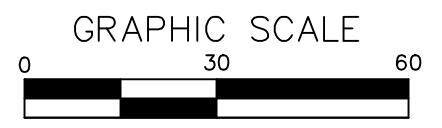
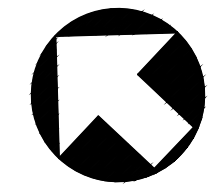

1 inch = 30 ft.
LEVEL WTC
CATCHMENT MAP

PROJECT NO.: THA012 DRAWN BY: MCS DESIGN BY: MCS REVIEWED BY: AKS DATE: 04/27/2023	<p>H Humber Design Group, Inc. <small>Civil Engineering • 503.946.6690 • hdgpx.com</small></p>
--	---



Humber Design Group, Inc.

Civil Engineering
503.946.6690
hdgpd.com

STAMP



RENEWAL DATE 6/30/24

REVISION NO.

DATE

KEY PLAN - (NTS)



**Level WTC
Multifamily**

LEVEL DEVELOPMENT
29690 SW Town Center Loop W
Wilsonville, OR 97070

ISSUANCE
LAND USE REVIEW

PROJECT NUMBER
02219

DATE
04/28/2023

SCALE
AS SHOWN

DRAWING TITLE
UTILITY PLAN

SHEET NUMBER

C-300

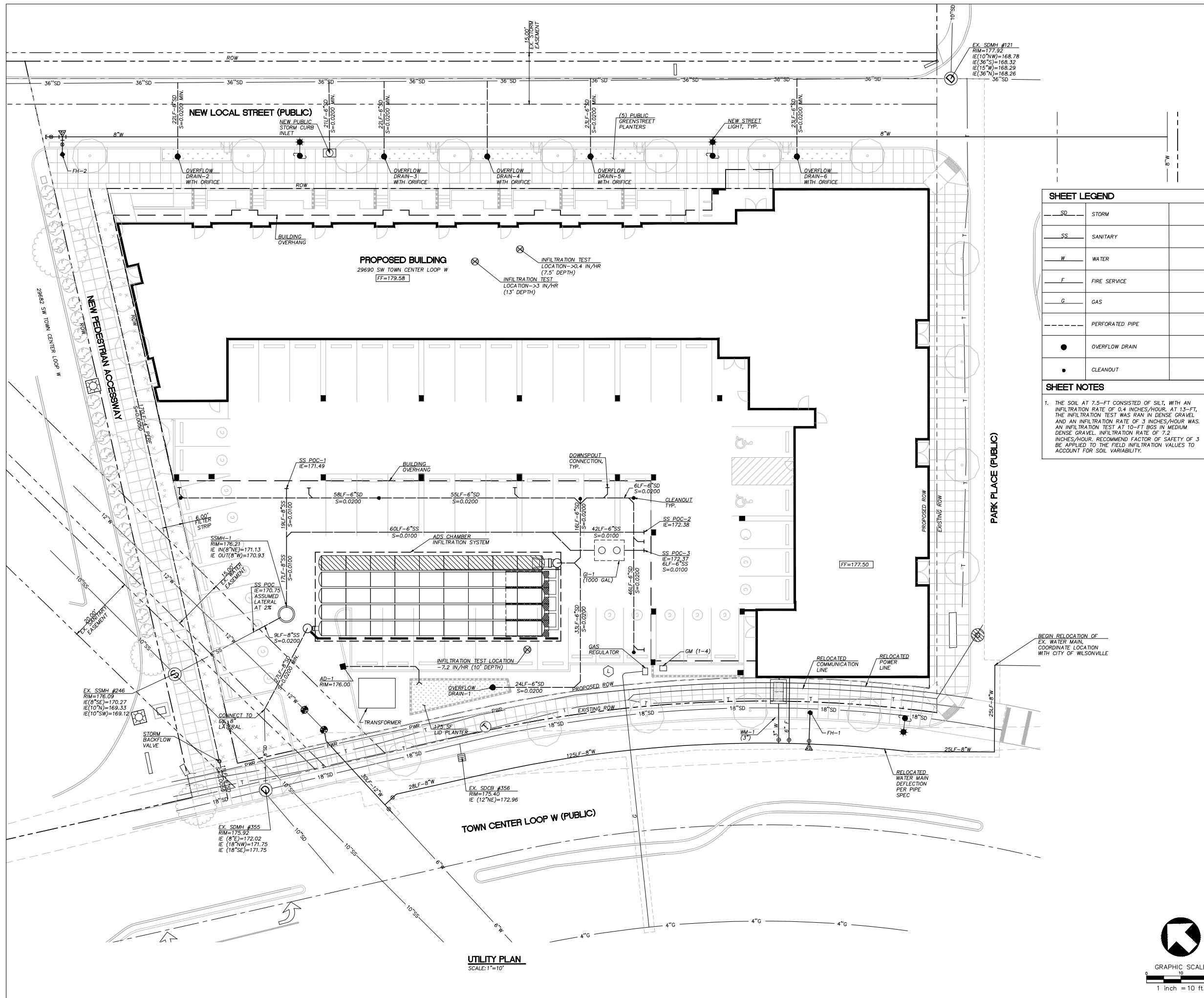

SHEET LEGEND

SD	STORM
SS	SANITARY
W	WATER
F	FIRE SERVICE
G	GAS
---	PERFORATED PIPE
●	OVERFLOW DRAIN
•	CLEANOUT

SHEET NOTES

- THE SOIL AT 7.5-FT CONSISTED OF SILT, WITH AN INFILTRATION RATE OF 0.4 INCHES/HOUR. AT 13-FT, THE INFILTRATION TEST WAS RUN IN DENSE GRAVEL AND AN INFILTRATION RATE OF 3 INCHES/HOUR WAS. AN INFILTRATION TEST AT 10-FT BGS IN MEDIUM DENSE GRAVEL, INFILTRATION RATE OF 7.2 INCHES/HOUR, RECOMMEND FACTOR OF SAFETY OF 3 BE APPLIED TO THE FIELD INFILTRATION VALUES TO ACCOUNT FOR SOIL VARIABILITY.

UTILITY PLAN
SCALE: 1"=10'

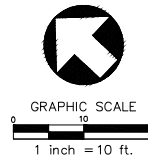

PROJECT INFORMATION	
ENGINEERED PRODUCT MANAGER	
ADS SALES REP	
PROJECT NO.	



Wilsonville

PORTLAND, OR, USA

SC-740 STORMTECH CHAMBER SPECIFICATIONS

1. CHAMBERS SHALL BE STORMTECH SC-740.
2. CHAMBERS SHALL BE ARCH-SHAPED AND SHALL BE MANUFACTURED FROM VIRGIN, IMPACT-MODIFIED POLYPROPYLENE COPOLYMERS.
3. CHAMBERS SHALL MEET THE REQUIREMENTS OF ASTM F2418, "STANDARD SPECIFICATION FOR POLYPROPYLENE (PP) CORRUGATED WALL STORMWATER COLLECTION CHAMBERS".
4. CHAMBER ROWS SHALL PROVIDE CONTINUOUS, UNOBSTRUCTED INTERNAL SPACE WITH NO INTERNAL SUPPORTS THAT WOULD IMPEDE FLOW OR LIMIT ACCESS FOR INSPECTION.
5. THE STRUCTURAL DESIGN OF THE CHAMBERS, THE STRUCTURAL BACKFILL, AND THE INSTALLATION REQUIREMENTS SHALL ENSURE THAT THE LOAD FACTORS SPECIFIED IN THE AASHTO LRFD BRIDGE DESIGN SPECIFICATIONS, SECTION 12.12, ARE MET FOR: 1) LONG-DURATION DEAD LOADS AND 2) SHORT-DURATION LIVE LOADS, BASED ON THE AASHTO DESIGN TRUCK WITH CONSIDERATION FOR IMPACT AND MULTIPLE VEHICLE PRESENCES.
6. CHAMBERS SHALL BE DESIGNED, TESTED AND ALLOWABLE LOAD CONFIGURATIONS DETERMINED IN ACCORDANCE WITH ASTM F2787, "STANDARD PRACTICE FOR STRUCTURAL DESIGN OF THERMOPLASTIC CORRUGATED WALL STORMWATER COLLECTION CHAMBERS". LOAD CONFIGURATIONS SHALL INCLUDE: 1) INSTANTANEOUS (<1 MIN) AASHTO DESIGN TRUCK LIVE LOAD ON MINIMUM COVER 2) MAXIMUM PERMANENT (75-YR) COVER LOAD AND 3) ALLOWABLE COVER WITH PARKED (1-WEEK) AASHTO DESIGN TRUCK.
7. REQUIREMENTS FOR HANDLING AND INSTALLATION:
 - TO MAINTAIN THE WIDTH OF CHAMBERS DURING SHIPPING AND HANDLING, CHAMBERS SHALL HAVE INTEGRAL, INTERLOCKING STACKING LUGS.
 - TO ENSURE A SECURE JOINT DURING INSTALLATION AND BACKFILL, THE HEIGHT OF THE CHAMBER JOINT SHALL NOT BE LESS THAN 2".
 - TO ENSURE THE INTEGRITY OF THE ARCH SHAPE DURING INSTALLATION, a) THE ARCH STIFFNESS CONSTANT SHALL BE GREATER THAN OR EQUAL TO 550 LBS/FT/%. THE ASC IS DEFINED IN SECTION 6.2.8 OF ASTM F2418. AND b) TO RESIST CHAMBER DEFORMATION DURING INSTALLATION AT ELEVATED TEMPERATURES (ABOVE 73° F / 23° C), CHAMBERS SHALL BE PRODUCED FROM REFLECTIVE GOLD OR YELLOW COLORS.
8. ONLY CHAMBERS THAT ARE APPROVED BY THE SITE DESIGN ENGINEER WILL BE ALLOWED. UPON REQUEST BY THE SITE DESIGN ENGINEER OR OWNER, THE CHAMBER MANUFACTURER SHALL SUBMIT A STRUCTURAL EVALUATION FOR APPROVAL BEFORE DELIVERING CHAMBERS TO THE PROJECT SITE AS FOLLOWS:
 - THE STRUCTURAL EVALUATION SHALL BE SEALED BY A REGISTERED PROFESSIONAL ENGINEER.
 - THE STRUCTURAL EVALUATION SHALL DEMONSTRATE THAT THE SAFETY FACTORS ARE GREATER THAN OR EQUAL TO 1.95 FOR DEAD LOAD AND 1.75 FOR LIVE LOAD, THE MINIMUM REQUIRED BY ASTM F2787 AND BY SECTIONS 3 AND 12.12 OF THE AASHTO LRFD BRIDGE DESIGN SPECIFICATIONS FOR THERMOPLASTIC PIPE.
 - THE TEST DERIVED CREEP MODULUS AS SPECIFIED IN ASTM F2418 SHALL BE USED FOR PERMANENT DEAD LOAD DESIGN EXCEPT THAT IT SHALL BE THE 75-YEAR MODULUS USED FOR DESIGN.
9. CHAMBERS AND END CAPS SHALL BE PRODUCED AT AN ISO 9001 CERTIFIED MANUFACTURING FACILITY.

IMPORTANT - NOTES FOR THE BIDDING AND INSTALLATION OF THE SC-740 SYSTEM

1. STORMTECH SC-740 CHAMBERS SHALL NOT BE INSTALLED UNTIL THE MANUFACTURER'S REPRESENTATIVE HAS COMPLETED A PRE-CONSTRUCTION MEETING WITH THE INSTALLERS.
2. STORMTECH SC-740 CHAMBERS SHALL BE INSTALLED IN ACCORDANCE WITH THE "STORMTECH SC-310/SC-740/DC-780 CONSTRUCTION GUIDE".
3. CHAMBERS ARE NOT TO BE BACKFILLED WITH A DOZER OR AN EXCAVATOR SITUATED OVER THE CHAMBERS. STORMTECH RECOMMENDS 3 BACKFILL METHODS:
 - STONESHOOTER LOCATED OFF THE CHAMBER BED.
 - BACKFILL AS ROWS ARE BUILT USING AN EXCAVATOR ON THE FOUNDATION STONE OR SUBGRADE.
 - BACKFILL FROM OUTSIDE THE EXCAVATION USING A LONG BOOM HOE OR EXCAVATOR.
4. THE FOUNDATION STONE SHALL BE LEVELED AND COMPACTED PRIOR TO PLACING CHAMBERS.
5. JOINTS BETWEEN CHAMBERS SHALL BE PROPERLY SEATED PRIOR TO PLACING STONE.
6. MAINTAIN MINIMUM - 6" (150 mm) SPACING BETWEEN THE CHAMBER ROWS.
7. EMBEDMENT STONE SURROUNDING CHAMBERS MUST BE A CLEAN, CRUSHED, ANGULAR STONE 3/4-2" (20-50 mm).
8. THE CONTRACTOR MUST REPORT ANY DISCREPANCIES WITH CHAMBER FOUNDATION MATERIALS BEARING CAPACITIES TO THE SITE DESIGN ENGINEER.
9. ADS RECOMMENDS THE USE OF "FLEXSTORM CATCH IT" INSERTS DURING CONSTRUCTION FOR ALL INLETS TO PROTECT THE SUBSURFACE STORMWATER MANAGEMENT SYSTEM FROM CONSTRUCTION SITE RUNOFF.

NOTES FOR CONSTRUCTION EQUIPMENT

1. STORMTECH SC-740 CHAMBERS SHALL BE INSTALLED IN ACCORDANCE WITH THE "STORMTECH SC-310/SC-740/DC-780 CONSTRUCTION GUIDE".
2. THE USE OF CONSTRUCTION EQUIPMENT OVER SC-740 CHAMBERS IS LIMITED:
 - NO EQUIPMENT IS ALLOWED ON BARE CHAMBERS.
 - NO RUBBER Tired LOADERS, DUMP TRUCKS, OR EXCAVATORS ARE ALLOWED UNTIL PROPER FILL DEPTHS ARE REACHED IN ACCORDANCE WITH THE "STORMTECH SC-310/SC-740/DC-780 CONSTRUCTION GUIDE".
 - WEIGHT LIMITS FOR CONSTRUCTION EQUIPMENT CAN BE FOUND IN THE "STORMTECH SC-310/SC-740/DC-780 CONSTRUCTION GUIDE".
3. FULL 36" (900 mm) OF STABILIZED COVER MATERIALS OVER THE CHAMBERS IS REQUIRED FOR DUMP TRUCK TRAVEL OR DUMPING.

USE OF A DOZER TO PUSH EMBEDMENT STONE BETWEEN THE ROWS OF CHAMBERS MAY CAUSE DAMAGE TO THE CHAMBERS AND IS NOT AN ACCEPTABLE BACKFILL METHOD. ANY CHAMBERS DAMAGED BY THE "DUMP AND PUSH" METHOD ARE NOT COVERED UNDER THE STORMTECH STANDARD WARRANTY.

CONTACT STORMTECH AT 1-888-892-2694 WITH ANY QUESTIONS ON INSTALLATION REQUIREMENTS OR WEIGHT LIMITS FOR CONSTRUCTION EQUIPMENT.

PROPOSED LAYOUT		CONCEPTUAL ELEVATIONS		*INVERT ABOVE BASE OF CHAMBER				
				PART TYPE	ITEM ON LAYOUT	DESCRIPTION	INVERT*	MAX FLOW
45	STORMTECH SC-740 CHAMBERS	MAXIMUM ALLOWABLE GRADE (TOP OF PAVEMENT/UNPAVED):	11.00					
10	STORMTECH SC-740 END CAPS	MINIMUM ALLOWABLE GRADE (UNPAVED WITH TRAFFIC):	5.00					
6	STONE ABOVE (in)	MINIMUM ALLOWABLE GRADE (UNPAVED NO TRAFFIC):	4.50	PREFABRICATED EZ END CAP	A	24" BOTTOM PREFABRICATED EZ END CAP, PART#: SC740ECEZ / TYP OF ALL 24" BOTTOM CONNECTIONS AND ISOLATOR PLUS ROWS	0.10"	
6	STONE BELOW (in)	MINIMUM ALLOWABLE GRADE (TOP OF RIGID CONCRETE PAVEMENT):	4.50	FLAMP	B	INSTALL FLAMP ON 24" ACCESS PIPE / PART#: SC74024RAMP		
40	STONE VOID	MINIMUM ALLOWABLE GRADE (BASE OF FLEXIBLE PAVEMENT):	4.50	MANIFOLD	C	8" x 8" TOP MANIFOLD, MOLDED FITTINGS	16.50"	
3823	INSTALLED SYSTEM VOLUME (CF) (PERIMETER STONE INCLUDED) (COVER STONE INCLUDED) (BASE STONE INCLUDED)	TOP OF STONE:	3.50	NYLOPLAST (INLET W/ ISO PLUS ROW)	D	30" DIAMETER (24.00" SUMP MIN)		2.4 CFS IN
		TOP OF SC-740 CHAMBER:	3.00	NYLOPLAST (OUTLET)	E	30" DIAMETER (DESIGN BY ENGINEER)		2.0 CFS OUT
		8" x 8" TOP MANIFOLD INVERT:	1.88	UNDERDRAIN	F	6" ADS N-12 DUAL WALL PERFORATED HDPE UNDERDRAIN		
1845	SYSTEM AREA (SF)	12" BOTTOM CONNECTION INVERT:	0.60					
194.4	SYSTEM PERIMETER (ft)	24" ISOLATOR ROW PLUS INVERT:	0.51					
		BOTTOM OF SC-740 CHAMBER:	0.50					
		UNDERDRAIN INVERT:	0.00					
		BOTTOM OF STONE:	0.00					

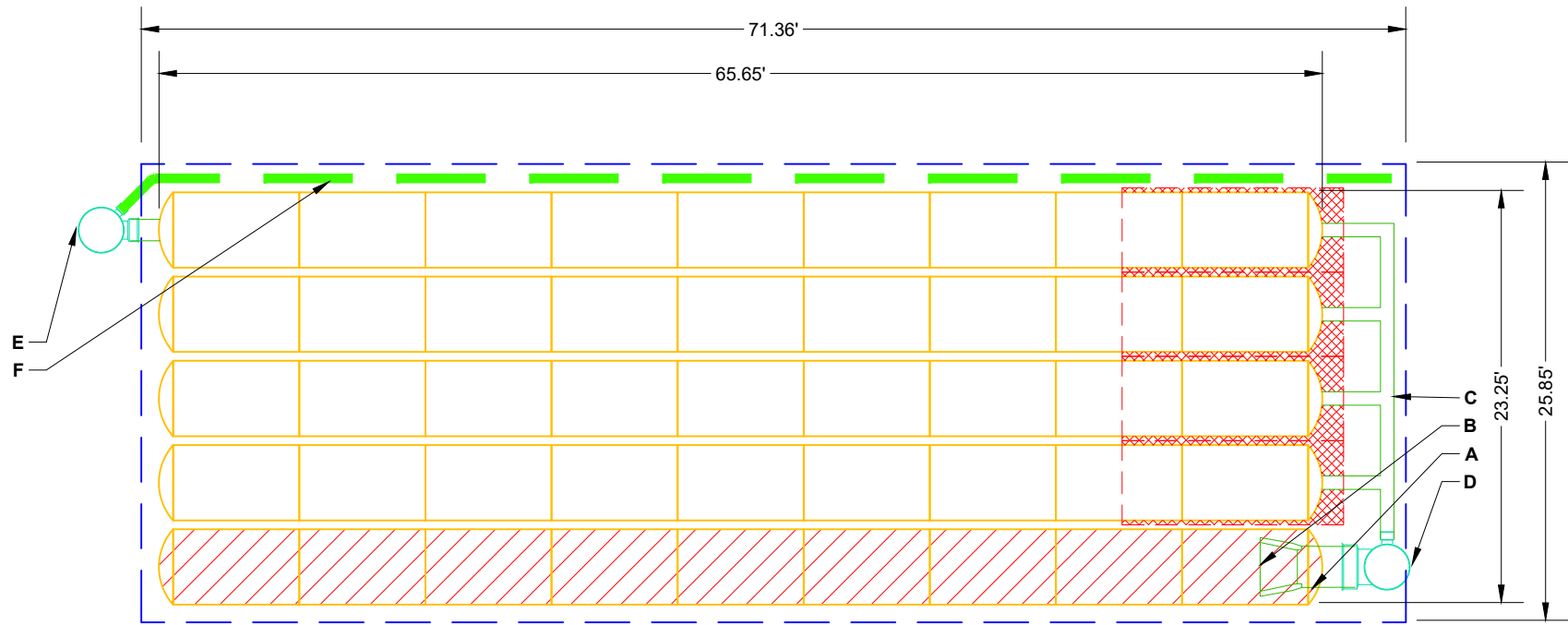

- ISOLATOR ROW PLUS (SEE DETAIL)
- PLACE MINIMUM 12.50' OF ADSPLUS125 WOVEN GEOTEXTILE OVER BEDDING STONE AND UNDERNEATH CHAMBER FEET FOR SCOUR PROTECTION AT ALL CHAMBER INLET ROWS
- BED LIMITS

NOTES

- MANIFOLD SIZE TO BE DETERMINED BY SITE DESIGN ENGINEER. SEE TECH NOTE #6.32 FOR MANIFOLD SIZING GUIDANCE.
- DUE TO THE ADAPTATION OF THIS CHAMBER SYSTEM TO SPECIFIC SITE AND DESIGN CONSTRAINTS, IT MAY BE NECESSARY TO CUT AND COUPLE ADDITIONAL PIPE TO STANDARD MANIFOLD COMPONENTS IN THE FIELD.
- THE SITE DESIGN ENGINEER MUST REVIEW ELEVATIONS AND IF NECESSARY ADJUST GRADING TO ENSURE THE CHAMBER COVER REQUIREMENTS ARE MET.
- THIS CHAMBER SYSTEM WAS DESIGNED WITHOUT SITE-SPECIFIC INFORMATION ON SOIL CONDITIONS OR BEARING CAPACITY. THE SITE DESIGN ENGINEER IS RESPONSIBLE FOR DETERMINING THE SUITABILITY OF THE SOIL AND PROVIDING THE BEARING CAPACITY OF THE INSITU SOILS. THE BASE STONE DEPTH MAY BE INCREASED OR DECREASED ONCE THIS INFORMATION IS PROVIDED.
- **NOT FOR CONSTRUCTION:** THIS LAYOUT IS FOR DIMENSIONAL PURPOSES ONLY TO PROVE CONCEPT & THE REQUIRED STORAGE VOLUME CAN BE ACHIEVED ON SITE.

ASDFSAGA
PORTLAND, OR, USA

DATE: _____
DRAWN: NG
PROJECT #: _____
CHECKED: N/A

StormTech®
Chamber System

888-892-2694 | WWW.STORMTECH.COM

DATE	DRW	CHK	DESCRIPTION

4640 TRUEMAN BLVD
HILLIARD, OH 43026
1-800-733-7473

THIS DRAWING HAS BEEN PREPARED BASED ON INFORMATION PROVIDED TO ADS UNDER THE DIRECTION OF THE SITE DESIGN ENGINEER OR OTHER PROJECT REPRESENTATIVE. THE SITE DESIGN ENGINEER SHALL REVIEW THIS DRAWING PRIOR TO CONSTRUCTION. IT IS THE ULTIMATE RESPONSIBILITY OF THE SITE DESIGN ENGINEER TO ENSURE THAT THE PRODUCT(S) DEPICTED AND ALL ASSOCIATED DETAILS MEET ALL APPLICABLE LAWS, REGULATIONS, AND PROJECT REQUIREMENTS.

SHEET
2 OF 6

ACCEPTABLE FILL MATERIALS: STORMTECH SC-740 CHAMBER SYSTEMS

MATERIAL LOCATION		DESCRIPTION	AASHTO MATERIAL CLASSIFICATIONS	COMPACTION / DENSITY REQUIREMENT
D	FINAL FILL: FILL MATERIAL FOR LAYER 'D' STARTS FROM THE TOP OF THE 'C' LAYER TO THE BOTTOM OF FLEXIBLE PAVEMENT OR UNPAVED FINISHED GRADE ABOVE. NOTE THAT PAVEMENT SUBBASE MAY BE PART OF THE 'D' LAYER.	ANY SOIL/ROCK MATERIALS, NATIVE SOILS, OR PER ENGINEER'S PLANS. CHECK PLANS FOR PAVEMENT SUBGRADE REQUIREMENTS.	N/A	PREPARE PER SITE DESIGN ENGINEER'S PLANS. PAVED INSTALLATIONS MAY HAVE STRINGENT MATERIAL AND PREPARATION REQUIREMENTS.
C	INITIAL FILL: FILL MATERIAL FOR LAYER 'C' STARTS FROM THE TOP OF THE EMBEDMENT STONE ('B' LAYER) TO 18" (450 mm) ABOVE THE TOP OF THE CHAMBER. NOTE THAT PAVEMENT SUBBASE MAY BE A PART OF THE 'C' LAYER.	GRANULAR WELL-GRADED SOIL/AGGREGATE MIXTURES, <35% FINES OR PROCESSED AGGREGATE. MOST PAVEMENT SUBBASE MATERIALS CAN BE USED IN LIEU OF THIS LAYER.	AASHTO M145 ¹ A-1, A-2-4, A-3 OR AASHTO M43 ¹ 3, 357, 4, 467, 5, 56, 57, 6, 67, 68, 7, 78, 8, 89, 9, 10	BEGIN COMPACTIONS AFTER 12" (300 mm) OF MATERIAL OVER THE CHAMBERS IS REACHED. COMPACT ADDITIONAL LAYERS IN 6" (150 mm) MAX LIFTS TO A MIN. 95% PROCTOR DENSITY FOR WELL GRADED MATERIAL AND 95% RELATIVE DENSITY FOR PROCESSED AGGREGATE MATERIALS. ROLLER GROSS VEHICLE WEIGHT NOT TO EXCEED 12,000 lbs (53 kN). DYNAMIC FORCE NOT TO EXCEED 20,000 lbs (89 kN).
B	EMBEDMENT STONE: FILL SURROUNDING THE CHAMBERS FROM THE FOUNDATION STONE ('A' LAYER) TO THE 'C' LAYER ABOVE.	CLEAN, CRUSHED, ANGULAR STONE	AASHTO M43 ¹ 3, 357, 4, 467, 5, 56, 57	NO COMPACTION REQUIRED.
A	FOUNDATION STONE: FILL BELOW CHAMBERS FROM THE SUBGRADE UP TO THE FOOT (BOTTOM) OF THE CHAMBER.	CLEAN, CRUSHED, ANGULAR STONE	AASHTO M43 ¹ 3, 357, 4, 467, 5, 56, 57	PLATE COMPACT OR ROLL TO ACHIEVE A FLAT SURFACE. ^{2,3}

PLEASE NOTE:

- THE LISTED AASHTO DESIGNATIONS ARE FOR GRADATIONS ONLY. THE STONE MUST ALSO BE CLEAN, CRUSHED, ANGULAR. FOR EXAMPLE, A SPECIFICATION FOR #4 STONE WOULD STATE: "CLEAN, CRUSHED, ANGULAR NO. 4 (AASHTO M43) STONE".
- STORMTECH COMPACTION REQUIREMENTS ARE MET FOR 'A' LOCATION MATERIALS WHEN PLACED AND COMPACTED IN 6" (150 mm) (MAX) LIFTS USING TWO FULL COVERAGES WITH A VIBRATORY COMPACTOR.
- WHERE INFILTRATION SURFACES MAY BE COMPROMISED BY COMPACTION, FOR STANDARD DESIGN LOAD CONDITIONS, A FLAT SURFACE MAY BE ACHIEVED BY RAKING OR DRAGGING WITHOUT COMPACTION EQUIPMENT. FOR SPECIAL LOAD DESIGNS, CONTACT STORMTECH FOR COMPACTION REQUIREMENTS.
- ONCE LAYER 'C' IS PLACED, ANY SOIL/MATERIAL CAN BE PLACED IN LAYER 'D' UP TO THE FINISHED GRADE. MOST PAVEMENT SUBBASE SOILS CAN BE USED TO REPLACE THE MATERIAL REQUIREMENTS OF LAYER 'C' OR 'D' AT THE SITE DESIGN ENGINEER'S DISCRETION.

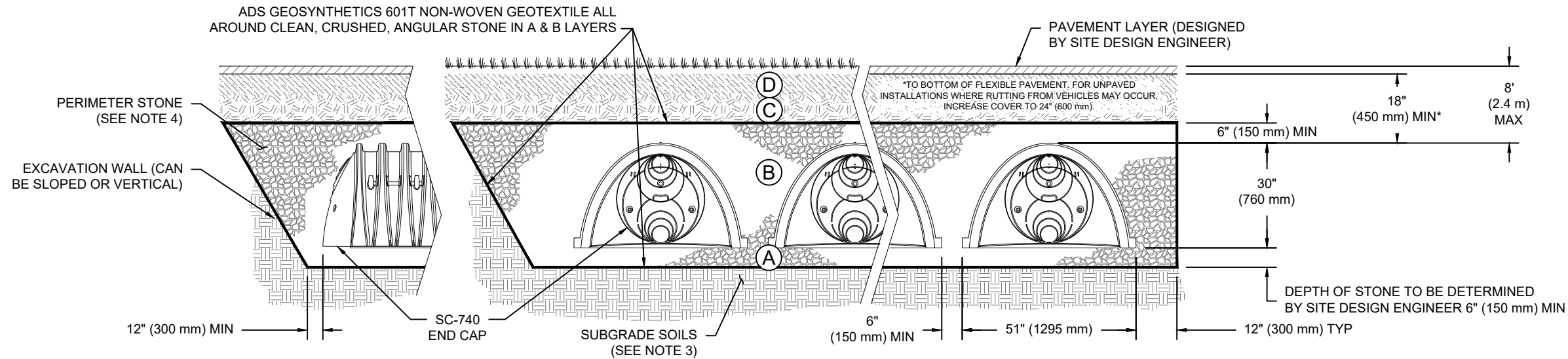

NOTES:

- CHAMBERS SHALL MEET THE REQUIREMENTS OF ASTM F2418, "STANDARD SPECIFICATION FOR POLYPROPYLENE (PP) CORRUGATED WALL STORMWATER COLLECTION CHAMBERS".
- SC-740 CHAMBERS SHALL BE DESIGNED IN ACCORDANCE WITH ASTM F2787 "STANDARD PRACTICE FOR STRUCTURAL DESIGN OF THERMOPLASTIC CORRUGATED WALL STORMWATER COLLECTION CHAMBERS".
- THE SITE DESIGN ENGINEER IS RESPONSIBLE FOR ASSESSING THE BEARING RESISTANCE (ALLOWABLE BEARING CAPACITY) OF THE SUBGRADE SOILS AND THE DEPTH OF FOUNDATION STONE WITH CONSIDERATION FOR THE RANGE OF EXPECTED SOIL MOISTURE CONDITIONS.
- PERIMETER STONE MUST BE EXTENDED HORIZONTALLY TO THE EXCAVATION WALL FOR BOTH VERTICAL AND SLOPED EXCAVATION WALLS.
- REQUIREMENTS FOR HANDLING AND INSTALLATION:
 - TO MAINTAIN THE WIDTH OF CHAMBERS DURING SHIPPING AND HANDLING, CHAMBERS SHALL HAVE INTEGRAL, INTERLOCKING STACKING LUGS.
 - TO ENSURE A SECURE JOINT DURING INSTALLATION AND BACKFILL, THE HEIGHT OF THE CHAMBER JOINT SHALL NOT BE LESS THAN 2".
 - TO ENSURE THE INTEGRITY OF THE ARCH SHAPE DURING INSTALLATION, a) THE ARCH STIFFNESS CONSTANT SHALL BE GREATER THAN OR EQUAL TO 550 LBS/FT/%. THE ASC IS DEFINED IN SECTION 6.2.8 OF ASTM F2418. AND b) TO RESIST CHAMBER DEFORMATION DURING INSTALLATION AT ELEVATED TEMPERATURES (ABOVE 73° F / 23° C), CHAMBERS SHALL BE PRODUCED FROM REFLECTIVE GOLD OR YELLOW COLORS.

ASDFSAGA	PORTLAND, OR, USA	DRAWN: NG	CHECKED: N/A
	DATE:		PROJECT #:
			DESCRIPTION
			CHK
			DATE
			DRW
			CHK
			DATE
			DRW
			CHK
			DATE
			DRW
			CHK
			DATE
			DRW
			CHK
			DATE
			DRW
			CHK
			DATE
			DRW
			CHK
			DATE
			DRW
			CHK
			DATE
			DRW
			CHK
			DATE
			DRW
			CHK
			DATE
			DRW
			CHK
			DATE
			DRW
			CHK
			DATE
			DRW
			CHK
			DATE
			DRW
			CHK
			DATE
			DRW
			CHK
			DATE
			DRW
			CHK
			DATE
			DRW
			CHK
			DATE
			DRW
			CHK
			DATE
			DRW
			CHK
			DATE
			DRW
			CHK
			DATE
			DRW
			CHK
			DATE
			DRW
			CHK
			DATE
			DRW
			CHK
			DATE
			DRW
			CHK
			DATE
			DRW
			CHK
			DATE
			DRW
			CHK
			DATE
			DRW
			CHK
			DATE
			DRW
			CHK
			DATE
			DRW
			CHK
			DATE
			DRW
			CHK
			DATE
			DRW
			CHK
			DATE
			DRW
			CHK
			DATE
			DRW
			CHK
			DATE
			DRW
			CHK
			DATE
			DRW
			CHK
			DATE
			DRW
			CHK
			DATE
			DRW
			CHK
			DATE
			DRW
			CHK
			DATE
			DRW
			CHK
			DATE
			DRW
			CHK
			DATE
			DRW
			CHK
			DATE
			DRW
			CHK
			DATE
			DRW
			CHK
			DATE
			DRW
			CHK
			DATE
			DRW
			CHK
			DATE
			DRW
			CHK
			DATE
			DRW
			CHK
			DATE

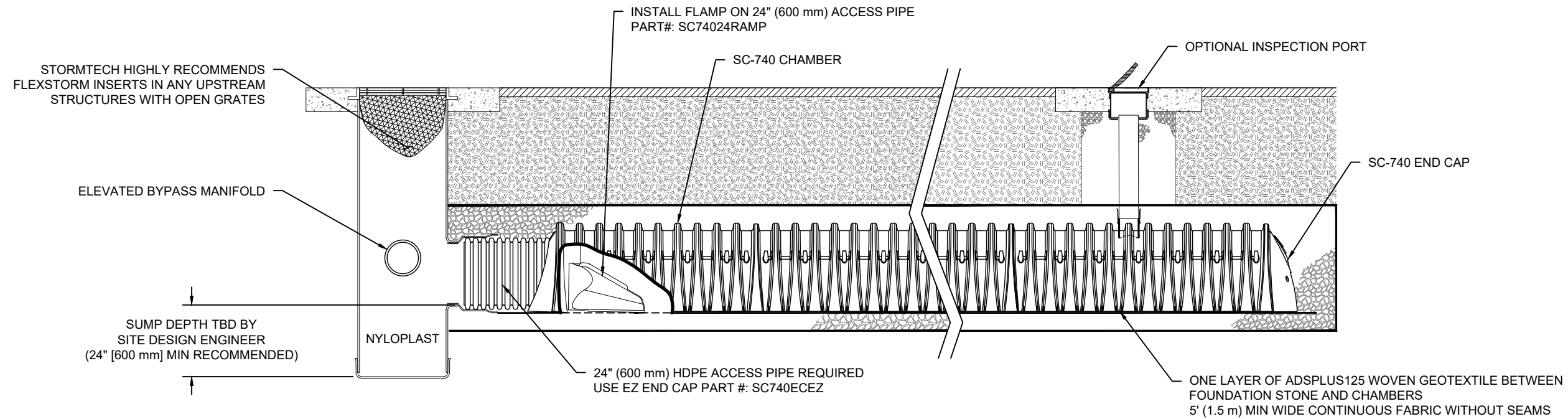

SC-740 ISOLATOR ROW PLUS DETAIL
NTS

INSPECTION & MAINTENANCE

- STEP 1) INSPECT ISOLATOR ROW PLUS FOR SEDIMENT
- A. INSPECTION PORTS (IF PRESENT)
 - A.1. REMOVE/OPEN LID ON NYLOPLAST INLINE DRAIN
 - A.2. REMOVE AND CLEAN FLEXSTORM FILTER IF INSTALLED
 - A.3. USING A FLASHLIGHT AND STADIA ROD, MEASURE DEPTH OF SEDIMENT AND RECORD ON MAINTENANCE LOG
 - A.4. LOWER A CAMERA INTO ISOLATOR ROW PLUS FOR VISUAL INSPECTION OF SEDIMENT LEVELS (OPTIONAL)
 - A.5. IF SEDIMENT IS AT, OR ABOVE, 3" (80 mm) PROCEED TO STEP 2. IF NOT, PROCEED TO STEP 3.
 - B. ALL ISOLATOR PLUS ROWS
 - B.1. REMOVE COVER FROM STRUCTURE AT UPSTREAM END OF ISOLATOR ROW PLUS
 - B.2. USING A FLASHLIGHT, INSPECT DOWN THE ISOLATOR ROW PLUS THROUGH OUTLET PIPE
 - i) MIRRORS ON POLES OR CAMERAS MAY BE USED TO AVOID A CONFINED SPACE ENTRY
 - ii) FOLLOW OSHA REGULATIONS FOR CONFINED SPACE ENTRY IF ENTERING MANHOLE
 - B.3. IF SEDIMENT IS AT, OR ABOVE, 3" (80 mm) PROCEED TO STEP 2. IF NOT, PROCEED TO STEP 3.
- STEP 2) CLEAN OUT ISOLATOR ROW PLUS USING THE JETVAC PROCESS
- A. A FIXED CULVERT CLEANING NOZZLE WITH REAR FACING SPREAD OF 45" (1.1 m) OR MORE IS PREFERRED
 - B. APPLY MULTIPLE PASSES OF JETVAC UNTIL BACKFLUSH WATER IS CLEAN
 - C. VACUUM STRUCTURE SUMP AS REQUIRED
- STEP 3) REPLACE ALL COVERS, GRATES, FILTERS, AND LIDS; RECORD OBSERVATIONS AND ACTIONS.
- STEP 4) INSPECT AND CLEAN BASINS AND MANHOLES UPSTREAM OF THE STORMTECH SYSTEM.

NOTES

1. INSPECT EVERY 6 MONTHS DURING THE FIRST YEAR OF OPERATION. ADJUST THE INSPECTION INTERVAL BASED ON PREVIOUS OBSERVATIONS OF SEDIMENT ACCUMULATION AND HIGH WATER ELEVATIONS.
2. CONDUCT JETTING AND VACTORING ANNUALLY OR WHEN INSPECTION SHOWS THAT MAINTENANCE IS NECESSARY.

ASDFSAGA	PORTLAND, OR, USA	DATE:	DRAWN: NG	CHECKED: N/A
		PROJECT #:		
		DESCRIPTION		
		CHK		
		DATE		
		DRW		
		888-892-2694 WWW.STORMTECH.COM		
4640 TRUEMAN BLVD HILLIARD, OH 43026 1-800-733-7473				
THIS DRAWING HAS BEEN PREPARED BASED ON INFORMATION PROVIDED TO ADS UNDER THE DIRECTION OF THE SITE DESIGN ENGINEER OR OTHER PROJECT REPRESENTATIVE. THE SITE DESIGN ENGINEER SHALL REVIEW THIS DRAWING PRIOR TO CONSTRUCTION. IT IS THE ULTIMATE RESPONSIBILITY OF THE SITE DESIGN ENGINEER TO ENSURE THAT THE PRODUCT(S) DEPICTED AND ALL ASSOCIATED DETAILS MEET ALL APPLICABLE LAWS, REGULATIONS, AND PROJECT REQUIREMENTS.				
		SHEET 4 OF 6		

UNDERDRAIN DETAIL

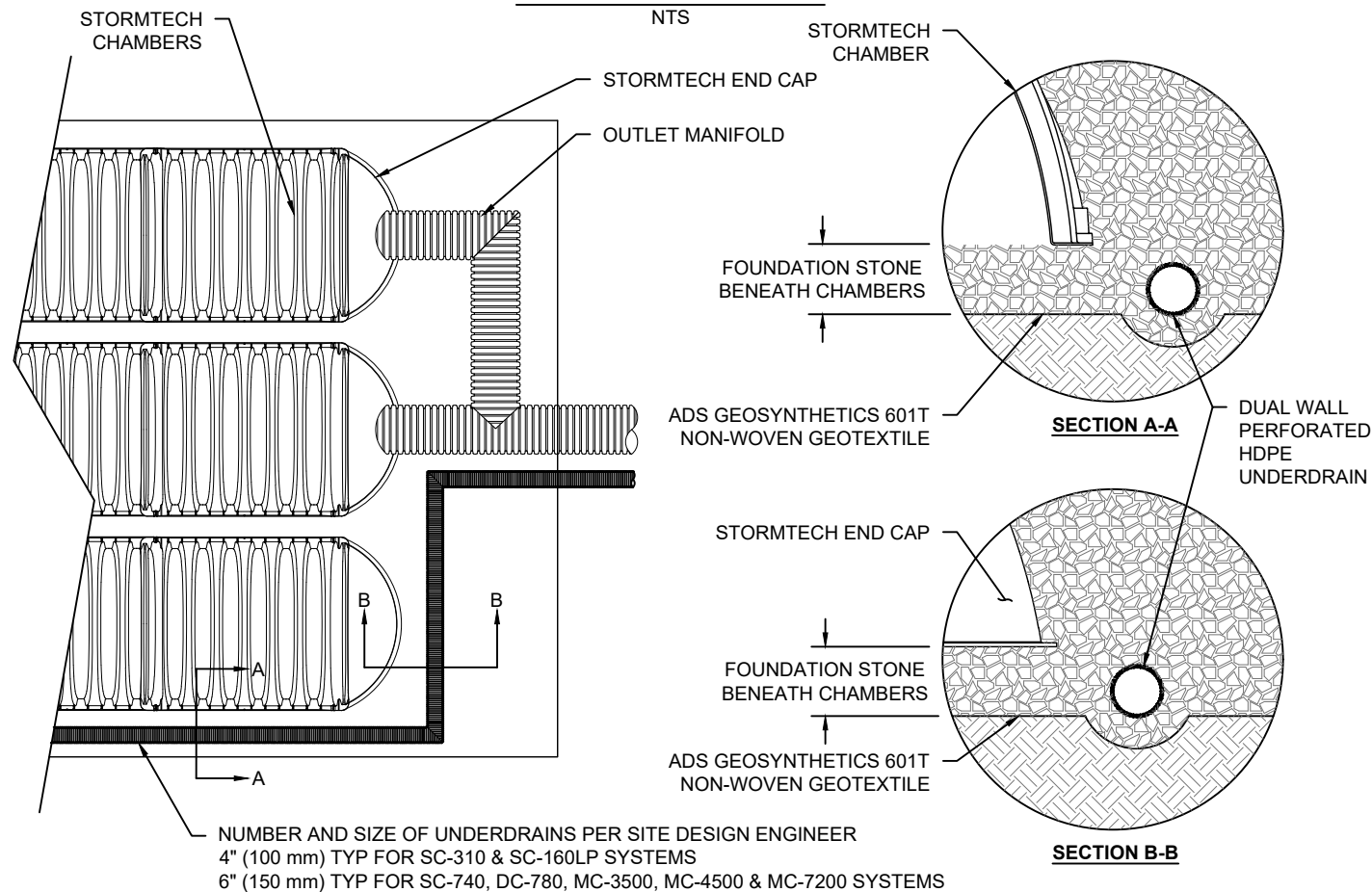

SC-740 TECHNICAL SPECIFICATION

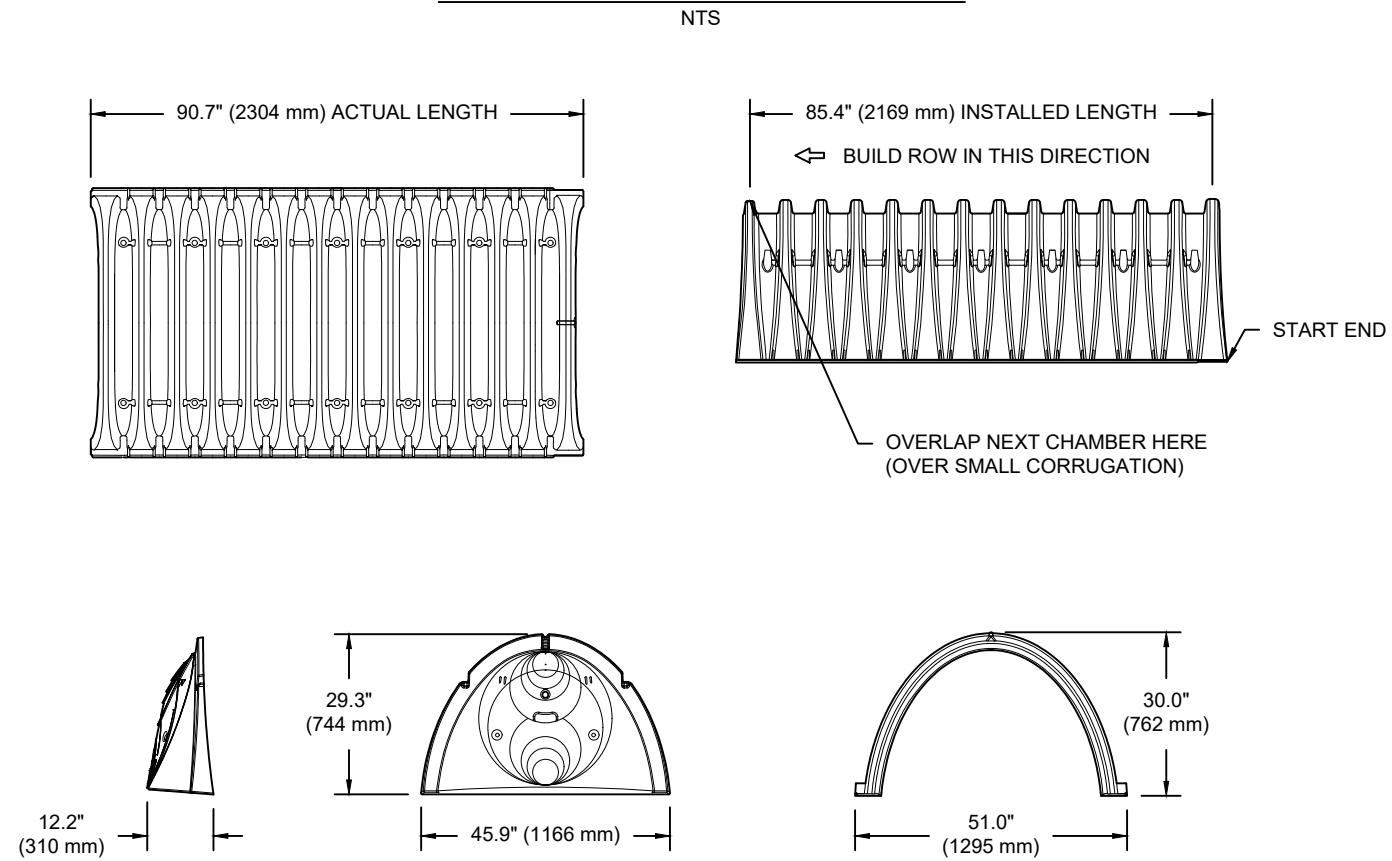

NOMINAL CHAMBER SPECIFICATIONS

SIZE (W X H X INSTALLED LENGTH)	51.0" X 30.0" X 85.4"	(1295 mm X 762 mm X 2169 mm)
CHAMBER STORAGE	45.9 CUBIC FEET	(1.30 m ³)
MINIMUM INSTALLED STORAGE*	74.9 CUBIC FEET	(2.12 m ³)
WEIGHT	75.0 lbs.	(33.6 kg)

*ASSUMES 6" (152 mm) STONE ABOVE, BELOW, AND BETWEEN CHAMBERS

PRE-FAB STUB AT BOTTOM OF END CAP WITH FLAMP END WITH "BR"
 PRE-FAB STUBS AT BOTTOM OF END CAP FOR PART NUMBERS ENDING WITH "B"
 PRE-FAB STUBS AT TOP OF END CAP FOR PART NUMBERS ENDING WITH "T"
 PRE-CORED END CAPS END WITH "PC"

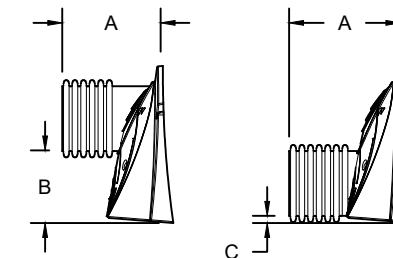

PART #	STUB	A	B	C
SC740EPE06T / SC740EPE06TPC	6" (150 mm)	10.9" (277 mm)	18.5" (470 mm)	---
SC740EPE06B / SC740EPE06BPC	---	---	---	0.5" (13 mm)
SC740EPE08T / SC740EPE08TPC	8" (200 mm)	12.2" (310 mm)	16.5" (419 mm)	---
SC740EPE08B / SC740EPE08BPC	---	---	---	0.6" (15 mm)
SC740EPE10T / SC740EPE10TPC	10" (250 mm)	13.4" (340 mm)	14.5" (368 mm)	---
SC740EPE10B / SC740EPE10BPC	---	---	---	0.7" (18 mm)
SC740EPE12T / SC740EPE12TPC	12" (300 mm)	14.7" (373 mm)	12.5" (318 mm)	---
SC740EPE12B / SC740EPE12BPC	---	---	---	1.2" (30 mm)
SC740EPE15T / SC740EPE15TPC	15" (375 mm)	18.4" (467 mm)	9.0" (229 mm)	---
SC740EPE15B / SC740EPE15BPC	---	---	---	1.3" (33 mm)
SC740EPE18T / SC740EPE18TPC	18" (450 mm)	19.7" (500 mm)	5.0" (127 mm)	---
SC740EPE18B / SC740EPE18BPC	---	---	---	1.6" (41 mm)
SC740ECEZ*	24" (600 mm)	18.5" (470 mm)	---	0.1" (3 mm)

ALL STUBS, EXCEPT FOR THE SC740ECEZ ARE PLACED AT BOTTOM OF END CAP SUCH THAT THE OUTSIDE DIAMETER OF THE STUB IS FLUSH WITH THE BOTTOM OF THE END CAP. FOR ADDITIONAL INFORMATION CONTACT STORMTECH AT 1-888-892-2694.

* FOR THE SC740ECEZ THE 24" (600 mm) STUB LIES BELOW THE BOTTOM OF THE END CAP APPROXIMATELY 1.75" (44 mm). BACKFILL MATERIAL SHOULD BE REMOVED FROM BELOW THE N-12 STUB SO THAT THE FITTING SITS LEVEL.

NOTE: ALL DIMENSIONS ARE NOMINAL

ASDFSAGA
 PORTLAND, OR, USA
 DRAWN: NG
 CHECKED: N/A

DATE: _____ PROJECT #: _____

DESCRIPTION _____

DATE _____ CHK _____

DATE _____

StormTech®
 Chamber System
 888-892-2694 | WWW.STORMTECH.COM

4640 TRUEMAN BLVD
 HILLIARD, OH 43026
 1-800-733-7473

SHEET
5 OF 6

THIS DRAWING HAS BEEN PREPARED BASED ON INFORMATION PROVIDED TO ADS UNDER THE DIRECTION OF THE SITE DESIGN ENGINEER OR OTHER PROJECT REPRESENTATIVE. THE SITE DESIGN ENGINEER SHALL REVIEW THIS DRAWING PRIOR TO CONSTRUCTION. IT IS THE ULTIMATE RESPONSIBILITY OF THE SITE DESIGN ENGINEER TO ENSURE THAT THE PRODUCT(S) DEPICTED AND ALL ASSOCIATED DETAILS MEET ALL APPLICABLE LAWS, REGULATIONS, AND PROJECT REQUIREMENTS.

NYLOPLAST DRAIN BASIN

NTS

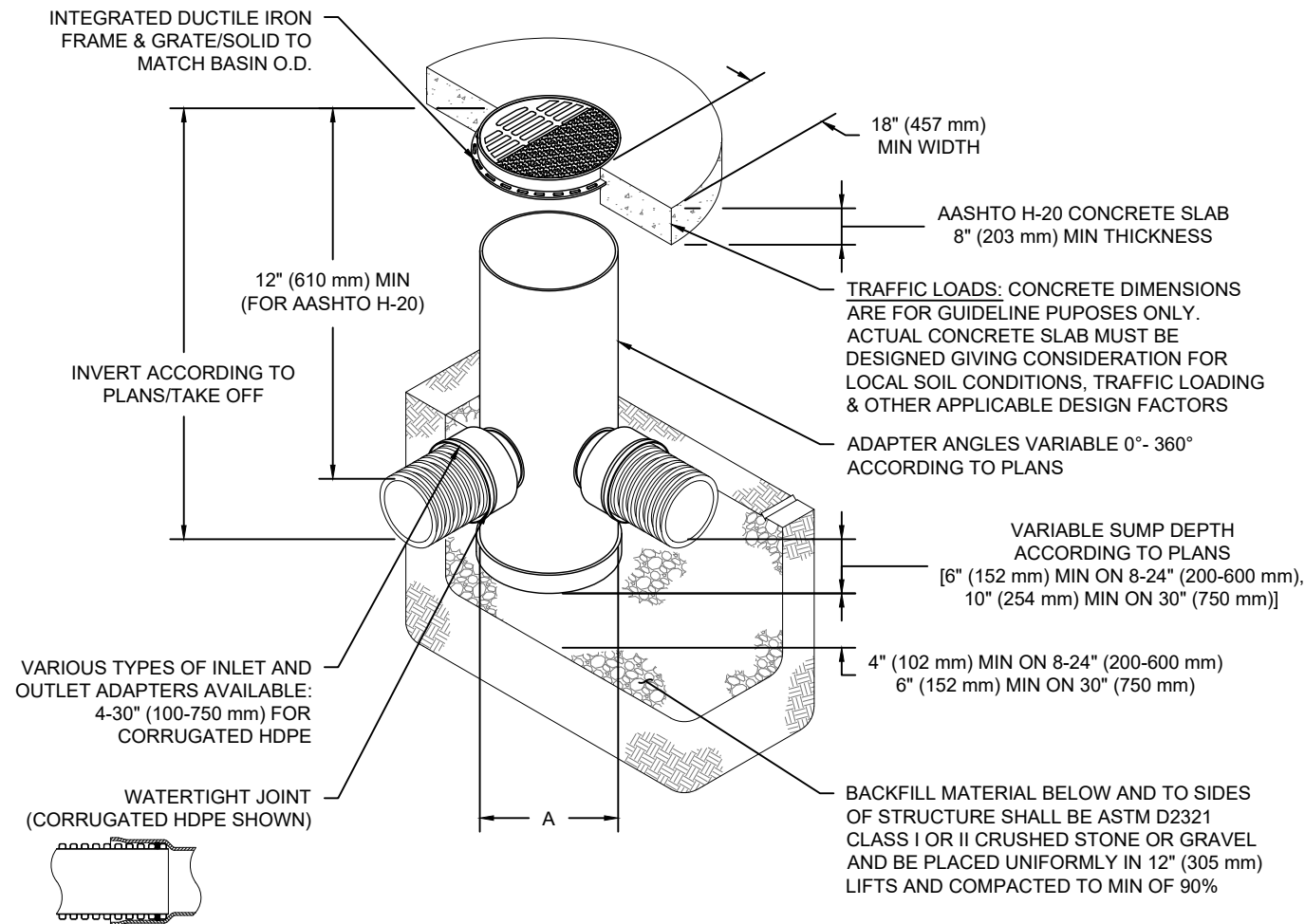

NOTES

- 8-30" (200-750 mm) GRATES/SOLID COVERS SHALL BE DUCTILE IRON PER ASTM A536 GRADE 70-50-05
- 12-30" (300-750 mm) FRAMES SHALL BE DUCTILE IRON PER ASTM A536 GRADE 70-50-05
- DRAIN BASIN TO BE CUSTOM MANUFACTURED ACCORDING TO PLAN DETAILS
- DRAINAGE CONNECTION STUB JOINT TIGHTNESS SHALL CONFORM TO ASTM D3212 FOR CORRUGATED HDPE (ADS & HANCOR DUAL WALL) & SDR 35 PVC
- FOR COMPLETE DESIGN AND PRODUCT INFORMATION: WWW.NYLOPLAST-US.COM
- TO ORDER CALL: 800-821-6710

A	PART #	GRATE/SOLID COVER OPTIONS		
8" (200 mm)	2808AG	PEDESTRIAN LIGHT DUTY	STANDARD LIGHT DUTY	SOLID LIGHT DUTY
10" (250 mm)	2810AG	PEDESTRIAN LIGHT DUTY	STANDARD LIGHT DUTY	SOLID LIGHT DUTY
12" (300 mm)	2812AG	PEDESTRIAN AASHTO H-10	STANDARD AASHTO H-20	SOLID AASHTO H-20
15" (375 mm)	2815AG	PEDESTRIAN AASHTO H-10	STANDARD AASHTO H-20	SOLID AASHTO H-20
18" (450 mm)	2818AG	PEDESTRIAN AASHTO H-10	STANDARD AASHTO H-20	SOLID AASHTO H-20
24" (600 mm)	2824AG	PEDESTRIAN AASHTO H-10	STANDARD AASHTO H-20	SOLID AASHTO H-20
30" (750 mm)	2830AG	PEDESTRIAN AASHTO H-20	STANDARD AASHTO H-20	SOLID AASHTO H-20

ASDFSAGA
PORTLAND, OR, USA

DATE: DRAWN: NG

CHECKED: N/A

DESCRIPTION

DATE DRW CHK

DATE DRW CHK

4640 TRUEMAN BLVD
HILLIARD, OH 43026
1-800-733-7473



SHEET
6 OF 6

THIS DRAWING HAS BEEN PREPARED BASED ON INFORMATION PROVIDED TO ADS UNDER THE DIRECTION OF THE SITE DESIGN ENGINEER OR OTHER PROJECT REPRESENTATIVE. THE SITE DESIGN ENGINEER SHALL REVIEW THIS DRAWING PRIOR TO CONSTRUCTION. IT IS THE ULTIMATE RESPONSIBILITY OF THE SITE DESIGN ENGINEER TO ENSURE THAT THE PRODUCT(S) DEPICTED AND ALL ASSOCIATED DETAILS MEET ALL APPLICABLE LAWS, REGULATIONS, AND PROJECT REQUIREMENTS.

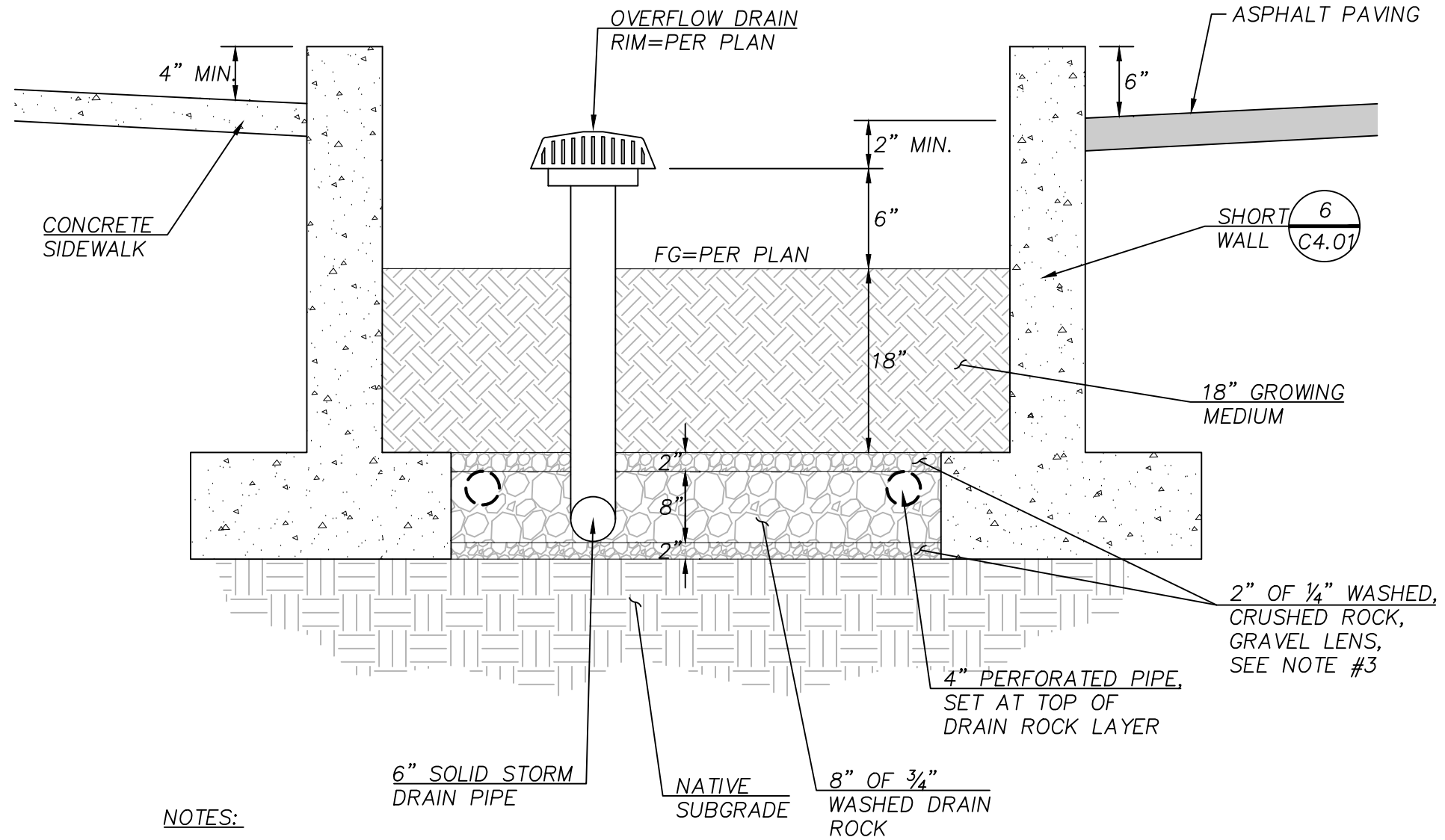

NOTES:

1. PLANTING PER LANDSCAPE DRAWINGS.
2. GROWING MEDIUM SHALL BE A SAND/LOAD/COMPOST 3-WAY MIX PER APPENDIX F OF THE PORTLAND STORMWATER MANAGEMENT MANUAL.
3. FILTER FABRIC CAN BE USED IN PLACE OF THE GRAVEL LENS. IF FILTER FABRIC IS USED, THE ENTIRE ROCK SECTION SHALL BE WRAPPED WITH THE FILTER FABRIC AND THE 8" OF DRAIN ROCK SHALL BE INCREASE TO 12".
4. CONNECT PERFORATED PIPE TO SOLID PIPE, PER PLAN.
5. CONSTRUCT ROCK SPILLWAY AT CURB OPENINGS TO PREVENT EROSION.

1 **STORMWATER PLANTER**
NTS

Appendix B

Support Calculations

HydroCAD Report

BMP Report

Conveyance Calculations

THA012 - ADS Chamber Calcs

Prepared by Hewlett-Packard Company

HydroCAD® 10.00-15 s/n 09142 © 2015 HydroCAD Software Solutions LLC

Type IA 24-hr 2 year Rainfall=2.50"

Printed 4/28/2023

Page 8

Pond 3P: ADS SC740 - Chamber Wizard Field A

Chamber Model = ADS_StormTechSC-740 (ADS StormTech®SC-740)

Effective Size= 44.6"W x 30.0"H => 6.45 sf x 7.12'L = 45.9 cf

Overall Size= 51.0"W x 30.0"H x 7.56'L with 0.44' Overlap

Row Length Adjustment= +0.44' x 6.45 sf x 5 rows

51.0" Wide + 6.0" Spacing = 57.0" C-C Row Spacing

9 Chambers/Row x 7.12' Long +0.44' Row Adjustment = 64.52' Row Length +12.0" End Stone x 2 = 66.52' Base Length

5 Rows x 51.0" Wide + 6.0" Spacing x 4 + 12.0" Side Stone x 2 = 25.25' Base Width

4.0" Base + 30.0" Chamber Height + 6.0" Cover = 3.33' Field Height

45 Chambers x 45.9 cf +0.44' Row Adjustment x 6.45 sf x 5 Rows = 2,081.5 cf Chamber Storage

5,598.8 cf Field - 2,081.5 cf Chambers = 3,517.3 cf Stone x 40.0% Voids = 1,406.9 cf Stone Storage

Chamber Storage + Stone Storage = 3,488.4 cf = 0.080 af

Overall Storage Efficiency = 62.3%

45 Chambers

207.4 cy Field

130.3 cy Stone

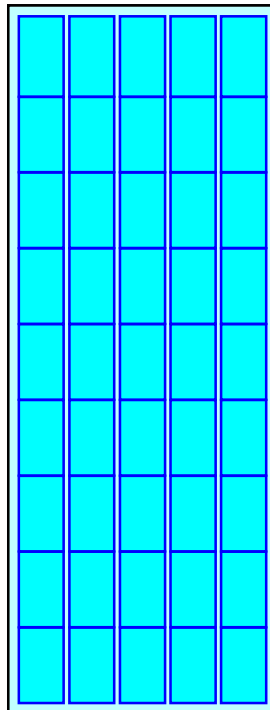

THA012 - ADS Chamber Calcs

Type IA 24-hr 2 year Rainfall=2.50"

Prepared by Hewlett-Packard Company

Printed 4/28/2023

HydroCAD® 10.00-15 s/n 09142 © 2015 HydroCAD Software Solutions LLC

Page 6

Summary for Subcatchment PreD: Pre Developed

[49] Hint: Tc<2dt may require smaller dt

Runoff = 0.13 cfs @ 7.99 hrs, Volume= 0.054 af, Depth= 0.84"

Runoff by SBUH method, Split Pervious/Imperv., Time Span= 0.00-40.00 hrs, dt= 0.05 hrs
Type IA 24-hr 2 year Rainfall=2.50"

Area (sf)	CN	Description
33,970	79	50-75% Grass cover, Fair, HSG C
33,970		100.00% Pervious Area

Tc (min)	Length (feet)	Slope (ft/ft)	Velocity (ft/sec)	Capacity (cfs)	Description
5.0					Direct Entry,

Subcatchment PreD: Pre Developed

Hydrograph

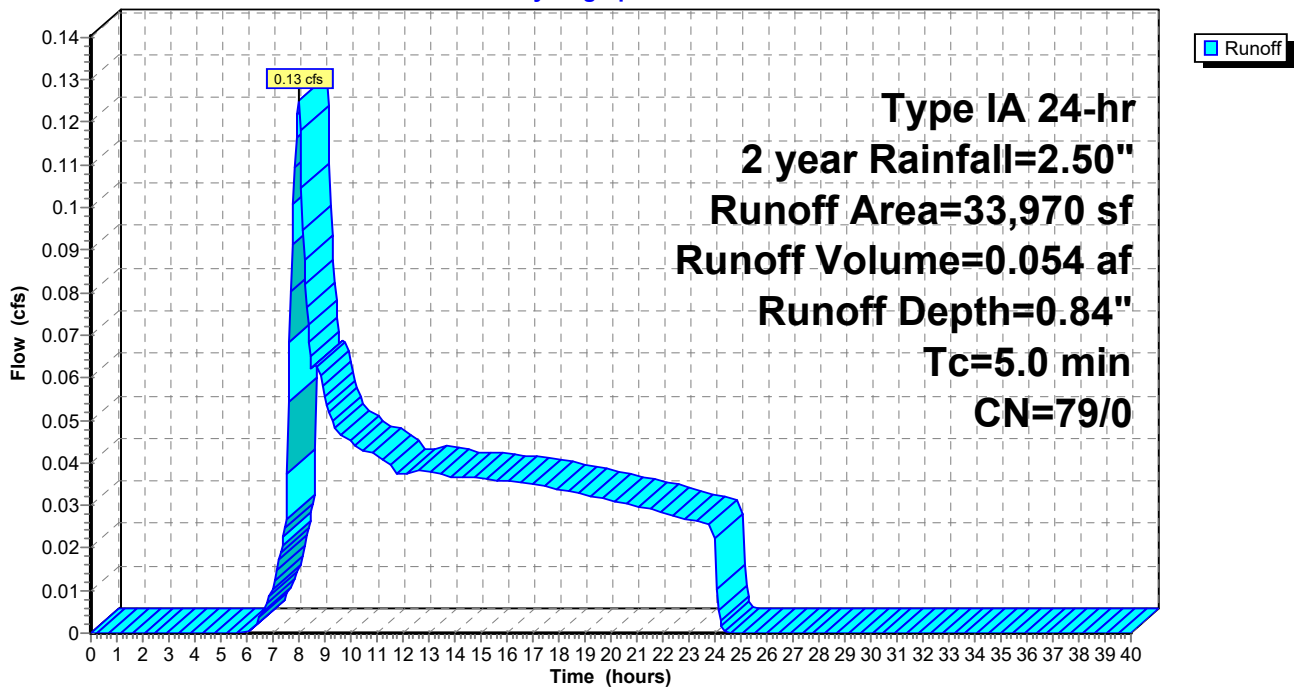

THA012 - ADS Chamber Calcs

Type IA 24-hr 2 year Rainfall=2.50"

Prepared by Hewlett-Packard Company

Printed 4/28/2023

HydroCAD® 10.00-15 s/n 09142 © 2015 HydroCAD Software Solutions LLC

Page 7

Summary for Pond 3P: ADS SC740

Inflow Area = 0.780 ac, 97.94% Impervious, Inflow Depth = 2.24" for 2 year event
 Inflow = 0.44 cfs @ 7.90 hrs, Volume= 0.146 af
 Outflow = 0.06 cfs @ 17.03 hrs, Volume= 0.128 af, Atten= 87%, Lag= 548.0 min
 Primary = 0.06 cfs @ 17.03 hrs, Volume= 0.128 af

Routing by Stor-Ind method, Time Span= 0.00-40.00 hrs, dt= 0.05 hrs
 Peak Elev= 102.74' @ 17.03 hrs Surf.Area= 1,680 sf Storage= 3,087 cf

Plug-Flow detention time= 681.3 min calculated for 0.128 af (88% of inflow)
 Center-of-Mass det. time= 595.9 min (1,271.1 - 675.2)

Volume	Invert	Avail.Storage	Storage Description
#1A	100.00'	1,407 cf	25.25'W x 66.52'L x 3.33'H Field A 5,599 cf Overall - 2,081 cf Embedded = 3,517 cf x 40.0% Voids
#2A	100.33'	2,081 cf	ADS_StormTech SC-740 x 45 Inside #1 Effective Size= 44.6"W x 30.0"H => 6.45 sf x 7.12'L = 45.9 cf Overall Size= 51.0"W x 30.0"H x 7.56'L with 0.44' Overlap Row Length Adjustment= +0.44' x 6.45 sf x 5 rows
		3,488 cf	Total Available Storage

Storage Group A created with Chamber Wizard

Device	Routing	Invert	Outlet Devices
#1	Primary	100.00'	8.0" Vert. Orifice/Grate C= 0.600
#2	Device 1	100.00'	1.1" Vert. Orifice/Grate C= 0.600
#3	Device 1	102.70'	6.0" Vert. Orifice/Grate C= 0.600

Primary OutFlow Max=0.06 cfs @ 17.03 hrs HW=102.74' (Free Discharge)
 ↑ **1=Orifice/Grate** (Passes 0.06 cfs of 2.61 cfs potential flow)
 ↑ **2=Orifice/Grate** (Orifice Controls 0.05 cfs @ 7.90 fps)
 ↑ **3=Orifice/Grate** (Orifice Controls 0.00 cfs @ 0.67 fps)

THA012 - ADS Chamber Calcs

Prepared by Hewlett-Packard Company

HydroCAD® 10.00-15 s/n 09142 © 2015 HydroCAD Software Solutions LLC

Type IA 24-hr 2 year Rainfall=2.50"

Printed 4/28/2023

Page 9

Pond 3P: ADS SC740

Hydrograph

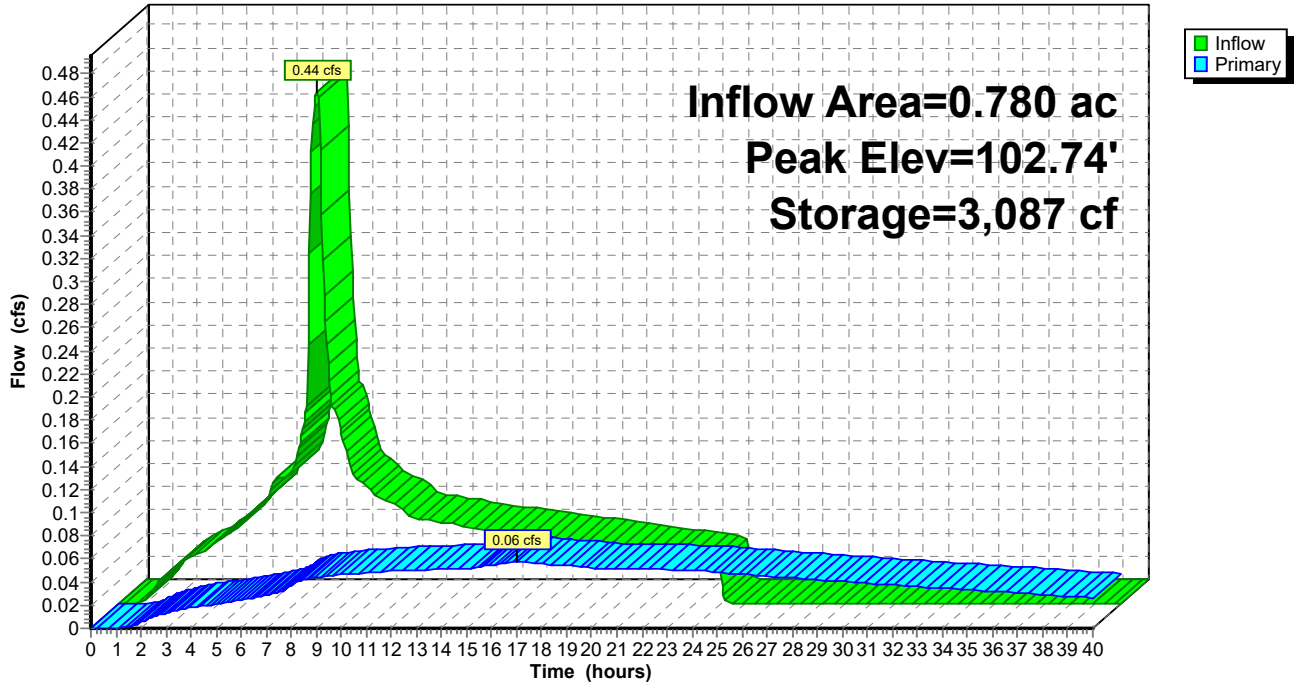

THA012 - ADS Chamber Calcs

Type IA 24-hr 10 YEAR Rainfall=3.45"

Prepared by Hewlett-Packard Company

Printed 4/28/2023

HydroCAD® 10.00-15 s/n 09142 © 2015 HydroCAD Software Solutions LLC

Page 11

Summary for Subcatchment PreD: Pre Developed

[49] Hint: Tc<2dt may require smaller dt

Runoff = 0.27 cfs @ 7.98 hrs, Volume= 0.099 af, Depth= 1.53"

Runoff by SBUH method, Split Pervious/Imperv., Time Span= 0.00-40.00 hrs, dt= 0.05 hrs
 Type IA 24-hr 10 YEAR Rainfall=3.45"

Area (sf)	CN	Description
33,970	79	50-75% Grass cover, Fair, HSG C
33,970		100.00% Pervious Area

Tc (min)	Length (feet)	Slope (ft/ft)	Velocity (ft/sec)	Capacity (cfs)	Description
5.0					Direct Entry,

Subcatchment PreD: Pre Developed

Hydrograph

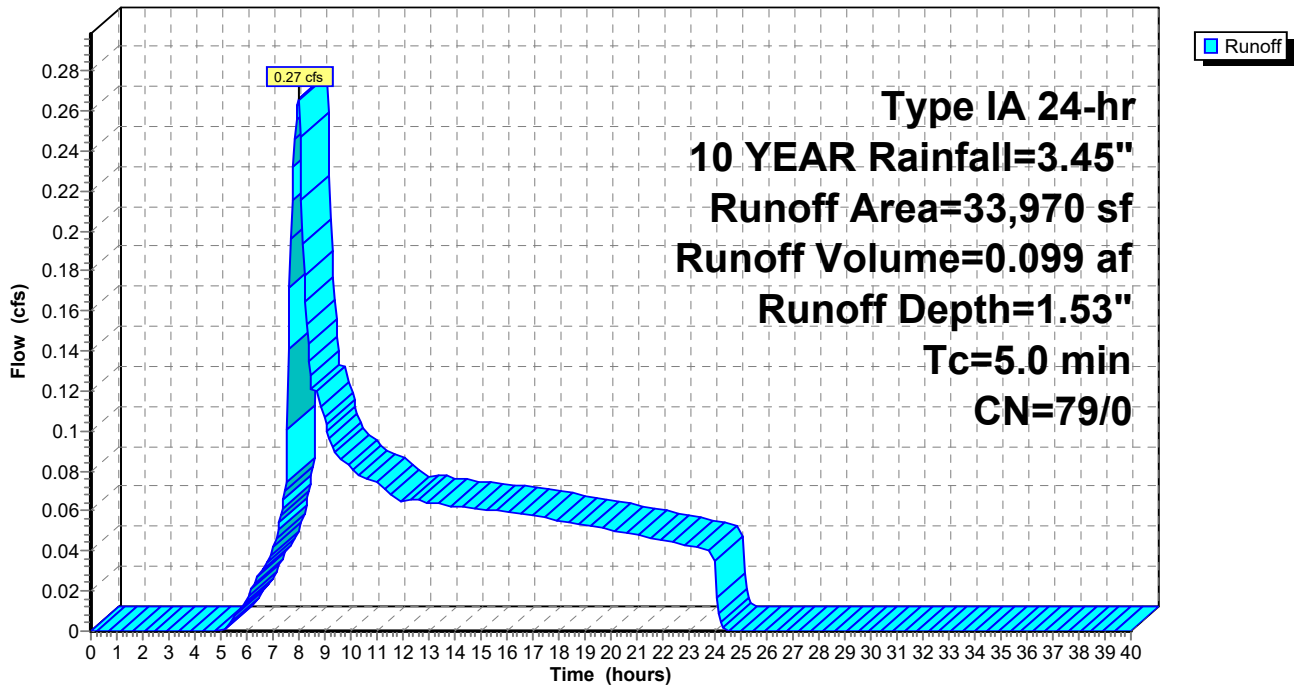

THA012 - ADS Chamber Calcs

Type IA 24-hr 10 YEAR Rainfall=3.45"

Prepared by Hewlett-Packard Company

Printed 4/28/2023

HydroCAD® 10.00-15 s/n 09142 © 2015 HydroCAD Software Solutions LLC

Page 12

Summary for Pond 3P: ADS SC740

Inflow Area = 0.780 ac, 97.94% Impervious, Inflow Depth = 3.18" for 10 YEAR event
 Inflow = 0.62 cfs @ 7.90 hrs, Volume= 0.207 af
 Outflow = 0.22 cfs @ 8.81 hrs, Volume= 0.187 af, Atten= 65%, Lag= 54.8 min
 Primary = 0.22 cfs @ 8.81 hrs, Volume= 0.187 af

Routing by Stor-Ind method, Time Span= 0.00-40.00 hrs, dt= 0.05 hrs
 Peak Elev= 102.95' @ 8.81 hrs Surf.Area= 1,680 sf Storage= 3,229 cf

Plug-Flow detention time= 512.7 min calculated for 0.187 af (91% of inflow)
 Center-of-Mass det. time= 444.2 min (1,110.2 - 665.9)

Volume	Invert	Avail.Storage	Storage Description
#1A	100.00'	1,407 cf	25.25'W x 66.52'L x 3.33'H Field A 5,599 cf Overall - 2,081 cf Embedded = 3,517 cf x 40.0% Voids
#2A	100.33'	2,081 cf	ADS_StormTech SC-740 x 45 Inside #1 Effective Size= 44.6"W x 30.0"H => 6.45 sf x 7.12'L = 45.9 cf Overall Size= 51.0"W x 30.0"H x 7.56'L with 0.44' Overlap Row Length Adjustment= +0.44' x 6.45 sf x 5 rows
		3,488 cf	Total Available Storage

Storage Group A created with Chamber Wizard

Device	Routing	Invert	Outlet Devices
#1	Primary	100.00'	8.0" Vert. Orifice/Grate C= 0.600
#2	Device 1	100.00'	1.1" Vert. Orifice/Grate C= 0.600
#3	Device 1	102.70'	6.0" Vert. Orifice/Grate C= 0.600

Primary OutFlow Max=0.22 cfs @ 8.81 hrs HW=102.95' (Free Discharge)

- ↑ **1=Orifice/Grate** (Passes 0.22 cfs of 2.72 cfs potential flow)
- ↑ **2=Orifice/Grate** (Orifice Controls 0.05 cfs @ 8.20 fps)
- ↑ **3=Orifice/Grate** (Orifice Controls 0.16 cfs @ 1.69 fps)

THA012 - ADS Chamber Calcs

Prepared by Hewlett-Packard Company

HydroCAD® 10.00-15 s/n 09142 © 2015 HydroCAD Software Solutions LLC

Type IA 24-hr 10 YEAR Rainfall=3.45"

Printed 4/28/2023

Page 14

Pond 3P: ADS SC740

Hydrograph

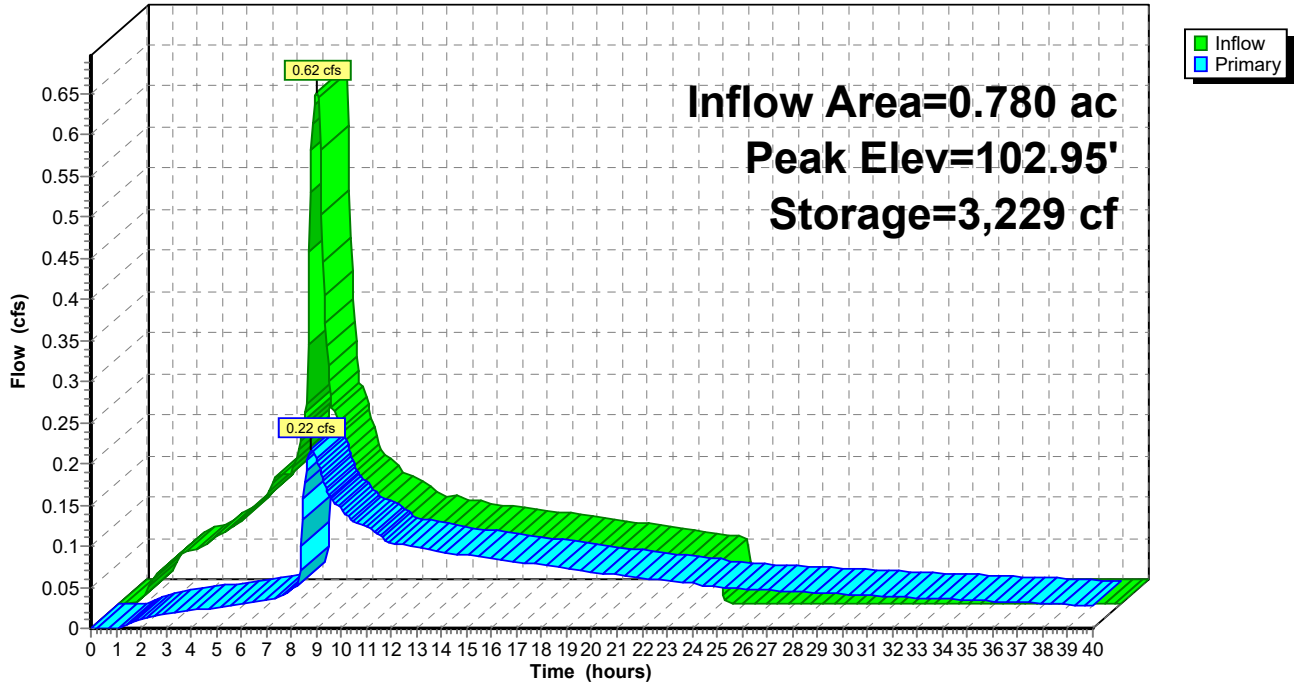

THA012 - ADS Chamber Calcs

Type IA 24-hr 25 YEAR Rainfall=3.90"

Prepared by Hewlett-Packard Company

Printed 4/28/2023

HydroCAD® 10.00-15 s/n 09142 © 2015 HydroCAD Software Solutions LLC

Page 16

Summary for Subcatchment PreD: Pre Developed

[49] Hint: Tc<2dt may require smaller dt

Runoff = 0.34 cfs @ 7.98 hrs, Volume= 0.122 af, Depth= 1.88"

Runoff by SBUH method, Split Pervious/Imperv., Time Span= 0.00-40.00 hrs, dt= 0.05 hrs
 Type IA 24-hr 25 YEAR Rainfall=3.90"

Area (sf)	CN	Description
33,970	79	50-75% Grass cover, Fair, HSG C
33,970		100.00% Pervious Area

Tc (min)	Length (feet)	Slope (ft/ft)	Velocity (ft/sec)	Capacity (cfs)	Description
5.0					Direct Entry,

Subcatchment PreD: Pre Developed

Hydrograph

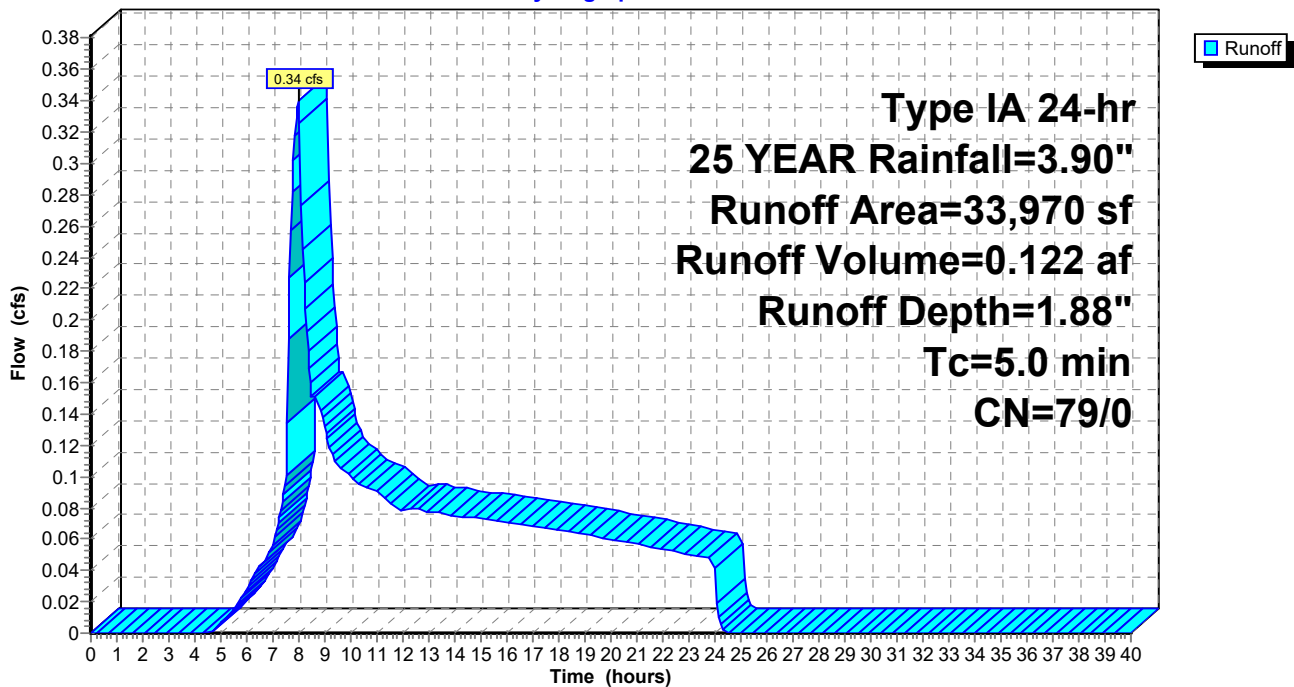

THA012 - ADS Chamber Calcs

Type IA 24-hr 25 YEAR Rainfall=3.90"

Prepared by Hewlett-Packard Company

Printed 4/28/2023

HydroCAD® 10.00-15 s/n 09142 © 2015 HydroCAD Software Solutions LLC

Page 17

Summary for Pond 3P: ADS SC740

Inflow Area = 0.780 ac, 97.94% Impervious, Inflow Depth = 3.63" for 25 YEAR event
 Inflow = 0.71 cfs @ 7.90 hrs, Volume= 0.236 af
 Outflow = 0.38 cfs @ 8.26 hrs, Volume= 0.216 af, Atten= 46%, Lag= 21.8 min
 Primary = 0.38 cfs @ 8.26 hrs, Volume= 0.216 af

Routing by Stor-Ind method, Time Span= 0.00-40.00 hrs, dt= 0.05 hrs
 Peak Elev= 103.08' @ 8.26 hrs Surf.Area= 1,680 sf Storage= 3,315 cf

Plug-Flow detention time= 454.5 min calculated for 0.216 af (92% of inflow)
 Center-of-Mass det. time= 393.1 min (1,056.0 - 662.9)

Volume	Invert	Avail.Storage	Storage Description
#1A	100.00'	1,407 cf	25.25'W x 66.52'L x 3.33'H Field A 5,599 cf Overall - 2,081 cf Embedded = 3,517 cf x 40.0% Voids
#2A	100.33'	2,081 cf	ADS_StormTech SC-740 x 45 Inside #1 Effective Size= 44.6"W x 30.0"H => 6.45 sf x 7.12'L = 45.9 cf Overall Size= 51.0"W x 30.0"H x 7.56'L with 0.44' Overlap Row Length Adjustment= +0.44' x 6.45 sf x 5 rows
		3,488 cf	Total Available Storage

Storage Group A created with Chamber Wizard

Device	Routing	Invert	Outlet Devices
#1	Primary	100.00'	8.0" Vert. Orifice/Grate C= 0.600
#2	Device 1	100.00'	1.1" Vert. Orifice/Grate C= 0.600
#3	Device 1	102.70'	6.0" Vert. Orifice/Grate C= 0.600

Primary OutFlow Max=0.38 cfs @ 8.26 hrs HW=103.07' (Free Discharge)

↑ **1=Orifice/Grate** (Passes 0.38 cfs of 2.78 cfs potential flow)

↑ **2=Orifice/Grate** (Orifice Controls 0.06 cfs @ 8.38 fps)

↑ **3=Orifice/Grate** (Orifice Controls 0.33 cfs @ 2.08 fps)

THA012 - ADS Chamber Calcs

Prepared by Hewlett-Packard Company

HydroCAD® 10.00-15 s/n 09142 © 2015 HydroCAD Software Solutions LLC

Type IA 24-hr 25 YEAR Rainfall=3.90"

Printed 4/28/2023

Page 19

Pond 3P: ADS SC740

Hydrograph

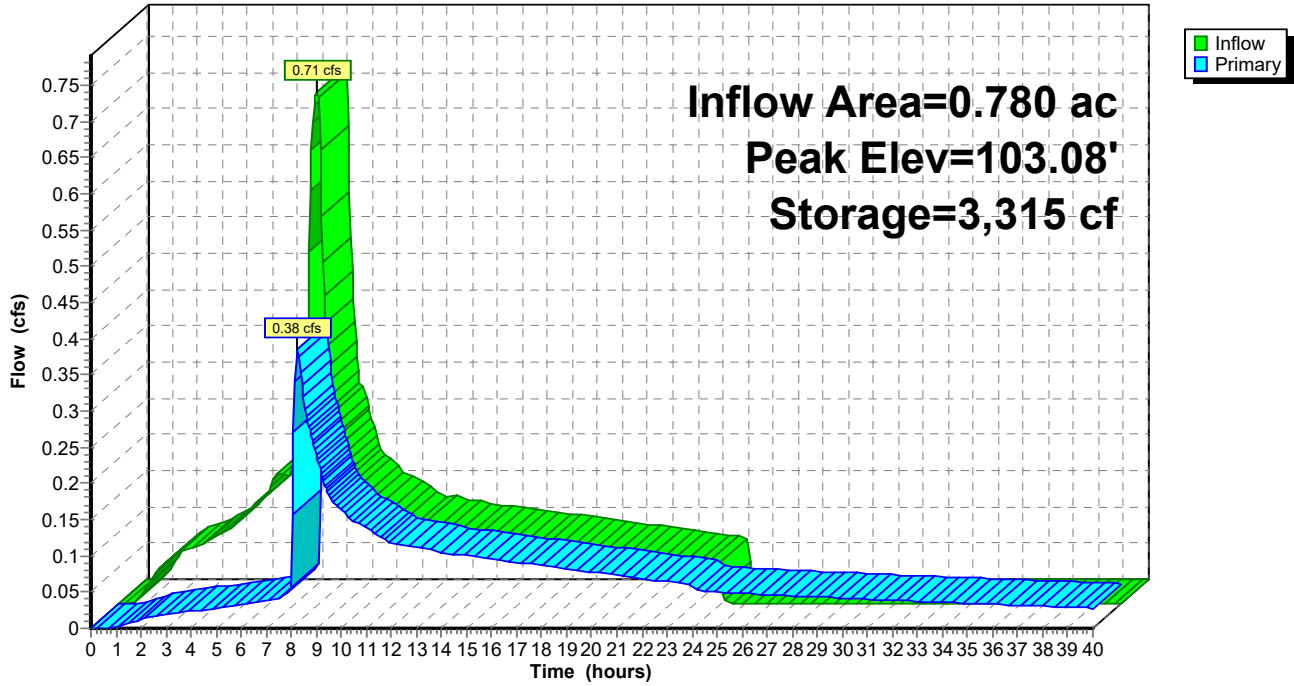

THA012 - ADS Chamber Calcs

Prepared by Hewlett-Packard Company

HydroCAD® 10.00-15 s/n 09142 © 2015 HydroCAD Software Solutions LLC

Type IA 24-hr 100 yr Rainfall=4.50"

Printed 4/28/2023

Page 21

Summary for Subcatchment PreD: Pre Developed

[49] Hint: $T_c < 2dt$ may require smaller dt

Runoff = 0.44 cfs @ 7.98 hrs, Volume= 0.154 af, Depth= 2.38"

Runoff by SBUH method, Split Pervious/Imperv., Time Span= 0.00-40.00 hrs, $dt= 0.05$ hrs
 Type IA 24-hr 100 yr Rainfall=4.50"

Area (sf)	CN	Description
33,970	79	50-75% Grass cover, Fair, HSG C
33,970		100.00% Pervious Area

Tc (min)	Length (feet)	Slope (ft/ft)	Velocity (ft/sec)	Capacity (cfs)	Description
5.0					Direct Entry,

Subcatchment PreD: Pre Developed

Hydrograph

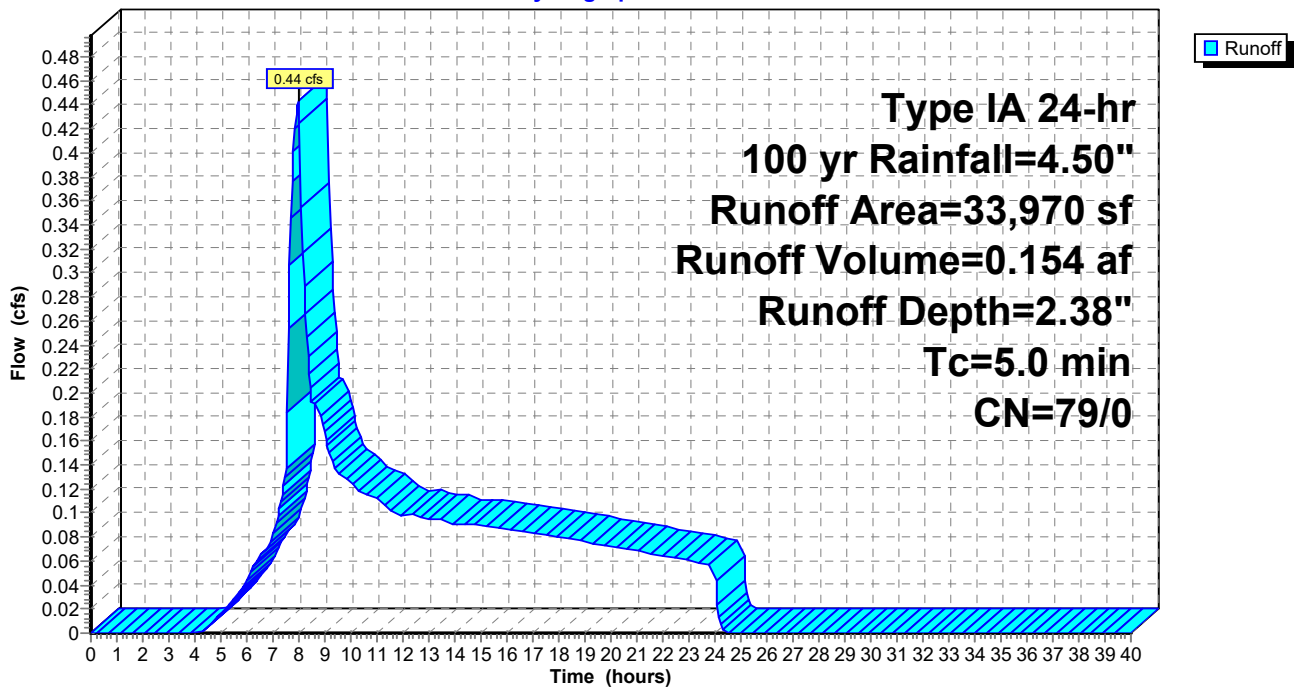

THA012 - ADS Chamber Calcs

Type IA 24-hr 100 yr Rainfall=4.50"

Prepared by Hewlett-Packard Company

Printed 4/28/2023

HydroCAD® 10.00-15 s/n 09142 © 2015 HydroCAD Software Solutions LLC

Page 22

Summary for Pond 3P: ADS SC740

Inflow Area = 0.780 ac, 97.94% Impervious, Inflow Depth = 4.23" for 100 yr event
 Inflow = 0.82 cfs @ 7.90 hrs, Volume= 0.275 af
 Outflow = 0.63 cfs @ 8.10 hrs, Volume= 0.255 af, Atten= 23%, Lag= 12.2 min
 Primary = 0.63 cfs @ 8.10 hrs, Volume= 0.255 af

Routing by Stor-Ind method, Time Span= 0.00-40.00 hrs, dt= 0.05 hrs
 Peak Elev= 103.32' @ 8.10 hrs Surf.Area= 1,680 sf Storage= 3,480 cf

Plug-Flow detention time= 395.9 min calculated for 0.255 af (93% of inflow)
 Center-of-Mass det. time= 342.1 min (1,001.8 - 659.7)

Volume	Invert	Avail.Storage	Storage Description
#1A	100.00'	1,407 cf	25.25'W x 66.52'L x 3.33'H Field A 5,599 cf Overall - 2,081 cf Embedded = 3,517 cf x 40.0% Voids
#2A	100.33'	2,081 cf	ADS_StormTech SC-740 x 45 Inside #1 Effective Size= 44.6"W x 30.0"H => 6.45 sf x 7.12'L = 45.9 cf Overall Size= 51.0"W x 30.0"H x 7.56'L with 0.44' Overlap Row Length Adjustment= +0.44' x 6.45 sf x 5 rows
		3,488 cf	Total Available Storage

Storage Group A created with Chamber Wizard

Device	Routing	Invert	Outlet Devices
#1	Primary	100.00'	8.0" Vert. Orifice/Grate C= 0.600
#2	Device 1	100.00'	1.1" Vert. Orifice/Grate C= 0.600
#3	Device 1	102.70'	6.0" Vert. Orifice/Grate C= 0.600

Primary OutFlow Max=0.63 cfs @ 8.10 hrs HW=103.32' (Free Discharge)
 1=Orifice/Grate (Passes 0.63 cfs of 2.90 cfs potential flow)
 2=Orifice/Grate (Orifice Controls 0.06 cfs @ 8.71 fps)
 3=Orifice/Grate (Orifice Controls 0.58 cfs @ 2.93 fps)

THA012 - ADS Chamber Calcs

Prepared by Hewlett-Packard Company

HydroCAD® 10.00-15 s/n 09142 © 2015 HydroCAD Software Solutions LLC

Type IA 24-hr 100 yr Rainfall=4.50"

Printed 4/28/2023

Page 24

Pond 3P: ADS SC740

Hydrograph

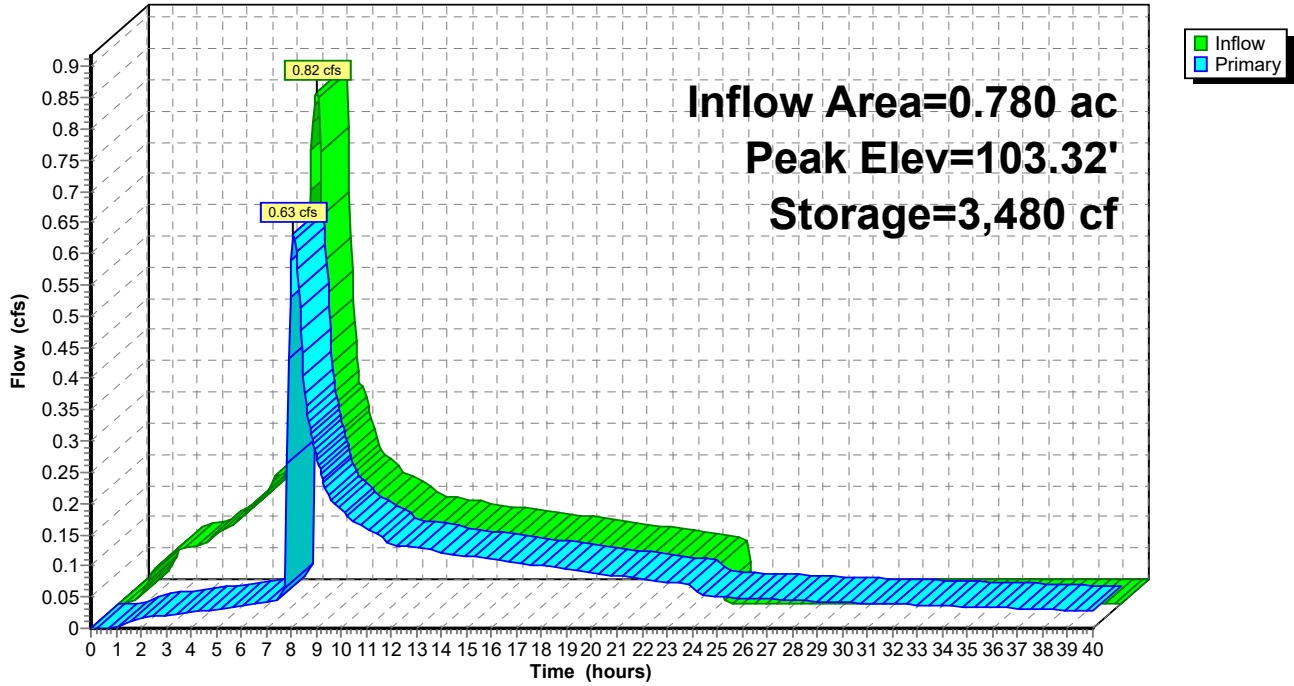

WES BMP Sizing Report

Project Information

Project Name	THA012-WTC
Project Type	MultiFamily
Location	29690 SW TOWN CENTER LOOP W
Stormwater Management Area	0
Project Applicant	
Jurisdiction	OutofDistrict

Drainage Management Area

Name	Area (sq-ft)	Pre-Project Cover	Post-Project Cover	DMA Soil Type	BMP
Parking Lot	8,140	Impervious	ConventionalCo ncrete	B	Planter
Roof	22,731	Impervious	Roofs	B	NA
Public Sidewalk (Trading Area)	3,473	Impervious	ConventionalCo ncrete	B	Planter

LID Facility Sizing Details

LID ID	Design Criteria	BMP Type	Facility Soil Type	Minimum Area (sq-ft)	Planned Areas (sq-ft)	Orifice Diameter (in)
Planter	WaterQuality	Stormwater Planter - Infiltration	B1	174.2	175.0	0.0

Pond Sizing Details

1. FCWQT = Flow control and water quality treatment, WQT = Water quality treatment only
2. Depth is measured from the bottom of the facility and includes the three feet of media (drain rock, separation layer and growing media).
3. Maximum volume of the facility. Includes the volume occupied by the media at the bottom of the facility.
4. Maximum water storage volume of the facility. Includes water storage in the three feet of soil media assuming a 40 percent porosity.

WES BMP Sizing Report

Project Information

Project Name	THA012-WTC
Project Type	MultiFamily
Location	
Stormwater Management Area	0
Project Applicant	
Jurisdiction	OutofDistrict

Drainage Management Area

Name	Area (sq-ft)	Pre-Project Cover	Post-Project Cover	DMA Soil Type	BMP
DMA	8,603	Grass	ConventionalConcrete	C	Public Planter

LID Facility Sizing Details

LID ID	Design Criteria	BMP Type	Facility Soil Type	Minimum Area (sq-ft)	Planned Areas (sq-ft)	Orifice Diameter (in)
Public Planter	FlowControlAndTreatment	Stormwater Planter - Filtration	C3	344.1	344.1	0.9

Pond Sizing Details

1. FCWQT = Flow control and water quality treatment, WQT = Water quality treatment only
2. Depth is measured from the bottom of the facility and includes the three feet of media (drain rock, separation layer and growing media).
3. Maximum volume of the facility. Includes the volume occupied by the media at the bottom of the facility.
4. Maximum water storage volume of the facility. Includes water storage in the three feet of soil media assuming a 40 percent porosity.



**Humber
Design
Group, Inc.**

110 SE Main Street
Suite 200
Portland, Oregon 97214

503.946.6690
www.hdgpx.com

Civil Engineering

STORMWATER CONVEYANCE CALCULATIONS

* This spreadsheet is based on King County SBUH method.

Design Storm: 25 YR
Storm Duration: 24 HRS
Precipitation: 3.9 IN
Manning's "n" 0.011 (FOR PVC STORM PIPE)

LINE	INC. AREA (AC)	INC. % IMP.	CUM. AREA (AC)	CUM. AREA PERV. (AC)	CN PER.	CUM. AREA IMP. (AC)	CN IMP.	TIME (MIN)	Q (CFS)	PIPE Dia. (IN)	SLOPE (FT/FT)	Qf (CFS)	Q/Qf (%)	Depth (in)	Depth/Dia.	V (fps)	LENGTH (FT)	INC. TIME (MIN)
25 YEAR	0.780	100.00	0.7798	0.0000	98	0.7798	98	5.00	0.38	8	0.0200	2.03	0.19	2.35	0.29	4.44	27.0	0.10

Design Storm: 100 YR
Storm Duration: 24 HRS
Precipitation: 4.5 IN
Manning's "n" 0.011 (FOR PVC STORM PIPE)

LINE	INC. AREA (AC)	INC. % IMP.	CUM. AREA (AC)	CUM. AREA PERV. (AC)	CN PER.	CUM. AREA IMP. (AC)	CN IMP.	TIME (MIN)	Q (CFS)	PIPE Dia. (IN)	SLOPE (FT/FT)	Qf (CFS)	Q/Qf (%)	Depth (in)	Depth/Dia.	V (fps)	LENGTH (FT)	INC. TIME (MIN)
100 YEAR	0.780	100.00	0.7798	0.0000	98	0.7798	98	5.00	0.63	8	0.0200	2.03	0.31	3.07	0.38	5.11	27.0	0.09

Appendix C

Additional Forms & Associated Reports

Geotechnical Report

Infiltration Testing Information



July 15, 2022

Level Development NW
7327 SW Barnes Road, #523
Portland, OR 97225

Attention: Seth Henderson

Due Diligence Geotechnical Engineering Services

Shari's Restaurant Site
29690 Town Center Loop West
Wilsonville, Oregon
Project: LevelDevNW-1-01

INTRODUCTION

This report presents the results of our due diligence geotechnical engineering services for the property located at 29690 Town Center Loop West in Wilsonville, Oregon. The site is 1.07 acres and currently occupied by asphalt concrete (AC) parking areas and a single-story Shari's restaurant. A site survey provided to us indicated that the site is relatively flat. Our services for this project were conducted in accordance with our proposal dated May 25, 2022. Figure 1 shows the site vicinity relative to surrounding features.

Plans were not available prepared at the time of this report. However, we understand the planned development will include a four-story, wood-framed, mixed-use building and associated surface parking. Foundation loads were not available at the time of this report; however, we have assumed maximum column and wall loads of 300 kips and 5 kips per foot, respectively. We have assumed floor loads will not exceed 100 pounds per square foot (psf). Site cuts and fills are anticipated to be minimal during site development.

PURPOSE AND SCOPE

The purpose of our scope was to provide preliminary geotechnical engineering recommendations for use in a due diligence evaluation of the property. Specifically, we conducted the following tasks:

- Reviewed readily available, published geotechnical and geologic information and our in-house files for existing information on subsurface conditions in the site vicinity.
- Coordinated and managed the field explorations, including utility locates and scheduling subcontractors and NV5 field staff.

- Conducted a subsurface exploration program that consisted of drilling two borings to depths of 16.3 and 20.8 feet below ground surface (BGS).
- Maintained a continuous log of the explorations and collected soil samples at representative intervals.
- Conducted a laboratory testing program consisting of the following:
 - Six moisture content determinations in general accordance with ASTM D2216
 - Two particle-size analyses in general accordance with ASTM D1140
- Prepared this report with preliminary recommendations, including seismic design criteria and foundation support.

SITE CONDITIONS

GEOLOGY

The site is located on the northern margin of the Central Willamette Valley physiographic province. Tertiary marine sedimentary and volcanic bedrock units form the western and eastern margins, respectively, of a depositional basin. The geologic profile is mapped as Miocene (14.5 million years before present) to recent Valley unconsolidated sediments (Burns et al., 1997). The geologic unit is a compilation of generally unconsolidated modern stream deposits, fine-grained catastrophic flood deposits, and Miocene to Pleistocene Age fluvial and lacustrine sediments. The flood deposits in the site vicinity generally consist of a thin cover of fine sand and silt overlying reworked gravel and cobbles from flood waters entering the Central Willamette Valley from the Tualatin and Portland basins located to the north. The flood deposits range in thickness from less than 20 feet to 50 feet (Gannett and Caldwell, 1998; Schlicker and Finlayson, 1979).

The flood deposits overlie fluvial and lacustrine sediments that consist of poorly to well-cemented conglomerate, sandstone, siltstone, and claystone equivalent to the Troutdale Formation and Sandy River Mudstone described in the Portland Basin located north of the site (Gannett and Caldwell, 1998; Burns et al., 1997; Schlicker and Finlayson, 1979; Hart and Newcomb, 1965). The fluvial and lacustrine sediments range in thickness from 285 to 315 feet in the site vicinity.

The bedrock unit that forms the bottom of the basin and underlies the Valley unconsolidated sediments is the Columbia River Basalt Group (CRBG). The CRBG is middle Miocene (16.5 million to 15 million years before present) in age and consists of a series of basalt flows that originated from southeastern Washington and northeastern Oregon. The CRBG is considered the geologic basement for this report (Gannett and Caldwell, 1998; Burns et al., 1997; Schlicker and Finlayson, 1979; Hart and Newcomb, 1965).

According to the Natural Resources Conservation Service's web soil survey, the near-surface soil in the existing and proposed channel areas is Woodburn silt loam. The soil's parent material consists of stratified glaciolacustrine deposits and is described as moderately well drained. The typical soil profile of the Woodburn silt loam consists of silt loam to silty clay loam from the ground surface to 5 feet BGS.

SUBSURFACE CONDITIONS

General

We explored subsurface conditions at the site by drilling two borings (B-1 and B-2) to depths of 16.3 and 20.8 feet BGS. The approximate locations of the explorations are shown on Figure 2. A description of the field explorations, the exploration logs, and the results of laboratory testing are present in the Attachment.

Our subsurface exploration program encountered three geologic units: fill, silt, and gravel. Asphalt concrete (AC) pavement is present at the surface of each boring locations. A brief description of each of these geologic units is presented below.

Pavement Section

Our explorations encountered 3 inches of AC underlain by 11 inches of aggregate base.

Fill

Fill was encountered in boring B-1 to a depth of 5 feet BGS. The fill consists of medium stiff, low plasticity silt with minor sand and trace organics and wood debris. It is possible that this fill was placed as engineered fill during construction of the parking lot.

Silt

The fill in B-1 and the pavement section in B-2 are underlain by stiff to very stiff, brown silt with varying proportions of sand. Laboratory testing conducted on select samples of the silt indicates a moisture content ranging from 29 to 31 percent at the time of our explorations.

Gravel

Medium dense to very dense gravel with sand and varying proportions of silt was encountered at depths of approximately 7.5 to 7.8 feet BGS to the maximum depths explored. We believe this unit contains cobble-size particles based on drilling resistance and drill spoils. Laboratory testing of select samples indicates an approximate fines content of 26 percent and an in-situ moisture content ranging from 12 to 16 percent.

GROUNDWATER

Groundwater was not encountered during our subsurface exploration of the site. Perched groundwater zones are likely to develop in the upper soil at the site, particularly during extended periods of wet weather. The depth to groundwater may fluctuate in response to seasonal changes, prolonged rainfall, changes in surface topography, and other factors not observed in this study.

CONCLUSIONS AND RECOMMENDATIONS

GENERAL

In our opinion, the site is acceptable for the proposed development. The following are expected to be the primary geotechnical considerations impacting the proposed development of the site:

- The building can be supported on spread footings founded on firm, undisturbed native soil or structural fill that overlies firm native soil.
- Undocumented fill was encountered in boring B-1 to a depth of 5 feet BGS. It is possible that this fill was placed as engineered fill during construction of the parking lot. However, if the fill is not engineered, it should be removed from the influence zones of foundations and replaced with engineered fill.
- Fine-grained soil present on this site is easily disturbed during the wet season. If not carefully executed, site earthwork can create extensive soft areas and significant repair costs can result. Subgrade protection will be required when the subgrade is wet.
- Cobbles are likely present at depths greater than 7.5 feet BGS. The presence of cobbles and boulders may make excavations difficult.

FOUNDATION SUPPORT

The proposed structure can be supported on conventional spread footings bearing on firm, undisturbed native soil or on granular pads consisting of structural fill placed over native soil. The following sections provide our recommendations for use in foundation design and construction.

Bearing Capacity

Conventional wall and column footings bearing on native soil or on structural fill granular pads should be sized based on an allowable bearing pressure of 3,000 psf. This is a net bearing pressure; the weight of the footing and overlying backfill can be ignored when calculating footing sizes. This allowable bearing pressure applies to the total of dead and long-term live loads and may be increased by one-third when considering loads from seismic or wind forces.

Lateral Resistance

Lateral loads can be resisted by passive earth pressure on the sides of footings and by friction on the base of the footings. An allowable passive resistance may be calculated as a triangular pressure distribution using an equivalent fluid density of 350 pounds per cubic foot. A coefficient of friction equal to 0.35 is typical when calculating resistance to sliding for foundations bearing on native soil and 0.50 for footings bearing on granular pads.

Settlement

Based on the anticipated foundation loads, post-construction settlement of new footings founded as recommended is anticipated to be less than 1 inch. Differential settlement between similarly loaded, newly constructed foundation elements should be approximately one-half of the total settlement. If grading plans or structural loads change, we should be contacted to perform additional settlement analyses.

SEISMIC DESIGN

The soil profile at the site is consistent with Site Class D in accordance with the 2109 State of Oregon Structural Specialty Code, which refers to ASCE 7-16. The values presented in Table 1 can be used to compute design levels of ground shaking.

Table 1. Seismic Design Parameters

Seismic Design Parameter	Short Period (T_s)	1 Second Period (T_1)
Maximum Considered Earthquake Spectral Acceleration	$S_s = 0.815 \text{ g}$	$S_1 = 0.381 \text{ g}$
Site Class	C	
Site Coefficient	$F_a = 1.2$	$F_v = 1.5$
Adjusted Spectral Acceleration	$S_{MS} = 0.987 \text{ g}$	$S_{M1} = 0.571 \text{ g}$
Design Spectral Response Acceleration Parameters	$S_{DS} = 0.652 \text{ g}$	$S_{D1} = 0.381 \text{ g}$

g: gravitational acceleration (32.2 feet/second²)

The soil present at the site is not susceptible to liquefaction or lateral spreading.

LIMITATIONS

We have prepared this preliminary report for use by Level Development NW and members of the design and construction teams for use in cost estimating and preliminary design. The data and report can be used for estimating purposes, but our report, conclusions, and interpretations should not be construed as a warranty of the subsurface conditions and are not applicable to other sites.

The scope does not include services related to construction safety precautions, and our recommendations are not intended to direct the contractor's methods, techniques, sequences, or procedures, except as specifically described in this report for consideration in design.

Within the limitations of scope, schedule, and budget, our services have been executed in accordance with generally accepted practices in this area at the time this report was prepared. No warranty, expressed or implied, should be understood.



We appreciate the opportunity to be of continued service to you. Please call if you have questions concerning this report or if we can provide additional services.

Sincerely,

NV5

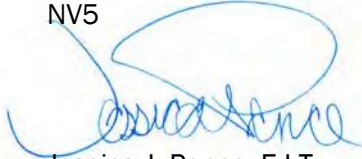

Jessica J. Pence, E.I.T.
Project Manager



Brett A. Shipton, P.E., G.E.
Principal Engineer



JJP:BAS:kt

Attachments

One copy submitted (via email only)

Document ID: LevelDevNW-1-01-071522-geolr.docx

© 2022 NV5. All rights reserved.

REFERENCES

Burns, Scott, Growney, Lawrence, Brodersen, Brett, Yeats, Robert S., Popowski, Thomas A., 1997, Map showing faults, bedrock geology, and sediment thickness of the western half of the Oregon City 1:100,000 quadrangle, Washington, Multnomah, Clackamas, and Marion Counties, Oregon, Oregon Department of Geology and Mineral Industries, IMS-75, scale 1:100,000.

Gannett, Marshall W., and Caldwell, Rodney R., 1998, Geologic Framework of the Willamette Lowland Aquifer System, Oregon and Washington: U.S. Geological Survey Professional Paper 1424-A, 32p, 8 plates.

Hart, D.H., and Newcomb, R.C., 1965, Geology and Ground Water of the Tualatin Valley, Oregon, U.S. Geological Survey Water-Supply Paper 1697, 167 p., 3 plates.

Schlicker, Herbert G. and Finlayson, Christopher T., 1979, Geology and Geologic Hazards of Northwestern Clackamas County, Oregon, Oregon Department of Geology and Mineral Industries Bulletin 99, 79p.

FIGURES

TOPOGRAPHIC SURVEY

LOCATED IN THE SE 1/4 OF SECTION 14, TOWNSHIP 3 SOUTH, RANGE 1 WEST OF THE WILLAMETTE MERIDIAN, CITY OF WILSONVILLE, CLACKAMAS, OREGON

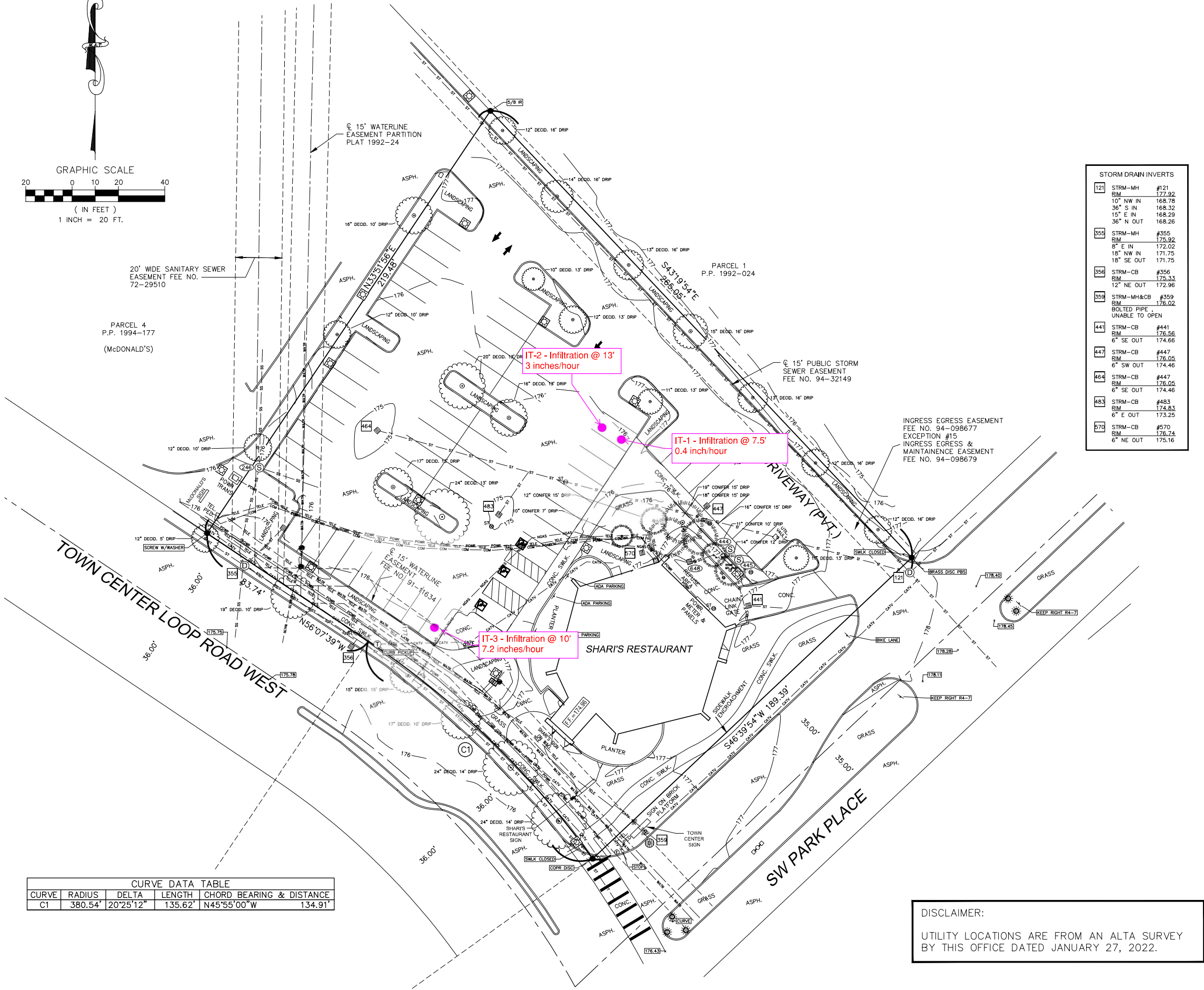
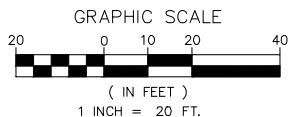

STORM DRAIN INVERTS		
121	STRM-MH #121	RIM 177.92
	10" NW IN	168.78
	36" S IN	168.32
	15" E IN	168.29
	36" N OUT	168.26
354	STRM-MH #355	RIM 175.92
	8" E IN	172.02
	18" NW IN	171.75
	18" SE OUT	171.75
356	STRM-CB #356	RIM 175.33
	12" NE OUT	172.96
359	STRM-MH&CB #359	RIM 176.02
	BOLTED PIPE - UNABLE TO OPEN	
441	STRM-CB #441	RIM 176.56
	6" SE OUT	174.66
447	STRM-CB #447	RIM 178.05
	6" SW OUT	174.46
464	STRM-CB #447	RIM 178.05
	6" SE OUT	174.46
483	STRM-CB #483	RIM 174.83
	6" E OUT	173.25
670	STRM-CB #570	RIM 176.74
	6" NE OUT	175.16

SANITARY SEWER INVERTS		
246	SSWR-MH #246	RIM 176.09
	8" SE IN	170.27
	10" N IN	169.33
	10" SW OUT	169.12
444	MH GREASE TRAP #444	RIM 177.02
	4" S OUT	173.59
445	MH GREASE TRAP #445	RIM 176.96
	4" N OUT	173.53
648	CB GREASE #648	RIM 176.86
	4" E OUT	N/A
	(ESTIMATED DIRECTION)	

- ### LEGEND
- FOUND SURVEY MONUMENT
 - SPOT ELEVATION
 - MAILBOX
 - GATEPOST
 - LIGHT ON POLE
 - FLOODLIGHT
 - BOLLARD W/LIGHT
 - LIGHT POLE (2)
 - POWER JCT. BOX
 - GAS METER
 - TELEPHONE MANHOLE
 - IRRIGATION VALVE
 - WATER METER
 - WATER VALVE
 - SANITARY SEWER CLEANOUT
 - SANITARY SEWER MANHOLE
 - STORM DRAIN CLEANOUT
 - CATCH BASIN
 - STORM DRAIN MANHOLE
 - STORM DRAIN MANHOLE & CATCH BASIN
 - STUMP
 - SHRUBBERY
 - CONIFER TREE
 - DECIDUOUS TREE

FLOOD HAZARD AREA:

THE SITE IS NOT IN A FLOOD HAZARD AREA ACCORDING TO FEMA'S FLOOD INSURANCE RATE MAP 41005C0242D, EFFECTIVE DATE JUNE 17, 2008. THE SITE IS IN ZONE X WHICH IS THE AREA DETERMINED TO BE OUTSIDE OF THE 500 YEAR FLOOD PLAIN.

SETBACKS:

SETBACKS REQUIREMENTS ARE BASED ON THE CITY OF WILSONVILLE REVISED CODE. THERE ARE NO SETBACK REQUIREMENTS.

AREA:

CONTAINS 1.09 ACRES OF LAND, MORE OR LESS.

TAX LOT:

TAX MAP NO. T3S 1W 14DD TAX LOT 411

ZONING:

THE ZONE OF THIS SITE IS CITY OF WILSONVILLE ZONING PLANNED DEVELOPMENT COMMERCIAL (PDC).

PARKING:

- 57 REGULAR PARKING SPACES
- 3 ADA PARKING SPACES
- 60 TOTAL PARKING SPACES

SPECIAL NOTE:

FOR CLARITY, THE WATER AND SANITARY EASEMENTS OFFSETS & DIMENSIONS ALONG BOUNDARY ARE SHOWN ON SHEET 2 OF 2.

CURVE DATA TABLE				
CURVE	RADIUS	DELTA	LENGTH	CHORD BEARING & DISTANCE
C1	380.54'	20°25'12"	135.62'	N45°55'00"W 134.91'

DISCLAIMER:
UTILITY LOCATIONS ARE FROM AN ALTA SURVEY BY THIS OFFICE DATED JANUARY 27, 2022.

SURVEY FOR: LEVEL DEVELOPMENT NW	
LOCATION: SHARI'S RESTAURANT 29690 SW TOWN CENTER LOOP WEST, WILSONVILLE, OR 97070	
SE 1/4 SECTION 14 CITY OF WILSONVILLE T3S, R1W, W.M. CLACKAMAS COUNTY, OREGON	
LAZER SITE SURVEYING, LLC 2009 25TH STREET S.E. SALEM OREGON 97302 (503) 581-6362	CREW: TP/EG REVIEW: R.J.G./M.A.T. SCALE: 1"=20' JOB NO.: 2022-047 SHEET DATE: 01/17/2023 1 OF 2

Printed By: aday | Print Date: 7/15/2022 4:44:11 PM
File Name: J:\E-L\LevelDevNW\LevelDevNW-1-01\Figures\CAD\LevelDevNW-1-01-VM01.dwg | Layout: FIGURE 1

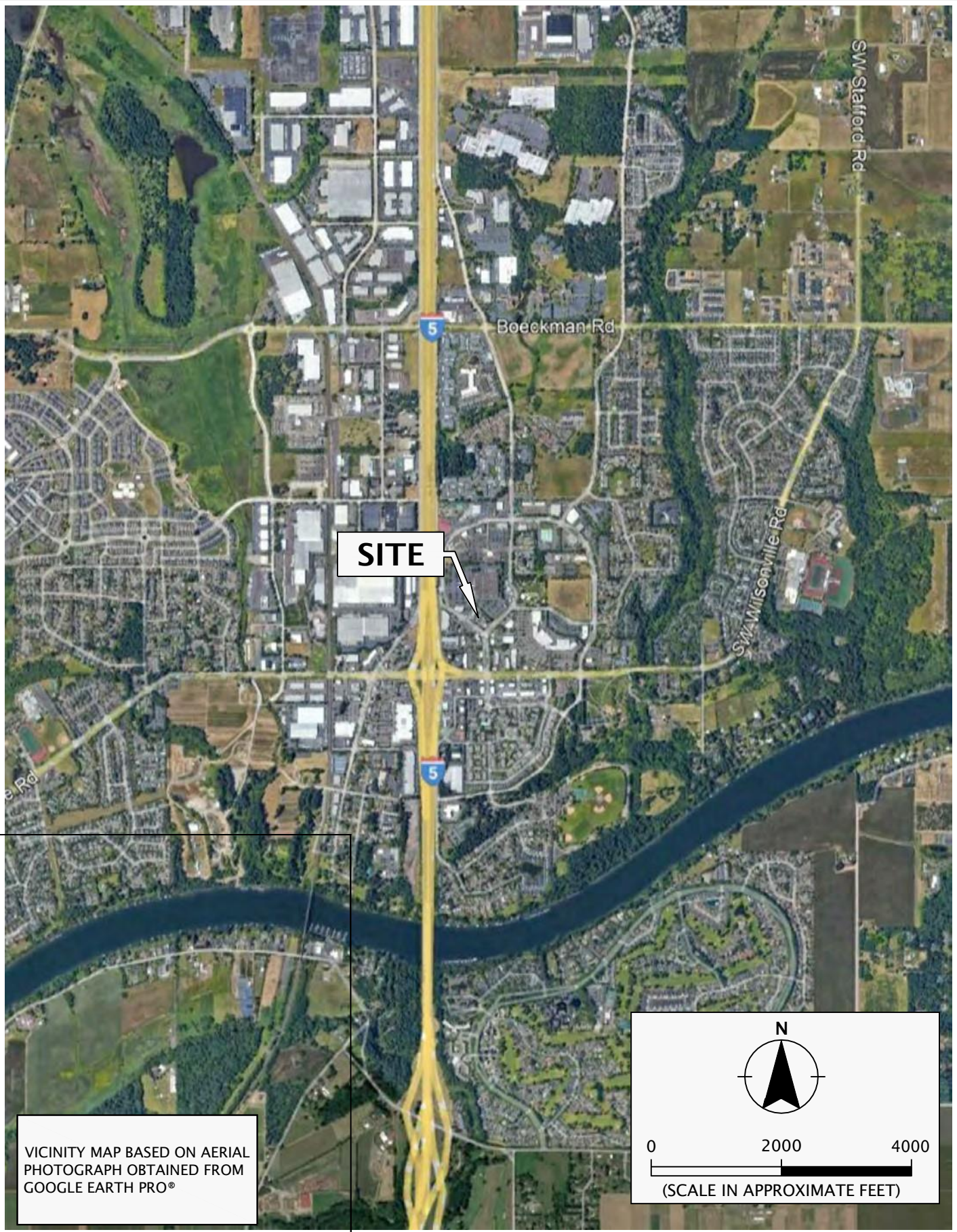

VICINITY MAP BASED ON AERIAL PHOTOGRAPH OBTAINED FROM GOOGLE EARTH PRO®

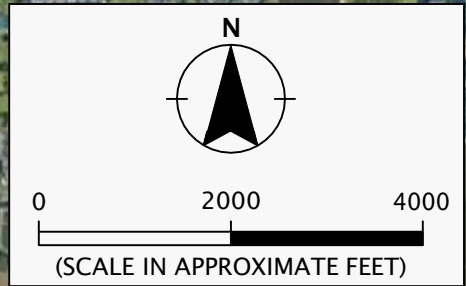

LEVELDEVNW-1-01

JULY 2022

VICINITY MAP

SHARI'S RESTAURANT SITE
WILSONVILLE, OR

FIGURE 1



LEGEND:

B-1 BORING

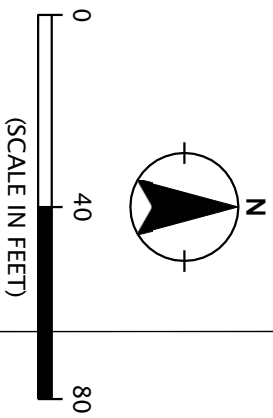

SITE PLAN BASED ON AERIAL PHOTOGRAPH DATED MAY 10, 2021, OBTAINED FROM GOOGLE EARTH PRO.

	LEVELDEVNW-1-01	SITE PLAN	
	JULY 2022	SHARI'S RESTAURANT SITE WILSONVILLE, OR	FIGURE 2

ATTACHMENT

ATTACHMENT

FIELD EXPLORATIONS

GENERAL

We explored subsurface conditions at the site by drilling two borings (B-1 and B-2) to depths of 16.3 and 20.8 feet BGS. Drilling services were provided by Dan J. Fischer Excavating, Inc. of Forest Grove, Oregon, on June 23, 2022, using a trailer-mounted drill rig with solid-stem auger methods. The exploration logs are presented in this attachment.

The locations of the explorations are shown on Figure 2. The exploration locations were determined by pacing from existing site features and should be considered accurate to the degree implied by the methods used. A member of our geology staff observed the explorations.

SOIL SAMPLING

We collected representative samples of the various soils encountered during drilling for geotechnical laboratory testing. Samples were collected from the borings using 1½- and 3-inch-inside-diameter, split-spoon (SPT) samplers in general accordance with ASTM D1586. The samplers were driven into the soil with a 140-pound hammer free-falling 30 inches. The sampler was driven a total distance of 18 inches. The number of blows required to drive the sampler the final 12 inches is recorded on the exploration logs, unless otherwise noted. Sampling methods and intervals are shown on the exploration logs.

The hammer used to conduct the SPTs was lifted using a rope and cathead system. The hammer was raised using two wraps of the rope around the cathead.

SOIL CLASSIFICATION

The soil samples were classified in the field in accordance with the “Exploration Key” (Table A-1) and “Soil Classification System” (Table A-2), which are presented in this attachment. The exploration logs indicates the depths at which the soil characteristics change, although the change actually could be gradual. If the change occurred between sample locations, the depth was interpreted. Classifications are shown on the exploration logs.

LABORATORY TESTING

CLASSIFICATION









The soil samples were classified in the laboratory to confirm field classifications. The laboratory classifications are shown on the exploration logs if those classifications differed from the field classifications.

MOISTURE CONTENT

The natural moisture content of select soil samples was determined in general accordance with ASTM D2216. The natural moisture content is a ratio of the weight of the water to dry soil in a test sample and is expressed as a percentage. The test results are presented in this attachment.

PARTICLE-SIZE ANALYSIS

Particle-size analysis was performed on select soil samples in general accordance with ASTM D1140. This test is a quantitative determination of the amount of material finer than the U.S. Standard No. 200 sieve expressed as a percentage of soil weight. The test results are presented in this attachment.

SYMBOL	SAMPLING DESCRIPTION
	Location of sample collected in general accordance with ASTM D1586 using Standard Penetration Test (SPT) with recovery
	Location of sample collected using thin-wall Shelby tube or Geoprobe® sampler in general accordance with ASTM D1587 with recovery
	Location of sample collected using Dames & Moore sampler and 300-pound hammer or pushed with recovery
	Location of sample collected using Dames & Moore sampler and 140-pound hammer or pushed with recovery
	Location of sample collected using 3-inch-outside diameter California split-spoon sampler and 140-pound hammer with recovery
	Location of grab sample
	Rock coring interval
	Water level during drilling
	Water level taken on date shown

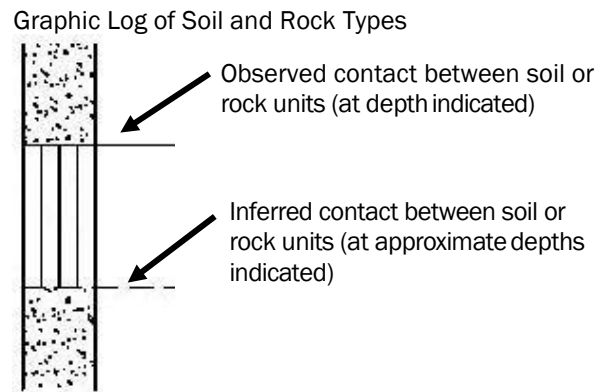

GEOTECHNICAL TESTING EXPLANATIONS

ATT	Atterberg Limits	P	Pushed Sample
CBR	California Bearing Ratio	PP	Pocket Penetrometer
CON	Consolidation	P200	Percent Passing U.S. Standard No. 200 Sieve
DD	Dry Density	RES	Resilient Modulus
DS	Direct Shear	SIEV	Sieve Gradation
HYD	Hydrometer Gradation	TOR	Torvane
MC	Moisture Content	UC	Unconfined Compressive Strength
MD	Moisture-Density Relationship	VS	Vane Shear
NP	Non-Plastic	kPa	Kilopascal
OC	Organic Content		

ENVIRONMENTAL TESTING EXPLANATIONS

CA	Sample Submitted for Chemical Analysis	ND	Not Detected
P	Pushed Sample	NS	No Visible Sheen
PID	Photoionization Detector Headspace Analysis	SS	Slight Sheen
ppm	Parts per Million	MS	Moderate Sheen
		HS	Heavy Sheen



RELATIVE DENSITY - COARSE-GRAINED SOIL								
Relative Density	Standard Penetration Test (SPT) Resistance		Dames & Moore Sampler (140-pound hammer)		Dames & Moore Sampler (300-pound hammer)			
Very loose	0 - 4		0 - 11		0 - 4			
Loose	4 - 10		11 - 26		4 - 10			
Medium dense	10 - 30		26 - 74		10 - 30			
Dense	30 - 50		74 - 120		30 - 47			
Very dense	More than 50		More than 120		More than 47			
CONSISTENCY - FINE-GRAINED SOIL								
Consistency	Standard Penetration Test (SPT) Resistance	Dames & Moore Sampler (140-pound hammer)	Dames & Moore Sampler (300-pound hammer)	Unconfined Compressive Strength (tsf)				
Very soft	Less than 2	Less than 3	Less than 2	Less than 0.25				
Soft	2 - 4	3 - 6	2 - 5	0.25 - 0.50				
Medium stiff	4 - 8	6 - 12	5 - 9	0.50 - 1.0				
Stiff	8 - 15	12 - 25	9 - 19	1.0 - 2.0				
Very stiff	15 - 30	25 - 65	19 - 31	2.0 - 4.0				
Hard	More than 30	More than 65	More than 31	More than 4.0				
PRIMARY SOIL DIVISIONS				GROUP SYMBOL	GROUP NAME			
COARSE-GRAINED SOIL (more than 50% retained on No. 200 sieve)	GRAVEL (more than 50% of coarse fraction retained on No. 4 sieve)	CLEAN GRAVEL (< 5% fines)		GW or GP	GRAVEL			
		GRAVEL WITH FINES (≥ 5% and ≤ 12% fines)		GW-GM or GP-GM	GRAVEL with silt			
				GW-GC or GP-GC	GRAVEL with clay			
		GRAVEL WITH FINES (> 12% fines)		GM	silty GRAVEL			
				GC	clayey GRAVEL			
			GC-GM	silty, clayey GRAVEL				
	SAND (50% or more of coarse fraction passing No. 4 sieve)	CLEAN SAND (<5% fines)		SW or SP	SAND			
		SAND WITH FINES (≥ 5% and ≤ 12% fines)		SW-SM or SP-SM	SAND with silt			
				SW-SC or SP-SC	SAND with clay			
		SAND WITH FINES (> 12% fines)		SM	silty SAND			
		SC	clayey SAND					
		SC-SM	silty, clayey SAND					
FINE-GRAINED SOIL (50% or more passing No. 200 sieve)	SILT AND CLAY	Liquid limit less than 50		ML	SILT			
				CL	CLAY			
				CL-ML	silty CLAY			
				OL	ORGANIC SILT or ORGANIC CLAY			
		Liquid limit 50 or greater		MH	SILT			
				CH	CLAY			
				OH	ORGANIC SILT or ORGANIC CLAY			
HIGHLY ORGANIC SOIL				PT	PEAT			
MOISTURE CLASSIFICATION		ADDITIONAL CONSTITUENTS						
Term	Field Test	Secondary granular components or other materials such as organics, man-made debris, etc.						
		Percent	Silt and Clay In:		Percent	Sand and Gravel In:		
	Fine-Grained Soil		Coarse-Grained Soil			Fine-Grained Soil	Coarse-Grained Soil	
dry	very low moisture, dry to touch	< 5	trace	trace	< 5	trace	trace	
moist	damp, without visible moisture	5 - 12	minor	with	5 - 15	minor	minor	
		> 12	some	silty/clayey	15 - 30	with	with	
wet	visible free water, usually saturated				> 30	sandy/gravelly	Indicate %	
		SOIL CLASSIFICATION SYSTEM				TABLE A-2		

BORING LOG - NV5 - 1 PER PAGE LEVELDEVNW-1-01-B1_2.GPJ GDI_NV5.GDT PRINT DATE: 7/15/22:KT

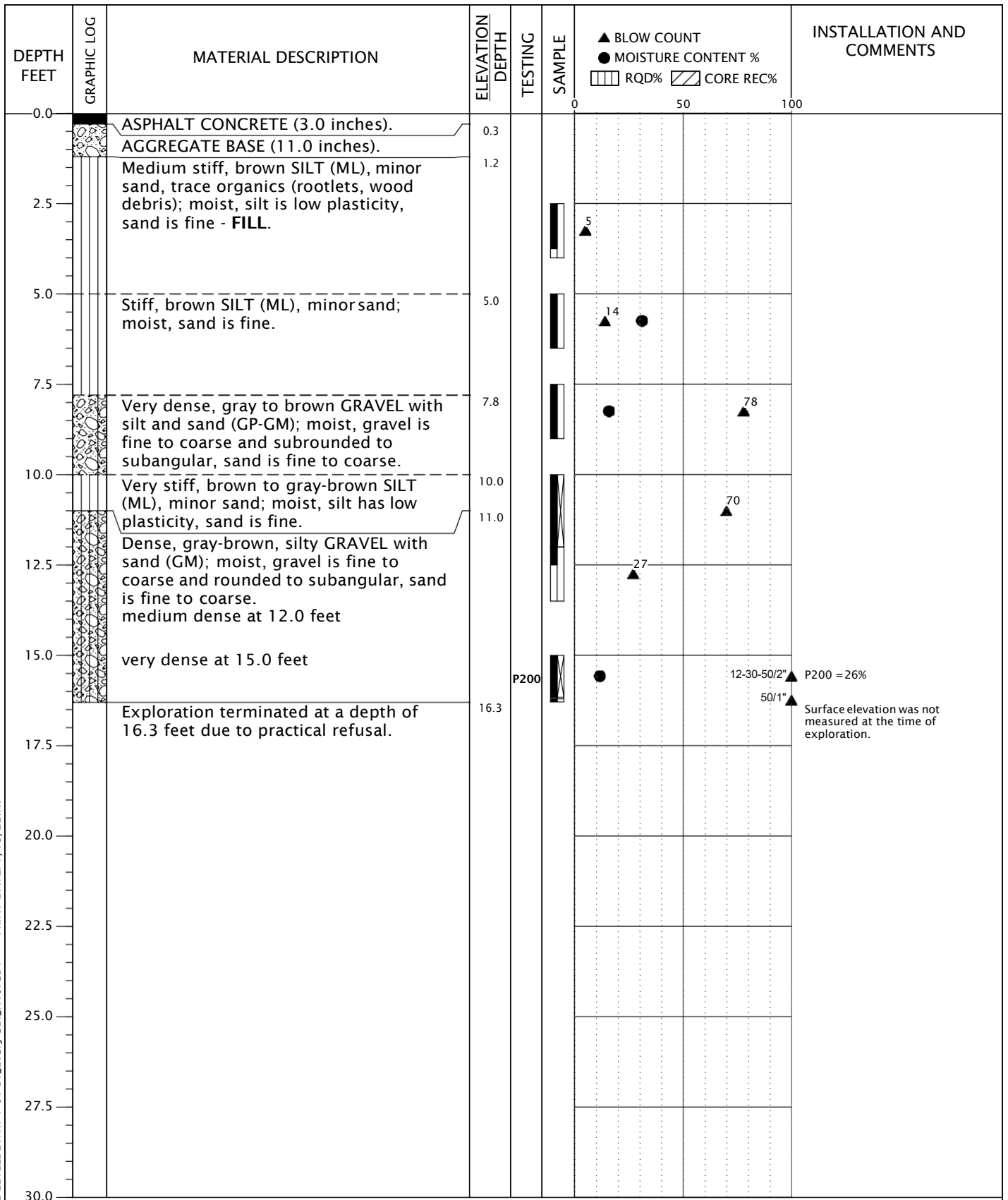

DRILLED BY: Dan J. Fischer Excavating, Inc.

LOGGED BY: S. Freeman

COMPLETED: 06/23/22

BORING METHOD: solid-stem auger (see document text)

BORING BIT DIAMETER: 4 inches



LEVELDEVNW-1-01

BORING B-1

JULY 2022

SHARI'S RESTAURANT SITE
WILSONVILLE, OR

FIGURE A-1

BORING LOG - NV5 - 1 PER PAGE LEVELDEVNW-1-01-B1_2.GPJ GDI_NV5.GDT PRINT DATE: 7/15/22:KT

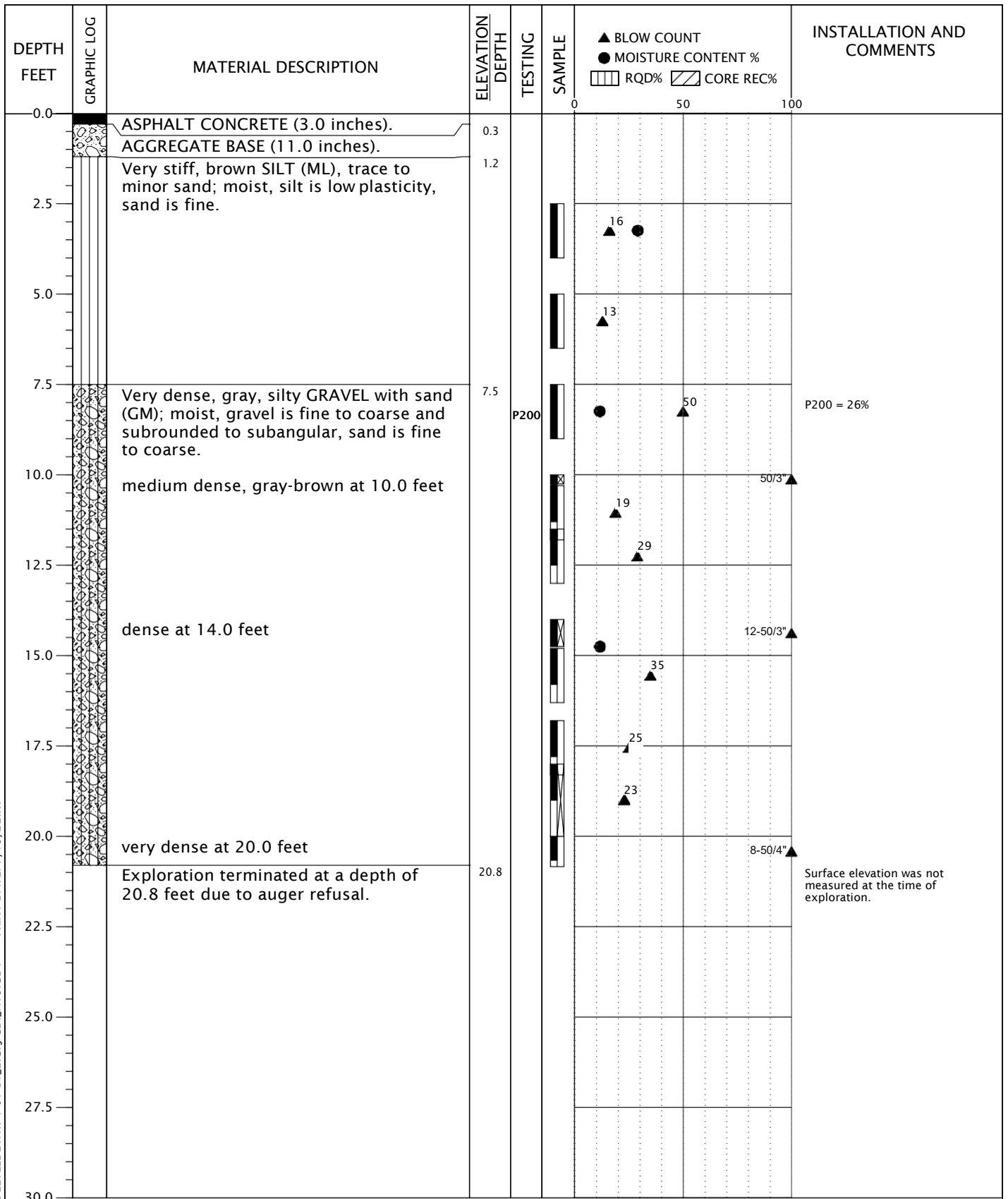

DRILLED BY: Dan J. Fischer Excavating, Inc.

LOGGED BY: S. Freeman

COMPLETED: 06/23/22

BORING METHOD: solid-stem auger (see document text)

BORING BIT DIAMETER: 4 inches



LEVELDEVNW-1-01

BORING B-2

JULY 2022

SHARI'S RESTAURANT SITE
WILSONVILLE, OR

FIGURE A-2

SAMPLE INFORMATION			MOISTURE CONTENT (PERCENT)	DRY DENSITY (PCF)	SIEVE			ATTERBERG LIMITS		
EXPLORATION NUMBER	SAMPLE DEPTH (FEET)	ELEVATION (FEET)			GRAVEL (PERCENT)	SAND (PERCENT)	P200 (PERCENT)	LIQUID LIMIT	PLASTIC LIMIT	PLASTICITY INDEX
B-1	5.0		31							
B-1	7.5		16							
B-1	15.0		12			26				
B-2	2.5		29							
B-2	7.5		12			26				
B-2	14.8		12							

	LEVELDEVNW-1-01	SUMMARY OF LABORATORY DATA		
	JULY 2022	SHARI'S RESTAURANT SITE WILSONVILLE, OR	FIGURE A-3	

March 14, 2023

Level Development NW
7327 SW Barnes Road, #523
Portland, OR 97225

Attention: Seth Henderson

Report of Infiltration Testing Services
Shari's Restaurant Site
29690 Town Center Loop West
Wilsonville, Oregon
Project: LevelDevNW-1-03

INTRODUCTION

This report presents the results of our infiltration testing for the proposed development located at 29690 Town Center Loop West in Wilsonville, Oregon. We understand that development will likely consist of a four-story, wood-framed, mixed-use building and associated surface parking areas. Figure 1 shows the site vicinity relative to surrounding features. Figure 2 shows the site layout and our approximate exploration locations. NV5 prepared a geotechnical due diligence report for the site in July 2022.¹

PURPOSE AND SCOPE

The purpose of our scope was to perform field infiltration testing to assist in design of on-site stormwater disposal systems. Specifically, we conducted the following tasks:

- Coordinated and managed the field exploration, including utility locates and scheduling of NV5 field staff.
- Conducted a subsurface exploration program consisting of drilling three 6-inch-diameter hollow-stem auger borings to depths between 14 and 19.5 feet below ground surface (BGS).
- Performed three infiltration tests using the encased falling head test method in general accordance with the City of Wilsonville *Public Works Standards*. The tests were performed at depths of 7.5, 10, and 13 feet BGS.

¹ NV5, 2022. *Due Diligence Geotechnical Engineering Services; Shari's Restaurant Site; 29690 Town Center Loop West; Wilsonville, Oregon*, dated July 15, 2022. Project: LevelDevNW-1-01

- Maintained a continuous log of the explorations and collected disturbed soil samples at representative intervals.
- Performed the following laboratory testing on samples collected from the explorations:
 - Four natural moisture content determinations in general accordance with ASTM D2216
 - Three particle-size analyses in general accordance with ASTM D1140
- Prepared this report summarizing the test program, presenting the test results, and providing general on-site stormwater disposal recommendations.

SITE CONDITIONS

SURFACE CONDITIONS

The site is currently occupied by asphalt concrete (AC) parking areas and a single-story Shari's restaurant. A site survey provided to us indicated that the site is relatively flat to gently sloped. The property is bordered to the north and east by a commercial building and parking areas and to the south and west by Town Center Loop West Road.

SUBSURFACE CONDITIONS

We explored subsurface conditions at the site by drilling three borings (IT-1 through IT-3) to depths between 14 and 19.5 feet BGS. The approximate locations of the explorations are shown on Figure 2. A description of the field explorations and laboratory testing program, the boring logs, and results of the laboratory testing are presented in Attachment A. Exploration logs and laboratory testing results from our 2022 study are presented in Attachment B.

Explorations at the site encountered 3 inches of AC overlying 8 to 11 inches of aggregate base at the ground surface. Silt with trace to minor amounts of fine sand underlies the aggregate base to depths of 6.1 to 7.8 feet BGS at the site. SPT results indicate that the silt is stiff to very stiff. Gravel with varying proportions of silt and sand underlies the silt unit to the maximum depth explored of 20.8 feet BGS. Gravel particles are generally rounded to subangular. SPT results indicate that the gravel is medium dense to very dense. The moisture content of the gravel samples was determined to range from 7 to 15 percent. Particle-size analysis indicated 18, 17, and 22 percent fines at depths of 7.5, 10, and 13 feet BGS, respectively.

Groundwater was not encountered in past or current borings to the maximum depth explored of 20.8 feet BGS. The depth of groundwater may fluctuate in response to seasonal changes, prolonged rainfall, changes in surface topography, and other factors not observed in this study.

INFILTRATION TESTING

Infiltration testing was performed in boring IT-1 at 7.5 feet BGS, boring IT-2 at 13 feet BGS, and boring IT-3 at 10 feet BGS using the encased falling head method and 6-inch hollow-stem augers to evaluate the feasibility of on-site stormwater disposal. A representative soil sample was collected below the infiltration test depths for particle-size analysis.

Table 1 summarizes the results of infiltration testing and particle-size analyses. The exploration logs and results of particle-size analyses are presented in Attachment A.

Table 1. Infiltration Testing Results

Exploration	Depth (feet BGS)	Soil Description	Percent Fines	Observed Infiltration Rate (in/hr)
IT-1	7.5	Silty GRAVEL with sand	18	0.4
IT-2	13.0	Silty GRAVEL with sand	22	3.0
IT-3	10.0	Silty GRAVEL with sand	17	7.2

in/hr: inches per hour

ON-SITE STORMWATER DISPOSAL

We understand that on-site stormwater disposal will be accomplished by means of drywells. The infiltration rates shown in Table 1 can be used to design stormwater disposal facilities. There is a relatively significant difference in infiltration rate observed at a depth of 7.5 feet BGS (IT-1) and the rates observed at depths of 10 and 13 feet BGS (IT-2 and IT-3). The test at 7.5 feet BGS was performed at the top of the gravel layer in a very dense zone of the gravel. This may explain the lower infiltration rate observed during this test. We recommend that drywells extend to a minimum depth of 10 feet BGS, which will allow the designer to select a design infiltration rate between 3 and 7.2 in/hr. It is important that infiltration systems be located at the approximate location and depth of our infiltration testing in order for the corresponding rates in Table 1 to be applicable.

The infiltration rates presented in Table 1 are short-term field rates and factors of safety have not been applied for the type of infiltration system being considered. Correction factors should be applied to the measured infiltration rates to account for soil variations and the potential for long-term clogging due to siltation and buildup of organic material. Without additional testing, from a geotechnical perspective, we recommend a minimum factor of safety of at least 3 be applied to the field infiltration values presented in Table 1 to account for soil variability with depth.

The infiltration flow rate of drywells will diminish over time as suspended solids and precipitates in the stormwater slowly clog the void spaces between the soil particles. Eventually, systems may fail and will need to be replaced or repaired. We recommend that any infiltration system be designed to overflow to a suitable discharge point such as the storm sewer or an acceptable overland release.

Stormwater infiltration systems will cause localized high groundwater levels; therefore, they should not be located near basement walls, retaining walls, or other embedded structures unless these are specifically designed to account for the resulting hydrostatic pressure. If basements will be constructed in the future, infiltration should occur at least 10 feet below the finished floor

elevation of the basement. It may be possible to reduce this offset depth if drywells are located a sufficient distance from the basement. The stormwater system should not be located on sloping ground unless it is approved by a geotechnical engineer.

Slight variations in soil density and composition are possible within short distances and can result in significant differences in infiltration capacity. Therefore, we recommend that stormwater disposal systems be field tested to confirm the design infiltration capacity has been achieved. We recommend contingencies be in place if field rates do not meet design rates. This may include deepening the drywells or installing additional drywells.

LIMITATIONS

We have prepared this report for use by Level Development NW and members of the design and construction teams for the proposed project. The data and report can be used for bidding or estimating purposes, but our report, conclusions, and interpretations should not be construed as warranty of the subsurface conditions and are not applicable to other nearby building sites.

Exploration observations indicate soil conditions only at specific locations and only to the depths penetrated. They do not necessarily reflect soil strata or water level variations that may exist between exploration locations. If subsurface conditions differing from those described are noted during the course of excavation and construction, re-evaluation will be necessary.

The site development plans and design details were preliminary at the time this report was prepared. When the design has been finalized and if there are changes in the site grades, location, or configuration; design loads; or type of construction, the conclusions and recommendations presented may not be applicable. If design changes are made, we request that we be retained to review our conclusions and recommendations and to provide a written modification or verification if needed.

The scope does not include services related to construction safety precautions, and our recommendations are not intended to direct the contractor's methods, techniques, sequences, or procedures, except as specifically described in this report for consideration in design.

Within the limitations of scope, schedule, and budget, our services have been executed in accordance with generally accepted practices in this area at the time this report was prepared. No warranty, expressed or implied, should be understood.

◆ ◆ ◆

We appreciate the opportunity to be of continued service to you. Please call if you have questions concerning this report or if we can provide additional services.

Sincerely,

NV5

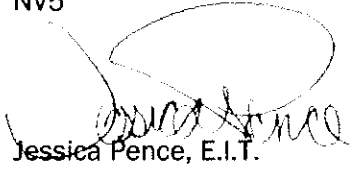

Jessica Pence, E.I.T.
Project Manager



Scott McDevitt, P.E., G.E.
Principal Engineer



ITA:JJP:SPM:sn

Attachments

One copy submitted

Document ID: LevelDevNW-1-03-031423-geolr

© 2023 NV5. All rights reserved.

FIGURES

Printed By: mmiller | Print Date: 3/14/2023 10:51:42 AM
File Name: J:\E\LevelDevNW\LevelDevNW-1-03\Figures\CAD\LevelDevNW-1-03-VM01.dwg | Layout: FIGURE 1

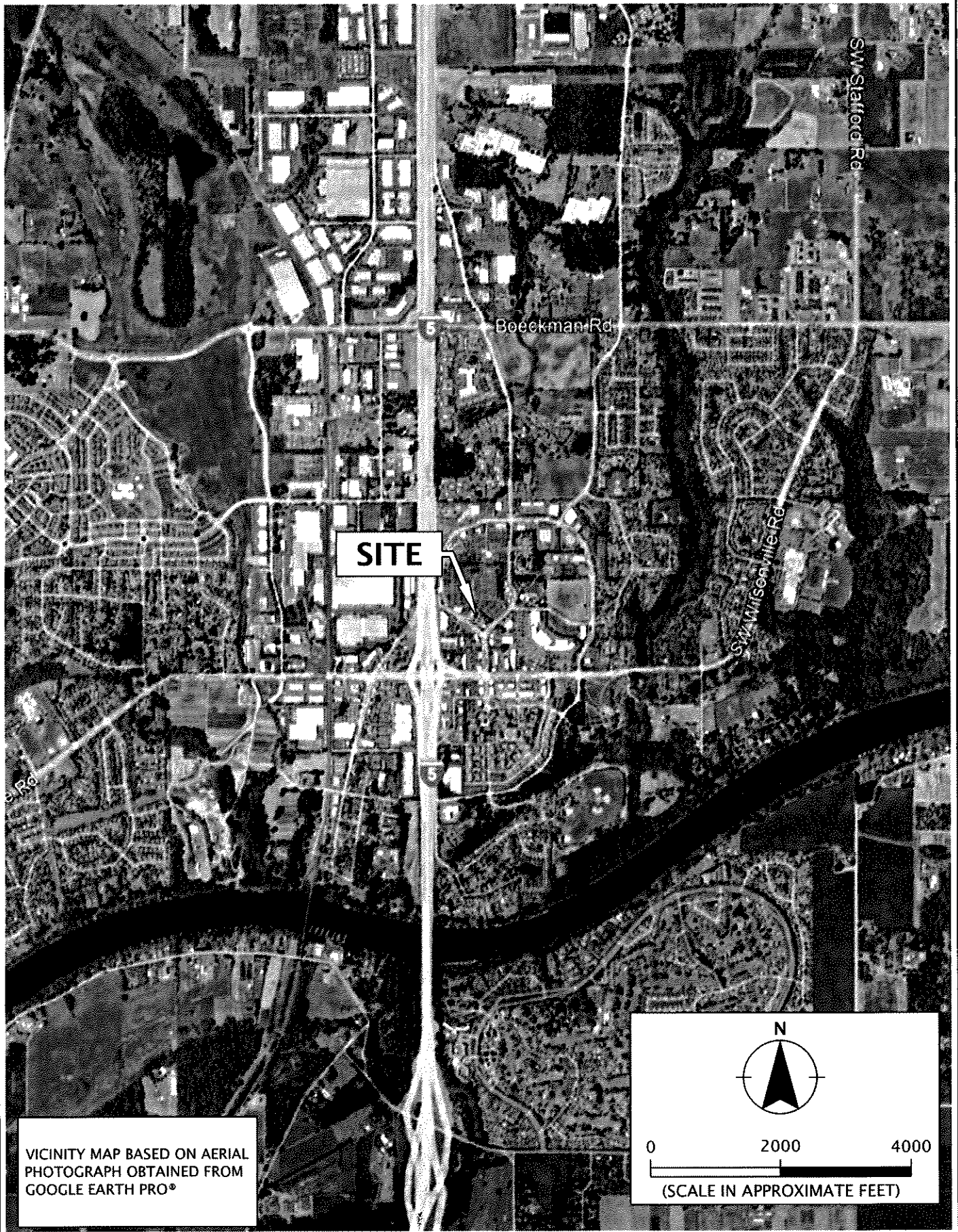

VICINITY MAP BASED ON AERIAL PHOTOGRAPH OBTAINED FROM GOOGLE EARTH PRO®

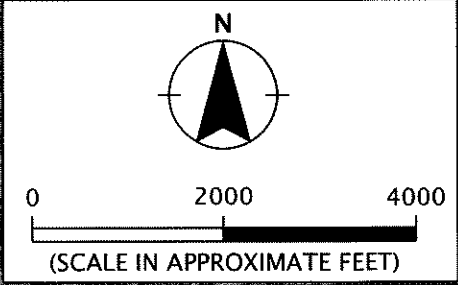

NIV15	LEVELDEVNW-1-03	VICINITY MAP	
	MARCH 2023	SHARI'S RESTAURANT SITE WILSONVILLE, OR	FIGURE 1

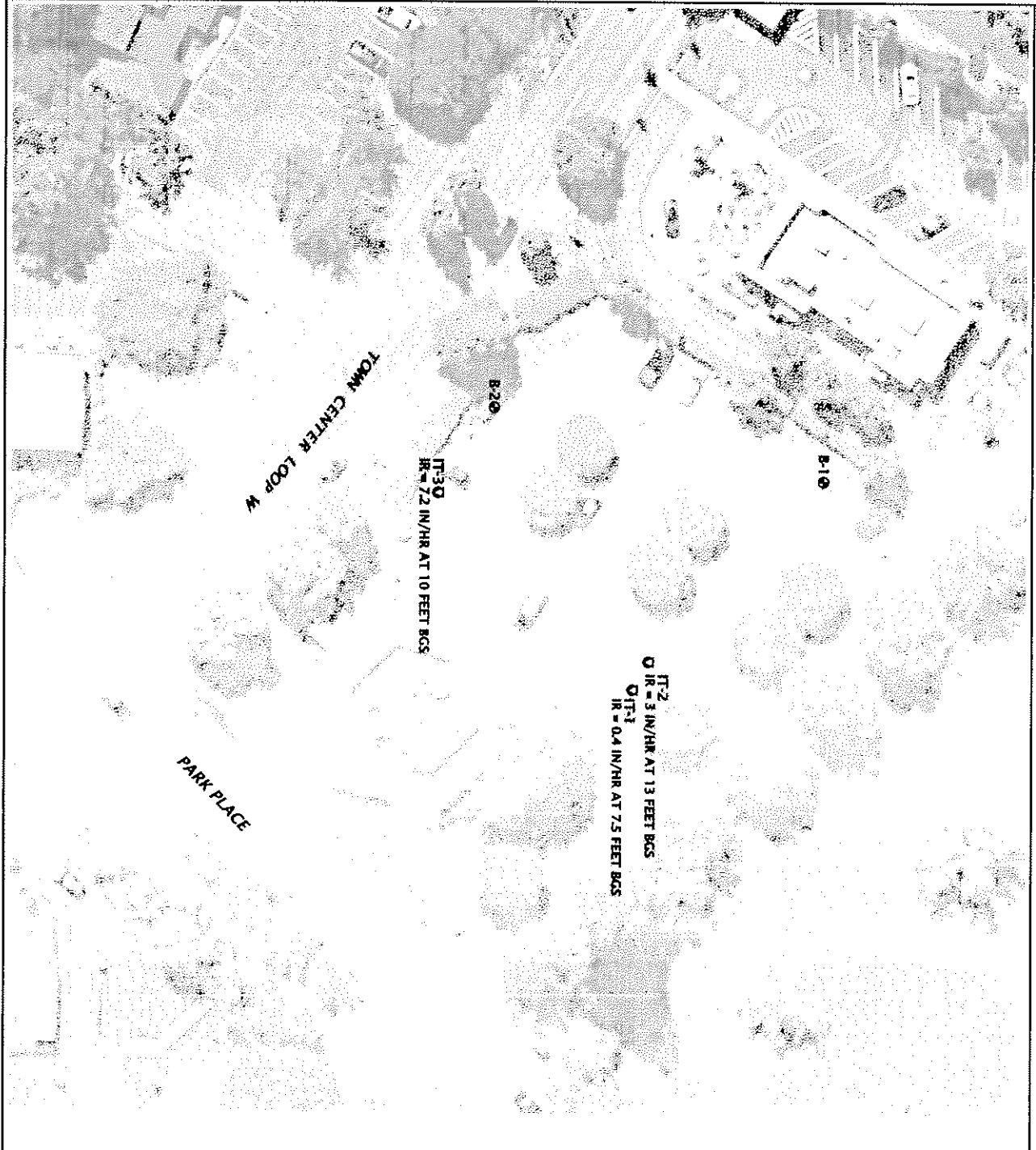

LEGEND:
 B-10 BORING (NVS, 2022)
 IT-1 INFILTRATION TEST BORING
 IR = 0.4 IN/HR UNFACTORED INFILTRATION RATE AT 7.5 FEET BGS

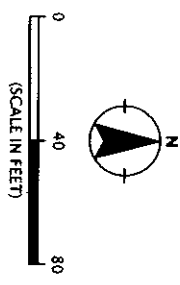

SITE PLAN BASED ON AERIAL PHOTOGRAPH DATED MAY 10, 2021, OBTAINED FROM GOOGLE EARTH PRO.

NIVIS	LEVELDEV\1-03	SITE PLAN	
	MARCH 2023	SHARI'S RESTAURANT SITE WILSONVILLE, OR	FIGURE 2

ATTACHMENT A

ATTACHMENT A

FIELD EXPLORATIONS

GENERAL

We explored subsurface conditions at the site by drilling three borings (IT-1 through IT-3) to depths between 14 and 19.5 feet BGS. Drilling services were provided by Western States Soil Conservation, Inc. of Hubbard, Oregon, on February 16, 2023, using a truck-mounted drill rig with hollow-stem auger methods. The exploration logs are presented in this attachment.

The locations of the explorations are shown on Figure 2. The exploration locations were determined by pacing from existing site features and should be considered accurate to the degree implied by the methods used. A member of our geology staff observed the explorations.

SOIL SAMPLING

We collected representative samples of the various soils encountered during drilling for geotechnical laboratory testing. Samples were collected from the borings using a 1½-inch-inside-diameter, split-spoon SPT sampler in general accordance with ASTM D1586. The sampler was driven into the soil with a 140-pound hammer free falling 30 inches. The sampler was driven a total distance of 18 inches. The number of blows required to drive the sampler the final 12 inches is recorded on the exploration logs, unless otherwise noted. Sampling methods and intervals are shown on the exploration logs.

The average efficiency of the automatic SPT hammer used by Western States Soil Conservation, Inc. was 77.7 percent. The calibration testing results are presented at the end of this attachment.

SOIL CLASSIFICATION

The soil samples were classified in accordance with the "Exploration Key" (Table A-1) and "Soil Classification System" (Table A-2), which are presented in this attachment. The exploration logs indicate the depths at which the soils or their characteristics change, although the change actually could be gradual. If the change occurred between sample locations, the depth was interpreted. Classifications are shown on the exploration logs.

LABORATORY TESTING

CLASSIFICATION









The soil samples were classified in the laboratory to confirm field classifications. The laboratory classifications are shown on the exploration logs if those classifications differed from the field classifications.

MOISTURE CONTENT

We tested the natural moisture content of select soil samples in general accordance with ASTM D2216. The natural moisture content is a ratio of the weight of the water to soil in a test sample and is expressed as a percentage. The test results are presented in this attachment.

PARTICLE-SIZE ANALYSIS

Particle-size analysis was completed on select soil samples in general accordance with ASTM C117 or ASTM D1140 (percent fines determination). The test results are presented in this attachment.

SYMBOL	SAMPLING DESCRIPTION
	Location of sample collected in general accordance with ASTM D1586 using Standard Penetration Test (SPT) with recovery
	Location of sample collected using thin-wall Shelby tube or Geoprobe® sampler in general accordance with ASTM D1587 with recovery
	Location of sample collected using Dames & Moore sampler and 300-pound hammer or pushed with recovery
	Location of sample collected using Dames & Moore sampler and 140-pound hammer or pushed with recovery
	Location of sample collected using 3-inch-outside diameter California split-spoon sampler and 140-pound hammer with recovery
	Location of grab sample
	Rock coring interval
	Water level during drilling
	Water level taken on date shown

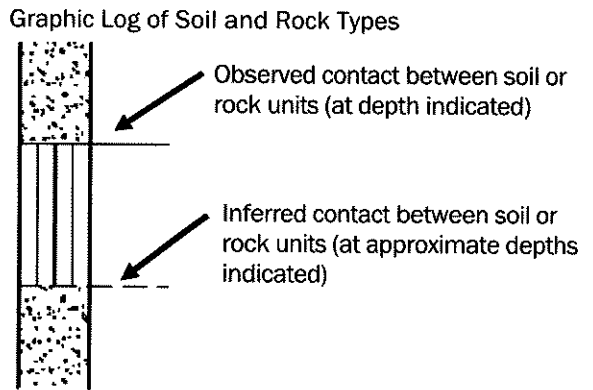

GEOTECHNICAL TESTING EXPLANATIONS

ATT	Atterberg Limits	P	Pushed Sample
CBR	California Bearing Ratio	PP	Pocket Penetrometer
CON	Consolidation	P200	Percent Passing U.S. Standard No. 200 Sieve
DD	Dry Density	RES	Resilient Modulus
DS	Direct Shear	SIEV	Sieve Gradation
HYD	Hydrometer Gradation	TOR	Torvane
MC	Moisture Content	UC	Unconfined Compressive Strength
MD	Moisture-Density Relationship	VS	Vane Shear
NP	Non-Plastic	kPa	Kilopascal
OC	Organic Content		

ENVIRONMENTAL TESTING EXPLANATIONS

CA	Sample Submitted for Chemical Analysis	ND	Not Detected
P	Pushed Sample	NS	No Visible Sheen
PID	Photoionization Detector Headspace Analysis	SS	Slight Sheen
ppm	Parts per Million	MS	Moderate Sheen
		HS	Heavy Sheen

N|V|5

EXPLORATION KEY

TABLE A-1

RELATIVE DENSITY - COARSE-GRAINED SOIL							
Relative Density	Standard Penetration Test (SPT) Resistance		Dames & Moore Sampler (140-pound hammer)		Dames & Moore Sampler (300-pound hammer)		
Very loose	0 - 4		0 - 11		0 - 4		
Loose	4 - 10		11 - 26		4 - 10		
Medium dense	10 - 30		26 - 74		10 - 30		
Dense	30 - 50		74 - 120		30 - 47		
Very dense	More than 50		More than 120		More than 47		
CONSISTENCY - FINE-GRAINED SOIL							
Consistency	Standard Penetration Test (SPT) Resistance	Dames & Moore Sampler (140-pound hammer)	Dames & Moore Sampler (300-pound hammer)	Unconfined Compressive Strength (tsf)			
Very soft	Less than 2	Less than 3	Less than 2	Less than 0.25			
Soft	2 - 4	3 - 6	2 - 5	0.25 - 0.50			
Medium stiff	4 - 8	6 - 12	5 - 9	0.50 - 1.0			
Stiff	8 - 15	12 - 25	9 - 19	1.0 - 2.0			
Very stiff	15 - 30	25 - 65	19 - 31	2.0 - 4.0			
Hard	More than 30	More than 65	More than 31	More than 4.0			
PRIMARY SOIL DIVISIONS			GROUP SYMBOL	GROUP NAME			
COARSE-GRAINED SOIL (more than 50% retained on No. 200 sieve)	GRAVEL (more than 50% of coarse fraction retained on No. 4 sieve)	CLEAN GRAVEL (< 5% fines)	GW or GP	GRAVEL			
		GRAVEL WITH FINES (≥ 5% and ≤ 12% fines)	GW-GM or GP-GM	GRAVEL with silt			
			GW-GC or GP-GC	GRAVEL with clay			
		GRAVEL WITH FINES (> 12% fines)	GM	silty GRAVEL			
			GC	clayey GRAVEL			
	GC-GM		silty, clayey GRAVEL				
	SAND (50% or more of coarse fraction passing No. 4 sieve)	CLEAN SAND (<5% fines)	SW or SP	SAND			
		SAND WITH FINES (≥ 5% and ≤ 12% fines)	SW-SM or SP-SM	SAND with silt			
			SW-SC or SP-SC	SAND with clay			
		SAND WITH FINES (> 12% fines)	SM	silty SAND			
SC			clayey SAND				
SC-SM			silty, clayey SAND				
FINE-GRAINED SOIL (50% or more passing No. 200 sieve)	SILT AND CLAY Liquid limit less than 50	ML	SILT				
		CL	CLAY				
		CL-ML	silty CLAY				
		OL	ORGANIC SILT or ORGANIC CLAY				
	Liquid limit 50 or greater	MH	SILT				
		CH	CLAY				
		OH	ORGANIC SILT or ORGANIC CLAY				
HIGHLY ORGANIC SOIL			PT	PEAT			
MOISTURE CLASSIFICATION		ADDITIONAL CONSTITUENTS					
Term	Field Test	Secondary granular components or other materials such as organics, man-made debris, etc.					
		Percent	Silt and Clay In:		Percent	Sand and Gravel In:	
Fine-Grained Soil	Coarse-Grained Soil		Fine-Grained Soil	Coarse-Grained Soil			
dry	very low moisture, dry to touch	< 5	trace	trace	< 5	trace	trace
moist	damp, without visible moisture	5 - 12	minor	with	5 - 15	minor	minor
		> 12	some	silty/clayey	15 - 30	with	with
wet	visible free water, usually saturated				> 30	sandy/gravelly	Indicate %
N I V I S		SOIL CLASSIFICATION SYSTEM				TABLE A-2	

BORING LOG - NV5 - 1 PER PAGE LEVELDEVNW-1-03-B1_3.GPJ GDLNV5.GDT PRINT DATE: 3/14/23 KT:SN

DEPTH FEET	GRAPHIC LOG	MATERIAL DESCRIPTION	ELEVATION DEPTH	TESTING	SAMPLE	▲ BLOW COUNT ● MOISTURE CONTENT % ▨ RQD% ▩ CORE REC%	INSTALLATION AND COMMENTS
0.0		ASPHALT CONCRETE (3.0 inches). AGGREGATE BASE (8.0 inches).	0.3 0.9				
2.5		Stiff, brown SILT (ML), trace sand; moist, sand is fine.				▲ 13	
5.0		medium stiff at 5.0 feet				▲ 6	
7.5		Very dense, gray, silty GRAVEL with sand (GM); dry, gravel is subangular to angular, sand is fine to coarse.	7.6	P200		●	Infiltration test at 7.5 feet. P200 = 18%
10.0		medium dense; moist at 10.0 feet pink at 10.4 feet gray at 10.5 feet gray-brown at 10.6 feet				▲ 23	
12.5		dry at 12.5 feet				▲ 26	
15.0		Exploration completed at a depth of 14.0 feet. Hammer efficiency factor is 77.7 percent.	14.0				Surface elevation was not measured at the time of exploration.
17.5							
20.0							
22.5							
25.0							
27.5							
30.0							

DRILLED BY: Western States Soil Conservation, Inc.

LOGGED BY: I. Allen

COMPLETED: 02/16/23

BORING METHOD: hollow-stem auger (see document text)

BORING BIT DIAMETER: 6 inches



LEVELDEVNW-1-03

BORING IT-1

MARCH 2023

SHARI'S RESTAURANT SITE
WILSONVILLE, OR

FIGURE A-1

BORING LOG - NVS - 1 PER PAGE LEVELDEVNW-1-03-B1-3-GPI-GDI-NVS-GDT PRINT DATE: 3/14/23-KT:SN

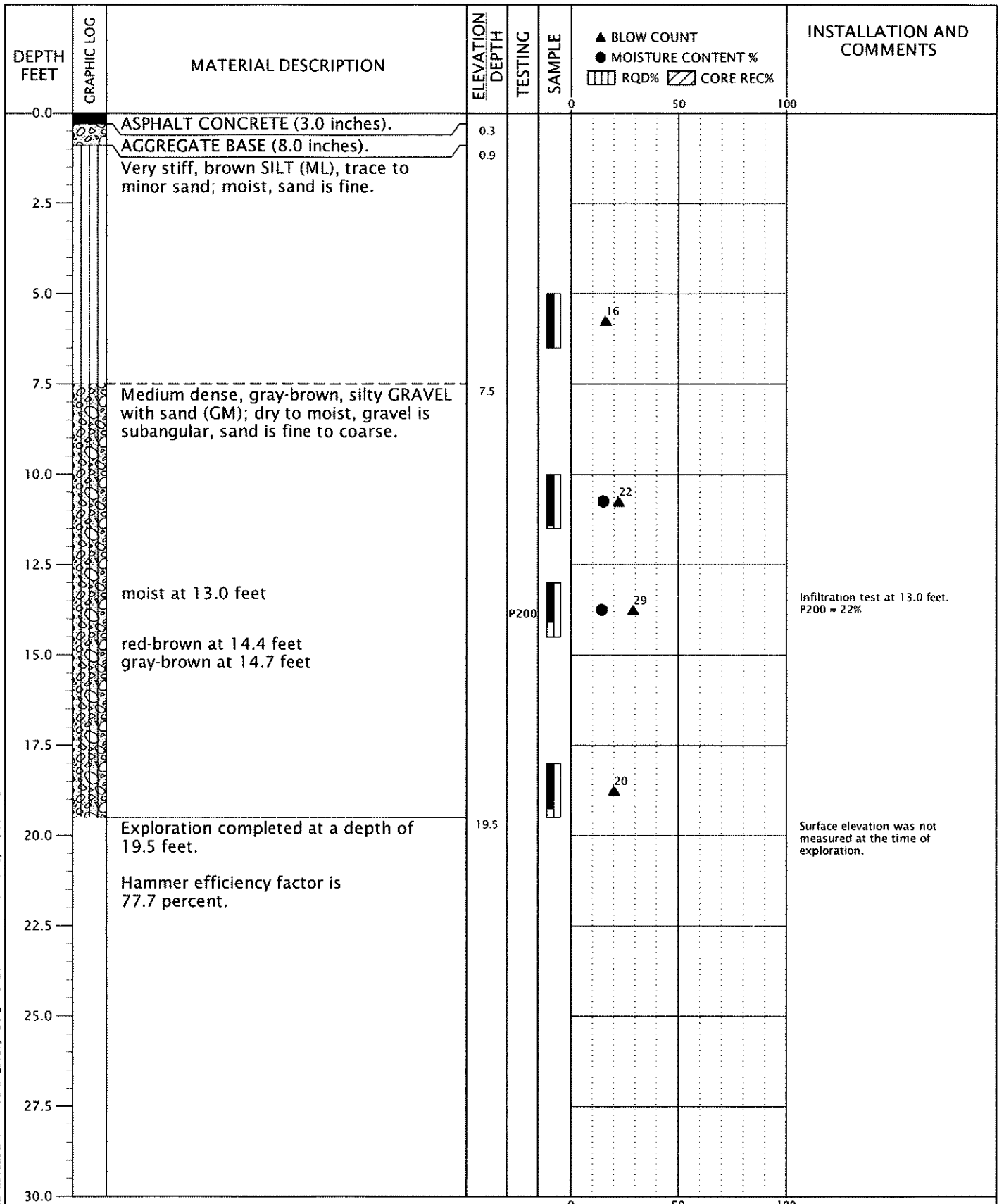

N V 5	LEVELDEVNW-1-03	BORING IT-2	
	MARCH 2023	SHARI'S RESTAURANT SITE WILSONVILLE, OR	FIGURE A-2

BORING LOG - NV5 - 1 PER PAGE LEVELDEVNW-1-03-B1_3.GPJ GDI_NV5.GDT PRINT DATE: 3/14/23:KT:SN

DEPTH FEET	GRAPHIC LOG	MATERIAL DESCRIPTION	ELEVATION DEPTH	TESTING	SAMPLE	▲ BLOW COUNT ● MOISTURE CONTENT % ▨ RQD% ▩ CORE REC%	INSTALLATION AND COMMENTS
0.0		ASPHALT CONCRETE (3.0 inches). AGGREGATE BASE (8.0 inches).	0.3				
2.5		Stiff, brown SILT (ML), trace sand; moist, sand is fine.	0.9				
5.0							
7.5		Medium dense, gray-brown, silty GRAVEL with sand (GM); dry to moist, gravel is subangular, sand is fine to coarse. dense, gray-pink at 7.5 feet gray-brown at 7.8 feet	6.1			▲ 10	
10.0		medium dense at 10.0 feet				▲ 28	
12.5						▲ 40	
15.0							
17.5		Exploration completed at a depth of 16.5 feet. Hammer efficiency factor is 77.7 percent.	16.5			● 14	Infiltration test at 10.0 feet. P200 = 17%
20.0							
22.5							
25.0						▲ 25	Surface elevation was not measured at the time of exploration.
27.5							
30.0							

DRILLED BY: Western States Soil Conservation, Inc.

LOGGED BY: I. Allen

COMPLETED: 02/16/23

BORING METHOD: hollow-stem auger (see document text)

BORING BIT DIAMETER: 6 inches

N|V|5

LEVELDEVNW-1-03

BORING IT-3

MARCH 2023

SHARI'S RESTAURANT SITE
WILSONVILLE, OR

FIGURE A-3

SAMPLE INFORMATION			MOISTURE CONTENT (PERCENT)	DRY DENSITY (PCF)	SIEVE			ATTERBERG LIMITS		
EXPLORATION NUMBER	SAMPLE DEPTH (FEET)	ELEVATION (FEET)			GRAVEL (PERCENT)	SAND (PERCENT)	P200 (PERCENT)	LIQUID LIMIT	PLASTIC LIMIT	PLASTICITY INDEX
IT-1	7.5		7			18				
IT-2	10.0		15							
IT-2	13.0		14			22				
IT-3	10.0		12			17				

LAB SUMMARY - GDLNVS LEVELDEVNW-1-03-81_3.GPJ GDLNVS.CDT PRINT DATE: 3/14/23:5N

N V 5	LEVELDEVNW-1-03	SUMMARY OF LABORATORY DATA		
	MARCH 2023	SHARI'S RESTAURANT SITE WILSONVILLE, OR	FIGURE A-4	

Summary of SPT Test Results

Project: WSSC-8-06, Test Date: 12/23/2021

FMX: Maximum Force
VMX: Maximum Velocity
BPM: Blows/Minute

EFV: Maximum Energy
ETR: Energy Transfer Ratio - Rated

Instr. Length ft	Blows Applied /6"	N Value	N60 Value	Average FMX kips	Average VMX ft/s	Average BPM bpm	Average EFV ft-lb	Average ETR %
60.00	11-17-20	37	47	42	14.3	52.9	282	80.6
60.00	5-8-16	24	31	42	14.2	52.8	258	73.7
60.00	13-16-0	16	20	35	12.5	46.4	245	70.1
60.00	5-10-15	25	32	42	14.2	48.0	288	82.3
60.00	3-7-10	17	22	39	13.1	44.8	271	77.5
Overall Average Values:		41	41	41	13.8	49.8	272	77.7
Standard Deviation:		2	2	2	0.8	3.3	16	4.5
Overall Maximum Value:		43	43	43	15.2	53.3	297	84.8
Overall Minimum Value:		34	34	34	11.8	43.5	238	67.9

ATTACHMENT B

ATTACHMENT B

EXPLORATION LOGS AND LABORATORY TESTING RESULTS FROM 2022 STUDY

BORING LOG - NV5 - 1 PER PAGE LEVELDEVNW-1-01-B1_2.GPJ GD\NV5.GDT PRINT DATE: 7/15/22:KT

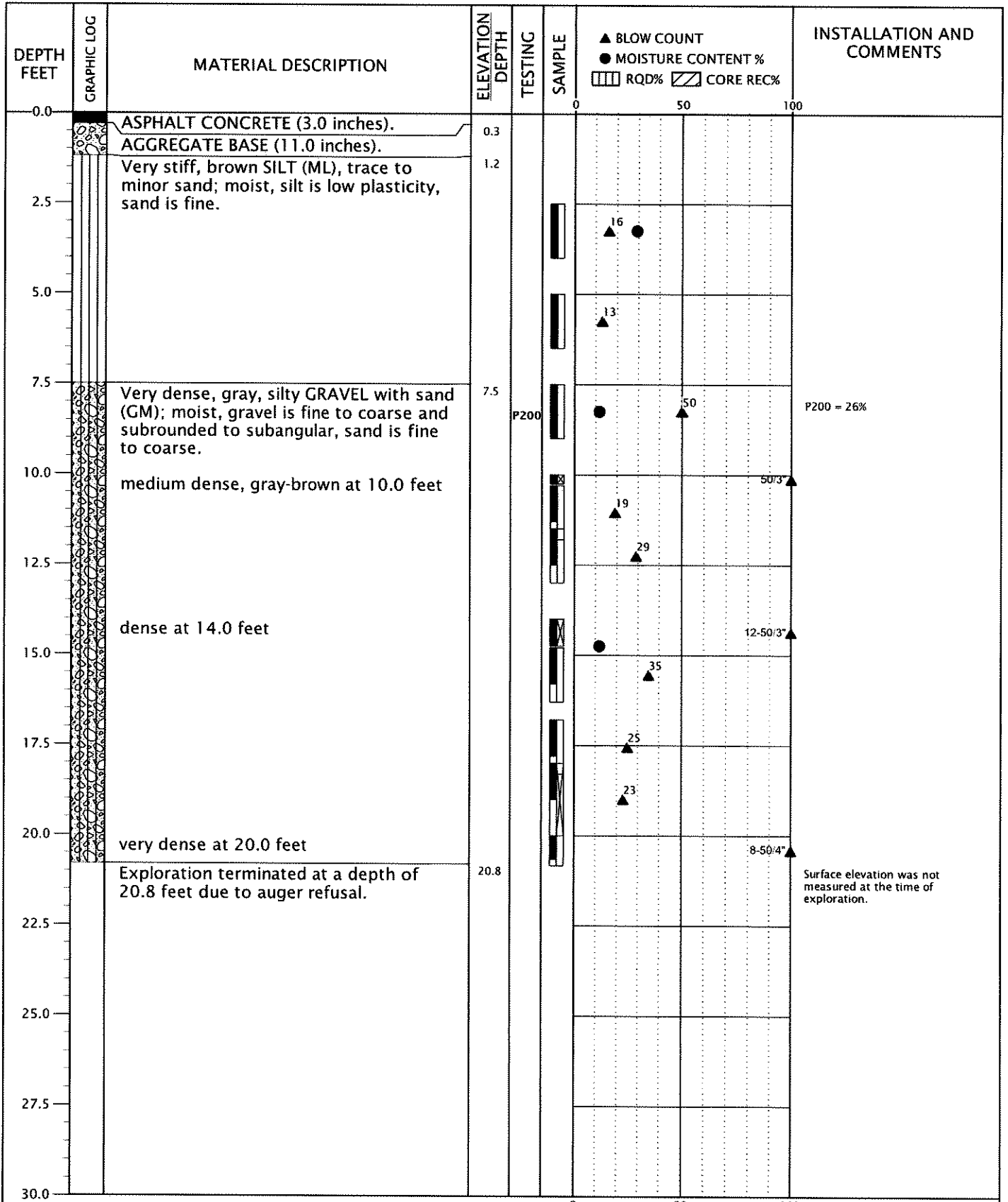

DRILLED BY: Dan J. Fischer Excavating, Inc.

LOGGED BY: S. Freeman

COMPLETED: 06/23/22

BORING METHOD: solid-stem auger (see document text)

BORING BIT DIAMETER: 4 inches



LEVELDEVNW-1-01

BORING B-2

JULY 2022

SHARI'S RESTAURANT SITE
WILSONVILLE, OR

FIGURE A-2

SAMPLE INFORMATION			MOISTURE CONTENT (PERCENT)	DRY DENSITY (PCF)	SIEVE			ATTERBERG LIMITS		
EXPLORATION NUMBER	SAMPLE DEPTH (FEET)	ELEVATION (FEET)			GRAVEL (PERCENT)	SAND (PERCENT)	P200 (PERCENT)	LIQUID LIMIT	PLASTIC LIMIT	PLASTICITY INDEX
B-1	5.0		31							
B-1	7.5		16							
B-1	15.0		12			26				
B-2	2.5		29							
B-2	7.5		12			26				
B-2	14.8		12							

LAB SUMMARY - GDI-NV5 LEVELDEVNW-1-01-B1-2-GPJ_GDL-NV5.GDT PRINT DATE: 7/11/22-SN

N V 5	LEVELDEVNW-1-01	SUMMARY OF LABORATORY DATA		
	JULY 2022	SHARI'S RESTAURANT SITE WILSONVILLE, OR		FIGURE A-3

From: Allen Schmitz
Sent: Tuesday, April 25, 2023 4:55 PM
To: kevin.weberling@deq.oregon.gov
Cc: David Humber
Subject: UIC for Land Use
Attachments: [WTC Landuse - 03-13-2023 3.pdf](#)

Kevin,

We are working on a project in Wilsonville and we are in the process of getting land use approval. We recently received an incomplete letter from the City and one of the items that have asked us to address is the following statement.

“Documentation that a UIC would be approved at this location by DEQ must be provided with the land use application”

Site address is 29690 SW Town Center loop Wilsonville, OR. Shown below in the mapping tool with the parcel #411.

We are providing water quality treatment prior to the UIC and we have infiltration testing that validates.

Would it be possible for you to reply to this email letting us know if there is any additional information that we would need to provide in order to respond to the City.

Please feel free to reach out if you have any questions.

Thanks,



Oregon Water Resources Department Well Report Mapping Tool

Search Identify **Layers** Bookmarks

- Well Reports
 - Water Wells
 - Type of Well Report
 - Water Wells
 - Monitoring Wells
 - Geotechnical Holes
 - Type of Work for Water/Monitor Wells
 - New Wells
 - Deepening Wells
 - Conversion Wells
 - Alteration Wells
 - Abandonment Wells
 - Other
 - Type of Work for Geotechnical Holes
 - Well Characteristics
- Wildfire Extent
- Other Boundaries
- Hydrography/River Miles
- Tax Lots
- PLSS
- DOGAMI Geology

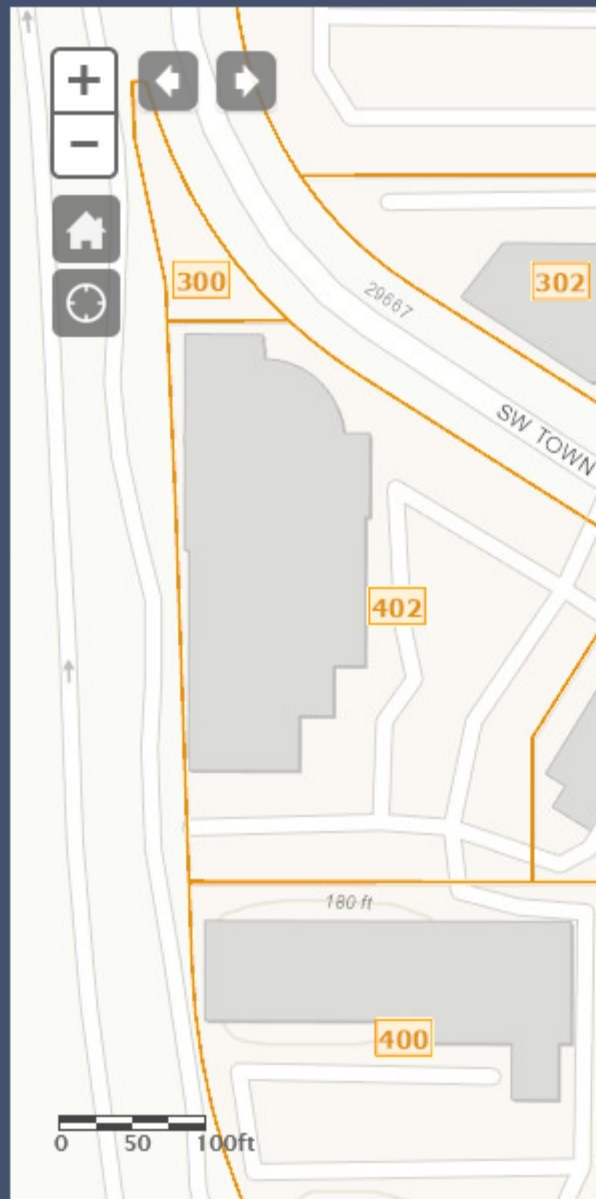

Wells

Allen Schmitz P.E.
Sr. Project Engineer
D: 503.488.5711

Humber Design Group, Inc.

Urban Civil Engineering

110 SE Main Street, Suite 200, Portland, OR 97214

www.hdgpdx.com

100 Best Companies in Oregon 2019 and 2020

100 Best Green Workplaces in Oregon 2019

City of Portland Sustainability at Work Silver Certified

March 14, 2023

Level Development NW
7327 SW Barnes Road, #523
Portland, OR 97225

Attention: Seth Henderson

Report of Infiltration Testing Services

Shari's Restaurant Site
29690 Town Center Loop West
Wilsonville, Oregon
Project: LevelDevNW-1-03

INTRODUCTION

This report presents the results of our infiltration testing for the proposed development located at 29690 Town Center Loop West in Wilsonville, Oregon. We understand that development will likely consist of a four-story, wood-framed, mixed-use building and associated surface parking areas. Figure 1 shows the site vicinity relative to surrounding features. Figure 2 shows the site layout and our approximate exploration locations. NV5 prepared a geotechnical due diligence report for the site in July 2022.¹

PURPOSE AND SCOPE

The purpose of our scope was to perform field infiltration testing to assist in design of on-site stormwater disposal systems. Specifically, we conducted the following tasks:

- Coordinated and managed the field exploration, including utility locates and scheduling of NV5 field staff.
- Conducted a subsurface exploration program consisting of drilling three 6-inch-diameter hollow-stem auger borings to depths between 14 and 19.5 feet below ground surface (BGS).
- Performed three infiltration tests using the encased falling head test method in general accordance with the City of Wilsonville *Public Works Standards*. The tests were performed at depths of 7.5, 10, and 13 feet BGS.

¹ NV5, 2022. *Due Diligence Geotechnical Engineering Services; Shari's Restaurant Site; 29690 Town Center Loop West; Wilsonville, Oregon*, dated July 15, 2022. Project: LevelDevNW-1-01

- Maintained a continuous log of the explorations and collected disturbed soil samples at representative intervals.
- Performed the following laboratory testing on samples collected from the explorations:
 - Four natural moisture content determinations in general accordance with ASTM D2216
 - Three particle-size analyses in general accordance with ASTM D1140
- Prepared this report summarizing the test program, presenting the test results, and providing general on-site stormwater disposal recommendations.

SITE CONDITIONS

SURFACE CONDITIONS

The site is currently occupied by asphalt concrete (AC) parking areas and a single-story Shari's restaurant. A site survey provided to us indicated that the site is relatively flat to gently sloped. The property is bordered to the north and east by a commercial building and parking areas and to the south and west by Town Center Loop West Road.

SUBSURFACE CONDITIONS

We explored subsurface conditions at the site by drilling three borings (IT-1 through IT-3) to depths between 14 and 19.5 feet BGS. The approximate locations of the explorations are shown on Figure 2. A description of the field explorations and laboratory testing program, the boring logs, and results of the laboratory testing are presented in Attachment A. Exploration logs and laboratory testing results from our 2022 study are presented in Attachment B.

Explorations at the site encountered 3 inches of AC overlying 8 to 11 inches of aggregate base at the ground surface. Silt with trace to minor amounts of fine sand underlies the aggregate base to depths of 6.1 to 7.8 feet BGS at the site. SPT results indicate that the silt is stiff to very stiff. Gravel with varying proportions of silt and sand underlies the silt unit to the maximum depth explored of 20.8 feet BGS. Gravel particles are generally rounded to subangular. SPT results indicate that the gravel is medium dense to very dense. The moisture content of the gravel samples was determined to range from 7 to 15 percent. Particle-size analysis indicated 18, 17, and 22 percent fines at depths of 7.5, 10, and 13 feet BGS, respectively.

Groundwater was not encountered in past or current borings to the maximum depth explored of 20.8 feet BGS. The depth of groundwater may fluctuate in response to seasonal changes, prolonged rainfall, changes in surface topography, and other factors not observed in this study.

INFILTRATION TESTING

Infiltration testing was performed in boring IT-1 at 7.5 feet BGS, boring IT-2 at 13 feet BGS, and boring IT-3 at 10 feet BGS using the encased falling head method and 6-inch hollow-stem augers to evaluate the feasibility of on-site stormwater disposal. A representative soil sample was collected below the infiltration test depths for particle-size analysis.

Table 1 summarizes the results of infiltration testing and particle-size analyses. The exploration logs and results of particle-size analyses are presented in Attachment A.

Table 1. Infiltration Testing Results

Exploration	Depth (feet BGS)	Soil Description	Percent Fines	Observed Infiltration Rate (in/hr)
IT-1	7.5	Silty GRAVEL with sand	18	0.4
IT-2	13.0	Silty GRAVEL with sand	22	3.0
IT-3	10.0	Silty GRAVEL with sand	17	7.2

in/hr: inches per hour

ON-SITE STORMWATER DISPOSAL

We understand that on-site stormwater disposal will be accomplished by means of drywells. The infiltration rates shown in Table 1 can be used to design stormwater disposal facilities. There is a relatively significant difference in infiltration rate observed at a depth of 7.5 feet BGS (IT-1) and the rates observed at depths of 10 and 13 feet BGS (IT-2 and IT-3). The test at 7.5 feet BGS was performed at the top of the gravel layer in a very dense zone of the gravel. This may explain the lower infiltration rate observed during this test. We recommend that drywells extend to a minimum depth of 10 feet BGS, which will allow the designer to select a design infiltration rate between 3 and 7.2 in/hr. It is important that infiltration systems be located at the approximate location and depth of our infiltration testing in order for the corresponding rates in Table 1 to be applicable.

The infiltration rates presented in Table 1 are short-term field rates and factors of safety have not been applied for the type of infiltration system being considered. Correction factors should be applied to the measured infiltration rates to account for soil variations and the potential for long-term clogging due to siltation and buildup of organic material. Without additional testing, from a geotechnical perspective, we recommend a minimum factor of safety of at least 3 be applied to the field infiltration values presented in Table 1 to account for soil variability with depth.

The infiltration flow rate of drywells will diminish over time as suspended solids and precipitates in the stormwater slowly clog the void spaces between the soil particles. Eventually, systems may fail and will need to be replaced or repaired. We recommend that any infiltration system be designed to overflow to a suitable discharge point such as the storm sewer or an acceptable overland release.

Stormwater infiltration systems will cause localized high groundwater levels; therefore, they should not be located near basement walls, retaining walls, or other embedded structures unless these are specifically designed to account for the resulting hydrostatic pressure. If basements will be constructed in the future, infiltration should occur at least 10 feet below the finished floor

elevation of the basement. It may be possible to reduce this offset depth if drywells are located a sufficient distance from the basement. The stormwater system should not be located on sloping ground unless it is approved by a geotechnical engineer.

Slight variations in soil density and composition are possible within short distances and can result in significant differences in infiltration capacity. Therefore, we recommend that stormwater disposal systems be field tested to confirm the design infiltration capacity has been achieved. We recommend contingencies be in place if field rates do not meet design rates. This may include deepening the drywells or installing additional drywells.

LIMITATIONS

We have prepared this report for use by Level Development NW and members of the design and construction teams for the proposed project. The data and report can be used for bidding or estimating purposes, but our report, conclusions, and interpretations should not be construed as warranty of the subsurface conditions and are not applicable to other nearby building sites.

Exploration observations indicate soil conditions only at specific locations and only to the depths penetrated. They do not necessarily reflect soil strata or water level variations that may exist between exploration locations. If subsurface conditions differing from those described are noted during the course of excavation and construction, re-evaluation will be necessary.

The site development plans and design details were preliminary at the time this report was prepared. When the design has been finalized and if there are changes in the site grades, location, or configuration; design loads; or type of construction, the conclusions and recommendations presented may not be applicable. If design changes are made, we request that we be retained to review our conclusions and recommendations and to provide a written modification or verification if needed.

The scope does not include services related to construction safety precautions, and our recommendations are not intended to direct the contractor's methods, techniques, sequences, or procedures, except as specifically described in this report for consideration in design.

Within the limitations of scope, schedule, and budget, our services have been executed in accordance with generally accepted practices in this area at the time this report was prepared. No warranty, expressed or implied, should be understood.



We appreciate the opportunity to be of continued service to you. Please call if you have questions concerning this report or if we can provide additional services.

Sincerely,

NV5

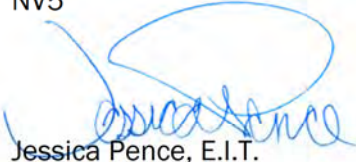

Jessica Pence, E.I.T.
Project Manager



Scott McDevitt, P.E., G.E.
Principal Engineer



ITA:JJP:SPM:sn

Attachments

One copy submitted

Document ID: LevelDevNW-1-03-031423-geolr

© 2023 NV5. All rights reserved.

FIGURES

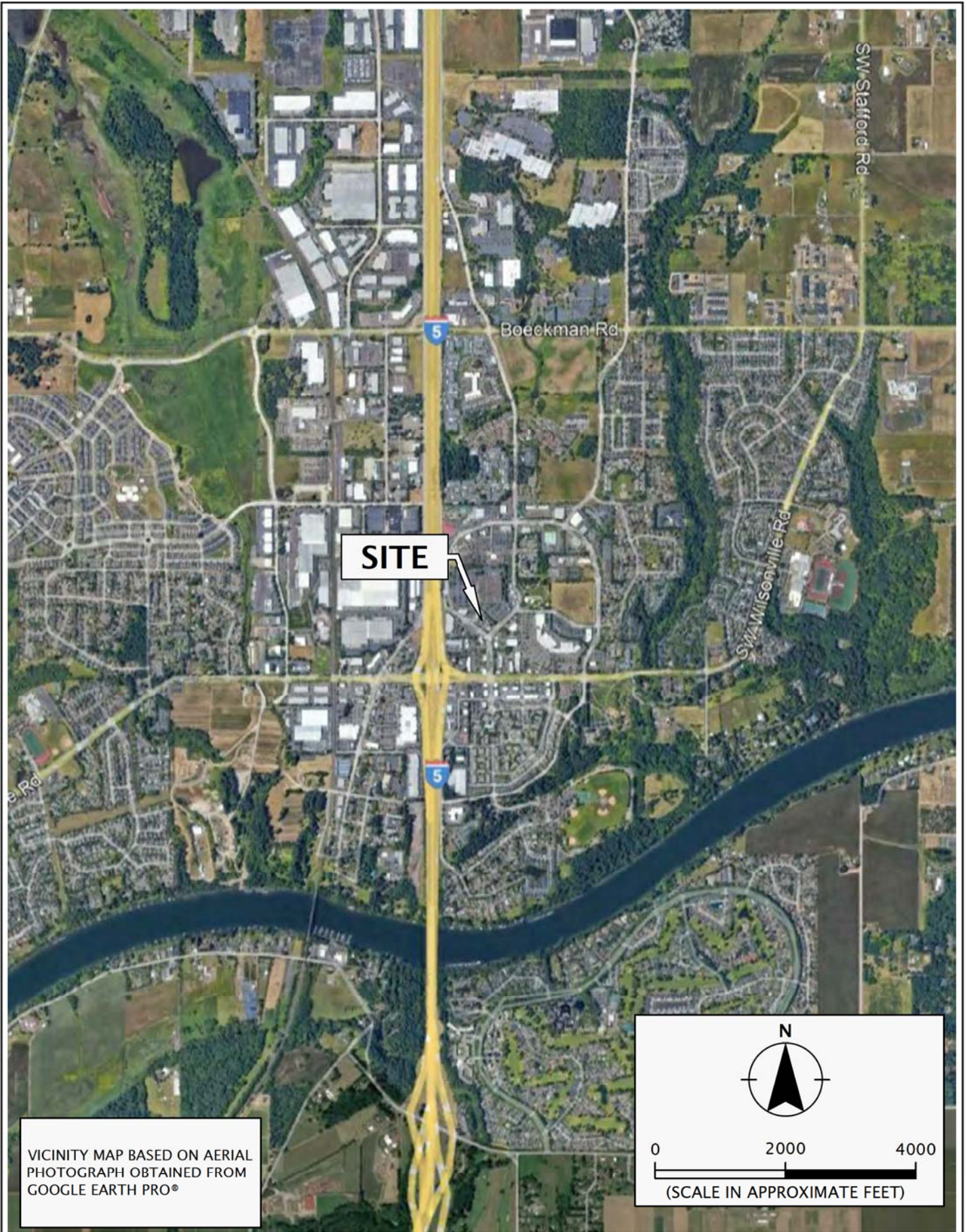

VICINITY MAP BASED ON AERIAL PHOTOGRAPH OBTAINED FROM GOOGLE EARTH PRO®

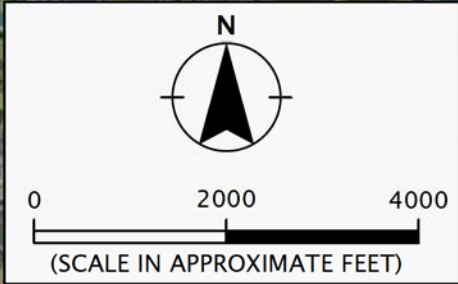

	LEVELDEVNW-1-03	VICINITY MAP	
	MARCH 2023	SHARI'S RESTAURANT SITE WILSONVILLE, OR	FIGURE 1

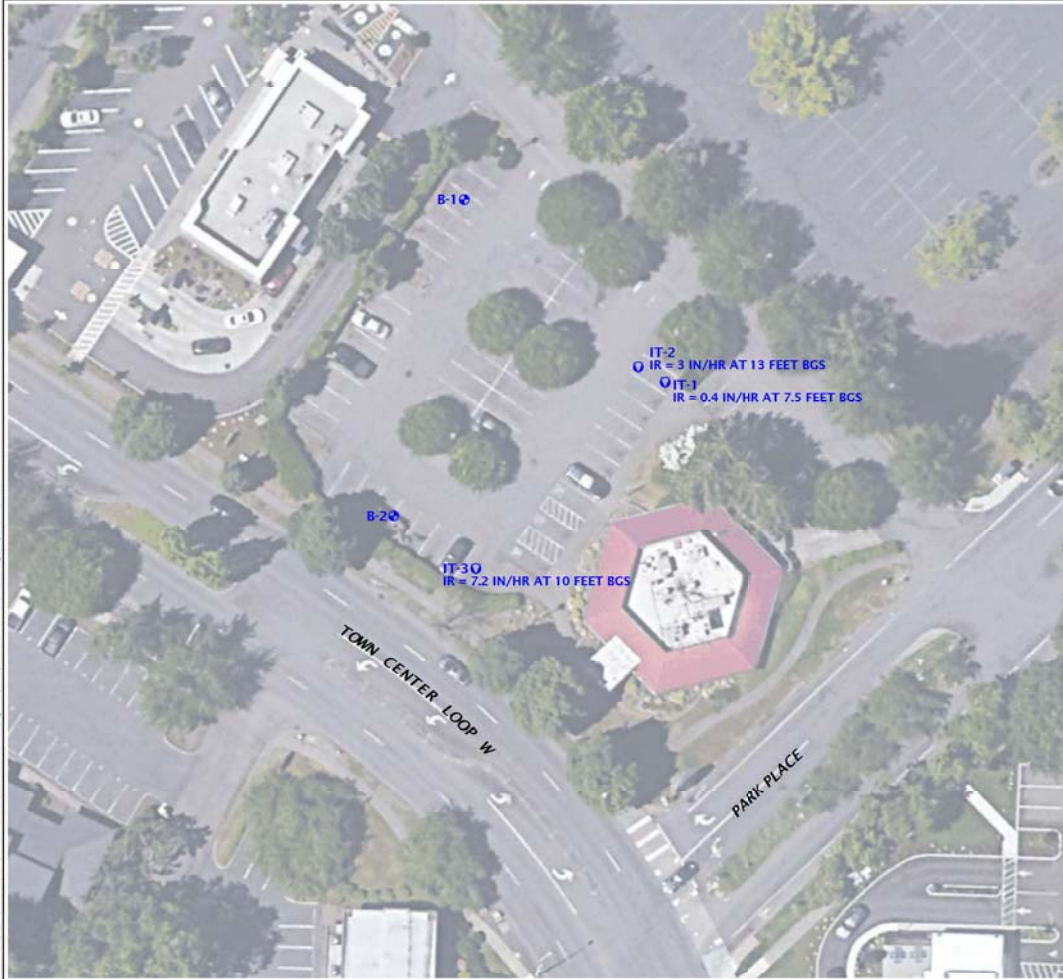

- LEGEND:**
- B-1 ◯ BORING (NV5, 2022)
 - IT-1 ◯ INFILTRATION TEST BORING
 - IR = 0.4 IN/HR AT 7.5 FEET BGS UNFACTORED INFILTRATION RATE

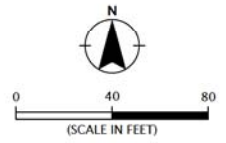

SITE PLAN BASED ON AERIAL PHOTOGRAPH DATED
MAY 10, 2021, OBTAINED FROM GOOGLE EARTH PRO.

NIV5	LEVEL/VN/1-03	SITE PLAN	FIGURE 2
	MARCH 2023	SHARI'S RESTAURANT SITE WILSONVILLE, OR	

ATTACHMENT A

ATTACHMENT A

FIELD EXPLORATIONS

GENERAL

We explored subsurface conditions at the site by drilling three borings (IT-1 through IT-3) to depths between 14 and 19.5 feet BGS. Drilling services were provided by Western States Soil Conservation, Inc. of Hubbard, Oregon, on February 16, 2023, using a truck-mounted drill rig with hollow-stem auger methods. The exploration logs are presented in this attachment.

The locations of the explorations are shown on Figure 2. The exploration locations were determined by pacing from existing site features and should be considered accurate to the degree implied by the methods used. A member of our geology staff observed the explorations.

SOIL SAMPLING

We collected representative samples of the various soils encountered during drilling for geotechnical laboratory testing. Samples were collected from the borings using a 1½-inch-inside-diameter, split-spoon SPT sampler in general accordance with ASTM D1586. The sampler was driven into the soil with a 140-pound hammer free falling 30 inches. The sampler was driven a total distance of 18 inches. The number of blows required to drive the sampler the final 12 inches is recorded on the exploration logs, unless otherwise noted. Sampling methods and intervals are shown on the exploration logs.

The average efficiency of the automatic SPT hammer used by Western States Soil Conservation, Inc. was 77.7 percent. The calibration testing results are presented at the end of this attachment.

SOIL CLASSIFICATION

The soil samples were classified in accordance with the “Exploration Key” (Table A-1) and “Soil Classification System” (Table A-2), which are presented in this attachment. The exploration logs indicate the depths at which the soils or their characteristics change, although the change actually could be gradual. If the change occurred between sample locations, the depth was interpreted. Classifications are shown on the exploration logs.

LABORATORY TESTING

CLASSIFICATION









The soil samples were classified in the laboratory to confirm field classifications. The laboratory classifications are shown on the exploration logs if those classifications differed from the field classifications.

MOISTURE CONTENT

We tested the natural moisture content of select soil samples in general accordance with ASTM D2216. The natural moisture content is a ratio of the weight of the water to soil in a test sample and is expressed as a percentage. The test results are presented in this attachment.

PARTICLE-SIZE ANALYSIS

Particle-size analysis was completed on select soil samples in general accordance with ASTM C117 or ASTM D1140 (percent fines determination). The test results are presented in this attachment.

SYMBOL	SAMPLING DESCRIPTION
	Location of sample collected in general accordance with ASTM D1586 using Standard Penetration Test (SPT) with recovery
	Location of sample collected using thin-wall Shelby tube or Geoprobe® sampler in general accordance with ASTM D1587 with recovery
	Location of sample collected using Dames & Moore sampler and 300-pound hammer or pushed with recovery
	Location of sample collected using Dames & Moore sampler and 140-pound hammer or pushed with recovery
	Location of sample collected using 3-inch-outside diameter California split-spoon sampler and 140-pound hammer with recovery
	Location of grab sample
	Rock coring interval
	Water level during drilling
	Water level taken on date shown

Graphic Log of Soil and Rock Types

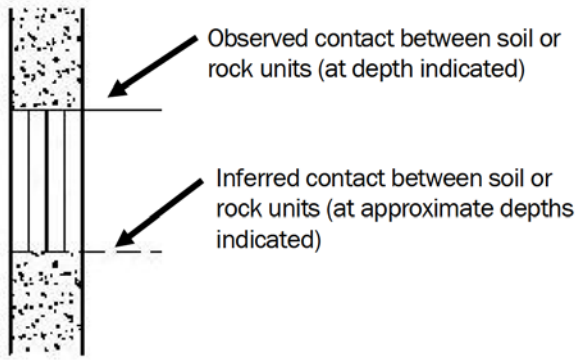

GEOTECHNICAL TESTING EXPLANATIONS

ATT	Atterberg Limits	P	Pushed Sample
CBR	California Bearing Ratio	PP	Pocket Penetrometer
CON	Consolidation	P200	Percent Passing U.S. Standard No. 200 Sieve
DD	Dry Density		
DS	Direct Shear	RES	Resilient Modulus
HYD	Hydrometer Gradation	SIEV	Sieve Gradation
MC	Moisture Content	TOR	Torvane
MD	Moisture-Density Relationship	UC	Unconfined Compressive Strength
NP	Non-Plastic	VS	Vane Shear
OC	Organic Content	kPa	Kilopascal

ENVIRONMENTAL TESTING EXPLANATIONS

CA	Sample Submitted for Chemical Analysis	ND	Not Detected
P	Pushed Sample	NS	No Visible Sheen
PID	Photoionization Detector Headspace Analysis	SS	Slight Sheen
ppm	Parts per Million	MS	Moderate Sheen
		HS	Heavy Sheen



EXPLORATION KEY

TABLE A-1

RELATIVE DENSITY - COARSE-GRAINED SOIL							
Relative Density	Standard Penetration Test (SPT) Resistance		Dames & Moore Sampler (140-pound hammer)		Dames & Moore Sampler (300-pound hammer)		
Very loose	0 - 4		0 - 11		0 - 4		
Loose	4 - 10		11 - 26		4 - 10		
Medium dense	10 - 30		26 - 74		10 - 30		
Dense	30 - 50		74 - 120		30 - 47		
Very dense	More than 50		More than 120		More than 47		
CONSISTENCY - FINE-GRAINED SOIL							
Consistency	Standard Penetration Test (SPT) Resistance	Dames & Moore Sampler (140-pound hammer)	Dames & Moore Sampler (300-pound hammer)	Unconfined Compressive Strength (tsf)			
Very soft	Less than 2	Less than 3	Less than 2	Less than 0.25			
Soft	2 - 4	3 - 6	2 - 5	0.25 - 0.50			
Medium stiff	4 - 8	6 - 12	5 - 9	0.50 - 1.0			
Stiff	8 - 15	12 - 25	9 - 19	1.0 - 2.0			
Very stiff	15 - 30	25 - 65	19 - 31	2.0 - 4.0			
Hard	More than 30	More than 65	More than 31	More than 4.0			
PRIMARY SOIL DIVISIONS				GROUP SYMBOL	GROUP NAME		
COARSE-GRAINED SOIL (more than 50% retained on No. 200 sieve)	GRAVEL (more than 50% of coarse fraction retained on No. 4 sieve)	CLEAN GRAVEL (< 5% fines)		GW or GP	GRAVEL		
		GRAVEL WITH FINES (≥ 5% and ≤ 12% fines)		GW-GM or GP-GM	GRAVEL with silt		
		GRAVEL WITH FINES (> 12% fines)		GW-GC or GP-GC	GRAVEL with clay		
				GM	silty GRAVEL		
				GC	clayey GRAVEL		
	SAND (50% or more of coarse fraction passing No. 4 sieve)	CLEAN SAND (<5% fines)		SW or SP	SAND		
		SAND WITH FINES (≥ 5% and ≤ 12% fines)		SW-SM or SP-SM	SAND with silt		
				SW-SC or SP-SC	SAND with clay		
		SAND WITH FINES (> 12% fines)		SM	silty SAND		
				SC	clayey SAND		
SC-SM	silty, clayey SAND						
FINE-GRAINED SOIL (50% or more passing No. 200 sieve)	SILT AND CLAY Liquid limit less than 50		ML	SILT			
			CL	CLAY			
			CL-ML	silty CLAY			
			OL	ORGANIC SILT or ORGANIC CLAY			
	SILT AND CLAY Liquid limit 50 or greater		MH	SILT			
			CH	CLAY			
			OH	ORGANIC SILT or ORGANIC CLAY			
			HIGHLY ORGANIC SOIL		PT	PEAT	
MOISTURE CLASSIFICATION		ADDITIONAL CONSTITUENTS					
Term	Field Test	Secondary granular components or other materials such as organics, man-made debris, etc.					
		Percent	Silt and Clay In:		Percent	Sand and Gravel In:	
dry	very low moisture, dry to touch		Fine-Grained Soil	Coarse-Grained Soil		Fine-Grained Soil	Coarse-Grained Soil
		< 5			trace		
moist	damp, without visible moisture	5 - 12	minor	with	5 - 15	minor	minor
		> 12	some	silty/clayey	15 - 30	with	with
wet	visible free water, usually saturated				> 30	sandy/gravelly	Indicate %
		SOIL CLASSIFICATION SYSTEM				TABLE A-2	

BORING LOG - NV5 - 1 PER PAGE LEVELDEVNW-1-03-BI_3.GPJ GDLNV5.GDT PRINT DATE: 3/14/23 KT:SN

DEPTH FEET	GRAPHIC LOG	MATERIAL DESCRIPTION	ELEVATION DEPTH	TESTING	SAMPLE	▲ BLOW COUNT ● MOISTURE CONTENT % ▨ RQD% ▩ CORE REC%	INSTALLATION AND COMMENTS
0.0		ASPHALT CONCRETE (3.0 inches). AGGREGATE BASE (8.0 inches).	0.3				
0.9		Stiff, brown SILT (ML), trace sand; moist, sand is fine.					
2.5		medium stiff at 5.0 feet					
7.5		Very dense, gray, silty GRAVEL with sand (GM); dry, gravel is subangular to angular, sand is fine to coarse.	7.6	P200			Infiltration test at 7.5 feet. P200 - 18%
10.0		medium dense; moist at 10.0 feet pink at 10.4 feet gray at 10.5 feet gray-brown at 10.6 feet					
12.5		dry at 12.5 feet					
14.0		Exploration completed at a depth of 14.0 feet. Hammer efficiency factor is 77.7 percent.	14.0				Surface elevation was not measured at the time of exploration.

DRILLED BY: Western States Soil Conservation, Inc.

LOGGED BY: I. Allen

COMPLETED: 02/16/23

BORING METHOD: hollow-stem auger (see document text)

BORING BIT DIAMETER: 6 inches



LEVELDEVNW-1-03

BORING IT-1

MARCH 2023

SHARI'S RESTAURANT SITE
WILSONVILLE, OR

FIGURE A-1

BORING LOG - NV5 - 1 PER PAGE LEVELDEVNW-1-03-BI_3.GPJ GDLNV5.GDT PRINT DATE: 3/14/23 KT:SN

DEPTH FEET	GRAPHIC LOG	MATERIAL DESCRIPTION	ELEVATION DEPTH	TESTING	SAMPLE	▲ BLOW COUNT ● MOISTURE CONTENT % ▨ RQD% ▩ CORE REC%	INSTALLATION AND COMMENTS
0.0		ASPHALT CONCRETE (3.0 inches). AGGREGATE BASE (8.0 inches).	0.3				
0.9		Very stiff, brown SILT (ML), trace to minor sand; moist, sand is fine.					
2.5							
5.0							
7.5		Medium dense, gray-brown, silty GRAVEL with sand (GM); dry to moist, gravel is subangular, sand is fine to coarse.	7.5				
10.0							
12.5							
13.0		moist at 13.0 feet					
14.4		red-brown at 14.4 feet					
14.7		gray-brown at 14.7 feet					
15.0							
17.5							
19.5		Exploration completed at a depth of 19.5 feet. Hammer efficiency factor is 77.7 percent.	19.5				
20.0							
22.5							
25.0							
27.5							
30.0							

P200

Infiltration test at 13.0 feet.
P200 = 22%

Surface elevation was not measured at the time of exploration.

DRILLED BY: Western States Soil Conservation, Inc.

LOGGED BY: I. Allen

COMPLETED: 02/16/23

BORING METHOD: hollow-stem auger (see document text)

BORING BIT DIAMETER: 6 inches



LEVELDEVNW-1-03

BORING IT-2

MARCH 2023

SHARI'S RESTAURANT SITE
WILSONVILLE, OR

FIGURE A-2

BORING LOG - NV5 - 1 PER PAGE LEVELDEVNW-1-03-B1_3.GPJ GDLNV5.GDT PRINT DATE: 3/14/23 KT:SN

DEPTH FEET	GRAPHIC LOG	MATERIAL DESCRIPTION	ELEVATION DEPTH	TESTING	SAMPLE	▲ BLOW COUNT ● MOISTURE CONTENT % ▨ RQD% ▩ CORE REC%	INSTALLATION AND COMMENTS
0.0		ASPHALT CONCRETE (3.0 inches). AGGREGATE BASE (8.0 inches).	0.3				
0.9		Stiff, brown SILT (ML), trace sand; moist, sand is fine.	0.9				
2.5						10	
5.0						28	
6.1		Medium dense, gray-brown, silty GRAVEL with sand (GM); dry to moist, gravel is subangular, sand is fine to coarse.	6.1				
7.5		dense, gray-pink at 7.5 feet gray-brown at 7.8 feet				40	
10.0		medium dense at 10.0 feet		P200		14	Infiltration test at 10.0 feet. P200 = 17%
12.5							
15.0						25	
16.5		Exploration completed at a depth of 16.5 feet. Hammer efficiency factor is 77.7 percent.	16.5				Surface elevation was not measured at the time of exploration.
17.5							
20.0							
22.5							
25.0							
27.5							
30.0							

DRILLED BY: Western States Soil Conservation, Inc.

LOGGED BY: I. Allen

COMPLETED: 02/16/23

BORING METHOD: hollow-stem auger (see document text)

BORING BIT DIAMETER: 6 inches



LEVELDEVNW-1-03

BORING IT-3

MARCH 2023

SHARI'S RESTAURANT SITE
WILSONVILLE, OR

FIGURE A-3

SAMPLE INFORMATION			MOISTURE CONTENT (PERCENT)	DRY DENSITY (PCF)	SIEVE			ATTERBERG LIMITS		
EXPLORATION NUMBER	SAMPLE DEPTH (FEET)	ELEVATION (FEET)			GRAVEL (PERCENT)	SAND (PERCENT)	P200 (PERCENT)	LIQUID LIMIT	PLASTIC LIMIT	PLASTICITY INDEX
IT-1	7.5		7			18				
IT-2	10.0		15							
IT-2	13.0		14			22				
IT-3	10.0		12			17				

	LEVELDEVNW-1-03	SUMMARY OF LABORATORY DATA		
	MARCH 2023	SHARI'S RESTAURANT SITE WILSONVILLE, OR		FIGURE A-4

Pile Dynamics, Inc.
SPT Analyzer Results

RIG #9
PDA-S Ver. 2021.34 - Printed: 12/27/2021

Summary of SPT Test Results

Project: WSSC-8-06, Test Date: 12/23/2021

FMX: Maximum Force
VMX: Maximum Velocity
BPM: Blows/Minute

EFV: Maximum Energy
ETR: Energy Transfer Ratio - Rated

Instr. Length ft	Blows Applied /6"	N Value	N60 Value	Average FMX kips	Average VMX ft/s	Average BPM bpm	Average EFV ft-lb	Average ETR %
60.00	11-17-20	37	47	42	14.3	52.9	282	80.6
60.00	5-8-16	24	31	42	14.2	52.8	258	73.7
60.00	13-16-0	16	20	35	12.5	46.4	245	70.1
60.00	5-10-15	25	32	42	14.2	48.0	288	82.3
60.00	3-7-10	17	22	39	13.1	44.8	271	77.5
Overall Average Values:				41	13.8	49.8	272	77.7
Standard Deviation:				2	0.8	3.3	16	4.5
Overall Maximum Value:				43	15.2	53.3	297	84.8
Overall Minimum Value:				34	11.8	43.5	238	67.9

ATTACHMENT B

ATTACHMENT B

EXPLORATION LOGS AND LABORATORY TESTING RESULTS FROM 2022 STUDY

BORING LOG - NV5 - 1 PER PAGE LEVELDEVNW-1-01-B1_2.GPJ GDLNV5.GDT PRINT DATE: 7/15/22.KT

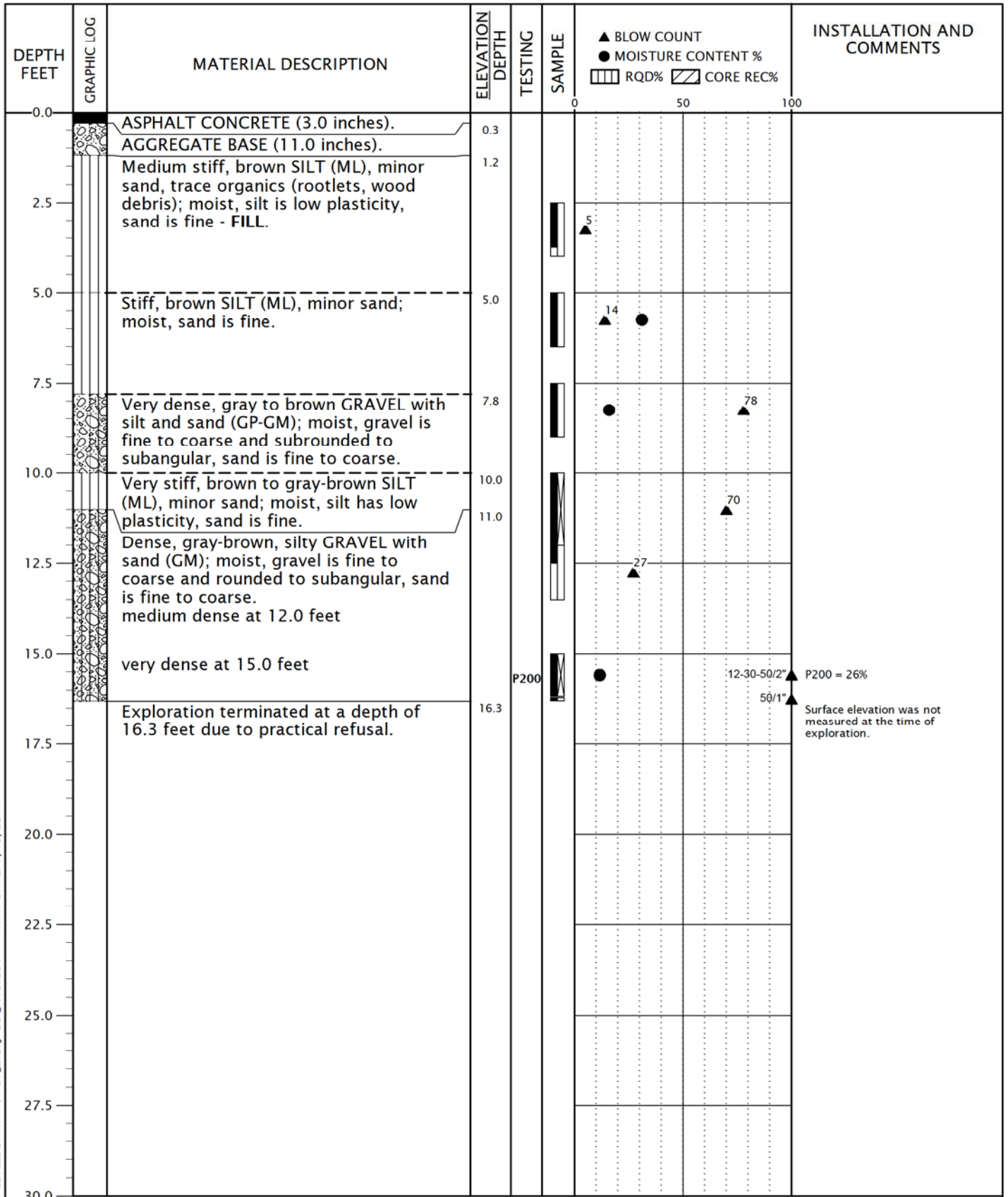

DRILLED BY: Dan J. Fischer Excavating, Inc.

LOGGED BY: S. Freeman

COMPLETED: 06/23/22

BORING METHOD: solid-stem auger (see document text)

BORING BIT DIAMETER: 4 inches



LEVELDEVNW-1-01

BORING B-1

JULY 2022

SHARI'S RESTAURANT SITE
WILSONVILLE, OR

FIGURE A-1

BORING LOG - NV5 - 1 PER PAGE LEVELDEVNW-1-01-B1_2.GPJ GDLNV5.GDT PRINT DATE: 7/15/22.KT

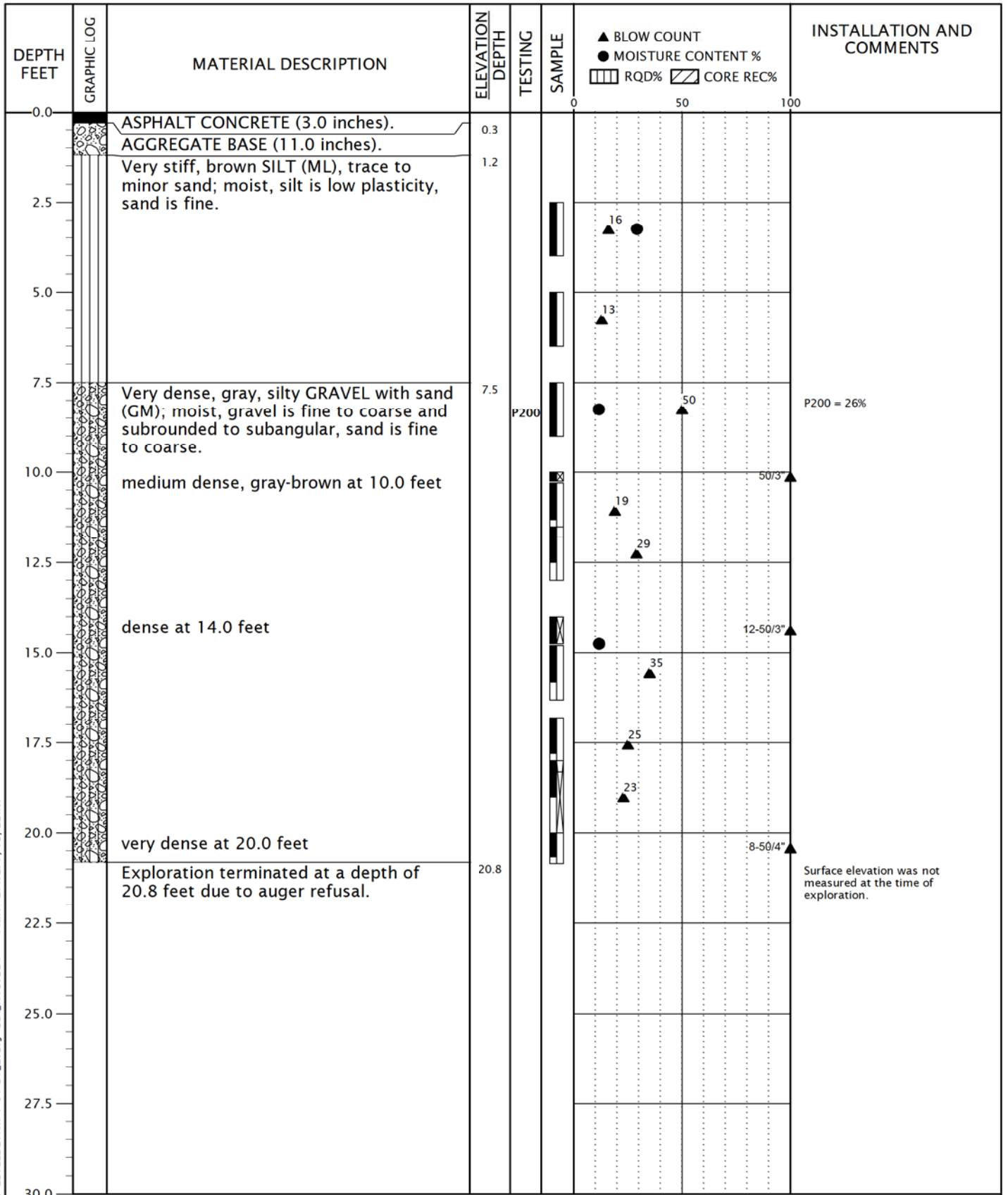

DRILLED BY: Dan J. Fischer Excavating, Inc.

LOGGED BY: S. Freeman

COMPLETED: 06/23/22

BORING METHOD: solid-stem auger (see document text)

BORING BIT DIAMETER: 4 inches



LEVELDEVNW-1-01

BORING B-2

JULY 2022

SHARI'S RESTAURANT SITE
WILSONVILLE, OR

FIGURE A-2

SAMPLE INFORMATION			MOISTURE CONTENT (PERCENT)	DRY DENSITY (PCF)	SIEVE			ATTERBERG LIMITS		
EXPLORATION NUMBER	SAMPLE DEPTH (FEET)	ELEVATION (FEET)			GRAVEL (PERCENT)	SAND (PERCENT)	P200 (PERCENT)	LIQUID LIMIT	PLASTIC LIMIT	PLASTICITY INDEX
B-1	5.0		31							
B-1	7.5		16							
B-1	15.0		12			26				
B-2	2.5		29							
B-2	7.5		12			26				
B-2	14.8		12							

LAB SUMMARY - GDI-NV5 LEVELDEVNW-1-01-B1_2.GPJ GDI_NV5.GDT PRINT DATE: 7/11/22:SN

	LEVELDEVNW-1-01	SUMMARY OF LABORATORY DATA		
	JULY 2022	SHARI'S RESTAURANT SITE WILSONVILLE, OR		FIGURE A-3

WILSONVILLE TOWN CENTER MULTIFAMILY DEVELOPMENT

TRANSPORTATION IMPACT ANALYSIS (TIA) FINAL

APRIL 2023

PREPARED FOR:

CITY OF WILSONVILLE



117 COMMERCIAL STREET NE, SUITE 310, SALEM, OR 97301 • 503.391.8773 • DKSASSOCIATES.COM

SHAPING A SMARTER TRANSPORTATION EXPERIENCE™

AN EMPLOYEE-OWNED COMPANY

PREPARED FOR CITY OF WILSONVILLE



Amy Pepper, PE

PREPARED BY DKS ASSOCIATES



Jenna Bogert, PE

Travis Larson, PE

Scott Mansur, PE, PTOE, RSP₁



TABLE OF CONTENTS

INTRODUCTION	1
EXISTING CONDITIONS	3
STUDY AREA ROADWAY NETWORK.....	3
EXISTING TRAFFIC VOLUMES.....	5
INTERSECTION PERFORMANCE MEASURES.....	5
EXISTING INTERSECTION OPERATIONS	7
PROJECT IMPACTS	8
PROPOSED DEVELOPMENT.....	8
FUTURE ANALYSIS SCENARIOS	8
TRIP GENERATION	8
VEHICLE TRIP DISTRIBUTION	9
FUTURE TRAFFIC VOLUMES	10
FUTURE INTERSECTION OPERATIONS.....	12
SITE PLAN REVIEW	13
SUMMARY	16
APPENDIX.....	17

INTRODUCTION

This study evaluates the transportation impacts associated with the proposed multifamily development that is to be located within the Wilsonville Town Center area on the north corner of the Park Place/Town Center Loop West intersection. The project will consist of 114 multifamily apartments and approximately 4,000 square feet of ground floor retail.

The Town Center area is subject to redevelopment in alignment with the Town Center Plan.¹ Therefore, while this multifamily development will be evaluated per existing conditions, applicable conformity to the Town Center Plan is considered.

The purpose of this transportation impact analysis (TIA) is to identify potential mitigation measures needed to offset transportation impacts that the proposed development may have on the nearby transportation network. The impact analysis is focused on the study intersections, which were selected for evaluation in coordination with City staff. The intersections are listed on the following page and shown in Figure 1. Important characteristics of the study area and proposed project are listed in Table 1.

1. Interstate-5 Southbound Ramps/Wilsonville Road
2. Interstate-5 Northbound Ramps/Wilsonville Road
3. Town Center Loop West/Wilsonville Road
4. Park Place/Town Center Loop West
5. Site Access/Town Center Loop West

TABLE 1: STUDY AREA & DEVELOPMENT CHARACTERISTICS

STUDY AREA	
NUMBER OF STUDY INTERSECTIONS	Five
ANALYSIS PERIODS	Weekday PM peak hour (one hour between 4pm – 6pm)
PROPOSED DEVELOPMENT	
LAND USE & SIZE	Mixed-use with 114 multifamily apartments and 4,000 square feet of ground floor retail.
PROJECT TRIPS	55 net PM peak hour trips (31 in, 24 out)
VEHICULAR ACCESS POINTS	One vehicular access point for off-street parking on Town Center Loop West

¹ Town Center Plan, City of Wilsonville, Amended October 2021.



FIGURE 1: STUDY AREA

EXISTING CONDITIONS

This chapter provides documentation of existing study area conditions, including the study area roadway network, pedestrian and bicycle facilities, and existing traffic volumes and operations.

STUDY AREA ROADWAY NETWORK

Key roadways and their existing characteristics in the study area are summarized in Table 2. The functional classifications for City of Wilsonville streets are provided in the City of Wilsonville Transportation System Plan (TSP).²

TABLE 2: STUDY AREA ROADWAY CHARACTERISTICS

ROADWAY	FUNCTIONAL CLASS	OWNER	LANES	POSTED SPEED	SIDE-WALKS	BICYCLE FACILITIES	ON-STREET PARKING
WILSONVILLE ROAD	Major Arterial	City of Wilsonville ^a	4 ^b	25 mph ^c	Yes	Yes	No
TOWN CENTER LOOP WEST	Major Arterial	City of Wilsonville	2	35 mph	Yes	Yes ^d	No
PARK PLACE	Local	City of Wilsonville	2	None Posted	Partial ^e	Yes	No
INTERSTATE 5	Urban Interstate	ODOT	6	65 mph	No	No	No

^a Wilsonville Road is under ODOT jurisdiction near the I-5 interchange.

^b Wilsonville Road is primarily 4 travel lanes, with some additional lanes present near the I-5 interchange.

^c Wilsonville Road has a posted speed of 35 mph east of Town Center Loop West.

^d Town Center Loop West has buffered bicycle lanes.

^e Park Place has sidewalks except for a small section on the NW side of the street.

BICYCLE AND PEDESTRIAN FACILITIES

Bicycle facilities in the Town Center area have been improved within the last five years with the addition of a buffered bicycle lane for the majority of the Town Center Loop. Wilsonville Road and a short section of Park Place also have bicycle lanes (non-buffered).

In general, sidewalks exist on all City streets including Town Center Loop and Wilsonville Road. Within the last few years, a new RRFB (Rectangular Rapid Flashing Beacon) with a median pedestrian island was added to the Town Center Loop crossing at the intersection with Park Place. This also included pedestrian crossing continental striping of the Park Place crossing.

² Chapter 3: The Standards, Wilsonville Transportation System Plan, City of Wilsonville, Amended November 2020.

PUBLIC TRANSIT SERVICE

South Metro Area Regional Transit (SMART) provides public transportation services within Wilsonville and outlying areas, including Canby, Salem, and south Portland. There are three SMART routes that service the study area. Route 2X (Tualatin Park & Ride) provides service between the Wilsonville Transit Center and Tualatin Park & Ride with approximately 30-minute headways. Route 4 (Wilsonville Road) provides service between the Wilsonville Transit Center and Meridian Creek Middle School with approximately 30-minute headways. Route V (Villebois Shopping Shuttle) provides service between the Villebois neighborhood and Town Center area with approximately 60-minute headways. Each route includes multiple transit stops within the Town Center area.

PLANNED PROJECTS

The City of Wilsonville Transportation System Plan (TSP) has a list of Higher Priority projects which includes the recommended projects reasonably expected to be funded through 2035. These are the highest priority solutions to meet the City's most important needs. The list includes the following projects that impact the key roadways near the proposed project site.

- [BW-8 \(Town Center Loop Pedestrian, Bicycle, and Transit Improvements\)](#) – Create more direct connections between destinations within Town Center area, improve accessibility to civic uses and transit stops, retrofit sidewalks with curb ramps, highlight crosswalks with colored pavement, and construct other similar treatments that support pedestrian, bicycle, and transit access and circulation.
- [BW-18 \(Park Place Promenade\)](#) – Convert the existing segment of Park Place between Courtyard Drive and Town Center Loop West from a motor vehicle route to pedestrian/bicycle facilities only. Construct a promenade that includes a cycle track and wide walkway for pedestrians.
- [RE-15 \(Park Place Extension\)](#) – Construct an extension of Park Place from Courtyard Drive to Wilsonville Road as a new main street with two travel lanes, parking, and sidewalks on both sides (see Figure 3-13). This extension will create a new signalized intersection at Wilsonville Road (SI-10).
- [RE-16 \(Courtyard Drive Extension\)](#) – Construct an extension of Courtyard Drive from Park Place to Town Center Loop West as a new main street with two travel lanes, buffered bike lanes, and sidewalks (see Figure 3-13).
- [SI-09 \(Wilsonville Road/Town Center Loop West Turn Lane Removal\)](#) – Modify the existing signal to eliminate eastbound and westbound left turns, add a landscaped median to the west leg, and add a crosswalk to the west side of the intersection with a median refuge island. This project should include a “trap lane” to mitigate queuing into the ramp terminal intersection unless at the time of construction a 20-year analysis demonstrates that it is not needed or if alternative mitigation is identified that that has similar or better results.
- [SI-10 \(Wilsonville Road/Park Place New Traffic Signal\)](#) – Modify the intersection to add left turn lanes on Wilsonville Road and install a traffic signal that allows all turning movements. To be installed in conjunction with SI-09 and RE-15. The project should include signal coordination with dump loop sensors unless at the time of construction a 20-year analysis demonstrates that the sensors and signal coordination in the corridor is not needed or if alternative mitigation is identified that that has similar or better results.

When these projects are constructed, there will be significant vehicle routing changes within the Town Center area due to the restriction of turning movements at certain intersections and new roadway connections. While these future routing impacts are not considered for this transportation impact analysis, it is important to note that current routing assumptions for this analysis are based on existing roadway conditions.

EXISTING TRAFFIC VOLUMES

New intersection turning movement count data was collected during two consecutive weekday PM peak periods (4:00pm – 6:00pm) at the study intersections. These two days of weekday PM peak hour volumes were averaged together to represent average, typical weekday conditions in Wilsonville. Figure 2 shows the Existing PM peak hour traffic volumes for the study intersections, along with the lane configurations and traffic control.

INTERSECTION PERFORMANCE MEASURES

Agency mobility standards often require intersections to meet level of service (LOS) or volume-to-capacity (v/c) intersection operation thresholds.

- The intersection LOS is similar to a “report card” rating based upon average vehicle delay. Level of service A, B, and C indicate conditions where traffic moves without significant delays over periods of peak hour travel demand. Level of service D and E are progressively worse operating conditions. Level of service F represents conditions where average vehicle delay has become excessive and demand has exceeded capacity. This condition is typically evident in long queues and delays.
- The volume-to-capacity (v/c) ratio represents the level of saturation of the intersection or individual movement. It is determined by dividing the peak hour traffic volume by the maximum hourly capacity of an intersection or turn movement. When the V/C ratio approaches 0.95, operations become unstable and small disruptions can cause the traffic flow to break down, resulting in the formation of excessive queues.

The City of Wilsonville requires study intersections on public streets to meet its minimum acceptable level of service (LOS) standard of LOS D for the PM peak period. An exception is placed on Wilsonville Road, between and including Boones Ferry Road and Town Center Loop West, which allows a minimum LOS standard of LOS E.³

The two intersections of the Interstate-5/Wilsonville Road interchange are required to meet ODOT mobility targets, which are identified in the METRO Regional Transportation Plan (2018) and the Oregon Highway Plan (1999). For the I-5 corridor between the Marquam Bridge to Wilsonville, the PM peak hour target for the first and second hour is a v/c ratio equal to or less than 0.99.⁴

³ Chapter 2: The Vision, Policy 5, Wilsonville Transportation System Plan, City of Wilsonville, Amended November 2020.

⁴ Table 2.4, Regional Transportation Plan, Metro, December 2018.

Table 7, Oregon Highway Plan, Oregon Department of Transportation, 1999.

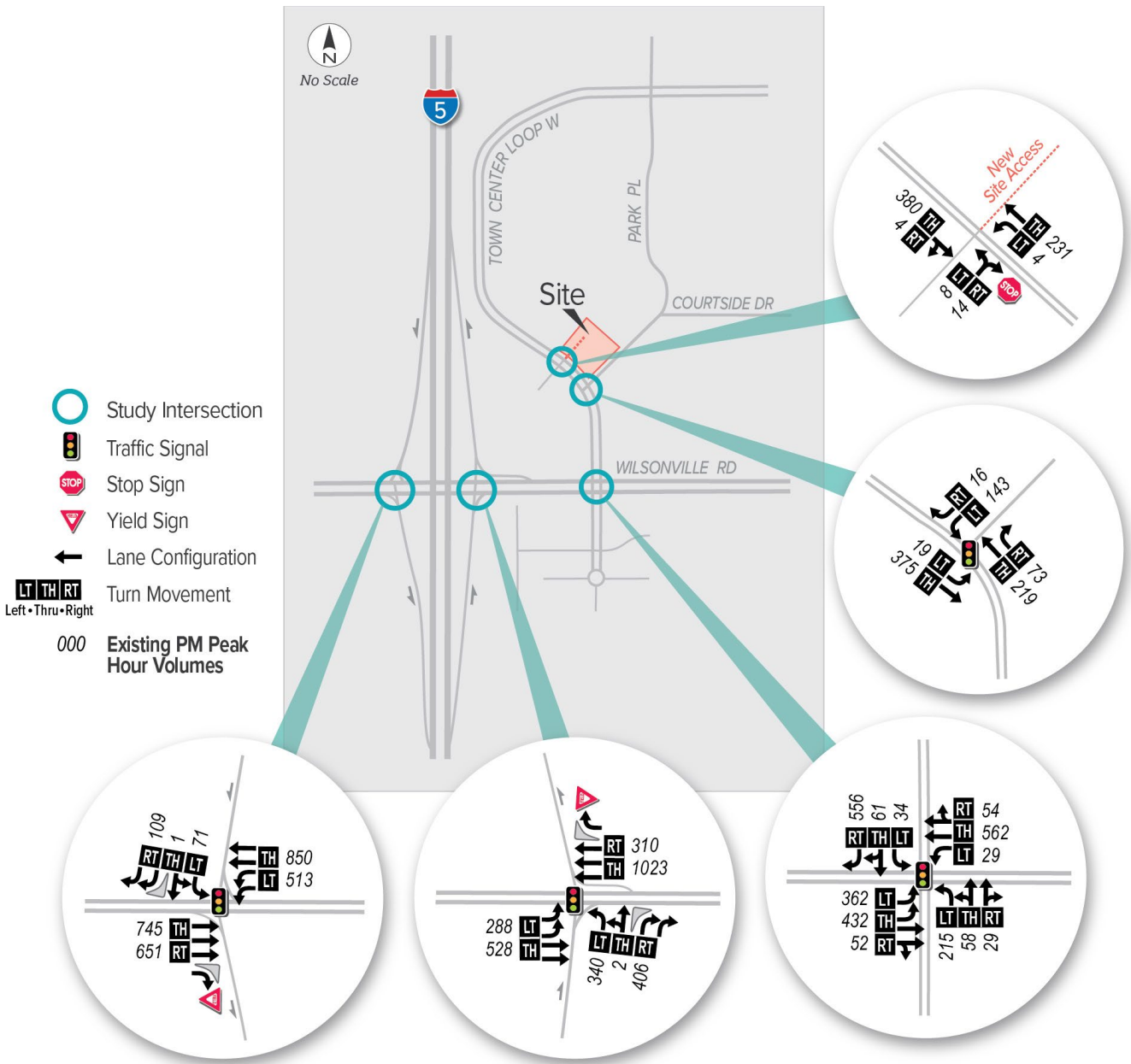

FIGURE 2: EXISTING PM PEAK HOUR TRAFFIC VOLUMES

EXISTING INTERSECTION OPERATIONS

Intersection operations were analyzed for the PM peak hour at all study intersections for the existing conditions using Highway Capacity Manual (HCM) 6th Edition methodology.⁵ The volume to capacity (v/c) ratio, delay, and level of service (LOS) of each study intersection are listed in Table 3.

As shown, all study intersections meet the applicable operating standards under all future analysis scenarios.

TABLE 3: EXISTING INTERSECTION OPERATIONS (PM PEAK)

INTERSECTION	OPERATING STANDARD	EXISTING		
		V/C	DELAY	LOS
SIGNALIZED				
I-5 SB RAMPS/WILSONVILLE RD	v/c ≤ 0.99 (ODOT)	0.36	12.3	B
I-5 NB RAMPS/WILSONVILLE RD	v/c ≤ 0.99 (ODOT)	0.45	15.0	B
TOWN CENTER LOOP WEST/WILSONVILLE RD	LOS E (City)	0.50	28.4	C
TWO-WAY STOP-CONTROLLED				
PARK PL/TOWN CENTER LOOP WEST	LOS D (City)	0.45	22.1	A/C
SIGNALIZED INTERSECTION:		TWO-WAY STOP-CONTROLLED INTERSECTION:		
Delay = Average Intersection Delay (secs)		Delay = Critical Movement Delay (secs)		
v/c = Total Volume-to-Capacity Ratio		v/c = Critical Movement Volume-to-Capacity Ratio		
LOS = Total Level of Service		LOS = Critical Levels of Service (Major/Minor Road)		

⁵ Highway Capacity Manual, 6th Edition, Transportation Research Board, 2017.

PROJECT IMPACTS

This chapter reviews the impacts that the proposed development may have on the transportation system within the study area. This analysis includes trip generation, trip distribution, future traffic volume development, and operations analysis for the study intersections.

PROPOSED DEVELOPMENT

The proposed development consists of a five-story mixed use building on the north corner of Park Place and Town Center Loop West. The building will include 114 multifamily apartments and 4,000 square feet of ground floor retail. The development will replace the existing Shari's Restaurant. On-site/off-street parking will be accessed via a new driveway located on Town Center Loop West. Based on the draft site plan, it appears to be placed directly opposite an existing driveway.

FUTURE ANALYSIS SCENARIOS

Operating conditions were analyzed at the study intersections for the following traffic scenarios. The comparison of the following scenarios enables the assessment of project impacts:

- Existing + Project
- Existing + Stage II
- Existing + Project + Stage II

All future analysis scenarios assume the same traffic control as existing conditions. Stage II represents traffic from other developments that have Stage II approval or are under construction in Wilsonville, which are based on the list of currently approved Stage II developments provided by City staff.⁶

TRIP GENERATION

Trip generation is the method used to estimate the number of vehicles added to site driveways and the adjacent roadway network by a development during a specified period (e.g., PM peak hour). The Institute of Transportation Engineers (ITE) publishes trip generation rates for the various land uses that can be applied to determine estimated traffic volumes.⁷

ITE Land Use categories Multifamily Housing (Mid-Rise) (221) and Strip Plaza (<40k) (822) was utilized for this analysis. Internal trip reductions were applied due to the mix of retail and residential land uses, for which a 23% reduction was calculated using methodology from NCHRP Report 684.⁸

⁶ Provided via email from Daniel Pauly, City of Wilsonville, March 6, 2023.

⁷ Trip Generation Manual, 11th Edition, Institute of Transportation Engineers, 2021.

⁸ NCHRP Report 684, Enhancing Internal Trip Capture Estimation for Mixed-Use Developments, Transportation Research Board, 2011.

As shown in Table 4, the proposed development is expected to generate a total of 55 net PM peak hour trips (31 in, 24 out) and 551 daily trips. It should be noted that the existing Shari’s restaurant that will be removed as part of this development was still in operation at the time of the transportation data collected for this study. As shown in the following section, no traffic impacts were identified in the transportation analysis and therefore, no trip reductions were applied as part of the analysis.

TABLE 4: VEHICLE TRIP GENERATION

LAND USE (ITE CODE)	SIZE	PM PEAK TRIPS			DAILY TRIPS
		IN	OUT	TOTAL	
MULTIFAMILY HOUSING (MID-RISE) (221)	114 Units	27	18	45	497
STRIP RETAIL PLAZA (<40K) (822)	4.0 KSF ^a	13	13	26	218
	Internal Reduction (23%):	-9	-7	-16	-164
	Total:	31	24	55	551

^a KSF = 1,000 square feet

VEHICLE TRIP DISTRIBUTION

Vehicle trip distribution provides an estimation of where vehicles would be coming from and going to. It is given as a percentage at key gateways to the study area and is used to route project trips through the study intersections. Figure 3 shows the trip distribution for the proposed site. The trip distribution was based on the Wilsonville Travel Demand Model.⁹ In general, the distribution showed approximately 35% of traffic coming from/going to the Wilsonville Road interchange, 35% coming from/going to Boeckman Road north of the Wilsonville Town Center, 15% coming from/going to Wilsonville Road west of I-5, and 15% coming from/going to Wilsonville Road east of Town Center Loop.

PROJECT TRIPS THROUGH CITY OF WILSONVILLE I-5 INTERCHANGE AREAS

The project trips through the two City of Wilsonville I-5 interchange areas were estimated based on the trip generation and distribution assumptions as discussed prior. Approximately 50% of the project trips (28 new PM peak hour trips) are expected to travel through the I-5/Wilsonville Road interchange area and approximately 5% (3 new PM peak hour trips) are expected to travel through the I-5/Elligsen Road interchange area.

⁹ 2035 Wilsonville Travel Demand Model, Select Zone Analysis, Zone 4050.

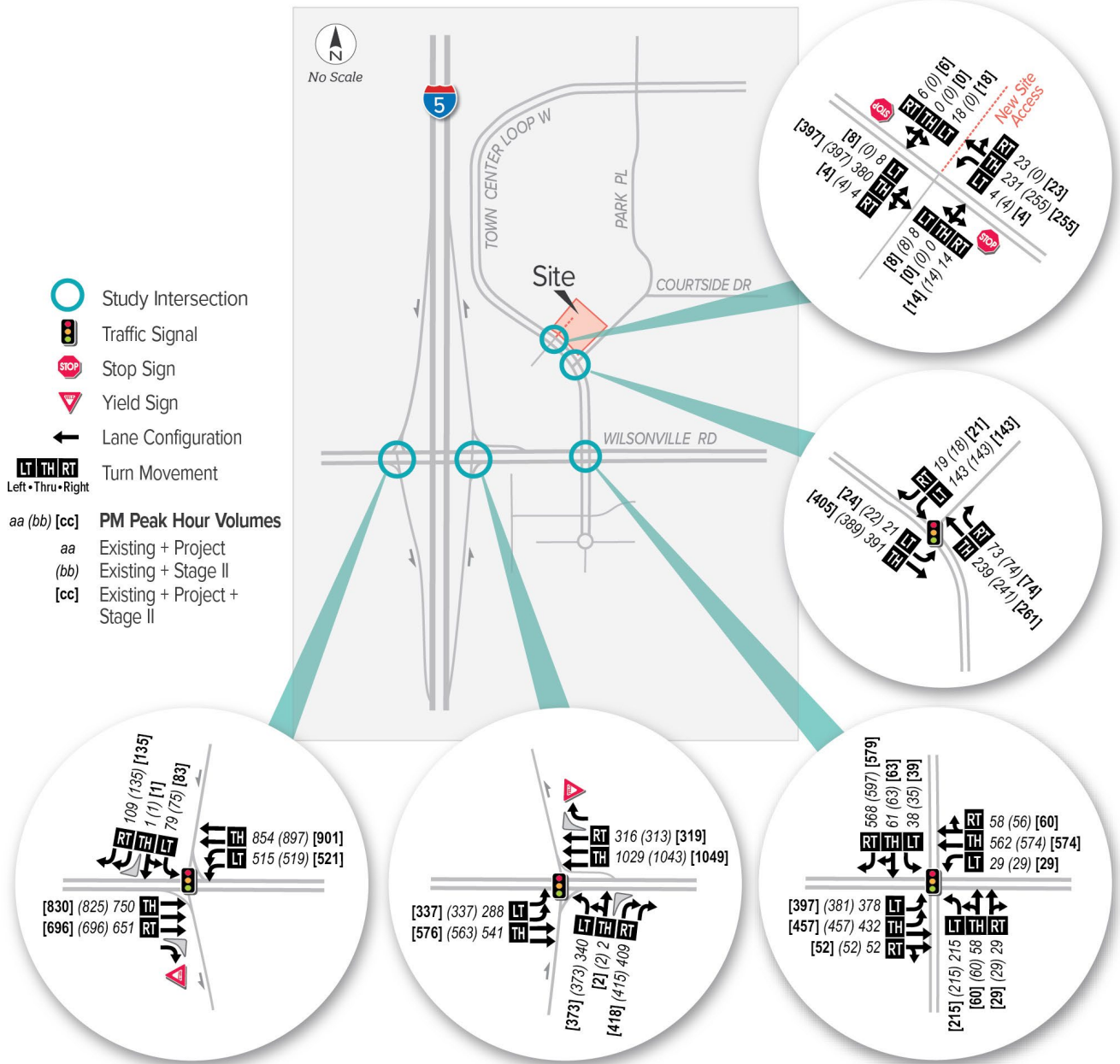

FIGURE 4: FUTURE PM PEAK HOUR TRAFFIC VOLUMES

FUTURE INTERSECTION OPERATIONS

Intersection operations were analyzed for the PM peak hour at all study intersections for the future scenarios using Highway Capacity Manual (HCM) 6th Edition methodology.¹⁰ The volume to capacity (v/c) ratio, delay, and level of service (LOS) of each study intersection are listed in Table 5.

As shown, all study intersections meet the applicable operating standards under all future analysis scenarios.

TABLE 5: FUTURE INTERSECTION OPERATIONS (PM PEAK)

INTERSECTION	OPERATING STANDARD	EXISTING + PROJECT			EXISTING + STAGE II			EXISTING + PROJECT + STAGE II		
		V/C	DELAY	LOS	V/C	DELAY	LOS	V/C	DELAY	LOS
SIGNALIZED										
I-5 SB RAMPS/ WILSONVILLE RD	v/c ≤ 0.99 (ODOT)	0.37	12.4	B	0.38	12.2	B	0.39	12.3	B
I-5 NB RAMPS/ WILSONVILLE RD	v/c ≤ 0.99 (ODOT)	0.45	15.0	B	0.48	15.9	B	0.48	15.9	B
TOWN CENTER LOOP WEST/ WILSONVILLE RD	LOS E (City)	0.50	28.8	C	0.51	28.7	C	0.52	29.2	C
TWO-WAY STOP-CONTROLLED										
PARK PL/ TOWN CENTER LOOP WEST	LOS D (City)	0.47	24.2	A/C	0.48	24.5	A/C	0.51	26.9	A/D
SITE ACCESS/ TOWN CENTER LOOP WEST	LOS D (City)	0.08	16.2	A/C	-	-	-	0.09	17.1	A/C
SIGNALIZED INTERSECTION: Delay = Average Intersection Delay (secs) v/c = Total Volume-to-Capacity Ratio LOS = Total Level of Service					TWO-WAY STOP-CONTROLLED INTERSECTION: Delay = Critical Movement Delay (secs) v/c = Critical Movement Volume-to-Capacity Ratio LOS = Critical Levels of Service (Major/Minor Road)					

¹⁰ Highway Capacity Manual, 6th Edition, Transportation Research Board, 2017.

SITE PLAN REVIEW

This chapter reviews the site plan on the basis of consistency with the Wilsonville Town Center Plan and abiding by the Transportation System Plan, including access spacing and sight distance, pedestrian and bicycle facilities, on-site circulation, and frontage improvements. The site plan is provided in the appendix.¹¹

TOWN CENTER PLAN CONSISTENCY

The proposed development is found to be consistent with future plans for the Town Center Area as laid out in the Town Center Plan.¹² The site plan provides no on-site access via Park Place, which is consistent with Park Place eventually being transitioned into a pedestrian-only promenade. The street connection on the north side of the plot is also maintained. With the development of the site, additional right-of-way will be dedicated on all sides of the property.

VEHICULAR SITE ACCESS

A vehicular site access for off-street parking is proposed along Town Center Loop West. Based on the site plan, it appears to be directly opposite an existing driveway serving the NW Wellness Center business park. It is desired from a traffic safety perspective for the two driveways to be aligned to reduce the number of potential conflict points.

The new driveway will be approximately 190 feet northwest of the Park Place intersection and approximately 240 feet southeast of the Mattress World/McDonalds driveway. The proposed access on Town Center Loop West is required to meet the City's Access Spacing Standards.¹³ The access spacing standard for a Major Arterial is to be a minimum 1,000 feet, but the desired spacing is 1,320 feet. The new driveway, therefore, does not meet access spacing standards.

Typically, access to a development should be placed on the lower classification street. However, in alignment with the Town Center Plan, Park Place will eventually be transitioned to a pedestrian zone and no vehicular access will be permitted on Park Place at that time. Therefore, Town Center Loop is the only current option for vehicular site access. Because the property frontage is only approximately 200 feet along Town Center Loop West, the site access will not be able to meet access spacing standards for a Minor Arterial. Therefore, a code variance for the site access spacing will need to be requested by the development to construct the site access on Town Center Loop West.

DRIVEWAY AISLE LENGTH

The City has minimum driveway aisle length standards.¹⁴ For driveways with more than 100 average daily traffic (ADT), the drive aisle must be clear of parking stalls and intersecting drive aisles within 100 feet from the back of sidewalk. The driveway shown on the site plan has a drive

¹¹ Level WTC Site Plan, 100% Schematic Design, Sheet G-100, Hacker Architects, 1/27/2023.

¹² Town Center Plan, City of Wilsonville, Amended October 2021.

¹³ Table 3-12, Transportation System Plan, City of Wilsonville, Amended November 2020.

¹⁴ Public Works Standards, Section 201.2.23 (Driveways), Revised December 2015.

aisle length of only 10 feet on the west side of the aisle before the first parking stall. In order to meet the City's public works standards, the driveway aisle would need to extend a minimum of 100 feet. This would be very difficult for the site to accommodate without losing the majority of parking on-site. Therefore, it is recommended that the drive aisle be extended to match the east side of the drive aisle (approximately 40 feet) to provide safe vehicle maneuvers in and out of the site and site parking stalls.

SIGHT DISTANCE

Adequate sight distance should be provided at all intersections and driveways. Objects (e.g., buildings, fences, walls, or vegetation) located near the intersections may inhibit sight distance for drivers attempting to turn out of a minor street onto the major street. With a speed limit of 35 miles per hour on Town Center Loop West, the sight distance requirement for the driveway is 390 feet to the northwest for vehicles turning left from the driveway roadway and 335 feet to the southeast for vehicles turning right from the driveway.¹⁵

Prior to occupancy, sight distance at any existing or proposed driveways will need to be verified, documented, and stamped by a registered professional Civil Engineer licensed in the State of Oregon to assure that buildings, signs, or landscaping does not restrict sight distance. The applicant should confirm through engineering drawings that the proposed access will meet the City's access spacing standards or variance request.

FRONTAGE IMPROVEMENTS

The developer shall coordinate with the City of Wilsonville regarding the required frontage improvements on Town Center Loop West and Park Place. Based on the standards prescribed in the Wilsonville TSP,¹⁶ Town Center Loop West is a major arterial which requires sidewalks, planter strips, and bike lanes along the project frontage. With Town Center Loop West also being a Freight Route, maintaining the existing separation between bicycles and vehicles is recommended.

As Park Place is planned to become a pedestrian promenade, the developer should coordinate any frontage improvements with the City to best fit future development plans.

MAJOR STREET TURN LANES

The Town Center Loop now consists of a buffered bicycle lane and single vehicle travel lane in each direction with a center raised median. At all existing driveways on the loop where there is not a conflict with a nearby public street intersection, a turn lane is present. While not shown on the site plan, it is recommended that a southbound left turn lane be installed in the Town Center Loop median with a raised barrier for access to the development driveway. This turn lane is recommended to improve safety for traffic accessing the proposed development; however, it will require modifications to the existing landscaped center median. This left turn lane does not meet left turn lane criteria and is therefore not required, but it is recommended. Without the left turn

¹⁵ Chapter 9, Tables 9-7 & 9-9, A Policy on Geometric Design of Highways and Streets, AASHTO, 7th Edition, 2018.

¹⁶ Chapter 3: The Standards, Wilsonville Transportation System Plan, City of Wilsonville, Amended November 2020.

lane, left turning vehicles will block through traffic on Town Center Loop West as cars wait to turn left into the site.

An additional landscaped median can be added back to Town Center Loop West when Park Place is converted to a pedestrian promenade since there will not be a need for a southbound left turn lane at Park Place at that time.

An aerial conceptual demonstration of the turn lane and possible future median addition is provided in the appendix.

ON-SITE CIRCULATION

The City desires for all modes of transportation to have practical parking and circulation that is safe and convenient.¹⁷ The site plan includes the single vehicular entrance to a parking lot, which generally includes a circular drive-aisle for parking.

PEDESTRIAN AND BICYCLE FACILITIES

The City provides standards for pedestrian facilities within developments to provide safe and convenient accessibility for all pedestrians.¹⁸ The site plan shows sidewalks encompassing the entire property/building, with wider sidewalks facing Park Place (the future pedestrian promenade). No specific bicycle facilities are shown, but both Town Center Loop West and Park Place already have bicycle lanes currently.

¹⁷ Section 4.421, Wilsonville Development Code, Updated March 2023.

¹⁸ Section 4.154, Wilsonville Development Code, Updated March 2023.

SUMMARY

The key findings of the transportation impact analysis for the Town Center Multifamily development are discussed below.

- The project will consist of a five-story mixed use building including 114 multifamily apartments and 4,000 square feet of ground floor retail. The development will replace the existing Shari's Restaurant that is located on the northeast corner of Park Place and Town Center Loop West.
- On-site/off-street parking will be accessed via a new driveway on Town Center Loop West that will be placed directly opposite an existing driveway.
- The proposed development is expected to generate 55 net PM peak hour trips (31 in, 24 out).
- Of those project trips, 28 new trips are expected to travel through the I-5/Wilsonville Road interchange area and 3 new trips are expected to travel through the I-5/Elligsen Road interchange area.
- The traffic operations at the five study intersections are expected to operate within the City's LOS standard and ODOT's mobility targets under all future volume conditions.
- The new driveway for the development does not meet access spacing standards. However, there is already an existing driveway directly adjacent to the proposed location and it is deemed the best location for the development.
- Prior to occupancy, sight distance at the proposed project access points will need to be verified, documented, and stamped by a registered professional Civil or Traffic Engineer licensed in the State of Oregon.
- It is recommended that a southbound left turn lane be installed in the Town Center Loop median for access to the development driveway for the safety of roadway users and consistency with the rest of the Town Center area. This would require the removal of the existing landscaped median.
- The developer shall coordinate with the City regarding any frontage improvements on Town Center Loop West and Park Place to maintain consistency with the Town Center Plan.

APPENDIX



1050 SW 6TH AVENUE, SUITE 600 • PORTLAND, OR 97204 • 503.243.3500 • DKSASSOCIATES.COM

CONTENTS

APPENDIX A: TRAFFIC COUNT DATA

APPENDIX B: STAGE II LIST

APPENDIX C: HCM REPORT - EXISTING

APPENDIX D: HCM REPORT – EXISTING + PROJECT

APPENDIX E: HCM REPORT – EXISTING + STAGE II

APPENDIX F: HCM REPORT – EXISTING + PROJECT + STAGE II

APPENDIX G: TURN LANE CONCEPTUAL DEMONSTRATION

APPENDIX H: SITE PLAN

APPENDIX A: TRAFFIC COUNT DATA



ALL TRAFFIC DATA SERVICES

(303) 216-2439

www.alltrafficdata.net

Location: 1 I-5 SB RAMPS & WILSONVILLE RD PM

Date: Tuesday, March 7, 2023

Peak Hour: 04:45 PM - 05:45 PM

Peak 15-Minutes: 05:25 PM - 05:40 PM

Peak Hour

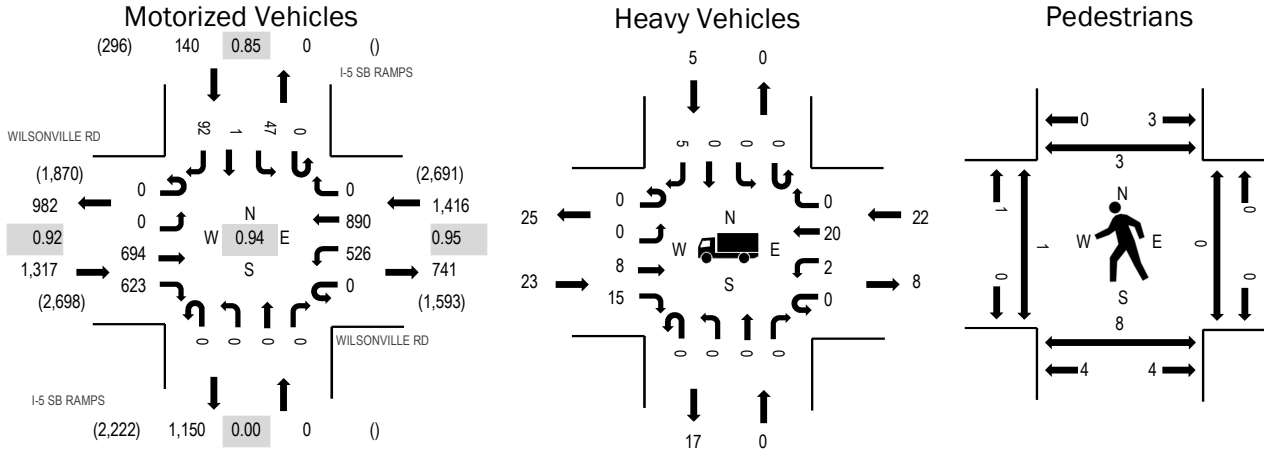

Note: Total study counts contained in parentheses.

	HV%	PHF
EB	1.7%	0.92
WB	1.6%	0.95
NB	0.0%	0.00
SB	3.6%	0.85
All	1.7%	0.94

Traffic Counts - Motorized Vehicles

Interval Start Time	WILSONVILLE RD Eastbound				WILSONVILLE RD Westbound				I-5 SB RAMPS Northbound				I-5 SB RAMPS Southbound				Total	Rolling Hour
	U-Turn	Left	Thru	Right	U-Turn	Left	Thru	Right	U-Turn	Left	Thru	Right	U-Turn	Left	Thru	Right		
4:00 PM	0	0	51	48	0	46	57	0	0	0	0	0	0	6	0	8	216	2,850
4:05 PM	0	0	76	44	0	27	72	0	0	0	0	0	0	7	0	8	234	2,871
4:10 PM	0	0	73	49	0	44	86	0	0	0	0	0	0	3	0	10	265	2,869
4:15 PM	0	0	55	52	0	48	69	0	0	0	0	0	0	3	0	5	232	2,825
4:20 PM	0	0	78	53	0	43	74	0	0	0	0	0	0	4	0	5	257	2,824
4:25 PM	0	0	57	48	0	43	75	0	0	0	0	0	0	5	0	9	237	2,807
4:30 PM	0	0	65	54	0	46	49	0	0	0	0	0	0	7	0	5	226	2,835
4:35 PM	0	0	51	59	0	40	77	0	0	0	0	0	0	8	0	4	239	2,863
4:40 PM	0	0	82	59	0	29	63	0	0	0	0	0	0	5	0	8	246	2,868
4:45 PM	0	0	58	51	0	50	71	0	0	0	0	0	0	3	0	7	240	2,873
4:50 PM	0	0	55	48	0	48	75	0	0	0	0	0	0	3	0	6	235	2,864
4:55 PM	0	0	44	52	0	45	71	0	0	0	0	0	0	1	0	10	223	2,837
5:00 PM	0	0	52	51	0	44	75	0	0	0	0	0	0	4	0	11	237	2,835
5:05 PM	0	0	48	51	0	43	77	0	0	0	0	0	0	7	0	6	232	
5:10 PM	0	0	44	53	0	45	71	0	0	0	0	0	0	3	1	4	221	
5:15 PM	0	0	56	58	0	38	69	0	0	0	0	0	0	4	0	6	231	
5:20 PM	0	0	65	48	0	41	74	0	0	0	0	0	0	1	0	11	240	
5:25 PM	0	0	72	54	0	46	80	0	0	0	0	0	0	3	0	10	265	
5:30 PM	0	0	51	59	0	49	83	0	0	0	0	0	0	5	0	7	254	
5:35 PM	0	0	85	44	0	38	62	0	0	0	0	0	0	7	0	8	244	
5:40 PM	0	0	64	54	0	39	82	0	0	0	0	0	0	6	0	6	251	
5:45 PM	0	0	68	49	0	42	66	0	0	0	0	0	0	2	0	4	231	
5:50 PM	0	0	47	43	0	39	57	0	0	0	0	0	0	12	0	10	208	
5:55 PM	0	0	76	44	0	23	60	0	0	0	0	0	0	11	0	7	221	
Count Total	0	0	1,473	1,225	0	996	1,695	0	0	0	0	0	0	120	1	175	5,685	
Peak Hour	0	0	694	623	0	526	890	0	0	0	0	0	0	47	1	92	2,873	

Traffic Counts - Heavy Vehicles, Bicycles on Road, and Pedestrians/Bicycles on Crosswalk

Interval Start Time	Heavy Vehicles					Interval Start Time	Bicycles on Roadway					Interval Start Time	Pedestrians/Bicycles on Crosswalk				
	EB	NB	WB	SB	Total		EB	NB	WB	SB	Total		EB	NB	WB	SB	Total
4:00 PM	6	0	0	1	7	4:00 PM	0	0	0	0	0	4:00 PM	0	0	0	1	1
4:05 PM	2	0	1	1	4	4:05 PM	0	0	0	0	0	4:05 PM	0	0	0	2	2
4:10 PM	4	0	4	3	11	4:10 PM	0	0	0	0	0	4:10 PM	0	0	0	0	0
4:15 PM	7	0	4	0	11	4:15 PM	0	0	0	0	0	4:15 PM	0	0	0	1	1
4:20 PM	2	0	2	0	4	4:20 PM	0	0	0	0	0	4:20 PM	0	1	0	1	2
4:25 PM	3	0	1	1	5	4:25 PM	0	0	0	0	0	4:25 PM	0	0	0	1	1
4:30 PM	0	0	1	0	1	4:30 PM	0	0	0	0	0	4:30 PM	0	1	0	0	1
4:35 PM	5	0	0	0	5	4:35 PM	0	0	0	0	0	4:35 PM	0	0	0	0	0
4:40 PM	2	0	4	2	8	4:40 PM	0	0	1	0	1	4:40 PM	0	1	0	0	1
4:45 PM	3	0	3	0	6	4:45 PM	0	0	1	0	1	4:45 PM	0	2	0	0	2
4:50 PM	2	0	0	1	3	4:50 PM	0	0	0	0	0	4:50 PM	0	0	0	0	0
4:55 PM	1	0	0	0	1	4:55 PM	0	0	0	0	0	4:55 PM	1	0	0	1	2
5:00 PM	3	0	3	0	6	5:00 PM	0	0	0	0	0	5:00 PM	0	1	0	0	1
5:05 PM	1	0	2	1	4	5:05 PM	0	0	0	0	0	5:05 PM	0	1	0	0	1
5:10 PM	3	0	1	0	4	5:10 PM	0	0	0	0	0	5:10 PM	0	2	0	0	2
5:15 PM	3	0	3	1	7	5:15 PM	0	0	0	0	0	5:15 PM	0	0	0	1	1
5:20 PM	1	0	5	1	7	5:20 PM	0	0	0	0	0	5:20 PM	0	1	0	1	2
5:25 PM	1	0	0	0	1	5:25 PM	0	0	0	0	0	5:25 PM	0	1	0	0	1
5:30 PM	1	0	2	0	3	5:30 PM	0	0	0	0	0	5:30 PM	0	1	0	0	1
5:35 PM	1	0	1	1	3	5:35 PM	0	0	0	0	0	5:35 PM	0	0	0	0	0
5:40 PM	3	0	2	0	5	5:40 PM	0	0	0	0	0	5:40 PM	0	0	0	0	0
5:45 PM	4	0	3	0	7	5:45 PM	0	0	0	0	0	5:45 PM	0	1	0	0	1
5:50 PM	1	0	2	0	3	5:50 PM	0	0	0	0	0	5:50 PM	0	1	0	2	3
5:55 PM	3	0	2	0	5	5:55 PM	0	0	0	0	0	5:55 PM	0	1	0	0	1
Count Total	62	0	46	13	121	Count Total	0	0	2	0	2	Count Total	1	15	0	11	27
Peak Hour	23	0	22	5	50	Peak Hour	0	0	1	0	1	Peak Hour	1	9	0	3	13

Traffic Counts - Heavy Vehicles, Bicycles on Road, and Pedestrians/Bicycles on Crosswalk

Interval Start Time	Heavy Vehicles					Interval Start Time	Bicycles on Roadway					Interval Start Time	Pedestrians/Bicycles on Crosswalk				
	EB	NB	WB	SB	Total		EB	NB	WB	SB	Total		EB	NB	WB	SB	Total
4:00 PM	4	1	1	0	6	4:00 PM	0	0	0	0	0	4:00 PM	0	0	0	0	0
4:05 PM	2	2	1	0	5	4:05 PM	1	0	0	0	1	4:05 PM	0	0	0	2	2
4:10 PM	3	2	2	0	7	4:10 PM	0	0	0	0	0	4:10 PM	0	0	0	1	1
4:15 PM	3	3	2	0	8	4:15 PM	0	0	0	0	0	4:15 PM	0	0	0	1	1
4:20 PM	1	1	2	0	4	4:20 PM	0	0	0	0	0	4:20 PM	0	0	0	1	1
4:25 PM	1	0	1	0	2	4:25 PM	0	0	0	0	0	4:25 PM	0	2	1	1	4
4:30 PM	0	1	0	0	1	4:30 PM	0	0	0	0	0	4:30 PM	0	0	0	0	0
4:35 PM	1	0	1	0	2	4:35 PM	0	0	0	0	0	4:35 PM	0	1	0	0	1
4:40 PM	0	2	2	0	4	4:40 PM	0	0	1	0	1	4:40 PM	0	0	0	0	0
4:45 PM	3	4	1	0	8	4:45 PM	0	0	1	0	1	4:45 PM	0	2	0	0	2
4:50 PM	0	1	1	0	2	4:50 PM	0	0	0	0	0	4:50 PM	0	0	0	0	0
4:55 PM	0	0	1	0	1	4:55 PM	0	1	0	0	1	4:55 PM	0	0	0	1	1
5:00 PM	1	1	2	0	4	5:00 PM	0	0	0	0	0	5:00 PM	0	2	0	0	2
5:05 PM	0	2	1	0	3	5:05 PM	0	0	0	0	0	5:05 PM	0	2	0	0	2
5:10 PM	2	1	1	0	4	5:10 PM	0	0	0	0	0	5:10 PM	0	0	0	0	0
5:15 PM	1	1	1	0	3	5:15 PM	0	0	0	0	0	5:15 PM	0	1	0	0	1
5:20 PM	0	5	2	0	7	5:20 PM	0	0	0	0	0	5:20 PM	0	2	0	2	4
5:25 PM	0	0	1	0	1	5:25 PM	0	0	0	0	0	5:25 PM	0	0	0	0	0
5:30 PM	0	0	3	0	3	5:30 PM	0	0	0	0	0	5:30 PM	0	1	0	0	1
5:35 PM	1	1	1	0	3	5:35 PM	0	0	0	0	0	5:35 PM	0	0	0	0	0
5:40 PM	1	0	1	0	2	5:40 PM	0	0	0	0	0	5:40 PM	0	0	0	0	0
5:45 PM	2	2	2	0	6	5:45 PM	0	0	0	0	0	5:45 PM	0	1	0	0	1
5:50 PM	0	1	2	0	3	5:50 PM	0	0	0	0	0	5:50 PM	0	1	0	2	3
5:55 PM	2	1	0	0	3	5:55 PM	0	0	0	0	0	5:55 PM	0	1	0	0	1
Count Total	28	32	32	0	92	Count Total	1	1	2	0	4	Count Total	0	16	1	11	28
Peak Hour	18	17	15	0	50	Peak Hour	1	1	2	0	4	Peak Hour	0	5	1	7	13



ALL TRAFFIC DATA SERVICES

(303) 216-2439

www.alltrafficdata.net

Location: 3 TOWN CENTER LOOP WEST & WILSONVILLE RD PM

Date: Tuesday, March 7, 2023

Peak Hour: 04:00 PM - 05:00 PM

Peak 15-Minutes: 04:00 PM - 04:15 PM

Peak Hour

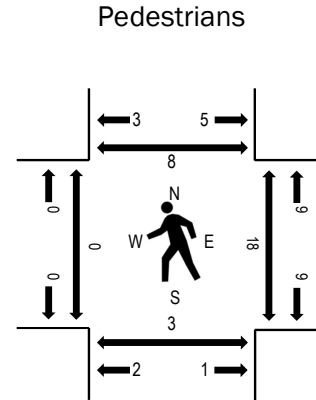
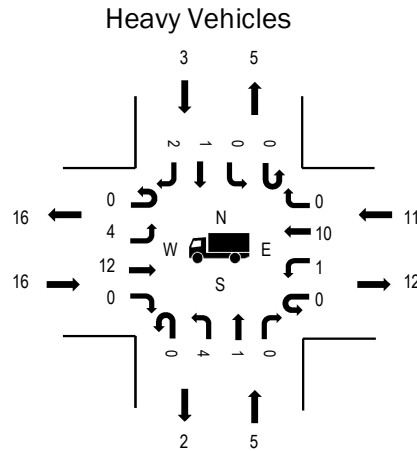
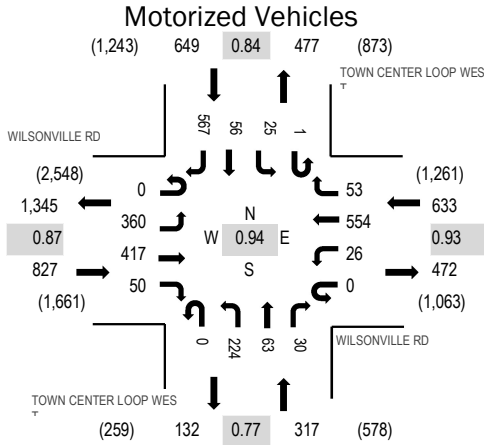

Note: Total study counts contained in parentheses.

	HV%	PHF
EB	1.9%	0.87
WB	1.7%	0.93
NB	1.6%	0.77
SB	0.5%	0.84
All	1.4%	0.94

Traffic Counts - Motorized Vehicles

Interval Start Time	WILSONVILLE RD Eastbound				WILSONVILLE RD Westbound				TOWN CENTER LOOP WEST Northbound				TOWN CENTER LOOP WEST Southbound				Total	Rolling Hour
	U-Turn	Left	Thru	Right	U-Turn	Left	Thru	Right	U-Turn	Left	Thru	Right	U-Turn	Left	Thru	Right		
4:00 PM	0	19	44	4	0	2	49	10	0	20	7	3	0	1	4	42	205	2,426
4:05 PM	0	43	38	1	0	5	43	5	0	10	2	2	0	4	7	65	225	2,424
4:10 PM	0	22	26	6	0	2	52	5	0	25	9	2	0	2	8	57	216	2,392
4:15 PM	0	17	33	6	0	1	66	5	0	18	1	2	0	1	5	45	200	2,356
4:20 PM	0	46	42	7	0	4	56	2	0	18	1	0	0	6	2	41	225	2,354
4:25 PM	0	31	29	2	0	2	42	5	0	17	8	3	0	3	5	44	191	2,314
4:30 PM	0	18	28	4	0	2	32	4	0	24	5	2	0	3	1	45	168	2,330
4:35 PM	0	45	43	4	0	1	48	6	0	37	7	2	0	1	4	35	233	2,360
4:40 PM	0	20	47	7	0	2	44	1	0	12	3	2	0	1	6	37	182	2,327
4:45 PM	0	38	29	4	0	1	34	4	0	17	11	1	0	0	3	49	191	2,328
4:50 PM	0	19	28	4	0	1	45	4	0	16	9	7	1	2	7	53	196	2,338
4:55 PM	0	42	30	1	0	3	43	2	0	10	0	4	0	1	4	54	194	2,337
5:00 PM	0	21	36	2	0	6	55	6	0	15	6	5	0	6	8	37	203	2,317
5:05 PM	0	15	39	6	0	2	39	6	0	16	5	2	0	1	6	56	193	
5:10 PM	0	13	34	1	0	3	55	2	0	14	7	2	0	3	5	41	180	
5:15 PM	0	24	37	5	0	3	53	5	0	16	5	1	0	3	2	44	198	
5:20 PM	0	26	48	3	0	5	43	1	0	16	4	5	0	1	4	29	185	
5:25 PM	1	22	25	4	0	3	52	5	0	16	6	1	0	4	9	59	207	
5:30 PM	0	26	47	2	0	3	44	6	0	12	5	4	0	2	1	46	198	
5:35 PM	0	27	57	4	0	1	47	4	0	8	2	2	0	5	7	36	200	
5:40 PM	0	27	38	4	0	0	36	7	0	18	5	2	0	4	2	40	183	
5:45 PM	0	19	47	3	0	4	44	6	0	21	7	3	0	11	2	34	201	
5:50 PM	0	47	54	2	0	1	26	4	0	9	6	4	0	3	6	33	195	
5:55 PM	0	16	51	1	0	3	47	1	0	8	2	1	0	3	4	37	174	
Count Total	1	643	930	87	0	60	1,095	106	0	393	123	62	1	71	112	1,059	4,743	
Peak Hour	0	360	417	50	0	26	554	53	0	224	63	30	1	25	56	567	2,426	

Traffic Counts - Heavy Vehicles, Bicycles on Road, and Pedestrians/Bicycles on Crosswalk

Interval Start Time	Heavy Vehicles					Interval Start Time	Bicycles on Roadway					Interval Start Time	Pedestrians/Bicycles on Crosswalk				
	EB	NB	WB	SB	Total		EB	NB	WB	SB	Total		EB	NB	WB	SB	Total
4:00 PM	2	2	1	0	5	4:00 PM	0	0	0	0	0	4:00 PM	0	0	3	1	4
4:05 PM	2	0	1	0	3	4:05 PM	0	0	0	0	0	4:05 PM	0	0	0	1	1
4:10 PM	2	1	0	1	4	4:10 PM	0	0	0	0	0	4:10 PM	0	0	0	2	2
4:15 PM	1	1	1	0	3	4:15 PM	0	0	0	0	0	4:15 PM	0	0	2	0	2
4:20 PM	1	0	2	0	3	4:20 PM	0	0	0	0	0	4:20 PM	0	0	1	1	2
4:25 PM	1	0	1	0	2	4:25 PM	0	0	0	0	0	4:25 PM	0	1	2	1	4
4:30 PM	0	0	0	0	0	4:30 PM	0	0	0	0	0	4:30 PM	0	0	2	0	2
4:35 PM	1	0	1	0	2	4:35 PM	0	0	0	0	0	4:35 PM	0	1	0	0	1
4:40 PM	3	0	1	1	5	4:40 PM	0	0	0	1	1	4:40 PM	0	1	2	1	4
4:45 PM	0	1	0	1	2	4:45 PM	0	0	0	0	0	4:45 PM	0	0	1	0	1
4:50 PM	2	0	1	0	3	4:50 PM	0	0	0	0	0	4:50 PM	0	0	1	0	1
4:55 PM	1	0	2	0	3	4:55 PM	0	0	0	0	0	4:55 PM	0	1	5	2	8
5:00 PM	1	0	2	0	3	5:00 PM	0	0	0	0	0	5:00 PM	0	0	1	2	3
5:05 PM	2	0	0	0	2	5:05 PM	0	0	0	0	0	5:05 PM	0	0	0	0	0
5:10 PM	1	0	1	1	3	5:10 PM	0	0	0	0	0	5:10 PM	0	0	1	0	1
5:15 PM	0	0	0	1	1	5:15 PM	0	0	0	0	0	5:15 PM	0	0	0	0	0
5:20 PM	1	1	1	0	3	5:20 PM	0	0	0	0	0	5:20 PM	0	0	1	2	3
5:25 PM	0	0	1	0	1	5:25 PM	0	0	0	0	0	5:25 PM	0	1	1	0	2
5:30 PM	0	0	2	1	3	5:30 PM	0	0	0	0	0	5:30 PM	0	1	0	1	2
5:35 PM	0	0	1	0	1	5:35 PM	0	0	0	0	0	5:35 PM	0	0	0	1	1
5:40 PM	1	0	1	1	3	5:40 PM	0	0	0	0	0	5:40 PM	0	0	0	0	0
5:45 PM	1	0	1	1	3	5:45 PM	0	0	0	0	0	5:45 PM	0	0	0	0	0
5:50 PM	1	0	2	0	3	5:50 PM	0	0	0	0	0	5:50 PM	0	1	0	0	1
5:55 PM	1	0	0	1	2	5:55 PM	0	0	0	0	0	5:55 PM	0	0	0	0	0
Count Total	25	6	23	9	63	Count Total	0	0	0	1	1	Count Total	0	7	23	15	45
Peak Hour	16	5	11	3	35	Peak Hour	0	0	0	1	1	Peak Hour	0	4	19	9	32



ALL TRAFFIC DATA SERVICES

(303) 216-2439

www.alltrafficdata.net

Location: 4 TOWN CENTER LOOP WEST & PARK PL PM

Date: Tuesday, March 7, 2023

Peak Hour: 04:00 PM - 05:00 PM

Peak 15-Minutes: 04:45 PM - 05:00 PM

Peak Hour

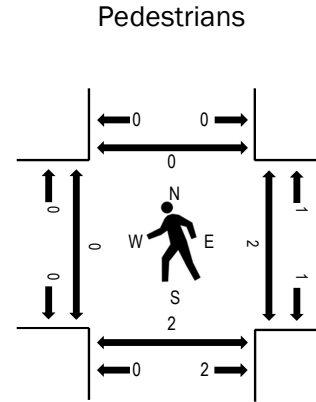
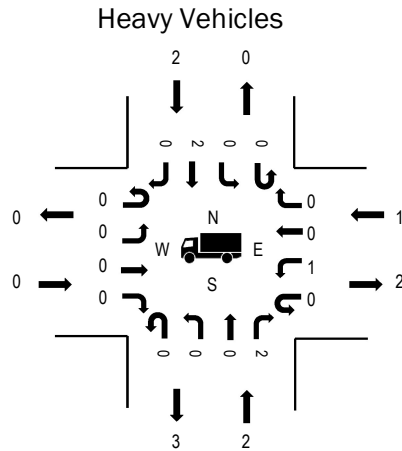
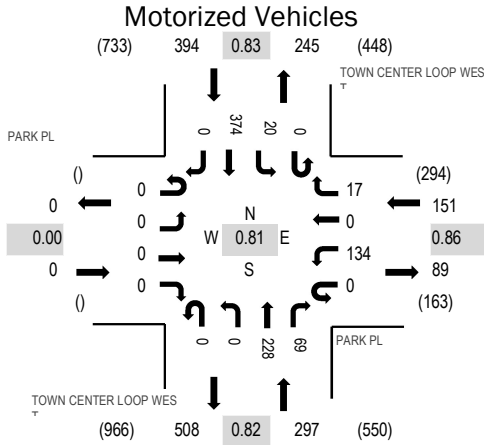

Note: Total study counts contained in parentheses.

	HV%	PHF
EB	0.0%	0.00
WB	0.7%	0.86
NB	0.7%	0.82
SB	0.5%	0.83
All	0.6%	0.81

Traffic Counts - Motorized Vehicles

Interval Start Time	PARK PL Eastbound				PARK PL Westbound				TOWN CENTER LOOP WEST Northbound				TOWN CENTER LOOP WEST Southbound				Total	Rolling Hour
	U-Turn	Left	Thru	Right	U-Turn	Left	Thru	Right	U-Turn	Left	Thru	Right	U-Turn	Left	Thru	Right		
4:00 PM	0	0	0	0	0	10	0	1	0	0	18	4	0	0	42	0	75	842
4:05 PM	0	0	0	0	0	11	0	2	0	0	13	6	0	1	43	0	76	827
4:10 PM	0	0	0	0	0	13	0	1	0	0	20	8	0	1	34	0	77	824
4:15 PM	0	0	0	0	0	13	0	2	0	0	15	4	0	2	24	0	60	822
4:20 PM	0	0	0	0	0	13	0	0	0	0	20	8	0	0	21	0	62	827
4:25 PM	0	0	0	0	0	4	0	1	0	0	17	4	0	1	31	0	58	827
4:30 PM	0	0	0	0	0	9	0	0	0	0	20	8	0	2	23	0	62	842
4:35 PM	0	0	0	0	0	12	0	1	0	0	17	6	0	1	17	0	54	839
4:40 PM	0	0	0	0	0	10	0	1	0	0	13	4	0	4	27	0	59	832
4:45 PM	0	0	0	0	0	11	0	6	0	0	30	4	0	2	43	0	96	828
4:50 PM	0	0	0	0	0	12	0	1	0	0	24	7	0	3	29	0	76	787
4:55 PM	0	0	0	0	0	16	0	1	0	0	21	6	0	3	40	0	87	777
5:00 PM	0	0	0	0	0	6	0	1	0	0	19	5	0	1	28	0	60	735
5:05 PM	0	0	0	0	0	10	0	2	0	0	18	3	0	1	39	0	73	
5:10 PM	0	0	0	0	0	20	0	1	0	0	14	4	0	1	35	0	75	
5:15 PM	0	0	0	0	0	11	0	1	0	0	12	3	0	0	38	0	65	
5:20 PM	0	0	0	0	0	12	0	1	0	0	16	7	0	1	25	0	62	
5:25 PM	0	0	0	0	0	10	0	3	0	0	17	7	0	3	33	0	73	
5:30 PM	0	0	0	0	0	12	0	1	0	0	17	5	0	0	24	0	59	
5:35 PM	0	0	0	0	0	8	0	0	0	0	18	2	0	1	18	0	47	
5:40 PM	0	0	0	0	0	13	0	0	0	0	14	5	0	1	22	0	55	
5:45 PM	0	0	0	0	0	8	0	0	0	0	15	9	0	0	23	0	55	
5:50 PM	0	0	0	0	0	12	0	2	0	0	19	13	0	2	18	0	66	
5:55 PM	0	0	0	0	0	8	0	1	0	0	11	0	0	0	25	0	45	
Count Total	0	0	0	0	0	264	0	30	0	0	418	132	0	31	702	0	1,577	
Peak Hour	0	0	0	0	0	134	0	17	0	0	228	69	0	20	374	0	842	

Traffic Counts - Heavy Vehicles, Bicycles on Road, and Pedestrians/Bicycles on Crosswalk

Interval Start Time	Heavy Vehicles					Interval Start Time	Bicycles on Roadway					Interval Start Time	Pedestrians/Bicycles on Crosswalk				
	EB	NB	WB	SB	Total		EB	NB	WB	SB	Total		EB	NB	WB	SB	Total
4:00 PM	0	0	0	0	0	4:00 PM	0	0	0	0	0	4:00 PM	0	0	0	0	0
4:05 PM	0	0	0	0	0	4:05 PM	0	0	0	0	0	4:05 PM	0	0	1	0	1
4:10 PM	0	0	1	0	1	4:10 PM	0	0	0	0	0	4:10 PM	0	0	0	0	0
4:15 PM	0	0	0	0	0	4:15 PM	0	0	0	0	0	4:15 PM	0	0	0	0	0
4:20 PM	0	1	0	0	1	4:20 PM	0	0	0	0	0	4:20 PM	0	1	0	0	1
4:25 PM	0	0	0	0	0	4:25 PM	0	0	0	0	0	4:25 PM	0	0	0	0	0
4:30 PM	0	0	0	0	0	4:30 PM	0	0	0	0	0	4:30 PM	0	1	0	0	1
4:35 PM	0	0	0	1	1	4:35 PM	0	0	0	0	0	4:35 PM	0	0	1	0	1
4:40 PM	0	0	0	1	1	4:40 PM	0	0	0	1	1	4:40 PM	0	0	0	0	0
4:45 PM	0	0	0	0	0	4:45 PM	0	0	0	0	0	4:45 PM	0	0	0	0	0
4:50 PM	0	1	0	0	1	4:50 PM	0	0	0	0	0	4:50 PM	0	0	0	0	0
4:55 PM	0	0	0	0	0	4:55 PM	0	0	0	0	0	4:55 PM	0	0	1	0	1
5:00 PM	0	1	0	0	1	5:00 PM	0	0	0	0	0	5:00 PM	0	1	0	0	1
5:05 PM	0	0	0	2	2	5:05 PM	0	0	0	0	0	5:05 PM	0	2	0	0	2
5:10 PM	0	0	1	1	2	5:10 PM	0	0	0	0	0	5:10 PM	0	1	0	0	1
5:15 PM	0	0	0	0	0	5:15 PM	0	0	0	0	0	5:15 PM	0	0	0	0	0
5:20 PM	0	1	0	0	1	5:20 PM	0	0	0	0	0	5:20 PM	0	2	0	0	2
5:25 PM	0	0	0	0	0	5:25 PM	0	0	0	0	0	5:25 PM	0	0	1	0	1
5:30 PM	0	0	0	0	0	5:30 PM	0	0	0	0	0	5:30 PM	0	1	1	0	2
5:35 PM	0	0	0	0	0	5:35 PM	0	0	0	0	0	5:35 PM	0	1	0	0	1
5:40 PM	0	0	1	0	1	5:40 PM	0	0	0	0	0	5:40 PM	0	0	1	0	1
5:45 PM	0	1	0	0	1	5:45 PM	0	0	0	0	0	5:45 PM	0	1	0	0	1
5:50 PM	0	0	1	0	1	5:50 PM	0	0	0	0	0	5:50 PM	0	0	0	0	0
5:55 PM	0	0	1	0	1	5:55 PM	0	0	0	0	0	5:55 PM	0	2	0	0	2
Count Total	0	5	5	5	15	Count Total	0	0	0	1	1	Count Total	0	13	6	0	19
Peak Hour	0	2	1	2	5	Peak Hour	0	0	0	1	1	Peak Hour	0	2	3	0	5



ALL TRAFFIC DATA SERVICES

(303) 216-2439

www.alltrafficdata.net

Location: 5 TOWN CENTER LOOP WEST & SITE ACCESS PM

Date: Tuesday, March 7, 2023

Peak Hour: 04:25 PM - 05:25 PM

Peak 15-Minutes: 04:45 PM - 05:00 PM

Peak Hour

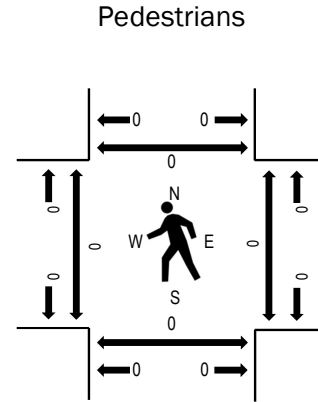
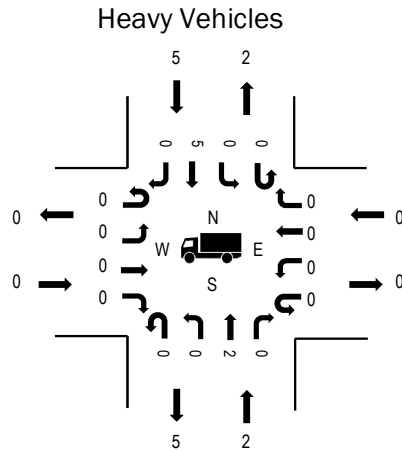
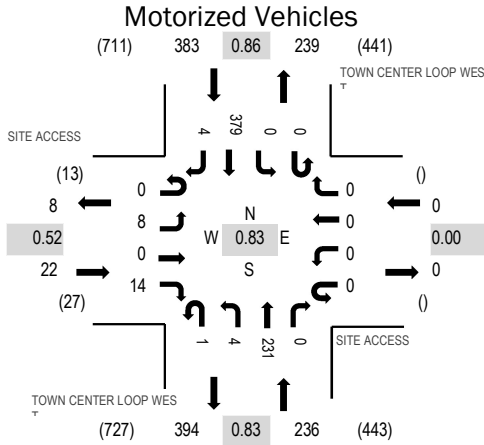

Note: Total study counts contained in parentheses.

	HV%	PHF
EB	0.0%	0.52
WB	0.0%	0.00
NB	0.8%	0.83
SB	1.3%	0.86
All	1.1%	0.83

Traffic Counts - Motorized Vehicles

Interval Start Time	SITE ACCESS Eastbound				SITE ACCESS Westbound				TOWN CENTER LOOP WEST Northbound				TOWN CENTER LOOP WEST Southbound				Total	Rolling Hour
	U-Turn	Left	Thru	Right	U-Turn	Left	Thru	Right	U-Turn	Left	Thru	Right	U-Turn	Left	Thru	Right		
4:00 PM	0	0	0	1	0	0	0	0	0	2	17	0	0	0	38	0	58	635
4:05 PM	0	0	0	0	0	0	0	0	0	0	17	0	0	0	43	0	60	629
4:10 PM	0	0	0	1	0	0	0	0	0	0	19	0	0	0	33	0	53	632
4:15 PM	0	0	0	0	0	0	0	0	0	0	18	0	0	0	27	0	45	631
4:20 PM	0	0	0	0	0	0	0	0	1	0	20	0	0	0	20	0	41	633
4:25 PM	0	0	0	0	0	0	0	0	0	0	18	0	0	0	32	0	50	641
4:30 PM	0	0	0	0	0	0	0	0	0	0	18	0	0	0	28	0	46	641
4:35 PM	0	0	0	0	0	0	0	0	0	0	18	0	0	0	18	0	36	637
4:40 PM	0	1	0	0	0	0	0	0	0	0	21	0	0	0	30	0	52	637
4:45 PM	0	0	0	5	0	0	0	0	0	0	28	0	0	0	39	2	74	624
4:50 PM	0	1	0	2	0	0	0	0	0	0	23	0	0	0	33	0	59	590
4:55 PM	0	1	0	2	0	0	0	0	0	1	22	0	0	0	35	0	61	576
5:00 PM	0	0	0	1	0	0	0	0	0	0	21	0	0	0	29	1	52	546
5:05 PM	0	2	0	1	0	0	0	0	0	2	16	0	0	0	41	1	63	
5:10 PM	0	1	0	0	0	0	0	0	0	0	15	0	0	0	36	0	52	
5:15 PM	0	1	0	1	0	0	0	0	1	0	11	0	0	0	33	0	47	
5:20 PM	0	1	0	2	0	0	0	0	0	1	20	0	0	0	25	0	49	
5:25 PM	0	0	0	1	0	0	0	0	1	0	15	0	0	0	33	0	50	
5:30 PM	0	0	0	0	0	0	0	0	0	0	18	0	0	0	24	0	42	
5:35 PM	0	0	0	0	0	0	0	0	0	0	18	0	0	0	18	0	36	
5:40 PM	0	0	0	0	0	0	0	0	0	0	14	0	0	0	24	1	39	
5:45 PM	0	0	0	0	0	0	0	0	0	2	13	0	0	0	25	0	40	
5:50 PM	0	1	0	1	0	0	0	0	0	0	25	0	0	0	18	0	45	
5:55 PM	0	0	0	0	0	0	0	0	0	0	7	0	0	0	24	0	31	
Count Total	0	9	0	18	0	0	0	0	3	8	432	0	0	0	706	5	1,181	
Peak Hour	0	8	0	14	0	0	0	0	1	4	231	0	0	0	379	4	641	

Traffic Counts - Heavy Vehicles, Bicycles on Road, and Pedestrians/Bicycles on Crosswalk

Interval Start Time	Heavy Vehicles					Interval Start Time	Bicycles on Roadway					Interval Start Time	Pedestrians/Bicycles on Crosswalk				
	EB	NB	WB	SB	Total		EB	NB	WB	SB	Total		EB	NB	WB	SB	Total
4:00 PM	0	1	0	0	1	4:00 PM	0	0	0	0	0	4:00 PM	0	0	0	0	0
4:05 PM	0	0	0	1	1	4:05 PM	0	0	0	0	0	4:05 PM	0	0	0	0	0
4:10 PM	0	0	0	1	1	4:10 PM	0	0	0	0	0	4:10 PM	0	0	0	0	0
4:15 PM	0	0	0	0	0	4:15 PM	0	0	0	0	0	4:15 PM	0	0	0	0	0
4:20 PM	0	0	0	0	0	4:20 PM	0	0	0	0	0	4:20 PM	0	0	0	0	0
4:25 PM	0	0	0	0	0	4:25 PM	0	0	0	0	0	4:25 PM	0	0	0	0	0
4:30 PM	0	0	0	0	0	4:30 PM	0	0	0	0	0	4:30 PM	0	0	0	0	0
4:35 PM	0	0	0	1	1	4:35 PM	0	0	0	0	0	4:35 PM	0	0	0	0	0
4:40 PM	0	0	0	1	1	4:40 PM	0	0	0	1	1	4:40 PM	0	0	0	0	0
4:45 PM	0	0	0	0	0	4:45 PM	0	0	0	0	0	4:45 PM	0	0	0	0	0
4:50 PM	0	0	0	0	0	4:50 PM	0	0	0	0	0	4:50 PM	0	0	0	0	0
4:55 PM	0	0	0	0	0	4:55 PM	0	0	0	0	0	4:55 PM	0	0	0	0	0
5:00 PM	0	1	0	0	1	5:00 PM	0	0	0	0	0	5:00 PM	0	0	0	0	0
5:05 PM	0	0	0	2	2	5:05 PM	0	0	0	0	0	5:05 PM	0	0	0	0	0
5:10 PM	0	1	0	1	2	5:10 PM	0	1	0	0	1	5:10 PM	0	0	0	0	0
5:15 PM	0	0	0	0	0	5:15 PM	0	0	0	0	0	5:15 PM	0	0	0	0	0
5:20 PM	0	0	0	0	0	5:20 PM	0	0	0	0	0	5:20 PM	0	0	0	0	0
5:25 PM	0	0	0	0	0	5:25 PM	0	0	0	0	0	5:25 PM	0	0	0	0	0
5:30 PM	0	0	0	0	0	5:30 PM	0	0	0	0	0	5:30 PM	0	0	0	0	0
5:35 PM	0	0	0	0	0	5:35 PM	0	0	0	0	0	5:35 PM	0	0	0	0	0
5:40 PM	0	0	0	0	0	5:40 PM	0	0	0	0	0	5:40 PM	0	0	0	0	0
5:45 PM	0	0	0	0	0	5:45 PM	0	0	0	0	0	5:45 PM	0	0	0	0	0
5:50 PM	0	1	0	0	1	5:50 PM	0	0	0	0	0	5:50 PM	0	0	0	0	0
5:55 PM	0	0	0	0	0	5:55 PM	0	0	0	0	0	5:55 PM	0	0	0	0	0
Count Total	0	4	0	7	11	Count Total	0	1	0	1	2	Count Total	0	0	0	0	0
Peak Hour	0	2	0	5	7	Peak Hour	0	1	0	1	2	Peak Hour	0	0	0	0	0



ALL TRAFFIC DATA SERVICES

(303) 216-2439

www.alltrafficdata.net

Location: 1 I-5 SB RAMPS & WILSONVILLE RD PM

Date: Wednesday, March 8, 2023

Peak Hour: 04:05 PM - 05:05 PM

Peak 15-Minutes: 04:05 PM - 04:20 PM

Peak Hour

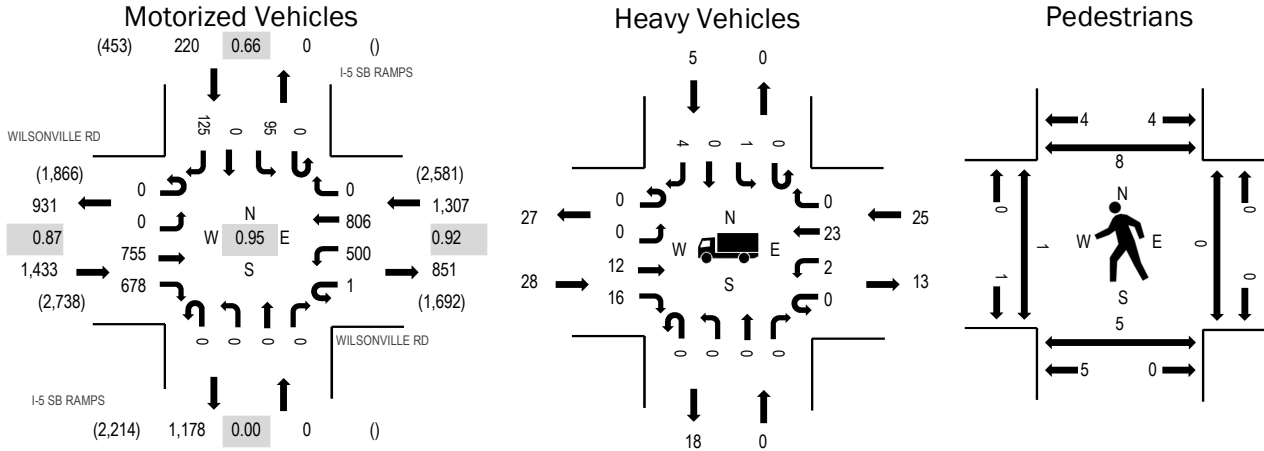

Note: Total study counts contained in parentheses.

	HV%	PHF
EB	2.0%	0.87
WB	1.9%	0.92
NB	0.0%	0.00
SB	2.3%	0.66
All	2.0%	0.95

Traffic Counts - Motorized Vehicles

Interval Start Time	WILSONVILLE RD Eastbound				WILSONVILLE RD Westbound				I-5 SB RAMPS Northbound				I-5 SB RAMPS Southbound				Total	Rolling Hour
	U-Turn	Left	Thru	Right	U-Turn	Left	Thru	Right	U-Turn	Left	Thru	Right	U-Turn	Left	Thru	Right		
4:00 PM	0	0	45	51	0	41	57	0	0	0	0	0	0	7	0	14	215	2,920
4:05 PM	0	0	68	85	0	32	54	0	0	0	0	0	0	11	0	17	267	2,960
4:10 PM	0	0	70	59	0	47	67	0	0	0	0	0	0	6	0	13	262	2,948
4:15 PM	0	0	77	52	0	43	60	0	0	0	0	0	0	6	0	11	249	2,935
4:20 PM	0	0	67	58	0	40	60	0	0	0	0	0	0	8	0	10	243	2,923
4:25 PM	0	0	53	41	0	37	88	0	0	0	0	0	0	15	0	8	242	2,955
4:30 PM	0	0	67	47	0	44	79	0	0	0	0	0	0	5	0	7	249	2,952
4:35 PM	0	0	47	48	0	33	58	0	0	0	0	0	0	11	0	6	203	2,914
4:40 PM	0	0	62	74	0	41	57	0	0	0	0	0	0	8	0	9	251	2,958
4:45 PM	0	0	63	59	0	53	87	0	0	0	0	0	0	4	0	12	278	2,944
4:50 PM	0	0	49	43	1	46	64	0	0	0	0	0	0	10	0	9	222	2,885
4:55 PM	0	0	50	51	0	53	69	0	0	0	0	0	0	5	0	11	239	2,868
5:00 PM	0	0	82	61	0	31	63	0	0	0	0	0	0	6	0	12	255	2,852
5:05 PM	0	0	71	54	0	52	66	0	0	0	0	0	0	6	0	6	255	
5:10 PM	0	0	71	54	0	58	58	0	0	0	0	0	0	2	0	6	249	
5:15 PM	0	0	64	47	0	39	67	0	0	0	0	0	0	13	0	7	237	
5:20 PM	0	0	64	56	0	43	88	0	0	0	0	0	0	12	0	12	275	
5:25 PM	0	0	77	44	0	36	69	0	0	0	0	0	0	6	0	7	239	
5:30 PM	0	0	66	40	0	24	63	0	0	0	0	0	0	9	0	9	211	
5:35 PM	0	0	70	55	0	33	74	0	0	0	0	0	0	6	0	9	247	
5:40 PM	0	0	54	48	0	48	72	0	0	0	0	0	0	6	0	9	237	
5:45 PM	0	0	47	31	0	37	81	0	0	0	0	0	0	11	0	12	219	
5:50 PM	0	0	40	46	0	30	58	0	0	0	0	0	0	11	0	20	205	
5:55 PM	0	0	67	43	0	26	54	0	0	0	0	0	0	16	0	17	223	
Count Total	0	0	1,491	1,247	1	967	1,613	0	0	0	0	0	0	200	0	253	5,772	
Peak Hour	0	0	755	678	1	500	806	0	0	0	0	0	0	95	0	125	2,960	

Traffic Counts - Heavy Vehicles, Bicycles on Road, and Pedestrians/Bicycles on Crosswalk

Interval Start Time	Heavy Vehicles					Interval Start Time	Bicycles on Roadway					Interval Start Time	Pedestrians/Bicycles on Crosswalk				
	EB	NB	WB	SB	Total		EB	NB	WB	SB	Total		EB	NB	WB	SB	Total
4:00 PM	4	0	0	0	4	4:00 PM	0	0	0	0	0	4:00 PM	0	0	0	0	0
4:05 PM	1	0	1	0	2	4:05 PM	0	0	0	0	0	4:05 PM	0	0	0	0	0
4:10 PM	5	0	3	0	8	4:10 PM	0	0	0	0	0	4:10 PM	0	0	0	0	0
4:15 PM	2	0	3	2	7	4:15 PM	0	0	0	0	0	4:15 PM	0	0	0	0	0
4:20 PM	2	0	1	1	4	4:20 PM	0	0	0	0	0	4:20 PM	0	2	0	3	5
4:25 PM	2	0	3	0	5	4:25 PM	0	0	0	0	0	4:25 PM	1	1	0	2	4
4:30 PM	3	0	2	1	6	4:30 PM	0	0	0	0	0	4:30 PM	0	0	0	1	1
4:35 PM	0	0	1	0	1	4:35 PM	0	0	0	0	0	4:35 PM	0	0	0	0	0
4:40 PM	5	0	4	0	9	4:40 PM	0	0	0	0	0	4:40 PM	0	1	0	0	1
4:45 PM	2	0	1	0	3	4:45 PM	0	0	0	0	0	4:45 PM	0	0	0	2	2
4:50 PM	1	0	5	0	6	4:50 PM	0	0	0	0	0	4:50 PM	0	1	0	0	1
4:55 PM	1	0	1	0	2	4:55 PM	0	0	0	0	0	4:55 PM	0	0	0	0	0
5:00 PM	4	0	0	1	5	5:00 PM	0	0	0	0	0	5:00 PM	0	1	0	0	1
5:05 PM	1	0	2	0	3	5:05 PM	0	0	0	0	0	5:05 PM	0	0	0	0	0
5:10 PM	1	0	2	0	3	5:10 PM	0	0	0	0	0	5:10 PM	0	0	0	0	0
5:15 PM	2	0	2	0	4	5:15 PM	0	0	0	0	0	5:15 PM	1	0	0	0	1
5:20 PM	1	0	0	0	1	5:20 PM	0	0	0	0	0	5:20 PM	2	1	0	2	5
5:25 PM	2	0	1	1	4	5:25 PM	0	0	0	0	0	5:25 PM	0	0	0	0	0
5:30 PM	1	0	0	0	1	5:30 PM	0	0	0	0	0	5:30 PM	1	0	0	1	2
5:35 PM	1	0	0	1	2	5:35 PM	0	0	2	0	2	5:35 PM	0	1	0	0	1
5:40 PM	5	0	2	0	7	5:40 PM	0	0	0	0	0	5:40 PM	0	6	0	0	6
5:45 PM	2	0	2	1	5	5:45 PM	0	0	0	0	0	5:45 PM	0	0	0	0	0
5:50 PM	1	0	3	1	5	5:50 PM	0	0	0	0	0	5:50 PM	0	0	0	0	0
5:55 PM	3	0	0	1	4	5:55 PM	0	0	0	0	0	5:55 PM	0	1	0	0	1
Count Total	52	0	39	10	101	Count Total	0	0	2	0	2	Count Total	5	15	0	11	31
Peak Hour	28	0	25	5	58	Peak Hour	0	0	0	0	0	Peak Hour	1	6	0	8	15

Traffic Counts - Heavy Vehicles, Bicycles on Road, and Pedestrians/Bicycles on Crosswalk

Interval Start Time	Heavy Vehicles					Interval Start Time	Bicycles on Roadway					Interval Start Time	Pedestrians/Bicycles on Crosswalk				
	EB	NB	WB	SB	Total		EB	NB	WB	SB	Total		EB	NB	WB	SB	Total
4:00 PM	5	1	2	0	8	4:00 PM	0	0	0	0	0	4:00 PM	0	0	0	0	0
4:05 PM	1	0	0	0	1	4:05 PM	0	0	0	0	0	4:05 PM	0	0	0	0	0
4:10 PM	1	1	2	0	4	4:10 PM	0	0	0	0	0	4:10 PM	0	0	0	0	0
4:15 PM	2	3	1	0	6	4:15 PM	0	0	0	0	0	4:15 PM	0	1	0	1	2
4:20 PM	1	3	1	0	5	4:20 PM	0	0	0	0	0	4:20 PM	0	2	0	3	5
4:25 PM	1	3	1	0	5	4:25 PM	0	0	0	0	0	4:25 PM	0	0	0	1	1
4:30 PM	4	5	0	0	9	4:30 PM	0	0	0	0	0	4:30 PM	0	0	0	0	0
4:35 PM	0	1	0	0	1	4:35 PM	0	0	0	0	0	4:35 PM	0	1	1	1	3
4:40 PM	1	3	1	0	5	4:40 PM	0	0	0	0	0	4:40 PM	0	0	0	0	0
4:45 PM	1	1	0	0	2	4:45 PM	0	0	0	0	0	4:45 PM	0	0	0	2	2
4:50 PM	0	3	2	0	5	4:50 PM	0	0	0	0	0	4:50 PM	0	1	0	0	1
4:55 PM	0	2	1	0	3	4:55 PM	0	0	0	0	0	4:55 PM	0	0	0	0	0
5:00 PM	1	0	2	0	3	5:00 PM	0	1	0	0	1	5:00 PM	0	1	0	0	1
5:05 PM	1	1	2	0	4	5:05 PM	0	0	0	0	0	5:05 PM	0	0	0	0	0
5:10 PM	0	2	2	0	4	5:10 PM	0	0	0	0	0	5:10 PM	0	0	0	0	0
5:15 PM	1	2	0	0	3	5:15 PM	0	0	0	0	0	5:15 PM	0	0	0	0	0
5:20 PM	0	0	0	0	0	5:20 PM	0	0	0	0	0	5:20 PM	0	2	0	2	4
5:25 PM	0	0	1	0	1	5:25 PM	0	0	0	0	0	5:25 PM	0	0	0	1	1
5:30 PM	2	0	0	0	2	5:30 PM	0	0	0	0	0	5:30 PM	0	0	1	0	1
5:35 PM	0	0	0	0	0	5:35 PM	0	0	0	0	0	5:35 PM	0	5	0	2	7
5:40 PM	2	0	2	0	4	5:40 PM	0	0	0	0	0	5:40 PM	0	1	0	0	1
5:45 PM	1	2	0	0	3	5:45 PM	0	0	0	0	0	5:45 PM	0	1	0	0	1
5:50 PM	0	2	1	0	3	5:50 PM	0	0	0	0	0	5:50 PM	0	0	0	0	0
5:55 PM	1	0	0	0	1	5:55 PM	0	0	0	0	0	5:55 PM	0	1	0	0	1
Count Total	26	35	21	0	82	Count Total	0	1	0	0	1	Count Total	0	16	2	13	31
Peak Hour	7	15	11	0	33	Peak Hour	0	1	0	0	1	Peak Hour	0	5	2	6	13



ALL TRAFFIC DATA SERVICES

(303) 216-2439

www.alltrafficdata.net

Location: 3 TOWN CENTER LOOP WEST & WILSONVILLE RD PM

Date: Wednesday, March 8, 2023

Peak Hour: 04:40 PM - 05:40 PM

Peak 15-Minutes: 04:55 PM - 05:10 PM

Peak Hour

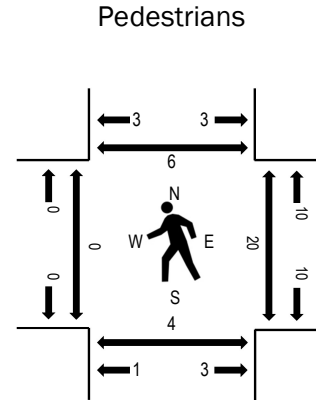
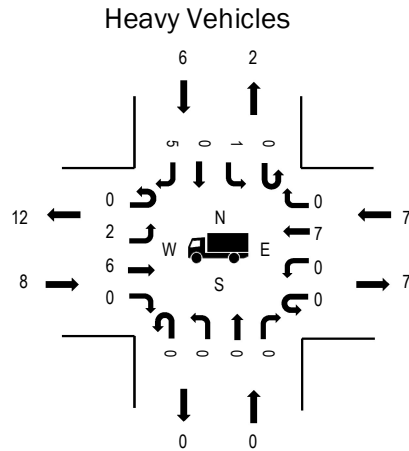
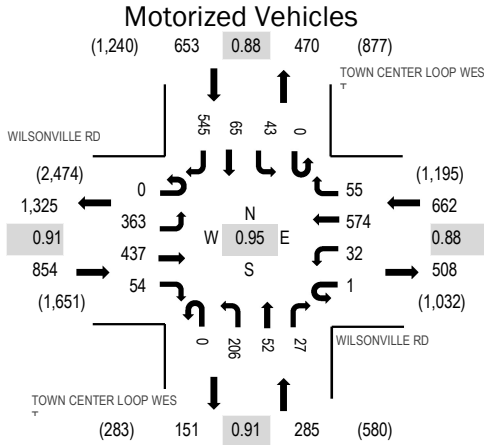

Note: Total study counts contained in parentheses.

	HV%	PHF
EB	0.9%	0.91
WB	1.1%	0.88
NB	0.0%	0.91
SB	0.9%	0.88
All	0.9%	0.95

Traffic Counts - Motorized Vehicles

Interval Start Time	WILSONVILLE RD Eastbound				WILSONVILLE RD Westbound				TOWN CENTER LOOP WEST Northbound				TOWN CENTER LOOP WEST Southbound				Total	Rolling Hour
	U-Turn	Left	Thru	Right	U-Turn	Left	Thru	Right	U-Turn	Left	Thru	Right	U-Turn	Left	Thru	Right		
4:00 PM	0	21	40	2	0	4	39	3	0	12	4	4	0	1	4	56	190	2,283
4:05 PM	0	28	42	3	0	5	36	3	0	10	1	1	0	2	6	46	183	2,310
4:10 PM	0	30	29	2	0	2	21	4	0	29	4	5	0	2	2	38	168	2,356
4:15 PM	0	29	44	5	0	3	42	4	0	20	2	4	0	2	8	43	206	2,387
4:20 PM	0	24	39	4	0	1	59	7	0	12	7	2	0	2	3	26	186	2,392
4:25 PM	0	33	35	3	0	2	32	2	0	12	10	3	0	3	7	52	194	2,413
4:30 PM	0	22	32	1	0	1	37	3	0	20	7	5	0	6	11	42	187	2,402
4:35 PM	0	24	44	4	0	3	42	2	0	19	6	2	0	1	4	38	189	2,428
4:40 PM	0	27	37	7	0	0	52	2	0	11	4	2	0	2	3	47	194	2,454
4:45 PM	0	34	33	1	1	0	41	4	0	19	3	1	0	2	3	45	187	2,436
4:50 PM	0	30	33	2	0	6	44	12	0	14	2	3	0	4	7	43	200	2,428
4:55 PM	0	31	25	5	0	1	51	10	0	16	4	2	0	7	4	43	199	2,395
5:00 PM	0	40	37	2	0	8	38	1	0	21	5	3	0	2	8	52	217	2,383
5:05 PM	0	27	41	3	0	2	48	4	0	24	2	6	0	8	2	62	229	
5:10 PM	0	21	36	3	0	1	67	5	0	20	4	2	0	1	5	34	199	
5:15 PM	0	34	36	6	0	4	55	1	0	17	2	2	0	4	10	40	211	
5:20 PM	0	25	37	6	0	1	51	4	0	21	6	2	0	4	2	48	207	
5:25 PM	0	24	36	6	0	3	27	5	0	17	5	1	0	7	8	44	183	
5:30 PM	0	36	51	9	0	3	43	3	0	15	10	2	0	1	5	35	213	
5:35 PM	0	34	35	4	0	3	57	4	0	11	5	1	0	1	8	52	215	
5:40 PM	0	21	34	3	0	2	29	4	0	19	8	0	0	1	5	50	176	
5:45 PM	0	13	30	5	0	2	47	6	0	15	8	2	0	4	5	42	179	
5:50 PM	0	23	42	5	0	3	41	1	0	10	9	1	0	4	1	27	167	
5:55 PM	0	25	50	6	0	2	34	5	0	16	4	2	0	4	3	36	187	
Count Total	0	656	898	97	1	62	1,033	99	0	400	122	58	0	75	124	1,041	4,666	
Peak Hour	0	363	437	54	1	32	574	55	0	206	52	27	0	43	65	545	2,454	

Traffic Counts - Heavy Vehicles, Bicycles on Road, and Pedestrians/Bicycles on Crosswalk

Interval Start Time	Heavy Vehicles					Interval Start Time	Bicycles on Roadway					Interval Start Time	Pedestrians/Bicycles on Crosswalk				
	EB	NB	WB	SB	Total		EB	NB	WB	SB	Total		EB	NB	WB	SB	Total
4:00 PM	1	0	1	1	3	4:00 PM	0	0	0	0	0	4:00 PM	0	2	2	0	4
4:05 PM	1	0	0	0	1	4:05 PM	0	0	0	0	0	4:05 PM	0	0	0	0	0
4:10 PM	0	2	0	1	3	4:10 PM	0	0	0	0	0	4:10 PM	0	0	4	0	4
4:15 PM	2	0	1	0	3	4:15 PM	0	0	0	0	0	4:15 PM	0	2	2	1	5
4:20 PM	0	0	1	0	1	4:20 PM	0	0	0	0	0	4:20 PM	0	0	1	1	2
4:25 PM	0	0	0	1	1	4:25 PM	0	0	0	0	0	4:25 PM	0	0	5	1	6
4:30 PM	4	0	0	0	4	4:30 PM	0	0	0	0	0	4:30 PM	0	0	0	0	0
4:35 PM	1	0	0	0	1	4:35 PM	0	0	0	0	0	4:35 PM	0	3	1	0	4
4:40 PM	1	0	0	1	2	4:40 PM	0	0	0	0	0	4:40 PM	0	1	2	0	3
4:45 PM	1	0	0	1	2	4:45 PM	0	0	0	0	0	4:45 PM	0	2	3	1	6
4:50 PM	0	0	2	0	2	4:50 PM	0	0	0	0	0	4:50 PM	0	0	2	3	5
4:55 PM	1	0	1	0	2	4:55 PM	0	0	0	0	0	4:55 PM	0	0	0	0	0
5:00 PM	1	0	1	1	3	5:00 PM	0	0	0	0	0	5:00 PM	0	1	1	0	2
5:05 PM	1	0	1	1	3	5:05 PM	0	0	0	0	0	5:05 PM	0	0	2	2	4
5:10 PM	0	0	1	1	2	5:10 PM	0	0	0	0	0	5:10 PM	0	1	3	0	4
5:15 PM	0	0	0	0	0	5:15 PM	0	0	0	0	0	5:15 PM	0	0	0	0	0
5:20 PM	1	0	0	0	1	5:20 PM	0	0	0	0	0	5:20 PM	0	0	0	0	0
5:25 PM	0	0	1	0	1	5:25 PM	0	0	0	0	0	5:25 PM	0	0	2	0	2
5:30 PM	2	0	0	0	2	5:30 PM	0	0	0	0	0	5:30 PM	0	0	3	0	3
5:35 PM	0	0	0	1	1	5:35 PM	0	0	0	0	0	5:35 PM	0	0	3	0	3
5:40 PM	3	0	0	1	4	5:40 PM	0	0	0	0	0	5:40 PM	0	0	1	0	1
5:45 PM	0	0	0	0	0	5:45 PM	0	0	0	0	0	5:45 PM	0	1	0	1	2
5:50 PM	0	0	1	0	1	5:50 PM	0	0	0	0	0	5:50 PM	0	2	1	1	4
5:55 PM	0	0	0	0	0	5:55 PM	0	0	0	0	0	5:55 PM	0	1	0	0	1
Count Total	20	2	11	10	43	Count Total	0	0	0	0	0	Count Total	0	16	38	11	65
Peak Hour	8	0	7	6	21	Peak Hour	0	0	0	0	0	Peak Hour	0	5	21	6	32

Traffic Counts - Heavy Vehicles, Bicycles on Road, and Pedestrians/Bicycles on Crosswalk

Interval Start Time	Heavy Vehicles					Interval Start Time	Bicycles on Roadway					Interval Start Time	Pedestrians/Bicycles on Crosswalk				
	EB	NB	WB	SB	Total		EB	NB	WB	SB	Total		EB	NB	WB	SB	Total
4:00 PM	0	0	0	0	0	4:00 PM	0	0	0	0	0	4:00 PM	0	0	0	0	0
4:05 PM	0	0	0	0	0	4:05 PM	0	0	0	0	0	4:05 PM	0	6	0	0	6
4:10 PM	0	0	1	0	1	4:10 PM	0	0	0	0	0	4:10 PM	0	0	1	0	1
4:15 PM	0	1	0	0	1	4:15 PM	0	0	0	0	0	4:15 PM	0	1	0	0	1
4:20 PM	0	0	0	0	0	4:20 PM	0	0	0	0	0	4:20 PM	0	0	0	0	0
4:25 PM	0	0	0	0	0	4:25 PM	0	0	0	0	0	4:25 PM	0	0	0	0	0
4:30 PM	0	1	0	0	1	4:30 PM	0	0	0	0	0	4:30 PM	0	1	0	0	1
4:35 PM	0	1	1	0	2	4:35 PM	0	0	0	0	0	4:35 PM	0	0	6	0	6
4:40 PM	0	0	0	0	0	4:40 PM	0	0	0	0	0	4:40 PM	0	0	0	0	0
4:45 PM	0	0	1	0	1	4:45 PM	0	0	0	0	0	4:45 PM	0	0	0	0	0
4:50 PM	0	1	0	0	1	4:50 PM	0	0	0	0	0	4:50 PM	0	1	0	0	1
4:55 PM	0	0	0	0	0	4:55 PM	0	0	0	0	0	4:55 PM	0	0	0	0	0
5:00 PM	0	0	0	1	1	5:00 PM	0	0	0	0	0	5:00 PM	0	0	0	0	0
5:05 PM	0	0	0	0	0	5:05 PM	0	0	0	0	0	5:05 PM	0	0	0	0	0
5:10 PM	0	0	1	0	1	5:10 PM	0	0	0	0	0	5:10 PM	0	0	0	0	0
5:15 PM	0	0	0	0	0	5:15 PM	0	0	0	0	0	5:15 PM	0	0	0	0	0
5:20 PM	0	1	0	0	1	5:20 PM	0	0	0	0	0	5:20 PM	0	0	1	0	1
5:25 PM	0	0	0	0	0	5:25 PM	0	0	0	0	0	5:25 PM	0	1	0	0	1
5:30 PM	0	0	0	0	0	5:30 PM	0	0	0	0	0	5:30 PM	0	0	0	0	0
5:35 PM	0	0	0	1	1	5:35 PM	0	0	0	0	0	5:35 PM	0	0	0	0	0
5:40 PM	0	0	1	0	1	5:40 PM	0	0	0	0	0	5:40 PM	0	0	0	0	0
5:45 PM	0	2	0	0	2	5:45 PM	0	0	0	0	0	5:45 PM	0	1	0	0	1
5:50 PM	0	0	0	0	0	5:50 PM	0	0	0	0	0	5:50 PM	0	0	0	0	0
5:55 PM	0	0	0	0	0	5:55 PM	0	0	0	0	0	5:55 PM	0	0	0	0	0
Count Total	0	7	5	2	14	Count Total	0	0	0	0	0	Count Total	0	11	8	0	19
Peak Hour	0	4	3	1	8	Peak Hour	0	0	0	0	0	Peak Hour	0	2	7	0	9

APPENDIX B: STAGE II LIST

Stage II Approved										
Project	Land Use	Status	Size	Total PM Peak Trips	Trip Allocation Percentage		Net New (Primary + Diverted) PM Peak Hour Trips not yet active			
					Internal	Pass-By	In	Out	Total	
Hydro-Temp: Recent agreement with the City, the project is vested and so are the traffic trips	Office/Flex-Space	Not built	60.8 KSF					44	46	90
Mercedes Benz (Phase 2)	Auto Dealership	Not built						20	26	46
Town Center Ph III and trip dedication to Miller Paint store Uses marked with "*" have not been built and PM peak hr trip sum exceeds remaining vested trip level by 2 trips. It has yet to be determined how to allocate trips between remaining buildings.	*High Turnover Restaurant (Pad 1)	Not built	7.5 KSF					24	17	47*
	Remaining Approved Total									47
Wilsonville Road Business Park Phase II	Phase 2 - office (2-story building on west parcel)	Partially Built	21.7 KSF					15	71	86
Frog Pond-Frog Pond Meadows (Phase 3B, 4A, 4B of 10/18 Study)	Residential	Partially Built, 69 homes built and occupied	74 units					3	2	5
Frog Pond Ridge	Residential	Under construction, no homes	71 units					43	28	71
Frog Pond Crossing	Residential	Under Construction	29 units					19	9	28
Frog Pond Estates	Residential	Approved	17 units					11	7	18
Frog Pond Oaks	Residential	Approved	41 units					27	14	41
Frog Pond Vista	Residential	Approved	38 units					27	17	44
Frog Pond Overlook	Residential	Approved	12 Units					8	5	13
Frog Pond Terrace	Residential	Approved	19 Units					12	8	20
Magnolia Townhomes	Residential	Under construction	6 units					3	2	5
Canyon Creek III	Residential	Under Construction	5 units (traffic study was for 11)					2	3	5
PW Complex on Boberg	Public	Under Construction	15,800 office, 17,900 warehouse					11	39	50
DAS North Valley Complex	Public/Industrial	Under Construction	174,700 sf					5	15	20
Black Creek Group-Garden Acres	Industrial	Under Construction	148,500 sf warehouse	178				69	109	178
Boones Ferry Gas Station/Convenience Store	Commercaill	Under Construction	3,460 sf store, 12 gas pumps	240		134		53	53	106
Boones Ferry Construction Storage Yard	Industrial	Under Construction	1.25 acres	5				1	4	5

Stage II Approved – Villebois													
Project	Phase	Status	Land Use					Total PM Peak Trips	Trip Allocation Percentage		Net New (Primary + Diverted) PM Peak Hour Trips not yet active		
			SF	Town.	Apt.	Retail	School		Internal	Pass-By	In	Out	Total
North (Entirety)	Residential	Partially built, 364 homes sold and occupied	451								53	34	87
Central	Residential	Partially Built, 991 homes (102 single family, 319 condo/row homes, 365 apartments) occupied	102	391	510						60	30	90
FOR REFERENCE SAP EAST			537	42									
FOR REFERENCE SAP SOUTH (Includes PDP 7 Grande Point)			560										













Pending Projects for Which Traffic Analysis has been completed										
Project	Land Use	Status	Size	Total PM Peak Trips	Trip Allocation Percentage			Net New (Primary) PM Peak Hour Trips		
					Internal	Pass-By	Diverted	In	Out	Total
Delta Logistics	Industrial	under review	56,100 sf wareh	33				9	24	33
Building W5 Boeckman and Kins	Industrial	under review	80,000 sf manufac	54				17	37	54
Precision Countertops	Industrial	under review	65800 square feet	43				13	30	43
Frog Pond Primary	Public	under review	550 students	88				39	48	87
Parkway Woods Expansion	Public	under review	80,000 sf manufac	52				16	36	52

Import Counts	Export		Total Vehicle Volumes									
	formal			Southbound			Eastbound			Westbound		
Intersection	NBL	NBT	NBR	SBL	SBT	SBR	EBL	EBT	EBR	WBL	WBT	WBR
Stage II Trips - PM Peak												
I-5 SB Ramps/Wilsonville Rd	0	0	0	4	0	26	0	80	45	6	47	0
I-5 NB Ramps/Wilsonville Rd	33	0	9	0	0	0	49	35	0	0	20	3
Wilsonville Rd/Town Center Loop West	0	2	0	1	2	11	19	25	0	0	12	2
Park Pl/Town Center Loop West	0	22	1	3	14	0	0	0	0	0	0	2
Site Access/Town Center Loop West	0	24	0	0	17	0	0	0	0	0	0	0

APPENDIX C: HCM REPORT - EXISTING

HCM 6th Signalized Intersection Summary
1: I-5 SB Ramp & Wilsonville Rd

Wilsonville Town Center Multifamily TIA
Existing 2023 - PM Peak

												
Movement	EBL	EBT	EBR	WBL	WBT	WBR	NBL	NBT	NBR	SBL	SBT	SBR
Lane Configurations		↑↑↑	↗	↘↗	↑↑					↘	↗	↗↗
Traffic Volume (veh/h)	0	745	651	513	850	0	0	0	0	71	1	109
Future Volume (veh/h)	0	745	651	513	850	0	0	0	0	71	1	109
Initial Q (Qb), veh	0	0	0	0	0	0				0	0	0
Ped-Bike Adj(A_pbT)	1.00		1.00	1.00		1.00				1.00		0.99
Parking Bus, Adj	1.00	1.00	1.00	1.00	1.00	1.00				1.00	1.00	1.00
Work Zone On Approach		No			No						No	
Adj Sat Flow, veh/h/ln	0	1870	1870	1900	1856	0				1885	1900	1841
Adj Flow Rate, veh/h	0	784	0	540	895	0				76	0	12
Peak Hour Factor	0.95	0.95	0.95	0.95	0.95	0.95				0.95	0.95	0.95
Percent Heavy Veh, %	0	2	2	0	3	0				1	0	4
Cap, veh/h	0	3383		616	3083	0				189	0	163
Arrive On Green	0.00	1.00	0.00	0.35	1.00	0.00				0.05	0.00	0.05
Sat Flow, veh/h	0	5274	1585	3510	3618	0				3591	0	3091
Grp Volume(v), veh/h	0	784	0	540	895	0				76	0	12
Grp Sat Flow(s),veh/h/ln	0	1702	1585	1755	1763	0				1795	0	1546
Q Serve(g_s), s	0.0	0.0	0.0	15.9	0.0	0.0				2.3	0.0	0.4
Cycle Q Clear(g_c), s	0.0	0.0	0.0	15.9	0.0	0.0				2.3	0.0	0.4
Prop In Lane	0.00		1.00	1.00		0.00				1.00		1.00
Lane Grp Cap(c), veh/h	0	3383		616	3083	0				189	0	163
V/C Ratio(X)	0.00	0.23		0.88	0.29	0.00				0.40	0.00	0.07
Avail Cap(c_a), veh/h	0	3383		766	3083	0				620	0	534
HCM Platoon Ratio	1.00	2.00	2.00	2.00	2.00	1.00				1.00	1.00	1.00
Upstream Filter(I)	0.00	1.00	0.00	0.92	0.92	0.00				1.00	0.00	1.00
Uniform Delay (d), s/veh	0.0	0.0	0.0	34.6	0.0	0.0				50.4	0.0	49.5
Incr Delay (d2), s/veh	0.0	0.2	0.0	8.8	0.2	0.0				1.4	0.0	0.2
Initial Q Delay(d3),s/veh	0.0	0.0	0.0	0.0	0.0	0.0				0.0	0.0	0.0
%ile BackOfQ(50%),veh/ln	0.0	0.1	0.0	6.4	0.1	0.0				1.0	0.0	0.4
Unsig. Movement Delay, s/veh												
LnGrp Delay(d),s/veh	0.0	0.2	0.0	43.4	0.2	0.0				51.8	0.0	49.7
LnGrp LOS	A	A		D	A	A				D	A	D
Approach Vol, veh/h		784			1435						88	
Approach Delay, s/veh		0.2			16.5						51.5	
Approach LOS		A			B						D	
Timer - Assigned Phs	1	2		4		6						
Phs Duration (G+Y+Rc), s	23.3	76.9		9.8		100.2						
Change Period (Y+Rc), s	4.0	4.0		4.0		4.0						
Max Green Setting (Gmax), s	24.0	55.0		19.0		75.0						
Max Q Clear Time (g_c+I1), s	17.9	2.0		4.3		2.0						
Green Ext Time (p_c), s	1.5	4.5		0.2		5.3						

Intersection Summary

HCM 6th Ctrl Delay	12.3
HCM 6th LOS	B

Notes

User approved volume balancing among the lanes for turning movement.
Unsignalized Delay for [EBR] is excluded from calculations of the approach delay and intersection delay.

HCM 6th Signalized Intersection Summary
2: I-5 NB Ramp & Wilsonville Rd

Wilsonville Town Center Multifamily TIA
Existing 2023 - PM Peak



Movement	EBL	EBT	EBR	WBL	WBT	WBR	NBL	NBT	NBR	SBL	SBT	SBR
Lane Configurations	↔↔	↑↑			↑↑↑	↔	↔	↔	↔↔			
Traffic Volume (veh/h)	288	528	0	0	1023	310	340	2	406	0	0	0
Future Volume (veh/h)	288	528	0	0	1023	310	340	2	406	0	0	0
Initial Q (Qb), veh	0	0	0	0	0	0	0	0	0			
Ped-Bike Adj(A_pbT)	1.00		1.00	1.00		1.00	1.00		0.97			
Parking Bus, Adj	1.00	1.00	1.00	1.00	1.00	1.00	1.00	1.00	1.00			
Work Zone On Approach		No			No			No				
Adj Sat Flow, veh/h/ln	1870	1870	0	0	1885	1870	1841	1900	1885			
Adj Flow Rate, veh/h	310	568	0	0	1100	0	367	0	122			
Peak Hour Factor	0.93	0.93	0.93	0.93	0.93	0.93	0.93	0.93	0.93			
Percent Heavy Veh, %	2	2	0	0	1	2	4	0	1			
Cap, veh/h	382	2820	0	0	3329		469	0	413			
Arrive On Green	0.22	1.00	0.00	0.00	1.00	0.00	0.13	0.00	0.13			
Sat Flow, veh/h	3456	3647	0	0	5316	1585	3506	0	3090			
Grp Volume(v), veh/h	310	568	0	0	1100	0	367	0	122			
Grp Sat Flow(s),veh/h/ln	1728	1777	0	0	1716	1585	1753	0	1545			
Q Serve(g_s), s	9.4	0.0	0.0	0.0	0.0	0.0	11.1	0.0	3.9			
Cycle Q Clear(g_c), s	9.4	0.0	0.0	0.0	0.0	0.0	11.1	0.0	3.9			
Prop In Lane	1.00		0.00	0.00		1.00	1.00		1.00			
Lane Grp Cap(c), veh/h	382	2820	0	0	3329		469	0	413			
V/C Ratio(X)	0.81	0.20	0.00	0.00	0.33		0.78	0.00	0.30			
Avail Cap(c_a), veh/h	691	2820	0	0	3329		956	0	843			
HCM Platoon Ratio	2.00	2.00	1.00	1.00	2.00	2.00	1.00	1.00	1.00			
Upstream Filter(I)	0.98	0.98	0.00	0.00	0.73	0.00	1.00	0.00	1.00			
Uniform Delay (d), s/veh	41.8	0.0	0.0	0.0	0.0	0.0	46.1	0.0	43.0			
Incr Delay (d2), s/veh	2.6	0.2	0.0	0.0	0.2	0.0	1.8	0.0	0.2			
Initial Q Delay(d3),s/veh	0.0	0.0	0.0	0.0	0.0	0.0	0.0	0.0	0.0			
%ile BackOfQ(50%),veh/ln	3.7	0.1	0.0	0.0	0.1	0.0	4.8	0.0	1.5			
Unsig. Movement Delay, s/veh												
LnGrp Delay(d),s/veh	44.3	0.2	0.0	0.0	0.2	0.0	47.9	0.0	43.2			
LnGrp LOS	D	A	A	A	A		D	A	D			
Approach Vol, veh/h		878			1100			489				
Approach Delay, s/veh		15.8			0.2			46.7				
Approach LOS		B			A			D				
Timer - Assigned Phs		2			5	6		8				
Phs Duration (G+Y+Rc), s		91.3			16.2	75.1		18.7				
Change Period (Y+Rc), s		4.0			4.0	4.0		4.0				
Max Green Setting (Gmax), s		55.0			22.0	46.0		30.0				
Max Q Clear Time (g_c+I1), s		2.0			11.4	2.0		13.1				
Green Ext Time (p_c), s		6.6			0.8	14.9		1.4				

Intersection Summary

HCM 6th Ctrl Delay	15.0
HCM 6th LOS	B

Notes

User approved volume balancing among the lanes for turning movement.
Unsignalized Delay for [WBR] is excluded from calculations of the approach delay and intersection delay.

HCM 6th Signalized Intersection Summary
 3: Town Center Loop West & Wilsonville Rd

Wilsonville Town Center Multifamily TIA
 Existing 2023 - PM Peak



Movement	EBL	EBT	EBR	WBL	WBT	WBR	NBL	NBT	NBR	SBL	SBT	SBR
Lane Configurations	↔↔	↕↔		↔	↕↔		↔	↕↔		↔	↕↔	↔
Traffic Volume (veh/h)	362	432	52	29	562	54	215	58	29	34	61	556
Future Volume (veh/h)	362	432	52	29	562	54	215	58	29	34	61	556
Initial Q (Qb), veh	0	0	0	0	0	0	0	0	0	0	0	0
Ped-Bike Adj(A_pbT)	1.00		0.99	1.00		0.98	1.00		0.94	1.00		0.93
Parking Bus, Adj	1.00	1.00	1.00	1.00	1.00	1.00	1.00	1.00	1.00	1.00	1.00	1.00
Work Zone On Approach		No		No		No		No		No		No
Adj Sat Flow, veh/h/ln	1885	1870	1900	1870	1870	1900	1885	1885	1900	1885	1885	1885
Adj Flow Rate, veh/h	381	455	49	31	592	52	226	61	15	36	129	108
Peak Hour Factor	0.95	0.95	0.95	0.95	0.95	0.95	0.95	0.95	0.95	0.95	0.95	0.95
Percent Heavy Veh, %	1	2	0	2	2	0	1	1	0	1	1	1
Cap, veh/h	446	1945	209	40	1635	143	463	186	46	176	184	145
Arrive On Green	0.26	1.00	1.00	0.02	0.50	0.49	0.13	0.13	0.13	0.10	0.10	0.10
Sat Flow, veh/h	3483	3235	347	1781	3300	289	3591	1442	354	1795	1885	1484
Grp Volume(v), veh/h	381	249	255	31	318	326	226	0	76	36	129	108
Grp Sat Flow(s),veh/h/ln	1742	1777	1806	1781	1777	1813	1795	0	1796	1795	1885	1484
Q Serve(g_s), s	11.5	0.0	0.0	1.9	12.1	12.2	6.4	0.0	4.2	2.0	7.3	7.8
Cycle Q Clear(g_c), s	11.5	0.0	0.0	1.9	12.1	12.2	6.4	0.0	4.2	2.0	7.3	7.8
Prop In Lane	1.00		0.19	1.00		0.16	1.00		0.20	1.00		1.00
Lane Grp Cap(c), veh/h	446	1068	1085	40	880	898	463	0	231	176	184	145
V/C Ratio(X)	0.85	0.23	0.24	0.78	0.36	0.36	0.49	0.00	0.33	0.20	0.70	0.74
Avail Cap(c_a), veh/h	570	1068	1085	97	880	898	914	0	457	277	291	229
HCM Platoon Ratio	2.00	2.00	2.00	1.00	1.00	1.00	1.00	1.00	1.00	1.00	1.00	1.00
Upstream Filter(I)	0.96	0.96	0.96	1.00	1.00	1.00	1.00	0.00	1.00	1.00	1.00	1.00
Uniform Delay (d), s/veh	39.9	0.0	0.0	53.5	17.1	17.1	44.5	0.0	43.6	45.7	48.1	48.3
Incr Delay (d2), s/veh	8.9	0.5	0.5	21.4	1.2	1.1	0.6	0.0	0.6	0.4	3.5	5.5
Initial Q Delay(d3),s/veh	0.0	0.0	0.0	0.0	0.0	0.0	0.0	0.0	0.0	0.0	0.0	0.0
%ile BackOfQ(50%),veh/ln	4.8	0.1	0.1	1.1	5.1	5.3	2.9	0.0	1.9	0.9	3.6	3.1
Unsig. Movement Delay, s/veh												
LnGrp Delay(d),s/veh	48.8	0.5	0.5	74.9	18.2	18.2	45.1	0.0	44.2	46.1	51.6	53.8
LnGrp LOS	D	A	A	E	B	B	D	A	D	D	D	D
Approach Vol, veh/h		885			675			302			273	
Approach Delay, s/veh		21.3			20.8			44.9			51.7	
Approach LOS		C			C			D			D	
Timer - Assigned Phs	1	2		4	5	6		8				
Phs Duration (G+Y+Rc), s	6.4	70.1		14.8	18.1	58.5		18.7				
Change Period (Y+Rc), s	4.0	4.5		4.5	4.0	4.5		4.5				
Max Green Setting (Gmax), s	6.0	42.0		16.5	18.0	30.0		28.0				
Max Q Clear Time (g_c+1), s	13.0	2.0		9.8	13.5	14.2		8.4				
Green Ext Time (p_c), s	0.0	3.4		0.5	0.6	3.7		1.0				

Intersection Summary

HCM 6th Ctrl Delay	28.4
HCM 6th LOS	C

Notes

User approved volume balancing among the lanes for turning movement.

Intersection						
Int Delay, s/veh	4.1					
Movement	WBL	WBR	NBT	NBR	SBL	SBT
Lane Configurations	↘	↗	↑	↗	↘	↑
Traffic Vol, veh/h	143	16	219	73	19	375
Future Vol, veh/h	143	16	219	73	19	375
Conflicting Peds, #/hr	2	0	0	5	5	0
Sign Control	Stop	Stop	Free	Free	Free	Free
RT Channelized	-	None	-	None	-	None
Storage Length	75	0	-	0	70	-
Veh in Median Storage, #	0	-	0	-	-	0
Grade, %	0	-	0	-	-	0
Peak Hour Factor	86	86	86	86	86	86
Heavy Vehicles, %	2	0	1	3	0	1
Mvmt Flow	166	19	255	85	22	436

Major/Minor	Minor1	Major1	Major2			
Conflicting Flow All	742	260	0	0	345	0
Stage 1	260	-	-	-	-	-
Stage 2	482	-	-	-	-	-
Critical Hdwy	6.42	6.2	-	-	4.1	-
Critical Hdwy Stg 1	5.42	-	-	-	-	-
Critical Hdwy Stg 2	5.42	-	-	-	-	-
Follow-up Hdwy	3.518	3.3	-	-	2.2	-
Pot Cap-1 Maneuver	383	784	-	-	1225	-
Stage 1	783	-	-	-	-	-
Stage 2	621	-	-	-	-	-
Platoon blocked, %			-	-	-	-
Mov Cap-1 Maneuver	374	781	-	-	1220	-
Mov Cap-2 Maneuver	374	-	-	-	-	-
Stage 1	780	-	-	-	-	-
Stage 2	609	-	-	-	-	-

Approach	WB	NB	SB
HCM Control Delay, s	20.9	0	0.4
HCM LOS	C		













Minor Lane/Major Mvmt	NBT	NBR	WBLn1	WBLn2	SBL	SBT
Capacity (veh/h)	-	-	374	781	1220	-
HCM Lane V/C Ratio	-	-	0.445	0.024	0.018	-
HCM Control Delay (s)	-	-	22.1	9.7	8	-
HCM Lane LOS	-	-	C	A	A	-
HCM 95th %tile Q(veh)	-	-	2.2	0.1	0.1	-

ID	Software/Method	Intersection	Control Type	LOS	Delay	V/C Ratio
1	Synchro HCM 6th Signal	I-5 SB Ramp & Wilsonville Rd	Signal	B	12.3	0.36
2	Synchro HCM 6th Signal	I-5 NB Ramp & Wilsonville Rd	Signal	B	15.0	0.45
3	Synchro HCM 6th Signal	Town Center Loop West & Wilsonville Rd	Signal	C	28.4	0.50

APPENDIX D: HCM REPORT – EXISTING + PROJECT

HCM 6th Signalized Intersection Summary
1: I-5 SB Ramp & Wilsonville Rd

Wilsonville Town Center Multifamily TIA
Existing + Project

												
Movement	EBL	EBT	EBR	WBL	WBT	WBR	NBL	NBT	NBR	SBL	SBT	SBR
Lane Configurations		↑↑↑	↗	↘↗	↑↑					↘	↗	↗↗
Traffic Volume (veh/h)	0	750	651	515	854	0	0	0	0	79	1	109
Future Volume (veh/h)	0	750	651	515	854	0	0	0	0	79	1	109
Initial Q (Qb), veh	0	0	0	0	0	0				0	0	0
Ped-Bike Adj(A_pbT)	1.00		1.00	1.00		1.00				1.00		0.99
Parking Bus, Adj	1.00	1.00	1.00	1.00	1.00	1.00				1.00	1.00	1.00
Work Zone On Approach		No			No						No	
Adj Sat Flow, veh/h/ln	0	1870	1870	1900	1856	0				1885	1900	1841
Adj Flow Rate, veh/h	0	789	0	542	899	0				84	0	12
Peak Hour Factor	0.95	0.95	0.95	0.95	0.95	0.95				0.95	0.95	0.95
Percent Heavy Veh, %	0	2	2	0	3	0				1	0	4
Cap, veh/h	0	3377		618	3080	0				192	0	165
Arrive On Green	0.00	1.00	0.00	0.35	1.00	0.00				0.05	0.00	0.05
Sat Flow, veh/h	0	5274	1585	3510	3618	0				3591	0	3091
Grp Volume(v), veh/h	0	789	0	542	899	0				84	0	12
Grp Sat Flow(s),veh/h/ln	0	1702	1585	1755	1763	0				1795	0	1546
Q Serve(g_s), s	0.0	0.0	0.0	15.9	0.0	0.0				2.5	0.0	0.4
Cycle Q Clear(g_c), s	0.0	0.0	0.0	15.9	0.0	0.0				2.5	0.0	0.4
Prop In Lane	0.00		1.00	1.00		0.00				1.00		1.00
Lane Grp Cap(c), veh/h	0	3377		618	3080	0				192	0	165
V/C Ratio(X)	0.00	0.23		0.88	0.29	0.00				0.44	0.00	0.07
Avail Cap(c_a), veh/h	0	3377		766	3080	0				620	0	534
HCM Platoon Ratio	1.00	2.00	2.00	2.00	2.00	1.00				1.00	1.00	1.00
Upstream Filter(I)	0.00	1.00	0.00	0.92	0.92	0.00				1.00	0.00	1.00
Uniform Delay (d), s/veh	0.0	0.0	0.0	34.5	0.0	0.0				50.5	0.0	49.5
Incr Delay (d2), s/veh	0.0	0.2	0.0	8.9	0.2	0.0				1.6	0.0	0.2
Initial Q Delay(d3),s/veh	0.0	0.0	0.0	0.0	0.0	0.0				0.0	0.0	0.0
%ile BackOfQ(50%),veh/ln	0.0	0.1	0.0	6.4	0.1	0.0				1.1	0.0	0.4
Unsig. Movement Delay, s/veh												
LnGrp Delay(d),s/veh	0.0	0.2	0.0	43.4	0.2	0.0				52.0	0.0	49.6
LnGrp LOS	A	A		D	A	A				D	A	D
Approach Vol, veh/h		789			1441						96	
Approach Delay, s/veh		0.2			16.5						51.7	
Approach LOS		A			B						D	
Timer - Assigned Phs	1	2		4		6						
Phs Duration (G+Y+Rc), s	23.4	76.7		9.9		100.1						
Change Period (Y+Rc), s	4.0	4.0		4.0		4.0						
Max Green Setting (Gmax), s	24.0	55.0		19.0		75.0						
Max Q Clear Time (g_c+I1), s	17.9	2.0		4.5		2.0						
Green Ext Time (p_c), s	1.5	4.5		0.2		5.4						

Intersection Summary

HCM 6th Ctrl Delay	12.4
HCM 6th LOS	B

Notes

User approved volume balancing among the lanes for turning movement.
Unsignalized Delay for [EBR] is excluded from calculations of the approach delay and intersection delay.

HCM 6th Signalized Intersection Summary
 2: I-5 NB Ramp & Wilsonville Rd

Wilsonville Town Center Multifamily TIA
 Existing + Project



Movement	EBL	EBT	EBR	WBL	WBT	WBR	NBL	NBT	NBR	SBL	SBT	SBR
Lane Configurations	↔↔	↑↑			↑↑↑	↔	↔	↔	↔↔			
Traffic Volume (veh/h)	288	541	0	0	1029	316	340	2	409	0	0	0
Future Volume (veh/h)	288	541	0	0	1029	316	340	2	409	0	0	0
Initial Q (Qb), veh	0	0	0	0	0	0	0	0	0			
Ped-Bike Adj(A_pbT)	1.00		1.00	1.00		1.00	1.00		0.97			
Parking Bus, Adj	1.00	1.00	1.00	1.00	1.00	1.00	1.00	1.00	1.00			
Work Zone On Approach		No			No			No				
Adj Sat Flow, veh/h/ln	1870	1870	0	0	1885	1870	1841	1900	1885			
Adj Flow Rate, veh/h	310	582	0	0	1106	0	367	0	136			
Peak Hour Factor	0.93	0.93	0.93	0.93	0.93	0.93	0.93	0.93	0.93			
Percent Heavy Veh, %	2	2	0	0	1	2	4	0	1			
Cap, veh/h	382	2819	0	0	3327		470	0	414			
Arrive On Green	0.22	1.00	0.00	0.00	1.00	0.00	0.13	0.00	0.13			
Sat Flow, veh/h	3456	3647	0	0	5316	1585	3506	0	3090			
Grp Volume(v), veh/h	310	582	0	0	1106	0	367	0	136			
Grp Sat Flow(s),veh/h/ln	1728	1777	0	0	1716	1585	1753	0	1545			
Q Serve(g_s), s	9.4	0.0	0.0	0.0	0.0	0.0	11.1	0.0	4.4			
Cycle Q Clear(g_c), s	9.4	0.0	0.0	0.0	0.0	0.0	11.1	0.0	4.4			
Prop In Lane	1.00		0.00	0.00		1.00	1.00		1.00			
Lane Grp Cap(c), veh/h	382	2819	0	0	3327		470	0	414			
V/C Ratio(X)	0.81	0.21	0.00	0.00	0.33		0.78	0.00	0.33			
Avail Cap(c_a), veh/h	691	2819	0	0	3327		956	0	843			
HCM Platoon Ratio	2.00	2.00	1.00	1.00	2.00	2.00	1.00	1.00	1.00			
Upstream Filter(I)	0.98	0.98	0.00	0.00	0.71	0.00	1.00	0.00	1.00			
Uniform Delay (d), s/veh	41.8	0.0	0.0	0.0	0.0	0.0	46.1	0.0	43.1			
Incr Delay (d2), s/veh	2.6	0.2	0.0	0.0	0.2	0.0	1.8	0.0	0.3			
Initial Q Delay(d3),s/veh	0.0	0.0	0.0	0.0	0.0	0.0	0.0	0.0	0.0			
%ile BackOfQ(50%),veh/ln	3.7	0.1	0.0	0.0	0.1	0.0	4.8	0.0	1.6			
Unsig. Movement Delay, s/veh												
LnGrp Delay(d),s/veh	44.3	0.2	0.0	0.0	0.2	0.0	47.8	0.0	43.4			
LnGrp LOS	D	A	A	A	A		D	A	D			
Approach Vol, veh/h		892			1106			503				
Approach Delay, s/veh		15.5			0.2			46.6				
Approach LOS		B			A			D				
Timer - Assigned Phs		2			5	6		8				
Phs Duration (G+Y+Rc), s		91.3			16.2	75.1		18.7				
Change Period (Y+Rc), s		4.0			4.0	4.0		4.0				
Max Green Setting (Gmax), s		55.0			22.0	46.0		30.0				
Max Q Clear Time (g_c+I1), s		2.0			11.4	2.0		13.1				
Green Ext Time (p_c), s		6.8			0.8	15.1		1.5				

Intersection Summary

HCM 6th Ctrl Delay	15.0
HCM 6th LOS	B

Notes

User approved volume balancing among the lanes for turning movement.
 Unsignalized Delay for [WBR] is excluded from calculations of the approach delay and intersection delay.

HCM 6th Signalized Intersection Summary
 3: Town Center Loop West & Wilsonville Rd

Wilsonville Town Center Multifamily TIA
 Existing + Project



Movement	EBL	EBT	EBR	WBL	WBT	WBR	NBL	NBT	NBR	SBL	SBT	SBR
Lane Configurations	↔↔	↕↔		↔	↕↔		↔	↕↔		↔	↕↔	↔
Traffic Volume (veh/h)	378	432	52	29	562	58	215	58	29	38	61	568
Future Volume (veh/h)	378	432	52	29	562	58	215	58	29	38	61	568
Initial Q (Qb), veh	0	0	0	0	0	0	0	0	0	0	0	0
Ped-Bike Adj(A_pbT)	1.00		0.99	1.00		0.98	1.00		0.94	1.00		0.93
Parking Bus, Adj	1.00	1.00	1.00	1.00	1.00	1.00	1.00	1.00	1.00	1.00	1.00	1.00
Work Zone On Approach		No			No			No			No	
Adj Sat Flow, veh/h/ln	1885	1870	1900	1870	1870	1900	1885	1885	1900	1885	1885	1885
Adj Flow Rate, veh/h	398	455	49	31	592	55	226	61	15	40	131	109
Peak Hour Factor	0.95	0.95	0.95	0.95	0.95	0.95	0.95	0.95	0.95	0.95	0.95	0.95
Percent Heavy Veh, %	1	2	0	2	2	0	1	1	0	1	1	1
Cap, veh/h	461	1942	208	40	1609	149	463	186	46	177	186	146
Arrive On Green	0.26	1.00	1.00	0.02	0.49	0.49	0.13	0.13	0.13	0.10	0.10	0.10
Sat Flow, veh/h	3483	3235	347	1781	3282	304	3591	1442	354	1795	1885	1485
Grp Volume(v), veh/h	398	249	255	31	320	327	226	0	76	40	131	109
Grp Sat Flow(s),veh/h/ln	1742	1777	1806	1781	1777	1809	1795	0	1796	1795	1885	1485
Q Serve(g_s), s	12.0	0.0	0.0	1.9	12.3	12.4	6.4	0.0	4.2	2.3	7.4	7.9
Cycle Q Clear(g_c), s	12.0	0.0	0.0	1.9	12.3	12.4	6.4	0.0	4.2	2.3	7.4	7.9
Prop In Lane	1.00		0.19	1.00		0.17	1.00		0.20	1.00		1.00
Lane Grp Cap(c), veh/h	461	1067	1084	40	871	887	463	0	231	177	186	146
V/C Ratio(X)	0.86	0.23	0.24	0.78	0.37	0.37	0.49	0.00	0.33	0.23	0.70	0.74
Avail Cap(c_a), veh/h	570	1067	1084	97	871	887	914	0	457	277	291	229
HCM Platoon Ratio	2.00	2.00	2.00	1.00	1.00	1.00	1.00	1.00	1.00	1.00	1.00	1.00
Upstream Filter(I)	0.96	0.96	0.96	1.00	1.00	1.00	1.00	0.00	1.00	1.00	1.00	1.00
Uniform Delay (d), s/veh	39.5	0.0	0.0	53.5	17.4	17.5	44.5	0.0	43.6	45.7	48.0	48.2
Incr Delay (d2), s/veh	10.0	0.5	0.5	21.4	1.2	1.2	0.6	0.0	0.6	0.5	3.6	5.5
Initial Q Delay(d3),s/veh	0.0	0.0	0.0	0.0	0.0	0.0	0.0	0.0	0.0	0.0	0.0	0.0
%ile BackOfQ(50%),veh/ln	5.1	0.1	0.1	1.1	5.2	5.4	2.9	0.0	1.9	1.0	3.7	3.1
Unsig. Movement Delay, s/veh												
LnGrp Delay(d),s/veh	49.5	0.5	0.5	74.9	18.6	18.7	45.1	0.0	44.2	46.2	51.6	53.7
LnGrp LOS	D	A	A	E	B	B	D	A	D	D	D	D
Approach Vol, veh/h		902			678			302			280	
Approach Delay, s/veh		22.1			21.2			44.9			51.7	
Approach LOS		C			C			D			D	
Timer - Assigned Phs	1	2		4	5	6		8				
Phs Duration (G+Y+Rc), s	6.4	70.0		14.8	18.6	57.9		18.7				
Change Period (Y+Rc), s	4.0	4.5		4.5	4.0	4.5		4.5				
Max Green Setting (Gmax), s	6.0	42.0		16.5	18.0	30.0		28.0				
Max Q Clear Time (g_c+1), s	13.0	2.0		9.9	14.0	14.4		8.4				
Green Ext Time (p_c), s	0.0	3.4		0.5	0.6	3.7		1.0				

Intersection Summary

HCM 6th Ctrl Delay	28.8
HCM 6th LOS	C

Notes

User approved volume balancing among the lanes for turning movement.

Intersection						
Int Delay, s/veh	4.3					
Movement	WBL	WBR	NBT	NBR	SBL	SBT
Lane Configurations	↘	↗	↑	↗	↘	↑
Traffic Vol, veh/h	143	19	239	73	21	391
Future Vol, veh/h	143	19	239	73	21	391
Conflicting Peds, #/hr	2	0	0	5	5	0
Sign Control	Stop	Stop	Free	Free	Free	Free
RT Channelized	-	None	-	None	-	None
Storage Length	75	0	-	0	70	-
Veh in Median Storage, #	0	-	0	-	-	0
Grade, %	0	-	0	-	-	0
Peak Hour Factor	86	86	86	86	86	86
Heavy Vehicles, %	2	0	1	3	0	1
Mvmt Flow	166	22	278	85	24	455

Major/Minor	Minor1	Major1	Major2			
Conflicting Flow All	788	283	0	0	368	0
Stage 1	283	-	-	-	-	-
Stage 2	505	-	-	-	-	-
Critical Hdwy	6.42	6.2	-	-	4.1	-
Critical Hdwy Stg 1	5.42	-	-	-	-	-
Critical Hdwy Stg 2	5.42	-	-	-	-	-
Follow-up Hdwy	3.518	3.3	-	-	2.2	-
Pot Cap-1 Maneuver	360	761	-	-	1202	-
Stage 1	765	-	-	-	-	-
Stage 2	606	-	-	-	-	-
Platoon blocked, %			-	-		-
Mov Cap-1 Maneuver	351	758	-	-	1197	-
Mov Cap-2 Maneuver	351	-	-	-	-	-
Stage 1	762	-	-	-	-	-
Stage 2	593	-	-	-	-	-

Approach	WB	NB	SB
HCM Control Delay, s	22.5	0	0.4
HCM LOS	C		

Minor Lane/Major Mvmt	NBT	NBR	WBLn1	WBLn2	SBL	SBT
Capacity (veh/h)	-	-	351	758	1197	-
HCM Lane V/C Ratio	-	-	0.474	0.029	0.02	-
HCM Control Delay (s)	-	-	24.2	9.9	8.1	-
HCM Lane LOS	-	-	C	A	A	-
HCM 95th %tile Q(veh)	-	-	2.4	0.1	0.1	-

Intersection												
Int Delay, s/veh	1.1											
Movement	EBL	EBT	EBR	WBL	WBT	WBR	NBL	NBT	NBR	SBL	SBT	SBR
Lane Configurations		↕			↕		↕	↕			↕	
Traffic Vol, veh/h	8	0	14	18	0	6	4	231	23	8	380	4
Future Vol, veh/h	8	0	14	18	0	6	4	231	23	8	380	4
Conflicting Peds, #/hr	0	0	0	0	0	0	0	0	0	0	0	0
Sign Control	Stop	Stop	Stop	Stop	Stop	Stop	Free	Free	Free	Free	Free	Free
RT Channelized	-	-	None	-	-	None	-	-	None	-	-	None
Storage Length	-	-	-	-	-	-	60	-	-	-	-	-
Veh in Median Storage, #	-	0	-	-	0	-	-	0	-	-	0	-
Grade, %	-	0	-	-	0	-	-	0	-	-	0	-
Peak Hour Factor	83	83	83	83	83	83	83	83	83	83	83	83
Heavy Vehicles, %	0	0	0	0	0	0	0	1	0	0	1	0
Mvmt Flow	10	0	17	22	0	7	5	278	28	10	458	5

Major/Minor	Minor2		Minor1		Major1			Major2				
Conflicting Flow All	787	797	461	791	785	292	463	0	0	306	0	0
Stage 1	481	481	-	302	302	-	-	-	-	-	-	-
Stage 2	306	316	-	489	483	-	-	-	-	-	-	-
Critical Hdwy	7.1	6.5	6.2	7.1	6.5	6.2	4.1	-	-	4.1	-	-
Critical Hdwy Stg 1	6.1	5.5	-	6.1	5.5	-	-	-	-	-	-	-
Critical Hdwy Stg 2	6.1	5.5	-	6.1	5.5	-	-	-	-	-	-	-
Follow-up Hdwy	3.5	4	3.3	3.5	4	3.3	2.2	-	-	2.2	-	-
Pot Cap-1 Maneuver	312	322	605	310	327	752	1109	-	-	1266	-	-
Stage 1	570	557	-	712	668	-	-	-	-	-	-	-
Stage 2	708	659	-	564	556	-	-	-	-	-	-	-
Platoon blocked, %								-	-	-	-	-
Mov Cap-1 Maneuver	305	317	605	298	322	752	1109	-	-	1266	-	-
Mov Cap-2 Maneuver	305	317	-	298	322	-	-	-	-	-	-	-
Stage 1	567	551	-	708	665	-	-	-	-	-	-	-
Stage 2	698	656	-	542	550	-	-	-	-	-	-	-

Approach	EB		WB		NB			SB		
HCM Control Delay, s	13.6		16.2		0.1			0.2		
HCM LOS	B		C							













Minor Lane/Major Mvmt	NBL	NBT	NBR	EBLn1	WBLn1	SBL	SBT	SBR
Capacity (veh/h)	1109	-	-	446	351	1266	-	-
HCM Lane V/C Ratio	0.004	-	-	0.059	0.082	0.008	-	-
HCM Control Delay (s)	8.3	-	-	13.6	16.2	7.9	0	-
HCM Lane LOS	A	-	-	B	C	A	A	-
HCM 95th %tile Q(veh)	0	-	-	0.2	0.3	0	-	-

ID	Software/Method	Intersection	Control Type	LOS	Delay	V/C Ratio
1	Synchro HCM 6th Signal	I-5 SB Ramp & Wilsonville Rd	Signal	B	12.4	0.37
2	Synchro HCM 6th Signal	I-5 NB Ramp & Wilsonville Rd	Signal	B	15.0	0.45
3	Synchro HCM 6th Signal	Town Center Loop West & Wilsonville Rd	Signal	C	28.8	0.50

APPENDIX E: HCM REPORT – EXISTING + STAGE II

HCM 6th Signalized Intersection Summary
1: I-5 SB Ramp & Wilsonville Rd

Wilsonville Town Center Multifamily TIA
Existing + Stage II

												
Movement	EBL	EBT	EBR	WBL	WBT	WBR	NBL	NBT	NBR	SBL	SBT	SBR
Lane Configurations		↑↑↑	↗	↘↗	↑↑					↘	↗	↗↗
Traffic Volume (veh/h)	0	825	696	519	897	0	0	0	0	75	1	135
Future Volume (veh/h)	0	825	696	519	897	0	0	0	0	75	1	135
Initial Q (Qb), veh	0	0	0	0	0	0				0	0	0
Ped-Bike Adj(A_pbT)	1.00		1.00	1.00		1.00				1.00		0.99
Parking Bus, Adj	1.00	1.00	1.00	1.00	1.00	1.00				1.00	1.00	1.00
Work Zone On Approach		No			No						No	
Adj Sat Flow, veh/h/ln	0	1870	1870	1900	1856	0				1885	1900	1841
Adj Flow Rate, veh/h	0	868	0	546	944	0				80	0	39
Peak Hour Factor	0.95	0.95	0.95	0.95	0.95	0.95				0.95	0.95	0.95
Percent Heavy Veh, %	0	2	2	0	3	0				1	0	4
Cap, veh/h	0	3364		622	3075	0				197	0	170
Arrive On Green	0.00	1.00	0.00	0.35	1.00	0.00				0.05	0.00	0.05
Sat Flow, veh/h	0	5274	1585	3510	3618	0				3591	0	3091
Grp Volume(v), veh/h	0	868	0	546	944	0				80	0	39
Grp Sat Flow(s),veh/h/ln	0	1702	1585	1755	1763	0				1795	0	1546
Q Serve(g_s), s	0.0	0.0	0.0	16.0	0.0	0.0				2.4	0.0	1.3
Cycle Q Clear(g_c), s	0.0	0.0	0.0	16.0	0.0	0.0				2.4	0.0	1.3
Prop In Lane	0.00		1.00	1.00		0.00				1.00		1.00
Lane Grp Cap(c), veh/h	0	3364		622	3075	0				197	0	170
V/C Ratio(X)	0.00	0.26		0.88	0.31	0.00				0.41	0.00	0.23
Avail Cap(c_a), veh/h	0	3364		766	3075	0				620	0	534
HCM Platoon Ratio	1.00	2.00	2.00	2.00	2.00	1.00				1.00	1.00	1.00
Upstream Filter(I)	0.00	1.00	0.00	0.90	0.90	0.00				1.00	0.00	1.00
Uniform Delay (d), s/veh	0.0	0.0	0.0	34.4	0.0	0.0				50.2	0.0	49.7
Incr Delay (d2), s/veh	0.0	0.2	0.0	8.9	0.2	0.0				1.3	0.0	0.7
Initial Q Delay(d3),s/veh	0.0	0.0	0.0	0.0	0.0	0.0				0.0	0.0	0.0
%ile BackOfQ(50%),veh/ln	0.0	0.1	0.0	6.5	0.1	0.0				1.1	0.0	1.2
Unsig. Movement Delay, s/veh												
LnGrp Delay(d),s/veh	0.0	0.2	0.0	43.3	0.2	0.0				51.6	0.0	50.4
LnGrp LOS	A	A		D	A	A				D	A	D
Approach Vol, veh/h		868			1490						119	
Approach Delay, s/veh		0.2			16.0						51.2	
Approach LOS		A			B						D	
Timer - Assigned Phs	1	2		4		6						
Phs Duration (G+Y+Rc), s	23.5	76.5		10.0		100.0						
Change Period (Y+Rc), s	4.0	4.0		4.0		4.0						
Max Green Setting (Gmax), s	24.0	55.0		19.0		75.0						
Max Q Clear Time (g_c+I1), s	18.0	2.0		4.4		2.0						
Green Ext Time (p_c), s	1.4	5.1		0.3		5.7						

Intersection Summary

HCM 6th Ctrl Delay	12.2
HCM 6th LOS	B

Notes

User approved volume balancing among the lanes for turning movement.
Unsignalized Delay for [EBR] is excluded from calculations of the approach delay and intersection delay.

HCM 6th Signalized Intersection Summary
2: I-5 NB Ramp & Wilsonville Rd

Wilsonville Town Center Multifamily TIA
Existing + Stage II



Movement	EBL	EBT	EBR	WBL	WBT	WBR	NBL	NBT	NBR	SBL	SBT	SBR
Lane Configurations	↔↔	↑↑			↑↑↑	↔	↔	↔	↔↔			
Traffic Volume (veh/h)	337	563	0	0	1043	313	373	2	415	0	0	0
Future Volume (veh/h)	337	563	0	0	1043	313	373	2	415	0	0	0
Initial Q (Qb), veh	0	0	0	0	0	0	0	0	0			
Ped-Bike Adj(A_pbT)	1.00		1.00	1.00		1.00	1.00		0.97			
Parking Bus, Adj	1.00	1.00	1.00	1.00	1.00	1.00	1.00	1.00	1.00			
Work Zone On Approach		No			No			No				
Adj Sat Flow, veh/h/ln	1870	1870	0	0	1885	1870	1841	1900	1885			
Adj Flow Rate, veh/h	362	605	0	0	1122	0	402	0	165			
Peak Hour Factor	0.93	0.93	0.93	0.93	0.93	0.93	0.93	0.93	0.93			
Percent Heavy Veh, %	2	2	0	0	1	2	4	0	1			
Cap, veh/h	433	2780	0	0	3194		508	0	448			
Arrive On Green	0.25	1.00	0.00	0.00	1.00	0.00	0.14	0.00	0.14			
Sat Flow, veh/h	3456	3647	0	0	5316	1585	3506	0	3093			
Grp Volume(v), veh/h	362	605	0	0	1122	0	402	0	165			
Grp Sat Flow(s),veh/h/ln	1728	1777	0	0	1716	1585	1753	0	1547			
Q Serve(g_s), s	10.9	0.0	0.0	0.0	0.0	0.0	12.2	0.0	5.3			
Cycle Q Clear(g_c), s	10.9	0.0	0.0	0.0	0.0	0.0	12.2	0.0	5.3			
Prop In Lane	1.00		0.00	0.00		1.00	1.00		1.00			
Lane Grp Cap(c), veh/h	433	2780	0	0	3194		508	0	448			
V/C Ratio(X)	0.84	0.22	0.00	0.00	0.35		0.79	0.00	0.37			
Avail Cap(c_a), veh/h	691	2780	0	0	3194		956	0	844			
HCM Platoon Ratio	2.00	2.00	1.00	1.00	2.00	2.00	1.00	1.00	1.00			
Upstream Filter(I)	0.97	0.97	0.00	0.00	0.70	0.00	1.00	0.00	1.00			
Uniform Delay (d), s/veh	40.1	0.0	0.0	0.0	0.0	0.0	45.4	0.0	42.5			
Incr Delay (d2), s/veh	3.4	0.2	0.0	0.0	0.2	0.0	1.7	0.0	0.3			
Initial Q Delay(d3),s/veh	0.0	0.0	0.0	0.0	0.0	0.0	0.0	0.0	0.0			
%ile BackOfQ(50%),veh/ln	4.3	0.1	0.0	0.0	0.1	0.0	5.2	0.0	2.0			
Unsig. Movement Delay, s/veh												
LnGrp Delay(d),s/veh	43.5	0.2	0.0	0.0	0.2	0.0	47.2	0.0	42.8			
LnGrp LOS	D	A	A	A	A		D	A	D			
Approach Vol, veh/h		967			1122			567				
Approach Delay, s/veh		16.4			0.2			45.9				
Approach LOS		B			A			D				
Timer - Assigned Phs		2			5	6		8				
Phs Duration (G+Y+Rc), s		90.1			17.8	72.3		19.9				
Change Period (Y+Rc), s		4.0			4.0	4.0		4.0				
Max Green Setting (Gmax), s		55.0			22.0	46.0		30.0				
Max Q Clear Time (g_c+1), s		2.0			12.9	2.0		14.2				
Green Ext Time (p_c), s		7.1			0.9	15.4		1.7				

Intersection Summary

HCM 6th Ctrl Delay	15.9
HCM 6th LOS	B

Notes

User approved volume balancing among the lanes for turning movement.
Unsignalized Delay for [WBR] is excluded from calculations of the approach delay and intersection delay.

HCM 6th Signalized Intersection Summary
 3: Town Center Loop West & Wilsonville Rd

Wilsonville Town Center Multifamily TIA
 Existing + Stage II



Movement	EBL	EBT	EBR	WBL	WBT	WBR	NBL	NBT	NBR	SBL	SBT	SBR
Lane Configurations	↔↔	↕↔		↔	↕↔		↔	↕↔		↔	↕↔	↔
Traffic Volume (veh/h)	381	457	52	29	574	56	215	60	29	35	63	567
Future Volume (veh/h)	381	457	52	29	574	56	215	60	29	35	63	567
Initial Q (Qb), veh	0	0	0	0	0	0	0	0	0	0	0	0
Ped-Bike Adj(A_pbT)	1.00		0.99	1.00		0.98	1.00		0.94	1.00		0.93
Parking Bus, Adj	1.00	1.00	1.00	1.00	1.00	1.00	1.00	1.00	1.00	1.00	1.00	1.00
Work Zone On Approach		No			No			No			No	
Adj Sat Flow, veh/h/ln	1885	1870	1900	1870	1870	1900	1885	1885	1900	1885	1885	1885
Adj Flow Rate, veh/h	401	481	49	31	604	53	226	63	16	37	137	113
Peak Hour Factor	0.95	0.95	0.95	0.95	0.95	0.95	0.95	0.95	0.95	0.95	0.95	0.95
Percent Heavy Veh, %	1	2	0	2	2	0	1	1	0	1	1	1
Cap, veh/h	464	1946	197	40	1606	141	463	184	47	182	191	150
Arrive On Green	0.27	1.00	1.00	0.02	0.49	0.48	0.13	0.13	0.13	0.10	0.10	0.10
Sat Flow, veh/h	3483	3255	330	1781	3300	289	3591	1431	363	1795	1885	1487
Grp Volume(v), veh/h	401	262	268	31	325	332	226	0	79	37	137	113
Grp Sat Flow(s),veh/h/ln	1742	1777	1809	1781	1777	1813	1795	0	1794	1795	1885	1487
Q Serve(g_s), s	12.1	0.0	0.0	1.9	12.6	12.7	6.4	0.0	4.4	2.1	7.7	8.1
Cycle Q Clear(g_c), s	12.1	0.0	0.0	1.9	12.6	12.7	6.4	0.0	4.4	2.1	7.7	8.1
Prop In Lane	1.00		0.18	1.00		0.16	1.00		0.20	1.00		1.00
Lane Grp Cap(c), veh/h	464	1062	1081	40	865	882	463	0	231	182	191	150
V/C Ratio(X)	0.86	0.25	0.25	0.78	0.38	0.38	0.49	0.00	0.34	0.20	0.72	0.75
Avail Cap(c_a), veh/h	570	1062	1081	97	865	882	914	0	457	277	291	230
HCM Platoon Ratio	2.00	2.00	2.00	1.00	1.00	1.00	1.00	1.00	1.00	1.00	1.00	1.00
Upstream Filter(I)	0.96	0.96	0.96	1.00	1.00	1.00	1.00	0.00	1.00	1.00	1.00	1.00
Uniform Delay (d), s/veh	39.4	0.0	0.0	53.5	17.7	17.8	44.5	0.0	43.7	45.4	47.9	48.1
Incr Delay (d2), s/veh	10.2	0.5	0.5	21.4	1.2	1.2	0.6	0.0	0.6	0.4	3.8	5.5
Initial Q Delay(d3),s/veh	0.0	0.0	0.0	0.0	0.0	0.0	0.0	0.0	0.0	0.0	0.0	0.0
%ile BackOfQ(50%),veh/ln	5.1	0.2	0.2	1.1	5.4	5.5	2.9	0.0	2.0	0.9	3.8	3.2
Unsig. Movement Delay, s/veh												
LnGrp Delay(d),s/veh	49.6	0.5	0.5	74.9	19.0	19.0	45.1	0.0	44.3	45.8	51.7	53.6
LnGrp LOS	D	A	A	E	B	B	D	A	D	D	D	D
Approach Vol, veh/h		931			688			305			287	
Approach Delay, s/veh		21.7			21.5			44.9			51.7	
Approach LOS		C			C			D			D	
Timer - Assigned Phs	1	2		4	5	6		8				
Phs Duration (G+Y+Rc), s	6.4	69.8		15.1	18.7	57.5		18.7				
Change Period (Y+Rc), s	4.0	4.5		4.5	4.0	4.5		4.5				
Max Green Setting (Gmax), s	6.0	42.0		16.5	18.0	30.0		28.0				
Max Q Clear Time (g_c+1/3), s	13.0	2.0		10.1	14.1	14.7		8.4				
Green Ext Time (p_c), s	0.0	3.6		0.5	0.6	3.7		1.0				

Intersection Summary

HCM 6th Ctrl Delay	28.7
HCM 6th LOS	C

Notes

User approved volume balancing among the lanes for turning movement.

Intersection						
Int Delay, s/veh	4.3					
Movement	WBL	WBR	NBT	NBR	SBL	SBT
Lane Configurations	↘	↗	↑	↗	↘	↑
Traffic Vol, veh/h	143	18	241	74	22	389
Future Vol, veh/h	143	18	241	74	22	389
Conflicting Peds, #/hr	2	0	0	5	5	0
Sign Control	Stop	Stop	Free	Free	Free	Free
RT Channelized	-	None	-	None	-	None
Storage Length	75	0	-	0	70	-
Veh in Median Storage, #	0	-	0	-	-	0
Grade, %	0	-	0	-	-	0
Peak Hour Factor	86	86	86	86	86	86
Heavy Vehicles, %	2	0	1	3	0	1
Mvmt Flow	166	21	280	86	26	452

Major/Minor	Minor1	Major1	Major2			
Conflicting Flow All	791	285	0	0	371	0
Stage 1	285	-	-	-	-	-
Stage 2	506	-	-	-	-	-
Critical Hdwy	6.42	6.2	-	-	4.1	-
Critical Hdwy Stg 1	5.42	-	-	-	-	-
Critical Hdwy Stg 2	5.42	-	-	-	-	-
Follow-up Hdwy	3.518	3.3	-	-	2.2	-
Pot Cap-1 Maneuver	358	759	-	-	1199	-
Stage 1	763	-	-	-	-	-
Stage 2	606	-	-	-	-	-
Platoon blocked, %			-	-		-
Mov Cap-1 Maneuver	348	756	-	-	1194	-
Mov Cap-2 Maneuver	348	-	-	-	-	-
Stage 1	760	-	-	-	-	-
Stage 2	591	-	-	-	-	-

Approach	WB	NB	SB
HCM Control Delay, s	22.9	0	0.4
HCM LOS	C		













Minor Lane/Major Mvmt	NBT	NBR	WBLn1	WBLn2	SBL	SBT
Capacity (veh/h)	-	-	348	756	1194	-
HCM Lane V/C Ratio	-	-	0.478	0.028	0.021	-
HCM Control Delay (s)	-	-	24.5	9.9	8.1	-
HCM Lane LOS	-	-	C	A	A	-
HCM 95th %tile Q(veh)	-	-	2.5	0.1	0.1	-

ID	Software/Method	Intersection	Control Type	LOS	Delay	V/C Ratio
1	Synchro HCM 6th Signal	I-5 SB Ramp & Wilsonville Rd	Signal	B	12.2	0.38
2	Synchro HCM 6th Signal	I-5 NB Ramp & Wilsonville Rd	Signal	B	15.9	0.48
3	Synchro HCM 6th Signal	Town Center Loop West & Wilsonville Rd	Signal	C	28.7	0.51

APPENDIX F: HCM REPORT – EXISTING + PROJECT + STAGE II

HCM 6th Signalized Intersection Summary
1: I-5 SB Ramp & Wilsonville Rd

Wilsonville Town Center Multifamily TIA
Existing + Project + Stage II

												
Movement	EBL	EBT	EBR	WBL	WBT	WBR	NBL	NBT	NBR	SBL	SBT	SBR
Lane Configurations		↑↑↑	↗	↘↗	↑↑					↘	↗	↗↗
Traffic Volume (veh/h)	0	830	696	521	901	0	0	0	0	83	1	135
Future Volume (veh/h)	0	830	696	521	901	0	0	0	0	83	1	135
Initial Q (Qb), veh	0	0	0	0	0	0				0	0	0
Ped-Bike Adj(A_pbT)	1.00		1.00	1.00		1.00				1.00		0.99
Parking Bus, Adj	1.00	1.00	1.00	1.00	1.00	1.00				1.00	1.00	1.00
Work Zone On Approach		No			No						No	
Adj Sat Flow, veh/h/ln	0	1870	1870	1900	1856	0				1885	1900	1841
Adj Flow Rate, veh/h	0	874	0	548	948	0				88	0	39
Peak Hour Factor	0.95	0.95	0.95	0.95	0.95	0.95				0.95	0.95	0.95
Percent Heavy Veh, %	0	2	2	0	3	0				1	0	4
Cap, veh/h	0	3360		623	3074	0				198	0	171
Arrive On Green	0.00	1.00	0.00	0.36	1.00	0.00				0.06	0.00	0.06
Sat Flow, veh/h	0	5274	1585	3510	3618	0				3591	0	3092
Grp Volume(v), veh/h	0	874	0	548	948	0				88	0	39
Grp Sat Flow(s),veh/h/ln	0	1702	1585	1755	1763	0				1795	0	1546
Q Serve(g_s), s	0.0	0.0	0.0	16.1	0.0	0.0				2.6	0.0	1.3
Cycle Q Clear(g_c), s	0.0	0.0	0.0	16.1	0.0	0.0				2.6	0.0	1.3
Prop In Lane	0.00		1.00	1.00		0.00				1.00		1.00
Lane Grp Cap(c), veh/h	0	3360		623	3074	0				198	0	171
V/C Ratio(X)	0.00	0.26		0.88	0.31	0.00				0.44	0.00	0.23
Avail Cap(c_a), veh/h	0	3360		766	3074	0				620	0	534
HCM Platoon Ratio	1.00	2.00	2.00	2.00	2.00	1.00				1.00	1.00	1.00
Upstream Filter(I)	0.00	1.00	0.00	0.90	0.90	0.00				1.00	0.00	1.00
Uniform Delay (d), s/veh	0.0	0.0	0.0	34.4	0.0	0.0				50.3	0.0	49.7
Incr Delay (d2), s/veh	0.0	0.2	0.0	9.0	0.2	0.0				1.6	0.0	0.7
Initial Q Delay(d3),s/veh	0.0	0.0	0.0	0.0	0.0	0.0				0.0	0.0	0.0
%ile BackOfQ(50%),veh/ln	0.0	0.1	0.0	6.5	0.1	0.0				1.2	0.0	1.2
Unsig. Movement Delay, s/veh												
LnGrp Delay(d),s/veh	0.0	0.2	0.0	43.3	0.2	0.0				51.9	0.0	50.4
LnGrp LOS	A	A		D	A	A				D	A	D
Approach Vol, veh/h		874			1496						127	
Approach Delay, s/veh		0.2			16.0						51.4	
Approach LOS		A			B						D	
Timer - Assigned Phs	1	2		4		6						
Phs Duration (G+Y+Rc), s	23.5	76.4		10.1		99.9						
Change Period (Y+Rc), s	4.0	4.0		4.0		4.0						
Max Green Setting (Gmax), s	24.0	55.0		19.0		75.0						
Max Q Clear Time (g_c+I1), s	18.1	2.0		4.6		2.0						
Green Ext Time (p_c), s	1.4	5.1		0.4		5.8						

Intersection Summary

HCM 6th Ctrl Delay	12.3
HCM 6th LOS	B

Notes

User approved volume balancing among the lanes for turning movement.
Unsignalized Delay for [EBR] is excluded from calculations of the approach delay and intersection delay.

HCM 6th Signalized Intersection Summary
 2: I-5 NB Ramp & Wilsonville Rd

Wilsonville Town Center Multifamily TIA
 Existing + Project + Stage II



Movement	EBL	EBT	EBR	WBL	WBT	WBR	NBL	NBT	NBR	SBL	SBT	SBR
Lane Configurations	↔↔	↑↑			↑↑↑	↔	↔	↔	↔↔			
Traffic Volume (veh/h)	337	576	0	0	1049	319	373	2	418	0	0	0
Future Volume (veh/h)	337	576	0	0	1049	319	373	2	418	0	0	0
Initial Q (Qb), veh	0	0	0	0	0	0	0	0	0			
Ped-Bike Adj(A_pbT)	1.00		1.00	1.00		1.00	1.00		0.97			
Parking Bus, Adj	1.00	1.00	1.00	1.00	1.00	1.00	1.00	1.00	1.00			
Work Zone On Approach		No			No			No				
Adj Sat Flow, veh/h/ln	1870	1870	0	0	1885	1870	1841	1900	1885			
Adj Flow Rate, veh/h	362	619	0	0	1128	0	402	0	178			
Peak Hour Factor	0.93	0.93	0.93	0.93	0.93	0.93	0.93	0.93	0.93			
Percent Heavy Veh, %	2	2	0	0	1	2	4	0	1			
Cap, veh/h	433	2779	0	0	3192		509	0	449			
Arrive On Green	0.25	1.00	0.00	0.00	1.00	0.00	0.15	0.00	0.15			
Sat Flow, veh/h	3456	3647	0	0	5316	1585	3506	0	3094			
Grp Volume(v), veh/h	362	619	0	0	1128	0	402	0	178			
Grp Sat Flow(s),veh/h/ln	1728	1777	0	0	1716	1585	1753	0	1547			
Q Serve(g_s), s	10.9	0.0	0.0	0.0	0.0	0.0	12.2	0.0	5.7			
Cycle Q Clear(g_c), s	10.9	0.0	0.0	0.0	0.0	0.0	12.2	0.0	5.7			
Prop In Lane	1.00		0.00	0.00		1.00	1.00		1.00			
Lane Grp Cap(c), veh/h	433	2779	0	0	3192		509	0	449			
V/C Ratio(X)	0.84	0.22	0.00	0.00	0.35		0.79	0.00	0.40			
Avail Cap(c_a), veh/h	691	2779	0	0	3192		956	0	844			
HCM Platoon Ratio	2.00	2.00	1.00	1.00	2.00	2.00	1.00	1.00	1.00			
Upstream Filter(I)	0.97	0.97	0.00	0.00	0.67	0.00	1.00	0.00	1.00			
Uniform Delay (d), s/veh	40.1	0.0	0.0	0.0	0.0	0.0	45.4	0.0	42.6			
Incr Delay (d2), s/veh	3.4	0.2	0.0	0.0	0.2	0.0	1.7	0.0	0.3			
Initial Q Delay(d3),s/veh	0.0	0.0	0.0	0.0	0.0	0.0	0.0	0.0	0.0			
%ile BackOfQ(50%),veh/ln	4.3	0.1	0.0	0.0	0.1	0.0	5.2	0.0	2.2			
Unsig. Movement Delay, s/veh												
LnGrp Delay(d),s/veh	43.5	0.2	0.0	0.0	0.2	0.0	47.1	0.0	43.0			
LnGrp LOS	D	A	A	A	A		D	A	D			
Approach Vol, veh/h		981			1128			580				
Approach Delay, s/veh		16.2			0.2			45.8				
Approach LOS		B			A			D				
Timer - Assigned Phs		2			5	6		8				
Phs Duration (G+Y+Rc), s		90.0			17.8	72.2		20.0				
Change Period (Y+Rc), s		4.0			4.0	4.0		4.0				
Max Green Setting (Gmax), s		55.0			22.0	46.0		30.0				
Max Q Clear Time (g_c+1), s		2.0			12.9	2.0		14.2				
Green Ext Time (p_c), s		7.3			0.9	15.5		1.7				

Intersection Summary

HCM 6th Ctrl Delay	15.9
HCM 6th LOS	B

Notes

User approved volume balancing among the lanes for turning movement.
 Unsignalized Delay for [WBR] is excluded from calculations of the approach delay and intersection delay.

HCM 6th Signalized Intersection Summary
 3: Town Center Loop West & Wilsonville Rd

Wilsonville Town Center Multifamily TIA
 Existing + Project + Stage II



Movement	EBL	EBT	EBR	WBL	WBT	WBR	NBL	NBT	NBR	SBL	SBT	SBR
Lane Configurations	↔↔	↑↔		↔	↑↔		↔	↔↔		↔	↔	↔
Traffic Volume (veh/h)	397	457	52	29	574	60	215	60	29	39	63	579
Future Volume (veh/h)	397	457	52	29	574	60	215	60	29	39	63	579
Initial Q (Qb), veh	0	0	0	0	0	0	0	0	0	0	0	0
Ped-Bike Adj(A_pbT)	1.00		0.99	1.00		0.98	1.00		0.94	1.00		0.93
Parking Bus, Adj	1.00	1.00	1.00	1.00	1.00	1.00	1.00	1.00	1.00	1.00	1.00	1.00
Work Zone On Approach		No			No			No			No	
Adj Sat Flow, veh/h/ln	1885	1870	1900	1870	1870	1900	1885	1885	1900	1885	1885	1885
Adj Flow Rate, veh/h	418	481	49	31	604	57	226	63	16	41	140	115
Peak Hour Factor	0.95	0.95	0.95	0.95	0.95	0.95	0.95	0.95	0.95	0.95	0.95	0.95
Percent Heavy Veh, %	1	2	0	2	2	0	1	1	0	1	1	1
Cap, veh/h	480	1941	197	40	1576	148	463	184	47	184	193	152
Arrive On Green	0.28	1.00	1.00	0.02	0.48	0.48	0.13	0.13	0.13	0.10	0.10	0.10
Sat Flow, veh/h	3483	3255	330	1781	3277	309	3591	1431	363	1795	1885	1488
Grp Volume(v), veh/h	418	262	268	31	327	334	226	0	79	41	140	115
Grp Sat Flow(s),veh/h/ln	1742	1777	1809	1781	1777	1809	1795	0	1794	1795	1885	1488
Q Serve(g_s), s	12.6	0.0	0.0	1.9	12.9	12.9	6.4	0.0	4.4	2.3	7.9	8.3
Cycle Q Clear(g_c), s	12.6	0.0	0.0	1.9	12.9	12.9	6.4	0.0	4.4	2.3	7.9	8.3
Prop In Lane	1.00		0.18	1.00		0.17	1.00		0.20	1.00		1.00
Lane Grp Cap(c), veh/h	480	1060	1079	40	855	870	463	0	231	184	193	152
V/C Ratio(X)	0.87	0.25	0.25	0.78	0.38	0.38	0.49	0.00	0.34	0.22	0.72	0.75
Avail Cap(c_a), veh/h	570	1060	1079	97	855	870	914	0	457	277	291	230
HCM Platoon Ratio	2.00	2.00	2.00	1.00	1.00	1.00	1.00	1.00	1.00	1.00	1.00	1.00
Upstream Filter(I)	0.95	0.95	0.95	1.00	1.00	1.00	1.00	0.00	1.00	1.00	1.00	1.00
Uniform Delay (d), s/veh	38.9	0.0	0.0	53.5	18.2	18.2	44.5	0.0	43.7	45.3	47.9	48.0
Incr Delay (d2), s/veh	11.2	0.5	0.5	21.4	1.3	1.3	0.6	0.0	0.6	0.4	3.8	5.5
Initial Q Delay(d3),s/veh	0.0	0.0	0.0	0.0	0.0	0.0	0.0	0.0	0.0	0.0	0.0	0.0
%ile BackOfQ(50%),veh/ln	5.3	0.2	0.2	1.1	5.5	5.6	2.9	0.0	2.0	1.1	3.9	3.3
Unsig. Movement Delay, s/veh												
LnGrp Delay(d),s/veh	50.1	0.5	0.5	74.9	19.5	19.5	45.1	0.0	44.3	45.8	51.7	53.6
LnGrp LOS	D	A	A	E	B	B	D	A	D	D	D	D
Approach Vol, veh/h		948			692			305			296	
Approach Delay, s/veh		22.4			22.0			44.9			51.6	
Approach LOS		C			C			D			D	
Timer - Assigned Phs	1	2		4	5	6		8				
Phs Duration (G+Y+Rc), s	6.4	69.6		15.3	19.1	56.9		18.7				
Change Period (Y+Rc), s	4.0	4.5		4.5	4.0	4.5		4.5				
Max Green Setting (Gmax), s	6.0	42.0		16.5	18.0	30.0		28.0				
Max Q Clear Time (g_c+1), s	13.0	2.0		10.3	14.6	14.9		8.4				
Green Ext Time (p_c), s	0.0	3.6		0.5	0.6	3.7		1.0				

Intersection Summary

HCM 6th Ctrl Delay	29.2
HCM 6th LOS	C

Notes

User approved volume balancing among the lanes for turning movement.

Intersection						
Int Delay, s/veh	4.6					
Movement	WBL	WBR	NBT	NBR	SBL	SBT
Lane Configurations	↘	↗	↑	↗	↘	↑
Traffic Vol, veh/h	143	21	261	74	24	405
Future Vol, veh/h	143	21	261	74	24	405
Conflicting Peds, #/hr	2	0	0	5	5	0
Sign Control	Stop	Stop	Free	Free	Free	Free
RT Channelized	-	None	-	None	-	None
Storage Length	75	0	-	0	70	-
Veh in Median Storage, #	0	-	0	-	-	0
Grade, %	0	-	0	-	-	0
Peak Hour Factor	86	86	86	86	86	86
Heavy Vehicles, %	2	0	1	3	0	1
Mvmt Flow	166	24	303	86	28	471

Major/Minor	Minor1	Major1	Major2		
Conflicting Flow All	837	308	0	0	394
Stage 1	308	-	-	-	-
Stage 2	529	-	-	-	-
Critical Hdwy	6.42	6.2	-	-	4.1
Critical Hdwy Stg 1	5.42	-	-	-	-
Critical Hdwy Stg 2	5.42	-	-	-	-
Follow-up Hdwy	3.518	3.3	-	-	2.2
Pot Cap-1 Maneuver	337	737	-	-	1176
Stage 1	745	-	-	-	-
Stage 2	591	-	-	-	-
Platoon blocked, %			-	-	-
Mov Cap-1 Maneuver	327	734	-	-	1171
Mov Cap-2 Maneuver	327	-	-	-	-
Stage 1	742	-	-	-	-
Stage 2	576	-	-	-	-

Approach	WB	NB	SB
HCM Control Delay, s	24.7	0	0.5
HCM LOS	C		

Minor Lane/Major Mvmt	NBT	NBR	WBLn1	WBLn2	SBL	SBT
Capacity (veh/h)	-	-	327	734	1171	-
HCM Lane V/C Ratio	-	-	0.508	0.033	0.024	-
HCM Control Delay (s)	-	-	26.9	10.1	8.1	-
HCM Lane LOS	-	-	D	B	A	-
HCM 95th %tile Q(veh)	-	-	2.7	0.1	0.1	-

Intersection												
Int Delay, s/veh	1.1											
Movement	EBL	EBT	EBR	WBL	WBT	WBR	NBL	NBT	NBR	SBL	SBT	SBR
Lane Configurations		↕			↕		↕	↕			↕	
Traffic Vol, veh/h	8	0	14	18	0	6	4	255	23	8	397	4
Future Vol, veh/h	8	0	14	18	0	6	4	255	23	8	397	4
Conflicting Peds, #/hr	0	0	0	0	0	0	0	0	0	0	0	0
Sign Control	Stop	Stop	Stop	Stop	Stop	Stop	Free	Free	Free	Free	Free	Free
RT Channelized	-	-	None	-	-	None	-	-	None	-	-	None
Storage Length	-	-	-	-	-	-	60	-	-	-	-	-
Veh in Median Storage, #	-	0	-	-	0	-	-	0	-	-	0	-
Grade, %	-	0	-	-	0	-	-	0	-	-	0	-
Peak Hour Factor	83	83	83	83	83	83	83	83	83	83	83	83
Heavy Vehicles, %	0	0	0	0	0	0	0	1	0	0	1	0
Mvmt Flow	10	0	17	22	0	7	5	307	28	10	478	5

Major/Minor	Minor2		Minor1		Major1		Major2					
Conflicting Flow All	836	846	481	840	834	321	483	0	0	335	0	0
Stage 1	501	501	-	331	331	-	-	-	-	-	-	-
Stage 2	335	345	-	509	503	-	-	-	-	-	-	-
Critical Hdwy	7.1	6.5	6.2	7.1	6.5	6.2	4.1	-	-	4.1	-	-
Critical Hdwy Stg 1	6.1	5.5	-	6.1	5.5	-	-	-	-	-	-	-
Critical Hdwy Stg 2	6.1	5.5	-	6.1	5.5	-	-	-	-	-	-	-
Follow-up Hdwy	3.5	4	3.3	3.5	4	3.3	2.2	-	-	2.2	-	-
Pot Cap-1 Maneuver	289	301	589	287	306	724	1090	-	-	1236	-	-
Stage 1	556	546	-	687	649	-	-	-	-	-	-	-
Stage 2	683	640	-	550	545	-	-	-	-	-	-	-
Platoon blocked, %								-	-	-	-	-
Mov Cap-1 Maneuver	283	296	589	276	301	724	1090	-	-	1236	-	-
Mov Cap-2 Maneuver	283	296	-	276	301	-	-	-	-	-	-	-
Stage 1	553	540	-	684	646	-	-	-	-	-	-	-
Stage 2	673	637	-	528	539	-	-	-	-	-	-	-

Approach	EB		WB		NB		SB			
HCM Control Delay, s	14.1		17.1		0.1		0.2			
HCM LOS	B		C							

Minor Lane/Major Mvmt	NBL	NBT	NBR	EBLn1	WBLn1	SBL	SBT	SBR
Capacity (veh/h)	1090	-	-	423	327	1236	-	-
HCM Lane V/C Ratio	0.004	-	-	0.063	0.088	0.008	-	-
HCM Control Delay (s)	8.3	-	-	14.1	17.1	7.9	0	-
HCM Lane LOS	A	-	-	B	C	A	A	-
HCM 95th %tile Q(veh)	0	-	-	0.2	0.3	0	-	-

ID	Software/Method	Intersection	Control Type	LOS	Delay	V/C Ratio
1	Synchro HCM 6th Signal	I-5 SB Ramp & Wilsonville Rd	Signal	B	12.3	0.39
2	Synchro HCM 6th Signal	I-5 NB Ramp & Wilsonville Rd	Signal	B	15.9	0.48
3	Synchro HCM 6th Signal	Town Center Loop West & Wilsonville Rd	Signal	C	29.2	0.52

APPENDIX G: TURN LANE CONCEPTUAL DEMONSTRATION

New Turn Lane
Conceptual Demonstration

Proposed Driveway

Turn Lane Concept

Optional Future Landscaped Median
(optional construction alongside future
Park Place Promenade project)

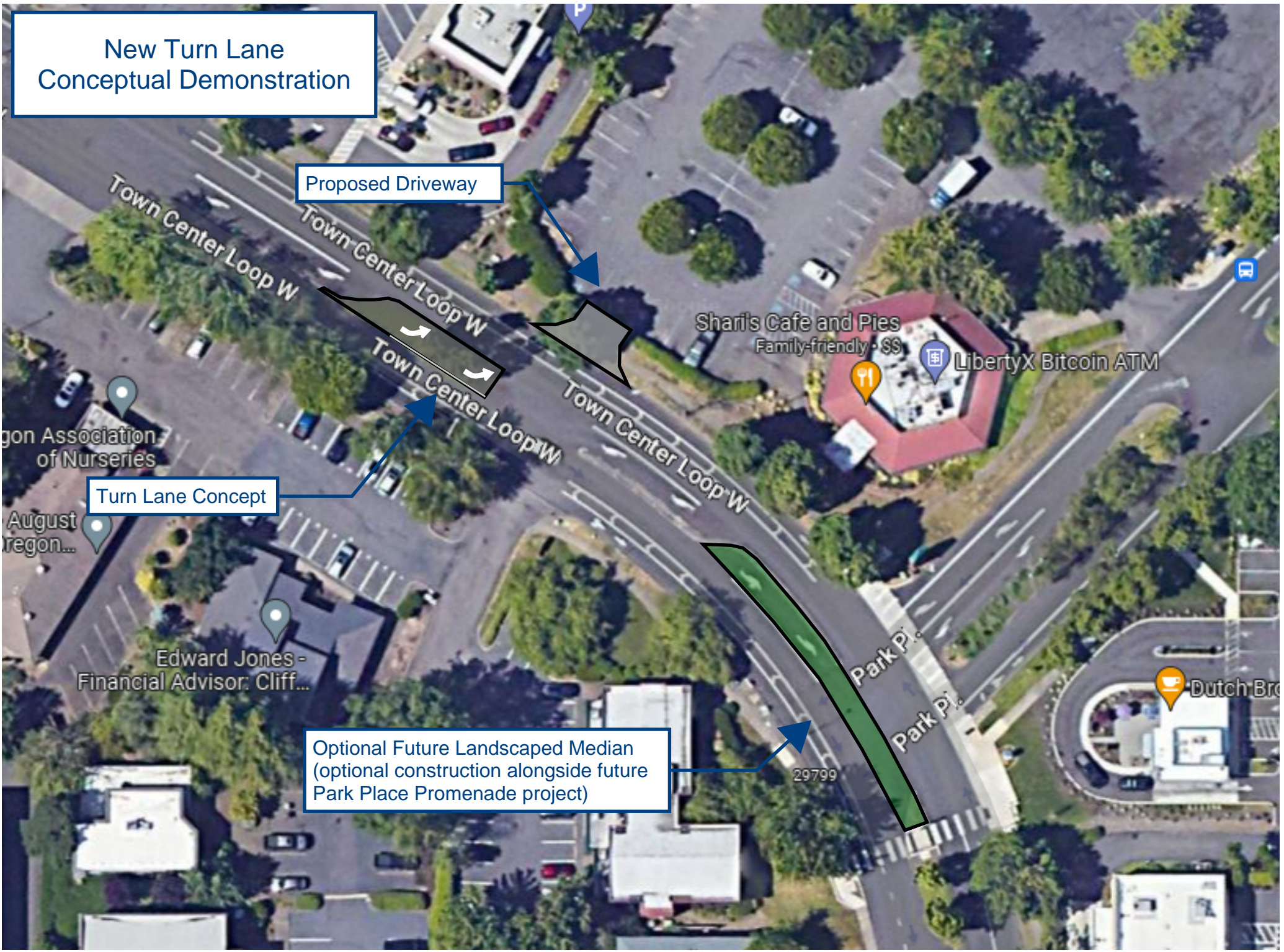

Shari's Cafe and Pies
Family-friendly · \$\$

LibertyX Bitcoin ATM

gon Association of Nurseries

August Oregon...

Edward Jones - Financial Advisor: Cliff...

29799

Dutch Br...

APPENDIX H: SITE PLAN

Mixed use 5-story building
114 multi-family units
Gross Building sq. ft. 92,000 sf
Retail: 4,000 sf
54 parking spaces

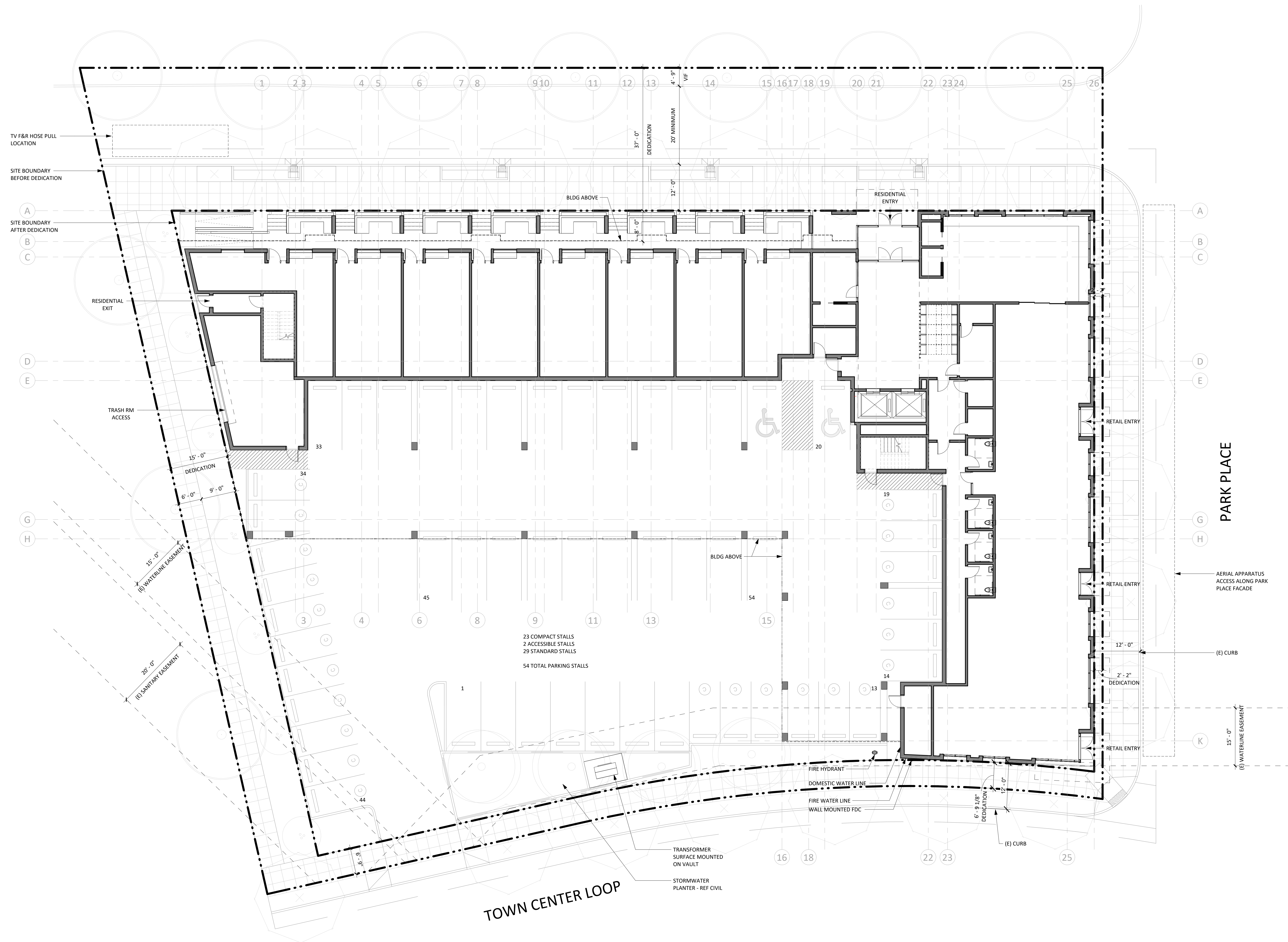

STAMP

NOT FOR CONSTRUCTION

REVISION NO.

DATE

KEY PLAN - (NTS)



LEVEL WTC MULTIFAMILY

LEVEL DEVELOPMENT
29690 SW Town Center Loop W
Wilsonville, OR 97070

ISSUANCE
100% SCHEMATIC DESIGN

PROJECT NUMBER
02219

DATE
1/27/2023

SCALE
3/32" = 1'-0"

DRAWING TITLE
SITE PLAN

SHEET NUMBER

G-100