

Evidence Mezzanine 201

Elevations

Color	Tag	Description
	WS1	24" D x 72" W x 72" H - Wire Decking
	U1	24" D x 36" W x 76-1/4" H - Plain Shelves - 4" Front Base
	U2	24" D x 36" W x 76-1/4" H - Plain Shelves - 4" Front Base - Door (Keyed Alike) - Back Panel



Project name:  
**Whitewater Police Department**

Salesperson:  
**MAWHINNEY, RYAN**

Project #:  
47552

Drawn by:  
SR

Date printed:  
3/18/2026

Rev. level:  
1A

APPROVAL  
This drawing is approved by:

DATE: \_\_\_\_\_

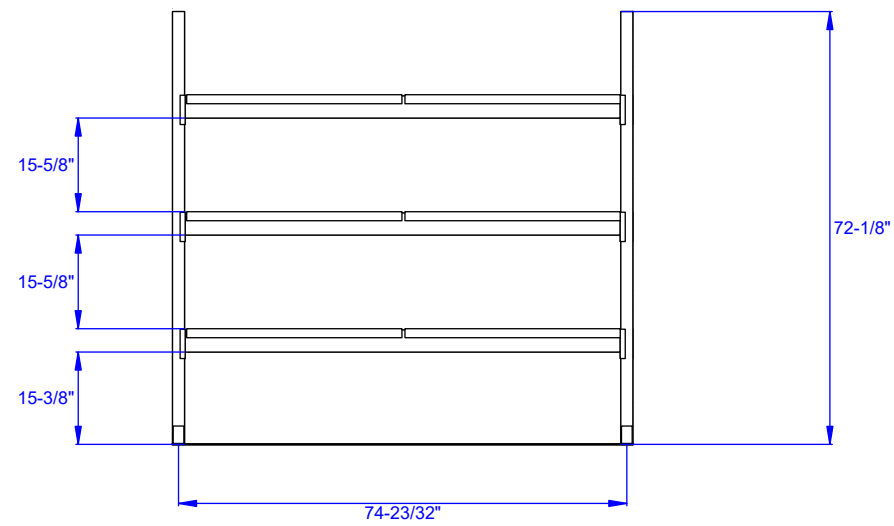

Color	Tag	Description
	WS1	24" D x 72" W x 72" H - Wire Decking

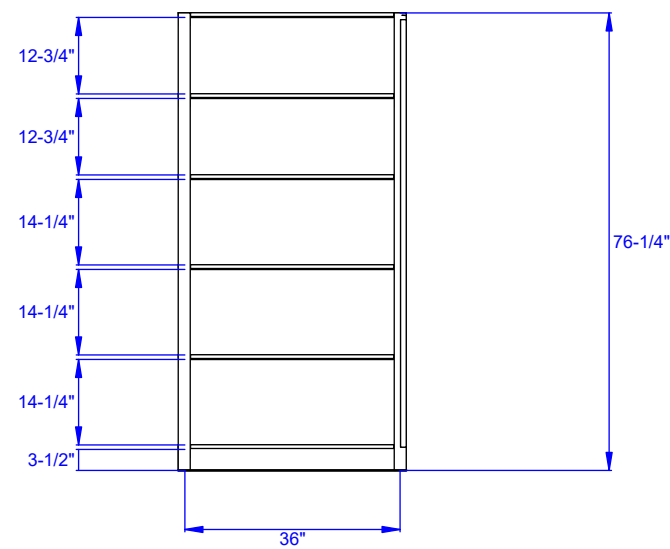
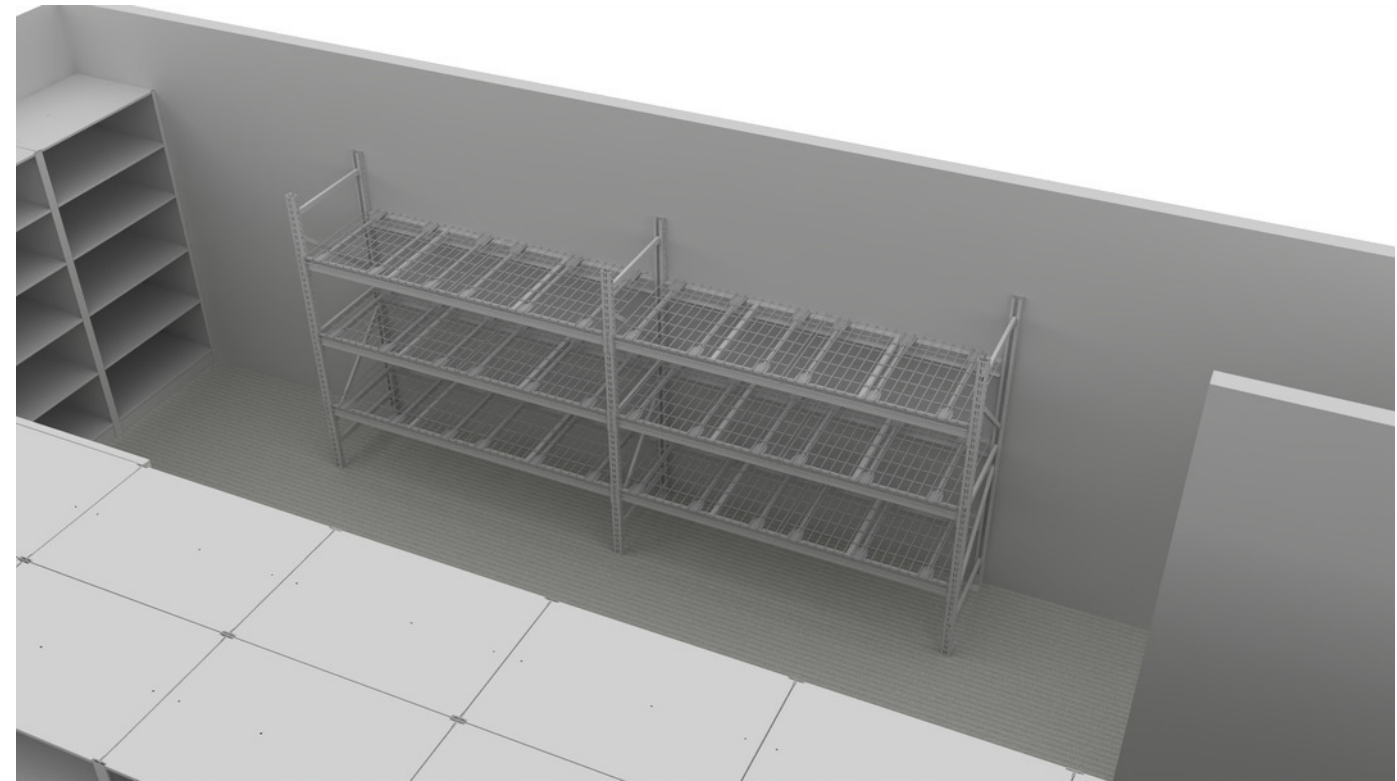

Color	Tag	Description
	U1	24" D x 36" W x 76-1/4" H - Plain Shelves - 4" Front Base

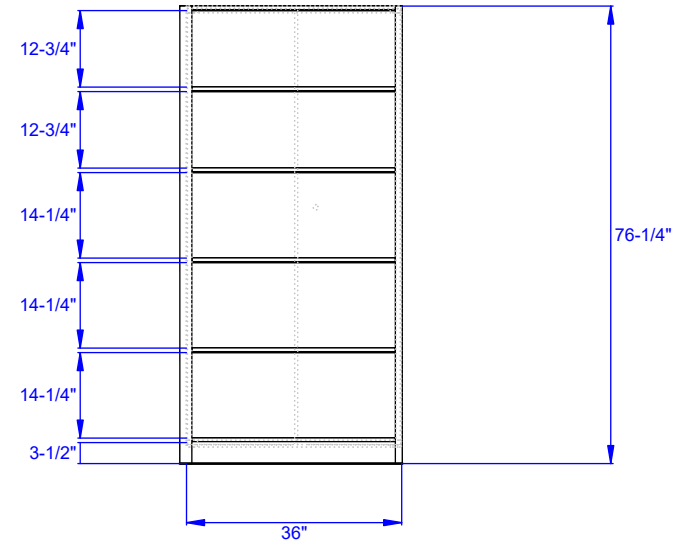

Color	Tag	Description
	U2	24" D x 36" W x 76-1/4" H - Plain Shelves - 4" Front Base - Door (Keyed Alike) - Back Panel

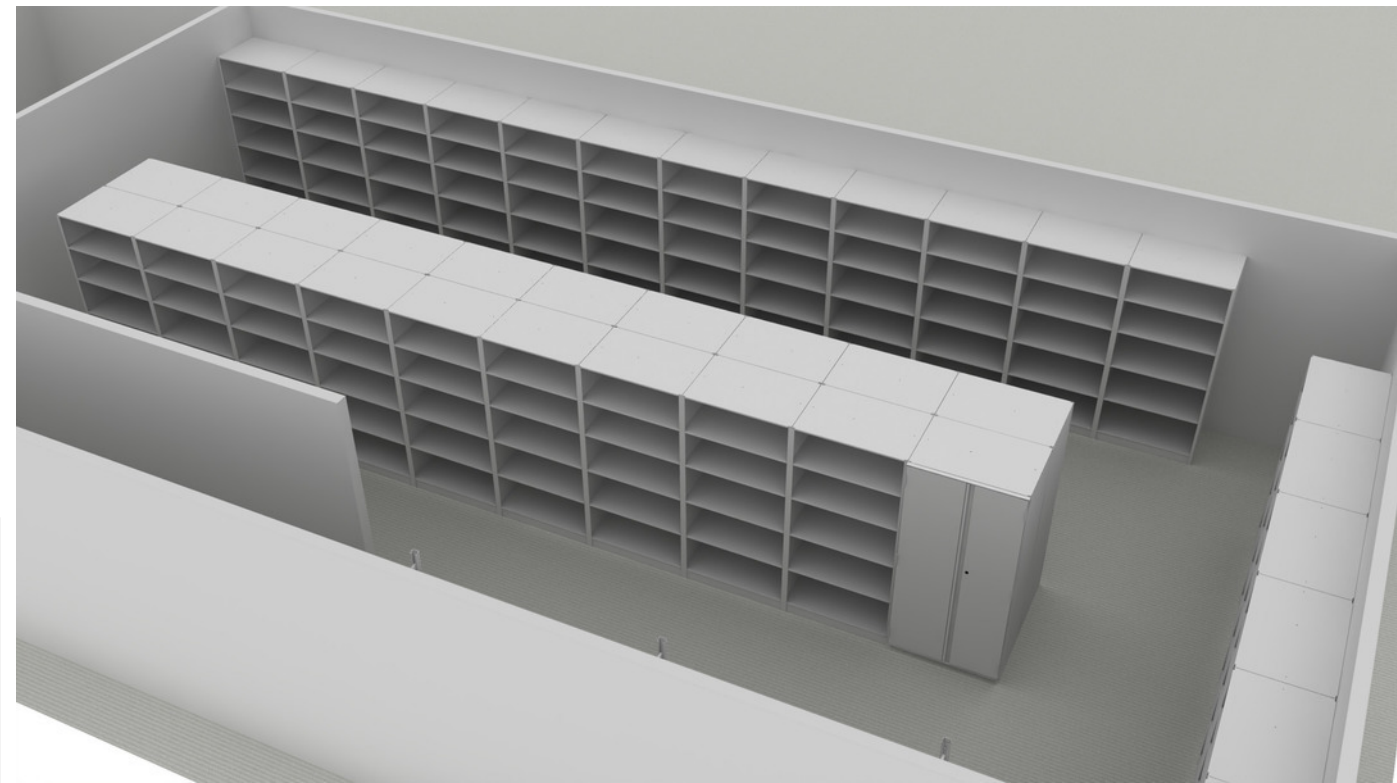

Project name:  
**Whitewater Police Department**

Salesperson:  
**MAWHINNEY, RYAN**

Rev. level:  
**1A**

Project #:  
**47552**

Drawn by:  
**SR**

Date printed:  
**3/18/2026**

APPROVAL  
This drawing is approved by:

DATE: \_\_\_\_\_

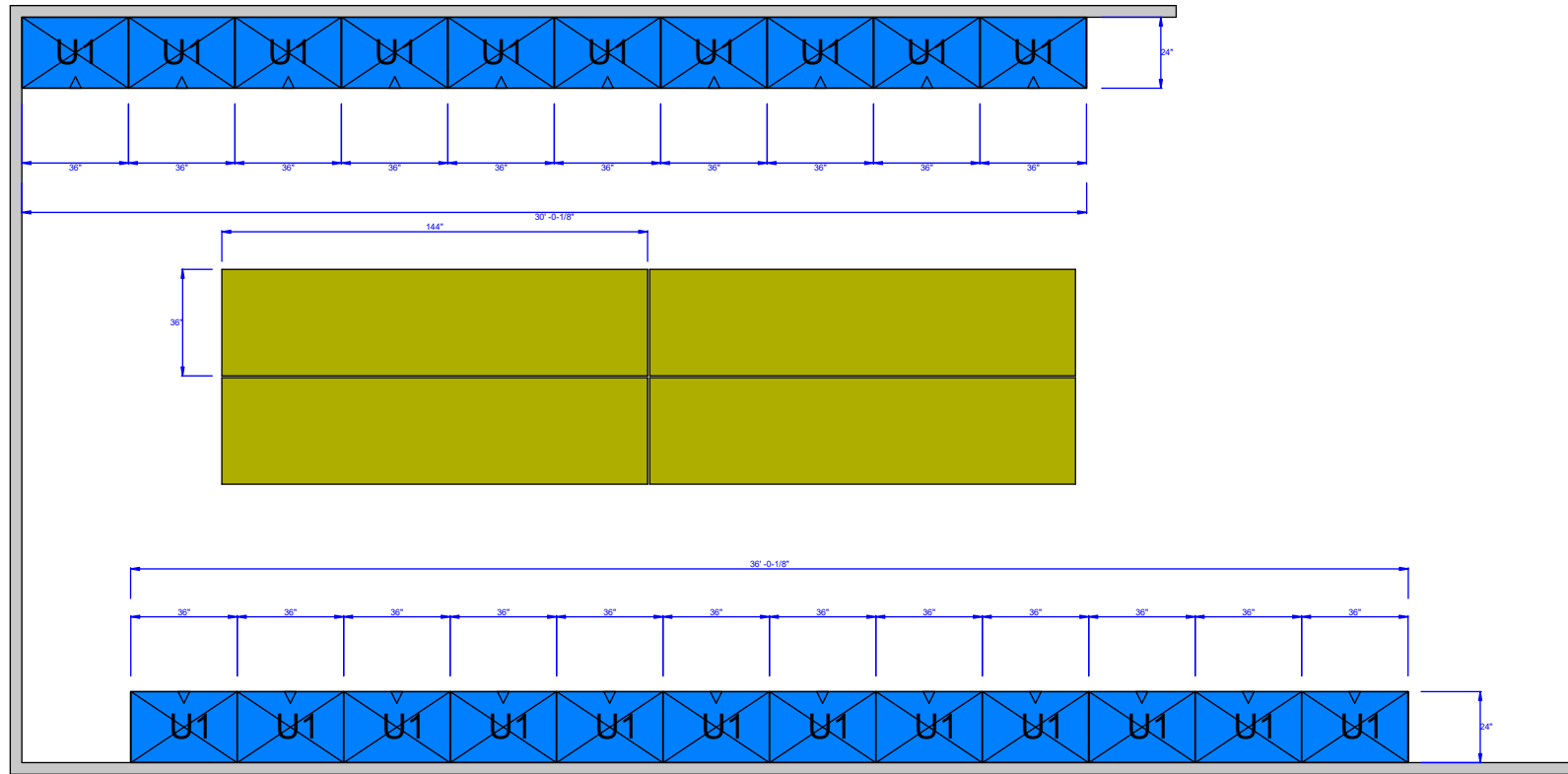

Evidence 101

Elevations

Color	Tag	Description
	U1	24" D x 36" W x 76-1/4" H - Plain Shelves - 4" Front Base
	Tables	(4) 36" D x 144" L - Back to Back Stainless Steel



Project name:  
**Whitewater Police Department**

Salesperson:  
**MAWHINNEY,RYAN**

Rev. level:  
**1A**

Project #:  
**47552**

Drawn by:  
**SR**

Date printed:  
**3/18/2026**

**APPROVAL**  
This drawing is approved by:

DATE: \_\_\_\_\_

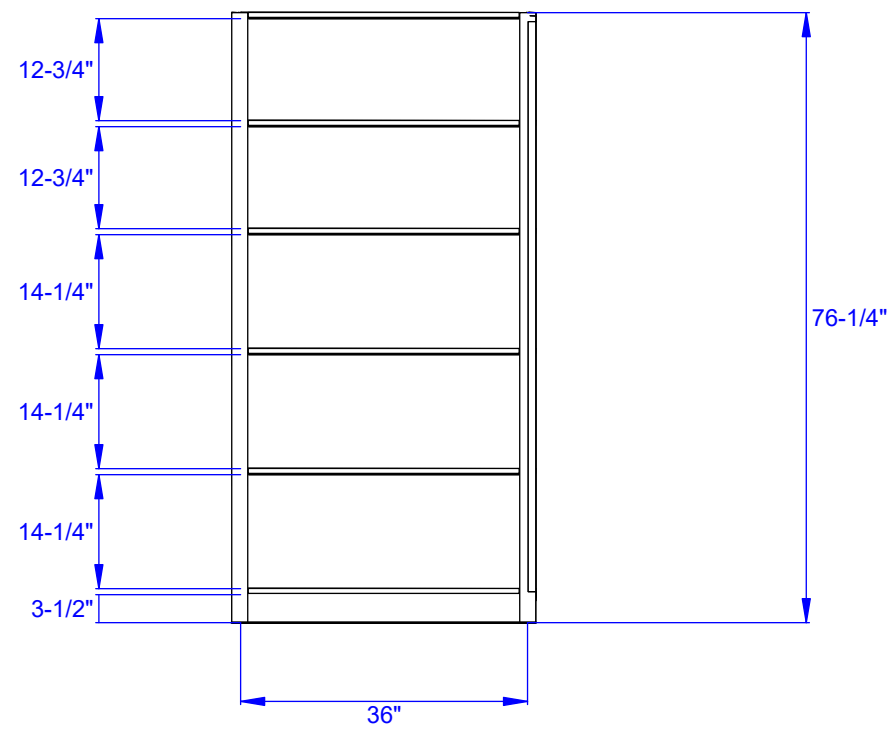

Color	Tag	Description
	U1	24" D x 36" W x 76-1/4" H - Plain Shelves - 4" Front Base

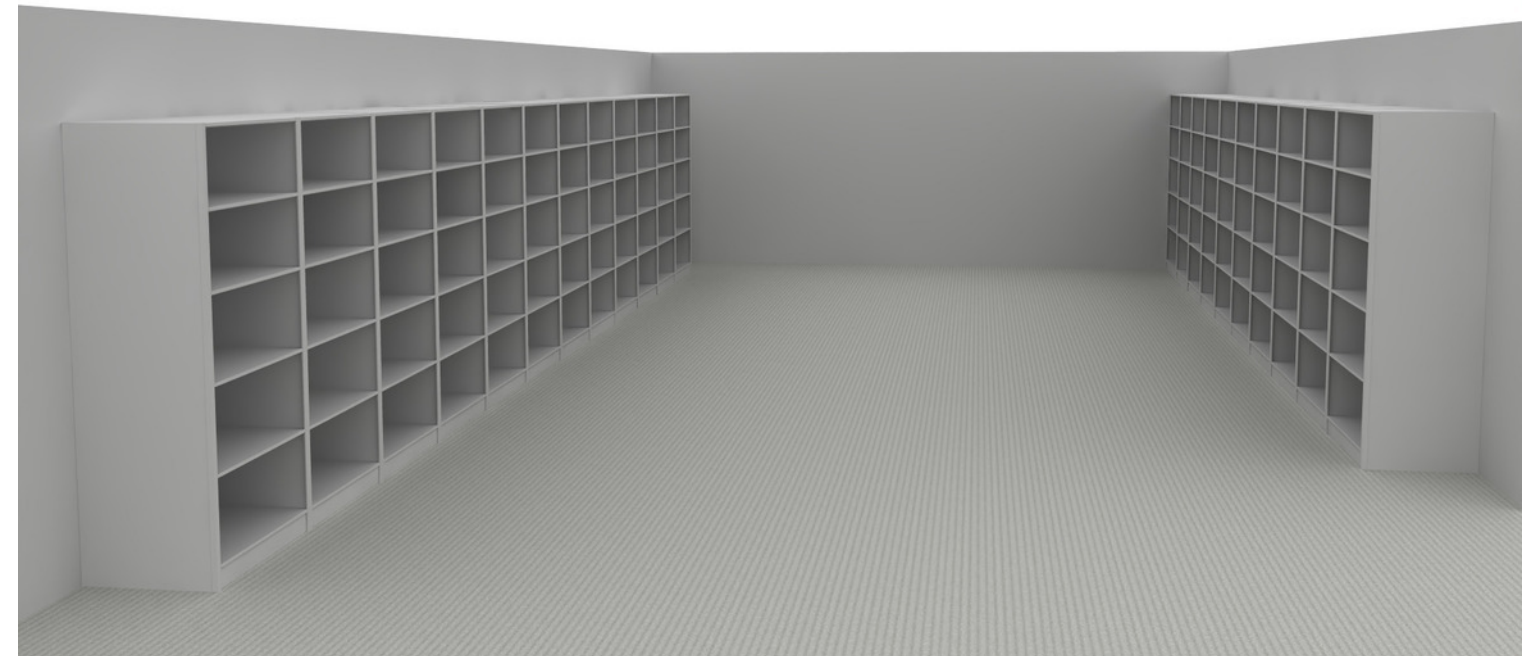

Color	Tag	Description
	Tables	(4) 36" D x 144" L - Back to Back Stainless Steel

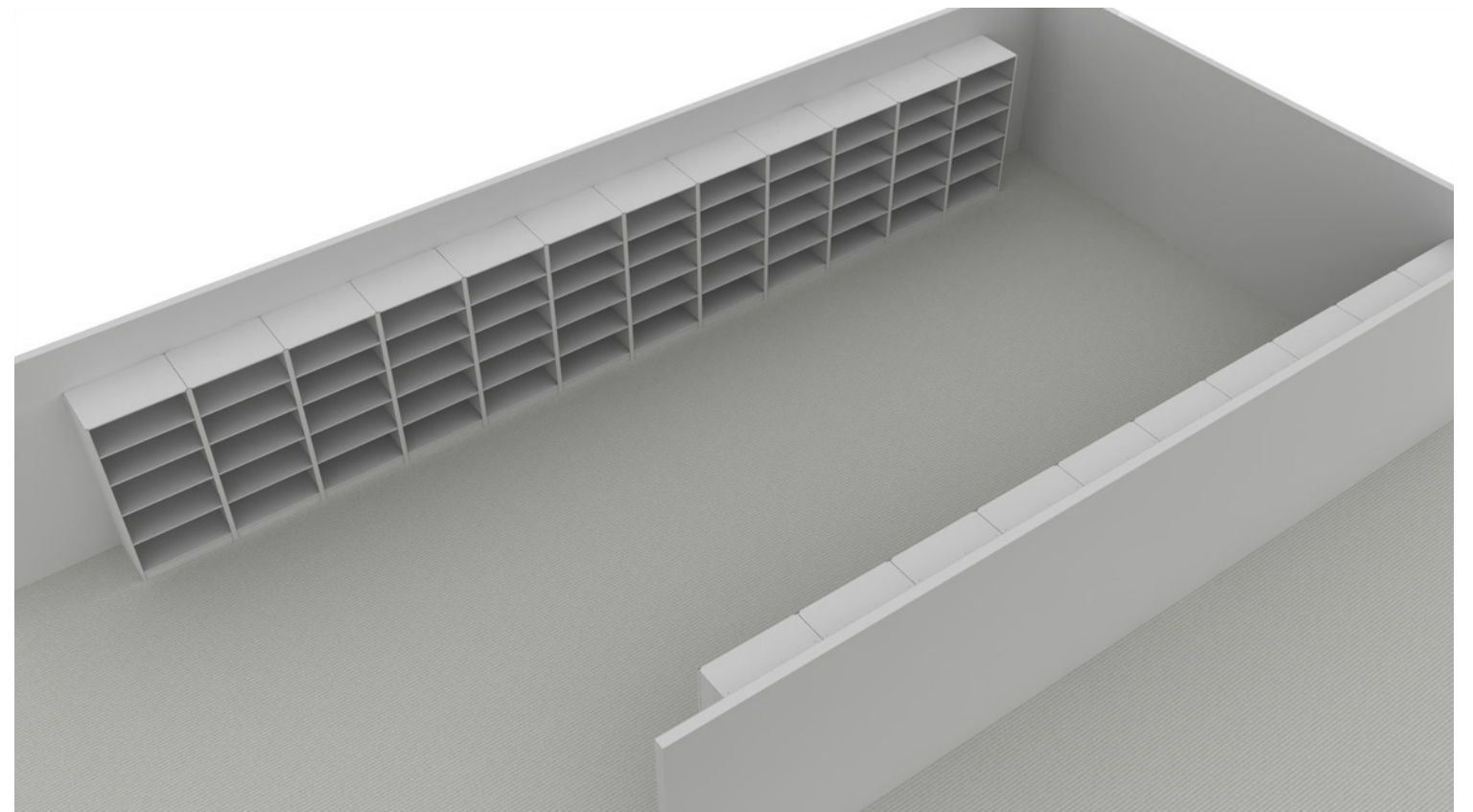

Project name:  
**Whitewater Police Department**

Salesperson:  
**MAWHINNEY, RYAN**

Rev. level:  
**1A**

Project #:  
**47552**

Drawn by:  
**SR**

Date printed:  
**3/18/2026**

**APPROVAL**  
This drawing is approved by:  
\_\_\_\_\_  
DATE: \_\_\_\_\_