

Dimensions Displayed in FEET

Top View

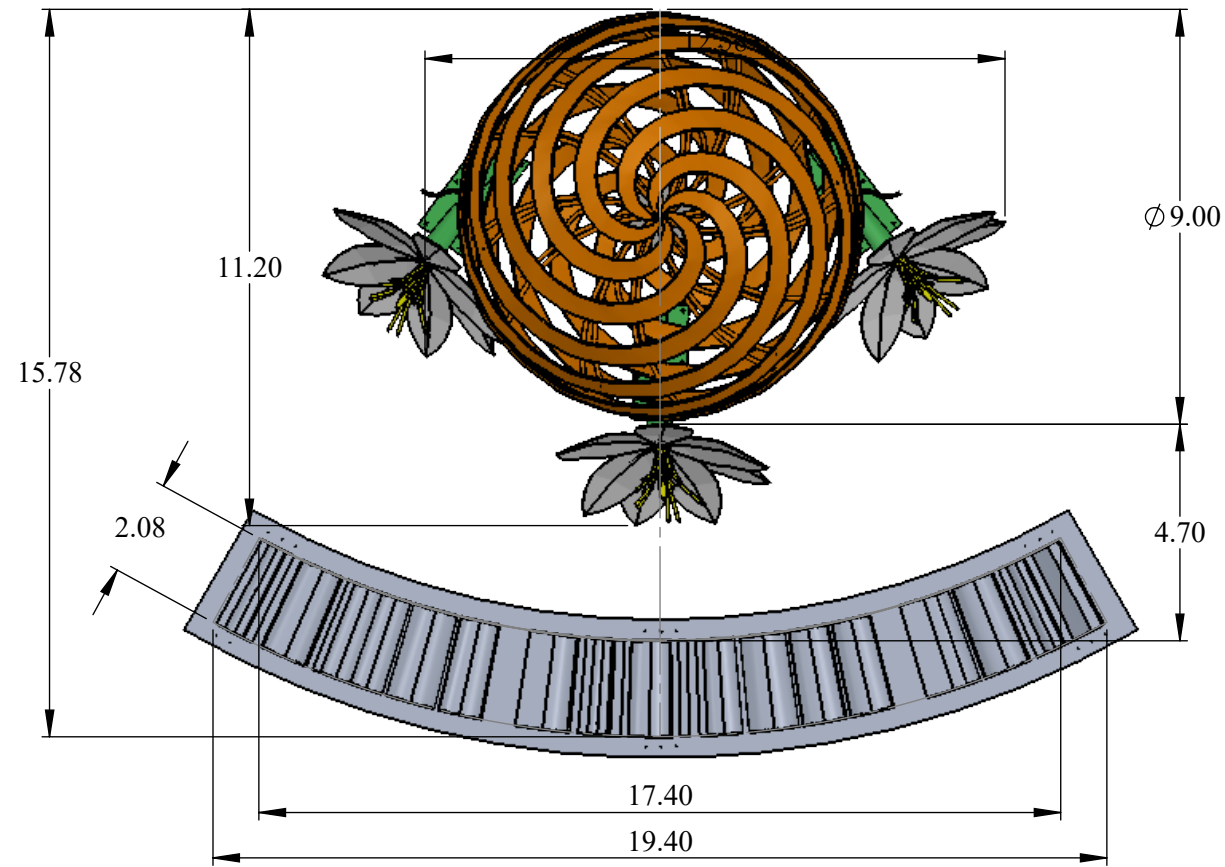

Front View

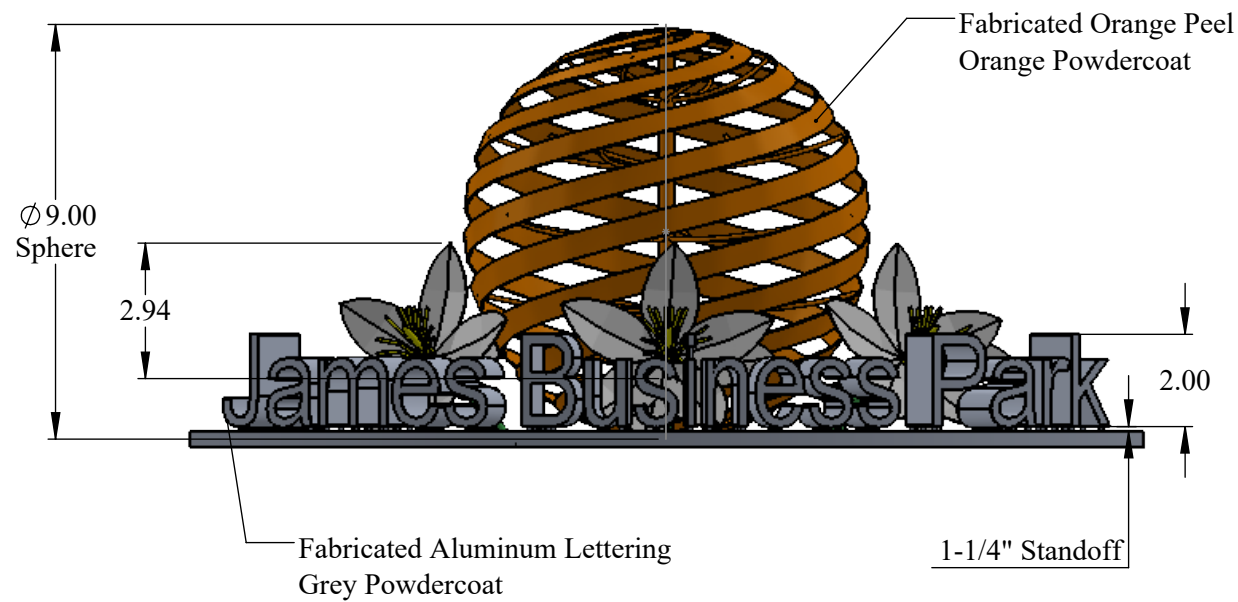

REVISIONS				
ZONE	REV.	DESCRIPTION	DATE	APPROVED
	A	Updated with Feedback from Customer	12/7/2022	EES
	B	Further Updates and more Details added (see pgs 3-4)	1/9/2023	EES

(6x) Orange Peels
 Fabricated 1/2" Aluminum Spirals
 w/ Stainless Steel Column
Estimated Weight: 1300 lbs
Estimated Wind Load: 763.5 sq ft

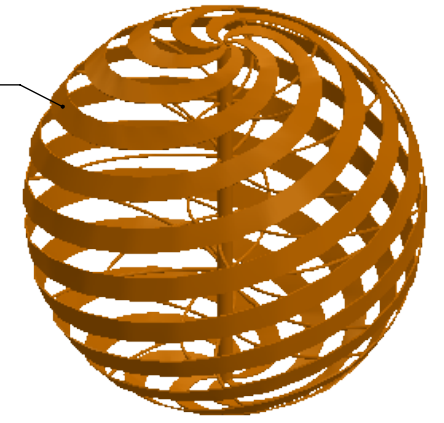

See pg 3 for Detail Overview

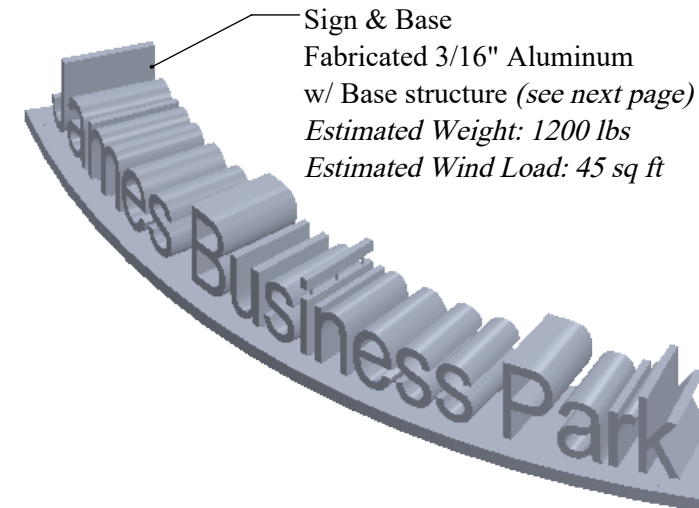

Sign & Base
 Fabricated 3/16" Aluminum
 w/ Base structure (see next page)
Estimated Weight: 1200 lbs
Estimated Wind Load: 45 sq ft

(1x) Pistil
 Yellow Powdercoat
 (13x) Anthers
 Yellow Powdercoat

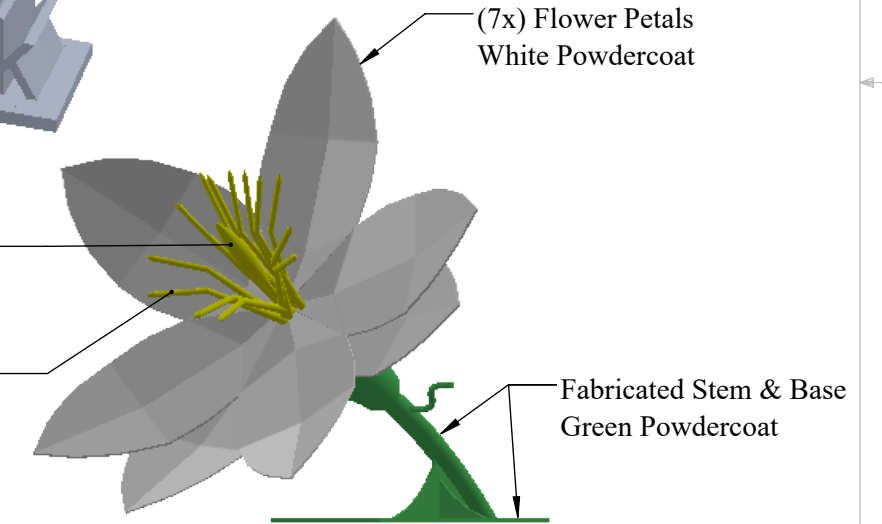

(7x) Flower Petals
 White Powdercoat

Fabricated Stem & Base
 Green Powdercoat

3x Orange Blossom Flower: Aluminum Assemblies
Estimated Weight: 180 lbs Each
Estimated Wind Loads: 125 sq ft Each

PROPRIETARY AND CONFIDENTIAL
 THE INFORMATION CONTAINED IN THIS DRAWING IS THE SOLE PROPERTY OF **EES DESIGN LLC**. ANY REPRODUCTION IN PART OR AS A WHOLE WITHOUT THE WRITTEN PERMISSION OF **EES DESIGN LLC** IS PROHIBITED.

		UNLESS OTHERWISE SPECIFIED:		NAME	DATE	EES DESIGN, LLC	
		DIMENSIONS ARE IN INCHES		DRAWN	JV	1/9/2023	
		TOLERANCES:		CHECKED		TITLE:	
		FRACTIONAL ±		ENG APPR.		Orange Peel Sculpture	
		ANGULAR: MACH ± BEND ±		MFG APPR.		SIZE DWG. NO.	
		TWO PLACE DECIMAL ±		Q.A.		REV	
		THREE PLACE DECIMAL ±		COMMENTS:		B	
		INTERPRET GEOMETRIC TOLERANCING PER:				22159-EN-1122	
		MATERIAL				SHEET 1 OF 4	
		FINISH				WEIGHT:	
NEXT ASSY	USED ON	DO NOT SCALE DRAWING				SCALE: 1:50	
APPLICATION							

BOTTOM VIEW

(8x) 3 x 3 x 1/4" Wall Stiffener

34" x 20.00
1" Aluminum
3 Places

27.27°

(6x) \varnothing 1"
each Base

(6x) \varnothing 3/4"
each Base

30" x 14.00
1/2" Aluminum
3 Places

\varnothing 18" OD
3/4" Stainless Steel
 \varnothing 15.00 Bolt Circle

(6x) \varnothing 3/4"

Site to be drilled and anchors installed using a provided template

PROPRIETARY AND CONFIDENTIAL
THE INFORMATION CONTAINED IN THIS
DRAWING IS THE SOLE PROPERTY OF
EES DESIGN LLC. ANY REPRODUCTION
IN PART OR AS A WHOLE WITHOUT THE
WRITTEN PERMISSION OF
EES DESIGN LLC IS PROHIBITED.

		UNLESS OTHERWISE SPECIFIED:		NAME	DATE	EES DESIGN, LLC TITLE: <i>Orange Peel Sculpture Base Detail</i> SIZE DWG. NO. REV B 22159-EN-1122 B SCALE: 1:30 WEIGHT: SHEET 2 OF 4	
		DIMENSIONS ARE IN INCHES		DRAWN	JV		1/9/2023
		TOLERANCES:		CHECKED			
		FRACTIONAL \pm		ENG APPR.			
		ANGULAR: MACH \pm BEND \pm		MFG APPR.			
		TWO PLACE DECIMAL \pm		Q.A.			
		THREE PLACE DECIMAL \pm		COMMENTS:			
		INTERPRET GEOMETRIC TOLERANCING PER:					
		MATERIAL					
NEXT ASSY	USED ON	FINISH					
APPLICATION		DO NOT SCALE DRAWING					

Support Tubes plug welded and outside surface blended smooth

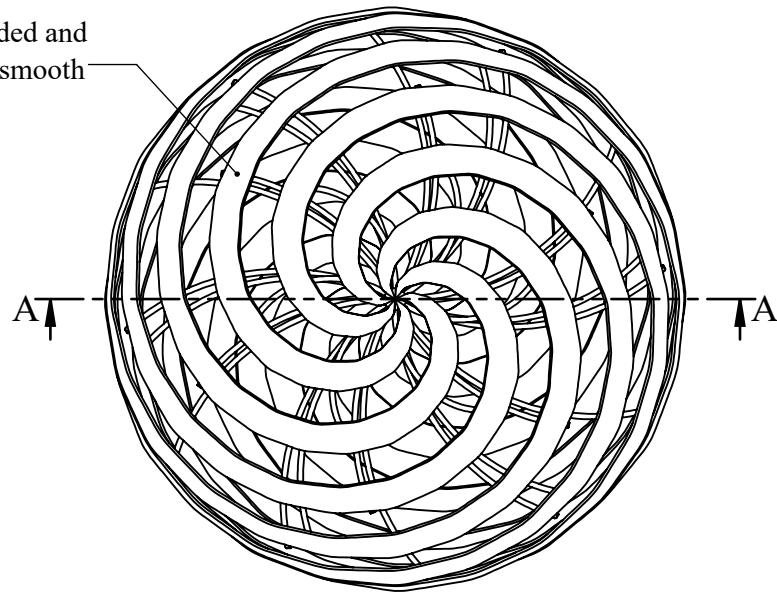

Top View

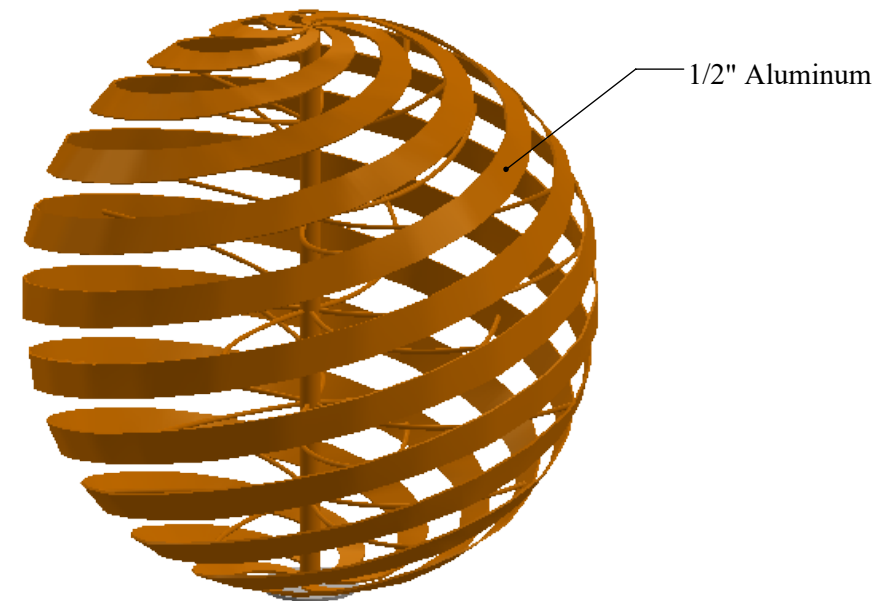
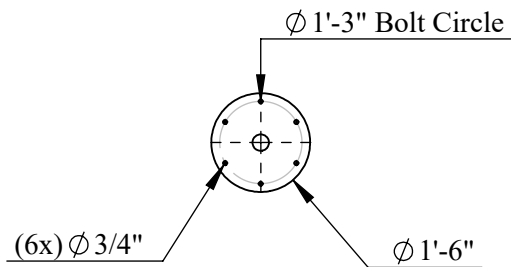

9ft Aluminum "Orange Peel" sphere, Current Concept:
Solid welded assembly with $\phi 1''$ rolled support arms

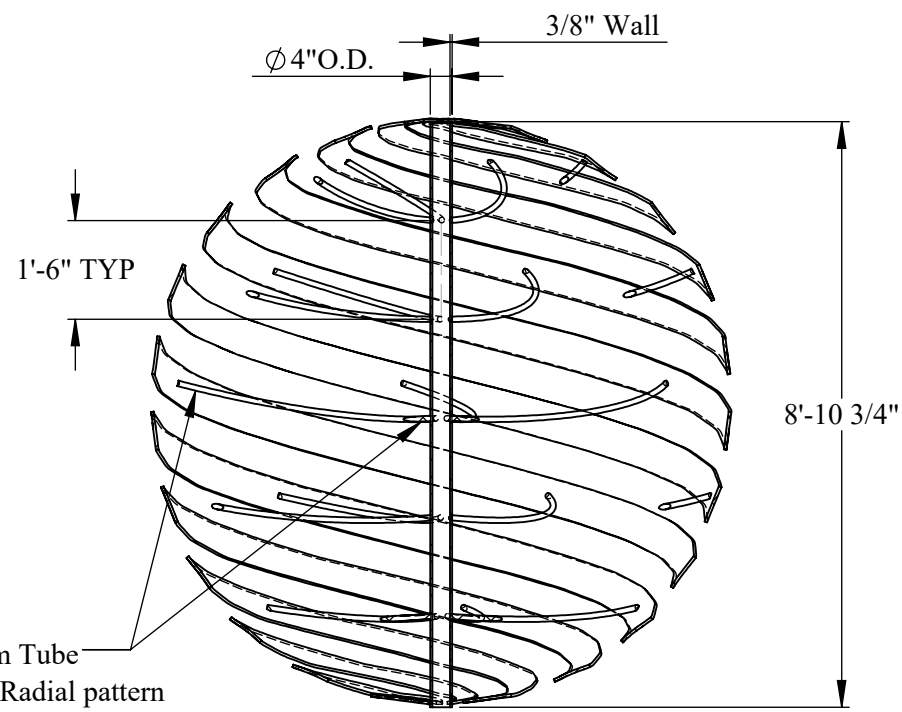

SECTION A-A
Front View

$\phi 1''$ Rolled aluminum Tube
Rolled and welded in Radial pattern
to central column and inside of Orange Peel ribbons

Edges of Orange Peel ribbons can be rounded over with a 1/4" or 3/16" radius to discourage climbing on the piece

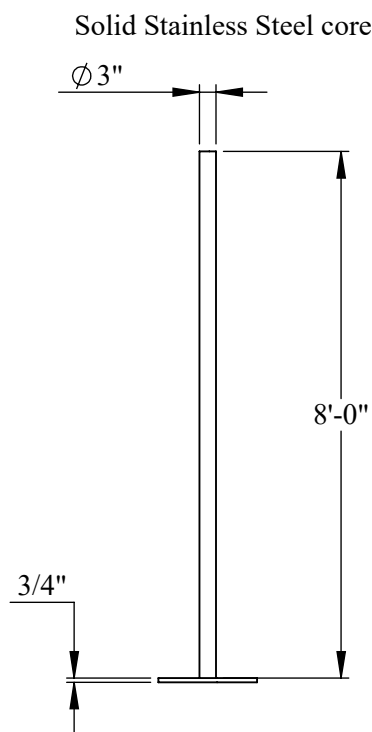

Solid Stainless Steel core

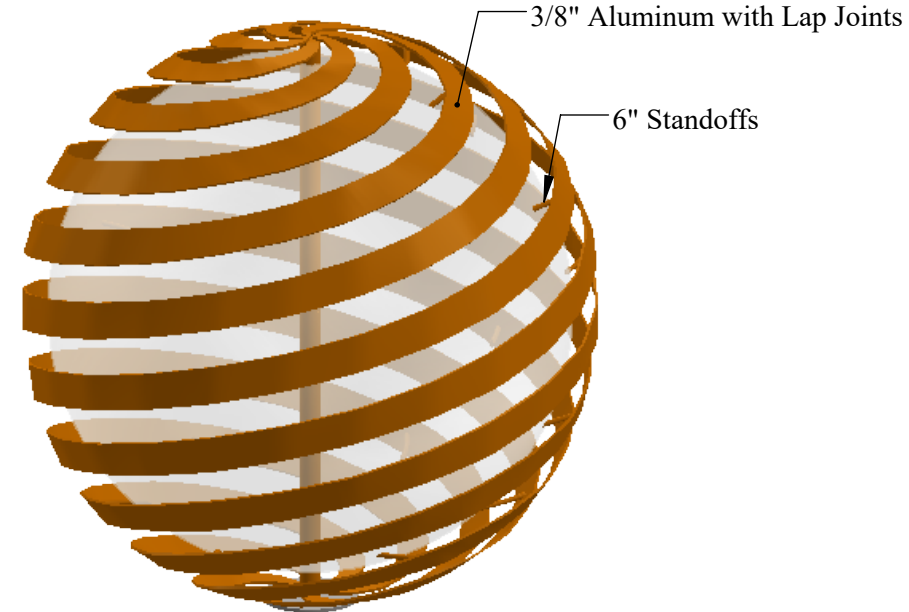

9ft Aluminum "Orange Peel" sphere, Alternate Concept:
Top/Bottom Half over 8ft Acrylic Hemispheres, with 6" standoffs

PROPRIETARY AND CONFIDENTIAL
THE INFORMATION CONTAINED IN THIS DRAWING IS THE SOLE PROPERTY OF **EES DESIGN LLC**. ANY REPRODUCTION IN PART OR AS A WHOLE WITHOUT THE WRITTEN PERMISSION OF **EES DESIGN LLC** IS PROHIBITED.

		UNLESS OTHERWISE SPECIFIED:		NAME	DATE	EES DESIGN, LLC	
		DIMENSIONS ARE IN INCHES		DRAWN	JV		
		TOLERANCES:		CHECKED		TITLE: <i>Orange Peel Detail Overview</i>	
		FRACTIONAL \pm		ENG APPR.			
		ANGULAR: MACH \pm		MFG APPR.		SIZE DWG. NO.	
		BEND \pm		Q.A.		22159-EN-1122	
		TWO PLACE DECIMAL \pm		COMMENTS:		REV	
		THREE PLACE DECIMAL \pm				B	
		INTERPRET GEOMETRIC TOLERANCING PER:				SHEET 3 OF 4	
		MATERIAL				SCALE: 1:35	
		FINISH				WEIGHT:	
NEXT ASSY	USED ON	DO NOT SCALE DRAWING					
APPLICATION							

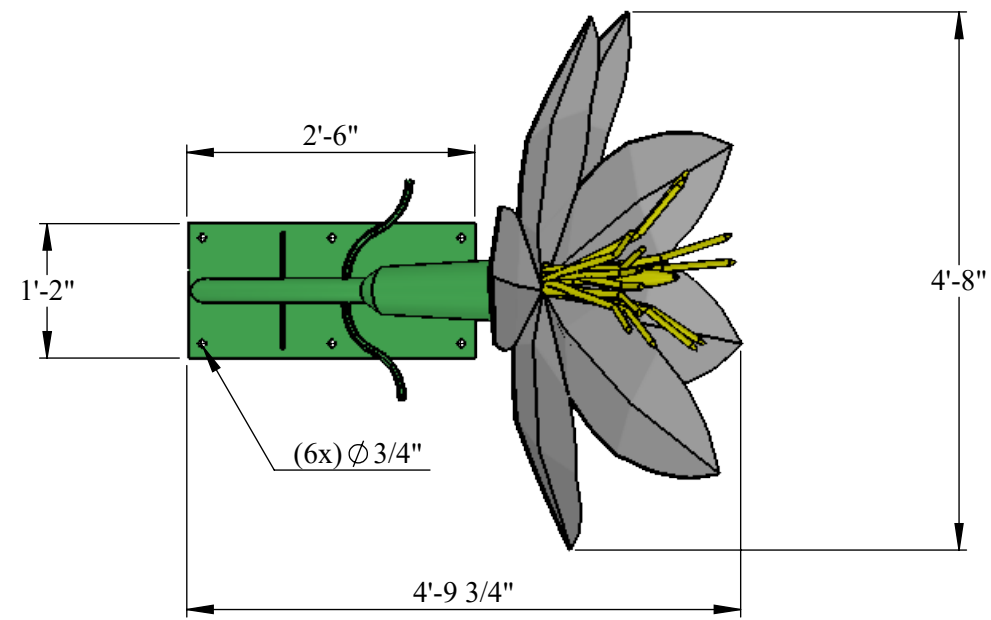

Anthers/Pistil and Flower Petal Sub-Assemblies
Mechanically fastened into Body with Stainless
Steel Tamper-Proof hardware

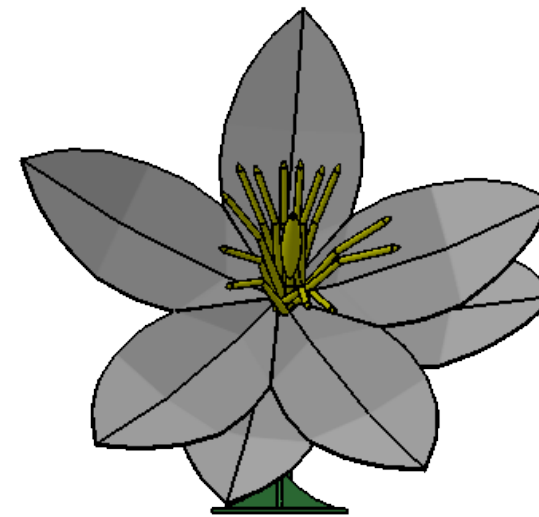
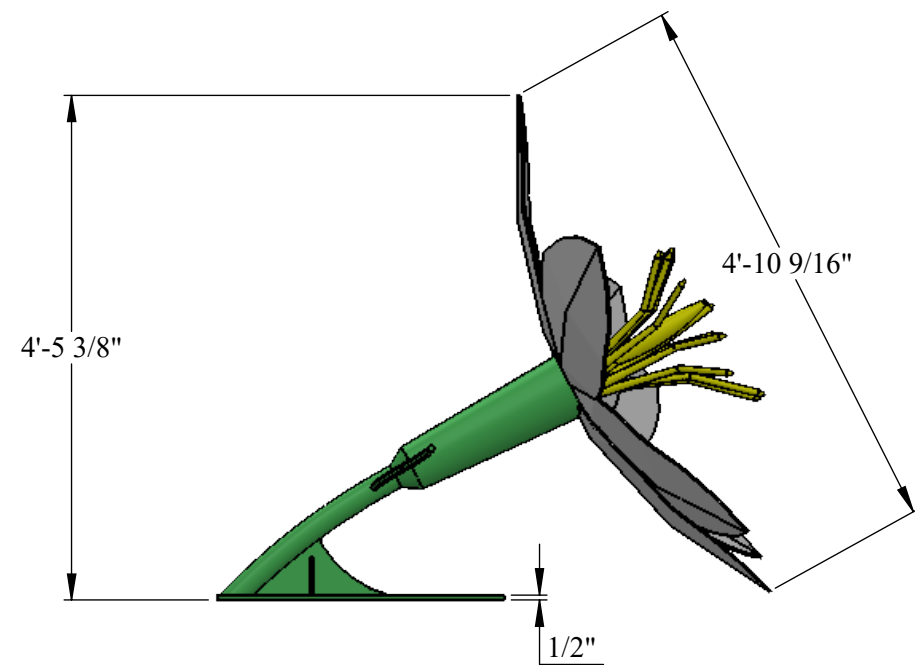
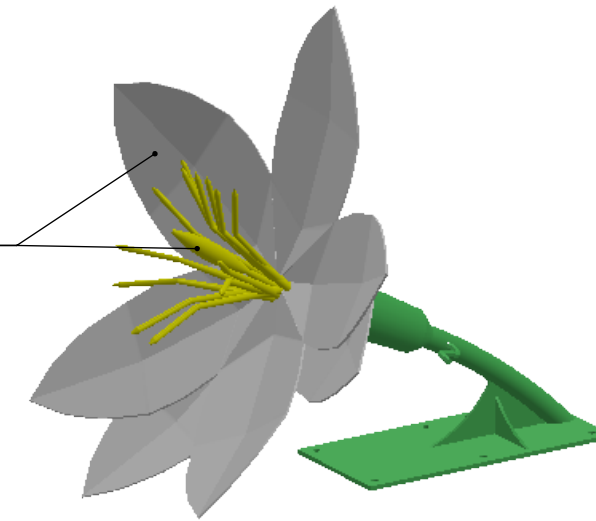

NOTE: Final fabrication model Anthers will have to be arranged in a more circular pattern

PROPRIETARY AND CONFIDENTIAL
THE INFORMATION CONTAINED IN THIS
DRAWING IS THE SOLE PROPERTY OF
EES DESIGN LLC. ANY REPRODUCTION
IN PART OR AS A WHOLE WITHOUT THE
WRITTEN PERMISSION OF
EES DESIGN LLC IS PROHIBITED.

		UNLESS OTHERWISE SPECIFIED:		NAME	DATE	EES DESIGN, LLC	
		DIMENSIONS ARE IN INCHES		DRAWN	JV	1/9/2023	TITLE: <i>Orange Blossom Flower Detail Overview</i>
		TOLERANCES:		CHECKED			
		FRACTIONAL ±		ENG APPR.			
		ANGULAR: MACH ± BEND ±		MFG APPR.			
		TWO PLACE DECIMAL ±		Q.A.			
		THREE PLACE DECIMAL ±		COMMENTS:			
		INTERPRET GEOMETRIC TOLERANCING PER:					
		MATERIAL					
		FINISH					
NEXT ASSY	USED ON					SIZE DWG. NO.	REV
APPLICATION		DO NOT SCALE DRAWING				B 22159-EN-1122	B
						SCALE: 1:20	WEIGHT:
						SHEET 4 OF 4	