

DRAFT



CITY OF TUALATIN

Water System Master Plan

March 2023

Water Master Plan

City of Tualatin

March 2023

DRAFT

Conсор

888 SW 5th Avenue
Suite 1170
Portland, OR 97204

Table of Contents

Executive Summary	ES-1
Introduction	ES-1
Water System Overview.....	ES-1
<i>Service Area</i>	ES-1
<i>Supply</i>	ES-3
<i>Distribution System</i>	ES-3
<i>Emergency Interties</i>	ES-3
Water Demand.....	ES-3
Analysis Criteria.....	ES-4
<i>Water Supply</i>	ES-4
<i>Service Pressure</i>	ES-4
<i>Fire Flow</i>	ES-5
<i>Storage Capacity</i>	ES-5
<i>Pump Stations</i>	ES-5
Water Supply Analysis.....	ES-5
Distribution System Analysis.....	ES-6
<i>Fire Flow Analysis</i>	ES-6
<i>B and C Level Transmission Capacity</i>	ES-7
<i>Storage Capacity</i>	ES-8
<i>Pump Stations</i>	ES-9
Water Quality and Conservation	ES-10
<i>Water Quality Regulations</i>	ES-10
<i>Water Conservation</i>	ES-10
Seismic Resilience Evaluation	ES-11
<i>System Backbone</i>	ES-11
<i>Seismic Hazards Assessment</i>	ES-11
<i>Summary of Recommendations</i>	ES-11
Recommended Capital Improvement Program (CIP).....	ES-12

Section 1 Introduction	1-1
1.1 Purpose	1-1
1.2 Compliance.....	1-1
1.3 Acronyms.....	1-2
Section 2 Existing Water System.....	2-1
2.1 Background and Study Area.....	2-1
2.2 Supply	2-1
2.2.1 Portland Water Bureau Wholesale Purchase	2-1
2.2.2 City Aquifer Storage and Recovery	2-6
2.2.3 Emergency Supply	2-8
2.3 Water Rights.....	2-10
2.4 Pressure Zones	2-10
2.4.1 A Level	2-11
2.4.2 B Level	2-12
2.4.3 C Level	2-13
2.4.4 Bridgeport Village	2-14
2.4.5 Corrosion Control System.....	2-14
2.5 System Summary.....	2-15
Section 3 Water Requirements	3-1
3.1 Introduction	3-1
3.2 Planning and Service Areas.....	3-1
3.2.1 Development Areas.....	3-1
3.3 Historical and Future Population Estimates	3-2
3.4 Historical Water Usage	3-5
3.4.1 Historical Water Production and Demand.....	3-6
3.4.2 Historical Water Demand Characterization	3-7
3.5 Water Demand Projections.....	3-9
3.5.1 Approach	3-9
3.5.2 Existing Equivalent Residential Units.....	3-10
3.5.3 Future ERUs and Water Demands	3-12

Section 4 Planning and Analysis Criteria 4-1

4.1 Introduction 4-1

4.2 Performance Criteria..... 4-1

 4.2.1 Water Supply..... 4-1

 4.2.2 Distribution System 4-2

 4.2.3 Service Pressure..... 4-3

 4.2.4 Required Fire Flow..... 4-3

 4.2.5 Storage Capacity 4-5

 4.2.6 Pump Stations 4-7

4.3 Seismic Resilience 4-7

4.4 Summary 4-8

Section 5 Water System Analysis 5-1

5.1 Water Supply Analysis..... 5-1

 5.1.1 Water Supply Strategy 5-1

 5.1.2 Intertie Expansion 5-2

5.2 Distribution System Analysis..... 5-2

 5.2.1 Hydraulic Model..... 5-2

 5.2.2 Modeled Water Demands..... 5-2

 5.2.3 Model Calibration..... 5-2

 5.2.4 Fire Flow Analysis..... 5-4

 5.2.5 Peak Hour Demand Analysis..... 5-5

 5.2.6 B and C Level Transmission Capacity..... 5-6

5.3 Storage Analysis 5-10

 5.3.1 Storage Capacity Analysis..... 5-10

 5.3.2 Current Storage Operational Considerations 5-12

5.4 Pump Station Analysis..... 5-15

 5.4.1 Capacity Analysis..... 5-15

 5.4.2 C Level Pumping 5-16

 5.4.3 Supply Failure Pumping..... 5-17

Section 6 Water Quality & Water Conservation 6-1

6.1 Water Quality Regulations 6-1

 6.1.1 Status of Drinking Water Regulations 6-1

6.1.2 Disinfectants/Disinfection Byproducts Rule.....	6-2
6.1.3 Total Coliform Rule.....	6-4
6.1.4 Lead and Copper Rule	6-6
6.1.5 Unregulated Contaminant Monitoring Rule.....	6-7
6.1.6 Aquifer Storage and Recovery Sampling.....	6-8
6.1.7 Additional Wholesale Provider Regulatory Issues	6-9
6.2 Water Conservation	6-9
6.2.1 Public Education and Outreach.....	6-10
6.2.2 Leak Prevention and Detection	6-11
6.2.3 Water Conservation Recommendations	6-11
Section 7 Seismic Resilience Evaluation	7-1
7.1 Introduction	7-1
7.2 Key Water System Facilities	7-1
7.2.1 Critical Customers	7-3
7.2.2 Water System Backbone	7-3
7.3 Seismic Hazards Evaluation.....	7-4
7.3.1 Seismicity and Assessment Earthquake	7-4
7.3.2 Subsurface Condition Assessment	7-5
7.3.3 Seismic Hazard Findings.....	7-7
7.4 Water Facility Seismic Vulnerability.....	7-13
7.4.1 Impact of Site Conditions	7-13
7.4.2 Impact of Structure Design, Age, and Condition	7-13
7.4.3 ASR Facilities	7-16
7.5 Pipe Fragility Analysis.....	7-16
7.5.1 Analysis Method.....	7-17
7.5.2 Pipe Installation and Materials (K Value Selection).....	7-17
7.5.3 Pipe Fragility Seismic Hazard Values	7-19
7.5.4 Pipe Fragility Findings	7-19
7.6 Emergency Plan - Valve Isolation Study.....	7-21
7.6.1 System Operations – During the Seismic Event.....	7-25
7.6.2 System Operations – Post Seismic Event, Backbone Reinstatement.....	7-25
7.6.3 System Operations – Post Seismic Event, Distribution Reinstatement	7-25

7.6.4 Next Steps.....	7-26
7.7 Design Standards for Seismic Resilience	7-26
7.7.1 Pipelines	7-26
7.7.2 Reservoirs	7-28
7.7.3 Pump Stations	7-29
7.7.4 ASR	7-29
7.8 Next Steps	7-30
7.9 Summary of Recommendations	7-30
Section 8 Capital Improvement Program (CIP)	8-1
8.1 Project Cost Estimates	8-1
8.2 Timeframes	8-1
8.3 Supply	8-2
8.3.1 PWB Supply	8-2
8.3.2 Emergency Supply Development	8-2
8.4 Storage Reservoirs	8-2
8.4.1 Reservoir Seismic Improvements	8-3
8.5 Pump Stations	8-3
8.5.1 A to B Pumping.....	8-3
8.5.2 B to C Pumping.....	8-3
8.6 Distribution Mains.....	8-3
8.6.1 Fire Flow Improvements.....	8-4
8.6.2 B Level Transmission Main.....	8-4
8.6.3 C Level Transmission Main.....	8-4
8.6.4 Replacements, Opportunity Projects, and Maintenance.....	8-5
8.7 Planning Studies	8-5
8.7.1 System-wide Planning	8-5
8.8 Additional Projects from City Planning.....	8-5
8.8.1 AWIA Improvements	8-6
8.8.2 City CIP	8-6
8.8.3 Future Service Areas.....	8-6
8.9 Capital Improvement Program	8-8
8.10 Funding Sources	8-10

8.10.1 Government Loan and Grant Programs	8-10
8.10.2 Public Debt	8-12
8.10.3 Water Fund Cash Resources and Revenues.....	8-14

Section 9 Emergency Water Plan 9-1

9.1 Introduction	9-1
9.2 Planning Process	9-1
9.2.1 Emergency Responders Workshop	9-2
9.2.2 CERT Workshop.....	9-5
9.3 Water System Recovery Plan	9-5
9.3.1 Stage 1.....	9-6
9.3.2 Stage 2.....	9-7
9.4 Improvements and Supplies	9-8

Tables

Table ES-1 Projected Water Demand	ES-4
Table ES-2 CIP Cost Summary	ES-13
Table 2-1 Emergency Intertie Summary	2-9
Table 2-2 Water Rights.....	2-10
Table 2-3 Pressure Zones	2-11
Table 2-4 Flow Control Supply Valves.....	2-16
Table 2-5 Pressure Reducing Supply Valves	2-16
Table 2-6 Pressure Reducing/Pressure Sustaining Valves.....	2-16
Table 2-7 Storage Reservoirs	2-17
Table 2-8 Pump Stations	2-17
Table 3-1 Historical and Projected Population	3-5
Table 3-2 Historical Water Production and Demand	3-7
Table 3-3 System Demands.....	3-8
Table 3-4 Existing ERUs and Developed Area Summary by Customer Class.....	3-11
Table 3-5 Estimated Existing Water Consumption and ERUs by Service Level.....	3-12
Table 3-6 Future ERUs and Water Demand Summary by Service Level	3-14
Table 4-1 Recommended Service Pressure Criteria	4-3
Table 4-2 Required Fire Flow Summary.....	4-4
Table 4-3 Water System Performance Criteria.....	4-9

Table 5-1 Calibration Confidence Results	5-4
Table 5-2 Storage Volume Recommendation Summary (MG).....	5-11
Table 5-3 Minimum Reservoir Storage Levels	5-14
Table 5-4 Pumping Capacity Needs	5-16
Table 5-5 Additional B Level Pumping Alternatives Evaluation.....	5-20
Table 6-1 Quarterly Disinfection Byproduct Monitoring Results	6-4
Table 6-2 Lead and Copper Rule Monitoring Results, 90 th Percentile	6-7
Table 7-1 Key Water System Facilities	7-4
Table 7-2 Structure Condition Rating Definitions.....	7-14
Table 7-3 Structure Seismic Performance Expectation Rating Definitions	7-15
Table 7-4 Structure Seismic Performance Investigation	7-16
Table 7-5 Pipe Fragility K Values ¹	7-18
Table 7-6 Pipe Fragility Seismic Hazard Values.....	7-19
Table 7-7 Estimated Backbone Pipe Repairs by Pressure Zone	7-20
Table 7-8 Automatic Shut-off Valve Considerations at Reservoirs	7-28
Table 8-1 Unit Costs for Distribution Main Projects.....	8-4
Table 8-2 CIP Cost Summary	8-8
Table 8-3 CIP Projects.....	8-9
Table 9-1 Emergency Water Distribution Sites Identified by Emergency Responders.....	9-4
Table 9-2 Water System Recovery Plan Phases.....	9-6
Table 9-3 Ability of Stored Water to Meet Subsistence-Level Water Needs.....	9-7
Table 9-4 Ability of ASR Well to Meet Subsistence-Level Water Needs	9-8
Table 9-5 Water System Recovery Plan Improvements and Supplies	9-9

Figures

Figure 1-1 Existing City of Tualatin Water System.....	ES-2
Figure 2-1 Existing City of Tualatin Water System.....	2-3
Figure 2-2 Water System Hydraulic Schematic	2-4
Figure 2-3 Washington County Supply Line.....	2-7
Figure 3-1 Planning Area and Service Area.....	3-3
Figure 3-2 Historical and Projected Population.....	3-4
Figure 3-3 Consumption by Customer Class.....	3-9
Figure 4-1 Storage Volumes.....	4-6

Figure 5-1 | 2020 Fire Flow Deficits5-8

Figure 5-2 | Buildout Fire Flow Deficits5-9

Figure 5-3 | Calculated Storage Volume Levels5-13

Figure 6-1 | Sampling Sites for Disinfection Byproducts.....6-3

Figure 7-1 | Target States of Recovery for Willamette Valley Water Utilities.....7-2

Figure 7-2 | Water System Backbone.....7-6

Figure 7-3 | Liquefaction Settlement7-9

Figure 7-4 | Lateral Spreading7-10

Figure 7-5 | Landslide Displacement7-11

Figure 7-6 | Peak Ground Velocity7-12

Figure 7-7 | Estimated Repair Rates for Ground Shaking – Peak Ground Velocity7-22

Figure 7-8 | Estimated Repair Rates for Ground Failure – Lateral Spreading7-23

Figure 7-9 | Estimated Repair Rates for Ground Failure – Liquefaction Settling7-24

Figure 7-10 | Valve Sequencing Post Seismic Event: Series 2 – Norwood Site to Boones Ferry
FCV/PRV7-27

Figure 8-1 | CIP Improvements8-7

Appendices

- A Portland Water Bureau Wholesale Contract Memorandum of Understanding
- B City of Tualatin Water Supply Strategy, The Formation Lab, 2021
- C Pump Station Hydraulic Performance Curves
- D City of Tualatin Water System Hydraulic Calibration Memo, Murray, Smith & Associates, Inc., 2017
- E Water System Capacity Analysis – Basalt Creek, Murraysmith, 2021
- F Seismic Hazards Evaluation, McMillen Jacobs Associates, 2018
- G Resiliency Investigation Report, Peterson Structural Engineers, 2018

Executive Summary



Executive Summary

Introduction

The purpose of this Water System Master Plan (WSMP) is to provide the City of Tualatin (City) with the information needed to inform long-term water infrastructure decisions. The objectives of the WSMP include:

- Document water system upgrades completed since the 2013 *Water Master Plan*.
- Estimate future water requirements including potential water system expansion areas.
- Identify deficiencies and recommend water facility improvements that correct deficiencies and provide for growth, including a preliminary evaluation of the water system’s seismic resilience.
- Provide suggestions for updates to the City’s capital improvement project list.
- Evaluate existing system development charges (SDCs) and water rates based on the proposed project list, as a follow-on analysis to this WSMP.
- Comply with water system master planning requirements for Public Water Systems established under Oregon Administrative Rules (OAR).

















Water System Overview

An overview of the City’s water system is shown in Error! Reference source not found..

Service Area

The City provides potable water to approximately 27,200 people through over 7,050 residential, commercial, industrial, and municipal service connections. The existing service area includes all areas within the current city limits and additional areas within the Metro Urban Growth Boundary (UGB). The study area of this planning effort includes the existing service area and expanded areas within the UGB, including the Basalt Creek area.

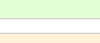
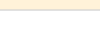
LEGEND

-  RESERVOIR
 -  PS PUMP STATION
 -  ASR AQUIFER STORAGE & RECOVERY FACILITY (ASR)
 -  PRPS DISTRIBUTION CONTROL VALVE (PRPS)
 -  PRV SUPPLY CONTROL VALVE (PRV)
 -  SUPPLY INTERTIE
 -  EMERGENCY INTERTIE
 -  WATERLINE (DIAMETER INDICATED IN INCHES)
 -  SHERWOOD
 -  PORTLAND SUPPLY MAIN
 -  CITY LIMITS
 -  METRO URBAN GROWTH BOUNDARY (UGB)
 -  COUNTY LINE
 -  RAILROAD
- PRESSURE ZONES:**
-  SERVICE AREA A
 -  SERVICE AREA B
 -  SERVICE AREA C
 -  BRIDGEPORT SERVICE AREA

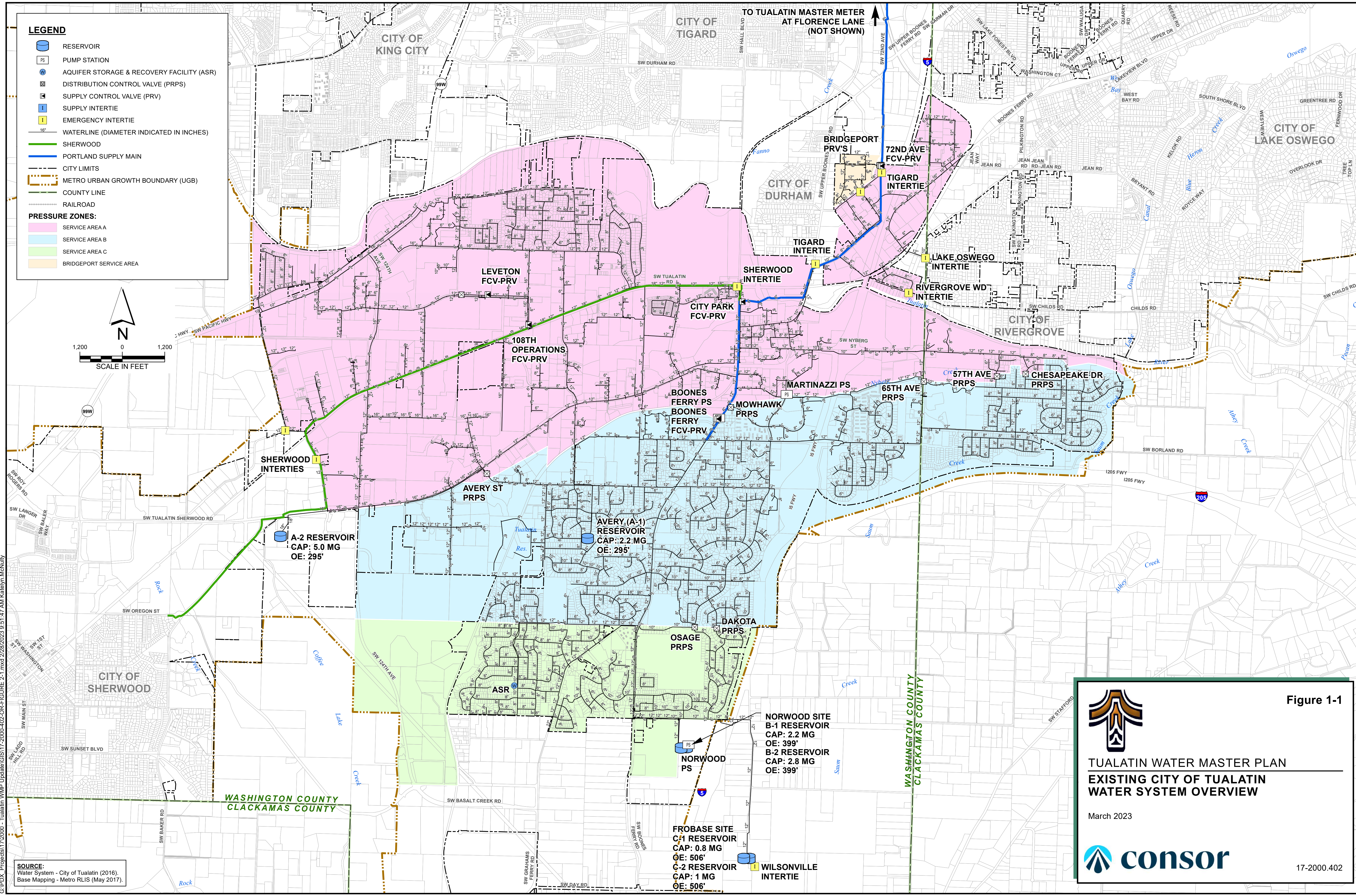
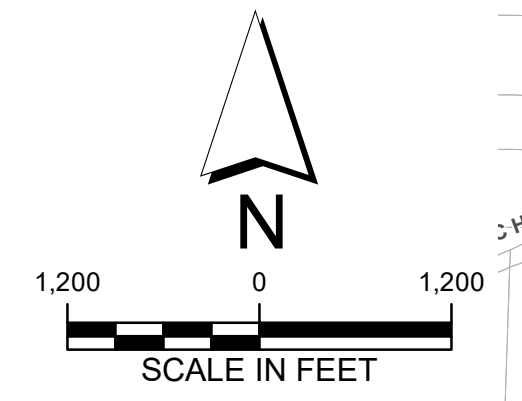

C:\PDX_Projects\172000 - Tualatin WMP Update\GIS\17-2000-402-OR-FIGURE 2-1.mxd 2/28/2023 9:51:47 AM Katelyn McNulty

SOURCE:
 Water System - City of Tualatin (2016).
 Base Mapping - Metro RLIS (May 2017).





Figure 1-1

TUALATIN WATER MASTER PLAN
EXISTING CITY OF TUALATIN
WATER SYSTEM OVERVIEW

March 2023



17-2000.402

Supply

The City purchases treated water from the Portland Water Bureau (PWB) as its sole source of water. In summer months, the City also has limited supplementary supply from its Aquifer Storage and Recovery (ASR) well. As the name implies, ASR programs work by storing treated water in an aquifer during the wet, low demand (winter and spring) season and recovering some of this stored volume in the dry, high demand (summer) season. In an emergency, the City can also supply or receive water via several emergency interties with neighboring cities.

Distribution System

The City's existing distribution system is divided into four pressure zones labelled A, B, C, and Bridgeport Village (BV) Levels. Pressure zones are usually defined by ground topography and designed to provide acceptable pressures to all customers in the zone. Zones are designated by hydraulic grade lines (HGLs) which are set by overflow elevations of water storage facilities or outlet settings of pressure reducing facilities serving the zone. An HGL approximately 100 feet above the elevation of a service connection, results in a pressure of approximately 43 pounds per square inch (psi). Pressure zone boundaries are further refined by street layout and specific development projects.

Within A, B, and C Levels, storage reservoirs provide gravity supply to looped distribution piping serving customers throughout the service area. BV Level is supplied directly from the Tualatin Supply Main (TSM) through a pressure reducing valve (PRV). The water system has 12.8 million gallons (MG) of available storage, used for water system equalizing (fluctuations in demand throughout the day), fire suppression, and emergency conditions.

Emergency Interties

The existing system has a number of emergency interties with surrounding cities. These interties connect neighboring distribution systems and have normally-closed isolation valves. The facilities are minimal and manual for each of the interties. If the City needed to supplement their system, they would need verbal agreement from the other city to manually open the isolation valve. Additionally, the station would need to be monitored manually to eliminate a water quality issue, track flow, and maintain required pressures in both systems. These interties are in place in case of emergency where the PWB supply is unavailable, but are operationally challenging to manage or operate.

Water Demand

Water demand refers to all water required by the system including residential, commercial, industrial, and irrigation uses. Demands are described using water metrics including average day demand (ADD) and maximum day demand (MDD).

Future expansion of the City’s water service area will include continued development in the Basalt Creek and Southwest Industrial Areas, as well as infill development within the existing City limits. The forecasted future water demands are calculated based on the 2020 estimate of system demand and a 0.4 percent annual growth rate, resulting in a buildout of the City’s water service area in approximately 30 years.

Population growth within the water service area was projected based on population forecasts from the Population Research Center (PRC, Portland State University, 2019). Historical demand data was used to forecast water use per residential customer as well as water use for other customer categories including commercial, industrial, and irrigation accounts. MDD was projected based on the historic ratio of MDD to ADD, also called a peaking factor. Both ADD and MDD were forecasted through 2040, shown for the planning years of 2025, 2030, 2040, and buildout in **Table ES-1**. The forecasted time steps support identification of existing and future system deficiencies, prioritization of Capital Improvement Program (CIP) projects to support development and growth, and sizing of future infrastructure to serve the long-term needs of the City.

Table ES-1 | Projected Water Demand

Year	ADD (mgd)	MDD (mgd)
2020	4.34	8.32
2025	4.69	9.00
2030	5.06	9.72
2040	5.28	10.14
Buildout	5.65	10.83

Analysis Criteria

Performance guidelines and system criteria are used with water demands presented in **Table ES-1** to assess the water system's ability to provide adequate water service under existing conditions and to guide improvements needed to provide for future water needs. Criteria are established through a review of City design standards, state requirements, American Water Works Association (AWWA) acceptable practice guidelines, Ten States Standards, the Washington Water System Design Manual, and practices of other water providers in the region.

Water Supply

Supply capacity must be sufficient to provide MDD from all sources operating together, including ASR wells, during the peak summer season. During the off-peak season, the PWB supply system must be capable of providing, off-peak season demand plus water for ASR injection.

Service Pressure

The acceptable service pressure range under ADD conditions is 50 to 80 psi. Per the *Oregon Plumbing Specialty Code*, maximum service pressures must not exceed 80 psi. During a fire flow

event or emergency, the minimum service pressure is 25 psi, which is 5 psi higher than required by Oregon Health Authority (OHA) Drinking Water Services (DWS) regulations.

Fire Flow

The distribution system should be capable of supplying recommended fire flows while supplying MDD and maintaining minimum residual pressures of 25 psi everywhere in the system.

Storage Capacity

Adequate storage capacity must be provided for each pressure zone. Recommended storage volume is the sum of four components.

- Operational Storage: the volume of water between operational setpoints of pumps (or wholesale supply connections) filling the reservoir
- Equalization Storage: the volume of water dedicated to supplying demand fluctuations throughout the day, estimated as the difference between the peak hour demand and the available supply to the pressure zone, for a duration of 150 minutes
- Fire Storage: the volume of water needed in each zone to meet the largest required fire flow for the duration specified in the Oregon Fire Code
- Emergency Storage: the volume of water needed to supply customers in each zone in the event of an emergency that makes supply to the zone temporarily unavailable, estimated as twice the ADD

Pump Stations

Pump stations should have adequate firm capacity to meet MDD in the pressure zones they serve. Firm capacity is defined as the station's pumping capacity with the largest pump out of service. In the case that a pump station serves a closed zone, or a zone with no storage or additional sources, the pumps station must provide peak hour demand plus fire flow.

Water Supply Analysis

The City conducted a separate overall Water Supply Strategy in parallel with this WSMP.

The Water Supply Strategy focused on ensuring the continued reliability of the City's water supply and documenting community values, expected current system performance during emergencies, and opportunities for improved emergency performance. The project resulted in a recommended three-prong strategy.

- **Strategy 1 - Invest in a New Backup Supply** to address the City's vulnerability to an outage of the TSM. The preferred option is to work with the City of Sherwood and the Willamette

Water Supply System (WWSS) to interconnect the WWSS Water Treatment Plant and the Sherwood Emergency Supply Main.

- **Strategy 2 – Continue to Support Reliability of the PWB System** by working with the PWB. Considerations include ensuring the City’s demands are included in future analyses of backup supply options, resolving future maintenance of the Washington County Supply Line (WCSL), and reaching agreement on a new wholesale agreement.
- **Strategy 3 – Increase Reliability of Local Interties** by working with neighboring agencies to make sure agreements are in place and test interties on a regular basis. The City should also continue to take advantage of future intertie opportunities, such as within the Basalt Creek area.

As part of this study, neighboring water agencies were also asked about their capacity to potentially provide long-term supply in the future. The intent was not to initiate a change in the City’s water supply, but instead to understand water supply availability in the region if PWB’s water were to become unavailable or unaffordable. Though short-term supplies could likely be provided by two of the neighboring water agencies, there is no agency with excess supply sufficient to meet the long-term needs of the City. *PWB remains the most reliable source of long-term supply for the City.*

Distribution System Analysis

A hydraulic network computer model was used to analyze the distribution system, which was evaluated based on the performance criteria described above and projected demands summarized in **Table ES-1**. Recommended CIP projects and pressure zone configuration or operational changes were developed based on the deficiencies identified through this analysis.

Fire Flow Analysis

Fire flow scenarios test the distribution system’s ability to provide required fire flows at a given location while simultaneously supplying MDD and maintaining a minimum residual service pressure at all services. There were two general types of deficiencies identified from the fire flow analysis:

- **Known Industrial Deficiencies in the A and B Levels** – The City is aware of fire flow deficiencies in the A and B Levels. Some of this deficiency is due to undersized and non-looped mains. To mitigate these risks, the City currently requires new customers who require large fire flows to install fire flow pumps. Increased looping in this area and upsizing of keys mains will also improve available flows.
- **C Level Deficiencies** – Most development in the C Level is residential homes less than 3,600 square feet; requiring 1,000 gallons per minute (gpm) fire flow. Larger homes or fire flows may require sprinkler use to reduce demand. As the system currently operates; a 1,000 gpm fire flow is generally available during MDD to the C Level. However, if larger homes

are constructed and sprinklers are not required, the system cannot meet these upsized demands without pumping during a fire flow or increased transmission.

B and C Level Transmission Capacity

The Basalt Creek Area located at the south end of the C Level is beginning to develop with two developments currently moving into land use approval. Existing transmission limitations through the B Level and fire flow requirements that exceed existing maximum available supply in the C Level require transmission improvements in both the B and C Levels prior to development. Findings are summarized below, and projects are incorporated into the CIP under “Transmission Improvements.”

- C Level transmission capacity between the Norwood Pump Station and C Level Reservoirs is inadequate to serve continued development in the C Level and specifically for the development of the Basalt Creek area. This deficiency results in inadequate fire flow capacity to serve proposed developments with fire flows greater than 1,000 gpm in 2020 and all fire flows by 2040.
- B Level transmission between the Boones Ferry Flow Control/Pressure Reducing Valve (FCV/PRV) and B Level Reservoirs is inadequate to supply B Level and C Level peak demands while refilling the B Level reservoirs.

Based on the summary of findings above, the City should consider the following phased improvements, which are included in the CIP.

C Level

- *Prior to Basalt Creek Development:* Development in the Basalt Creek area should not be allowed without the completion of the following improvements.
 - C Level Pump Station operational changes and permanent standby power installation to address current fire flow deficiencies to support Community Partners for Affordable Housing (CPAH) development.
 - Oversize Autumn Sunrise subdivision piping from C Level Pump Station south to Greenhill Road to 18-inch diameter when constructed.
 - New I-5 Crossing at Greenhill Road and connection to existing transmission along SW 82nd Ave, approximately 2,200 linear feet (LF) of 18-inch diameter main.
- *Long-term Recommendations:* Full development of the Basalt Creek area will require the buildout of a transmission main loop, and the following improvements to address the transmission deficiency between the Norwood Pump Station and C Level Reservoirs.

- Upsize the remaining transmission from the new I-5 Crossing up to the C Level Reservoirs to 18-inch diameter main: 1,300 LF.

B Level

- *Prior to Basalt Creek Development:* Further development of the B Level and C Level should be limited until the following improvement is completed.
 - Upsize existing transmission to 18-inch diameter main from Norwood Reservoirs to SW Ibach Street.
- *Long-term Recommendations:* With full development of the B and C Levels, further transmission improvements are recommended in the B Level.
 - Upsize existing transmission to 18-inch diameter main in SW Boones Ferry Road from SW Ibach Street to SW Sagert Street.

Storage Capacity

Storage in the A Level is currently deficient, while storage in the B and C Levels is projected to be deficient within 20 years. The City should consider constructing a 2.5 MG reservoir, similar to the existing B Reservoirs, within the next 10 years to address deficits in all levels. By buildout and as development requires, the City should consider a second reservoir to address any remaining storage deficit.

It is recommended that all new storage is combined in the B Level because reservoir site alternatives are limited in the City area, the system is relatively well connected, and A and C Level existing storage can meet most of the future storage requirements in those zones.

- The proposed B Level Reservoir sites are located adjacent to the existing B Level Reservoirs and the existing ASR well. Additional sites with sufficient elevation for ground level tanks, without dead storage, are limited within City boundaries. New sites to serve the A Level would likely include long transmission lines, or significant dead storage if collocated at existing A Level Reservoir sites. New sites to serve the C Level would face similar issues with long transmission lines. Additionally, C Level deficits are minimal by buildout and could be mostly addressed by either relying on C Level pumping for fire supply or, if the City decided to accept the risk, nesting fire flow storage within emergency storage.
- Storage at the B Level to meet A or C Level needs may also be allowed because the system is well connected. The A Level can be served by the B Level by gravity via five pressure reducing/pressure sustaining (PRPS) valves along the A/B Level boundary. These would automatically supply the A Level in the event of a failure of the A Level PWB supplies. The C Level can be served from the B Level by the C Level pump station, located adjacent to the existing B Level Reservoirs. This station can meet C Level needs through buildout, with

a single pump active. Increased transmission in the B and C Levels will also improve distribution.

- Existing storage in the A and C Levels can meet all buildout storage requirements except for 33 percent of A Level emergency storage and 20 percent of C Level emergency storage. If emergency deficits were significantly greater, or either zone did not have sufficient storage to meet daily operational requirements, combined storage in the B Level would not be recommended.

A 2.5 MG reservoir is included in the CIP within 10 years, and a 1.0 MG reservoir is included in the CIP in 20+ years. However, future development timing may require adjustment of these timelines.

Pump Stations

Pumping capacity will be discussed by zone supply, from A to B Level and from B to C Level, and evaluated based on the MDD of the zones being pumped to.

B Level Pumping

There is no pumping required under normal operating conditions from A to B Level; both receive supply from the TSM. The Boones Ferry FCV/PRV is the only supply to the B Level. Pumping from A to B would only be required under emergency or maintenance operations. There are two existing A to B Level pump stations (Martinazzi and Boones Ferry), but they are not reliably operable, have insufficient capacity (for emergency conditions), and have reached the end of their usable lives. FCV/PRVA new pump station from A to B Level is recommended for redundancy and reliability. Based on an alternatives analysis, the City should replace the Martinazzi Pump Station.

C Level Pumping

The B to C Level, Norwood Pump Station operates daily and is the only supply to the C Level. The station's existing firm capacity (largest pump out of service) of 2.02 MGD (1,400 gpm) is adequate to supply the needs of the C Level through buildout.

Additional improvements should be considered for risk mitigation:

- The City should add permanent standby power with automatic switching in the event of a power failure to the station.
- The station is not operationally redundant. This means there is no secondary supply to the C Level, whether from a pump station or PRVs from higher levels. A failure of the Norwood Pump Station or supply mains would mean total reliance on the stored water in the C Level Reservoirs, or possible emergency supply from Wilsonville via the Wilsonville Intertie. It is recommended that the City build a second C Level pump station at the existing ASR site, once a B Level reservoir is constructed onsite.

Water Quality and Conservation

Water Quality Regulations

The City, along with all public drinking water systems, must follow both state and federal regulations. At the federal level, the Environmental Protection Agency (EPA) establishes water quality standards, monitoring requirements, and enforcement procedures. At the state level, either the EPA or a state agency will implement the EPA rules. As a primacy state, Oregon administers most of the EPA's drinking water rules through the OHA DWS. The DWS rules for water quality standards and monitoring are adopted directly from the EPA. The DWS is required to adopt rules at least as stringent as federal rules. To date, the DWS has elected not to implement more stringent water quality or monitoring requirements.

At the federal level, the Safe Drinking Water Act (SDWA) is the primary drinking water regulation. It was originally enacted in 1974 by Congress to ensure the quality of America's drinking water with a focus on water treatment. The act was reauthorized and updated in 1986 and 1996 to expand protections to source water and improve operator training, system improvement funding, and public education. The SDWA contains the following assignment and programs for the EPA and the states to administer:

- State revolving loan fund for water system construction
- Public notification reports
- Source water assessment and protection
- Monitoring reductions based on source water protection
- Mandatory certification of operators

These assignments have been implemented by the EPA and/or individual states and are regularly updated. Under the authority of the SDWA, the EPA sets various rules and regulations to maintain safe drinking water.

The City currently meets all existing and proposed water quality regulations that govern the operation and performance of the water system.

Water Conservation

The City is not required by the state to develop a formal Water Management and Conservation Plan as it does not have any active municipal water rights. However, PWB requires the City to establish a joint conservation program and create a water conservation plan under the wholesale water supply agreement and the City is committed to reducing water usage.

The City implements various aspects of water conservation including:

- Public education and outreach as part of the Regional Water Providers Consortium (RWPC)
- Leak prevention and detection

Seismic Resilience Evaluation

System Backbone

Consistent with the Oregon Resilience Plan (ORP) guidelines, the City identified critical facilities and customers that will need uninterrupted or quickly restored water service following the anticipated magnitude 9.0 (M9) Cascadia Subduction Zone (CSZ) earthquake. Critical customer locations along with critical water supply and distribution facility locations were used to develop a water system “backbone” connecting key facilities and water mains.

Seismic Hazards Assessment

Seismic hazards all have the potential to damage buried water mains and other water facilities. Within the City of Tualatin water service area, these hazards were evaluated based on existing M9 CSZ earthquake hazard maps published for the Portland Metro region by the Oregon Department of Geology and Mineral Industries (DOGAMI). These maps were refined using geotechnical exploration data and subsurface boring logs from reservoirs, pump station sites, and various projects constructed near critical water facilities in the City’s water service area.

Summary of Recommendations

The seismic resilience recommendations are summarized below.

- Facility Seismic Improvements:
 - Boones Ferry FCV/PRV Improvements – Upgrades to this facility should include rehabilitation or replacement of the buried utility vault and piping transitions. This is a critical water supply facility for transmitting PWB supply to the B Level and C Level service zones.
 - A-1 Reservoir Structural Analysis – A structural analysis should be performed for this reservoir to better quantify seismic risk and determine if cost-effective mitigation strategies are available.
 - Reservoir Connections: Flexibility and Isolation – Install new flexible connections (where current flexible connections are not provided or are inadequate) and seismic isolation valves at all six of the City’s existing reservoirs. New reservoirs should be designed and constructed with these features.
 - Norwood Pump Station Improvements – Install a permanent standby generator at the Pump Station with adequate fuel storage for a minimum of 24-hours of operation.

- Backbone Piping:
 - Seismic Design Standards – Implement the seismic design standards presented in this WSMP.
 - TSM Study – Conduct a study to assess the condition and performance of the TSM, especially in the context of seismic resilience. The study should present mitigation strategies and cost considerations for City in the broader context of water supply reliability.
- Emergency Preparedness:
 - Emergency Water Plan – Implement the strategies, recommendations and improvements presented in the Emergency Water Plan, documented in this WSMP.

Recommended Capital Improvement Program (CIP)

A summary of all recommended improvement projects and estimated project costs is presented in **Table ES-2**. This CIP table provides for project sequencing by showing prioritized projects for the 5-year, 6- to 10-year, and 11- to 20-year timeframes defined as follows.

- 5-year timeframe - recommended completion through 2025
- 6- to 10-year timeframe - recommended completion between 2026 and 2030
- 11- to 20-year timeframe - recommended completion between 2031 and 2040

Estimated project costs presented in the CIP are intended to provide guidance in system master planning and long-range project scheduling and implementation. Final project costs will vary depending on actual labor and material costs, market conditions for construction, regulatory factors, final project scope, project schedule, and other factors.

Table ES-2 summarizes these projects by type and investment timeframe. The City’s proposed CIP includes significant investment, particularly in transmission and storage improvements. This new capacity will serve growth while also providing more resilient water facilities that benefit all customers. An evaluation of water rates and SDCs in support of the water system CIP will be completed as follow-on work to this WSMP.

Table ES-2 | CIP Cost Summary

Project Type	0-5 Years	6-10 Years	11-20 Years	Total
Residential Fire Flow			\$1,832,000	\$1,832,000
Non-Residential Fire Flow			\$10,522,000	\$10,522,000
System Looping		\$3,328,000		\$3,328,000
Transmission	\$10,556,000	\$6,610,000		\$17,166,000
Facilities	\$14,850,000	\$7,300,000	\$5,610,000	\$27,760,000
Pipe Replacement			\$9,900,000	\$9,900,000
Total	\$25,406,000	\$17,238,000	\$27,864,000	\$70,508,000

Notes:

1. Not all non-residential fire flow improvements may be required as some sites may have onsite pumping.
2. Pipe replacement is a perpetual ongoing cost and should be planned for. \$1,000,000/year was assumed to allow for systematic replacement of aging mains.

Chapter 1



Section 1

Introduction

1.1 Purpose

The purpose of this Water System Master Plan (WSMP) is to perform an analysis of the City of Tualatin's (City's) water system and:

- Document water system upgrades completed since the 2013 *Water Master Plan*.
- Estimate future water requirements including potential water system expansion areas.
- Identify deficiencies and recommend water facility improvements that correct deficiencies and provide for growth including a preliminary evaluation of the water system's seismic resilience.
- Provide suggestions for updates to the City's capital improvement project list.
- Evaluate existing system development charges (SDCs) and water rates based on the proposed project list, as a follow-on analysis to this WSMP.

This report is divided into nine sections to address the goals described above. The first four sections summarize the existing system and water demands, estimate future water demands, and list the performance criteria used to analyze the system. **Sections 5, 6, and 7** utilize the prior sections to identify system deficiencies, analyze current water quality and conservation goals, and provide a preliminary seismic resiliency analysis. **Section 8** summarizes recommended improvement projects to mitigate existing and projected system deficiencies and vulnerabilities and presents a financial analysis to support those projects. **Section 9** presents the Emergency Water Plan intended to address water system recovery after a catastrophic event such as a Cascadia Subduction Zone seismic event. The planning and analysis efforts presented in this WSMP are intended to provide the City with the information needed to inform long-term water supply and distribution infrastructure decisions.

1.2 Compliance

This plan complies with water system master planning requirements established under Oregon Administrative Rules (OAR) for Public Water Systems, Chapter 333, Division 61.

1.3 Acronyms

Acronym	Definition
A	
AACE	Association for the Advancement of Cost Engineering International
ADD	average daily demand
ALA	American Lifelines Alliance
ASCE	American Society of Civil Engineers
ASR	Aquifer Storage and Recovery
AWWA	American Water Works Association
B	
BV	Bridgeport Village (pressure zone)
C	
CERT	Community Emergency Response Team
CIP	capital improvement program
City	City of Tualatin
CP	cathodic protection
CPAH	Community Partners for Affordable Housing
CRBG	Columbia River Basalt Group
CSZ	Cascadia Subduction Zone
D	
D/DBP	disinfectants/disinfection byproducts
DEQ	Oregon Department of Environmental Quality
DOGAMI	Department of Geology and Mineral Industries
DWPLF	Drinking Water Protection Loan Fund
DWS	Drinking Water Services
E	
EPA	Environmental Protection Agency
ERU	equivalent residential unit
F	
FCV	flow control valve
FCV/PRV	flow control/ pressure reducing valve
FEMA	Federal Emergency Management Agency
fps	feet per second
fy	fiscal year
G	
GIS	geographic information system
gpad	gallons per acre per day
gpcd	gallons per capita per day
gpd	gallons per day
gpm	gallons per minute

Acronym	Definition
H	
HAA5s	haloacetic acids
HGL	hydraulic grade line
hp	horsepower
I	
I-5	Interstate 5
IFA	Infrastructure Finance Authority
in/s	inches per second
J	
JMP	Joint Monitoring Program
JWC	Joint Water Commission
L	
LCR	Lead and Copper Rule
LF	linear feet
LT1ESWTR	Long-Term 1 Enhanced Surface Water Treatment Rule
LT2ESWTR	Long-Term 2 Enhanced Surface Water Treatment Rule
M	
M9	magnitude 9.0
MCL	maximum contaminant level
MDD	maximum day demand
mgd	million gallons per day
MG	million gallons
mg/L	milligrams per liter
MOU	Memorandum of Understanding
MTSM	Metzger-Tualatin Supply Main
N	
NEPA	National Environmental Policy Act
NRCS	National Resource Conservation Service
O	
OAR	Oregon Administrative Rule
OFC	Oregon Fire Code
OHA	Oregon Health Authority
ORP	Oregon Resilience Plan
OWRD	Oregon Water Resources Department
P	
P3DD	peak three day demand
PHD	peak hour demand
PGD	permanent ground deformation
PGV	peak ground velocity
ppm	parts per million
PRPS	pressure reducing/pressure sustaining (Valves)

Acronym	Definition
PRV	pressure reducing valve
PSD	peak season demand
PSU PRC	Portland State University Population Research Center
PSE	Peterson Structural Engineers
Psi	pounds per square inch
PWB	Portland Water Bureau
R	
RLIS	Metro's Regional Land Information System
RR	rates of repair
RWD	Raleigh Water District
RWPC	Regional Water Providers Consortium
S	
SCADA	supervisory control and data acquisition
SDCs	system development charges
SDWA	Safe Drinking Water Act
SDWRLF	Safe Drinking Water Revolving Loan Fund
SOCs	synthetic organic contaminants
SOPs	standard operating procedures
T	
TSM	Tualatin Supply Main
TTHMs	total trihalomethanes
TVFR	Tualatin Valley Fire & Rescue
TVWD	Tualatin Valley Water District
U	
UCMR 4	Unregulated Contaminant Monitoring Rule 4
UGB	urban growth boundary
V	
VFDs	variable frequency drives
VOCs	volatile organic contaminants
W	
WCSL	Washington County Supply Line
WIFIA	Water Infrastructure Finance and Innovation Act
WRWTP	Willamette River Water Treatment Plant
WSMP	Water System Master Plan
WWSS	Willamette Water Supply System

Chapter 2



Section 2

Existing Water System

2.1 Background and Study Area

The City provides potable water to approximately 27,200 people through over 7,050 residential, commercial, industrial, and municipal service connections. The existing service area includes all areas within the current city limits and additional areas within the Metro Urban Growth Boundary (UGB). The study area of this planning effort includes the existing service area and expanded areas within the UGB, including the Basalt Creek area.

The City purchases wholesale water from the Portland Water Bureau (PWB) as its sole supply through a single 36-inch diameter supply line extending south from the Washington County Supply Line (WCSL), a major regional transmission main supplying wholesale water supply from PWB to water providers in Washington County. The City's water distribution system currently consists of four pressure zones supplied by six steel storage facilities, three pump stations (two of which are for emergency operations only), and an Aquifer Storage and Recovery (ASR) facility.

A system map and hydraulic schematic are included in **Figure 2-1** and **Figure 2-2**.

2.2 Supply

The City purchases treated water from PWB as its sole source of water. In summer months, the City also has limited supplementary supply from its ASR well. As the name implies, ASR programs work by storing treated water in an aquifer during the wet, low demand (winter and spring) season and recovering some of this stored volume in the dry, high demand (summer) season. In an emergency, the City can also supply or receive water via several emergency interties with neighboring cities.

2.2.1 Portland Water Bureau Wholesale Purchase

2.2.1.1 Wholesale Supply Contract

The City purchases finished water from PWB through a wholesale water supply contract signed in 2006. The current contract extends through 2026. Under the terms of the agreement, the City is obligated to purchase a minimum annual volume of water equal to 4.4 million gallons per day (mgd). Under the current wholesale contract terms, this volume can be increased but not decreased.

The wholesale water rate paid by the City is based on three factors: 1) the guaranteed minimum purchase (4.4 MGD), 2) the City's peak seasonal factor (1.32 for fiscal year (FY) 2021-22), and 3) the City's peak 3-day factor (1.62 for FY 2021-22). Items 2 and 3 are the ratio of the average daily water volume purchase from July 1 to September 30 and the average daily water use over the three consecutive highest days to the guaranteed minimum purchase. These peaking factors are calculated specifically for the PWB contract and are different from maximum day and peak hour peaking factors discussed later in **Section 3**.

In April of 2016, the City and PWB signed an amendment to the original wholesale agreement. This amendment updates the calculations used for determining peaking factors and summer interruptible (water provided over the minimum agreed upon volume) water purchase.

In February 2021, PWB issued a Memorandum of Understanding (MOU) Regarding the Regional Water Sales Agreement to all wholesale water providers, informing the wholesalers of PWB's intent to provide notice that PWB will not renew the current agreement. A copy of the MOU is included in this WSMP as **Appendix A**. The MOU states that it is PWB's desire to continue to supply the wholesale customers and that this notice is consistent with negotiations that have been occurring between the wholesalers and PWB regarding the framework of a new agreement. The City continues to be an active participant in the process of developing a new agreement that is in the common interest of PWB and the wholesale customers.

2.2.1.2 Wholesale Source

The PWB primarily sources its water from the Bull Run watershed, a protected watershed located near Mt. Hood. Two surface water impoundments, Bull Run Reservoir No. 1 and No. 2 store up to approximately 9.9 billion gallons in the watershed. The Bull Run Watershed averages 130 inches of precipitation per year, with the heaviest rains occurring from late fall through spring, filling the two reservoirs for storage. Because rain is scarce during the summer season, the water stored in the reservoirs is essential for meeting summer water demand. Drawdown is when PWB begins to take more water out of the reservoirs than streamflow brings in during the summer and into the fall. Streamflow provides about half of the dry season supply and gradually decreases over the summer. Fall rains typically replenish the supply in late September, but in dry years this can happen as late as November or December.

The PWB also operates a secondary groundwater supply, the Columbia South Shore Wellfield. This wellfield pulls from three regional aquifers to supplement the Bull Run surface water storage in the summer and to provide a level of source redundancy. The wellfield has a total capacity of approximately 100 mgd.

Currently, the Bull Run water is unfiltered and disinfected with chlorine at the Bull Run Reservoir No. 2 Headworks. Further treatment occurs at the Lusted Hill facility where ammonia is added to the water to form a more robust residual disinfectant, chloramines. Additionally, at Lusted Hill, the water pH is adjusted with sodium hydroxide to decrease the water's corrosive qualities. Temporary corrosion control improvements at Lusted Hill have been implemented, converting from liquid sodium hydroxide to a combination of soda ash and carbon dioxide for pH adjustment.

LEGEND

- RESERVOIR
- PUMP STATION
- AQUIFER STORAGE & RECOVERY FACILITY (ASR)
- DISTRIBUTION CONTROL VALVE (PRPS)
- SUPPLY CONTROL VALVE (PRV)
- SUPPLY INTERTIE
- EMERGENCY INTERTIE
- WATERLINE (DIAMETER INDICATED IN INCHES)
- SHERWOOD
- PORTLAND SUPPLY MAIN
- CITY LIMITS
- METRO URBAN GROWTH BOUNDARY (UGB)
- COUNTY LINE
- RAILROAD

PRESSURE ZONES:

- SERVICE AREA A
- SERVICE AREA B
- SERVICE AREA C
- BRIDGEPORT SERVICE AREA

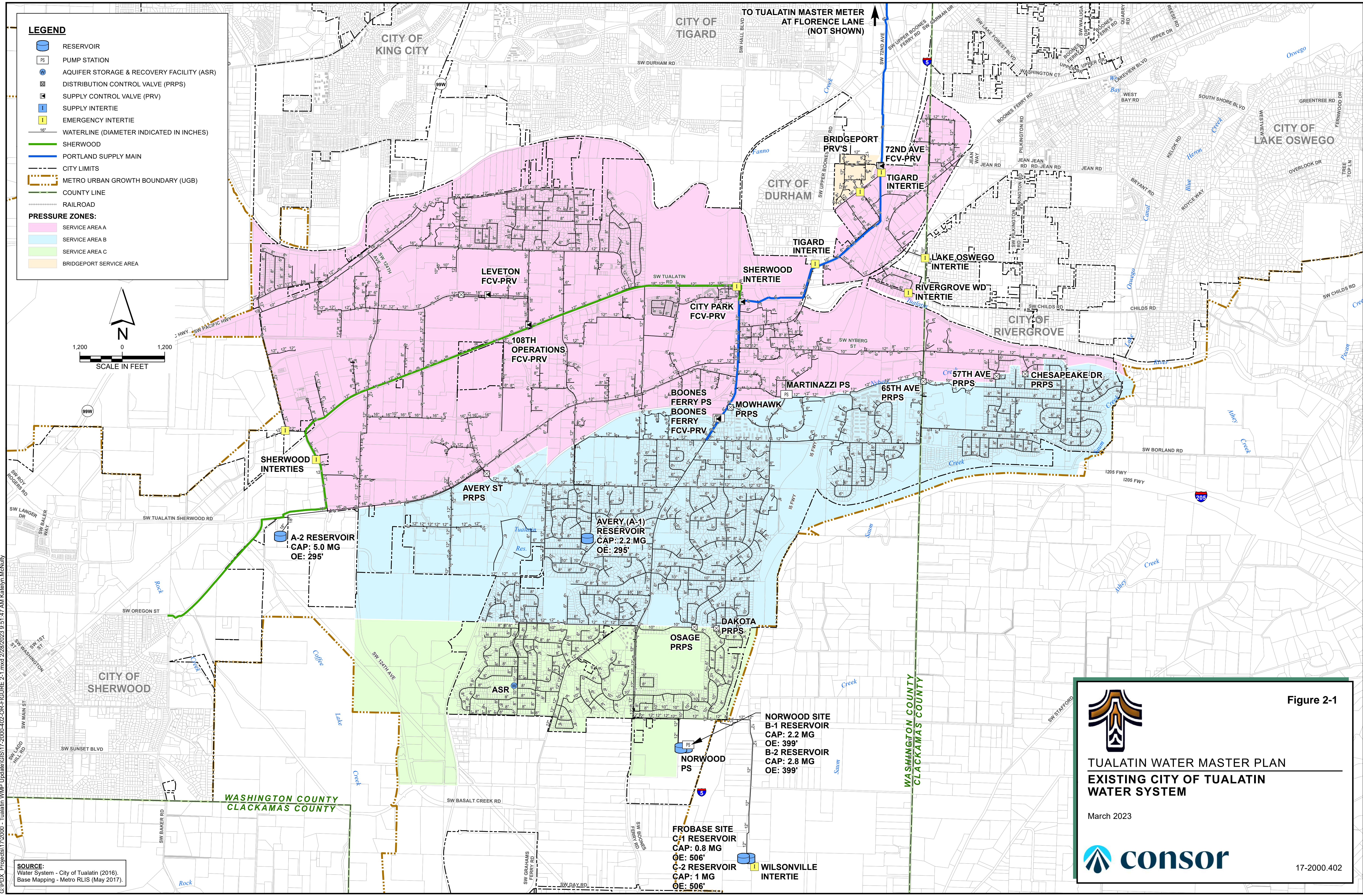
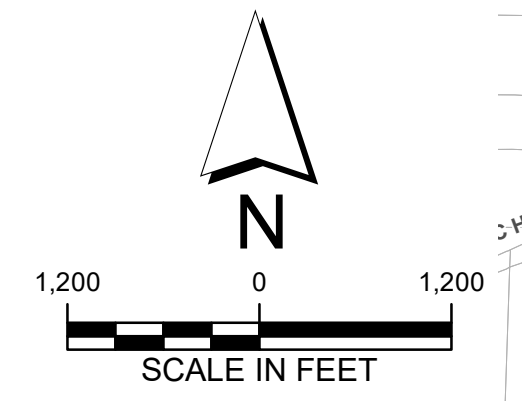

G:\PDX_Proj\cs172000 - Tualatin WMP Update\CS17-2000-402-OR-FIGURE 2-1.mxd 2/28/2023 9:51:47 AM Katelyn McNulty

SOURCE:
Water System - City of Tualatin (2016).
Base Mapping - Metro RLIS (May 2017).





Figure 2-1

TUALATIN WATER MASTER PLAN
EXISTING CITY OF TUALATIN
WATER SYSTEM

March 2023



17-2000.402

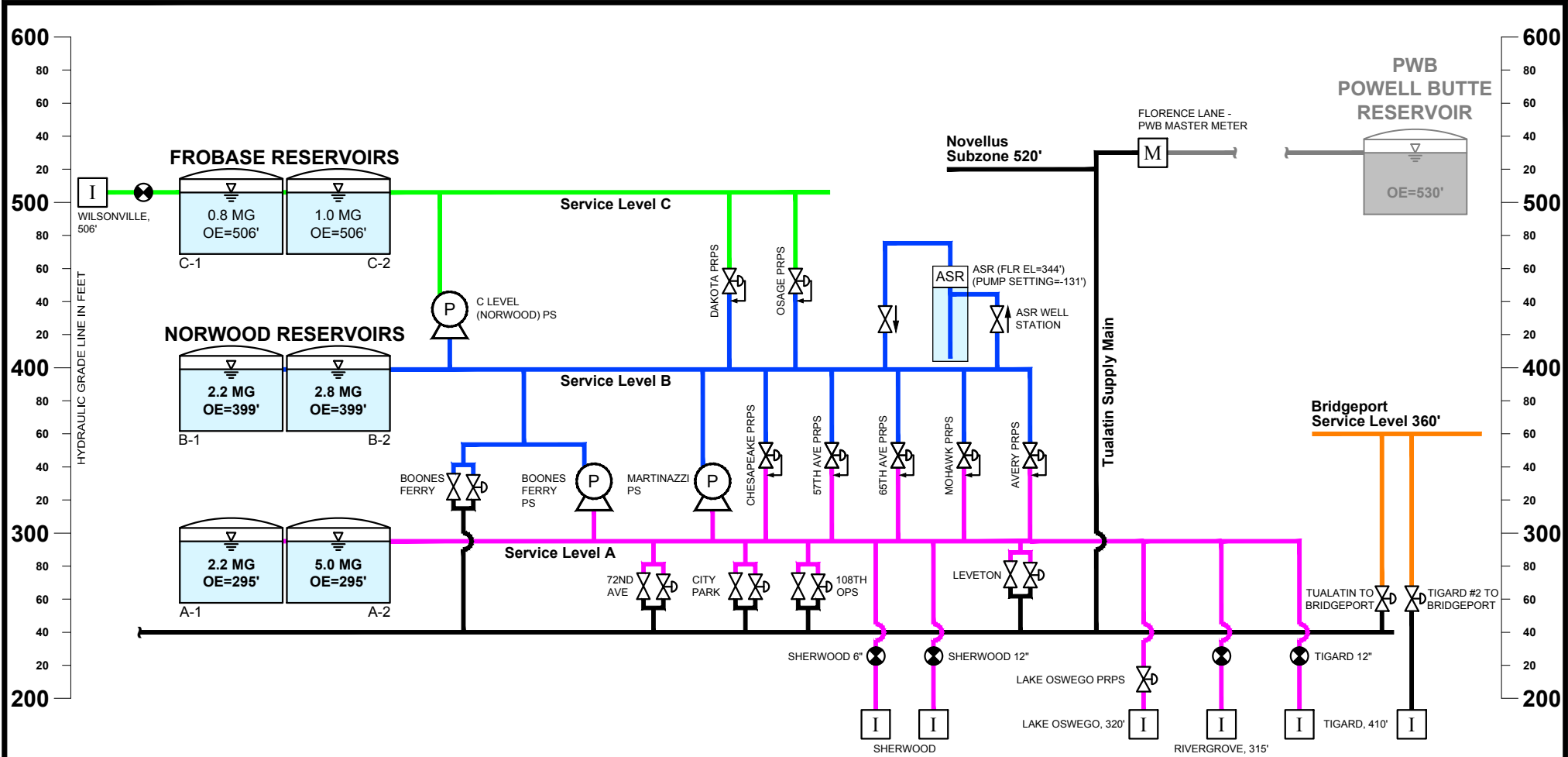

LEGEND

- SERVICE LEVEL A - 295'
- SERVICE LEVEL B - 399'
- SERVICE LEVEL C - 506'
- BRIDGEPORT SERVICE LEVEL - 360'
- FLOW CONTROL VALVE (FCV)
- PRESSURE REDUCING VALVE (PRV) OR PRESSURE RELIEF/PRESSURE SUSTAINING VALVE (PRPS)
- NORMALLY CLOSED VALVE (NC)
- AQUIFER STORAGE & RECOVERY (ASR) WELL
- EMERGENCY INTERTIE
- METER STATION
- PUMP STATION (PS)
- STORAGE TANK
CAPACITY
OVERFLOW ELEVATION



Figure 2-2

TUALATIN WATER MASTER PLAN EXISTING CITY OF TUALATIN WATER SYSTEM HYDRAULIC SCHEMATIC

March 2023



The PWB is proceeding with construction for a water treatment plant which will include filtration, disinfection, and permanent corrosion control facilities. These updates are directed to comply with the Environmental Protection Agency (EPA) requirement to address the potential for cryptosporidium contamination under the Long Term 2 Enhanced Surface Water Treatment Rule (LT2ESWTR) and are projected to be fully in place by 2027.

The construction of new infrastructure will be funded in part through wholesale rates which will affect the City’s existing rates.

2.2.1.3 Wholesale Transmission

The WCSL conveys water by gravity from PWB’s Powell Butte Reservoirs in southeast Portland to Washington County wholesale customers including the City, Tualatin Valley Water District (TVWD), and Raleigh Water District (RWD). **Figure 2-3** presents an overview of the WCSL and the PWB wholesale customers supplied by this transmission main.

The WCSL begins as a 66-inch diameter transmission line at the PWB’s two 50-million gallon (MG) Powell Butte Reservoirs and ending as a 36-inch diameter main approximately 22 miles southwest of Powell Butte in Tualatin. The 36-inch diameter section from Florence Lane to Tualatin Community Park is referred to as the Tualatin Supply Main (TSM) in this report, Details regarding the distance and diameter of the WCSL system are identified below.

WCSL Segment - From	WCSL Segment - To	Distance (miles)	Diameter (inches)
Powell Butte	SE 136 & Holgate	1.1	66
SE 136th & Holgate	SE 67th & Holgate	3.4	66
SE 67th & Holgate	Hannah Mason PS	5.3	60
Hannah Mason PS	SW B-H Hwy @ Oleson Rd	4.2	60
SW B-H Hwy @ Oleson Rd	SW 80th and Florence Ln	2.5	48
SW 90th and Florence Ln	Tualatin Community Park	5.9	36

The 36-inch diameter TSM supplies the City distribution system at five metered control valves, the southernmost connection being the Boones Ferry Road FCV/PRV. These supply connections reduce pressure from the Powell Butte level to City service pressures in the A and B Levels. Areas south of Ibach Road (the C Level) are supplied via distribution pumping from the B to the C Level.

The City of Sherwood-owned 24-inch diameter, ductile iron main branches off the TSM near Upper Boones Ferry Road within the City of Tualatin. Historically, this was used to supply the City of Sherwood from the City of Tualatin’s PWB supply connection at City Park, just south of the Tualatin River. In 2011, the City of Sherwood transitioned supply to the Willamette River Water Treatment Plant (WRWTP) near the City of Wilsonville, and so the 24-inch diameter main currently exists as an emergency intertie only.

2.2.1.4 Wholesale Transmission Ownership

Currently, the City is the furthest WCSL user to receive water from PWB. This means intermediate demands of the other customers affect the flow rate of water available, although the City has not had supply issues related to this. The City owns 18 percent of the WCSL pipe nominal capacity and approximately 58 percent of the Metzger-Tualatin Supply Main (MTSM) 48-inch diameter pipe nominal capacity. The City owns the 36-inch diameter pipe that conveys water from the Florence Lane Master Meter to the City of Tualatin (the TSM, referenced in **Section 2.2.1.3**).

2.2.2 City Aquifer Storage and Recovery

The City has operated one ASR facility since 2011. ASR operations allow the City to store surplus drinking water in a groundwater aquifer during low demand periods (fall through spring) and recover the water from a groundwater well during high demand periods (summer). Under the State of Oregon Water Resources Department authorizing limited license (ASR Limited License #010) the City can recover up to 95 percent of the water injected over the current water year (October 1 through September 30). The volume of water allowed for recovery drops by five percent each year the injected water remains in the ground.

The ASR facility is located on SW 108th Avenue near SW Dogwood Street receiving recharge water from, and recovering to, the B Level to aid in meeting B Level and C Level demands during the summer. The recharge water is injected from the City's distribution system into the well by gravity flow. A 150 horsepower (hp) vertical turbine well pump recovers water in the summer.

Onsite treatment was recently converted to a liquid feed system. During injection, water is hypochlorinated at just under 4 parts per million (ppm) to minimize the risk of biofouling in the well. During recovery, hypochlorite is added to the water to achieve a chlorine residual of 1.5 ppm and ammonia is also added to form chloramines to match the disinfectant used in the PWB supply. Both chemicals are stored onsite within the ASR well house.

The City has been operating the ASR facility as a pilot project since 2011 and more regularly in the past few years. In 2019 and 2020, recovery rates between 300 and 400 gallons per minute (gpm) were seen, depending on aquifer level and hydraulic conditions. In the 2019 water year, the City injected 77 MG and recovered 30 MG. In recent years, there have been significant breaks during the injection and recovery pumping due to maintenance and upgrades, including installation of a new automatic transfer switch, upgrade of water quality analyzers, and replacement of chemical feed systems.

LEGEND

KEY WATER FACILITIES

- RESERVOIR
- PUMP STATION
- PWB DISTRIBUTION CONNECTION
- MASTER METER
- BYPASS

TRANSMISSION MAINS

- WCSL/PWB TRANSMISSION
- TVWD TRANSMISSION
- SHERWOOD TRANSMISSION
- TUALATIN SUPPLY LINE

POLITICAL BOUNDARIES

- COUNTY LINE
- METRO URBAN GROWTH BOUNDARY (UGB)
- CITY LIMITS
- TAXLOTS

TUALATIN PRESSURE ZONES:

- SERVICE AREA A
- SERVICE AREA B
- SERVICE AREA C
- BRIDGEPORT SERVICE AREA

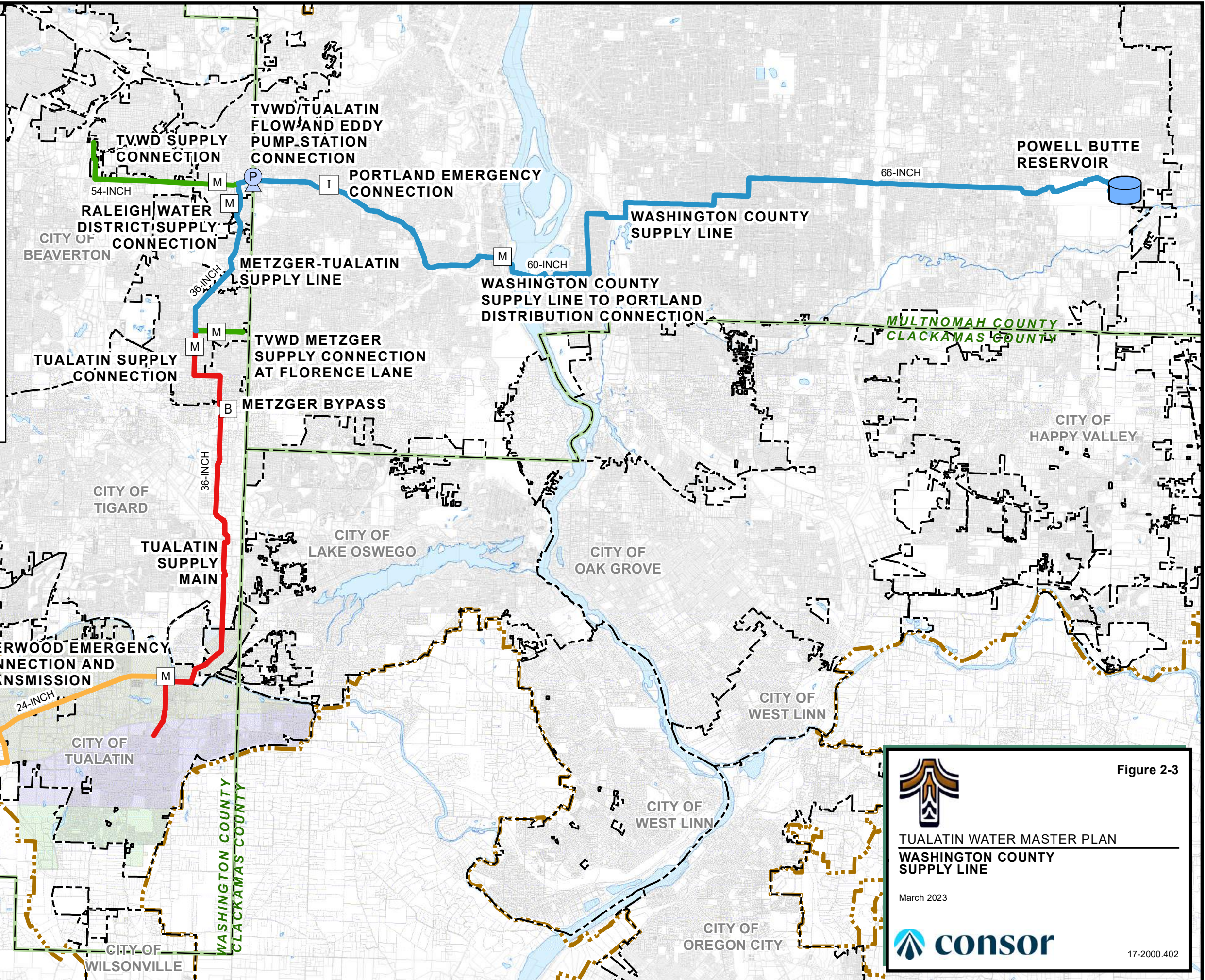
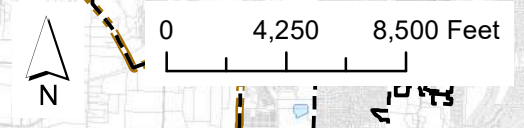

G:\PDX Projects\17-2000 - Tualatin WMP Update\GIS\17-2000-402-OR-FIGURE 2-3.mxd 2/28/2023 11:42:20 AM Katelyn McNulty

SOURCE:
 Water System - City of Tualatin (2016).
 Base Mapping - Metro RLIS (May 2017).

Figure 2-3

TUALATIN WATER MASTER PLAN
WASHINGTON COUNTY SUPPLY LINE

March 2023

17-2000.402

2.2.3 Emergency Supply

2.2.3.1 Emergency Interties

Several emergency interties with neighboring water providers potentially allow for alternate supply during emergencies. However, these interties are rarely, if ever, used or maintained and supply capacity is often severely limited and dependent on operational conditions of the supplying system. Additionally, the City is not legally allowed to use certain interties due to the 2002 City Charter amendment prohibiting drinking water sourced from the Willamette River without a citizen vote (Chapter 10, Section 46 of the City Charter), with the exception of an emergency declaration by the State of Oregon (such as would likely occur following a large seismic event).

Existing interties include connections with the Cities of Tigard, Sherwood, Wilsonville, and Lake Oswego, and the Rivergrove Water District. Except for the Tigard intertie at 72nd and Boones Ferry which provides additional fire flow to the Bridgeport Village, all emergency interties exist as normally closed valves that are manually operated. **Figure 2-1** shows the location of these emergency interties and **Table 2-1** summarizes important details.

Table 2-1 | Emergency Intertie Summary

Intertie	Water Source	Type	Hydraulic Grade (Tualatin Level)	Hydraulic Grade (Other)	Diameter ¹ (in)
Willamette Water Supply System (124th and Tualatin-Sherwood Road)	Willamette River	Emergency ²	295 (A)	~450	12
Lake Oswego (LO) (65th & McEwan)	Clackamas River (Tigard-LO Partnership)	Emergency	295 (A)	320	12
Tigard (Boones Ferry & Lower Boones Ferry)	Clackamas River (Tigard-LO Partnership)	Emergency	295 (A)	410	10
Tigard (72nd & Boones Ferry) ³	Clackamas River (Tigard-LO Partnership)	Fire flow (Bridgeport Village)	360 (BV)	410	10
Rivergrove (65th & Childs)	Rivergrove Wellfield	Emergency	295 (A)	315	8
Sherwood - Supply Main (City Park)	Willamette River WTP	Emergency ²	295 (A)	380	24
Sherwood (Cipole and Galbreath)	Willamette River WTP	Emergency ²	295 (A)	380	12
Wilsonville (Frobase Site)	Willamette River WTP	Emergency ²	506 (C)	506	8

Notes:

1. Intertie capacity is unknown. Pipe diameters can be used to approximate capacity, however available supply is dependent on boundary conditions of both supplying and receiving systems.
2. Connection with the Willamette Water Supply System. Currently, use of this intertie is limited to water supply following an emergency declaration by the State of Oregon.
3. Bridgeport Village Intertie located at 72nd & Boones Ferry. There is both a fire flow connection (10-inch to 10-inch) and a separate intertie (10-inch to 10-inch) near this location. The intertie is around the corner and can connect into the A Level distribution system with an HGL of ~410 ft on the Tigard side and ~295 ft on the Tualatin side. This intertie can also connect to the TSM. As its pressure is lower than the normal pressure in the TSM, PWB supply would need to be valved off (which would likely be the case if the TSM were out of service). Because of the reversed hydraulics, this intertie is not usually listed in the City’s emergency connections.

2.2.3.2 Tualatin Valley Water District Portable Pump Stations

In 2014, the City and TVWD recognized their vulnerability to PWB supply failures. In response, the construction and purchase of two portable pumps was finalized (named “Flow” and “Eddy”) for emergency use in a PWB supply disruption. The piping near the TVWD meter at the intersection of Beaverton Hillsdale Highway and Oleson Road was reconfigured to allow for emergency connection of the pumps between TVWD’s transmission main and the WCSL. Each pump has a capacity of 5MGD and is designed to supply water from the Joint Water Commission (JWC) or other TVWD-Wolf Creek water supplies along Oleson Road towards TVWD-Metzger and Tualatin customers through the WCSL and the TSM. It is understood that the B Level could be supplied from this configuration with the portable pumps.

2.2.3.3 Inter-Pressure Zone Pumping Connections

Three six-inch diameter flange stubs are located at grade to allow for external temporary pumping from the A to B and B to C Levels. These stubs are located at the B-1 and B-2 Reservoirs (Norwood) site, the Martinazzi Pump Station, and at 10900 SW Avery Street where the B and C levels meet.

These sites are for emergency use only and will require the use of a portable pump station to provide minimal supply to localized areas near the connection point. Presently, the City does not own a portable pump station, but is acquiring appurtenances (flange connections and hoses) to support emergency pumping. Further discussion is included later in this document.

2.3 Water Rights

While the City does not hold any municipal drinking water rights, it does hold a limited license for ASR operations, summarized in **Table 2-2**.

The City’s single ASR facility operates under Oregon Water Resources Department (OWRD) ASR Limited License No. 010, which was most recently renewed for an additional five years on May 12, 2019. This Limited License authorizes the City to operate an ASR system of up to five wells storing 475 MG of water for a combined recovery of up to 3,500 gpm during the summer season. Presently, the City does not use the full Limited License authorized rate.

Table 2-2 | Water Rights

Permit No.	Certificate No.	Authorized Use	Priority Date	Authorized Rate	Description
ASR LL #010	N/A	ASR	2004	2,750/3,500gpm injection/recovery	ASR injection and recovery

2.4 Pressure Zones

The City’s existing distribution system is divided into four pressure zones labelled A, B, C, and Bridgeport Village (BV) Levels. Pressure zones are usually defined by ground topography and designed to provide acceptable pressures to all customers in the zone. Zones are designated by hydraulic grade lines (HGL) which are set by overflow elevations of water storage facilities or outlet settings of pressure reducing facilities serving the zone. An HGL approximately 100 feet above the elevation of a service connection, results in a pressure of approximately 43 pounds per square inch (psi). Pressure zone boundaries are further refined by street layout and specific development projects.

Each of the four pressure zones is summarized in **Table 2-3** and illustrated on **Figure 2-1**. This information is presented in more detail in the following sections including descriptions of the service area, supply mechanism, storage facilities, and pumping facilities serving each zone.

Table 2-3 | Pressure Zones

Zone Name	HGL (ft)	Primary Customer Type	Current ADD (mgd)	Current MDD (mgd)	Usable Storage (MG) ¹	Max Fire flow Required (gpm)
A Level	295	Commercial, industrial, residential	2.24	4.28	6.0	3,000
B Level	399	Residential, commercial, industrial	1.46	2.79	5.0	3,000
C Level	506	Residential, institutional	0.34	0.65	1.8	2,000
BV Level	360	Commercial	0.03	0.06	0	3,000

Note:

Usable storage calculated as the potential volume of water stored above the tank height that can provide 20 psi to all zone customers.

2.4.1 A Level

The A Level covers Tualatin north of SW Tualatin-Sherwood Road and includes a broad array of customer types including commercial, industrial, and residential (see **Figure 2-1**).

2.4.1.1 Supply

The A Level is supplied by four FCV/PRVs off the TSM. These valves drop the hydraulic grade from approximately 530 feet, as set by the PWB Powell Butte Reservoir, to 295 feet, as set by the A Level Reservoirs. The four valves are located at 72nd Avenue, City Park (located in Tualatin Community Park at SW Tualatin Road), 108th Avenue/Operations, and Leveton. 72nd Avenue, 108th/Operations, and Leveton supply most of the flow. The valves are primarily operated in flow control mode, meaning that the valve modulates to maintain a constant flow rate that is set by City staff. These control valves also have an overriding pressure setting to maintain pressures within an acceptable service range on either side of the valve. The Leveton FCV/PRV supplies an area of higher pressure within the A level to meet the water supply needs of industrial customers.

In an emergency, five PRPS can provide limited supply from the B Level. These valves are located along the interface between the A and B Levels. The PRPS valve will open when the A Level pressure drops below a set point and shut either when the A Level pressure rises above that set point or the B Level pressure drops below a second set point that prevents the pressure in B level from dropping below minimum acceptable levels. These valves are intended only for emergency supply. The flow rate available through the PRPS valves can range from less than 100 gpm up to 1,000 gpm or more, depending on reservoir levels and water demands.

2.4.1.2 Storage

Storage in the A Level is provided by two welded steel tanks with a combined total volume of 7.2 MG. The A-1 tank, formerly known as the Avery tank, was built in 1971. It is located in the residential area south of Avery Road. The A-2 tank was built in 2006 and is located west of the City,

just south of Tualatin-Sherwood Road. When A Level tanks drop below 8 feet in depth, static pressures in the A Level are less than 25 psi. Therefore, the A Level reservoirs have approximately 1.2 MG of dead storage (bottom 8 feet of both tanks) and a combined accessible storage of 6 MG.

2.4.1.3 Distribution

The A Level distribution piping is looped with 12-inch diameter mains primarily along Herman, Tualatin-Sherwood, and Nyberg Roads. A 16-inch transmission line beneath the Tualatin River connects the portions of the A Level north and south of the Tualatin River. Additional 16-inch and 18-inch diameter mains extend along Tualatin-Sherwood Road from Avery Street west, and a 16-inch diameter main extends north-south between Tualatin-Sherwood Road and Herman Road.

2.4.2 B Level

The B Level primarily serves customers south of SW Tualatin-Sherwood Road and north of Ibach Street (see **Figure 2-1**).

2.4.2.1 Supply

During normal operations, the B Level is supplied by a single FCV/PRV off the TSM at Boones Ferry Road. This valve drops the hydraulic grade from approximately 530 feet, as set by the PWB Powell Butte Reservoir, to 399 feet, as set by the B Level Reservoirs. This valve is set by flow control and operates in two conditions: reservoir filling and reservoir supply. During reservoir filling, the valve supplies approximately 3,100 gpm to the B Level customers with excess supply filling the B Reservoirs, with the limitation on available capacity being over pressurization of low elevation customers in the B level. The C Level pump station subsequently pumps out of the B Reservoirs to supply the C Level. During reservoir supply (low demand periods), to facilitate turnover of water in the B Level Reservoirs, the Boones Ferry valve operates at approximately 400 gpm (during periods when the ASR well is not being recharged).

There are times at which a combination of factors including high system demands, simultaneous low tank levels in the B and C Levels, and supply limitations that result in unsatisfactory supply to the B and C Levels. This deficiency is addressed in further detail in **Section 5**.

Additional supply comes from the City's ASR facility, which is connected to the B Level distribution system. In the winter, water is injected into the aquifer from the B level at a rate of approximately 350 to 400 gpm. In the summer, water is recovered from the aquifer and supplied to the B level at a rate of 350 gpm. Additional explanation of ASR operations is included earlier in **Section 2.2.2**.

In an emergency, two PRPS valves exist at Osage Street and Dakota Avenue can provide limited supply from the C Level to the B level. These valves operate in the same way as the PRPS valves from the B to A Levels.

2.4.2.1.1 Pump Stations

Historically, the Martinazzi Pump Station and the Boones Ferry Pump Station supplied water to the B Level, pumping water from A Level distribution. However, these pump stations have not been operated as part of normal system operation for at least 20 years. As such, the ability to reliably operate these stations in the event of a supply failure of either the Boones Ferry FCV/PRV or PWB supply through the TSM is uncertain at this time. Further analysis of the functionality and value of the pump stations is presented in **Section 5**.

The Boones Ferry Pump Station is located near the intersection of SW Boones Ferry Road and SW Mohawk Street in a buried, pre-fabricated vault. The pump station is adjacent to the Boones Ferry FCV/PRV and has historically been used to pump water from the A to B Levels. The pump station houses two 25-hp, 500 gpm centrifugal pumps. The Boones Ferry Pump Station has not been upgraded or exercised in at least a decade. Extensive studies and upgrades would likely be required to operate the station at a reliable level of service.

The Martinazzi Pump Station is located near the northeast corner of the intersection of SW Martinazzi Avenue and SW Warm Springs Street in a below grade, cast-in-place, concrete vault. The pump station is used to pump water from the A to B levels. The pump station currently houses two centrifugal 50-hp pumps, each with a nominal capacity of approximately 1,000 gpm. The pump performance curves for the Martinazzi Pump Station pumps are included as **Appendix C**.

2.4.2.2 Storage

Storage in the B Level is consolidated at the Norwood site, south of the City near the Horizon Christian School. Two welded steel tanks provide a total of 5.0 MG of storage at an overflow elevation of 399 feet. The 2.2 MG B-1 Reservoir was built in 1971 and the 2.8 MG B-2 Reservoir was built in 1989. Both were seismically upgraded to 2006 standards. The B-1 Reservoir received a new concrete ringwall, manway, anchor bolts, and new welded steel anchor chairs. The B-2 Reservoir received similar upgrades and additional pipe modifications. The B-1 Reservoir was repainted and sandblasted in 2015 and similar rehab to the B-2 Reservoir is planned.

2.4.2.3 Distribution

The B Level distribution system is looped with 12-inch diameter lines along Sagert Street, Avery Street, Borland Road and Boones Ferry Road, and along Ibach Street to the ASR facility. The B Reservoirs are connected to the rest of the B Level distribution system by approximately 4,800 LF of 12-inch diameter cast iron main.

2.4.3 C Level

The C Level primarily serves residential customers south of Ibach Street (see **Figure 2-1**).

2.4.3.1 Supply

The C Level is supplied only by the Norwood Pump Station at the Norwood site. The pump station was upgraded in 2009 and houses twin 75 hp, 1,400 gpm pumps with variable frequency drives (VFDs). The pump performance curves for the Norwood Pump Station are included as **Appendix C**. In the event of a power outage, the station is equipped with automatic switching for continued operation with a mobile standby generator.

2.4.3.2 Storage

The Norwood Pump Station pumps from the B Level to the C Level Reservoirs located at the Frobase site, south of the City. The 0.8 MG C-1 tank was built in 1981 and underwent seismic improvements including construction of a new concrete ringwall and concrete collar around the base of the tank in 2006. Further seismic improvements completed in 2017, included installation of a new roof and center column to raise the available freeboard for sloshing during a seismic event. The C-2 tank was built in 2016 and provides an additional 1.0 MG of storage.

2.4.3.3 Distribution

Distribution mains in the C Level are primarily looped, 8- and 10-inch diameter residential distribution mains with a 10-inch diameter main from Iowa Street to Grahams Ferry Road and 12-inch diameter mains in Grahams Ferry Road and Boones Ferry Road. From immediately west of Interstate 5 (I-5), extending east on Norwood Road across I-5 and south, the piping between the Norwood Pump Station and the C Level (Frobase) Reservoirs is a single dead end 12-inch diameter main.

2.4.4 Bridgeport Village

The BV Level is an isolated zone supplying commercial customers within Bridgeport Village, north of the City (see **Figure 2-1**).

Bridgeport Village does not contain gravity storage. Instead, the BV Level is constantly supplied directly from the TSM through the SW 82nd Avenue PRV which drops the hydraulic grade from approximately 530 feet to an HGL of approximately 360 feet (or approximately 80 psi) in the BV Level. A second PRV from the City of Tigard is available for additional fire suppression flow capacity, or in the event the pressure downstream of this valve drops below 65 psi (15 psi lower than normal).

2.4.5 Corrosion Control System

Corrosion of metal (such as a pipeline or reservoir) is a natural process by which the refined metal returns to its original native mineral state as an ore (the familiar red rust). The process is an electrochemical reaction between the metal and its environment that results in a loss of material

at the anode (the pipe or reservoir wall). Stray current from rail, high voltage power lines, and other utilities can accelerate this process if infrastructure is not protected.

Soil corrosivity also affects corrosion. The City has not conducted a corrosion study to determine local soil corrosivity. Anecdotally, the City does not experience significant corrosion, so it is likely the soil is not very corrosive.

There are several methods of protecting infrastructure from corrosion including passive cathodic protection (CP), active CP, and other physical methods.

- In a passive CP system, a sacrificial material is added to the circuit, often in the form of zinc and/or magnesium plates buried in the soil and connected to the pipeline with a wire. Zinc and magnesium oxidize more readily than steel or cast iron and therefore corrosion occurs at the anode rather than the pipe.
- An active CP system or impressed current system includes the addition of an electrical current to the pipeline to further force the reaction away from the pipeline and using the pipe as the anode.
- Physical barriers can also limit corrosion. These include methods such as poly-wrap or coatings.

The City has installed a passive CP system on the TSM within the system and an active CP system on large diameter piping north of 72nd Avenue to Florence Lane. Four of the reservoirs (A-1, B-1, B-2, and C-1) all have functioning active CP systems. The active CP system at the C-2 Reservoir, built in 2016, has not yet been connected. This is common practice to provide sufficient time for possible manufacturing errors in the coating to be fixed within the warranty period by the contractor. The A-2 Reservoir, built in 2006, does not have a CP system.

2.5 System Summary

The following tables summarize the components of the City's Water System.

Table 2-4 | Flow Control Supply Valves

Valve ID	Upper Zone	Lower Zone	Valve Diameter (in)	October - May		June - September	
				Low Setting (gpm)	High Setting (gpm)	Low Setting (gpm)	High Setting (gpm)
72nd Ave	TSM	A	6/12	200	700	500	1,000
City Park	TSM	A	3/12	50	100	50	100
108th/Operations	TSM	A	8/12	200	800	400	1,200
Leveton	TSM	A	4/12	50	400	100	600
Boones Ferry	TSM	B	10/-	400	2,200	1,000	3,100

Table 2-5 | Pressure Reducing Supply Valves

Valve ID	Type	Upper Zone	Lower Zone	Ground Elev. (ft)	Valve 1 Diameter (in)	Valve 2 Diameter (in)	Valve 1 Setting (psi)	Valve 2 Setting (psi)
Bridgeport (Portland)	PRV	TSM	BV	175	3	8	360	348
Bridgeport (Tigard)	PRV	Tigard	BV	175	3	8	325	318

Table 2-6 | Pressure Reducing/Pressure Sustaining Valves

Valve ID	Upper Zone	Lower Zone	Pressure Reducing Setting		Pressure Sustaining Setting	
			(psi)	(HGL)	(psi)	(HGL)
Avery Street	B	A	35	251	84	364
65th Avenue	B	A	50	246	99	359
Chesapeake Drive	B	A	28	265	78	380
Mohawk Street	B	A	41	255	91	370
57th Avenue	B	A	34	242	84	357
Dakota Drive	C	B	33	358	84	476
Osage Street	C	B	33	356	84	474

Note:

These valves typically remain closed. Pressure reducing function activates to supply lower zones in the event of an emergency, or high flow event as all zones are primarily served by other means.

Table 2-7 | Storage Reservoirs

Reservoir Name	Max Volume (mg)	Available Capacity (mg)	Floor Elevation (ft)	Overflow Elevation/ Max. Water Depth (ft)	Shell Height (ft)	Year built	Type	Dia (ft)
A-1 (Avery)	2.2	1.8	248	295/ 47	50	1971	Steel	90
A-2	5.0	4.2	248	295/ 47	52	2006	Steel	135
B-1 (Norwood)	2.2	2.2	352	399/ 47	50	1971	Steel	90
B-2 (Norwood)	2.8	2.8	352	399/ 47	50	1989	Steel	100
C-1 (Frobese)	0.8	0.8	458.5	507.5/ 49	53	1981	Steel	54
C-2 (Frobese)	1.0	1.0	458.5	507.5/ 49	53	2016	Steel	59

Note:

As noted earlier in this section, maximum volume reflects the maximum volume of water stored in the reservoir. Where storage is below an elevation required to provide 25 psi to customers, it is considered dead storage and not included in available capacity.

Table 2-8 | Pump Stations

Pump Station	Facility Type ¹	Supplying Zone	Receiving Zone	No. of Pumps	Individual Pump Capacity (gpm)	Firm Capacity (gpm) ²	Pump Type
Martinazzi ³	Emergency	A	B	2	1,000	1,000	End-Suction Centrifugal
Boones Ferry	<i>As discussed early in this section, the Boones Ferry PS is no longer considered operational, and is not part of the active water system analyzed in this WSMP.</i>						
C Level (Norwood) ³	Distribution System	B	C	2	1,400	1,400	End-suction centrifugal

Notes:

1. Facility type indicates how the station functions in the system. The City has one distribution system pump station (C Level) that is required for normal service and is operated daily. The City has one permanent emergency station that may be available for emergency use to pump water from the A to B levels, if the Boones Ferry FCV/PRV is out for an extended period. Recent operation of this pump station has been limited so it is not guaranteed supply.
2. Firm Capacity: Operating capacity with largest pump out of service.
3. Pump performance curves are included in **Appendix C** of this WSMP.

Chapter 3



Section 3

Water Requirements

3.1 Introduction

This section presents the development of water demand forecasts for the City's water service area. Population and water demand forecasts are developed from regional and City planning data, current land use designations, historical water demand records, and previous City water supply planning efforts. A description of the water service area limits is also included in this section.

The City conducts an annual demand estimate as part of their contract with the PWB. The annual demand estimates are used to determine peak three-day demand, peak season demand, annual demand, and interruptible water demand. These values may be different from the ones calculated in this section and should not be interchanged.

3.2 Planning and Service Areas

The current water service area includes the area within the existing city limits plus two small areas outside the city limits that are served by the City. The entire Bridgeport Village commercial area in the northeast is served by the City including the movie theater that is in the City of Tigard. East of the freeway, the residential lots between the Tualatin River and SW Childs Road in the City of Rivergrove, as well as the commercial/industrial area between SW 63rd Avenue and I-5, are also served by the City. These areas are illustrated in **Figure 3-1**.

3.2.1 Development Areas

Two large development areas are currently under consideration for City service: the Basalt Creek Area and the Southwest Industrial Area. Both areas are expected to begin development within the 20-year planning period of this WSMP. In addition, this WSMP provides a cursory look at impacts of potential service to the Stafford Urban Reserve area that could be brought into the UGB in the future and incorporated into the City.

3.2.1.1 Basalt Creek Area

The Basalt Creek Area is located south of the city limits, within the UGB, and just north of the City of Wilsonville. The area will be served by both cities, divided into north and south sections approximately along Greenhill Road. The area highlighted in **Figure 3-1** is the area anticipated to be served by the City of Tualatin.

Annexation to the City of Tualatin in the Basalt Creek area, including specific local roadways and development configurations will be determined with the review and approval of land use applications. A combination of single family residential, multifamily residential, and commercial development is expected in currently vacant land within the City's service area.

3.2.1.2 Southwest Industrial Area

The Southwest Industrial Area was studied in the prior WSMP, although development in the area has still not occurred. The area is located southwest of the City and within the UGB.

The updated development plan includes a mix of industrial and commercial zoning. However, the Tigard Sand and Gravel Quarry is currently operating in the area and is expected to continue operations through this planning period. Therefore, for the purpose of this plan, development will be assumed to be restricted to select taxlots north and south of the quarry. There is no expected increase in population from this area, although some water intensive industries could drastically increase the water demand, if allowed by the City.

3.3 Historical and Future Population Estimates

In 2020, Tualatin supplied water to approximately 27,195 residents. Current and historical population estimates for the City were taken from the 2020 Portland State University Population Research Center (PSU PRC) population estimates and are presented in **Figure 3-2**. Over the past five years, the average annual growth rate in the City has been approximately 0.4 percent with a maximum annual rate of 1.6 percent in 2013.

Based on known population drivers, the City is expected to continue experiencing growth at a similar rate. Using the past five-years' 0.4 percent average growth rate, the 5-, 10-, 20-, and 50-year projection population forecasts were calculated and are presented in **Table 3-1** and **Figure 3-2**. These projections will be used to determine the timing of water supply and infrastructure upgrades and are addressed later in this section.

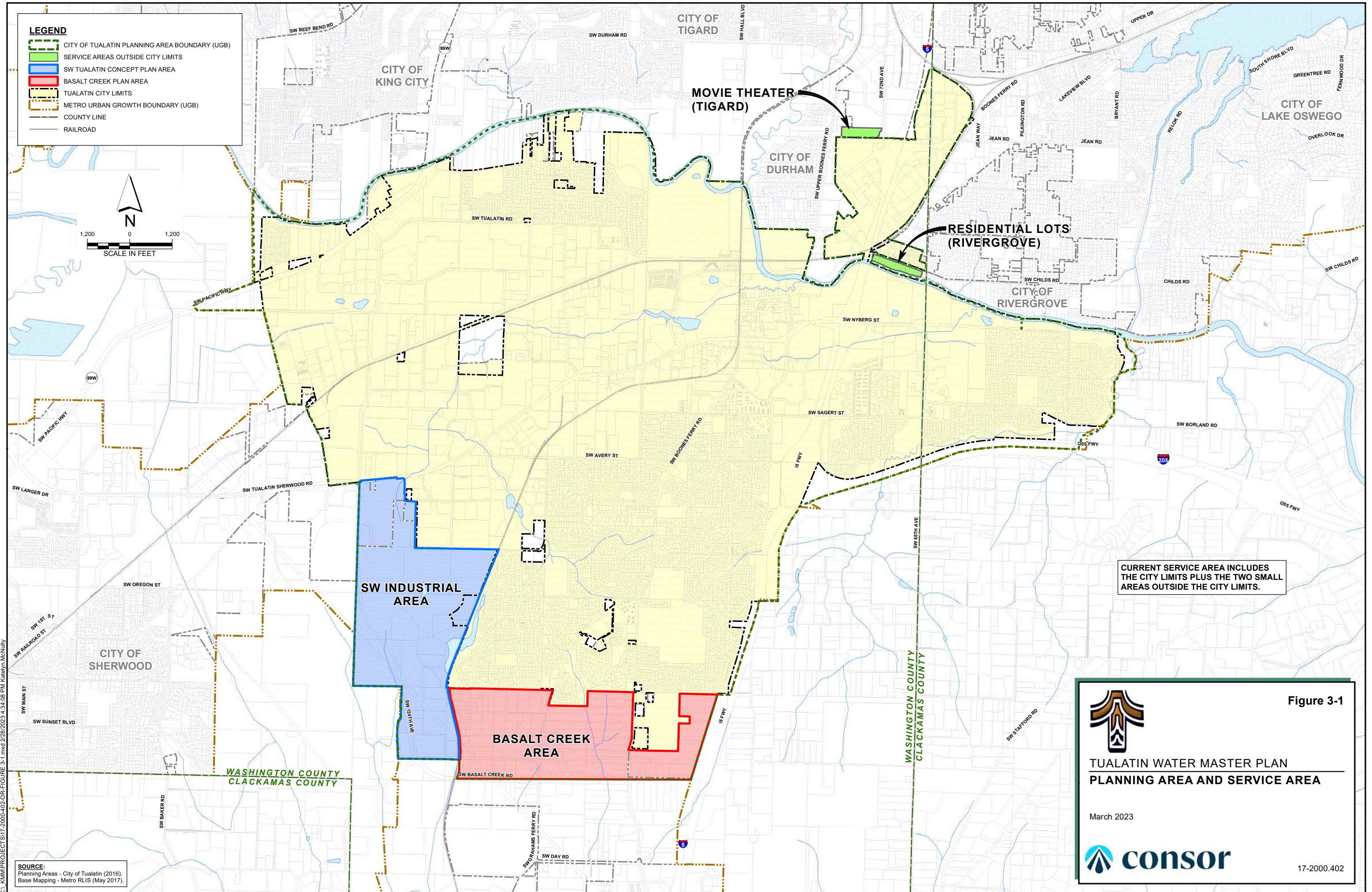

LEGEND

- CITY OF TUALATIN PLANNING AREA BOUNDARY (UGB)
- SERVICE AREAS OUTSIDE CITY LIMITS
- SW TUALATIN CONCEPT PLAN AREA
- BASALT CREEK PLAN AREA
- TUALATIN CITY LIMITS
- METRO URBAN GROWTH BOUNDARY (UGB)
- COUNTY LINE
- RAILROAD

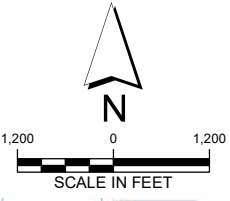

CURRENT SERVICE AREA INCLUDES THE CITY LIMITS PLUS THE TWO SMALL AREAS OUTSIDE THE CITY LIMITS.



Figure 3-1

**TUALATIN WATER MASTER PLAN
PLANNING AREA AND SERVICE AREA**

March 2023



C:\KIM\PROJECTS\17-2000-402-OR-FIGURE 3-1.mxd 2/28/2023 4:34:08 PM Katelyn McNulty

SOURCE:
Planning Areas - City of Tualatin (2016).
Base Mapping - Metro RLIS (May 2017).

Figure 3-2 | Historical and Projected Population

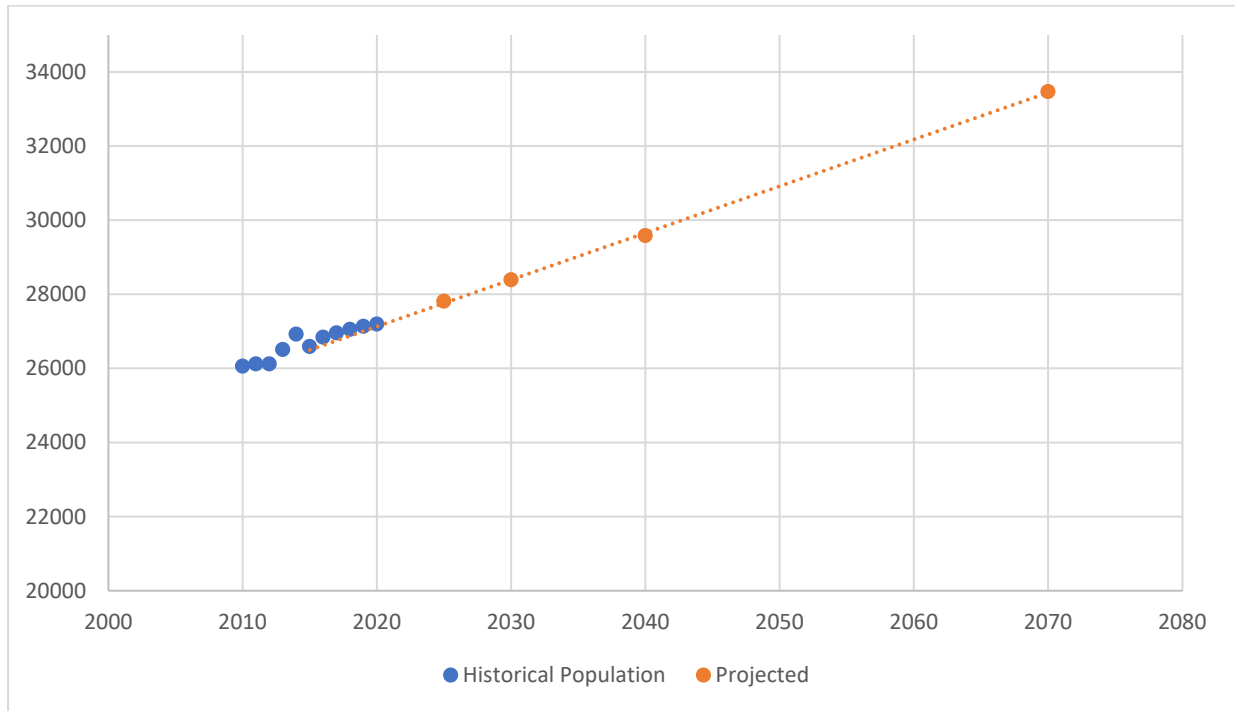

Table 3-1 | Historical and Projected Population

Year	Population	Average Annual Growth Rate (AAGR)
2012	26,120	1.49%
2013	26,510	1.57%
2014	26,925	-1.24%
2015	26,590	0.94%
2016	26,840	0.45%
2017	26,960	0.35%
2018	27,055	0.30%
2019	27,135	0.30%
2020	27,195	0.40%
2025	27,813	0.40%
2030	28,391	0.40%
2040	29,583	0.40%
2070	33,469	0.40%

Note:

1. The negative growth rate for 2014 to 2015 population estimates is assumed to be an anomaly and reflect the level of accuracy available from annual population estimates.
2. AAGR after 2019 is used to project populations.

3.4 Historical Water Usage

Terminology used in this section to describe uses of drinking water supplied by the municipal water system is defined below.

A **water balance** accounts for all water supplies and demands in the system.

Water consumption is the amount of metered water usage billed to customers by the City. Water consumption is also commonly referred to as customer usage.

Water demand refers to all water requirements in the system including water consumption, ASR recharge and unaccounted-for water.

Water production is the amount of water produced and delivered to the distribution system. The City of Tualatin purchases wholesale water from PWB. The City also recovers water from an ASR well it recharges annually. For the purposes of this study, water production is purchased plus recovered water.

Unaccounted-for water includes system leakage, or water loss, and unmetered uses. Unaccounted-for water is the unmeasured portion of the water balance and can be calculated as the difference between water production and water demand.

Peaking factor is the ratio of high to low water demand and is useful for characterizing the total water system demands. Peaking factors can be developed for any number of demand conditions such as maximum day demand (MDD) or peak hour demand (PHD) to average day demand (ADD).

Water usage is discussed in terms of volume per unit of time such as gpm, gallons per day (gpd), or mgd. Demands are also related to per capita use such as gallons per capita per day (gpcd) or per acre use such as gallons per acre per day (gpad).

3.4.1 Historical Water Production and Demand

The City's water balance has changed significantly since the last plan. In 2011, the City of Sherwood began transitioning supply to water from the WRWTP in Wilsonville and discontinued purchasing PWB water wheeled through the Tualatin system. The 24-inch Sherwood supply main remains connected as an emergency supply to the City of Sherwood but has not been utilized in several years and would require inspection, disinfection, and flushing prior to resuming use. Also in 2011, the City began piloting the ASR program. The City began injecting water in 2011 and began recovering water to meet peak season demands in 2012.

3.4.1.1 Unaccounted for Water

Unaccounted for or non-revenue water in the Tualatin system is approximately six percent, which is fairly typical for a system of this size. Unaccounted for use reflects unmetered authorized use such as system flushing, unmetered unauthorized use, and minor leaks. Unaccounted-for water volumes that are less than 10 percent of total water production are within an acceptable operating range consistent with OWRD municipal water conservation guidelines (OAR 690-086-0150(4)).

Table 3-2 provides a summary of the historical water production, water demand, and unaccounted-for water.

Table 3-2 | Historical Water Production and Demand

Year	Purchase/Production (MG)			Demand (MG)				Unaccounted for Water	
	PWB Supply ¹	ASR Recovery ²	Total	City of Tualatin	City of Sherwood	ASR Recharge ²	Total	Volume (MG)	Percent
2012	1610	62	1672	1336	133	110	1579	93	5.5%
2013	1523	55	1579	1365	66	83	1514	65	4.1%
2014	1648	53	1701	1456	85	108	1649	53	3.1%
2015	1650	50	1700	1522	28	95	1645	56	3.3%
2016 ³	1547	43	1590	1486	0	24	1511	80	5.0%
2017	1593	44	1638	1465	1	73	1539	99	6.0%
2018	1666	37	1703	1546	0	37	1584	119	7.0%
2019	1624	30	1654	1499	0	67	1566	88	5.4%
2020	1624	22	1655	1485	0	61	1546	100	6.1%

Notes:

1. PWB Supply provided by the City from Metzger Meter Readings.
2. ASR supply assumed recovery between July 1 and September 30, and recharge between October 1 and June 30.
 - a. ASR volumes documented here are per calendar year. Other documents present ASR volumes in terms of water year.
3. ASR recovery and recharge in 2016 were interrupted due to mechanical issues.

3.4.2 Historical Water Demand Characterization

3.4.2.1 Demand Peaking Factors

Water demands fluctuate greatly over the course of a day, month, or year. These variations reflect changes in water use based on daily water use patterns, specific industry use, or irrigation seasons.

The industry standard to characterize system-wide water use is ADD. However, ADD does not capture these daily or seasonal variations. Therefore, peaking factors based on the ratio of ADD to demand in a specific period of time are used to understand these variations and predict future maximums.

For this plan, two different sets of peaking factors will be used, the PWB wholesale contract peaking factors and City water use peaking factors. The PWB peaking factors are used to calculate wholesale water rates and include Peak Season Demand (PSD) and Peak Three Day Demand (P3DD). They are based on a ratio of the City’s Guaranteed Minimum Purchase to the water purchased during the 90 days from July 1 to September 30 and the peak three consecutive days of water purchase during that season, respectively.

For planning purposes, peaking factors based on water demand are used for infrastructure sizing and include MDD and PHD, calculated as the ratio of these demand periods to ADD (MDD) or MDD (PHD).

Table 3-3 presents a summary of recent system demands and maximum peaking factors.

Table 3-3 | System Demands

Year	Demand Condition (mgd)				
	Average Day	Peak Season	Peak 3-Day	Maximum Day	Peak Hour
2014	4.36	6.78	7.71	7.83	n/a
2015	4.40	6.56	8.30	8.45	n/a
2016	4.28	6.19	7.68	8.37	n/a
2017	4.29	6.69	8.46	9.54	n/a
2018	4.56	6.61	8.14	8.41	n/a
2019	4.33	5.92	7.53	7.64	n/a
Peaking Factors:		1.47	1.82	1.92	2.0¹

Notes:

PHD is not available based on data provided by the City and instead the 2.0 peaking factor shown above is typical of similar water systems in Oregon (data review for the cities of Tigard, Newberg and Beaverton – PHD peaking factor ranged from 1.7 to 2.0).

System demands include unaccounted for water at a rate of roughly 6%.

3.4.2.2 Consumption by Customer Class

In the Tualatin water system, customers are assigned to one of five general customer classes based on the type of water use or facility being served. Customer classes include residential, multifamily, commercial or industrial, institutional, or City.

Consumption is split primarily between residential use and commercial or industrial use. Residential water use is generally consistent on a per capita or per household basis. Commercial and industrial use, however, varies depending on the type of industry. Distribution warehouses have relatively low water consumption while fruit and vegetable processing facilities are extremely water intensive. Therefore, it is useful to classify consumption by customer class and also to consider the type of industry when considering future loading. **Figure 3-3** illustrates consumption by customer class for 2020.

Figure 3-3 | Consumption by Customer Class

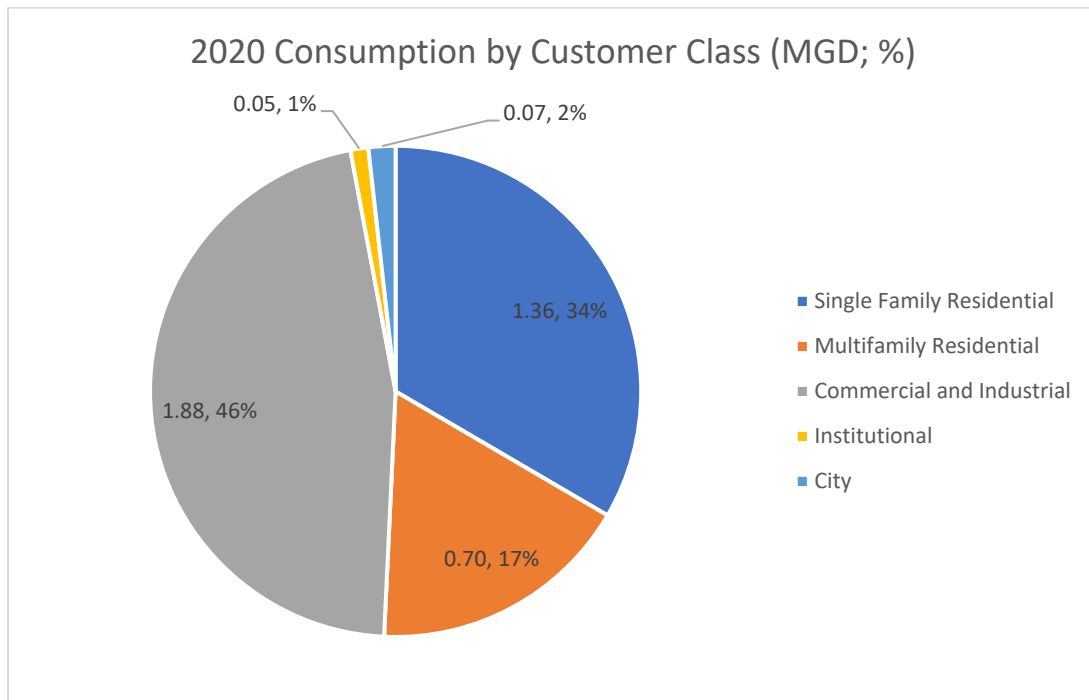

3.5 Water Demand Projections

3.5.1 Approach

In order to reasonably estimate future water demands, water use characteristics under existing conditions must be related to some measure of future growth within the water service area. Historical population growth often provides a reasonable approximation of system-wide water demand growth. However, this approach is less reliable in systems with high percentages of non-residential water demand and large areas of planned non-residential development, as there is in Tualatin. Additionally, a population growth-based approach generally requires Capital Improvement Program (CIP) projects to be tied to a population threshold or a fixed timeline, as opposed to growth metrics that correlate to actual demand growth. Therefore, a more detailed projection based on customer type and estimated development timing will be used to predict future demands.

For this analysis, demands are standardized based on the annual average consumption of a single-family residential unit, defined as an equivalent residential unit (ERU) and used with tax lot information on customer class, developable acreage, and development timing to calculate system demands from existing through buildout conditions. The following sections describe this process including,

- Development of an ERU demand
- Conversion of customer class demands to number of ERUs

- Calculation of ERUs/acre for each customer class
- Application of ERUs/acre factors and calculation of forecasted system demand through buildout condition

3.5.2 Existing Equivalent Residential Units

For this planning effort, the water needs of non-residential and multi-family residential customers are represented in terms of single-family residential units. The number of average single-family residential units that could be served by the water demand of these other types of customers is referred to as the number of ERUs.

Different from actual metered service connections, ERUs relate all water services to an equivalent number of representative single-family residential services. For example, a commercial customer that uses on average, half the amount of water an average single family residential customer uses (one ERU) would be represented as half of an ERU.

3.5.2.1 Average Consumption per ERU

The average consumption per ERU is calculated as the total annual consumption by single-family residential customers divided by the total number of single-family residential service connections. Both total consumption and total number of service connections are tracked by the City. For the years 2012 through 2016, the average daily consumption per ERU for the City was approximately 231 gpd and based on a review of more recent data, this still represents an accurate estimate of usage per ERU for forecasting.

3.5.2.2 Existing ERUs by Customer Class

For this WSMP, customers within each customer class are assumed to share similar water use characteristics. Therefore, the total number of existing ERUs per customer class is calculated by dividing the aggregate annual consumption of each customer class by the average consumption per ERU. This total number of ERUs is then distributed across developed tax lots to calculate existing ERUs per acre for each customer class. **Table 3-4** presents the results of these calculations.

Table 3-4 | Existing ERUs and Developed Area Summary by Customer Class

Customer Class	2016 Water Consumption (MGD) ¹	2016 ERUs ²	Developed Area (acres)	ERUs per Acre
Single Family	1.32	5,701	1,318	4.3
Multifamily	0.70	3,014	325	9.3
Commercial and Industrial	1.90	8,218	1,807	4.5
Institutional	0.05	219	190	1.2
Public	0.11	465	141	3.3
System Wide Total	4.07	17,617	3,781	

Notes:

1. 2016 Water Consumption is based on consumption data and does not include the approximately 5% of unaccounted for demands.
2. ERU differences between Table 3-4 and 3-5 due to rounding.

3.5.2.2.1 Determining Existing Developed Acreage and Customer Class

Determining existing developed acreage and customer class required understanding demands on a per tax lot basis. Geolocated water billing records and data available through Metro’s Regional Land Information System (RLIS) were used to classify tax lots. In an ideal system, each address of a water billing record would match an address of a developed tax lot. However, differences in address syntax between RLIS tax lot information and City water billing records, as well as multiple tax lot records that exist for a single water service prevent this one-to-one match. To account for these deficiencies, determining the customer class and development potential of tax lots is a multistep process.

First, tax lot addresses that matched geolocated billing data or were easily spatially linked to billing data were considered developed and assigned a customer class from the billing data. Approximately 80 percent of tax lots were classified through this method.

The remaining tax lots were classified based on Metro data and aerial photography review. Customer class was assigned based on LANDUSE categories available from Metro. Development was primarily based on BLDGVAL greater than 0 and spot checked with aerial photography for accuracy.

3.5.2.3 Existing ERUs by Service Level

The existing number of ERUs in each service level were estimated using the ERUs per acre calculated in **Table 3-4** and the tax lot data developed in the prior section. Existing 2016 demand and ERUs for each service level are summarized in **Table 3-5**. The 2016 data represents the current distribution of demand and customers by zone. A review of 2017 through 2020 data confirmed that customer water use distribution and characteristics have remained consistent.

Table 3-5 | Estimated Existing Water Consumption and ERUs by Service Level

Service Level	2016 ERUs	2016 Water Consumption (MGD) ¹	Existing Consumption %
A	9,680	2.24	55%
B	6,336	1.46	36%
C	1,456	0.34	8%
BV	134	0.03	1%
Total	17,606	4.07	

Notes:

- Existing consumption calculated without the 5% unaccounted for water.

3.5.3 Future ERUs and Water Demands

As described earlier in this section, future ERUs and associated water demands are assigned to each service level based on the land use type and the total developable land available in each service level. Development is expected both as new development within and outside of the existing service area, and redevelopment of large parcels within the existing service area. The projected timing of development and redevelopment was developed with input from the City’s Planning Division. A summarized report of expected ERUs and demands by pressure zone is included in **Table 3-6** at the end of this section.

3.5.3.1 Development and Redevelopment Areas

All areas located within the 100-year floodplain based on Federal Emergency Management Agency (FEMA) flood mapping, and with a slope greater than 25 percent based on RLIS hazard mapping, are considered undevelopable. Existing developed tax lots within these zones are considered developed but no new development or redevelopment will occur in the future. This is consistent with similar planning efforts in the region.

3.5.3.1.1 SW Industrial Area

The SW Industrial Area is expected to eventually develop as entirely commercial or industrial businesses at existing “Commercial and Industrial” densities. However, the existing Tigard Sand and Gravel quarry in the middle of the planning area will likely continue to operate and not develop for the planning period of this WSMP. For the purposes of this WSMP, it is anticipated that no additional development will occur in the 20-year planning horizon. Buildout conditions would include full development of commercial and industrial acreage in the area. Most of the SW Industrial Area will be served by the B Level, although portions of the quarry will require C Level pressures.

3.5.3.1.2 Basalt Creek Area

The City of Tualatin portion of the Basalt Creek Area is expected to develop as a mixture of residential and commercial or industrial. Customer class is assigned based on City planning documents. Residential development is expected to occur at a density of 8 ERUs/net acre, to

account for both single family and multifamily residential development. Residential areas will likely develop within the next five years while non-residential will likely begin development five years after residential development and will not reach saturation development within this planning period. For the purposes of this WSMP, at buildout, the Basalt Creek Area is forecasted to have approximately 1,600 ERUs.

3.5.3.1.3 Development within Existing Service Area

There are limited undeveloped areas within the existing service area. Residential areas will likely develop within the next five years at densities closer to 6 ERUs/acre. Employment and industrial areas will continue developing at existing densities within the next 10-20 years.

3.5.3.1.4 Redevelopment within Existing Service Area

Redevelopment of single-family residential tax lots greater than 0.5 acres is expected to occur where environmental hazards do not exist. Development is expected at densities of 6 ERUs/acre after development occurs elsewhere in the system.

3.5.3.2 Future Demands

Future demands are calculated for the whole system and by service level at 5-, 10-, and 20-years, and for buildout conditions, presented in **Table 3-6**. The forecasted time steps support identification of existing and future system deficiencies, prioritization of CIP projects to support development and growth, and sizing of future infrastructure to serve the long-term needs of the City.

The forecasted number of ERUs and future water demands are calculated based on the 2020 estimate of system demand and a 0.4 percent growth rate, resulting in a buildout of the City's water service area in approximately 30 years. The distribution of future demands by pressure zone was developed using the assumptions for development timing and future ERU densities as described in **Section 3.5.3.1**.

Table 3-6 | Future ERUs and Water Demand Summary by Service Level

Service Level	2016	2020	2025	2030	2040	Buildout
ERUs						
A	9,680	9,841	10,541	10,991	11,491	11,591
B	6,336	6,441	6,741	7,241	7,341	8,491
C	1,456	1,480	1,930	2,530	2,830	3,080
BV	134	136	136	136	136	136
Total	17,606	17,898	19,348	20,898	21,798	23,298
Average Day Demand¹						
A	2.35	2.39	2.55	2.66	2.78	2.81
B	1.54	1.56	1.63	1.75	1.78	2.06
C	0.35	0.36	0.47	0.61	0.69	0.75
BV	0.03	0.03	0.03	0.03	0.03	0.03
Total	4.27	4.34	4.69	5.06	5.28	5.65
Maximum Day Demand^{1,2}						
A	4.50	4.58	4.90	5.11	5.34	5.39
B	2.95	2.99	3.13	3.37	3.41	3.95
C	0.68	0.69	0.90	1.18	1.32	1.43
BV	0.06	0.06	0.06	0.06	0.06	0.06
Total	8.19	8.32	9.00	9.72	10.14	10.83

Notes:

1. Demands include a 5% markup for unaccounted for water
2. MDD:ADD peaking factor = 1.92

Chapter 4



Section 4

Planning and Analysis Criteria

4.1 Introduction

This section documents the performance criteria used for water system analysis presented in **Section 5** of this WSMP. Criteria are established for evaluating water supply, distribution system piping, service pressures, storage and pumping capacity, and fire flow availability. These criteria are used in conjunction with the water demand forecasts presented in **Section 3** to complete the water system analysis.

4.2 Performance Criteria

The water distribution system should be capable of operating within certain performance limits under existing, 20-year, and buildout conditions.

The recommendations of this plan are based on the performance criteria summarized in **Table 4-3** at the end of this section. These criteria have been developed through a review of City design standards, State requirements, American Water Works Association (AWWA) acceptable practice guidelines, *Ten States Standards*, the *Washington Water System Design Manual*, the *Oregon Resilience Plan*, and practices of other water providers in the region.

4.2.1 Water Supply

As described in **Section 2**, the City's sole supply is wholesale water purchased from PWB and delivered through the 66-inch diameter WCSL, the 48-inch diameter MTSM to the PWB master meter at Florence Lane, and the 36-inch diameter TSM. The primary water supply for PWB is the Bull Run Watershed and secondary supply is the Columbia South Shore Wellfield.

4.2.1.1 Supply Capacity

During peak summer water demand, the City withdraws water at a limited rate from the Columbia River Basalt Group (CRBG) aquifer with an ASR well. Total volume of available water in the aquifer is limited to 95 percent of water injected that year and an annually decreasing volume of water not recovered in previous years. Emergency interties with the Cities of Tigard, Sherwood, Lake Oswego, and Wilsonville, the Willamette Water Supply System, and the Rivergrove Water District can also likely provide minimal additional supply although these interties have rarely been utilized and the actual capacity is available is undocumented.

Due to seasonal changes in the City's supply sources, such as ASR supply availability during the summer months and the need to inject water for ASR in the winter, it is important to look at the impact of both the peak and off-peak season water demands on the City's supply capacity.

Based on current water system operations, the City should plan for adequate peak season (summer) supply capacity to provide MDD from PWB. The supply system must also be capable of providing ADD plus water for ASR injection during the off-peak season. For the purposes of this WSMP, the off-peak season is defined as the period when the City is injecting supply to the ASR wells, from approximately November to mid-May each year.

4.2.1.2 Supply Transmission

For the City's system, transmission piping is piping that falls into one of two categories.

- Mains that operate a hydraulic grade independent of the surrounding pressure zone: the key features of these transmission mains are that they do not have service connections and are not directly connected to the surrounding distribution mains. These mains, include the TSM, the 24-inch diameter main in Boones Ferry Road between the TSM and the Boones Ferry FCV/PRV, and the mains extending from the TSM to the 10th/Operations and Levelton FCV/PRVs.
- Distribution mains larger than 12-inch diameter which operate at the same hydraulic grade as the adjacent distribution mains: the key features of these transmission mains are that they may have direct service connections and are directly connected to those adjacent distribution mains.

Transmission mains will be evaluated based on: 1) the required carrying capacity to serve their purpose (i.e., for the TSM, the capacity to supply MDD from PWB wholesale supply) and 2) maintaining a maximum velocity of 8 feet per second (fps) under peak flow conditions. While this velocity criteria will typically not be used as a sole basis for recommending improvements, it provides a basis for identifying potential capacity deficiencies and for sizing future mains.

4.2.2 Distribution System

The distribution system will be evaluated under two demand scenarios: 1) MDD + fire flow and 2) PHD. These two scenarios typically account for the largest instantaneous demands on the system. Evaluating the system under these conditions helps identify deficiencies in the distribution network and suggest improvements to be included in the Capital Improvements Projects list.

4.2.2.1 Main Size

Typically, new water distribution mains should be at least 8 inches in diameter to supply minimum fire flows. Potential water quality issues will be considered on a case by case basis when sizing pipes for any proposed water main improvements identified during distribution system analysis.

4.2.3 Service Pressure

Water distribution systems are separated by ground elevation into pressure zones to provide service pressures within an acceptable range to all customers. Typically, water from a reservoir will serve customers by gravity within a specified range of ground elevations so as to maintain acceptable minimum and maximum water pressures at each individual service connection. When it is not feasible or practical to have a separate reservoir for each pressure zone, pump stations or PRVs are used to serve customers in different pressure zones from a single reservoir.

The three primary Tualatin pressure zones are served by reservoirs in each zone while the Bridgeport service area is only supplied by PRV connection to the TSM. PRVs also exist between service areas within the system for emergency supply.

The acceptable service pressure range under normal (ADD) operating conditions is 50 to 80 psi. Where mainline pressures exceed 80 psi, services must be equipped with individual PRVs to maintain their static pressures at no more than 80 psi in compliance with the *Oregon Plumbing Specialty Code*. A maximum mainline pressure of 110 psi is recommended, except in special circumstances (such as a high-pressure transmission main without services or looping connections to distribution).

The minimum residual service pressure at any meter under fire flow conditions during MDD is 20 psi as required by Oregon Health Authority (OHA) regulations and OAR 333-061. As an added factor of safety, the City has a goal of reaching 25 psi under these same conditions. This condition should be met even under the most extreme storage conditions where all operational, equalization, and fire suppression storage is depleted. Recommended service pressure criteria are summarized in **Table 4-1**.

Table 4-1 | Recommended Service Pressure Criteria

Service Pressure Criterion	Pressure (psi)
Minimum, during emergency or fire flow (<i>5 psi higher than regulatory minimum of 20 psi</i>)	25
Normal minimum, during ADD (<i>used to establish pressure zone boundaries</i>)	50
Normal Maximum (to guide pressure zone boundaries for customer compliance with the Oregon Plumbing Specialty Code)	80
Maximum Mainline Pressure	110

4.2.4 Required Fire Flow

The water distribution system nominally provides water for domestic uses and is also expected to provide water for fire suppression. The amount of water required for fire suppression purposes is associated with the local building size and type or land use of a specific location within the distribution system. Fire flow requirements are typically much greater in magnitude than the MDD in any local area. Adequate hydraulic capacity must be provided for these potentially large fire flow demands. Emergency response in the City is provided by TVFR. TVFR establishes fire flow

requirements for each building within the City. General TVFR fire flow guidelines are described in the *Fire Code Applications Guide* consistent with the 2019 *Oregon Fire Code* (OFC). Fire flow requirements by land use type based on these guidelines are summarized in **Table 4-2** and reflect a balance between providing fire suppression flows from the water system and requiring onsite fire suppression (per the OFC) to reduce the demand on the water system.

4.2.4.1 Single-Family Residential

The OFC and TVFR guidelines specify a minimum fire flow of 1,000 gpm for single-family and two-family dwellings with a square footage less than 3,600 square feet. For residential structures larger than 3,600 square feet, the minimum fire flow requirement is 1,750 gpm.

For the purposes of this WSMP, distribution piping fire flow capacity will be tested in the water system hydraulic model with a requirement of 1,000 gpm. For structures requiring a larger fire flow rate, the City has determined that the developer/owner may require sprinklers to reduce fire flow requirements to 1,000 gpm.

4.2.4.2 Multi-Family Residential

A required fire flow of 2,000 gpm is recommended for medium density residential properties. Properties zoned for neighborhood services and community services commercial are anticipated to require similar flows for fire suppression. While onsite fire sprinkler use can reduce the fire flow requirement for specific structures, it is recommended that the City plan for system storage, pumping and distribution capacity to meet a 2,000 gpm fire flow in all pressure zones with potential multi-family development.

4.2.4.3 Commercial, Industrial, and Institutional

A 3,000 gpm fire flow is recommended for commercial, industrial, and institutional development consistent with TVFR maximum fire flow guidelines. This maximum fire flow requirement is also appropriate for institutional and public facilities, such as schools or community centers. As with other development types, the actual required fire flow for a given structure will vary depending on construction type, occupancy, and the presence of onsite fire sprinklers. It is recommended that the City plan for system storage, pumping and distribution capacity to meet a 3,000 gpm fire flow in all pressure zones with potential large commercial or industrial development.

Recommended fire flow requirements by land use type are summarized in **Table 4-2**.

Table 4-2 | Required Fire Flow Summary

Land Use Type	Applicable Zoning	Required Fire Flow (gpm)	Required Duration (hours)
Single-Family Residential	RL, RML	1,000	1
Multi-Family Residential	RMH, RH, RH-HR	2,000	2
Commercial, Industrial, and Institutional		3,000	3

4.2.5 Storage Capacity

City water storage reservoirs should provide capacity for four purposes: operational storage, fire storage, equalization storage, and standby or emergency storage. Additionally, dead storage and headroom for seismic sloshing should also be included in storage volume calculations, where tanks have not been constructed to include seismic slosh height. While storage is typically discussed as a volume, limiting factors may actually be based on vertical space in a tank, flow rates, or actual volume of water. Adequate storage capacity for each purpose must be provided for each pressure zone, although the volume may be divided among multiple tanks. **Figure 4-1** provides a visual of the six storage volume components. A brief discussion of each storage element is included below, based on the *Washington State Water System Design Manual* guidelines.

4.2.5.1 Operational Storage

Operational storage is the volume of water stored between the nominal on/off reservoir level set points for the supplying pump stations or supply valves. This volume is dedicated to supplying demand fluctuations throughout the day and minimizing constant pump cycling. Operational storage can be varied throughout the year to provide reservoir turnover. For example, winter tank levels are normally set lower than summer levels to allow for continued turnover with lower winter demands.

4.2.5.2 Fire Storage

Water stored for fire suppression is typically provided to meet the single most severe fire flow demand within each pressure zone. Fire services in the City water service area are provided by Tualatin Valley Fire & Rescue (TVFR). Although the final fire flow requirement for any one property is determined by the Fire Marshal, TVFR provides the *Fire Code Applications Guide* which addresses general requirements by building construction and development type.

The maximum required fire flow for any future development in the TVFR service area is 3,000 gpm for a recommended duration of three hours. The recommended fire storage volume is determined by multiplying the fire flow rate by the duration of that flow. Fire flow requirements by land use type and zoning are discussed later in this section and summarized in **Table 4-2**.

4.2.5.3 Equalization Storage

Equalization storage is required to meet water system demands when zone demands exceed supply delivery capacity. The Washington Standards calculate equalization storage as,

$$(\text{Peak Hour Demand} - Q_s) \times 150 \text{ minutes}$$

Where Q_s is the total supply available to the zone excluding emergency supply.

Figure 4-1 | Storage Volumes

SEISMIC	Space above the reservoir overflow to top of wall shell for seismic protection. Required height varies (site specific), but is typically 5 ft +/- in western Oregon for welded steel tanks
OPERATIONAL	Volume of water contained between the high/low set points for system supply. Used to provide a reasonable range of on/off setpoints for supply facilities (pump stations or wholesale supply control valves).
EQUALIZATION	Volume of water available to offset variations in demand throughout the day that exceed supply to the zone. This component of storage is expected to be supplied to the system during high demand times (mid-morning and early evening) and refilled during lower demand times (early morning and late night).
FIRE	Volume of water required for the largest fire flow requirement in the zone. The water provider may choose to have this volume overlap the emergency volume, assuming that the two events will not occur simultaneously.
EMERGENCY	Volume of water available in the event of a short-term emergency such as a disruption of wholesale supply from Portland or a temporary disruption of pump station operation. Under these conditions, customer demands would be met from this emergency storage volume for up to 1-2 days depending on the level of water use.
DEAD	Volume of water below the level that is adequate to supply 25 psi. Volume may still be available for use following a major emergency (such as a large seismic event) but is not included in the calculation of available storage for system operation.

4.2.5.4 Emergency Storage

Emergency storage is provided to supply water from storage during emergencies such as supply pipeline failures, equipment failures, power outages, or natural disasters. The amount of emergency storage provided can be highly variable depending upon an assessment of risk and the desired degree of system reliability. For the City of Tualatin system, an emergency storage volume of 2x ADD is recommended, consistent with recommendations in the *Washington State Water System Design Manual*.

4.2.5.5 Dead Storage and Seismic Volume

Some reservoirs may include two additional, non-usable volumes of air or water. Dead storage is the volume of water at the base of a reservoir that does not provide a minimum 25 psi or exists below the outlet. Seismic volume is only required in older reservoirs that do not meet current seismic standards. It includes the volume of space between the maximum water surface allowed and the base of the tank roof. This space is maintained as a buffer in the event of a seismic event to minimize forces on the tank caused by uplift and the resultant sloshing. For older reservoirs with inadequate freeboard, this volume of space may require the reservoir to be operated such that the maximum operational level is below the set overflow elevation of the tank.

4.2.6 Pump Stations

4.2.6.1 Station Capacity

Pumping capacity requirements vary depending on the water demand, volume of available storage, and the number of pumping facilities serving a particular pressure zone. When pumping to storage reservoirs, a firm pumping capacity equal to the pressure zone's MDD is recommended. Firm pumping capacity is defined as a station's pumping capacity with the largest pump out of service.

4.2.6.2 Backup Power

It is recommended that pump stations supplying gravity storage reservoirs include, at a minimum, manual transfer switches and connections for a portable back-up generator. Automatic transfer switches, however, are preferable and are the updated recommended standard. The emergency storage volume in each reservoir will provide short term water service reliability in case of a power outage at the pump station. Permanently installed onsite back-up generators should be in place for pump stations critical to the City's operations (i.e., Norwood Pump Station).

4.3 Seismic Resilience

Recently, regional emergency preparedness programs have focused on the eminent threat and extreme risk of a CSZ earthquake. Following this research, the State of Oregon has developed the ORP to establish target timelines for utilities to provide service following a seismic event.

As part of this WSMP, the City completed a seismic risk assessment of their existing water system. Seismic criteria and analysis are presented in **Section 7**.

4.4 Summary

The criteria presented in this section and summarized in **Table 4-3** were developed from various regional planning and design standard documents, state requirements, as well as criteria used in similar regional systems. The criteria will be used to evaluate the existing system in **Section 5** and additional criteria related to seismic resilience will be developed and presented in **Section 7**.

Table 4-3 | Water System Performance Criteria

Water System Facility	Evaluation Criterion	Value	Design Standard/Guideline
Water Supply	Transmission Capacity	MDD	Ten State Standards, Washington Water System Design Manual
	Supply Capacity	Summer: MDD Winter: ADD + ASR Recharge	
Service Pressure	Normal Range (ADD ¹ Conditions)	50-80 psi	Ten State Standards
	Maximum	110 psi system pressure and 80 psi at service with individual PRVs	Oregon Plumbing Specialty Code, Section 608.2
	Minimum, during MDD ¹ with Fire Flow	25 psi	2019 Oregon Fire Code, OAR 333-061, City recommendation
Distribution Piping	Velocity during PHD ¹	Not to exceed 8 fps	AWWA M32, Washington Water System Design Manual
	Minimum Pipe Diameter	8-inch diameter ductile iron, 4- or 6-inch acceptable for short mains without fire service	Tualatin Public Works Construction Code
Storage	Total Available Storage Capacity	Sum of operational, equalization, fire suppression, and emergency storage volumes (does not include seismic or dead storage volumes)	Washington Water System Design Manual
	Operational	Tank level set points	
	Equalization	(PHD-Qs)*(150 minutes)	
	Fire	Required fire flow x flow duration	
	Emergency (Standby)	2 x ADD	
Pump Stations	Minimum no. of Pumps	2	Ten State Standards
	Open Zone Capacity ² (firm capacity)	MDD ¹	Washington Water System Design Manual
	Backup Power	At least two independent sources	Ten State Standards
Required Fire Flow and Duration	Single Family Residential	1,000 gpm for 1 hour	2019 Oregon Fire Code, Tualatin Valley Fire & Rescue Fire Code Applications Guide
	Multifamily Residential	2,000 gpm for 2 hours	
	Commercial, Industrial, and Institutional	3,000 gpm for 3 hours	

Notes:

1. ADD: Average daily demand, defined as the average volume of water delivered to the system during a 24-hour period = total annual demand/365 days per year. MDD: Maximum day demand, defined as the maximum volume of water delivered to the system during any single day. PHD: Peak hour demand, generally the peak hour of MDD. Estimated as 2xMDD.
2. Open zone is defined as a pressure zone supplied by gravity from a storage reservoir.

Chapter 5



Section 5

Water System Analysis

5.1 Water Supply Analysis

5.1.1 Water Supply Strategy

The City conducted a separate overall water supply strategy in parallel with this WSMP. The *City of Tualatin – Water Supply Strategy* (The Formation Lab, 2021) documents the City’s overall water supply strategy and is included in **Appendix B**.

The Water Supply Strategy focused on ensuring the continued reliability of the City’s water supply and documenting community values, expected current system performance during emergencies, and opportunities for improved emergency performance. The project resulted in a recommended three-prong strategy:

- **Strategy 1 - Invest in a New Backup Supply** to address the City’s vulnerability to an outage of the TSM. The preferred option is to work with the City of Sherwood and the WWSS to interconnect the WWSS Water Treatment Plant and the Sherwood Emergency Supply Main.
- **Strategy 2 – Continue to Support Reliability of the PWB System** by working with the PWB. Considerations include ensuring the City’s demands are included in future analyses of backup supply options, resolving future maintenance of the WCSL, and reaching agreement on a new wholesale agreement.
- **Strategy 3 – Increase Reliability of Local Interties** by working with neighboring agencies to make sure agreements are in place and test interties on a regular basis. The City should also continue to take advantage of future intertie opportunities, such as within the Basalt Creek Area.

As part of this study, neighboring water agencies were also asked about their capacity to potentially provide long-term supply in the future. The intent was not to initiate a change in the City’s water supply, but instead to understand water supply availability in the region if PWB’s water were to become unavailable or unaffordable. Though short-term supplies could likely be provided by two of the neighboring water agencies, there is no agency with excess supply sufficient to meet the City’s long-term needs. *PWB remains the most reliable source of long-term supply for the City.*

5.1.2 Intertie Expansion

The City explored permanent alternatives to supply redundancy, including diversifying its water supply through the expansion of an emergency intertie into a routinely used supply to meet normal system demands. As documented in the *City of Tualatin – Water Supply Strategy* (The Formation Lab, 2021), included as **Appendix B** of this report, the City met with nearby water purveyors to determine if alternate long-term water supplies exist. Based on that study, the City confirmed that the most reliable long-term supply available to the City is wholesale supply from PWB.

5.2 Distribution System Analysis

5.2.1 Hydraulic Model

A steady-state hydraulic network analysis model (a model that represents the system as a series of lines and junctions, and calculates system flows and pressures at a specific point in time) was used to evaluate the performance of the City’s existing distribution system and identify proposed piping improvements based on hydraulic performance criteria described in **Section 4**. The purpose of the model was to determine pressure and flow relationships throughout the distribution system for average and peak water demands under existing and projected future conditions, which ultimately inform the need for future improvement projects. Modeled pipes are shown as “links” between “nodes” which represent pipeline junctions or pipe size changes. Diameter, length, and head loss coefficients are specified for each pipe and an approximate ground elevation is specified for each node.

The current hydraulic model was updated during the 2013 WSMP using the Innowyze InfoWater modeling software platform and the City’s GIS base mapping. The model was updated again in late 2016 to reflect new development and infrastructure renewal. Building on the facilities identified in the prior model and updated facility and operations data provided by the City, the model was then calibrated using fire hydrant flow test data and analysis scenarios were created to evaluate existing and projected 20-year demands. The existing water demands in the model have been updated from year 2016 to 2020 demand conditions for this analysis.

5.2.2 Modeled Water Demands

Existing and projected future demands are summarized in **Section 3**. Within the existing water service area, demands are assigned to the model based on current customer billing address and billed water consumption. Future demands in water service expansion areas were assigned uniformly over each proposed development area within pressure zones.

5.2.3 Model Calibration

Model calibration typically involves adjusting the model parameters such that pressure and flow results from the model more closely reflect those measured at the City’s fire hydrants. This

calibration process tests the accuracy of model pipeline friction factors, demand distribution, valve status, network configuration, and facility parameters such as tank elevations, PRV settings, and pump controls and curves. The required level of model accuracy can vary according to the intended use of the model, the type and size of water system, the available data, and the way the system is controlled and operated. Pressure and flow measurements are recorded for the City's fire hydrants through a process called fire flow testing. This data is used to calibrate the model for future analysis.

The complete 2017 Model Calibration Memo can be found in **Appendix D**.

5.2.3.1 Calibration Hydrant Flow Testing

Hydrant flow testing consists of recording static pressure at a fire hydrant and then “stressing” the system by flowing an adjacent hydrant. While the adjacent hydrant is flowing, residual pressure is measured at the first hydrant to determine the pressure drop that occurs when the system is “stressed”. Boundary condition data such as reservoir levels and pump on/off status must also be known to accurately model the system conditions during the time of the flow test. For this plan, 30 hydrant flow tests were conducted in September 2016 distributed across the A, B, and C Levels. The recorded time of each fire hydrant flow test was used to collect boundary condition information from the City's SCADA system.

No hydrant flow tests were completed in Bridgeport Village. This is a closed zone normally served by the TSM via a PRV. Emergency or fire flow supply is available via an intertie and PRV with the City of Tigard. No additional development in the area has occurred since the model was last calibrated, and the zone has minimal connections with the rest of the City's system. Therefore, Bridgeport Village was not calibrated in this model and assumed to be accurate for planning purposes.

5.2.3.2 Pressure Reducing Valve/Flow Control Valve Settings

Supply to the City distribution system from Portland is dependent on dual-purpose FCV/PRVs. A pressure reducing valve sets the downstream pressure by throttling flow through the valve. A flow control valve sets the flow through the valve by varying pressure drop across the valve. A dual-purpose valve can have minimum or maximum settings for both flow and pressure, with either flow or pressure setting being the primary setting.

The FCV/PRVs have summer and winter operating modes, with low and high flow settings for each season. For the model calibration, the valves in the model were set at the maximum flow seen from SCADA and PRV settings were used to limit flow. In both the A and B Levels, flow through the FCV is overestimated for lower demand periods but aligns well during higher demand periods.

For system evaluation, calibration settings are used as “typical operation”. For analysis of system performance under fire flow conditions and under peak hour conditions, the TSM FCV/PRV stations are assumed to be closed or operating at a low flow setting.

5.2.3.3 Steady-State Calibration Results

Overall, the City's water system model calibrated well with moderate to high calibration confidence. Each existing pressure zone's overall confidence level was determined by the number of low, medium and high-confidence results for percentage difference in static pressure, and pressure change difference during a fire flow. Results are summarized in **Table 5-1**.

Table 5-1 | Calibration Confidence Results

Pressure Zone	Static Pressure		Residual Fire Flow Pressure	
	Average % Difference/Confidence		Average Pressure Difference/Confidence	
A	<1%	Moderate-High	2.5 PSI	High
B	4.5%	Moderate-High	4.7 PSI	High
C	2%	Moderate-High	2.3 PSI	High

Note:

Complete results listed in 2017 Model Calibration Memo in Appendix D.

For most water systems, a portion of the data needed to fully characterize the distribution system (boundary conditions, customer demands, pressure and flow at specific locations, etc.) will be missing or inaccurate and assumptions will be required. This does not necessarily mean the use of the hydraulic model will be compromised. Depending on the accuracy and completeness of the available information, some pressure zones may achieve a higher degree of calibration than others. Models that do not meet the highest degree of calibration can still be useful for planning purposes.

5.2.4 Fire Flow Analysis

Fire flow scenarios test the distribution system's ability to provide required fire flows at a given location while simultaneously supplying MDD and maintaining a minimum residual service pressure at all services. As discussed in **Section 4**, a minimum pressure of 25 PSI, rather than the typical 20 PSI, was selected by the City. Required fire flows are assigned based on the zoning surrounding each node as summarized in **Table 4-2**.

The following boundary conditions were used for fire flow analysis in the model.

- Tanks set with fire flow storage depleted (only emergency + dead storage included) or minimum historical operating level, whichever is less. This translates to a depth of 30 feet in the A Level, 24 feet in the B Level, and 20 feet in the C Level.
- System demands were set at either 2020 or buildout demands. While 2040 demands are minimally lower than buildout demands (**Table 3-6**), the fire flow requirements for 2040 and buildout conditions are constant, dictated by landuse, fire code, and building types.
- All residential fire flow demands were calculated at 1,000 gpm. It is assumed that single family residential structures over 3,600 square feet would be sprinklered to reduce the fire flow requirement to this level.

- Available fire flow in the City System is highly dependent on the available supply to each zone (PWB supply valves in A and B Levels, C Level Pump Station in C Level). For fire flow analysis, PWB supply valves were set to high winter flows. For peak hour analysis, PWB supply valves were set to low summer flows. See **Table 2-4** for winter/summer low/high supply rates from PWB valves.

5.2.4.1 Fire Flow Results

Figure 5-1 and **Figure 5-2** show the identified fire flow deficits under 2020 and buildout high flow conditions. Fire flows are higher than peak hour flows in the system and govern any capacity deficiencies. Aside from the SW Industrial Area, which is not anticipated to develop more until after 2040, fire flow demands are the same for 2040 and buildout conditions. Buildout conditions were evaluated knowing they are representative of 2040 demands. SW Industrial Area deficiencies identified in the buildout scenario are not expected to occur until after 2040 (or when additional development in the SW Industrial Area is proposed and moves forward). There were two general results from the fire flow analysis:

- **Known Industrial deficiencies in the A and B Levels** – The City is aware of fire flow deficiencies in the A and B Levels. Some of these deficiencies are due to undersized and non-looped mains. To mitigate these risks, the City currently requires new customers who require large fire flows to install fire flow pumps. Increased looping in this area and upsizing of keys mains will also improve available flows.
- **C Level Deficiencies** – Most development in the C Level is residential homes less than 3,600 square feet, requiring 1,000 gpm fire flow. Larger homes or fire flows may require sprinkler use to reduce demand. As the system currently operates, a 1,000 gpm fire flow is generally available during MDD to the C Level. However, if larger homes are constructed and sprinklers are not required, the system cannot meet these upsized demands without pumping during a fire flow or increased transmission. Increased looping in this area and upsizing of keys mains will also improve available flows. C Level Transmission is discussed further in **Section 5.2.6**.

Projects to address fire flow deficiencies are included in the CIP under Residential Fire Flow and Nonresidential Fire Flow.

5.2.5 Peak Hour Demand Analysis

For distribution system modeling, the PWB supply valves are assumed to operate in the summer low setting with reservoirs providing most of the supply to each zone. Storage reservoirs are modeled at 75 percent full, slightly less than typical summertime lows for a more conservative estimate. These two assumptions present a worst-case scenario for testing the system under stressed conditions.

Distribution system pressures were evaluated under peak hour demand conditions to confirm identified piping improvements. Peak hour demands were estimated as two times the MDD. No

additional pressure deficiencies were identified under these conditions, as the fire flow condition creates a greater stress on the system. No additional CIP projects were identified for peak hour supply.

5.2.6 B and C Level Transmission Capacity

The Basalt Creek Area located at the south end of the C Level is beginning to develop with two developments currently moving into land use approval. Existing transmission limitations through the B Level and fire flow requirements that exceed existing maximum available supply in the C Level require transmission improvements in both the B and C Levels prior to development. The analysis and complete findings from this study can be found in the *Water System Capacity Analysis – Basalt Creek Service Technical Memorandum* (Murraysmith, 2021) which is included as **Appendix E**. Findings from this report are summarized below, and projects are incorporated into the CIP under “Transmission Improvements.”

- B Level transmission between the Boones Ferry FCV/PRV and B Level Reservoirs are inadequate to supply B Level and C Level peak demands while refilling the B Level reservoirs.
- C Level transmission capacity between the Norwood Pump Station and C Level Reservoirs is inadequate to serve continued development in the C Level and specifically for the development of the Basalt Creek Area. This deficiency results in inadequate fire flow capacity to serve proposed developments with fire flows greater than 1,000 gpm in 2020, and all fire flows by 2040.

Based on the summary of findings above, the City should consider the following phased improvements, which are included in the CIP.

B Level

- *Prior to Basalt Creek Development:* Further development of the B Level and C Level should be limited until the following improvement is completed.
 - Upsize existing transmission to 18-inch diameter main from Norwood Reservoirs to SW Ibach Street.
- *Long-term Recommendations:* With full development of the B and C Levels, further transmission improvements are recommended in the B Level.
 - Upsize existing transmission to 18-inch diameter main in SW Boones Ferry Road from SW Ibach Street to SW Sagert Street.

C Level

Due to concerns about the constructability of upsizing the existing transmission from the C Level Pump Station to the C Level Reservoirs, the City proposed a hydraulically similar route that goes

south through the Autumn Sunrise development to Greenhill Road, crosses I-5 at Greenhill Road, and joins the existing alignment on the east side of I-5. This route, while different than the one studied and proposed in the *Water System Capacity Analysis – Basalt Creek Service Technical Memorandum (Appendix E)*, will still improve transmission capacity between the C Level Reservoirs and the C Level. Additional study will be required to verify the feasibility of this route.

- *Prior to Basalt Creek Development:* Development in the Basalt Creek area should not be allowed without the completion of the following improvements.
 - C Level Pump Station operational changes and permanent standby power installation to address current fire flow deficiencies to support CPAH development.
 - Oversize Autumn Sunrise development piping from C Level Pump Station south to Greenhill Road to 18-inch diameter when constructed.
 - New I-5 Crossing at Greenhill Road and connection to existing transmission along SW 82nd Ave, approximately 2,200 LF of 18-inch diameter main.
- *Long-term Recommendations:* Full development of the Basalt Creek Area will require the buildout of a transmission main loop (described in Section 8.8.3) and the following improvements to address the transmission deficiency between the Norwood Pump Station and C Level Reservoirs.
 - Upsize the remaining transmission from the new I-5 crossing up to the C Level Reservoirs to 18-inch diameter main, 1,300 LF.

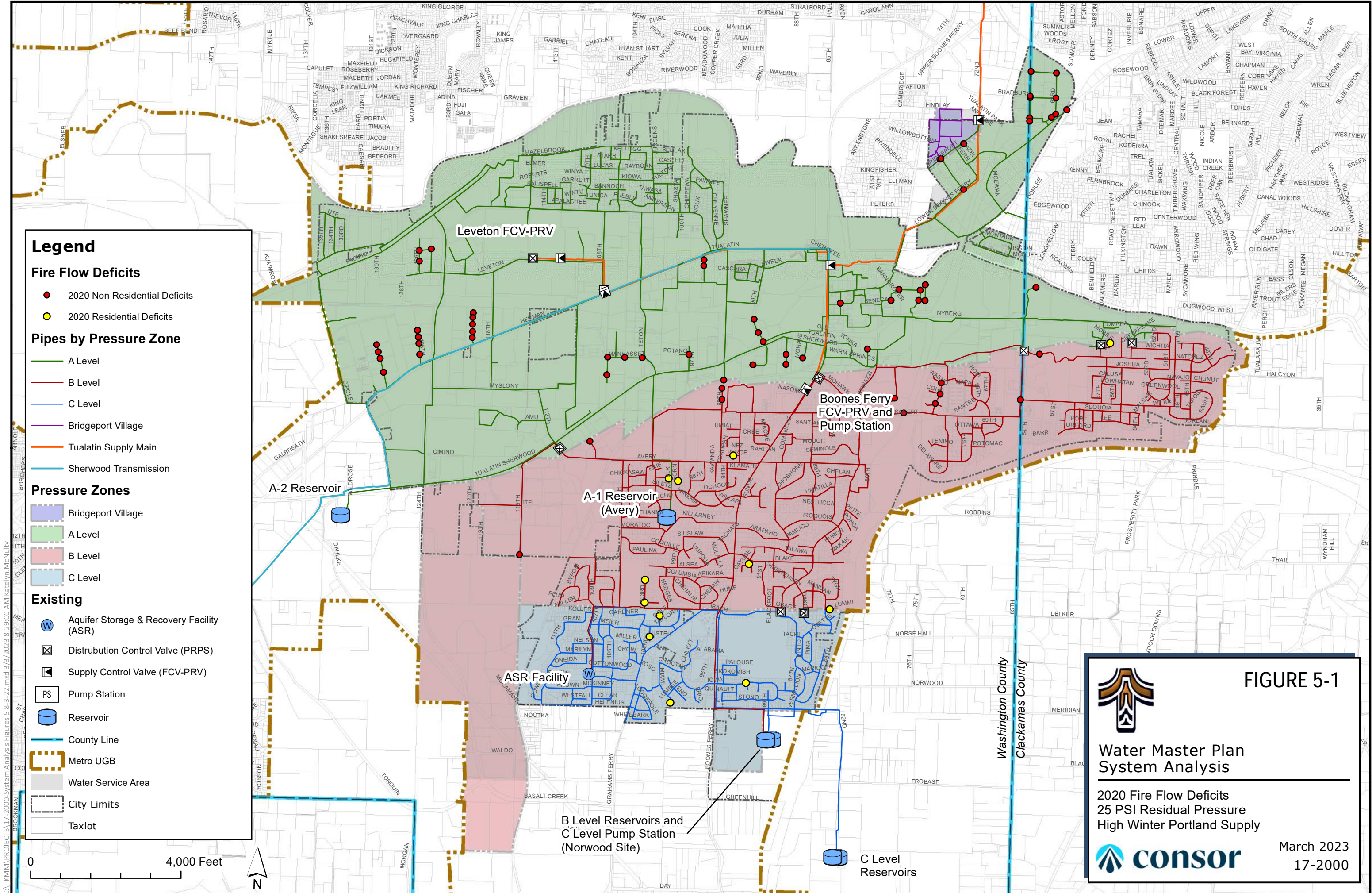

Legend

Fire Flow Deficits

- 2020 Non Residential Deficits
- 2020 Residential Deficits

Pipes by Pressure Zone

- A Level
- B Level
- C Level
- Bridgeport Village
- Tualatin Supply Main
- Sherwood Transmission

Pressure Zones

- ▭ Bridgeport Village
- ▭ A Level
- ▭ B Level
- ▭ C Level

Existing

- ⊕ Aquifer Storage & Recovery Facility (ASR)
- ⊠ Distrubution Control Valve (PRPS)
- ⊠ Supply Control Valve (FCV-PRV)
- ⊠ PS Pump Station
- ⊕ Reservoir
- County Line
- ▭ Metro UGB
- ▭ Water Service Area
- ▭ City Limits
- ▭ Taxlot



FIGURE 5-1

Water Master Plan System Analysis

2020 Fire Flow Deficits
25 PSI Residual Pressure
High Winter Portland Supply

consor

March 2023
17-2000

C:\A_KVMA\PROJECTS\17-2000-System Analysis Figures 5-8-3-22.mxd 3/3/2023 8:29:00 AM kate.lvn.McNulty

C:\KMM\PROJECTS\17-2000-System Analysis Figures 5-8-3-22.mxd 3/3/2023 8:29:00 AM kate.lvn.McNulty

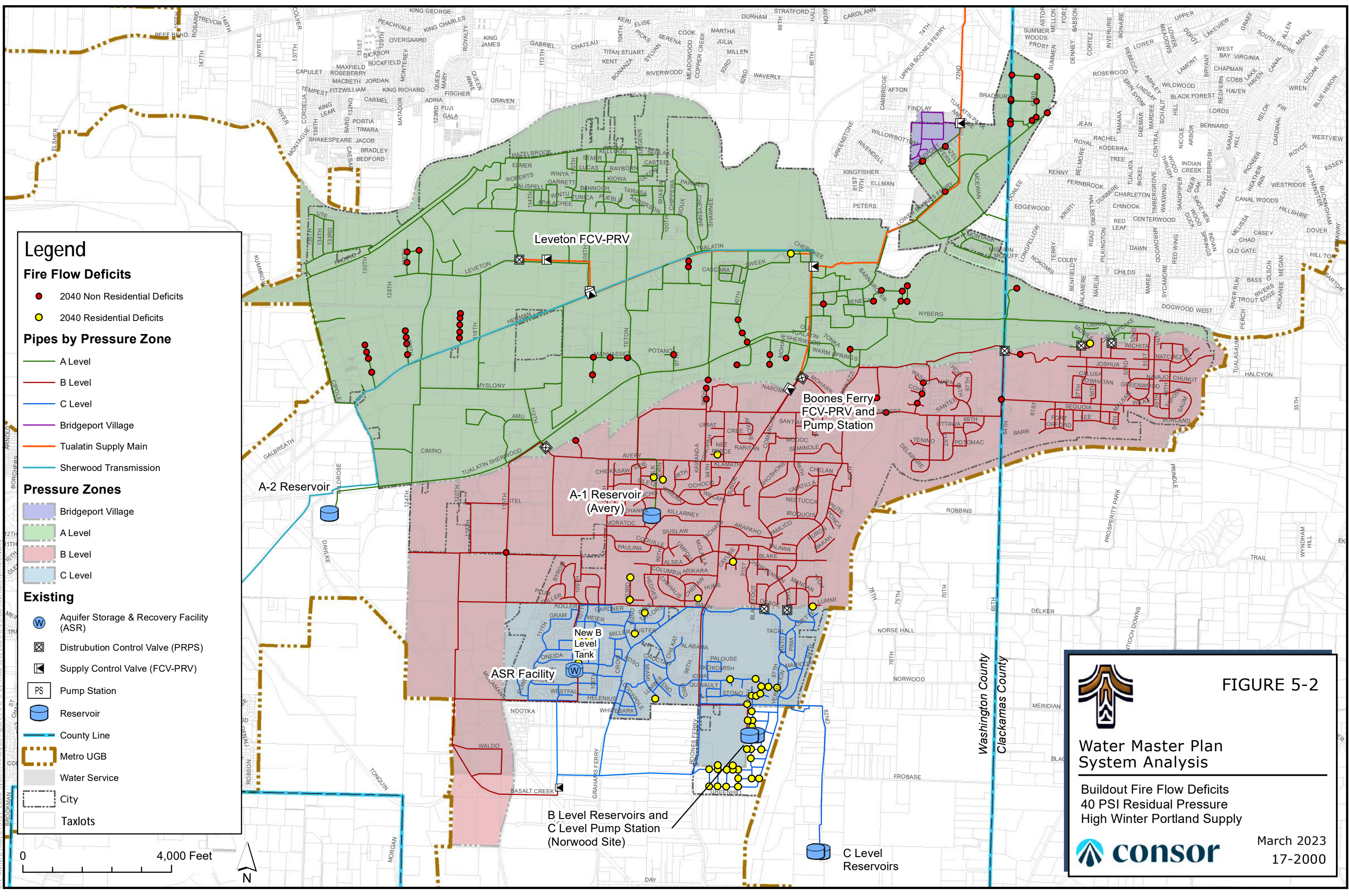

Legend

Fire Flow Deficits

- 2040 Non Residential Deficits
- 2040 Residential Deficits

Pipes by Pressure Zone

- A Level
- B Level
- C Level
- Bridgeport Village
- Tualatin Supply Main
- Sherwood Transmission

Pressure Zones

- ▭ Bridgeport Village
- ▭ A Level
- ▭ B Level
- ▭ C Level

Existing

- ⊕ Aquifer Storage & Recovery Facility (ASR)
- ⊠ Distrubution Control Valve (PRPS)
- ⊠ Supply Control Valve (FCV-PRV)
- ⊠ PS Pump Station
- ⊕ Reservoir
- County Line
- ▭ Metro UGB
- ▭ Water Service
- ▭ City
- ▭ Taxlots





FIGURE 5-2

**Water Master Plan
System Analysis**

Buildout Fire Flow Deficits
40 PSI Residual Pressure
High Winter Portland Supply

consor

March 2023
17-2000

5.3 Storage Analysis

5.3.1 Storage Capacity Analysis

Storage capacity needs were evaluated within individual Levels then considered system-wide.

The storage volume was evaluated using the criteria developed in **Section 4**, summarized below.

- Operational: Volume in between reservoir low/high set points, assumed a low level of 40 feet (summer) in all tanks and high of tank overflow. Volume calculated in existing reservoirs and maintained through buildout.
- Equalization Storage: The amount of storage required to offset peak hour demand from nominal supply capacity calculated as $(PHD - Q_s) * (150 \text{ minutes})$ where
 - PHD = Peak Hour Demand
 - Q_s = Sum of all permanent and seasonal sources. Assumed as summer high supply valve flows in A and B Levels, and one pump active in C Level.
- Fire Flow Storage: 2019 OFC
- Emergency Storage: 2 x ADD

Table 5-2 summarizes the individual storage components and combined storage needs recommended for operational, equalization, fire, and emergency purposes for service areas A, B, and C Level under 2020, 2040, and buildout conditions. The BV service area is small enough that it is not cost effective to have storage for this zone. Additionally, the topography does not provide a good location for gravity storage for the BV zone and there are two independent supply feeds (TSM and the Tigard PRV which operates automatically to provide flow if pressures drop) to the existing service area. It should be noted that equalization storage includes credits for continuously available pumping. ASR is not included in these calculations to provide a conservative evaluation of storage needs for the City. Existing available storage is compared to the calculated storage needs and estimated storage deficit for each service area for 2020, 2040, and buildout conditions are summarized in the right-hand columns of **Table 5-2**.

Table 5-2 | Storage Volume Recommendation Summary (MG)

Service Area	Operational	Fire Flow	Equalization ¹	Emergency ²	Total Required Storage	Existing Available Storage ³	Storage Deficit ⁴
2020							
A	1.07	0.54	0.52	4.77	6.90	6.01	-0.89
B	0.74	0.54	0.40	3.12	4.81	5.00	0.19
C	0.33	0.24	0.00	0.72	1.29	1.80	0.51
2040							
A	1.07	0.54	0.68	5.57	7.86	6.01	-1.85
B	0.74	0.54	0.49	3.56	5.33	5.00	-0.33
C	0.33	0.24	0.03	1.37	1.98	1.80	-0.18
Buildout							
A	1.07	0.54	0.69	5.62	7.92	6.01	-1.91
B	0.74	0.54	0.60	4.12	6.00	5.00	-1.00
C	0.33	0.24	0.06	1.49	2.12	1.80	-0.32

Notes:

1. PHD estimated as 2xMDD.
2. Emergency Storage presented in this column is 2xADD.
3. Available storage accounts for approximately 1.2 MG of dead storage in the A Level.
4. Additional storage in excess of the existing storage required to meet the calculated needs of the zone. Positive numbers indicate available excess capacity in the existing storage.

The B Level equalization storage accounts for impacts on supply capacity when the C Pump Station is pulling from the B Level. This is not required for A and B Levels as it is assumed PWB supply volumes are sufficient to meet the system’s needs. Nesting fire storage within emergency storage was discussed with the City. However, this is not recommended given the City’s limited supply alternatives, and the lack of extreme emergency that would require the City to rely on emergency storage (PWB supply outage).

As shown in **Table 5-2**, Storage in the A Level is currently deficient, while storage in the B and C Levels is projected to be deficient within 20 years.

5.3.1.1 Future Storage Alternatives

It is recommended that all new storage is combined in the B Level because reservoir site options are limited in the City area, the system is relatively well connected, and A and C Level existing storage can meet most of the future storage requirements in those zones. These considerations are expanded upon below.

- Sites with sufficient elevation for ground level tanks, without dead storage, are limited within City boundaries. New sites to serve the A Level would likely include long transmission lines, or significant dead storage if collocated at existing A Level Reservoir sites. New sites to serve the C Level would face similar issues with long transmission lines.

- Storage at the B Level may also be allowed because the system is well connected. The A Level can be served by the B Level by gravity via five PRPS valves along the A/B Level boundary. These would automatically supply the A Level in the event of a failure of the A Level PWB supplies. The C Level can be served from the B Level by the existing C Level pump station located at the Norwood site and the proposed C level pump station located at the ASR site. As discussed earlier in this report, the firm capacity of the existing station can meet C Level needs through buildout.
- Existing storage in the A and C Levels can meet most of the buildout storage requirements. C Level deficits are minimal by buildout and could be mostly addressed by either relying on C Level pumping for fire supply or, if the City decides to accept this risk, nesting fire flow storage within emergency storage. If emergency deficits were significantly greater, or either zone did not have sufficient storage to meet daily operational requirements, combined storage in the B Level would not be recommended.

The City should consider constructing a 2.5 MG reservoir at the ASR site, with similar operating elevations to the existing B Reservoirs, within the next 10 years to address deficits in all levels. By buildout and as development requires, the City should consider an additional reservoir, potentially at the B Level Reservoirs (Norwood) site, to address any remaining storage deficit. A 2.5 MG reservoir is included in the CIP within 10 years, and a 1.0 MG reservoir is included in the CIP in 20+ years. However, future development timing may require adjustment of these timelines.

5.3.2 Current Storage Operational Considerations

Historically, the City has had trouble maintaining reservoir levels in the B and C Levels during peak hour demand when both the B and C Level Reservoirs are filling. The transmission from Boones Ferry FCV/PRV to the B Level Reservoirs cannot keep up with this high demand and so the B Reservoirs drain to unacceptably low levels. The City has mitigated this issue by increasing summertime operational low-levels of the B and C Reservoirs to 40 feet. The City can further mitigate supply issues by improving transmission in the B and C Levels, as discussed in **Section 5.2.6**.

Increasing the low-level set point during the winter will exacerbate water turnover issues and may trigger low chlorine residual concerns. However, lower winter levels are typically acceptable, because winter demand is typically much lower than summer demands. The City may be able to continue winter operations as is, but should be aware how operational changes affect emergency and fire storage.

Current storage allocations were calculated from existing storage reservoir and pressure zone characteristics to help the City make operational decisions, particularly during high demand conditions. The Calculated Storage Volume Levels are calculated from reservoir floor up and are illustrated in **Figure 5-3** and shown at the bottom of **Table 5-3**. The minimum operating level (Base of Equalization Storage in **Table 5-3**) is the calculated low point the reservoir levels should not dip below during normal operations, to maintain adequate fire and emergency storage.

Figure 5-3 | Calculated Storage Volume Levels

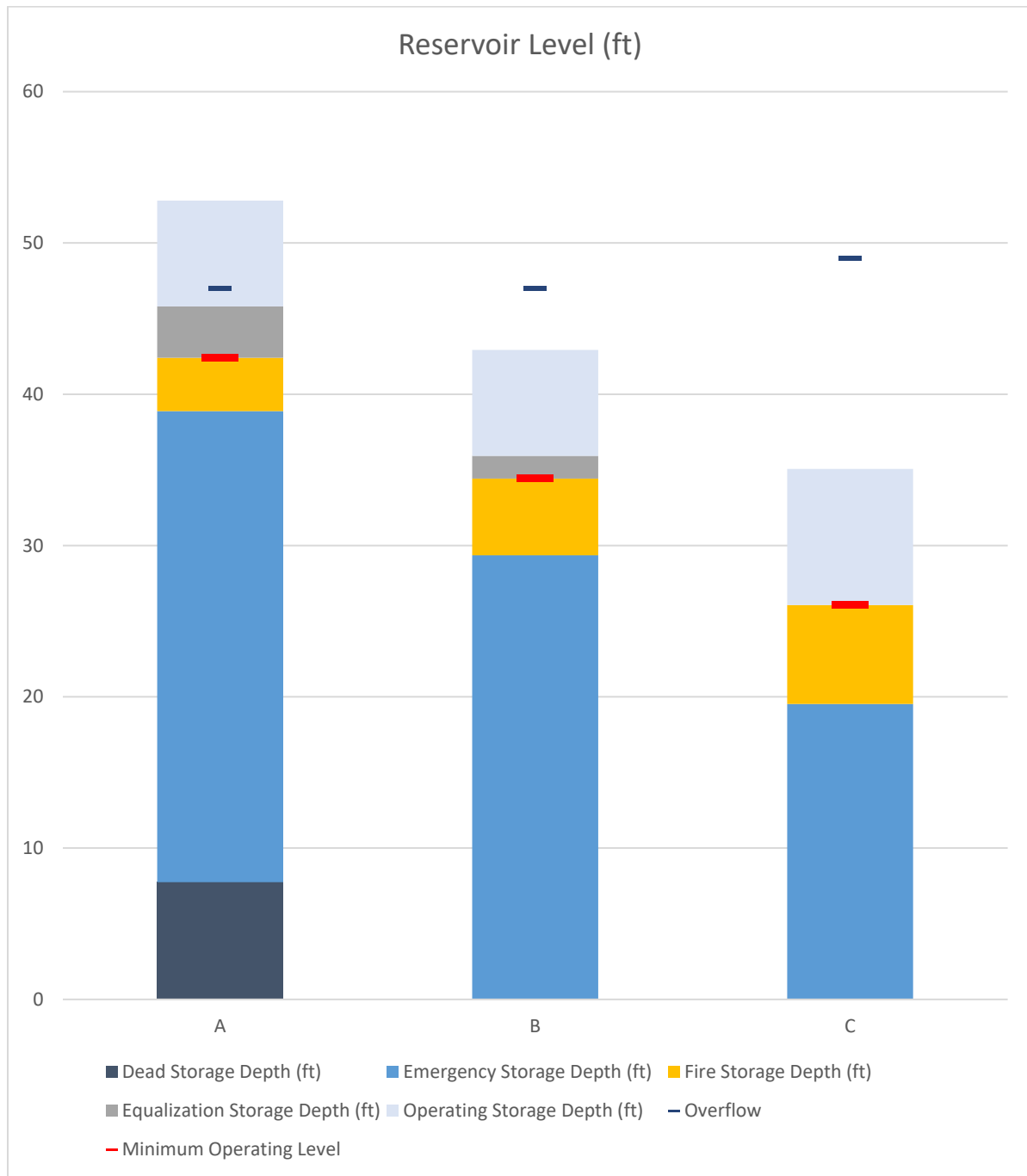

Note:

The A Level existing storage deficit as noted in **Section 5.3.1**, is illustrated by the operating storage depth exceeding the overflow depth.

Table 5-3 | Minimum Reservoir Storage Levels

Tank Characteristics	Pressure Zone		
	A	B	C
Tank Floor Elevation (ft)	248	352	458.5
Tank Height (ft)	47	47	49
Existing Summer Low Level (ft)	40	40	40
Existing Storage (MG)	7.2	5	1.8
Volume/Depth (MG/ft)	0.153	0.106	0.037
Zone Characteristics	A	B	C
Maximum Zone Ground Elevation (ft)	198	286	359
Minimum HGL to serve maximum ground elevation at 25 psi (ft)	255.75	343.75	416.75
Minimum Tank Depth to serve maximum ground elevation at 25 psi (ft)	7.75	0	0
Dead Storage (MG)	1.2	0	0
Usable Storage (MG)	6	5	1.8
Zone Demand, Fire Flow, and Supply	A	B	C
2020 Average Day Demand (MGD)	2.39	1.56	0.36
2020 Max Day Demand (MGD)	4.58	3	0.69
PHD: Max Day Demand PF	2	2	2
Fire Flow Rate (gpm)	3000	3000	2000
Fire Flow Duration (hrs)	3	3	2
Qs (regularly available supply to zone) (gpm)	2900	3100	1400
Calculated Storage Volumes	A	B	C
Emergency Storage (MG)	4.77	3.12	0.72
Fire Storage (MG)	0.54	0.54	0.24
Equalization Storage (MG)	0.52	0.16	0
Operating Storage (MG)	1.07	0.74	0.33
Calculated Storage Volume to Depth Conversion	A	B	C
Operating Storage Depth (ft)	7	7	9
Equalization Storage Depth (ft)	3	1	0
Fire Storage Depth (ft)	4	5	7
Emergency Storage Depth (ft)	31	29	20
Dead Storage Depth (ft)	8	0	0
Calculated Storage Volume Levels (Shown in Figure 5-3)	A	B	C
Tank Overflow (ft)	47	47	49
Base of Operating Storage (ft)	46	36	26
Base of Equalization Storage (ft)	42	34	26
Base of Fire Storage (ft)	39	29	20
Base of Emergency Storage (ft)	8	0	0
Floor (ft)	0	0	0

5.4 Pump Station Analysis

The City relies on pumping under two situations: 1) normal operation and 2) PWB supply disruption.

1. Under normal operation, the only system pumping required is from the B to C Level. This is via the C Level Pump Station located at the Norwood Reservoir (B Level) site. The A and B Levels are supplied by gravity directly by FCV/PRV connections off the Tualatin Supply Main and do not require pumping under normal operations.
2. If supply from PWB through the TSM is disrupted, or the Boones Ferry FCV/PRV is offline, pumping would be required from the A to B Level. This is in addition to the regular C Level pumping.

Station reliability, pumping redundancy, and zone supply capacity will be addressed below based on these two supply modes.

5.4.1 Capacity Analysis

Pumping capacity will be discussed by zone supply, from A to B Level and from B to C Level. Pumping to the B Level must meet the needs of both the B and C Levels because all C Level supply is pumped from B Level. Pumping from A to B is only required under emergency or maintenance operations and therefore the entire station capacity can be used to meet MDD. While there are two existing A to B Level pump stations (Martinazzi and Boones Ferry), they are not reliably operable, have insufficient capacity, and have reached the end of their usable lives and are not included as existing emergency supply. B to C Level pumping is required for normal operation and so the station should be able to meet MDD under firm capacity (largest pump out of service).

Table 5-4 summarizes the recommended pumping capacity through buildout.

Table 5-4 | Pumping Capacity Needs

Operation Type and Pump Conditions	Supply Failure Pumping, A to B Level:	Normal Pumping, B to C Level:
	Emergency – Total Capacity	Normal - Firm Capacity
Existing Pump Station	None ⁴	C Level (Norwood)
Number of Existing Pumps	0	2
Existing Station Firm Capacity ¹ (MGD)	0	2.02
Service Area(s) Supplied	B+C ⁵	C
Max Day Demands (MGD)		
Existing	3.69	0.69
2040	4.73	1.32
Buildout	5.38	1.43
Pumping Deficit ³ (MGD)		
Existing	-3.69	1.33
2040	-4.73	0.70
Buildout	-5.38	0.58

Notes:

1. Firm capacity is the station capacity with the largest pump out of service. The C Level pump station has two equal pumps and so firm capacity is a single pump active.
2. A negative value under pumping deficit indicates additional pumping required to meet system demands.
3. The existing Boones Ferry and Martinazzi Pump Stations are in poor condition, have reached the end of their usable lives, and are not exercised sufficiently for reliable operation. Therefore, neither is shown with existing capacity.
4. The C Level is supplied from B Level, therefore pumping capacity to the B Level must be adequate to meet MDD of both B and C Levels.

5.4.2 C Level Pumping

The C Level, Norwood Pump Station operates daily and is the only supply to the C Level. Based on the capacity needs analysis presented in **Table 5-4**, the station's existing firm capacity (one pump out of service) of 2.02 MGD (1,400 gpm) is adequate to supply the needs of the C Level through buildout. However, additional improvements and a second pump station should be considered for risk mitigation.

The City considers the existing station reliable based on historical operations. With consistent maintenance, the City does not foresee a need to change operations to improve reliability. The City should add permanent standby power with automatic switching in the event of a power failure to the station.

The station is not operationally redundant. This means there is no secondary supply to the C Level, whether from a pump station or PRVs from higher levels. A failure of the C Level Pump Station or supply mains would mean total reliance on the stored water in the C Level Reservoirs, or possible emergency supply from the City of Wilsonville via the Wilsonville Intertie. If the C Level Reservoirs are completely full, this translates to about 64 hours of supply under present MDD, or 33 hours of supply under 2040 MDD. If the tanks are lowered to emergency levels (20 feet of storage), supply time is reduced by approximately 3/5 to 27 hours under existing MDD or 13 hours under 2040 MDD.

The City should consider a second supply route to the C Level in the form of a second C Level Pump Station located at the ASR site, once a new B Level Reservoir is constructed onsite as well. The ASR supply may be available sooner after a seismic event than the PWB supply; a reservoir and pump station on site would help supply more City customers if the PWB supply becomes unavailable. As it is the City's preference to not construct a pump station that's only purpose is for emergency supply, normal supply to the C Level could be provided regularly by either pump station.

Alternatively, the City could consider purchasing portable pumping equipment for use at the existing 6-inch stub-outs located at the Norwood site. Portable pumping has not been used here in recent memory and the portable pumps the City jointly owns with TVWD (Flow and Eddy) would not work at this location due to pump curve requirements. The City currently would rely on leased equipment (commercial rental businesses) or borrowed equipment (neighboring water systems) for service through the 6-inch stub-outs, although neither of these approaches have been investigated seriously.

5.4.2.1 C Level Fire Flow Pumping

Prior to construction of C Level transmission upsizing (discussed in **Section 5.2.6**), the City should consider adding pressure controls to the C Level Pump Station for improved fire flow availability in the C Level. The current pump station is operated by reservoir level. Fire flow availability is improved when this pump station is active. Currently, there is no guarantee the pump station is active during the fire until the reservoir level drops to their low settings and until then, system pressures may be low if flows above 1,000 gpm are required. A second trigger based on system pressures should be added to the existing C Level Pump Station to activate the station when pressures in the C Level drop below approximately 35 psi downstream of the C Pump Station.

5.4.2.2 C Level Operational Adjustment

Both pumps at the C Level Pump Station are equipped with VFDs, allowing them to modulate supply between on and off. However, they are not currently used. The City should consider modifying the operations to make use of the VFDs to pace flow and maintain constant reservoir levels with longer duration with lower rate pump run cycles, particularly in the summer. In coordination with this operational change, it is recommended the C Level Pump Station setpoint be increased (effectively reducing the required operational storage volume and increasing the volume available for equalizing, fire suppression, and emergency). With active mixing of reservoir contents, deep cycling of the reservoirs is less important for maintaining water quality, especially during the peak summer season.

5.4.3 Supply Failure Pumping

The Boones Ferry FCV/PRV is the only supply to the B and C Levels. A pump station from A to B Level is recommended for redundancy and reliability. Three alternatives for this pump station are outlined in this section.

A pump station from A to B Level could potentially address two supply failure conditions. First, the pump station could supply the B and C Levels when the Boones Ferry FCV/PRV supply is offline for either maintenance or failure. Second, if all supply from PWB is disrupted and the City has a connection to the WWSS as recommended in the *Supply Alternatives Technical Memorandum* (2021, The Formation Lab) and summarized in **Section 0**, then the City could take WWSS water through the Sherwood Emergency Supply Main to the TSM. It is unclear whether there would be sufficient hydraulic grade to directly serve the B Level. A pump station from A to B Level would allow WWSS water to be pumped up to the B and C Levels. This would require an amendment to the City Charter which currently prohibits the City from using Willamette River water for municipal use unless the Governor declares an emergency. It is not clear if a disruption in the PWB supply would constitute such an emergency that would allow the City to override the charter and use Willamette River water.

5.4.3.1 A to B Level Pumping Alternatives

Three pumping alternatives were developed to address deficiencies in the event of a supply failure and provide a reliable supplement to the primary B Level supply from the TSM (Boones Ferry FCV/PRV supply): 1) upgrade or replace the existing Martinazzi Pump Station, 2) build a new pump station near the A-2 reservoir, or 3) acquire and build a portable pumping system. An analysis of these three alternatives is summarized in the following sections.

5.4.3.1.1 Alternative 1: Upgrade Martinazzi Pump Station

The City could upgrade the existing Martinazzi Pump Station. This will likely require a complete replacement as the existing underground station is past its usable lifespan, not seismically up to code, and extensive structural upgrades would be required in addition to pump upsizing. A new pump station would ideally include a modern pump station structure with adequate access, operations and maintenance, and safety features, likely necessitating land acquisition for this alternative.

The Martinazzi Pump Station is located adjacent to 12-inch diameter A and B Level piping and is in close proximity to the major transmission piping from the Boones Ferry FCV/PRV to the Norwood Reservoir, which means this site will likely not require upsizing of nearby piping to adequately transmit A to B Level flows. However, transmission from the proposed emergency connection at the WWSS would be through existing piping in the A Level and may be limited due to the size of transmission piping across the A Level and the distance between the proposed connection point and the Martinazzi Pump Station.

In addition, the existing Martinazzi Pump Station site may be inadequate to support a modern pump station structure with the required access, operations and maintenance, and safety features required, likely necessitating land acquisition for this alternative.

As a permanent pump station, the new Martinazzi Pump Station could be set up to run for a few hours once a week, or as is necessary, to ensure the station is available for emergency conditions.

Continued operation of this station would not need to be significant but could address some of the failures of the existing two stations.

5.4.3.1.2 Alternative 2: Build a New Pump Station at the A-2 Reservoir Site

A new pump station could be built adjacent to the existing A-2 Reservoir on the west side of the system. There are two primary advantages to this solution: improving existing water quality issues and location. Significantly, however, this alternative is highly contingent on development of the Southwest Industrial Area for transmission piping that may not occur in this planning period.

While the primary purpose of this station would be for supply disruption, the pump station could be operated regularly to boost B Level supply and water quality. This alternative would improve the turnover in the A-2 Reservoir during normal operation by pulling more water through the tank, although existing water quality issues have been largely mitigated by chlorine boosting and tank mixing. This alternative would also provide supplemental pumping capacity to the B Level during peak demands, particularly on the west side of the system to help supply new development and large fire flows.

The site is located in close proximity to the proposed emergency supply connection to the WWSS which would result in the ability to effectively supply the B Level without the construction of additional transmission piping. The advantage of this alternative is increased if the City considers the use of the City of Sherwood's 24-inch diameter PWB supply main to transmit water to the east side of the A Level, as well.

However, a pump station at the A-2 site has several disadvantages. This alternative is contingent on the development of B Level piping south from the A-2 Reservoir through the existing Tigar Sand and Gravel properties. Either significant pipe installation will be required prior to development, or the City will continue to be without emergency supply until development reaches this area, which could be beyond the planning period of this WSMP. A pump station at the A-2 site also needs to contend with significant road and infrastructure crossings. 124th Street is a significant thoroughfare and construction in this right of way may include additional constraints. Crossing the WWSS transmission line is also constrained by the WWSS. Significant coordination with the WWSS and major site limitations may limit feasibility of this location.

5.4.3.1.3 Alternative 3: Portable Pump Stations

Portable pumping would expand the existing portable pumping infrastructure. The City currently has three sites where a Portable Pump Station can be installed to provide supplemental pumping. Two of these sites (along SW Avery Street and the Boones Ferry FCV/PRV site) provide pumping from the A to B Levels. Additional stub out locations could be built at several sites along the A/B Level interface. Several portable pumps would need to be purchased and could be installed at any combination of these sites to provide sufficient supply to match the failure.

Portable pumps allow for locational flexibility and could be used for failures in the C Level pumping and/or be available as a regional resource to aid in a regional emergency.

There are several drawbacks to portable pumping. The stations require storage, annual maintenance, and training that would place an increased load on City staff. Additionally, the stations require initial deployment and set up, and cannot be automatically turned on in an emergency. This is especially significant in the not unlikely event that a winter storm and power outage occur during (or directly cause) a supply failure. Moving the stations to deployment locations, and even getting employees on location to operate the stations would be a significant challenge.

5.4.3.1.4 A to B Level Pumping Evaluation and Recommendation

The three alternatives were evaluated based the criteria summarized below in **Table 5-5**.

Table 5-5 | Additional B Level Pumping Alternatives Evaluation

Pumping Alternative:	Upgrade Martinazzi	New Pump Station near A-2 Reservoir	Portable Pumping System
Long Term Capacity Needs	+	+	-/0
Capital Cost	0	0	+
Ease of Operation	+	+	-
Proximity to Emergency Supply	0	+	0
Fatal Flaw	Land acquisition	Land acquisition, WWSS coordination, development timing	Not instantaneous or permanent

Based on the analysis in **Table 5-5**, a new A to B pump station located near A-2 Reservoir would be recommended, if not for the fatal flaw of unknown development timing. Instead, the City should investigate both options of upgrading Martinazzi or portable pumping. The CIP presented in **Section 9** assumes the more expensive option of upgrading Martinazzi Pump Station.

Chapter 6



Section 6

Water Quality & Water Conservation

6.1 Water Quality Regulations

The City, along with all public drinking water systems, must follow both state and federal regulations. At the federal level, the EPA establishes water quality standards, monitoring requirements, and enforcement procedures. At the state level, either the EPA or a state agency will implement the EPA rules. If a state meets certain requirements, it can be given primacy, meaning it is the primary authority for implementing the EPA's rules within the state.

As a primacy state, Oregon administers most of the EPA's drinking water rules through the OHA DWS. The DWS rules for water quality standards and monitoring are adopted directly from the EPA. The DWS is required to adopt rules at least as stringent as federal rules. To date, the DWS has elected not to implement more stringent water quality or monitoring requirements.

In some areas not directly related to water quality, DWS rules cover a broader scope than EPA rules. These areas include general construction standards, cross connection control, backflow installation standards, and other water system operation and maintenance standards. The City's activities are also governed by the DEQ. The complete rules governing the regulation of drinking water systems by DWS in the State of Oregon are contained in OAR Chapter 333, Division 61, Public Water Systems.

6.1.1 Status of Drinking Water Regulations

At the federal level, the SDWA is the primary drinking water regulation. It was originally enacted in 1974 by Congress to ensure the quality of America's drinking water with a focus on water treatment. The act was reauthorized and updated in 1986 and 1996 to expand protections to source water and improve operator training, system improvement funding, and public education. The SDWA contains the following assignment and programs for the EPA and the states to administer:

- State revolving loan fund for water system construction
- Public notification reports
- Source water assessment and protection
- Monitoring reductions based on source water protection
- Mandatory certification of operators

These assignments have been implemented by the EPA and/or individual states and are regularly updated. Under the authority of the SDWA, the EPA sets various rules and regulations to maintain

safe drinking water. The following sections identify relevant rules and the City's existing compliance status.

6.1.2 Disinfectants/Disinfection Byproducts Rule

The City is required to monitor for disinfectants/disinfection byproducts (D/DBP) under stage 1 and 2 of the D/DBP Rule. This rule regulates exposure to disinfectants, disinfection byproducts, and precursors that may react with disinfectants to produce harmful chemicals. Disinfectants are added to drinking water to kill harmful pathogens. At low levels, these disinfectants keep our water safe and do not affect human health. At higher concentrations (such as typical concentrations in pool water), exposure could lead to nausea, vomiting, and diarrhea. Disinfection byproducts occur when disinfectants react with usually non-harmful nutrients in the water to produce contaminants. When these precursors are not present, there is nothing for the disinfectants to react with and so disinfection byproducts are not formed. Therefore, it is important to monitor for both the precursors and resultant contaminants.

Specifically, the D/DBP Rule regulates the following contaminants.

Disinfectants

- Chlorine
- Chloramine
- Chlorine dioxide

Disinfection Byproducts

- Total trihalomethanes (TTHMs)
 - Trichloromethane (chloroform)
 - Tribromomethane (bromoform)
 - Bromodichloromethane
 - Dibromochloromethane
- Haloacetic acids (HAA5s)
 - Monochloroacetic acid
 - Dichloroacetic acid
 - Trichloroacetic acid
 - Monobromoacetic acid
 - Dibromoacetic acid
- Chlorite
- Bromate

The City of Portland currently uses a chloramine treatment process. Therefore, the relevant contaminants for the City are chloramine, TTHMs, and HAA5s.

Stage 2 of the D/DBPs Rule requires that MCL of the listed contaminants be calculated on the locational running annual average of samples taken quarterly. Compliance sites consist both of locations where high concentrations of disinfection byproducts are found (typically sites with long detention times), and sites with average detention times within the distribution system. The number of sites is based on the type of source water and population served. The rule also provides for reduced monitoring for systems with very low disinfection by-products based on two years of existing data.

6.1.2.1 City Compliance

The City is currently monitoring for and maintaining a steady level of chloramine in the system, and is monitoring for D/DBPs and is meeting all D/DBP Rule requirements. Monitoring locations for D/DBPs were identified in a 2006 study, and the City has continued to sample at these same locations at quarterly intervals (see **Figure 6-1**).

Figure 6-1 | Sampling Sites for Disinfection Byproducts

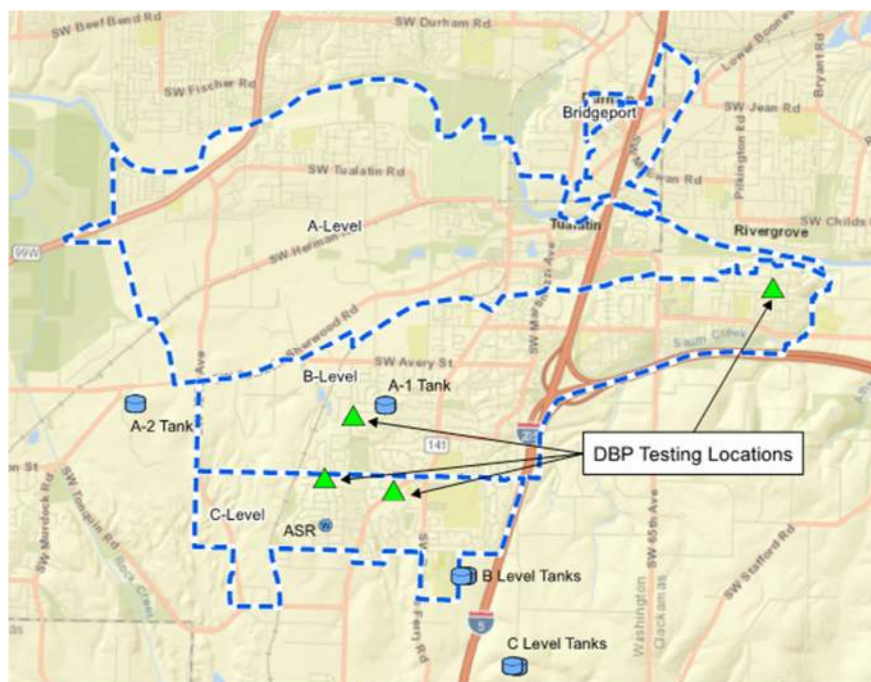

Statistics for the TTHM and HAA5 sampling results from 2017 through 2019 for the Stage 1 and 2 D/DBP Rules are shown in **Table 6-1**. No values exceed regulations. Chlorine monitoring results are discussed in the next section as chlorine levels directly affect total coliforms.

Table 6-1 | Quarterly Disinfection Byproduct Monitoring Results

	Trihalomethanes (TTHM) (mg/l)	Haloacetic Acids (HAA5) (mg/l)
Maximum Contaminant Level (Regulation)	0.080	0.060
Quarterly DBP Monitoring Results, 2017 – 2019		
Average Measurement	0.027	0.026
Maximum Measurement	0.046	0.041

6.1.3 Total Coliform Rule

The City is required to monitor for coliform bacteria under the Total Coliform Rule, which applies to all surface water and groundwater systems. Most coliforms are not disease causing. Rather, their presence indicates the sanitary conditions of the water and are one of the easiest indicator species to monitor.

Total coliforms include both environmental and fecal coliforms. Both types are important to measure as both can indicate the presence of pathogens, although fecal coliforms are generally more concerning. E. coli bacteria is used to indicate fecal coliforms, as it is one of the major species of fecal coliforms that does not reproduce in the absence of fecal matter.

Sampling requirements vary according to population served and history of positive samples. The City is required to take 30 samples from across the system per month and test for total coliforms. If total coliforms are found to be present at any site, additional testing for E. coli is required to determine compliance.

6.1.3.1 City Compliance

The City is currently meeting all applicable requirements for the Total Coliform Rule.

To ensure continued compliance and minimize bacterial growth, it is important to retain a minimum chlorine residual and limit the accumulation of sediments. Additionally, it is important to maintain active circulation of water throughout the distribution system, in both pipes and reservoirs.

EPA standards for the residual disinfectant concentration in the water entering the distribution system cannot be less than 0.2 milligrams per liter (mg/L) for more than four hours (40 CFR 141.72(a)(3) and (b)(2)). The residual disinfectant concentration in the distribution system cannot be undetectable in more than five percent of the samples each month for any two consecutive months that the system serves water to the public (40 CFR 141.72(a)(4) and (b)(3)). The City samples monthly for chlorine residual at 30 points in the distribution system. In 2019, the average residual of monthly samples ranged from 0.67 to 1.92 mg/L, well above the minimum of 0.2 mg/L and below the maximum recommended level of 4 mg/L (per the D/DBP Rule).

6.1.3.2 Potential City Action

While currently meeting standards, the City should continue to proactively maintain chlorine residuals. Three best practices to maintain chlorine residuals include:

- Distribution system circulation and strategic flushing
- Reservoir turnover and mixing
- Secondary chlorination, as needed

6.1.3.2.1 Distribution System Circulation and Flushing

Stagnant water is problematic for a water distribution system for two primary reasons. Chlorine breaks down over time and if water is not mixed within the distribution system, pockets of low chlorine residual can form which can lead to organic growth. Additionally, stagnant water lets non harmful particles such as calcium deposits settle out of the stream, creating a physical buildup in the pipes blocking flow, and a habitat for organic growth.

Active circulation and sediment accumulation should be considered as new pipelines and reservoirs are added to the system. Large dead-end pipes like those in the industrial area of the A Level should be avoided because the lack of circulation results in a loss of chlorine residual. Where they are installed, it is important for the City to continue the existing program of regular flushing of these lines. Flushing programs must be regular and not just in response to loss of chlorine residuals, because by that time, coliforms may already be growing in the system and in the water delivered to customers. The locations of these large, dead-end pipes should be identified and tracked in the City's asset management program.

6.1.3.2.2 Reservoir Turnover and Mixing

Reservoirs should be designed and operated to ensure adequate mixing and reservoir turnover to promote good water quality. The City's reservoirs include inlet mixing systems on most reservoirs, and reservoirs are operated at reduced capacity to ensure adequate turnover during periods of low water use. In order to improve reservoir mixing, if future conditions warrant (low disinfectant residuals in the distribution system), an active mixing system could be considered. These systems include solar- or utility-powered internal mixers or external circulation pumps.

6.1.3.2.3 Secondary Chlorination

Secondary chlorination is another option to boost chlorine levels in the distribution system. This action must be properly calibrated based on the specific chemistry of the system to prevent harmful levels of DBPs. Free chlorine will react with organic materials in the water and result in high levels of DBPs. For the City, booster chlorination would serve the purpose of forming chloramines by adding chlorine to bind up free ammonia that is present as a result of decay of the source water disinfectant. Because of the risk of DBP formation and the challenges of obtaining the proper ration of chlorine to ammonia, secondary chlorination should only be considered if other measures are not adequate.

The City has identified chlorine residual issues in the vicinity of the A-2 Reservoir and has a booster trailer set to maintain a chlorine residual of 1.00 mg/L. Future system improvements, specifically expansion of the B Level and development of a new A Level to B Level pump station near to the A-2 Reservoir will help reduce water age in the reservoir and reduce the need for booster chlorination.

6.1.4 Lead and Copper Rule

The Lead and Copper Rule (LCR) was first established in 1991 to limit lead and copper exposure. The LCR was updated with revisions in 2000, 2007, and 2016 and full text can be found on the EPA website (<https://www.epa.gov/dwreginfo/lead-and-copper-rule>). The most common sources of lead in the water system are pipes, faucets, and plumbing fixtures. Therefore, testing within the distribution system, rather than just at the water source, is important.

Historically, the City was sampled as part of the PWB Bull Run system for LCR monitoring, also known as the Joint Monitoring Program (JMP). Four samples were collected yearly in the City since 1999. In the fall of 2016, the City of Tigard left the JMP and the City increased sampling to 9 homes. In spring 2017, TVWD left the JMP and the City increased sampling to 15 homes. Due to continued operation of the City's ASR program, the City left the JMP in the fall of 2017 and began its own Lead and Copper Monitoring Program. In 2020, after three rounds of lead and copper results below EPA Action Levels, the City reduced monitoring to annually from June 1 – September 30 at 63 customer taps across the City. If there is an exceedance, sampling requirements may increase and additional reduction actions will apply.

Water samples at the customer's tap are required to be taken at high-risk locations, which are defined as homes with the following conditions.

- Lead solder installed after 1982
- Lead service lines
- Lead interior piping

For a water system to comply with the LCR, the samples at the customer's tap must not exceed the following action levels.

- Lead - 0.015 mg/L detected in the 90th percentile of all samples
- Copper -1.3 mg/L detected in the 90th percentile of all samples

If action levels are exceeded for either lead or copper, there are additional requirements including source monitoring, public education, and corrosion control studies.

The EPA finalized additional revisions to the LCR that took take effect on December 16, 2021. The specific requirements of the final rule revisions include:

- Updated sampling procedures to improve identification of elevated levels of lead at customer taps

- Revised action levels and corrosion control treatment implementation timelines
- More aggressive lead service line replacement requirements
- Water utility inventory of lead service lines
- Sampling at schools and child-care facilities

The proposed LCR revisions should not have a significant impact on the City’s compliance. It is anticipated that the most significant action required will be the completion of the lead service line inventory, which is required by September 16, 2024. The City should review the requirements of the rule update to confirm if there are revisions that may impact the City’s compliance.

6.1.4.1 City Compliance

The City is currently monitoring annually for lead and copper at high risk customer taps. In Spring of 2019, five of the 63 samples exceeded EPA action limits. No additional actions are currently required for the City. However, the goal for detectable lead is 0 mg/L, as any lead can be potentially harmful. Therefore, PWB is actively working to increase corrosion control to limit dissolving lead from pipes and fixtures into water. Currently, PWB adds a combination of soda ash and carbon dioxide during water treatment for pH adjustment. A summary of the lead and copper monitoring for the City and PWB for reference is presented in **Table 6-2**.

Table 6-2 | Lead and Copper Rule Monitoring Results, 90th Percentile

	City of Tualatin				Portland Water Bureau ²				
	Lead		Copper		Lead		Copper		
Action Level, 90th Percentile (mg/l)	0.015		1.30		0.015		1.30		
Result (mg/l) / Exceedance (Y/N) ¹									
2020 - Fall	0.0121	N	0.2253	N	0.0138	N	0.2620	N	
2019 - Spring	0.0120	N	0.154	N	0.0131	N	0.2690	N	
2018 - Fall	0.0120	N	0.167	N	0.0119	N	0.2163	N	
2018 - Spring	0.0170	Y	0.159	N	0.0126	N	0.2212	N	
2017 - Fall	0.0160	Y	0.159	N	0.0170	Y	0.2520	N	
2017 - Spring	0.0145	N	0.190	N	0.0145	N	0.1948	N	

Notes:

Lead and Copper results from yourwater.oregon.gov

PWB results shown for reference.

6.1.5 Unregulated Contaminant Monitoring Rule

The EPA uses the Unregulated Contaminant Monitoring program to collect data for contaminants suspected to be present in drinking water, but that do not have health-based standards set under the SDWA. The program began in 1996 with Rule 1. The Unregulated Contaminant Monitoring

Rule 4 (UCMR 4) was enacted by the EPA in December 2016, requiring monitoring for 30 contaminants between 2018 and 2020 (summarized below).

UCMR 4 List 1 Contaminants

Cyanotoxins	Oxyfluorfen
Total microcystin	Profenofos
Microcystin-LA	Tebuconazole
Microcystin-LF	Total permethrin (cis & trans)
Microcystin-LR	Tribufos
Microcystin-LY	
Microcystin-RR	Brominated Haloacetic Acid Groups
Microcystin-YR	HAA5*
Nodularin	HAA6Br*
Anatoxin-a	HAA9*
Cylindrospermopsin	
	Alcohols
Metals	1-butanol
Germanium	2-methoxyethanol
Manganese*	2-propen-1-ol
Pesticides and Pesticide Manufacturing Byproduct	Semivolatile Chemicals
Alpha-hexachlorocyclohexane	Butylated hydroxyanisole
Chlorpyrifos	O-toluidine
Dimethipin	Quinoline
Ethoprop	

Note: An asterisk (*) indicates the contaminant was detected in the City's water. At the levels detected, negative health effects are unlikely. More detailed results are available on the City's website at tualatinoregon.gov/publicworks/water-quality.

6.1.6 Aquifer Storage and Recovery Sampling

The City operates an ASR facility under Limited License #010. Licensing requirements include additional water quality sampling and reporting to the OHA DWS. Pilot testing began at the facility in 2009.

Current sampling and reporting is set by the *Monitoring Plan for Cycle Year 11-15 (GSI, 2019)*. The monitoring schedule laid out in the plan was created to ensure water quality standards are met throughout the year in the source water, stored groundwater, and recovered water. The City is required monitor for various water quality parameters including field parameters, geochemicals, metals, DBPs, microbial growth, radionuclides, synthetic organic compounds (SOCs), and volatile organic compounds (VOCs). The complete list and frequency of monitoring is documented in the *2019 Monitoring Plan*.

6.1.6.1 City Compliance

Based on test results from required monitoring, water injected into and recovered from the ASR currently meets or exceeds state and federal drinking water standards. The most recent ASR monitoring results are summarized in the *ASR Cycle 11 Test Results Report (GSI, February 2020)*.

6.1.7 Additional Wholesale Provider Regulatory Issues

As the source water provider, PWB is responsible for sampling, monitoring and compliance with numerous water quality regulations that do not need to be addressed directly by the City. These include:

- Synthetic Organic Chemicals and Inorganic Chemicals
- Volatile Organic Compounds
- Arsenic
- Sulfate
- Fluoride
- Radon/Radionuclides
- Groundwater Rule
- Surface Water Treatment Rule and Supplementary Rules:
 - Interim Enhanced Surface Water Treatment Rule
 - LT1ESWTR
 - LT2ESWTR

6.1.7.1 City Compliance

As the wholesale water provider to the City, PWB is responsible for meeting these regulatory requirements. The cost to meet these requirements is passed on to the City and other wholesale customers through wholesale water rates. The primary water supply for PWB is the Bull Run Watershed, a protected watershed near Mount Hood. All human access to the watershed is highly controlled and it is geographically isolated from upstream impacts by a ridge.

The PWB is proceeding with designs for a water treatment facility to comply with the EPA requirement to reduce potential for cryptosporidium contamination under the LT2ESWTR. Currently PWB is planning on completing design and construction of a new water filtration facility by 2027.

6.2 Water Conservation

The City is not required by the state to develop a formal Water Management and Conservation Plan as it does not have any active municipal water rights. However, PWB requires the City to establish a joint conservation program and create a water conservation plan under the wholesale water supply agreement and the City is committed to reducing water usage.

The City implements various aspects of water conservation including:

- Public education and outreach as part of the RWPC
- Leak prevention and detection

6.2.1 Public Education and Outreach

As a member of the RWPC, the City actively participates in regional water conservation program development and implementation. Comprised of 23 water providers and the Metro Regional Government, the RWPC provides a forum for collaboration on water supply, resource management, emergency preparedness, and conservation issues affecting the region. The 2016 Regional Water Supply Plan Update is the region's water supply strategy and recognizes that water conservation plays a key role in meeting future water needs. The updated plan evaluated regional source options while reflecting the actions and plans of the individual members. The plan also updated water demand forecasts and continued to emphasize opportunities for regional conservation programs where economies of scale and regionally consistent conservation messages and benefits can be achieved. The RWPC's conservation objectives are to:

- Plan and implement regional programs and events focused on reducing peak summer water use.
- Effectively encourage customers to visit and utilize the web site at www.regionalh2o.org.
- Integrate consistent conservation messages into the daily lives of customers.
- Develop and implement effective monitoring and reporting techniques to verify program effectiveness.
- Invite stakeholder participation in conservation program development.
- Seek economies of scale by working together.
- Foster public awareness of the RWPC's collaborative efforts.

The RWPC's conservation plan contains a variety of programs and outreach opportunities which include:

- Summer marketing campaign
- Education programs
- Regional events
- Landscape industry partnerships
- A web site (www.regionalh2o.org)
- Informational materials (brochures, kits, and water-saving devices)

Given the City's participation in RWPC, further City-specific public education and outreach programs are not likely to offer cost-effective water conservation results.

6.2.2 Leak Prevention and Detection

Water loss prevention and leak detection programs are typically economical when annual water losses regularly exceed 10 percent. Given that the estimated percentage of unaccounted-for water in the City water system is below this level, the City does not currently have and is not planning for implementation of a comprehensive on-going leak detection program within the distribution system. However, the City regularly replaces leaking water meters, provides guidance and troubleshooting for customers on the customer side of the meter, and encourages residents to take advantage of the leak detection program through the RWPC.

Additionally, the City has actively replaced aging water mains systematically with a focus on existing asbestos cement pipe and associated service lines to reduce water loss and excessive main breaks. The continuation of this program as a key element of the City's water system capital budget is recommended to maintain current low levels of water loss.

6.2.3 Water Conservation Recommendations

As a member of the RWPC, the City contributes funds to the promotion of water conservation throughout the Portland Metropolitan area and realizes significant benefit from the conservation program of this organization. It is recommended that the City continue to invest its water conservation funds in the larger RWPC conservation program. Generally, further investment in City-specific water conservation measures is not recommended at this time; however, as the City continues to grow and develop, future efforts to encourage and support water conservation efforts may help to delay the need to make substantial capital improvements to meet increased water demands. It is recommended that the City develop tools to monitor, track and document infrastructure failures to better inform the need for age or condition-related replacements. This should include annual water loss auditing, development of an asset management database, and potential use of targeted non-destructive pipeline condition assessment techniques to evaluate critical pipeline assets. The City should also continue to evaluate potential conservation-encouraging programs with future WSMP updates.

Chapter 7



Section 7

Seismic Resilience Evaluation

7.1 Introduction

Cities throughout the region are increasingly aware of the risk to their infrastructure from potential seismic activity. Following recent seismic research, which presented persuasive evidence on the eminent threat and extreme risk of a CSZ earthquake, the State of Oregon developed the ORP in 2013. The ORP established target timelines for water utilities to provide service following a seismic event. The ORP also recognized that currently water providers and existing water infrastructure are unable to meet these recovery goals. To improve existing water systems' seismic resilience, one of the ORPs key recommendations was for water utilities to complete a seismic risk assessment and mitigation plan as part of their periodic WSMP update. The State of Oregon formalized this recommendation under 333-061-0060(5)(J) and now cities located in seismic hazard areas are required to include a seismic risk assessment and mitigation plan in their WSMPs.

As part of this WSMP, the City has chosen to complete a seismic risk assessment of their existing water system. The scope of this evaluation includes risk findings and general recommendations regarding seismic design standards for future water infrastructure. Recommended improvements to mitigate specific facility risks will be included in this WSMP's capital improvement list or will be assessed by the City as follow-on work to this WSMP.

The overall objective of this evaluation is to identify and document risks and establish a framework for mitigating these risks over a 50-year or longer period so the City's water system achieves a higher level of resilience to seismic events.

A companion section of this WMSP, **Section 9** Emergency Water Plan, was prepared in coordination with The Formation Lab and documents short-term strategies to provide emergency water supply within the City following a seismic event (or other water system disruption). The recommendations presented in that report (**Appendix B**) are intended to provide mitigation for a seismic event, if it occurs before the City can implement the resilience recommendations presented herein.

7.2 Key Water System Facilities

Through a workshop process involving City staff and local/regional emergency responders, the project team identified the transmission backbone and key facilities that should have water service uninterrupted or quickly restored post seismic event, consistent with ORP guidelines. Critical customers or potential emergency water distribution sites were also identified, primarily along these transmission routes.

After a seismic event, it will be important to return service to critical customers and key locations as quickly as possible. The ORP has developed targets for getting various portions of the distribution system operational (see **Figure 7-1**). These time frames range from 0 to 24 hours for key facilities and 6 months to 1 year for some fire suppression and for the distribution system to be 90 percent operational (current state).

The purpose of these goals is to establish a target for water providers to strive towards over a 50-year period of system improvement and mitigation. *For the City, the capital investment required to meet these goals, especially related to the full distribution system operation, is far greater than the financial resources of the City and will only be achievable if outside sources of State and/or Federal funding become available.* In recognition of this, this section of the WSMP also presents a strategy for post-seismic event response and recovery that reflects the reality that the system may not be significantly more resilient when a major earthquake occurs and prioritizes planning and low-cost investment in the means to provide basic drinking water requirements for the community in coordination with first responders, emergency management agencies, and community groups.

Figure 7-1 | Target States of Recovery for Willamette Valley Water Utilities

KEY TO THE TABLE

TARGET TIMEFRAME FOR RECOVERY:

Desired time to restore component to 80–90% operational

Desired time to restore component to 50–60% operational

Desired time to restore component to 20–30% operational

Current state (90% operational)

G
Y
R
X

TARGET STATES OF RECOVERY: WATER & WASTEWATER SECTOR (VALLEY)											
	Event occurs	0–24 hours	1–3 days	3–7 days	1–2 weeks	2 weeks–1 month	1–3 months	3–6 months	6 months–1 year	1–3 years	3+ years
Domestic Water Supply											
<i>Potable water available at supply source (WTP, wells, impoundment)</i>		R	Y		G			X			
<i>Main transmission facilities, pipes, pump stations, and reservoirs (backbone) operational</i>		G					X				
<i>Water supply to critical facilities available</i>		Y	G				X				
<i>Water for fire suppression—at key supply points</i>		G		X							
<i>Water for fire suppression—at fire hydrants</i>				R	Y	G		X			
<i>Water available at community distribution centers/points</i>			Y	G	X						
<i>Distribution system operational</i>			R	Y	G			X			

7.2.1 Critical Customers

During the workshop with City staff and first responders, a list of potential sites available for water distribution were identified. If the distribution system is unusable, these sites should be available for customers to get water. The locations are primarily located along the backbone transmission lines. Service to the selected water distribution sites should be restored within three to seven days.

One of the most critical customers is the Meridian Park Hospital. It is located in the B Level at SW 65th and Borland Road, just north of I-205. Given the distance from the backbone of the City's system, increasing the resilience of the distribution piping serving these customers will be an expensive, long-term objective. It is understood that the hospital has a well for emergency water supply. The City should coordinate with the hospital to understand their emergency water supply plans and the condition/capacity of this well to supply the hospital's water needs during an emergency that disrupts supply from the water distribution system.

7.2.2 Water System Backbone

The primary objective of establishing this backbone and identifying critical facilities is to focus the City's investment in mitigating seismic risk on these facilities that will be essential to supplying drinking water to the community at discreet locations (and in limited volumes) immediately following a seismic event.

The City identified critical transmission piping and categorized it into two tiers. Tier 1 transmission connects key A and B Level facilities, and Tier 2 transmission includes supply from the PWB and additional transmission mains to the C Level Reservoirs, and the A-2 Reservoir.

The City then used this backbone transmission, critical customers noted in the prior section, and typical system operations to identify key water system facilities. Key City water facilities and their critical supply and distribution functions are summarized in **Table 7-1** and illustrated on **Figure 7-2**. Facilities were assigned a tier corresponding to the connecting transmission piping tiers.

Table 7-1 | Key Water System Facilities

Tier	Facility Name	Critical Functions
1	ASR Facility	▪ Only current supply if PWB supply is disrupted ¹
1	B Level Reservoirs	▪ B Level storage
1	A-1 Reservoir	▪ Primary A Level storage
1	Boones Ferry FCV/PRV	▪ Primary supply to the B Level from PWB
2	C Level Reservoirs	▪ C Level storage
2	A-2 Reservoir	▪ Secondary A Level storage
2	C Level Pump Station	▪ City supply (ASR or PWB) to C Level
2	Leveton FCV/PRV	▪ PWB supply to A Level
2	65th Ave PRPS	▪ City distribution from B to A Level

Note:

The ability to utilize supply from ASR may be disrupted in a major seismic event where main breaks disrupt the connection between the ASR facility and the B Level reservoirs.

7.3 Seismic Hazards Evaluation

The seismic hazards evaluation for the City's water service area was conducted by geotechnical engineers McMillen Jacobs and Associates, as summarized in the following paragraphs. More detailed information is available in their technical memorandum included as **Appendix F**.

7.3.1 Seismicity and Assessment Earthquake

There are two main sources of seismicity in the Tualatin area: the CSZ at the boundary between the oceanic Juan de Fuca Plate and the North American Plate, and crustal faults within the North American Plate. The CSZ is located off the Pacific Coast and stretches from Vancouver Island, British Columbia south to northern California. Subduction zone earthquakes are much larger and longer in duration than crustal earthquakes, but also occur much further away. For the purposes of this evaluation, seismic hazards to the water system are assessed under a CSZ magnitude 9.0 (M9) earthquake as this is regarded as the greatest threat to the region.

Paleoseismic evidence and studies of historical tsunamis indicate that the most recent CSZ event occurred in the year 1700, probably ruptured the full length of the CSZ, and may have reached a magnitude of 9.0. Recent seismological and geological research (Goldfinger et al., 2012) provides the best understanding of the CSZ mega-thrust earthquake hazard for Oregon and Washington. The magnitude of a CSZ earthquake depends on the rupture length along the subduction zone, full rupture will likely generate mega-M9 and above earthquake events, and partial rupture will likely cause large-magnitude 8.0 to 8.5 earthquakes.

These earthquake events are estimated to recur approximately every 500 years for the mega-magnitude full rupture events and 200 to 300 years for the large-magnitude partial rupture events. Thus, the probability of a future occurrence is high because we are “past due” based on historic earthquakes documented in ocean sediments. The CSZ earthquake with a magnitude greater than

8.5 — similar to recent events in Japan, Chile, and Indonesia — has an estimated 16 to 22 percent probability of occurring off the Oregon Coast in the next 50 years (Goldfinger and others, 2016).

7.3.2 Subsurface Condition Assessment

Seismic hazards were evaluated based on existing M9 CSZ earthquake hazard maps published for the Portland Metro region by the DOGAMI (Madin and Burns, 2012). For this assessment, these maps were refined for the City’s water service area (including the Tualatin Supply Main) using geotechnical exploration data and subsurface boring logs from reservoirs, transmission main extensions, and various projects constructed between 1990 and 2017 near critical water facilities.

Legend

- ★ Critical Customer
- Emergency Water Distribution Site
- City Limits
- ◻ Control Valve
- PS Pump Station
- ⊙ ASR
- ⊕ Reservoir
- ▬▬▬ Matchline

Tier 1 Transmission

- ≤ 8"
- 10" - 18"
- 20" - 24"
- > 24"

Tier 2 Transmission

- ≤ 8"
- 10" - 18"
- 20" - 24"
- > 24"
- County Line
- Taxlot

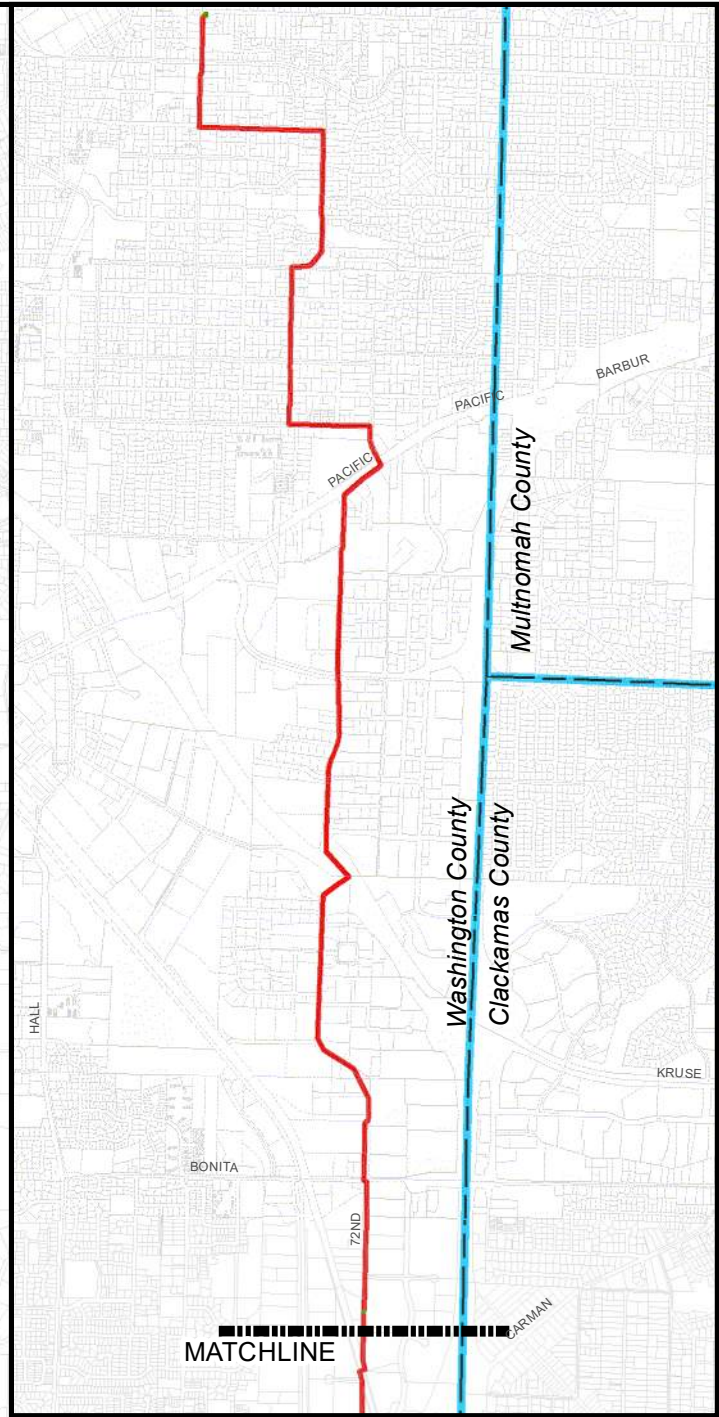
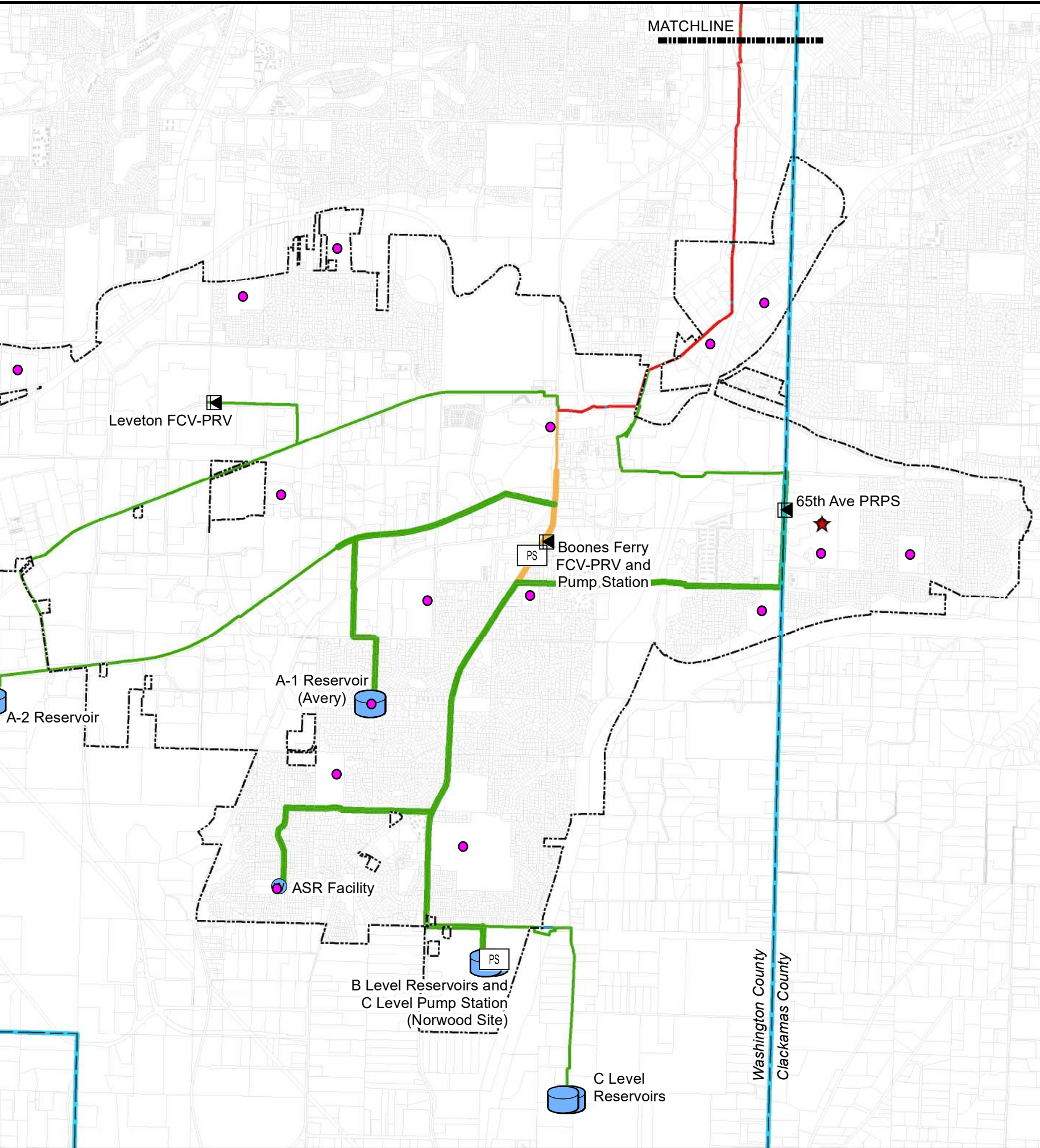

C:\KMM\PROJECTS\17-2000-SEISMIC_v2.mxd 3/16/2023 6:18:06 PM Katelyn McNulty



FIGURE 7-2

**Water Master Plan
Seismic Resilience Evaluation**

Water System Backbone

March 2023
17-2000

7.3.3 Seismic Hazard Findings

The likelihood and magnitude of four sources of seismic hazard were analyzed including the following.

- liquefaction settlement
- lateral spreading displacement
- landslides
- strong ground shaking

These hazards all have the potential to damage buried water mains and other water facilities.

Seismic hazards are present for the City's water system.

- In the A and B levels, a large percentage of the City and its backbone transmission system are located in high to medium liquefaction hazard zones.
- Within the liquefaction hazard zone, lateral spreading is also a hazard along creek banks and other sloped areas steeper than four degrees.

As further discussed in **Section 7.5**, these seismic hazards result in a higher risk of pipeline failure during a seismic event. New piping in areas with higher levels of seismic hazards should be designed to withstand these seismic hazards, and the City should prioritize backbone hardening in these areas where there is the highest likelihood of main breaks and leaks following a seismic event.

7.3.3.1 Liquefaction

Liquefaction occurs when saturated soil experiences enough shaking that it loses its shear strength and transforms from a solid into a nearly liquid state. The results of soil liquefaction include loss of bearing capacity, loss of soil materials through sand boils or flow, flotation of buried chambers and pipes, and post-liquefaction reconsolidation (ground settlement). The assessed liquefaction hazard for the City's water service area is quantified as a magnitude of post-liquefaction settlement.

The liquefaction hazard varies significantly across the service area. Liquefaction potential in the south is low due to the shallow basalt bedrock layer. Liquefiable soils are present in the rest of the project area and there is the potential for over 9 inches of liquefaction induced settlement, predominantly in the northern portion of the service area near the Tualatin River, and along other creeks. Liquefaction hazards for the City's water service area are illustrated on **Figure 7-3**.

7.3.3.2 Lateral Spreading

Associated with soil liquefaction settlement, the liquefied soil and non-liquefied soil crust can generate horizontal movement known as lateral spreading. Lateral spreading generally occurs

near and along riverbanks, as well as other sloped ground. The potential for lateral spreading depends on the liquefaction potential of the soil, the seismic horizontal loading, the residual shear strength of the soil, and the area's topography.

In general, the lateral spreading hazard is minimal over most the water service area due to its relative flatness. Lateral spreading is primarily localized to creeks and rivers, areas with a liquefaction hazard where the ground is sloped steeper than 4 degrees. The highest lateral spreading hazard exists in the sloped ground around the Tualatin River, Nyberg Creek, and Saum Creek. The permanent ground deformation (PGD) in the high hazard lateral spread areas is estimated to be over 6 feet. Lateral spreading hazards for the City's water service area are illustrated on **Figure 7-4**.

7.3.3.3 Landslide

Earthquake induced landslides can occur due to the inertial force from an earthquake adding load to a slope. The ground movement due to landslides can be extremely large and damaging to pipelines.

Due to the relative flatness of the water service area most of the water system is not subject to a landslide hazard. However, steeper slopes along rivers and creeks provide a potential for landslides to occur. Estimated landslide displacement in localized areas of the City is primarily between 1 and 4 feet, as illustrated in **Figure 7-5**.

7.3.3.4 Ground Shaking

The rapid and extreme shaking during an earthquake can cause transient stress and strain in pipelines that can be damaging if the pipe material and joints are not strong enough to withstand the shaking. Damage from ground shaking occurs even when there is no permanent ground deformation. The intensity of ground shaking can be quantified with the PGV at a site due to an earthquake.

The estimated ground shaking intensity, PGV, depends on the subsurface materials. The ground shaking near the surface will be amplified by thick soil units overlying deep bedrock. In areas with shallow bedrock, such as the south, average PGV is estimated to be less than 10 inches per second (in/s). In the A and B Levels, average PGV is expected to be over 15 in/s due to amplification. **Figure 7-6** shows estimated PGV for the water service area.

Legend

- City Limits
- Control Valve
- Pump Station
- ASR
- Reservoir
- Matchline
- Transmission Backbone

Liquefaction Settlement (in)

- <1.0 in.
- 1.0 - 4.0 in.
- 5.0 - 8.0 in.
- > 9.0 in.

County Line

Taxlot

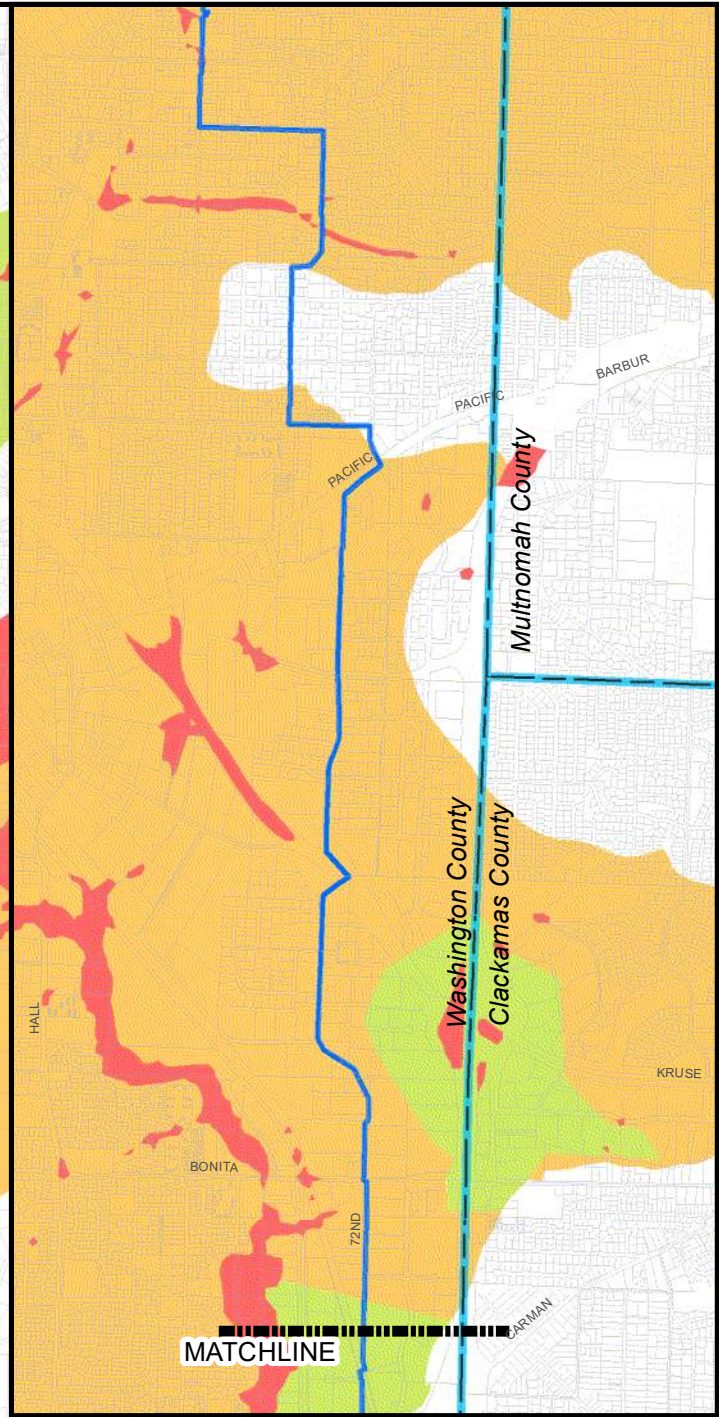
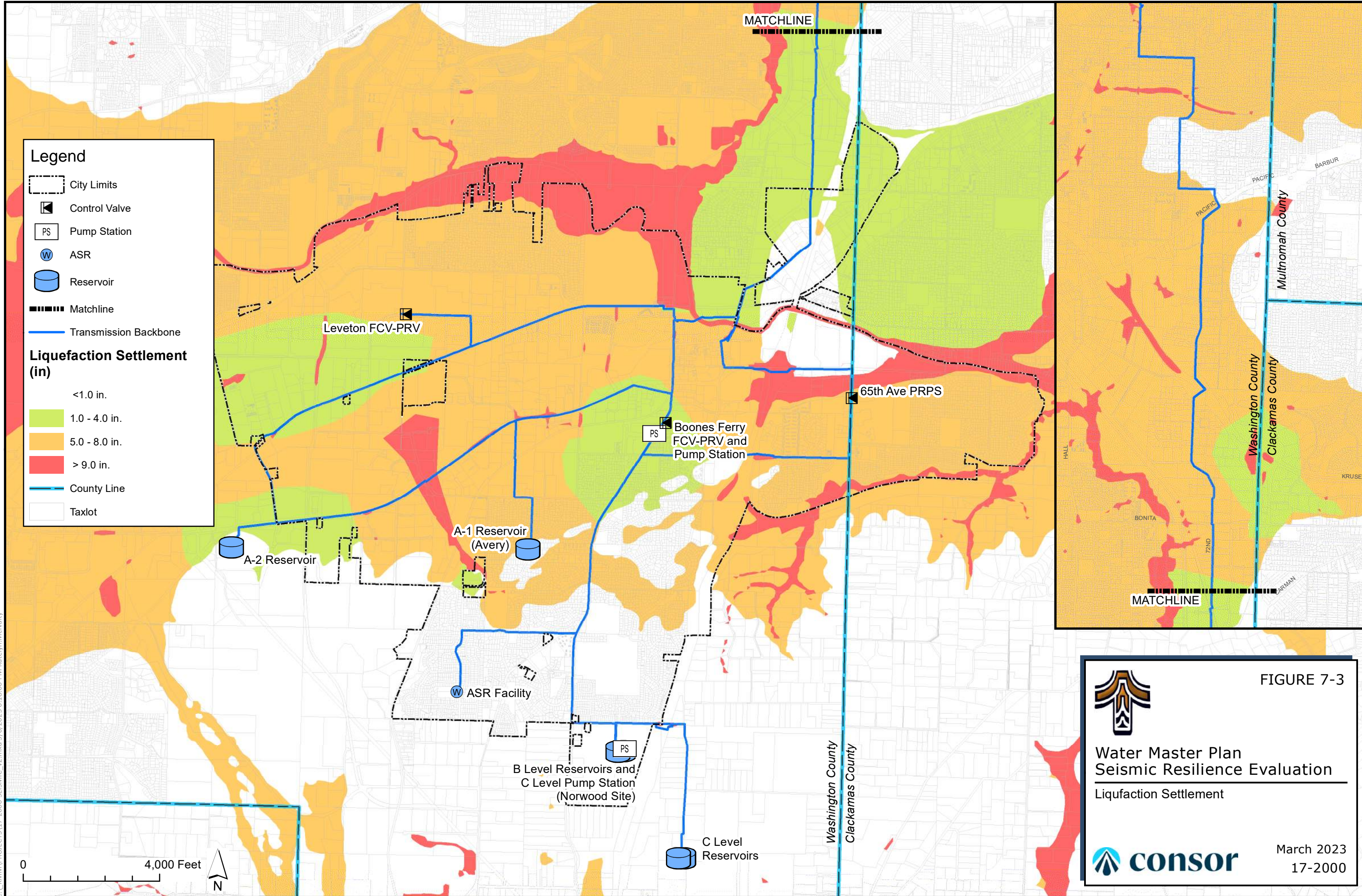

FIGURE 7-3

**Water Master Plan
Seismic Resilience Evaluation**

Liquefaction Settlement

March 2023
17-2000

C:\KMM\PROJECTS\17-2000-SEISMIC_v2.mxd 3/16/2023 6:18:06 PM Katelyn McNulty

Legend

- City Limits
- Control Valve
- Pump Station
- ASR
- Reservoir
- Matchline
- Transmission Backbone

Lateral Spreading (ft)

NO LIQUEFACTION

- 0- 3.0
- 3.0- 6.0
- > 6.0

- County Line
- Taxlot

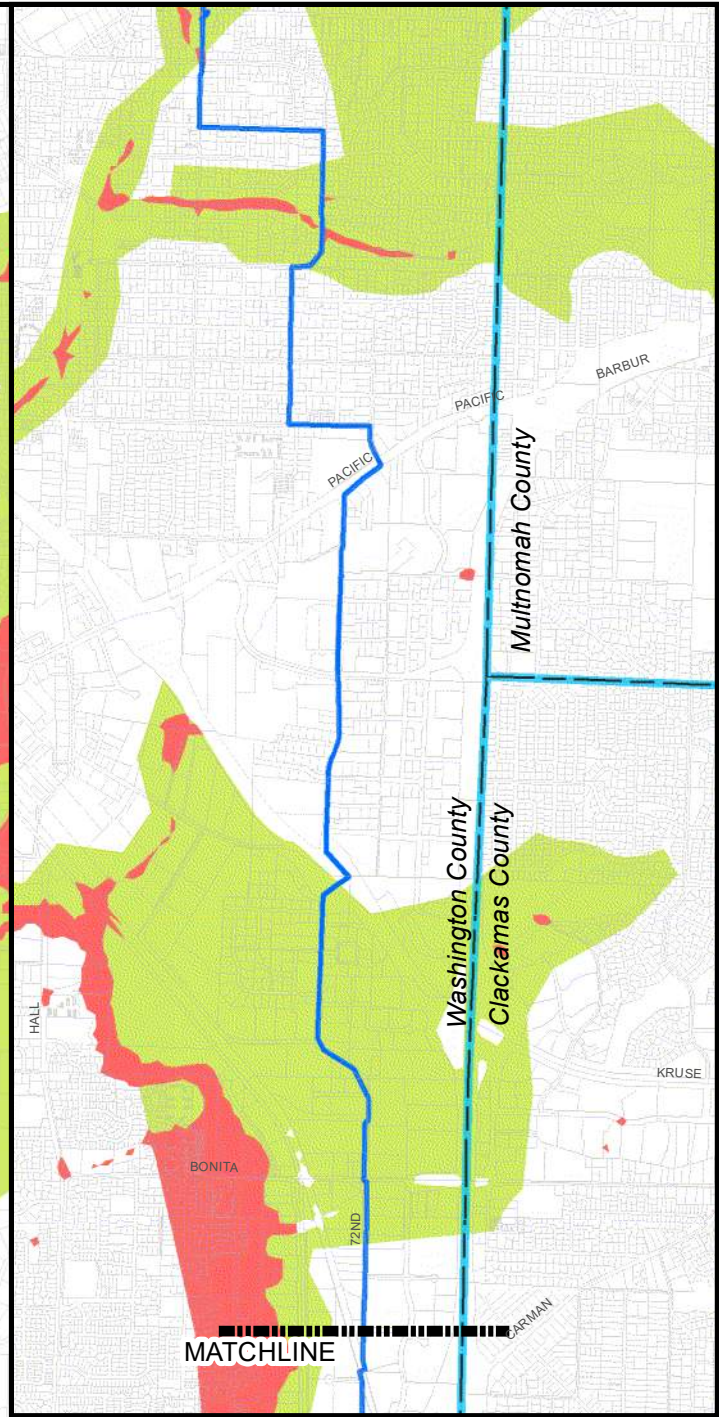
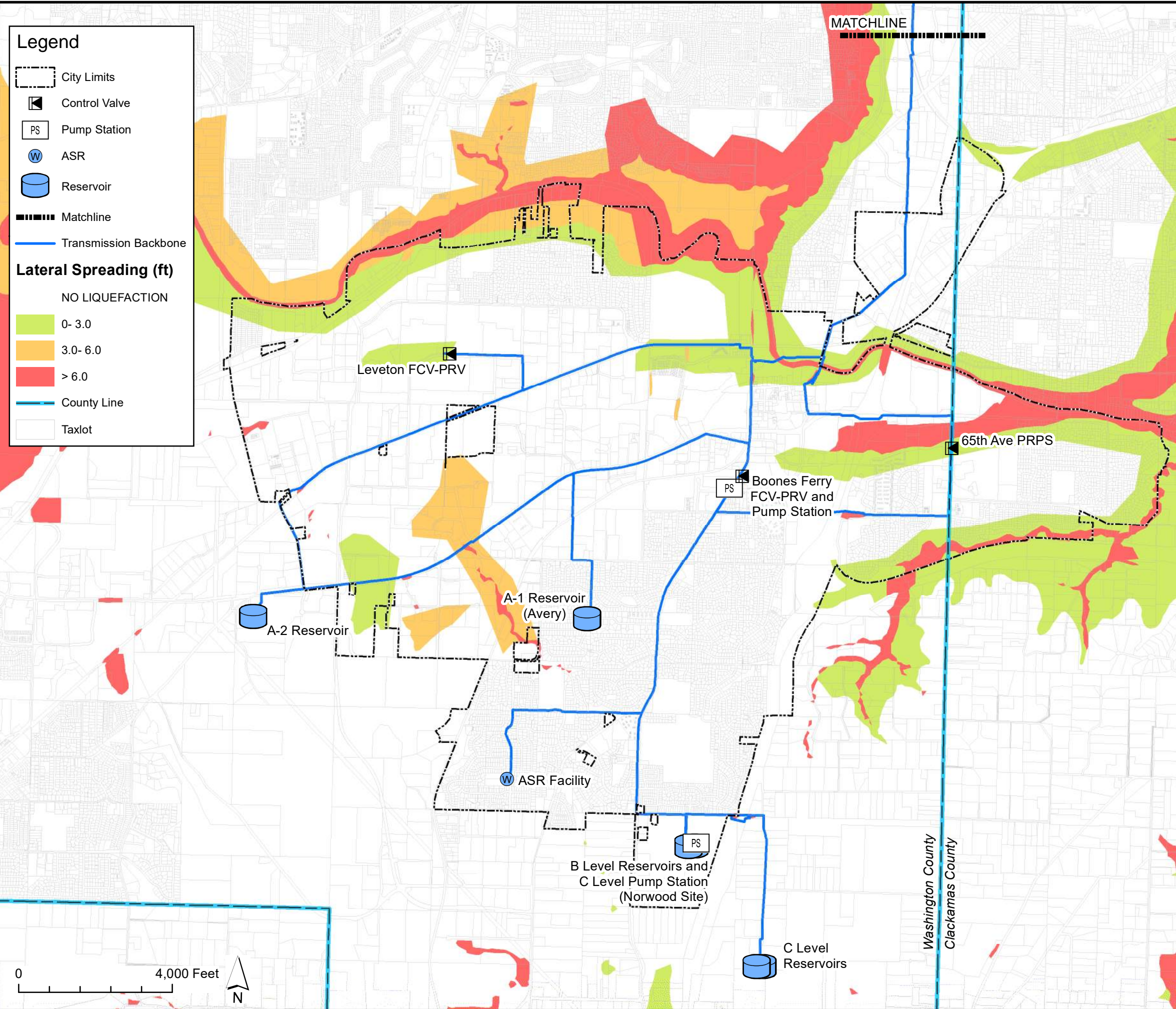

C:\KMM\PROJECTS\17-2000-SEISMIC_v2.mxd 3/16/2023 3:46:26 PM Katelyn.McNulty

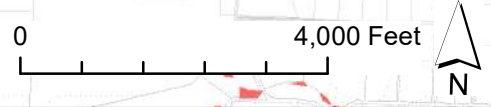

FIGURE 7-4

**Water Master Plan
Seismic Resilience Evaluation**

Lateral Spreading

March 2023
17-2000

Legend

- City Limits
- Control Valve
- Pump Station
- ASR
- Reservoir
- Matchline
- Transmission Backbone

Landslide Displacement (ft)

- < 1
- 1 - 4
- 4 - 10
- 10 - 28

County Line

Taxlot

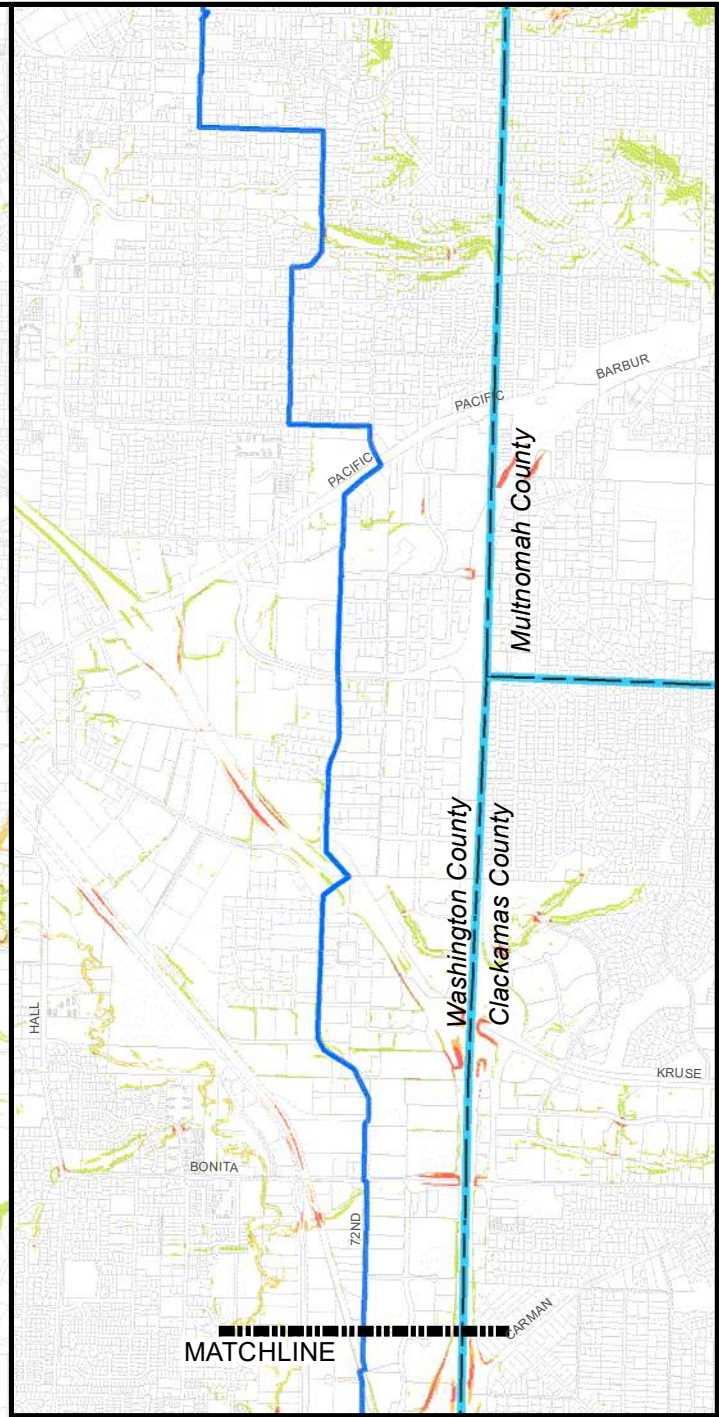
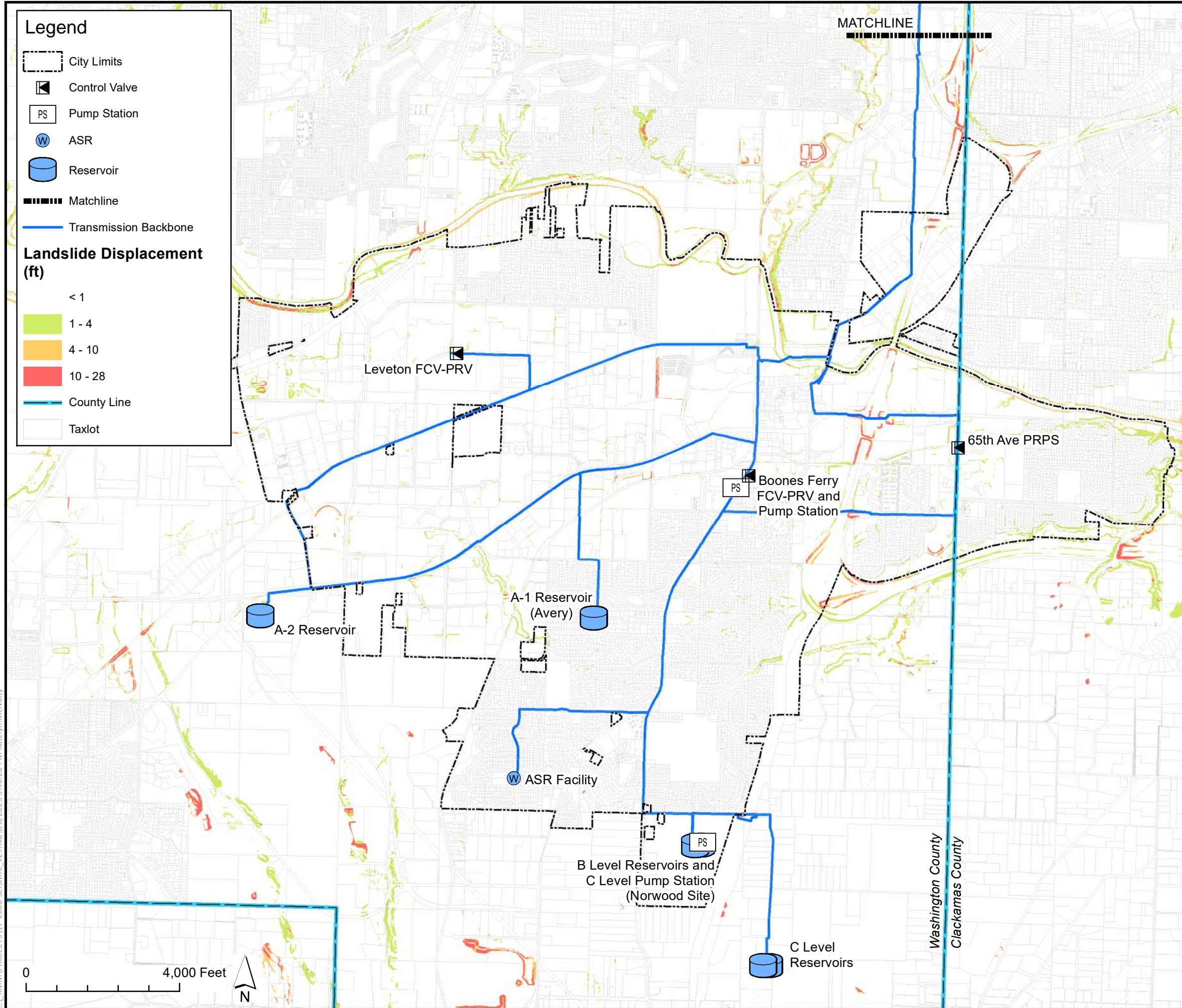

C:\KMM\PROJECTS\17-2000-SEISMIC_v2.mxd 3/16/2023 3:46:26 PM Katelyn.McNulty



**Water Master Plan
Seismic Resilience Evaluation**

Landslide Displacement

FIGURE 7-5

March 2023
17-2000

Legend

- City Limits
- Control Valve
- Pump Station
- ASR
- Reservoir
- Matchline
- Transmission Backbone

Peak Ground Velocity (in/sec)

- < 10
- 10 - 15
- > 15

- County Line
- Taxlot

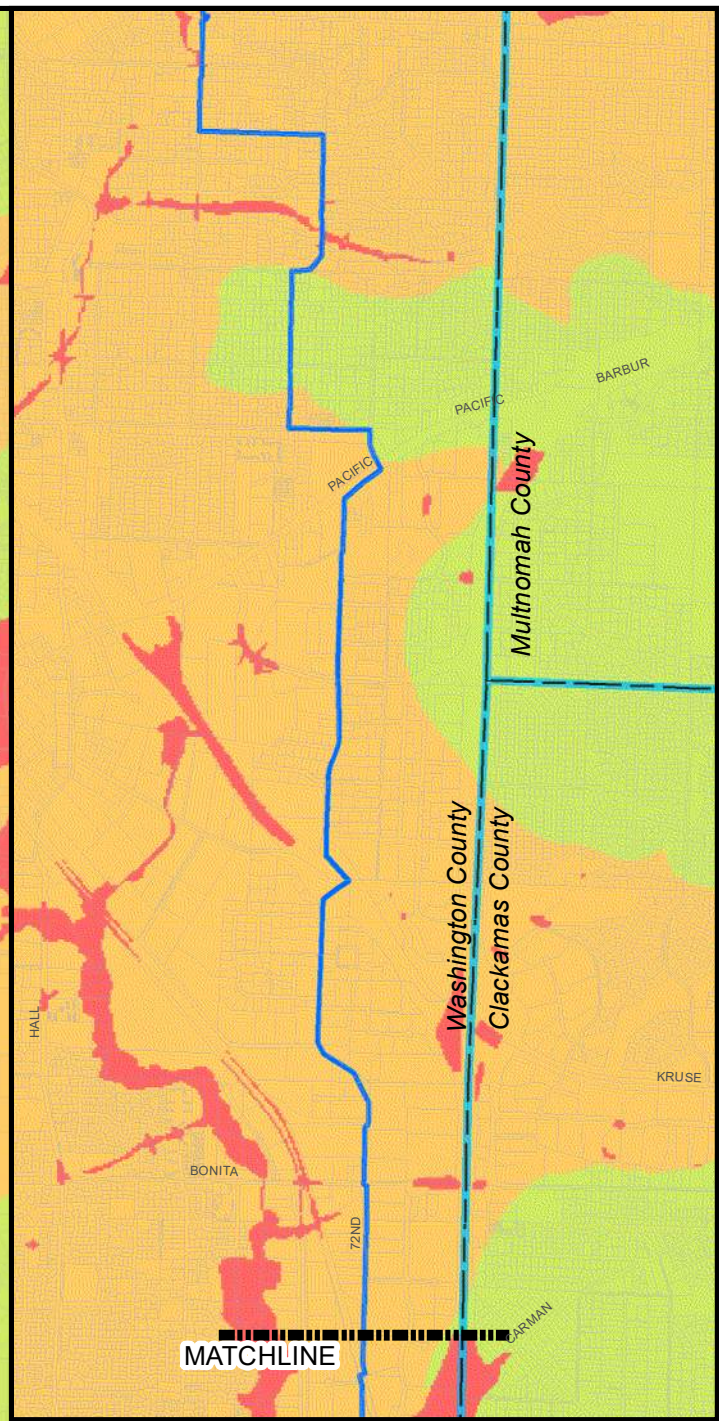
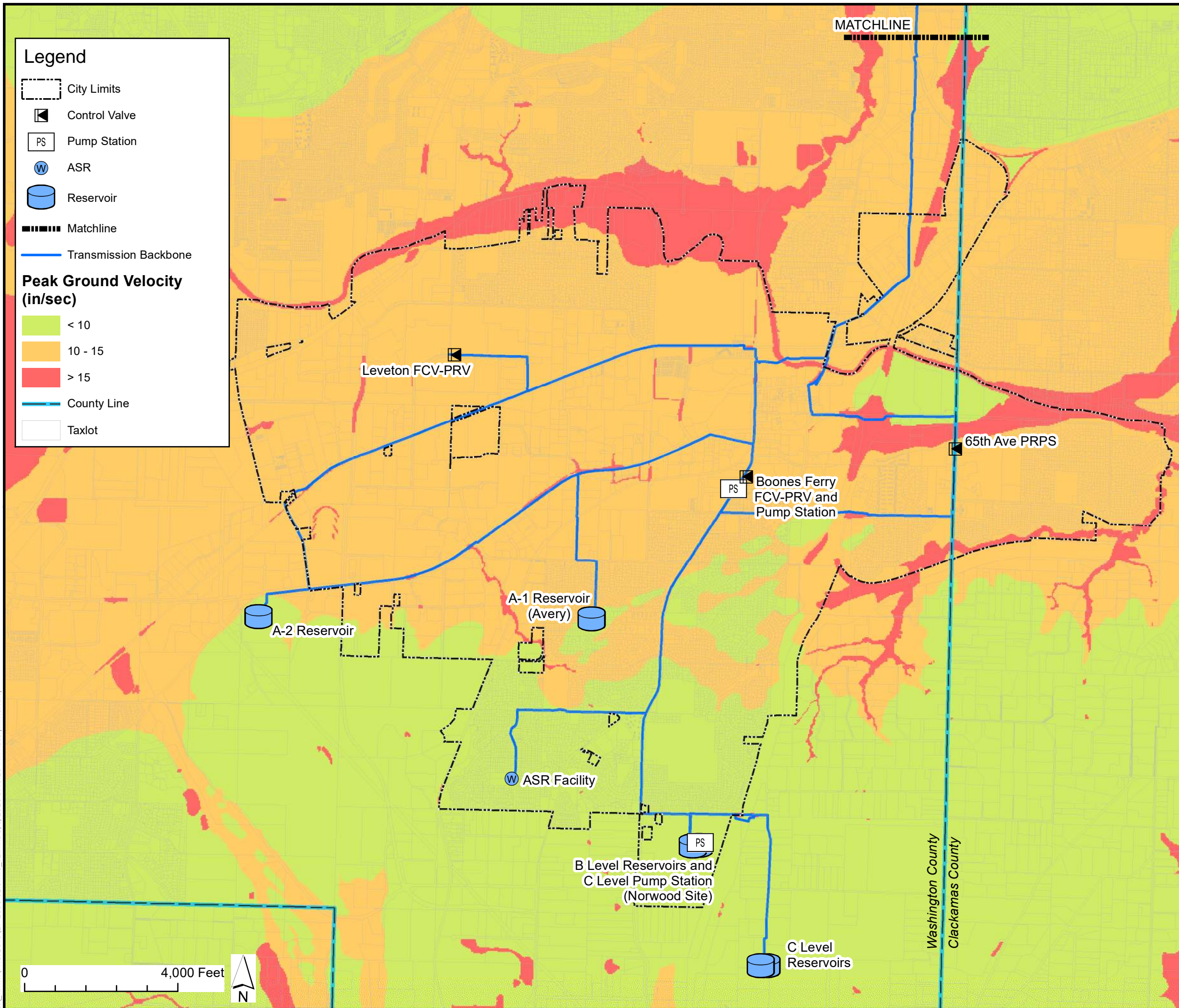

C:\KMM\PROJECTS\17-2000-SEISMIC_v2.mxd 3/16/2023 3:46:26 PM Katelyn.McNulty

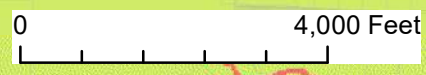

FIGURE 7-6

**Water Master Plan
Seismic Resilience Evaluation**

Peak Ground Velocity

March 2023
17-2000

7.4 Water Facility Seismic Vulnerability

7.4.1 Impact of Site Conditions

In addition to the seismic hazard study for the overall service area; reservoir, pump station, and valve site visits were also conducted to assess potential impacts from subsurface conditions and facility orientation at each site. Assessed facilities include the A-1, A-2, and B Level Reservoirs, the C Level Pump Station, and the Boones Ferry, City Park, and 108th Operations Supply Control Valves. The ASR site was not included in the site visits because it was constructed since more recent seismic regulations have been in place. These facilities correspond approximately to the Tier 1 facilities described in **Table 7-1**.

7.4.1.1 Site Condition Findings Summary

- There is a general lack of geotechnical data and subsurface information at all of the visited sites.
- The C Level Reservoir site seismic hazards have been evaluated and facilities were designed or have been seismically upgraded in recent years.
- Liquefaction settlement and lateral spreading at the A-2 Reservoir is anticipated to be negligible. However, a thorough review of the existing data is recommended to confirm the mapped subsurface conditions.
- Liquefaction settlement and lateral spreading at the A-1 Reservoir and the Norwood site (B Level Reservoirs and C Level Pump Station) is anticipated to be low. Due to the anticipated low level of liquefaction hazard, site-specific studies do not need to be prioritized.
- There are some liquefaction settlement and lateral spreading hazards at Boones Ferry Pump Station and Supply Control Valve, City Park Supply Control Valve, and 108th Operations Supply Control Valve sites. A subsurface investigation and site-specific stability evaluation is recommended for each of these site.

7.4.2 Impact of Structure Design, Age, and Condition

As part of this seismic risk assessment, a high-level building evaluation was conducted by Petersen Structural Engineers (PSE) at 10 of the City's water facilities, as summarized in the following paragraphs. More detailed information is available in their visual observations report included as **Appendix G** to the WSMP.

Observations of facility construction, age and condition were made based on as-built drawings provided by the City and site visits conducted April 25, 2018. Opinions of seismic performance are based solely on building age, condition, and type. No load-based analysis was conducted for this evaluation. The observed water facilities include:

- ASR Pump Station
- Boones Ferry FCV/PRV Control Station
- Martinazzi Pump Station
- C Level (Norwood) Pump Station
- 2.2 MG A-1 Reservoir – Welded Steel
- 5.0 MG A-2 Reservoir – Welded Steel
- 2.2 MG B-1 Reservoir – Welded Steel
- 2.8 MG B-2 Reservoir – Welded Steel
- 0.8 MG C-1 Reservoir – Welded Steel
- 1.0 MG C-2 Reservoir – Welded Steel

7.4.2.1 Structure Condition Rating

Each facility was given a condition rating which is indicative of the overall structural condition with some adjustment for age. This rating is not a descriptor of design quality. Specific deficiencies or areas of concern are noted for each facility. Water facility structure condition ratings are defined in **Table 7-2**.

Table 7-2 | Structure Condition Rating Definitions

Rating	Description
9-10	Very good
7-8	Good, shows slight signs of wear
6-6	Shows expected level of aging
3-4	Shows wear and will need rehabilitation or replacement
1-2	Should be replaced or rehabilitated as soon as possible

7.4.2.2 Structure Seismic Performance Expectation

Each facility was assigned a seismic performance expectation based on a visual inspection of the structure and review of the original construction drawings. Construction drawing review referenced “benchmark buildings” from the ASCE 41 Seismic Evaluation of Existing Buildings. The benchmark building gives a baseline code edition for many types of buildings. If the building is designed to the benchmark code (or a later iteration of that code) the building is likely to have been detailed sufficiently to prevent a catastrophic failure or life-safety risk in a seismic event. Water facility seismic performance expectation ratings are defined in **Table 7-3**.

Table 7-3 | Structure Seismic Performance Expectation Rating Definitions

Rating	General Performance/Damage	Re-Occupancy	Maintained Serviceability	Repairs or Replacement
Good	Structure likely to perform well with minor damage	Likely	Likely	Some repairs
Moderate	Structure likely to retain primary shape without collapse, moderate to heavy damage	Possible	Possible	Extensive repairs or replacement expected
Poor	Partial or comprehensive structure collapse likely with extensive damage	Unlikely	Unlikely	Extensive repairs or replacement probable

7.4.2.3 Structure Condition Findings Summary

Most facilities observed are in generally good condition. However, significant updates to code provisions for seismic design and detailing criteria have occurred (the Oregon Structural Specialty Code is revised and updated every 3 years in coordination with the International Building Code) since most structures were designed, which may lead to additional upgrades depending on the level of risk the City is willing to accept.

Storage racks, piping, HVAC, tanks, pumps and control panels in all pump stations and ASR well buildings generally have inadequate bracing for seismic resistance. It is recommended that these be evaluated and upgraded with code compliant seismic bracing. Much of this bracing can be upgraded by City staff, as procurement and installation are not complex and generally inexpensive. Specific ratings and notes for each water facility structure are summarized in **Table 7-4**.

Table 7-4 | Structure Seismic Performance Investigation

Water Facility	Condition Rating	Seismic Performance Expectation	Notes
ASR Pump Station	9	Good	<ul style="list-style-type: none"> Recent 2010 construction with seismic considerations. Seismic bracing upgrades have been completed.
Boones Ferry FCV/PRV Station	3	Poor	<ul style="list-style-type: none"> Poor overall condition, no seismic upgrades. Unlikely to be operational post seismic event due to failure of rigid pipe to vault connections and potential structural vault failure.
Martinazzi Pump Station	4	Poor	<ul style="list-style-type: none"> Poor overall condition, no seismic upgrades. Unlikely to be operational post seismic event.
C Level Pump Station	8	Good	<ul style="list-style-type: none"> Recent 2010 construction with seismic considerations. Seismic bracing upgrades recommended.
2.2 MG A-1 Reservoir	6	Moderate	<ul style="list-style-type: none"> 2006 seismic retrofit, buckled plates, areas of questionable welds, structural analysis recommended. Damage expected in seismic event. Existing overflow discharge could cause foundation damage.
5.0 MG A-2 Reservoir	8	Good	<ul style="list-style-type: none"> Recent 2006 construction, well anchored, 5' freeboard.
2.2 MG B-1 Reservoir	5	Poor	<ul style="list-style-type: none"> 2006 seismic retrofit, buckled plates, areas of questionable welds, structural analysis recommended. Damage expected in seismic event. Existing overflow discharge could cause foundation damage.
2.8 MG B-2 Reservoir	7	Moderate	<ul style="list-style-type: none"> 2006 seismic retrofit. Limited freeboard (2'), recommend increasing to reduce potential for roof damage.
0.8 MG C-1 Reservoir	4	Moderate - Good	<ul style="list-style-type: none"> 2006 seismic retrofit included roof replacement. Limited freeboard (12"), recommend increasing to reduce potential for roof damage. Addressed by setpoints that maintain 4-feet of freeboard.
1.0 MG C-2 Reservoir	10	Good	<ul style="list-style-type: none"> Recent 2016 construction with seismic considerations, 4' freeboard.

7.4.3 ASR Facilities

The City’s existing ASR well system has the potential to be a significant asset after a seismic event if the facilities remain operational and other water sources are compromised. According to a study of well survivability in previous seismic events (Ballantyne, AWWA 2010), water wells have historically insignificant vulnerability to seismic impacts. The greatest risks to wells from a seismic event are large earth deformations and liquefaction of soil surrounding the well casing and screen.

7.5 Pipe Fragility Analysis

Pipeline fragility describes the likelihood of pipeline damage by estimating the necessary rate of repair (RR) per 1,000 feet of main following an earthquake. The estimated RR is based on the pipe

material, installation, and surrounding ground conditions. While the actual location of pipeline damage cannot be predicted, pipeline fragility analysis provides a measure of the expected severity of damage to the water system backbone overall and may identify areas of higher relative risk where mitigation efforts should be focused first.

7.5.1 Analysis Method

This analysis focused on estimating RR for the water system backbone mains illustrated on **Figure 7-2** which were identified for this analysis with City water utility and emergency management staff input. Backbone mains are divided into higher-priority Tier 1 mains and lower-priority Tier 2 mains.

Backbone pipeline fragility was evaluated using data provided by the City, seismic geohazards described earlier in this section, and the Seismic Fragility Formulations for Water Systems guideline developed by the American Lifelines Alliance (ALA). The ALA is a partnership between FEMA and ASCE.

The ALA guideline damage algorithms used to calculate RR per 1,000 LF of pipe are based on empirical evidence catalogued after major earthquakes such as the 1989 Loma Prieta Earthquake in the San Francisco bay area and the 1995 Great Hanshin earthquake in Hyogoken-Nanbu (Kobe), Japan. The guideline recommends using two pipe vulnerability functions, each of which address a different seismic hazard:

1. $RR = K1 * 0.00187 * PGV$

This function estimates a RR per 1,000 LF of pipe due to seismic wave propagation or ground shaking. The magnitude of ground shaking is represented by PGV, described earlier in this section.

2. $RR = K2 * 1.06 * PGD^{0.391}$

This function estimates a RR per 1,000 LF of pipe due to PGD, which can be the result of landslide or lateral spreading due to soil liquefaction, described earlier in this section.

In the pipe vulnerability equations above, K1 and K2 are empirical fragility constants which are used to scale the repair rates for different pipe diameters, pipe materials, and joint types. K1 generally represents the strength and flexibility of the pipe material to withstand ground shaking. K2 generally represents the strength and flexibility of the pipe joint to resist separation during ground deformation. A larger K value correlates with higher material or joint vulnerability.

7.5.2 Pipe Installation and Materials (K Value Selection)

The ALA seismic fragility guideline provides a range of K values which scale estimated RR for different pipe materials and joint types. K values are estimated based on empirical damage evidence from previous earthquakes. Thus, the influence of some variables, such as pipe diameter, are inconclusive based on the currently available historical water main damage data. Selected K

values for the City’s water system backbone are summarized in **Table 7-5** based on the ALA guideline and the City’s current water system asset management data and mapping.

K1 generally represents the pipe material. RR for some material types are also influenced by pipe diameter and soil corrosivity. Large diameter, defined as 16-inch diameter and greater, welded steel or concrete cylinder mains show lower damage rates in previous seismic events than smaller diameter mains of the same material. This may be attributed to higher quality control during construction, fewer bends and lateral connections than smaller mains or lower soil loads as a function of pipe strength for the same depth of cover. The City’s water system mapping data includes water main diameter for all pipes and pipe material for most pipes.

Soil corrosivity also influences K1 values for cast iron and steel pipes. If these pipes are installed in corrosive soils, anticipated damage rates would be higher. Based on soil survey data from the NRCS, soil corrosivity is believed to be high throughout the City’s water service area. City staff informed the project team that this is not consistent with observations of soil conditions and pipe performance in the field. The K1 value was adjusted to reflect a moderate level of soil corrosivity, in alignment with the City’s observations.

K2 generally represents the pipe joint and is selected based on joint type and pipe material. Joint type information was not available for City water system mains. Joint type is assumed based on pipe material and common construction methods at the time of pipe installation. The City’s water system mapping data includes installation date for most pipes.

Table 7-5 | Pipe Fragility K Values¹

Pipe Material	Installation Date	Assumed Joint Type	Diameter	K1	K2
Cast Iron	<1970	Cement	All	1.4	1.0
Cast Iron	>=1970	Rubber Gasket	All	0.8	0.8
Ductile Iron	All	Rubber Gasket	Small ²	0.5	0.5
Ductile Iron	All	Rubber Gasket	12-24"	0.8	0.7
Ductile Iron	All	Rubber Gasket	>24"	1.0	1.0
Concrete w/Steel Cylinder	CCP >=1970; Ameron All	Rubber Gasket or Carnegie-style push-on	Large ³	0.8	0.7
Polyvinyl Chloride	All	Rubber Gasket	Small	0.5	0.8
High Density Polyethylene	All	Welded or fused	Large	0.15	0.15
Asbestos Cement	All	Cement	All	1.0	1.0
Unknown	All	Unknown	All	1.0	1.0

Notes:

1. Higher K values reflect pipe that has a greater risk of breaks and/or joint failure during a seismic event
2. Small = 4- to 12-inch diameter
3. Large = 16-inch diameter and greater

7.5.3 Pipe Fragility Seismic Hazard Values

Pipe fragility RR per 1,000 LF of pipe are calculated for the following seismic hazards.

- strong ground shaking, expressed as PGV
- settlement due to liquefaction, expressed as PGD_{LIQ}
- liquefaction induced lateral spreading, expressed as PGD_{LAT}

Relative potential hazard levels for each of these three hazards are shown as negligible, low, medium, and high in **Figure 7-3**, **Figure 7-4**, and **Figure 7-6**. As illustrated on **Figure 7-5**, ground movement due to landslide is unlikely throughout the water service area except for very localized areas. Thus, pipe fragility due to landslide is not calculated for the City's water system backbone overall. Specific values for PGV and PGD used in the pipe fragility RR calculations are summarized in **Table 7-6**.

Table 7-6 | Pipe Fragility Seismic Hazard Values

Seismic Hazard	Variable (units)	Negligible		Low		Medium		High	
		Range	Pipe Fragility Value	Range	Pipe Fragility Value	Range	Pipe Fragility Value	Range	Pipe Fragility Value
Ground Shaking ¹	PGV (inches/second)		0	< 10		10 to 15		> 15	
Liquefaction Settlement	PGD _{LIQ} (inches)	< 1	1	1 to 4	2.5	5 to 8	6.5	> 9	9
Lateral Spreading	PGD _{LAT} (inches)	0	0	0 to 3	1.5	3 to 6	4.5	> 6	6

7.5.4 Pipe Fragility Findings

Buried pipeline damage caused by ground failure (liquefaction and lateral spreading) will be significantly more severe than damage caused by ground shaking. Empirical data used to develop the ALA's pipe fragility analysis method reveals repair rates two orders of magnitude higher for damage caused by ground failure. FEMA's Hazus methodology, a nationally recognized risk model used to assess potential earthquake damage to buried pipelines, also supports this conclusion. For pipeline repairs caused by ground failure, Hazus assigns 80 percent of the repairs as "breaks" and 20 percent as "leaks". For ground shaking, 20 percent are considered breaks and 80 percent leaks.

In the City's water service area, liquefaction and lateral spreading during a seismic event present the largest risk to transmission and distribution mains. **Table 7-7** summarizes the total estimated water system backbone repairs by pressure zone due to both ground shaking and ground failure. Total repairs are split into potential breaks and leaks based on the 80 percent to 20 percent ratios described in the previous paragraph. **Figure 7-7** illustrates estimated RR for ground shaking, **Figure**

7-8 illustrates estimated RR for lateral spreading and **Figure 7-9** illustrates the estimated RR for liquefaction settlement.

Tier 1 backbone mains are the most critical for restoring water service and connecting pressure zones. It is recommended that damage mitigation planning focus on these mains first. There is predicted to be limited damage south of Ibach Street, primarily due to the relatively shallow bedrock which results in low rates of expected lateral spreading and settlement. Tier 1 mains along Boones Ferry Road, Tualatin Sherwood Highway, and Sagert Street are expected to experience medium RR due to settlement. Tier 2 mains along Herman Road to the Leveton PRV are also expected to experience medium rates of repair due to settlement. Overall, lateral spreading is expected to affect the City pipe less than settlement but could result in medium RR near the Park PRV, in the vicinity of the I-5 crossing to the C Level Reservoirs, a portion of SW Tualatin-Sherwood Road, Sagert Road, and along the Tualatin River.

Pipe material plays a key role in predicting failures. Most of the City’s distribution piping is small diameter ductile iron. Generally, this material is expected to withstand better in an earthquake than some other materials. One area of concern for the City is the Tier 1 transmission along Tualatin-Sherwood Road between Boones Ferry and Teton. This line connects the A-1 Reservoir to the distribution system. The line was built in 1969 and is 12-inch diameter cast iron, which is generally expected to perform relatively poorly in a seismic event. Additionally, distribution system looping is more limited in this industrial area of the City, which means the City is more reliant on this pipeline.

The TSM is the City’s sole source of PWB supply to the distribution system. It is a concrete cylinder pipe that is nearly 50-years old. Because of the importance of this single line, the City should complete a more in-depth evaluation to assess risk and potential mitigation strategies along the pipeline.

Table 7-7 | Estimated Backbone Pipe Repairs by Pressure Zone

Pressure Zone	Length (mi)		Ground Shaking		Ground Failure		TOTAL
	Tier 1	Tier 2	Tier 1	Tier 2	Tier 1	Tier 2	
A Level	2.0	5.4	< 1	< 1	19	42	61
B Level	4.6		< 1	< 1	24	< 1	24
C Level		1.4	< 1	< 1	< 1	4	4
Tualatin Transmission ¹	0.4	7.7	< 1	< 1	2	81	84
Total Estimated Backbone Repairs	7.0	14.5	< 1	1	45	127	173
Estimated Leaks			< 1	< 1	36	102	139
Estimated Breaks			< 1	< 1	9	25	34

Note:

Transmission includes piping from the Florence Lane Master Meter to the Boones Ferry FCV/PRV and A Level and Bridgeport Level PRVs.

For context, this analysis indicates that approximately two percent of the backbone piping in the system (not including the TSM, which extends north outside of the City’s water service area) is

likely to require repair of breaks or leaks following a seismic event. If the same RR is applied to the remaining distribution system, over 100 miles of pipe, the City should expect that there may be an excess of 600 required repairs following a seismic event.

While there is a need to focus on increasing the resilience of the City's piping network, beginning with the backbone and eventually extending to the entire distribution system, the City lacks the financial resources to achieve a more resilient water distribution system in the near-term and it will be a challenge to achieve this goal even over a long period of time (50 years). As such, the next part of this section presents short-term investments and strategies to ensure that emergency water supply is available to the community following a seismic event.

7.6 Emergency Plan - Valve Isolation Study

In planning for recovery after a major earthquake, the City needs specific policies and Standard Operating Procedures (SOPs) in place to efficiently and safely bring facilities back online. This study specifically looked at bringing the transmission line between the Boones Ferry FCV/PRV and the Norwood Site (B Level Reservoirs) back online. However, the pressure testing procedures described herein are applicable to bringing any pipe infrastructure back online after an earthquake. This strategy is integrated into the *Emergency Water Plan* presented in **Section 9**.

C:\KMM\PROJECTS\17-2000-SEISMIC_v2.mxd 3/16/2023 3:46:26 PM Katelyn.McNulty

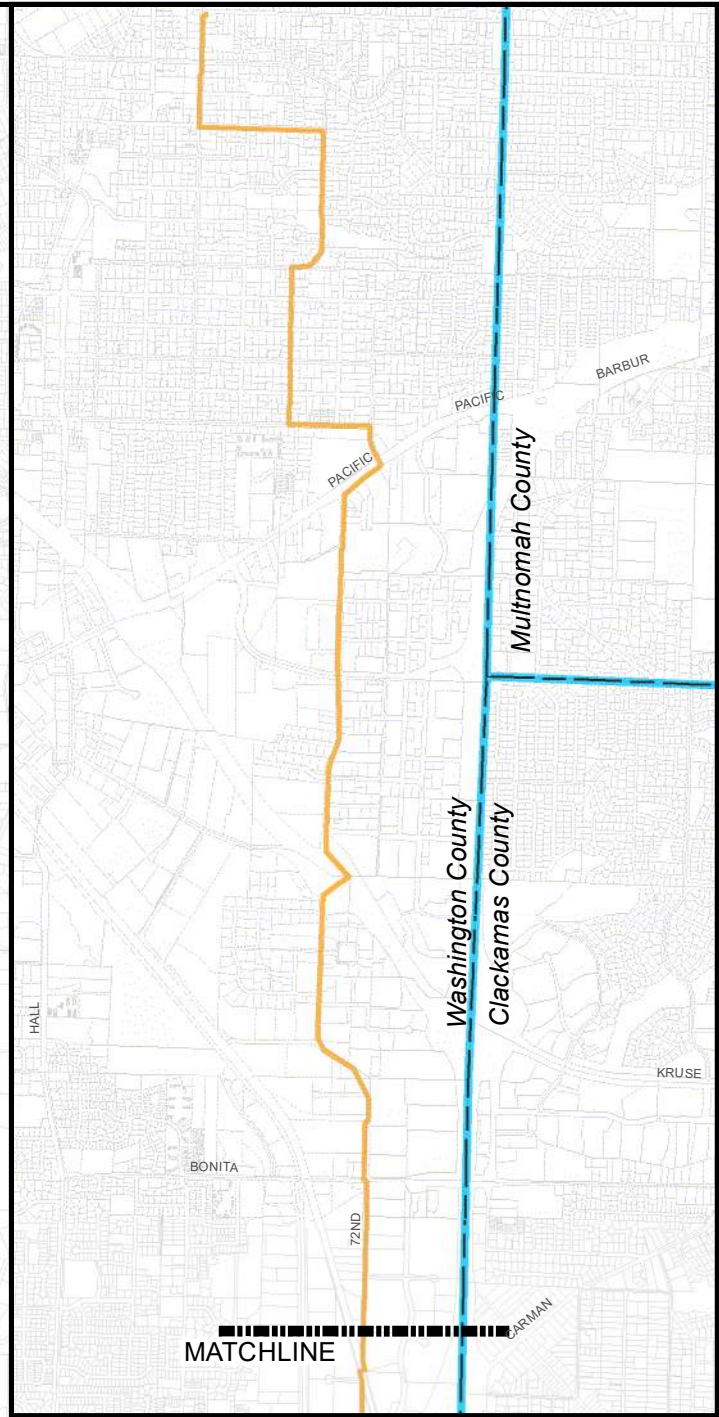
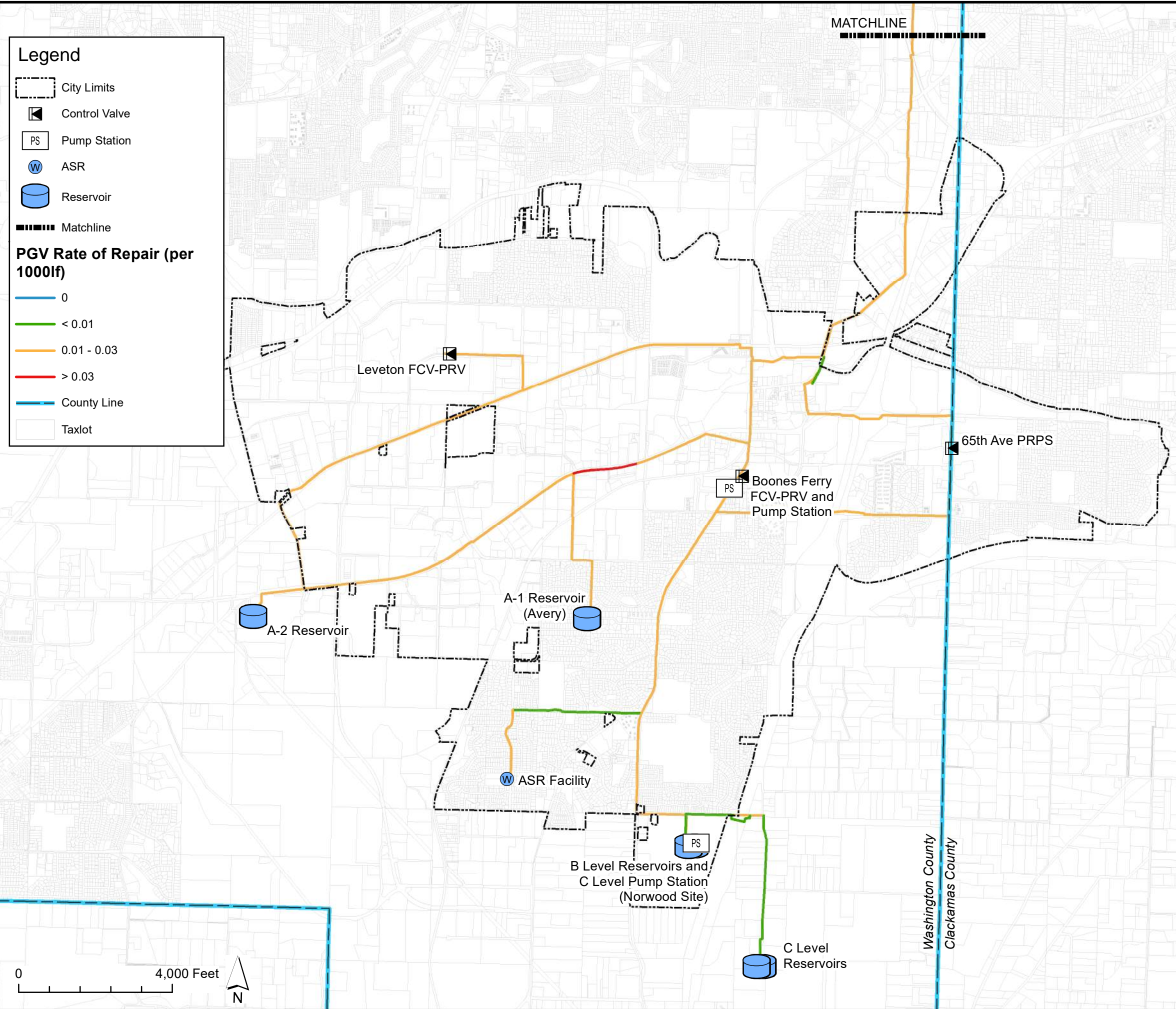



FIGURE 7-7



**Water Master Plan
Seismic Resilience Evaluation**

Estimated Repair Rates for Ground
Failure - Peak Ground Velocity



March 2023
17-2000

Legend

- City Limits
- Control Valve
- Pump Station
- ASR
- Reservoir
- Matchline

Lateral Spreading Rate of Repair (per 1000lf)

- 0
- < 1
- 1 - 3
- > 3
- County Line
- Taxlot

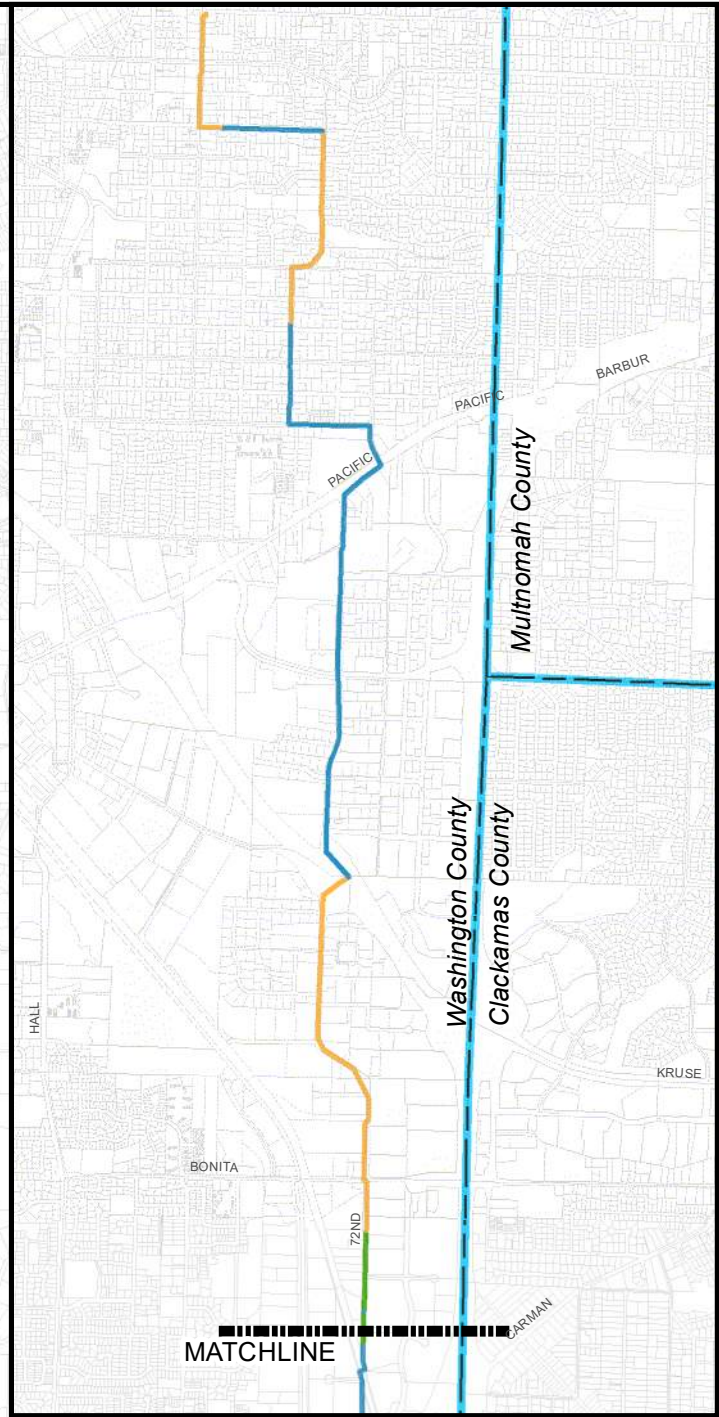
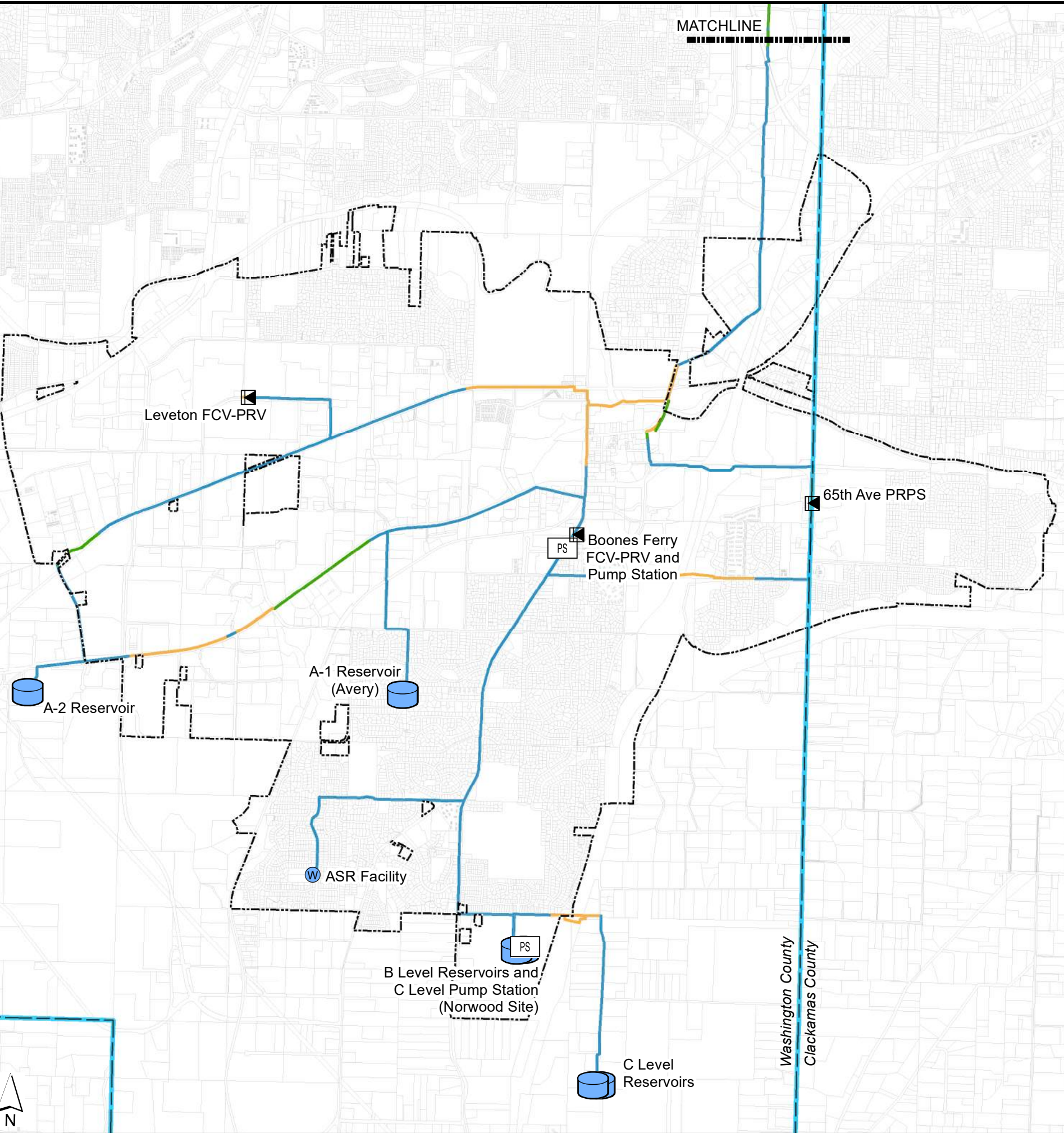

C:\KMM\PROJECTS\17-2000-SEISMIC_v2.mxd 3/16/2023 3:46:26 PM Katelyn.McNulty

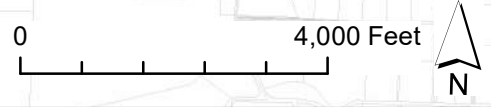

FIGURE 7-8

**Water Master Plan
Seismic Resilience Evaluation**

Estimated Repair Rates for Ground Failure - Lateral Spreading

March 2023
17-2000

C:\KMM\PROJECTS\17-2000-SEISMIC_v2.mxd 3/16/2023 3:46:26 PM Katelyn.McNulty

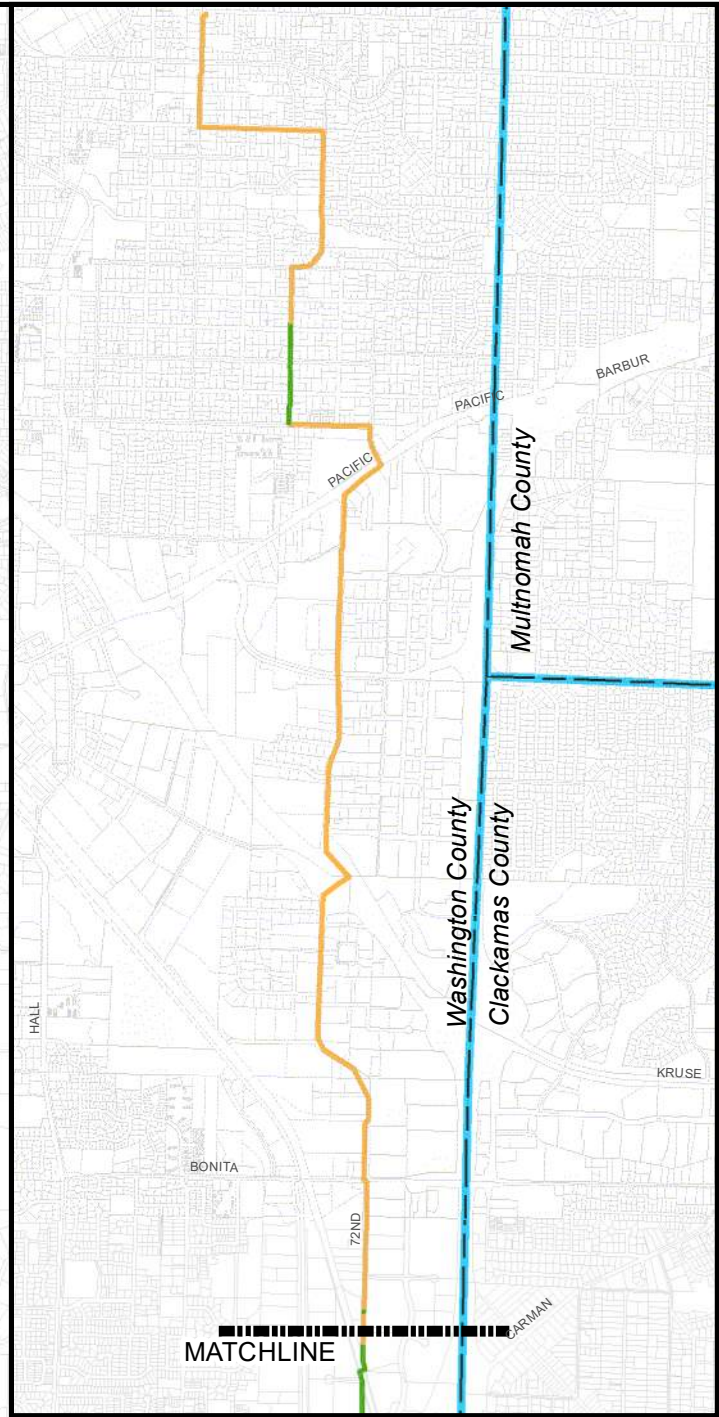
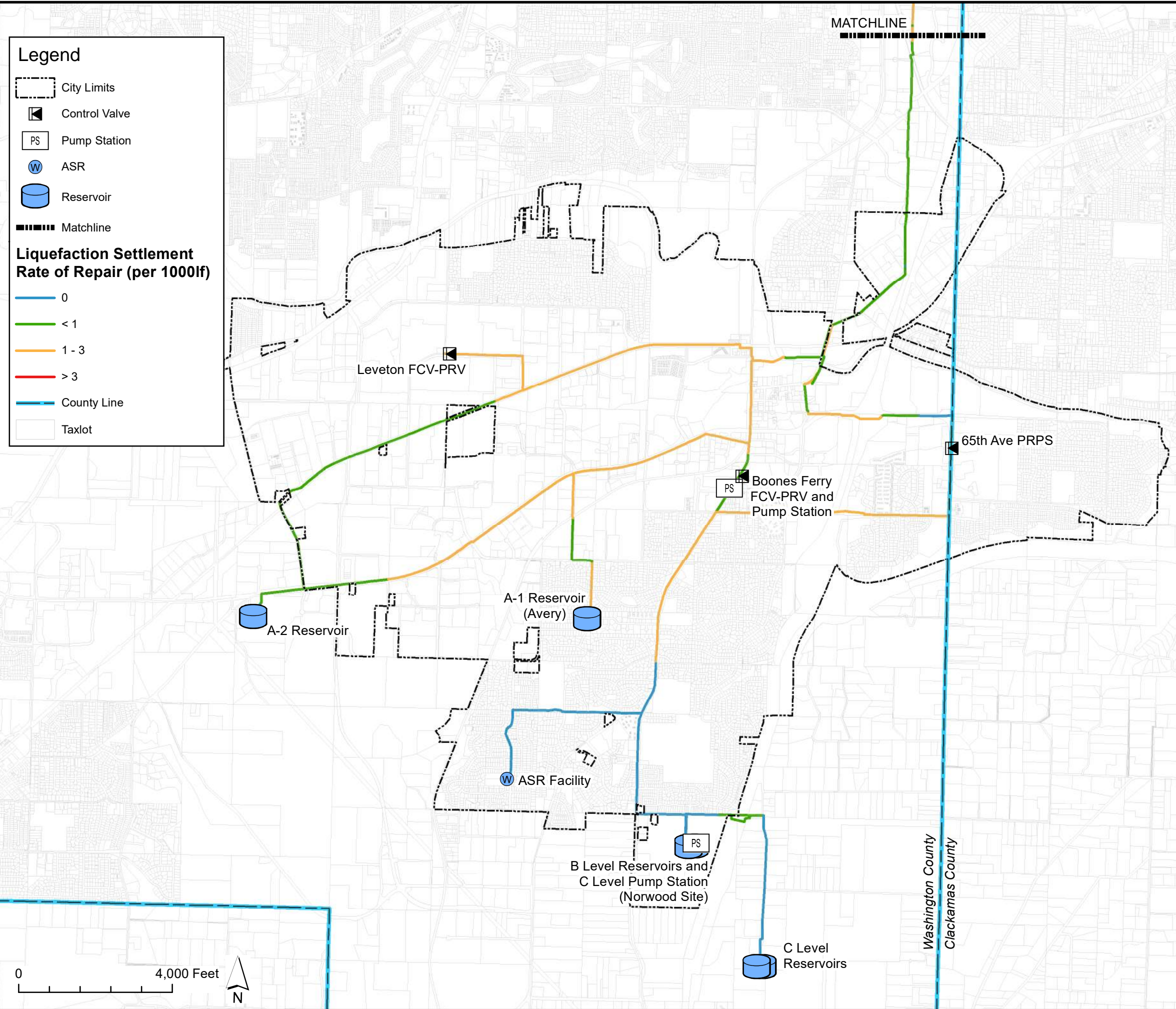

FIGURE 7-9

**Water Master Plan
Seismic Resilience Evaluation**

Estimated Repair Rates for Ground Failure - Liquefaction Settlement

March 2023
17-2000

7.6.1 System Operations – During the Seismic Event

In the event of a significant earthquake, proposed seismically actuated valves at the reservoirs (see **Section 7.9**) will activate, isolating the tanks from the system. Distribution and transmission pipes will likely rupture in several locations throughout the system. Water in the distribution system will be lost through the leaks but, if the reservoirs are intact and the seismic valves operate properly, water will remain in the reservoirs. Services and hydrants will no longer receive water.

*It is recommended that the City plan for the installation of seismically actuated valves at reservoirs in each pressure zone in order to preserve stored water following a seismic event. Specific recommendations are discussed later in this section and included in the CIP presented in **Section 8**.*

7.6.2 System Operations – Post Seismic Event, Backbone Reinstatement

After a seismic event, the highest priority will be reinstating the Tier 1 and 2 Backbone mains, in addition to the key facilities listed in **Table 7-4**. After obvious failures have been fixed, the remaining pipe will need to be incrementally pressure tested, and the identified leaks repaired.

A map was developed to identify the pressure test sequencing for the transmission main between the Norwood Site and the Boones Ferry FCV/PRV (see **Figure 7-10**). Starting at the B Level Reservoirs and drawing water from them, valves can be closed to isolate pipe segments that are progressively further from the Reservoirs. Adjacent hydrants can be used for pressure measurements.

The segments south of Ibach Street do not have hydrants off the transmission main, as the pressure in that segment does not adequately serve the surrounding area. This limits the necessity of valve closures for branching distribution piping, but also limits the hydrant availability for pressure measurements. As this transmission line is upgraded, blowoff valves or sample connection ports should be added every 1,000 feet along the transmission line for this purpose, as discussed further in **Section 7.7.1.1**.

In order to facilitate pressure testing, the City should acquire a small pump and associated appurtenances for performing pressure testing. It may be difficult to rent or acquire this equipment following a seismic event and purchasing it now allows the City to configure the apparatus and connection points for efficient setup.

7.6.3 System Operations – Post Seismic Event, Distribution Reinstatement

Reinstating distribution lines after a seismic event will likely be a similar process to reinstatement of transmission lines. However, as there are service laterals off distribution lines, leaks may be more prevalent, or more difficult to test. Pressure testing working incrementally from water supply out to distribution can help identify major system leaks. Additional leak detection measures such as acoustic devices will also likely be used. The ORP guidelines suggest full operation within one

month but depending on the severity of the earthquake and the resiliency of the distribution system, reinstatement may take longer.

7.6.4 Next Steps

As the City replaces system pipes, additional consideration should be given for seismic resiliency. In the next section, possible design standards are listed.

7.7 Design Standards for Seismic Resilience

Oregon Structural Specialty and Mechanical Specialty Codes will dictate that all new water facility construction meet current earthquake standards which are based on an M9 event. Suggestions for City design and construction standards include recommendations for the following types of facilities.

- Pipelines
- Reservoirs
- Pump Stations
- ASR

7.7.1 Pipelines

Based on the seismic vulnerability of the City's water system, restrained joint ductile iron pipe provides the best balance of cost, performance, and life cycle. Fully restrained ductile iron pipe reduces the risk of separation at standard push-on joints and allows limited deflection as a result of ground shaking and ground deformation. Furthermore, ductile iron is a piping material that City crews are familiar with and stock adequate supplies to respond to leaks and main breaks.

For pipes larger than 24-inch diameter, the City should consider the most appropriate pipe material for the specific conditions. The selection of piping material, lining, and coating system, and other design parameters should be made on a case-by-case basis with adequate consideration of specific alignment seismic hazards, hydraulics, performance and life-cycle expectations, soil considerations, etc.

7.7.1.1 Pipeline Pressure Testing

To allow for pressure testing of pipes after a seismic event, blow off valves, or other locations that will allow the City to isolate and pressure test key pipe segments should be installed, as replacement allows. This is especially key in areas without fire hydrants on the transmission main, such as the B Level transmission south of Ibach Street, through the C Level, to the B Level Reservoirs. Pressure test sites for new, or upgraded, backbone piping should be located every 1,000 feet, with the proper valving to allow for pipe isolation.

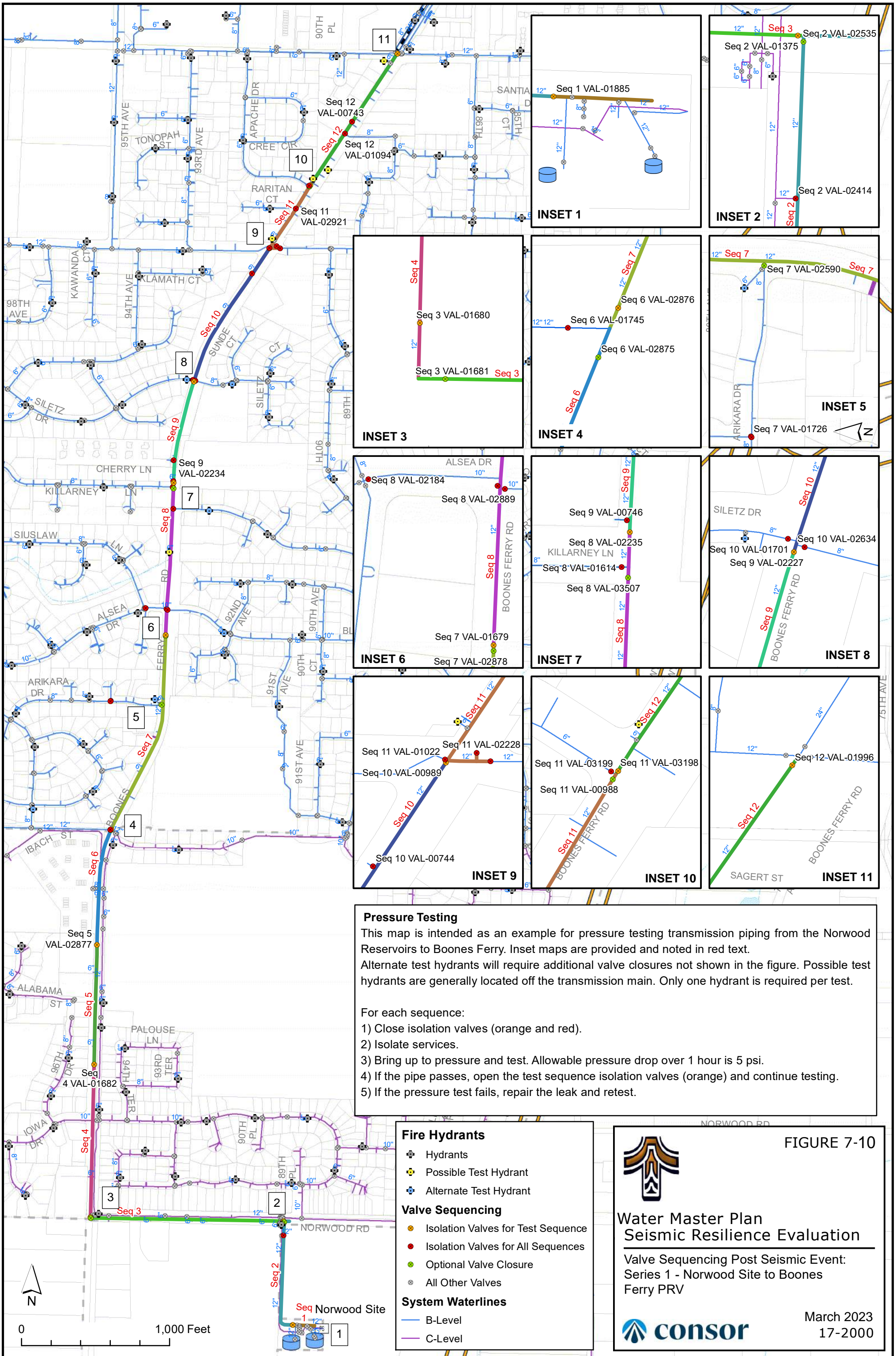

Pressure Testing
 This map is intended as an example for pressure testing transmission piping from the Norwood Reservoirs to Boones Ferry. Inset maps are provided and noted in red text. Alternate test hydrants will require additional valve closures not shown in the figure. Possible test hydrants are generally located off the transmission main. Only one hydrant is required per test.

For each sequence:
 1) Close isolation valves (orange and red).
 2) Isolate services.
 3) Bring up to pressure and test. Allowable pressure drop over 1 hour is 5 psi.
 4) If the pipe passes, open the test sequence isolation valves (orange) and continue testing.
 5) If the pressure test fails, repair the leak and retest.

- Fire Hydrants**
- Hydrants
 - Possible Test Hydrant
 - Alternate Test Hydrant
- Valve Sequencing**
- Isolation Valves for Test Sequence
 - Isolation Valves for All Sequences
 - Optional Valve Closure
 - All Other Valves
- System Waterlines**
- B-Level
 - C-Level

FIGURE 7-10



**Water Master Plan
 Seismic Resilience Evaluation**

Valve Sequencing Post Seismic Event:
 Series 1 - Norwood Site to Boones
 Ferry PRV



March 2023
 17-2000

7.7.2 Reservoirs

It is assumed that future reservoir structures will be designed to meet earthquake standards consistent with current Structural and Mechanical Specialty codes, and these codes should be considered when the City is evaluating the condition, performance and rehabilitation needs of existing reservoirs. There are two key design considerations associated with reservoir configuration and connections to the distribution system.

- Pipe to reservoir connections
- Automated isolation valves at reservoir inlet and outlet piping connections

7.7.2.1 Pipe to Reservoir Connections

At each distribution or transmission piping connection to the reservoir, significant stress can be placed on the pipe as a result of the difference in response to ground motion and deformation by the pipe and reservoir foundation. To minimize the risk of pipe breakage at this location, it is recommended that a flexible expansion joint be installed at this interface. Flexible expansion joints must be capable of allowing axial expansion/contraction and differential movement that results in a vertical or horizontal offset. It is recommended that the City review as-built drawings to determine if adequate flexible connection exist currently, and if not, the City should plan to add flexible expansion joints at each reservoir in coordination with seismic actuated valves described below.

7.7.2.2 Automated Isolation Valves

Automated isolation valving with seismic valve actuators should be considered at all reservoir piping connections. There are several considerations to be weighed in determining whether to use an automatic shut-off valve at each reservoir as summarized in **Table 7-8**.

Table 7-8 | Automatic Shut-off Valve Considerations at Reservoirs

If a seismic valve actuator is used for automatic shut-off at reservoirs:	YES	NO
Water Available for Fire Suppression Immediately After Event?		✓
Reservoir Water Volume Preserved for Use During Recovery?	✓	
Requires Maintenance of Batteries for Valve Actuation?	✓	
Vulnerable to Accidental Closure due to False Alarm?	✓	

The City should consider the specific performance objectives of each reservoir associated with a seismic event and the anticipated response and recovery period to determine whether the installation of seismically actuated valves is warranted. For example, if two reservoirs serve a pressure zone, one may be equipped with seismic valves to preserve the water volume for future use during recovery while the other will remain connected to the system to provide adequate

pressure if limited, or no damage occurs in the system, with the risk that this volume may be lost through main breaks.

In order to maximize the volume of water retained in storage following a seismic event, it is recommended that the City install seismic isolation valves on all reservoirs. Recent advances in the technology makes these valves far less prone to false alarms and maintenance issues, and there is the potential to operate these valves with a signal from seismic warning systems that are in ongoing development and expansion across the Northwest.

During preliminary design, the City should confirm the configuration of seismic isolation valves, including:

- Single or dual valves for isolation of sites with multiple reservoirs
- Source of standby power for valve operation (standby generator versus battery backup)

7.7.3 Pump Stations

Similar to reservoir structures, pipe connections at the pump station building present specific vulnerability as a result of differential movement and settlement. To minimize the risk of pipe breakage at this location, it is recommended that a flexible expansion joint be installed at this interface. Flexible expansion joints must be capable of allowing axial expansion/contraction and differential movement that results in a vertical or horizontal offset.

Standby power should also be provided, in the form of a standby generator, at all critical pump station facilities. The standby generator should be equipped with onsite fuel storage for at least 24 hours of operation. While a significantly greater volume of fuel will likely be required to sustain operation of the generator through the recovery period following a seismic event, storage of greater volumes of fuel present complications and are likely not economically feasible. The City's public works facility includes onsite fuel storage that will extend the City's ability to operate without sourcing additional fuel following an emergency.

7.7.4 ASR

Future upgrades and design considerations can further enhance seismic resiliency of the City's ASR well. These include:

- flexible couplings at the wellhead to withstand ground motion
- quick-connect couplers to deliver water to a truck or skid-mounted tank if the water distribution system has failed
- easy access over the wellhead to clean and repair the well after a major seismic event

The most significant improvement to increase the City's ability to beneficially use water from the ASR well following a seismic event is to construct a new B Level reservoir at the site to provide onsite storage for distribution of water.

7.8 Next Steps

This initial seismic evaluation demonstrates that there are significant risks to the City's water system during a seismic event. The City has made significant steps towards identifying and planning for these risks through the Emergency Water Supply Study. As discussed in the study, it is recommended that the City:

- Continue coordination with emergency managers to refine understanding of post-disaster water needs which will inform water facility performance goals and design choices.
- Pursue a more detailed analysis of vulnerable facilities to develop a 50-year seismic CIP consistent with the ORP.
- Consider seismic implications when replacing transmission or distribution piping.
- Include blow-off valves and other appurtenances to allow for systematic pressure testing of mains after a seismic event.

7.9 Summary of Recommendations

The highest priority recommendations presented in this section are summarized below. For those recommendations that include capital investment, see **Section 8** for the proposed capital improvement cost and timing relative to the conditional and capacity related improvements described elsewhere in this WSMP.

- Facility Seismic Improvements:
 - Upgrade the Boones Ferry FCV/PRV – Upgrades to this facility should include rehabilitation or replacement of the buried utility vault and piping transitions. This is a critical water supply facility for transmitting PWB supply to the B Level and C Level service zones.
 - A-1 Reservoir Structural Analysis – A structural analysis should be performed for this reservoir to better quantify seismic risk and determine if cost-effective mitigation strategies are available.
 - Reservoir Connections: Flexibility and Isolation – Install new flexible connections (where current flexible connections are not provided or are inadequate) and seismic isolation valves at all six of the City's existing reservoirs. New reservoirs should be designed and constructed with these features.

- Install a permanent standby generator at the Norwood Pump Station with adequate fuel storage for a minimum of 24-hours of operation.
- Backbone Piping:
 - Implement the Seismic Design Standards presented in this section.
 - TSM Study – Conduct a study to assess the condition and performance of the TSM, especially in the context of seismic resilience. The study should present mitigation strategies and costs for City consideration in the broader context of water supply reliability.
- Emergency Preparedness:
 - Implement the strategies, recommendations and improvements presented in **Section 9, Emergency Water Plan**.

Chapter 8



Section 8

Capital Improvement Program (CIP)

This section presents recommended improvements for the City’s water system based on the analysis and findings presented earlier in this WSMP and projects identified in the 2013 WSMP. These improvements include supply, storage reservoir, pump station, and water main projects. The CIP presented in **Table 8-3** later in this section summarizes recommended improvements and provides an approximate timeframe for each project. Proposed improvements are illustrated in **Figure 8-1**.

8.1 Project Cost Estimates

An estimated project cost has been developed for each recommended improvement consistent with previously identified projects from the City’s 2013 plan and current preliminary design work, as applicable. Cost estimates represent opinions of cost only, acknowledging that final costs of individual projects will vary depending on actual labor and material costs, market conditions for construction, regulatory factors, final project scope, project schedule and other factors. The AACE classifies cost estimates depending on project definition, end usage and other factors. The cost estimates presented here are considered Class 5 with an end use being a study or feasibility evaluation and an expected accuracy range of -50 percent to +100 percent. As the project is better defined, the accuracy level of the estimates can be narrowed.

8.2 Timeframes

A summary of all improvement projects and estimated project costs is presented in **Table 8-2** | . This CIP table provides for project sequencing by showing projects prioritized by timeframes defined as follows.

- 0 to 5-year timeframe - recommended completion through 2027
- 6 to 10-year timeframe - recommended completion between 2028 and 2032
- 11 to 20-year timeframe - recommended completion between 2033 and 2042
- 20+ year timeframe – recommended completion beyond 2043

A note on timeframes – these recommendations are based on an understanding as of 2022. If development occurs at a faster or slower rate, some projects, such as a second B Level reservoir, may be required earlier than documented in this WSMP. Additional studies may be required for certain projects, as well.

8.3 Supply

8.3.1 PWB Supply

The WCSL will need investment in the form of rehabilitation and eventual replacement. The City should plan for continued investment in the WCSL and an additional study when replacement is deemed necessary. As partners of the WCSL change their use of the supply main, this investment may change as well. A recent investigation by PWB evaluated potential changes in water quality as a result of increased water age as the WCSL's largest user, TVWD, discontinues use of the transmission main for wholesale supply in 2026. While the study indicated that increased water age should be offset by water quality improvements associated with the implementation of filtration of the Bull Run supply, the City should prepare for potential increases in disinfection by-product formation and lower disinfectant residuals when these changes occur in 2026.

8.3.2 Emergency Supply Development

As discussed in the *City of Tualatin - Water Supply Strategy* (The Formation Lab, 2021), PWB remains the most reliable source of long-term supply for the City and a three prong strategy is recommended to ensure the continued reliability of the City's water supply including:

- Invest in a New Backup Supply
- Continue to Support Reliability of the PWB System
- Increase Reliability of Local Interties

Tasks under these strategies are included in the CIP as CIP# 604, Emergency Supply Improvements Placeholder, with an assumed bulk cost to apply towards the various projects. The City should continue to update and refine the strategies as work continues, as well as update the CIP estimates as more information and detail are established for the City's long-term supply needs.

8.4 Storage Reservoirs

As presented in **Section 5**, the City will need additional storage at all supply levels. Due to site and transmission limitations, it is recommended to build all additional storage at the B Level, and pump or valve to appropriate pressures for the A and C Levels. Two locations have been identified – the existing ASR site and adjacent to the existing B Level Reservoirs (Norwood). Property acquisition may be required for a third reservoir at the Norwood site.

It is recommended that the City implement the following strategy for development of additional storage:

- Construct an additional 2.5-MG Reservoir in the next 5 years (2022-2027, CIP# 601). This improvement will address short-term storage deficits. It is anticipated that this storage will be constructed at the ASR site.

- The remaining system-wide deficit at buildout should be addressed by constructing a 1.0 MG reservoir with construction timing as required by development.

8.4.1 Reservoir Seismic Improvements

Various projects are recommended for seismic resilience improvements at the City’s reservoirs. In addition to projects discussed in **Section 8.8**, seismic valving should be installed at each of the reservoirs. This cost is included in CIP projects when upgrades are called out at individual reservoirs and as CIP# 602, 605, 613 and 614 for the B-2, C Level, and A Level Reservoirs.

8.5 Pump Stations

8.5.1 A to B Pumping

It is recommended the City invest in a facility to provide pumping from the A to B Levels in the event of a Boones Ferry FCV/PRV Supply outage. A replacement of the existing Martinazzi Pump Station is recommended, but a portable pump station is also an option. This pump station upgrade should occur in 6-10 years. Budget for this project is included in the CIP table under CIP# 606, Upgrade Martinazzi Pump Station.

8.5.2 B to C Pumping

As discussed in **Section 5.4.2**, it is recommended the City construct a second C Level Pump Station, located at the ASR site once a B Level reservoir is constructed at the site. This new pump station will provide resilience and flexibility for supplying the C Level, for both typical operations and fire flow requirements. Budget for this project is included in the CIP table under CIP# 603.

8.6 Distribution Mains

Replacement unit costs for distribution mains are displayed in **Table 8-1**. These costs are calculated as project costs based on RSMean pipe costs and recent bid tabulations in the region, and include general markups for earthwork and construction, erosion, and traffic control (five percent), meters (10 percent), fittings and valves (30 percent), mobilization (10 percent), contingencies (30 percent), contractor overhead (15 percent), engineering design (20 percent), and legal/admin coordination (10 percent). Actual costs will vary based on roadway improvements and other conditions.

Table 8-1 | Unit Costs for Distribution Main Projects

Pipe Diameter	Cost per Linear Foot (\$/LF)
8-inch	\$509
12-inch	\$686
18-inch	\$931

8.6.1 Fire Flow Improvements

As presented in **Section 5**, the City’s distribution system is generally well looped. Adequate fire flow is available throughout most of the existing distribution system. Localized water main upgrades (either upsizing or looping) are recommended to address fire flow deficiencies. These have been identified in the CIP (**Table 8-3**) as residential or non-residential fire flow projects. It should be noted that some industrial sites have onsite pumping that is not included in this analysis and may mitigate some of the deficiencies. Improvements to address sites that may have pumping are included in the plan at this time and should be assessed on a case-by-case basis prior to budgeting for improvements.

8.6.2 B Level Transmission Main

Proposed improvements between the Boones Ferry FCV/PRV and the B Level reservoirs are recommended to improve supply to the B and C Levels during maximum day demands. A replacement 18-inch diameter main is recommended. The completion of this major capital improvement project is split into two segments.

- A. Norwood Reservoir Site to Ibach Street (Norwood Road and Boones Ferry Road) within the immediate timeframe (CIP# 301A, 0-5 yrs, 2022-2027)
- B. Ibach Street to Sagert Street (CIP# 301B, 6-10 yrs, 2028-2032)

8.6.3 C Level Transmission Main

Upsized transmission is recommended between the C Level Pump Station at the Norwood site and the C Level Reservoirs at the Frobase site. A route along the existing transmission line was analyzed in the *Water System Capacity Analysis – Basalt Creek Service Technical Memorandum* (see **Appendix E**). It is understood that this project may face significant construction challenges and the City proposed a hydraulically similar path south through the proposed Autumn Sunrise development, then east via a new I-5 crossing aligned with Greenhill Road. A pre-design level analysis of the feasibility and cost of the two alternate routes should be evaluated. The updated transmission improvement is divided into multiple segments:

- 0-5 Years, 2022-2027 C Level Transmission Improvements:
 - Oversize Autumn Sunrise subdivision piping from C Level Pump Station, south to Greenhill Road to 18-inch diameter when constructed (CIP# 303)
 - New I-5 Crossing at Greenhill Road and connection to existing transmission along SW 82nd Ave, approximately 2,200 LF of 18-inch diameter main (CIP# 302A)
- 6-10 Years, 2028-2032 C Level Transmission Improvements:
 - Upsizing the remaining transmission from the new I-5 Crossing up to the C Level Reservoirs to 18-inch diameter main, 1,300 LF (CIP# 302B)

8.6.4 Replacements, Opportunity Projects, and Maintenance

The City has established on-going capital expenditures to maintain the existing distribution system level of service including,

- Water main replacements: Pipes were assumed to need replacement after 75 years. Continued investment in renewal and replacement of the water system is essential to ensuring reliable system operation and minimizing expensive emergency repairs associated with failing pipeline infrastructure. Costs were assumed at \$1,000,000 annually beginning in 2033 (Year 11 of the CIP) and continuing indefinitely.
- Opportunity projects: Upsizing or extension of water mains in concert with other utility or road work in the same area. Costs for these projects are not known but may be allocated in other capital projects slated for the future, or in pipe replacement.
- Annual maintenance: Annual maintenance for pipes, tanks, pump stations, valves, and other facilities is not considered in the CIP list. It is assumed these maintenance items are addressed in the operations budget.

8.7 Planning Studies

8.7.1 System-wide Planning

It is recommended that the City continue to update the WSMP every 10 years. An updated WSMP is required by the State of Oregon on a 20-year planning period. However, with the rapid pace of growth in Tualatin and the broader metro area, it is prudent for the City to continue to regularly evaluate capital investment and prioritize needs for the water system with updated WSMPs. An update has been included in the 11-20 year timeframe of the CIP (CIP# 615).

8.8 Additional Projects from City Planning

Additional projects have been included in this CIP from other City planning efforts.

8.8.1 AWIA Improvements

The American Water Infrastructure Act of 2018 (AWIA) is a federal law with over 30 mandated programs administered by the EPA. The primary goal of the law is to invest in aging drinking water systems. Several projects were identified in the City's compliance including the following:

- Onsite power generation (either trailer or permanent) at the C Level Pump Station. This project is in line with pump station power redundancy goals outlined in **Section 4** (CIP# 607).
- Seismic upgrades to the B-1 Reservoir. The City indicated a 2018 assessment called for improvements to bring the reservoir into code. A full seismic evaluation is recommended to refine project scope and costs.
- Seismic upgrades to each of the five (5) Portland Supply Valves, with the Boones Ferry FCV/PRV as top priority (CIP# 609).
- Miscellaneous physical site and cyber security upgrades.

8.8.2 City CIP

The City's current CIP includes several projects not mentioned elsewhere in the plan. These include:



- SCADA upgrades – At the end of 2021, the City began upgrading its SCADA system. Project costs were provided by the City and are included in year 0-5 and include design, implementation, and associated equipment.
- ASR well rehabilitation – The ASR well will likely require rehabilitation for efficient operation in the next 6-10 years.
- Childs Road AC main I-5 crossing replacement – The City intends to replace the AC crossing of I-5. Project costs were provided by City staff and are included as CIP# 702.
- Additional rehabilitation at reservoirs including:
 - A-1 Reservoir interior coating rehab (included in CIP# 613).
 - A-2 Reservoir interior coating inspection and rehabilitation (included in CIP# 614).

8.8.3 Future Service Areas



The backbone piping for future service areas is illustrated in **Figure 8-1**. These projects are included in the CIP as developer driven.

Legend

CIP Facility Improvements





-  Pump Station
-  PRV
-  Storage

Fire Flow Deficiencies





-  Residential
-  Non Residential

CIP Pipe Improvements











CIP Project Type

-  Fire Flow
-  Transmission
-  System Looping
-  Future Service
-  Existing Pipe

Pressure Zones

-  Bridgeport Village
-  A Level
-  B Level
-  C Level

Existing

-  Aquifer Storage & Recovery Facility (ASR)
-  Distribution Control Valve (PRPS)
-  Supply Control Valve (FCV-PRV)
-  Pump Station
-  Reservoir
-  County Line
-  Metro UGB
-  Water Service
-  City
-  Taxlots

0 4,000 Feet

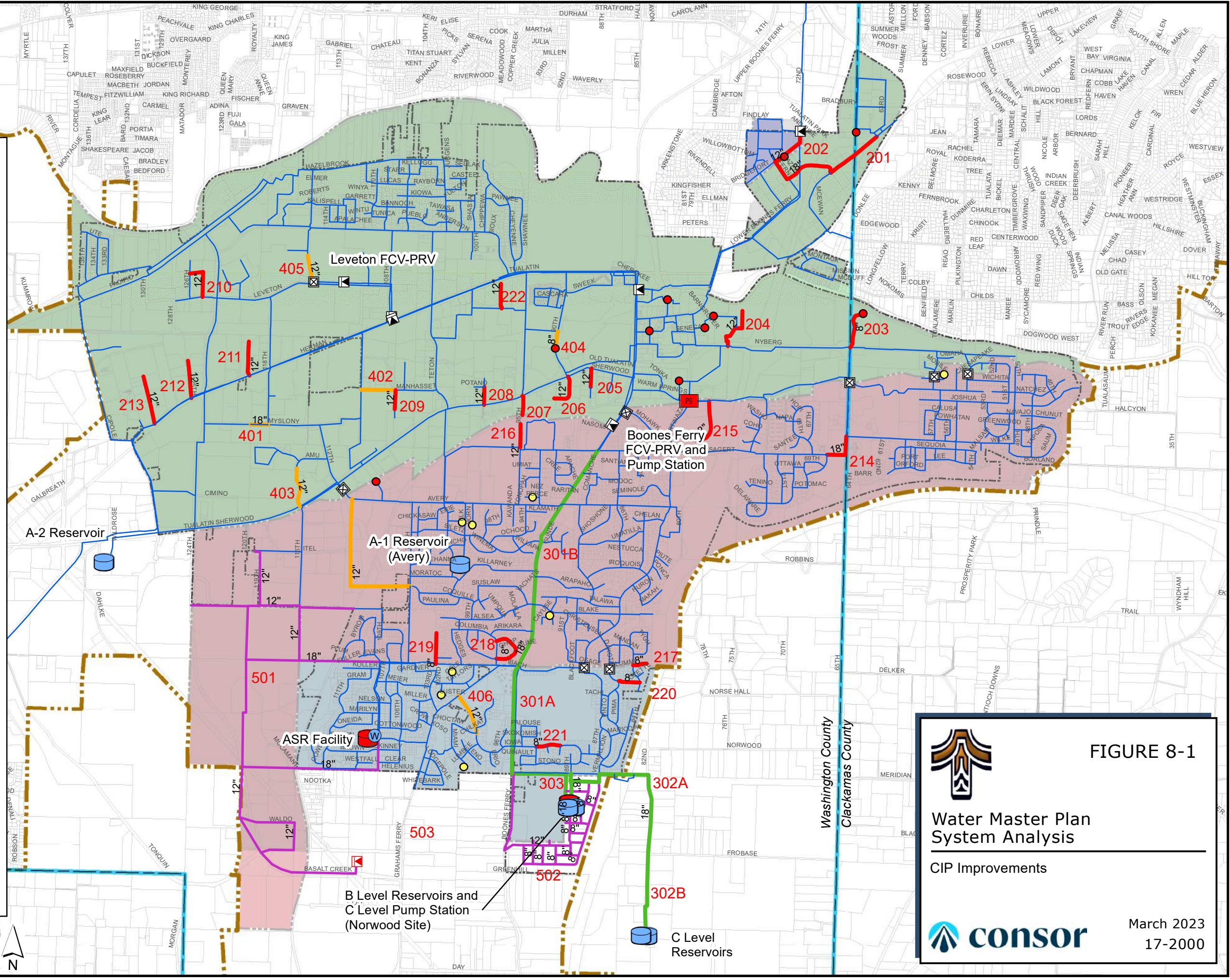





FIGURE 8-1

Water Master Plan System Analysis

CIP Improvements



March 2023
17-2000

C:\KMM\PROJECTS\17-2000-System Analysis Figures 5 8-3-22.mxd 3/3/2023 8:29:00 AM kate.lvn.McNulty

8.9 Capital Improvement Program

Table 8-2 presents a summary of project types and overall recommended CIP funding. Individual projects are listed and costed in **Table 8-3**. **Table 8-3** summarizes these projects by investment timeframe (0-5 years, 6-10 years, etc.). Within each timeframe projects are ordered by type. The City’s proposed CIP includes significant investment, particularly in supply and storage improvements. This new capacity will serve growth while also providing more resilient water facilities that benefit all customers. An evaluation of water rates and SDCs in support of the water system CIP will be completed as follow-on work to this WSMP.

Table 8-2 | CIP Cost Summary

Project Type	0-5 Years	6-10 Years	11-20 Years	Total
Residential Fire Flow			\$1,832,000	\$1,832,000
Non-Residential Fire Flow ¹			\$10,522,000	\$10,522,000
System Looping		\$3,328,000		\$3,328,000
Transmission	\$10,556,000	\$6,610,000		\$17,166,000
Facilities	\$14,850,000	\$7,300,000	\$5,610,000	\$27,760,000
Renewal and Replacement ²			\$9,900,000	\$9,900,000
Total	\$25,406,000	\$17,238,000	\$27,864,000	\$70,508,000

Notes:

1. Not all non-residential fire flow improvements may be required as some sites may have onsite pumping.
2. Pipe replacement is a perpetual ongoing cost and should be planned for. \$1,000,000/year was assumed to allow for systematic replacement of aging mains beginning in Year 11 of the CIP.

Table 8-3 | CIP Projects

CIP #	Project Type	Description	Diameter (in)/Size	Length (LF)	Cost Estimate	Timing
303	Transmission	C Level Transmission - Oversize Autumn Sunrise piping ¹	18	1400	\$1,304,000	0-5
605	Facilities	Seismic Upgrades at C Level Reservoirs			\$450,000	0-5
603	Facilities	B to C Level Pump Station at ASR Site (after or concurrent with 601)	1,000 gpm		\$2,000,000	0-5
302A	Transmission	C Level Transmission - new I-5 crossing and connect at Greenhill Rd	18	2,200	2,042,000	6-10
604	Facilities	Emergency Supply Improvements Placeholder			\$2,000,000	0-5
503A	Transmission	Basalt Creek Pipeline from Boones to Graham			\$2,555,000	0-5
301A	Transmission	B Level Transmission upsizing - Ibach to B Level Reservoirs	18	5,000	\$4,655,000	0-5
601	Facilities	B Level Reservoir 3 (predate or concurrent with 603)	2.5 MG		\$6,250,000	0-5
607	Facilities	C Level Pump Station, On Site Power Generation			\$200,000	0-5
610	Facilities	Miscellaneous Physical Site and Cyber Security Upgrades			\$250,000	0-5
611	Facilities	SCADA Upgrades			\$2,050,000	0-5
613	Facilities	A-1 Reservoir upgrades			\$2,100,000	0-5
404	System Looping	90th Ave (A Level)	8	500	\$255,000	6-10
401	System Looping	Myslony Rd (A Level)	18	500	\$466,000	6-10
405	System Looping	Leveton (A Level)	12	800	\$549,000	6-10
402	System Looping	Manhasset Dr (A Level)	12	900	\$617,000	6-10
403	System Looping	Amu St Extension (A Level)	12	1,000	\$686,000	6-10
406	System Looping	Iowa St (C Level)	12	1,100	\$755,000	6-10
302B	Transmission	C Level Transmission upsizing - SW 82nd Ave to C Level Reservoirs	18	1,300	\$1,210,000	6-10
301B	Transmission	B Level Transmission upsizing - Ibach to Sagert	18	5,800	\$5,400,000	6-10
606	Facilities	Upgrade Martinazzi Pump Station	4,000 gpm		\$5,500,000	6-10
612	Facilities	ASR Well Rehabilitation			\$600,000	6-10
614	Facilities	A-2 Reservoir upgrades			\$1,500,000	6-10
220	Fire Flow	Residential - SW Dakota Dr	8	600	\$305,000	11-20
221	Fire Flow	Residential - SW Iowa Dr	8	600	\$305,000	11-20
214	Fire Flow	Non-residential - SW Sagert St and 65th Ave	18	1,000	\$932,000	11-20
202	Fire Flow	Non-residential - SW Bridgeport Rd	12, 18	1,300	\$1,210,000	11-20
701	Renewal and Replacement	Annual Replacement of Aging Pipes ²	\$1M/Yr		\$9,000,000	11-20
217	Fire Flow	Residential - SW Lummi St	8	400	\$204,000	11-20
208	Fire Flow	Non-residential - SW 97th Ave	12	500	\$343,000	11-20
205	Fire Flow	Non-residential - SW 89th Ave	12	500	\$343,000	11-20
209	Fire Flow	Non-residential - SW Manhasset Dr	12	500	\$343,000	11-20
207	Fire Flow	Non-residential - SW 95th Ave	12	500	\$343,000	11-20
219	Fire Flow	Residential - SW 103rd Ct	8	800	\$407,000	11-20
216	Fire Flow	Non-residential - SW 95th Ave	12	600	\$412,000	11-20
222	Fire Flow	Non-residential - SW Herman Rd	12	700	\$480,000	11-20
203	Fire Flow	Non-residential - Stonestrow Apartments	8	1,100	\$560,000	11-20
218	Fire Flow	Residential - SW Columbia Cir	8	1,200	\$611,000	11-20
211	Fire Flow	Non-residential - SW 119th Ave	12	900	\$617,000	11-20
206	Fire Flow	Non-residential - SW 90th Ct	12	900	\$617,000	11-20
212	Fire Flow	Non-residential - SW 125th Ct	12	1,000	\$686,000	11-20
210	Fire Flow	Non-residential - SW 124th Ave	12	1,000	\$686,000	11-20
213	Fire Flow	Non-residential - SW 129th Ave	12	1,200	\$824,000	11-20
204	Fire Flow	Non-residential - Nyberg Rivers Looping	12	1,200	\$823,000	11-20
215	Fire Flow	Non-residential - SW Mohawk St	12	1,900	\$1,303,000	11-20
615	Facilities	Water System Master Plan Update			\$250,000	11-20
201	Fire Flow	Non-residential - SW Hazel Fern Rd, McEwan Rd, and I-5 Crossing	18	3,300	Future Cost	Beyond 20
608	Facilities	B-1 Reservoir seismic upgrades			\$2,110,000	11-20
609	Facilities	Portland Supply Valve Seismic Upgrades			\$1,000,000	11-20
702	Renewal and Replacement	Childs Road I-5 crossing and AC Main Replacement			\$900,000	11-20
602	Facilities	B Level Reservoir 4	1 MG		\$2,500,000	11-20
501	Future Service Area	Western B Level Extension	12, 18	32,800		
502	Future Service Area	Planned Residential near I-5	8, 12	11,600		
503B	Future Service Area	C Level Extension	12	9,600		
504	Future Service Area	C to B Level PRV in Basalt Creek Area	Fire Flow			

Notes:

1. Assumed City to pay only oversizing costs. Total cost shown consistent with other pipe improvements.
2. Pipe replacement is a perpetual ongoing cost and should be planned for. \$1,000,000/year was assumed to allow for systematic replacement of aging mains beginning in Year 11 of the CIP
3. Some of the non-residential fire flow improvements may be for locations with onsite pumping.

8.10 Funding Sources

A variety of sources may contribute to the funding of the City's CIP. In general, these sources can be summarized as: 1) governmental grant and loan programs; 2) publicly issued debt; and 3) cash resources and revenues. These sources are described below.

8.10.1 Government Loan and Grant Programs

8.10.1.1 Oregon State Safe Drinking Water Financing Program

Annual grants from the EPA and matching state resources support the Safe Drinking Water Fund. The program is managed jointly by the OHA DWS and Business Oregon's Infrastructure Finance Authority (IFA). The Safe Drinking Water Fund program provides low-cost financing for construction and/or improvements of public and private water systems. This is accomplished through two independent programs: the Safe Drinking Water Revolving Loan Fund (SDWRLF) for collection, treatment, distribution and related infrastructure, and the Drinking Water Protection Loan Fund (DWPLF) for sources of drinking water improvements prior to the water system intake.

The SDWRLF lends up to \$6 million per project, with a possibility of subsidized interest rate and principal forgiveness for a Disadvantaged Community. The standard loan term is 20 years or the useful life of project assets, whichever is less, with interest rates at 80 percent of the current state/local bond rate. The maximum award for the DWPLF is \$100,000 per project.

8.10.1.2 Special Public Works Fund

The Special Public Works Fund program provides funding for the infrastructure that supports job creation in Oregon. Loans and grants are made to eligible public entities for the purpose of studying, designing, and building public infrastructure that leads to job creation or retention.

Water systems are listed among the eligible infrastructure projects to receive funding. The Special Public Works Fund is comprehensive in terms of the types of project costs that can be financed. As well as actual construction, eligible project costs can include costs incurred in conducting feasibility and other preliminary studies and for the design and construction engineering.

The Fund is primarily a loan program. Grants can be awarded, up to the program limits, based on job creation or on a financial analysis of the applicant's capacity for carrying debt financing. The total loan amount per project cannot exceed \$10 million. The IFA is able to offer discounted interest rates that typically reflect low market rates for very good quality creditors. In addition, the IFA absorbs the associated costs of debt issuance thereby saving applicants even more on the overall cost of borrowing. Loans are generally made for 20-year terms but can be stretched to 25 years under special circumstances.

8.10.1.3 Water/Wastewater Fund

The Water/Wastewater Fund was created by the Oregon State Legislature in 1993. It was initially capitalized with lottery funds appropriated each biennium and with the sale of state revenue bonds since 1999. The purpose of the program is to provide financing for the design and construction of public infrastructure needed to ensure compliance with the SDWA or the Clean Water Act.

Eligible activities include costs for constructing improvements for expansion of drinking water, wastewater, or stormwater systems. To be eligible a system must have received, or be likely to soon receive, a Notice of Non-Compliance by the appropriate regulatory agency, associated with the SDWA or the Clean Water Act. Projects also must meet other state or federal water quality statutes and standards. Funding criteria include projects that are necessary to ensure that municipal water and wastewater systems comply with the SDWA or the Clean Water Act.

In addition, other limitations apply, including:

- The project must be consistent with the acknowledged local comprehensive plan.
- The municipality will require the installation of meters on all new service connections to any distribution lines that may be included in the project.
- The funding recipient shall certify that a registered professional engineer will be responsible for the design and construction of the project.

The Water/Wastewater Fund provides both loans and grants, but it is primarily a loan program. The loan/grant amounts are determined by a financial analysis of the applicant's ability to afford a loan including the following criteria: debt capacity, repayment sources, and other factors.

The Water/Wastewater Fund financing program's guidelines, project administration, loan terms, and interest rates are similar to the Special Public Works Fund program. The maximum loan term is 25 years or the useful life of the infrastructure financed, whichever is less. The maximum loan amount is \$10 million per project through a combination of direct and/or bond funded loans. Loans are generally repaid with utility revenues or voter-approved bond issuance. A limited tax general obligation pledge may also be required. Certain entities may seek project funding within this program through the sale of state revenue bonds, although this can be a significant undertaking.

8.10.1.4 Water Infrastructure Finance and Innovation Act

The Water Infrastructure Finance and Innovation Act of 2014 (WIFIA) established the WIFIA program, a federal credit program administered by EPA. The program can provide financing for a broad range of eligible water and wastewater projects or combinations of projects. Up to 49 percent of eligible project costs can be financed through WIFIA, which can be combined with other local funding sources such as revenue bonds.

The WIFIA program offers the potential for substantial savings to municipalities on borrowing costs through a combination of lower interest rates, deferred payments, flexible payment structuring, and longer loan term. Lower borrowing costs can reduce the level of rate increases needed to fund capital improvements.

The savings on borrowing costs begin with lower interest rates. The interest rate on WIFIA loans is fixed and is tied by statute to the 30-year Treasury rate as of closing, which is typically well below the market rate on revenue bond financing. Unlike with revenue bonds, funds from WIFIA loans are disbursed over time on a reimbursement basis as expenses are incurred. Interest accrues on WIFIA loan funds only as they are disbursed.

WIFIA loans are set up for 30-year repayment periods, with the loan term beginning after substantial completion of construction. Payments can be deferred throughout the construction period and for up to 5 years after substantial completion. The result is a potential loan term of up to 35 years after substantial completion. The WIFIA program also allows for flexible payment structuring throughout the loan term to help the borrower manage the impact of loan payments on rate increase requirements.

Projects are selected to apply for WIFIA financing through a competitive annual process administered by the EPA. Appropriate related federal provisions apply under the loans, such as National Environmental Policy Act (NEPA), Davis-Bacon, and American Iron and Steel.

8.10.2 Public Debt

8.10.2.1 General Obligation Bonds

General obligation bonds are backed by the City's full faith and credit, as the City must pledge to assess property taxes sufficient to pay the annual debt service. This tax is beyond the State's constitutional limit of \$10 per \$1,000 of assessed value. A "double-barrel" bond uses a mix of property taxes and user fees and is a mix of the general obligation bond and a revenue bond.

Oregon Revised Statutes limit the maximum bond term to 40 years. The realistic term for which general obligation bonds should be issued is 15 to 20 years, or more. Under the present economic climate, lower interest rates will be associated with the shorter terms.

Financing of water system improvements by general obligation bonds is usually accomplished by the following procedure.

1. Determination of the capital costs required for the improvement.
2. An election by the voters to authorize the sale of bonds.
3. The bonds are offered for sale.
4. The proceeds from the bond sale are used to pay the capital costs associated with the project(s).

General obligation bonds are similar to revenue bonds in matters of simplicity and cost of issuance. Since the bonds are secured by the power to tax, these bonds usually command a lower interest rate than other types of bonds. General obligation bonds lend themselves readily to public sale at a reasonable interest rate because of their high degree of security, tax-exempt status, and public acceptance.

General obligation bonds, which impact the community's tax burden through the full faith and credit pledge, are normally associated with the financing of facilities that benefit a large portion of the community and must be approved by a majority vote.

8.10.2.2 Revenue Bonds

For revenue bonds, the City pledges the net operating revenue of the utility to repay the bonds. The primary source of the net revenue is user fees, and the primary security is the City's pledge to charge sufficient user fees to pay all operating costs and debt service.

The general shift away from ad valorem property taxes and toward a greater reliance on user fees makes revenue bonds a frequently used option for payment of long-term debt. Many communities prefer revenue bonding because it ensures that no tax will be levied. In addition, debt obligation will be limited to system users since repayment is derived from user fees. An advantage with revenue bonds is that they reserve the tax-based revenues for other services and are not typically restricted by debt limitation statutes. Furthermore, the issuing authority can set user rates to fund the debt repayment without needing a public vote.

Municipalities may elect to issue revenue bonds for revenue producing facilities without a vote of the electorate (ORS 288.805-288.945). Certain notice and posting requirements must be met and a 60-day waiting period is mandatory. A petition signed by five percent of the municipality's registered voters may cause the issue to be referred to an election.

8.10.2.3 Improvement Bonds

Improvement (Bancroft) bonds can be issued under an Oregon law called the Bancroft Act. These bonds are an intermediate form of financing that is less than full-fledged general obligation or revenue bonds, but is quite useful, especially for smaller issues or for limited purposes.

An improvement bond is payable only from the receipts of special benefit assessments, not from general tax revenues. Such bonds are issued only where certain properties are recipients of special benefits not occurring to other properties. For a specific improvement, all property within the improvement area is assessed on an equal basis, regardless of whether it is developed or undeveloped. The assessment is designed to apportion the cost of improvements among the benefited property owners approximately in proportion to the afforded direct or indirect benefits. This assessment becomes a direct lien against the property, and owners have the option of either paying the assessment in cash or applying for improvement bonds. If the improvement bond option is taken, the municipality sells Bancroft improvement bonds to finance the construction,

and the assessment is paid over 20 years in 40 semi-annual installments with interest. Cities and special districts are limited to improvement bonds not exceeding three percent of true cash value.

8.10.3 Water Fund Cash Resources and Revenues

The City financial resources available for capital funding include rates, cash reserves, and SDCs. Rates are the backbone of a municipal water system's revenue and are typically established to provide funds to capitalize improvement projects or to repay debt-financed improvement projects.

An SDC is a fee collected on new development. The SDC is used to finance the necessary capital improvements required by the development. The charge is intended to recover an equitable share of the costs of existing and planned facilities that provide capacity to serve new growth.

Oregon Revised Statutes 223.297 – 223.314 establish guidelines on the establishment of the SDC methodology and administration. By statute, an SDC amount can be structured to include one or both of the following two components.

- *Reimbursement Fee* – Intended to recover an equitable share of the cost of facilities already constructed or under construction.
- *Improvement Fee* – Intended to recover a fair share of future planned capital improvements needed to increase the capacity of the system.

The reimbursement fee methodology must consider the cost of existing facilities and the value of unused capacity in those facilities. The calculation must also ensure that future system users contribute no more than an equitable share of existing facilities costs. Reimbursement fee proceeds may be spent on any capital improvements or debt service repayment related to the system for which the SDC is applied. For example, water reimbursement SDCs must be spent on water improvements or water debt service.

The improvement fee methodology must include only the cost of projected capital improvements needed to increase system capacity. In other words, the cost of planned projects that correct existing deficiencies or do not otherwise increase capacity may not be included in the improvement fee calculation. Improvement fee proceeds may be spent only on capital improvements (or related debt service), or portions thereof, that increase the capacity of the system for which they were applied.

Chapter 9



Section 9

Emergency Water Plan

9.1 Introduction

This section documents development and results of the Emergency Water Plan. The Emergency Water Plan is intended to address water system recovery after a catastrophic event such as a CSZ seismic event. In this scenario, it is assumed there is significant damage to water system infrastructure and the distribution system is not functioning. Water will initially be distributed at emergency water sites located throughout the community, with community members traveling to and those sites on foot. After a catastrophic event, City staff will be focused on recovering function of the water system, with emergency distribution activities largely being accomplished by emergency response agencies and the Community Emergency Response Team (CERT) and local volunteers. The Emergency Water Plan was developed with significant input from those agencies and groups.

The Emergency Water Plan has two components: 1) a Water System Recovery Plan describing the approach to incrementally recovering water system function following a catastrophic event and 2) Improvements and Materials needed to implement the plan.

9.2 Planning Process

The Emergency Water Plan was developed based on input from Emergency Responders and CERT. Prior to starting the project, the plan was envisioned as identifying specific sites through the City where emergency water would be distributed after a catastrophic event, with City staff delivering water to those sites in tanks or trucks and CERT and other volunteers directly distributing water from those sites to members of the community. Through the planning process and input from the emergency responders and CERT, it emerged that the plan should be more flexible and focus on working with existing infrastructure and supplies.

The plan was developed as follows.

- Emergency Responders Workshop. This workshop engaged local agencies involved in emergency response, educating them about the local water system and receiving input on water distribution sites characteristics and locations.
- Draft Emergency Water Plan. Based on the outcome of the workshop, the project team developed a draft plan to incrementally recover water system function.
- CERT Workshop. The project team shared the water system recovery plan with CERT, both to share information on the planned approach and to receive feedback.

- Revised Emergency Water Plan. A revised version of the Emergency Water Plan was presented to City Council.

Additional information on the two workshops is provided herein.

9.2.1 Emergency Responders Workshop

Goals of the Emergency Responders Workshop were as follows.

- Introduce attendees to Tualatin’s need for an Emergency Water Plan.
- Solicit feedback on ideal characteristics of an emergency water distribution site.
- Identify potential emergency water distribution sites for further consideration.

Attendees included representatives from: City of Tualatin Public Works and Police Departments, American Red Cross, Tualatin Valley Fire & Rescue, Washington County Emergency Management, Legacy Meridian Park Medical Center, Clackamas County Disaster Management, CERT, and the consultant team.

The workshop included initial live polling of attendees, a brainstorming exercise to identify ideal water distribution site characteristics, and an interactive exercise to identify potential water distribution site locations.

9.2.1.1 Level of Emergency Water Service

Attendees were polled during the meeting on their role in emergency response and expected level of emergency water service that can be provided to the community after a catastrophic event. Results of the polling included:

- 70 percent of attendees reported having a role in providing drinking water after an emergency.
- Attendees expressed a desire to move to a high level of preparedness (6 on a scale of 7) from the current low level of preparedness (3 on a scale of 7).
- All attendees have emergency water stored at home, with half meeting the recommended 14 gallons per person.
- Attendees estimated the maximum distance residents can be expected to walk to emergency water distribution sites as between a quarter and half-mile.
- Attendees on average thought that six to ten emergency water sites could be managed, though many thought fewer sites are more realistic.

Attendees recognize the number of sites that can be managed will drive the distance community members need to walk to get water, with the required distance likely exceeding the quarter to half-mile identified as preferable.

9.2.1.2 Ideal Characteristics of a Water Distribution Site

Attendees went through a brainstorming exercise to identify characteristics of an ideal emergency water distribution site. The group developed the following list.

- Accessible/traffic flow
- On a major street
- Appropriate distribution
- Co-located with other community points of distribution:
 - Near shelters
 - Near demand – SW99
 - Legal (get agreements in place)
- Securable – parking lots are hard
 - Familiar
- Open space for helicopter access
- Away from hazard exposure - flood earthquake, landslides, hazardous materials (check DOGAMI map), no overhead things (power)
- Schools, parks, churches, some reservoirs, big box stores
- Geographic equity:
 - Residential/across the city
 - Economically disadvantaged
 - Elderly

Attendees acknowledged that when National Guard or other emergency responders come in from outside the region, they will select their own sites for distribution of supplies that won't be affected by local plans or points of distribution. So, any designated emergency sites may be temporary. Those external emergency response agencies typically bring in bottled water that is distributed along with food and other supplies.

Attendees also noted the need for flexibility – selecting high priority or preferred sites is helpful, but don't convey to the public that all of those specific sites will be active or exactly as assumed.

9.2.1.3 Water Distribution Sites Opportunities

The group was divided into three subgroups to identify sets of emergency sites. A summary of the individual sites and notes provided by attendees on their rationale is provided in **Table 9-1**. Sites are organized by area. The sites selected by the groups were very similar – most of the most beneficial sites were identified by all three groups.

Table 9-1 | Emergency Water Distribution Sites Identified by Emergency Responders

	Site Description	Rationale
Northeast	Angel Haven & Riverpark	<ul style="list-style-type: none"> Site could accommodate large group of people
	Lam Research – Parking Lot	<ul style="list-style-type: none"> Large parking area where many employees in commercial area may congregate
	Hazelbrook MS	<ul style="list-style-type: none"> Close to residential population. Good staging area.
	Jurgens Park	<ul style="list-style-type: none"> Large open area for staging and close to residential area
	Parking Lot – Former Haggen Grocery	<ul style="list-style-type: none"> Centrally located
North east	Providence Bridgeport Immediate Care	<ul style="list-style-type: none"> Location north of Tualatin River
	Parking Lot – 24 Hour Fitness	<ul style="list-style-type: none"> Location north of Tualatin River
Southeast	Bridgeport Elementary	<ul style="list-style-type: none"> Site could accommodate large group of people
	Alfalati Park	<ul style="list-style-type: none"> Lots of available space. Close to denser, low-income housing
	Parking Lot – Legacy Meridian Hospital	<ul style="list-style-type: none"> Likely site for general emergency response coordination
Southwest	Living Savior Lutheran Church	<ul style="list-style-type: none"> Good access. Parking lot. Close to residential populations.
	Tualatin HS or Edward Byrom Elementary	<ul style="list-style-type: none"> Proximity to residential population. May be able to use existing irrigation well.
	ASR Well Site	<ul style="list-style-type: none"> Proximity to residential population. ASR well may be a source of water.
	A1 Reservoir	<ul style="list-style-type: none"> Likely stored water available.
	Ibach Park	<ul style="list-style-type: none"> Close to large population center
	Tualatin Elementary	<ul style="list-style-type: none"> Central location to large population center

9.2.1.4 Outcomes

A key outcome from the workshop is that the City of Tualatin Public Works Department cannot select and drive specific water distribution sites in isolation of other emergency response efforts. The Emergency Water Plan, with its information on where emergency water can most easily be delivered within the City, should instead feed into ongoing efforts in Washington County to identify community points of distribution.

Another second key outcome of the Emergency Responders Workshop was the recognition that the majority of the emergency distribution sites selected by the group lay along a major backbone pipe through the City’s water system. The focus then shifted from identifying specific water distribution system sites to developing a plan to recover water system function along that backbone, with the goal of restoring supply of continuously flowing, piped water to multiple sites along that backbone.

9.2.2 CERT Workshop

The project team presented the proposed Emergency Water Plan to CERT, including the core of the water system recovery plan described in **Section 9.3**. In the presentation, the team shared information on how Tualatin’s water system works and what can be expected from the water system after a catastrophic event.

Goals of the meeting were for CERT to:

- Gain a better understanding of the water system
- Know what to expect from the water system after a catastrophic emergency
- Understand CERT roles in distributing water during an emergency

The City’s goal for the meeting was to receive feedback from CERT members on its plan to recover water system function, including the water distribution site characteristics and support needed by CERT to fill its role. In addition to providing feedback during the meeting, CERT members provided written feedback on forms distributed at the event.

Overall, CERT members appreciated the planning effort and general approach, in the words of one CERT member “It is flexible and seems to focus on what is doable as the main goal.” Other CERT feedback included:

- Emergency water should be available at locations familiar to City residents (e.g., schools)
- Distribution locations should be provided throughout the City (including east of the I-5 freeway)
- Any portable tanks should be designed to work with pick-up trucks, allowing community members to transport water using their own vehicles
- CERT members would like training and clear written instructions on emergency water procedures (how to operate equipment and disinfect water, how much water to give per person)

CERT feedback was incorporated into the water system recovery plan described in **Section 9.3**.

9.3 Water System Recovery Plan

This section summarizes the first two phases of a Water System Recovery Plan, identifying the general approach, assumptions, and required improvements and supplies. The Water System Recovery Plan includes the four phases shown in **Table 9-2**. This plan focuses on the first two stages – additional detail for those two phases is provided in this chapter.

Table 9-2 | Water System Recovery Plan Phases

Stage/Duration	Goals
Stage 1 First few weeks	<ul style="list-style-type: none"> ▪ Hold on to water stored in reservoirs ▪ Allow volunteers to access the stored water and move it around the City
Stage 2 First couple month	<ul style="list-style-type: none"> ▪ Create a sustained, emergency level, water distribution system ▪ Get running water to a series of emergency water distribution sites along the City’s pipe backbone ▪ Connect the City’s well to that backbone system
Stage 3 One to four months	<ul style="list-style-type: none"> ▪ Connect our emergency backbone to the Portland supply or other available working supply
Stage 4 Several months to years	<ul style="list-style-type: none"> ▪ Recover full normal function of the water distribution system ▪ Restore water service to individual homes and businesses throughout the City

9.3.1 Stage 1

Stage 1 captures the first few days and weeks after a catastrophic event. It is assumed that the water distribution system is non-operational, with multiple pipe breakages throughout the distribution system. The general approach to this stage is:

- Seismic valves on the reservoirs capture the stored water and prevent it from leaking from the distribution system.
- Water system operators initially focus on repairing any damage to the tanks to prevent losses of stored water. If some tanks are badly damaged, operators will need to assess whether all reservoirs can be maintained.
- Emergency water is provided to the community via trucked water. Based on CERT feedback, water will be transported using portable tanks designed to fit the beds of standard-sized pick-up trucks. It is assumed water will be transported by CERT or other community members in their own vehicles, using tanks provided by the City.
- CERT and other community members will distribute water to community members from the portable tanks. It is assumed a portion of immediate water needs will be filled through community members using their own stored water.

9.3.1.1 Reservoir Storage Capacity

The City has six water storage reservoirs with a total water storage volume of 14.0 MG. Though under normal conditions this storage would meet demands for only a couple days, they can provide water at a subsistence level (two gallons per person per day). Calculations are shown in **Table 9-3** and show subsistence-level water needs can be met for the City’s population for approximately 120 days, assuming reservoirs retain half their volume.

Table 9-3 | Ability of Stored Water to Meet Subsistence-Level Water Needs

Item/Description	Value
Total Stored Water Volume Based on 50% of reservoir total volume	7.0 MG
Daily Subsistence Water Need Based on two gallons per person and City population of 28,000	56,000 GAL
Days of Stored Water Stored water volume divided by daily subsistence water need	120 days

9.3.1.2 Required Improvements and Supplies

Improvements and supplies for this stage are listed in **Section 9.4** and include:

- Improvement: Seismic valves on all tanks, prioritizing Reservoirs B-1 and B-2. Facilities to allow easy filling of portable tanks at each reservoir.
- Supplies: four portable water tanks designed to be transported by standard size pick-up trucks.
- Supplies: Bottled water at the Operations Center to sustain City staff and community members supporting emergency water distribution.

Community members will also require individual containers to transport water home from the emergency distribution sites. It is assumed sufficient containers will be available through individual preparedness – the City does not plan to purchase or provide individual containers.

9.3.2 Stage 2

Stage 2 includes the first couple of months after the event. The focus during this stage is on recovering function of a backbone pipeline that can be used to provide a continuous supply to emergency water distribution sites.

The general approach to this stage is:

- Function of the backbone pipeline is recovered incrementally, working from valve to valve, starting from Reservoirs B-1 and B-2.
- At each step, the set of valves immediately downstream will first be closed. The upstream valve will then be partially opened to allow water to flow into the segment of pipe to identify leaks. The upstream valve will then be reclosed while major leaks are repaired or bypassed. Once the segment is recovered, the upstream valve will be opened and work will move to the next segment.
- Hydrants along recovered portion of the backbone pipe will be available for emergency water distribution. Distribution will occur via manifolds designed to connect to fire

hydrants. Public Works staff will connect the manifolds, with community volunteers responsible for monitoring and distributing water from the manifolds to community members.

- The backbone will be recovered working north from Reservoir B-1 and B-2 along SW Norwood Road and SW Boones Ferry Road to SW Avery Street, then working west to connect the A-1 Reservoir and east towards Legacy Meridian Park Medical Center. Finally, the backbone will be extended to connect to the City’s ASR well.

9.3.2.1 ASR Capacity

The City has a single ASR well with a conservative sustainable flow rate of approximately 300 gpm. Though the ASR well can itself serve as a source of emergency water, it cannot be used to directly feed a manifold as the flow rate is too for the system to operate efficiently. The Water System Recovery Plan instead assumes the backbone pipe will connect to the ASR well, with Reservoirs B-1 and B-2 providing storage and allowing the well to be operated at full capacity.

Though under normal conditions the ASR would meet only a small portion of average demands, it can provide water at a subsistence level (two gallons per person per day) to the City. Calculations are shown in **Table 9-4** and show subsistence-level water needs can be met for 100 percent of the City’s population.

Table 9-4 | Ability of ASR Well to Meet Subsistence-Level Water Needs

Item/Description	Value
ASR Daily Flow Rate Based on capacity of 300 gpm and 10-hour per day operation	252,000 gallons per day
Portion of City Population Based on total population of ****	100 %

9.3.2.2 Required Improvements and Supplies

Supplies needed for this stage consist of materials for pipeline repair and bypass. Specific supplies are identified in **Section 9.4**. One goal of the Emergency Water Plan was to minimize the need for supplies that will not be used and maintained as part of normal water system operation. The supplies shown in **Section 9.4** focus on increasing inventory of currently used supplies, rather than focusing on specialized materials and approaches.

9.4 Improvements and Supplies

Improvements and supplies required to implement the Water System Recovery Plan are summarized in **Table 9-5**. Improvements were incorporated as individual items within the capital improvement budget in **Section 8**. Required supplies are beyond what can be accommodated within the operations and maintenance budget and are included as a single line item within the Capital Improvements Plan.

Table 9-5 | Water System Recovery Plan Improvements and Supplies

Item	Estimated Cost
Emergency Water Supplies	
Portable Tank Fill Station at Reservoirs (A-1, A-2, B-1/B-2)	\$30,000
Portable water tanks (4)	\$10,000
Bottled water supply for operations center	\$2,000
Water distribution manifolds (10)	\$25,000
Temporary Pipe and Fittings	\$50,000
Miscellaneous Items	\$8,000
Total Investment	\$125,000

Appendix



**MEMORANDUM OF UNDERSTANDING
REGARDING THE REGIONAL WATER SALES AGREEMENT**

This Memorandum of Understanding (“MOU”) is between the City of Portland (“Portland”) and its nineteen current wholesale customers (“Wholesale Customers”) who purchase water at a wholesale water rate from Portland to sell to their own retail water customers through the 2006 Wholesale Water Purchase Agreement (“current agreement”) set to sunset for most Wholesale Customers in 2026. The Wholesale Customers and the expiration dates of their individual current agreements are listed in Exhibit A to this MOU.

This MOU is intended to memorialize the working relationship that exists between Portland and the Wholesale Customers (collectively, “Parties”) and to outline steps the Parties propose to develop and ultimately agree to a new Regional Water Sales Agreement (“New Agreement”) to be effective on or before July 1, 2026. The relationship between the Parties is built on mutual trust and open, honest, and transparent communication. This affiliation is critical to ensure that the New Agreement can be created that mutually works well for the Parties.

The Parties recognize the importance of developing and strengthening a regional water system that provides water to approximately one million people. This robust system can move water between basins through a planned regional transmission network to address seismic resiliency, wildfire suppression incidents, and other events. The Parties recognize that a reliable water supply system is critical to protect the health and safety of all customers and maintain the economic stability and growth of the greater metropolitan area.

The Parties agree on the importance of creating a fair and equitable New Agreement that shares the reasonable costs associated with building, operating, and maintaining a regional water supply system.

The Parties agree that following items are in their common interest:

1. The current agreement no longer meets many of the needs of the Parties. The current agreement was created to address a set of conditions, many of which do not exist today. Since 2006, Portland and the Wholesale Customers have worked hard to develop regional collaboration based on mutual trust and an understanding of shared goals.
2. With a few exceptions, the current agreement renews (or expires) in 2026 (see Exhibit A). On or before June 30, 2021, most of the Wholesale Customers are required to notify Portland, or vice versa, if they intend to exit the current agreement in 2026.

3. For the past year, the Parties have been developing a framework for a new wholesale water sales agreement that will replace the current agreement and provide terms that are mutually acceptable and agreed upon by the Parties.
4. To that end, the Wholesale Customers hired FCS Group ("FCS"), a financial consulting firm, to work with the Parties to identify elements that they would like to include in the New Agreement. The FCS report (attached as Exhibit B) identified common goals and principles the Parties want to include in the New Agreement.
5. To assure that New Agreement will be in place on or before July 1, 2026, Portland will provide notice to Wholesale Customers on or before June 30, 2021, that Portland will not renew the current agreement.
6. The Parties intend to work together collaboratively to develop the New Agreement with a final draft completed by June 30, 2022.
7. With this MOU, Portland is stating its desire to continue selling water to all current Wholesale Customers who intend to purchase water from Portland. The Parties intend to jointly develop the New Agreement that will govern the terms of sale of that water to the Wholesale Customers beyond the 2026 expiration date of the current agreement.
8. The New Agreement will be based on the principles and goals jointly developed by the Parties and documented in the FCS report.
9. Nothing in this MOU modifies the current agreement between Portland and the Wholesale Customers, which for most Wholesale Customers remains in full force and effect until July 1, 2026.

IN WITNESS WHEREOF, the Parties have executed this MOU to be effective as of the date last executed. The parties attest that the signatories to this MOU have the authority to enter into this agreement on behalf of their respective agencies.

City of Portland

Signature: Gabriel Solmer

Print Name: Gabriel Solmer

Title: Administrator, Portland Water Bureau

Date: 2/10/2021

Agency: _____

Signature: _____

Print Name: _____

Title: _____

Date: _____

City of Tualatin Water Supply Strategy

Water Supply Strategy

(Rev. 7/9/21)

Introduction

The City of Tualatin (Tualatin) is developing a Water Supply Strategy to ensure a safe and reliable supply of drinking water for their community. The City currently purchases wholesale water from the City of Portland and plans to continue use of the Portland supply into the future. Portland's water source is the Bull Run watershed, supplemented with groundwater from the Columbia South Shore Wellfield. To reach Tualatin, Portland water travels over 50 miles through three large diameter pipes between the watershed and Powell Butte in SE Portland, and then through the Washington County Supply Line. After 2026, Tualatin Valley Water District (TVWD)—a major user of the Washington County Supply Line—will no longer use Portland as its main supply. This may leave the City of Tualatin with a greater share of the pipeline's maintenance and repair costs. The final 6 miles of Tualatin's supply system, the Tualatin Supply Main, is owned solely by Tualatin. It is over 40 years old and is Tualatin's sole supply connection. If the Tualatin Supply Main pipeline were to break, Tualatin would have very limited supply available through a combination of the City's single Aquifer Storage and Recovery (ASR) well and a number of small connections with neighboring water systems. Many of those neighboring systems use water sourced from the Willamette River—use of Willamette River water is prohibited under a City of Tualatin charter amendment unless allowed under a governor-declared state of emergency.

In response to these vulnerabilities, Tualatin committed to developing a water supply strategy. The water supply strategy focuses on understanding the system's current performance during different types of emergencies then identifying opportunities to increase Tualatin's water supply reliability under emergency conditions. The intent of the strategy is not to initiate a change in Tualatin's supply but to understand current and future opportunities to maintain Tualatin's supply if the current system is interrupted.

As part of this study, neighboring water agencies were also asked about their capacity to potentially provide long-term supply in the future. The intent was not to initiate a change in Tualatin's water supply, but instead to understand water supply availability in the region if Portland's water were to become unavailable or unaffordable. Though short-term supplies could be provided by several of the water agencies listed above, there is no agency with excess supply sufficient to meet the long-term needs of Tualatin. ***Portland remains the most reliable source of long-term supply for the City of Tualatin.***

The document is organized into the following sections:

- Community Conversation and Values
- Existing Water System and Supply
- Existing Backup Supplies and Interties
- Long-term Supply Availability
- Current System Performance in an Emergency

- Opportunities to Increase Reliability
- Water Supply Strategy

Community Conversation and Values

A significant part of the Water Supply Strategy is to engage in a community conversation about water—educating the public on vulnerabilities of Tualatin’s existing water supply and receiving feedback on community values. The City reached out the community in two ways.

First, stakeholder interviews were conducted with City Council and community leaders. The input from stakeholders was used to develop an initial set of community values relevant to the water system. That process identified seven community values.

Next, community members were asked to rank community values to identify the most important values to consider in developing a reliable supply. Efforts to gain input on values included tabling at community events, including events focused on Tualatin’s Latino/ Hispanic community; results from the online survey; and presentations to community and City advisory groups. Community input was gathered from a total of 267 community members through these efforts. In addition to providing input on values, community members were asked about emergency preparedness and awareness.

Key learnings from community engagement are summarized here. More information on the outreach efforts and results are provided in *Attachment A – Community Conversation Summary*.

Water quality and reliable delivery—now and into the future—are most important to Tualatin customers. Ordered from most to least important, the community values are:

- Provides safe, high-quality water
- Provides enough water for future needs
- Prepares the community for an earthquake or natural disaster
- Continues conservation as an important strategy
- Allows our community to be a good steward of our natural and water resources
- Deliver the best value to customers
- Prepares the community for global climate change

All the identified community values resonated with the community and were seen as important. Cost is important, but not as important as having high-quality reliable water—‘best value’ ranked sixth out of the seven values. The top values are consistent with stakeholder input and are reasonably consistent among the different groups polled. Overall, these community values show a willingness to invest in safe, reliable water.

Customers take the reliability of their water for granted—when they learn about vulnerabilities, they support City action. Customers are generally aware of and have positive response to Portland’s Bull Run as Tualatin’s primary supply. But almost across the board, water is taken for granted and there is little to no awareness of the vulnerabilities of Tualatin’s supply. Stakeholders note it is important to educate the public about the existing system and its limitations. Explaining the issue—the ‘why’—to the general public is important to gain the public’s attention. Once they become aware, they are concerned and motivated to increase the reliability of the system. They want solutions to focus on long-term needs, not short-term fixes.

The Willamette River carries a negative perception with some, but the landscape shifts when considering emergency use. Highly knowledgeable stakeholders consider the Willamette a good source of supply and see use by others in the region as evidence of its quality. Others in the community have a sense of the Willamette as dirty or contaminated—not as good as the Portland Bull Run supply or other regional options. The number of people with negative perceptions of the Willamette is relatively small—fewer than 10% of survey respondents noted a negative perception of the Willamette when prompted for input on water sources. However, those who have negative perceptions of the Willamette River often feel strongly. Participants acknowledge the Willamette River is more acceptable as an emergency option, as opposed to replacing Portland as the main supply.

Existing Water Supply and System

Tualatin’s existing water supply and distribution system and current and projected demands are detailed in the 2021 Water Master Plan. The summary below captures information critical to understanding and evaluating backup supply options.

Water Supply System

Tualatin’s sole source of supply is wholesale water purchased from Portland Water Bureau. That water is delivered by gravity from Portland’s Powell Butte Reservoir on the east side of Portland via the Washington County Supply Line—a large diameter pipeline with a length of 22.2 miles and diameter ranging from 36 to 66 inches. Closer to Tualatin, the Metzger-Tualatin Supply Line is co-owned with TVWD and extends 2.5 miles from SW Beaverton Hillsdale Highway at Oleson Road, to SW 80th Avenue and Florence Lane. The final section of pipeline is the Tualatin Supply Main. It is owned solely by Tualatin and includes 5.9 miles of 36-inch diameter pipe. A schematic of this system is shown in Figure 1.

Tualatin has a single Aquifer Storage and Recovery (ASR) well used to supplement supply during peak demands. During the winter when demands are low, Portland water is injected into the well and stored underground. That water is then pumped out during the hottest parts of the summer to offset Tualatin’s peak demands. The pumping capacity of the well is around 0.5 million gallon per day (MGD)— less than 10% of Tualatin’s peak summer demand.

Water Distribution System

A map of Tualatin’s water system is presented in Figure 2. Tualatin’s water system has three major water pressure zones—in order from lowest to highest elevation, Zone A (295 feet), Zone B (399 feet), and Zone C (506 feet). There is an additional, very small pressure zone that serves commercial customers within Bridgeport Village (BV, 360 feet). This zone is isolated from the rest of the system and has its own backup supply connection from the City of Tigard—it is not discussed further within the Water Supply Strategy.

Each zone is described by its water pressure, measured as a hydraulic grade line (HGL) or equivalent water elevation. Zones with higher HGLs are required in higher elevation areas (such as in the southern area of Tualatin), and zones with lower HGLs are needed in lower elevation areas (in the northern area of Tualatin). If the HGL were the same everywhere in a system, pressures in low lying areas would be too high and do damage to the water system and household plumbing. Conversely,

Figure 1. Tualatin's Water Supply System

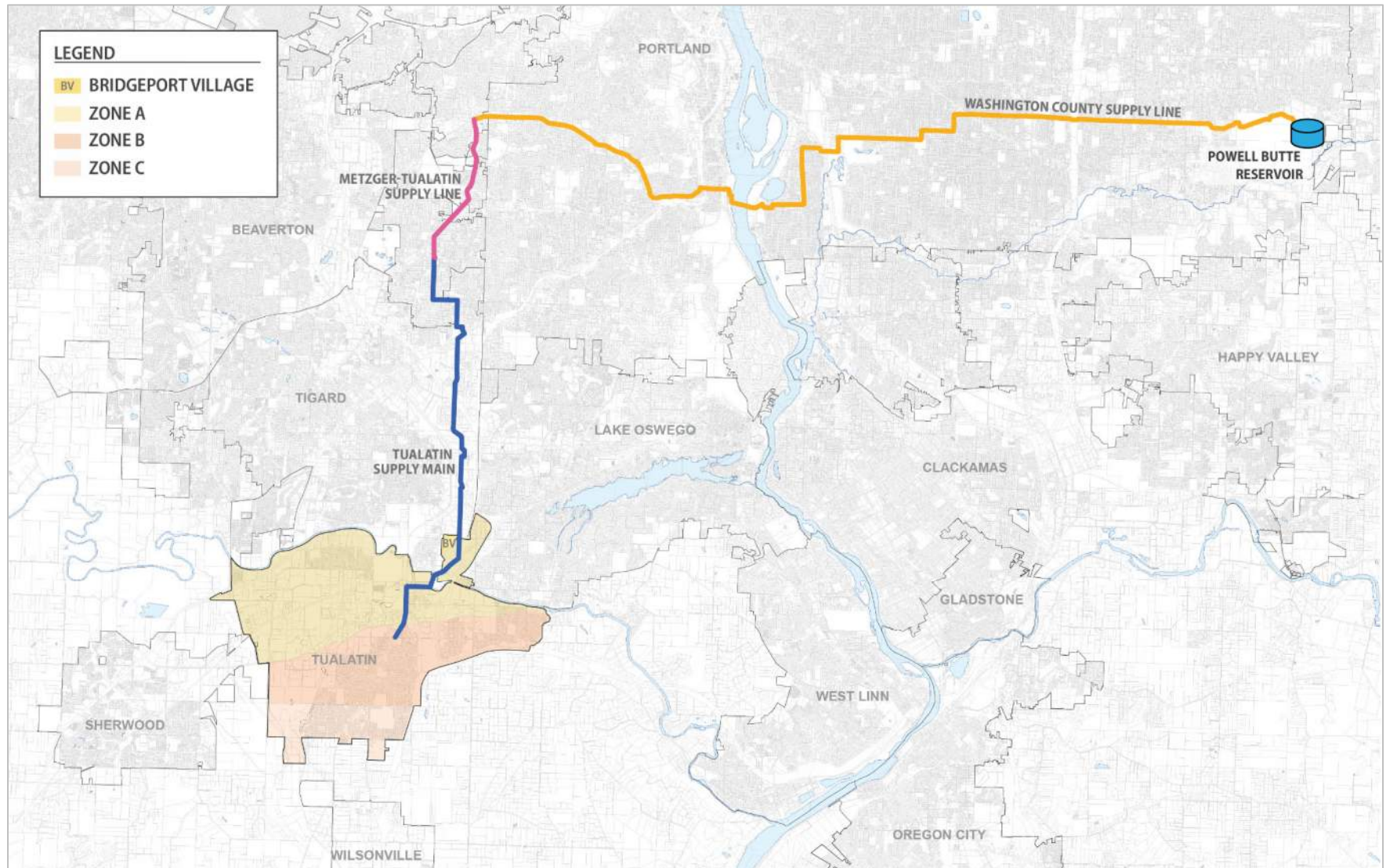
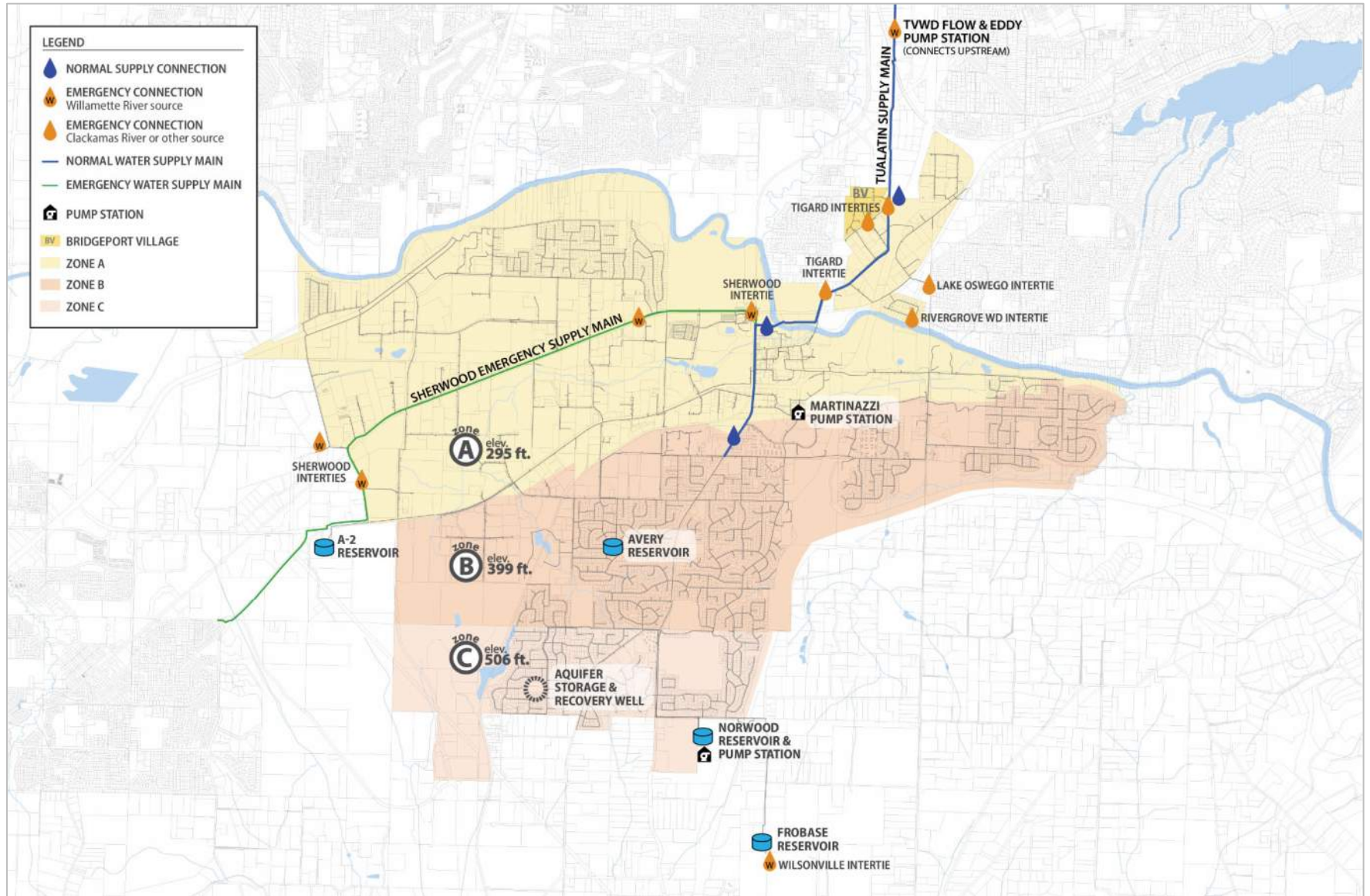

Figure 2. Tualatin's Water System



up on a hill, the pressure would be too low and the City wouldn't be able to fight fires or deliver reasonable water pressure to people's homes and businesses.

In general, water can be moved from areas with a higher HGL to areas with a lower HGL, in the same way that a ball would roll down a hill from a higher elevation point to a lower one. When water is moved to a lower pressure zone, pressure reducing valves are used to reduce the water pressure down to that of the receiving service level. Pumping is required to move water up to a higher service level.

Tualatin's two main water service zones—Zones A and B—are served directly by the Tualatin Supply Main, which extends into Tualatin's system. Water can reach all areas of the system from Zone B; water flows to Zone A via pressure reducing stations and is pumped to Zone C by the C-Level Pump Station. Within the existing system, there is very limited ability to pump water from Zone A to Zone B. The Martinazzi Pump Station pumps from Zone A to Zone B, but has not been in normal operation for over 20 years. Annual tests have verified the pump station is still operating, but it has limited reliability.

Water systems are designed with larger water transmission pipelines (in this case, the Tualatin Supply Main) that connect to increasingly smaller distribution pipes as the water moves through the distribution system to its outer reaches. To provide reliable supply-level water service, a backup supply needs to be able to connect to transmission pipelines, as the distribution pipes are too small to convey a significant amount of water.

Water Demands

Tualatin's water demands are summarized in Table 1. Tualatin has enough water supply capacity to meet current and estimated future demands. On a peak day, Tualatin's demands are around 8.1 MGD, expected to increase to around 10.6 MGD when Tualatin is built out. On an average day, demands are around half of peak demands. In the winter, when water is not being used for outdoor watering, the City uses around 3.2 MGD. That includes indoor uses like drinking, bathing, and flushing the toilet, as well as industrial and commercial uses. A backup supply should, at a minimum, be able to meet winter demands but would preferably be able to maintain normal water service at an average day or greater level of service.

Table 1. Current and Project Demands

Type of Demand	Actual Demand in 2017	Estimated Demand at Buildout
Winter Demand Winter demands are used to estimate indoor water use—the water used for drinking, showering, washing, cooking, and flushing toilets.	3.2 MGD	4.1 MGD
Average Day Demand (ADD) The average amount of water the community uses in a day, averaged over an entire year. It includes indoor use and a limited amount of outdoor, irrigation use.	4.2 MGD	5.5 MGD

Type of Demand	Actual Demand in 2017	Estimated Demand at Buildout
Maximum Day Demand (MDD) The maximum amount of water the community uses in a single day over the year, typically after a string of very hot summer days when there is very high water use for irrigation.	8.1 MGD	10.6 MGD

* Based on 2017 and buildout demands from the Water System Master Plan, winter demands are around 75% of average day demands.

Existing Backup Supplies and Interties

Tualatin’s existing connections to neighboring utilities can be classified as either backup supplies or local interties. To be considered a backup supply, a connection must have the following characteristics:

- Connection between Tualatin and the neighboring system must have a large diameter (at least 24 inches).
- Direct connection to a reservoir or major transmission pipeline (24 inches or larger) within the neighboring distribution or supply system.
- Connection to a major transmission pipeline—the Tualatin Supply Main—within the City’s system so that the backup supply can be distributed to all areas of the City’s system.
- Ideally, reliance on a different water supply source so that it will still be available if Portland’s supply is temporarily unavailable.

A backup supply differs from a local intertie, which is a connection at the edge of the distribution system that connects two adjacent water systems. These interties generally have low (and unreliable) capacity, due to the small diameter of the connection (less than 12 inches), limited pipeline capacity to deliver water to and away from the intertie, and often limited (and variable) pressure available to deliver water. Local interties are useful to address localized distribution system outages but are not considered sufficiently reliable to address a system-wide supply interruption.

It is not possible to accurately determine the capacities of individual local interties. Assumptions based on pipeline diameter tend to overestimate available flow. There may be an insufficient difference in hydraulic grade line (HGL) (too flat) from the neighboring system to Tualatin’s receiving zone, or pipelines around the local intertie may have limited hydraulic capacity.

Existing and potential connections between Tualatin and neighboring water systems are summarized in Table 2, with additional information provided in *Attachment B – Regional Water Opportunities*. The information was developed based on Tualatin’s 2021 Water Master Plan and meetings with staff from Portland Water Bureau, Tualatin Valley Water District and the Cities of Tigard, Lake Oswego, Sherwood and Wilsonville.

Table 2. Existing Interties and Backup Supplies¹

Intertie or Backup Supply	Water Source	Type	Pressure Zone Served (HGL)	HGL (other)	Dia. (in)	Relies on TSM
TVWD/Tualatin Flow and Eddy Pump Station From TVWD system into TSM	WWSP/Joint Water Commission	Supply-level	Zones A (295) and B (399)	450	36"	Yes, long section
Tigard Intertie Boones Ferry & Lower Boones Ferry	Clackamas River (LO-Tigard Partnership)	Local Intertie	Zone A (295)	410	10"	Yes, short section
Tigard – Bridgeport Intertie Fire connection and separate intertie at 72 nd & Boones Ferry ²	Clackamas River (LO-Tigard Partnership)	Local Intertie & Fire Conn.	Zone A (295)/ TSM	410	10"	No
Lake Oswego Intertie 65 th & McEwan	Clackamas River (LO-Tigard Partnership)	Local Intertie	Zone A (295)	320	12"	No
Rivergrove Intertie 65 th & Childs	Rivergrove wellfield	Local Intertie	Zone A (295)	315	8"	No
Sherwood Emergency Supply Main City Park	Willamette River WTP	Local Intertie	Zone A (295)	380	24"	No
Sherwood Intertie Cipole and Galbreath	Willamette River WTP	Local Intertie	Zone A (295)	380	8"	No
Wilsonville Intertie Frobese Reservoir Site	Willamette River WTP	Local Intertie	Zone C (507)	506	8"	No

¹ HGL – hydraulic grade line (water level), TSM – Tualatin Supply Main, LO – Lake Oswego. WTP – Water Treatment Plant

² Intertie not listed in Water Master Plan as intertie normally serves emergency water from the Tualatin Supply Main to Tigard. Pressure in Tigard system is lower than pressure in the Tualatin Supply Main. Operation would require the main be valved off from the Portland Supply.

Table 2 notes the regional supply accessed through each connection. Tualatin is fortunate to be located adjacent to utilities using a number of different regional supplies. The four supplies used by neighboring utilities are:

- **Joint Water Commission** sources water from the Tualatin and Trask watersheds, stored in Hagg Lake and Barney Reservoir. The water is filtered in Forest Grove and the system is co-owned by TVWD and the Cities of Hillsboro, Beaverton, and Forest Grove .
- **Lake Oswego-Tigard Water Partnership** sources water from the Clackamas River. The water is filtered in Lake Oswego and the system serves both Lake Oswego and Tigard.
- **Willamette Water Supply System (WWSS)** is currently under construction and will be in service in 2026. The new system will source water from the Willamette River which will be filtered at a new site in Sherwood. The system will be co-owned by TVWD and the Cities of Hillsboro and Beaverton.
- **Willamette River Water Treatment Plant** is located in the City of Wilsonville. It sources water from the Willamette River and is co-owned by the Cities of Wilsonville and Sherwood. This supply shares an existing river intake with the Willamette Water Supply System.

Only one of the existing connections—water pumped by the TVWD/Tualatin Flow and Eddy Pump Station—is considered a backup supply. The pump station is co-owned by Tualatin and TVWD and has two pumps that pump water from the TVWD system into the last sections of the Washington County Supply Line and then into the Tualatin Supply Main. With a combined capacity of 10 MGD, Flow and Eddy can provide sustained supply at average day demands, or at peak day demands if TVWD does not require emergency supply at the same time. If activated today, this pump station would provide water from the Joint Water Commission and Portland supplies. Starting in 2026, this connection would also provide water from the WWSS.

Other existing connections are classified as local interties because of their location at the periphery of the distribution system and the small diameter of their connections. The one exception is a 24-inch Sherwood Emergency Supply Main that was constructed to ‘wheel’ Portland water through Tualatin to Sherwood. It connects directly to the Tualatin Supply Main and has sufficient diameter to meet backup supply requirements. However, the pressure and pipe diameters on the Sherwood side mean it can only serve the lowest zone (Zone A) and flow would be limited. This connection sources water from the Willamette River Water Treatment Plant in Wilsonville.

Long-term Supply Availability

Neighboring water utilities were also asked about the availability of non-emergency, long-term wholesale supplies. The intent was not to initiate a change in supply, but to understand options Tualatin would have if Portland supply were to become unavailable or unaffordable.

Tualatin has been a long-term wholesale customer of Portland. As part of that relationship, Portland includes Tualatin’s needs within its water supply and infrastructure planning efforts. Though either party can terminate the agreement, long-term wholesale agreements are typically not terminated by the wholesale provider and provide a reliable long-term source of water. Tualatin would be seeking an equivalently stable wholesale relationship if need for an alternate long-term supply were to arise.

Overall, **none of the neighboring utilities are able to offer an equivalently secure wholesale relationship.** Utilities have only secured sufficient supplies to meet their own long-term needs. Two of the neighboring utilities (TVWD and the City of Sherwood) have wholesale water available for a limited

period. Water could be available for 20 or 30 years, or even longer, but these agencies would not be able to make a long-term commitment equivalent to Tualatin’s current relationship with Portland. Both utilities use water supplied from the Willamette River.

Performance of Existing System During an Emergency

This study focused on two different scenarios for interruption of Tualatin’s supply—the first is interruption of supply upstream of the Tualatin Supply Main and the second is failure of the Tualatin Supply Main itself. Water systems can also experience localized outages due to distribution pipeline or pump station failures, system maintenance, or construction. These localized outages are best addressed through local interties and are not the focus of the water supply strategy. The expected system performance under each scenario is discussed below.

Scenario 1 - Loss of the supply system upstream of the Tualatin Supply Main

This scenario could include an outage or severe curtailments of Portland’s Bull Run and groundwater supplies, contamination of the transmission system by algal toxins or a malevolent act, or maintenance activities on the transmission system that last longer than a few days. In this scenario, the Tualatin Supply Main is assumed to still be intact and available to convey water from neighboring water systems.

Overall, this scenario has low likelihood because of investments Portland Water Bureau has made in reliability of the supply system. Those investments include the availability of the groundwater system as a backup supply and the ability to bypass significant portions of the Washington County Supply Line through other existing infrastructure. Information on that bypassing approach is provided in *Attachment C – Portland Water Bureau’s Planned Response to an Outage of the Washington County Supply Line*. The location where the bypassed supply would enter the Washington County Supply Line is shown in Figure 3, labelled Portland Emergency Connection.

Portland Water Bureau is also investing in a new water filtration facility that will further increase reliability of the supply, allowing

Figure 3. Connections Available During Supply System Failure Upstream of the Tualatin Supply Main

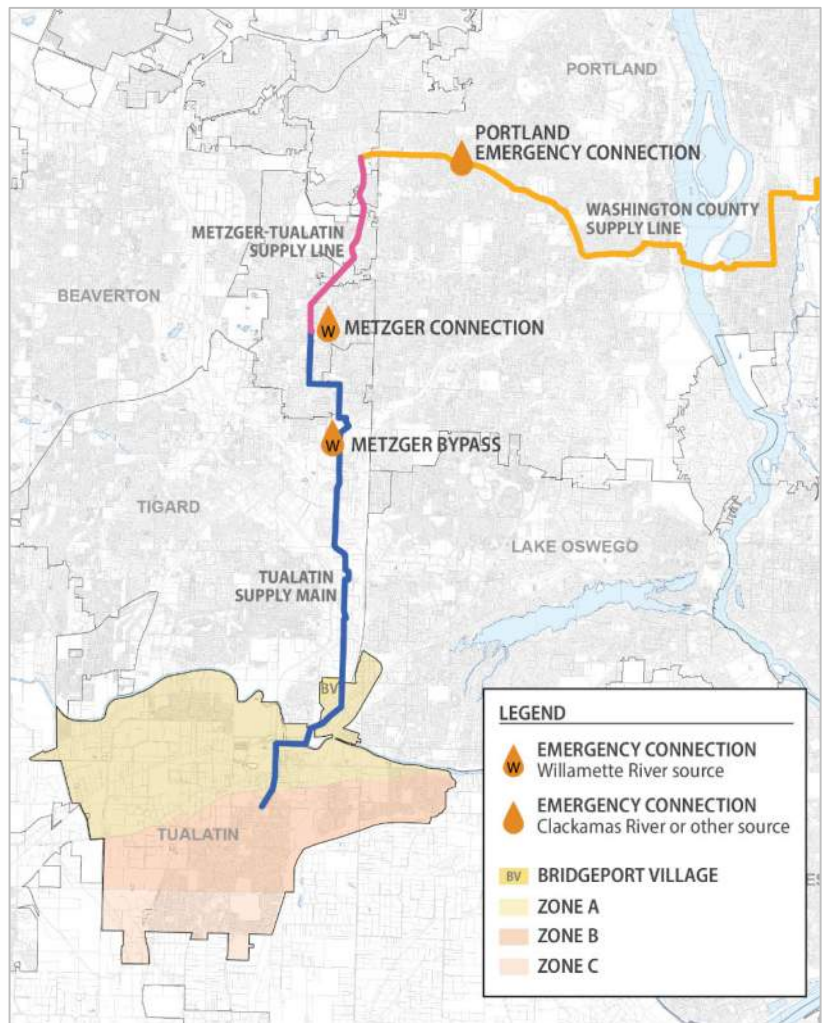

continued operation after a fire in the watershed and protecting against algal toxins and any future contamination.

Current System Performance. If Portland’s systems were to fail, Tualatin has made its own investment—the TVWD/Tualatin Flow and Eddy Pump Station—that would provide reliable water service in this scenario. The Emergency Pump Station can provide reliable supply to meet average day demands (including industrial and commercial needs) at a minimum, up to full peak day demands if TVWD does not also require emergency pumping. This emergency water could be supplemented with flows from both the City’s ASR well and from local interties. Water stored in the City’s reservoirs would help meet demands while the pump station and other emergency connections are deployed. If the emergency were to occur today, the Flow and Eddy Pump Station would deliver water from the Portland system. After 2026, this connection will provide water from the Willamette Water Supply System. Though not a formal intertie, TVWD is also able to bypass around the Metzger-Tualatin Supply Line and upper portions of the Tualatin Supply main using distribution piping in the Metzger area (labeled ‘Metzger Bypass’ in Figure 3). The bypass piping has the capacity to deliver flow at around half Tualatin’s average day demand.

Conclusion. The combined existing Portland Water Bureau and Tualatin systems offer a high level of reliability and no further investments are needed to address this scenario.

Scenario 2 - Failure of the Tualatin Supply Main

The second scenario is supply interruption due to pipe failure or maintenance of the Tualatin Supply Main, downstream of the TVWD intertie mentioned above. This pipeline is over 40 years old and is a concern because there is no infrastructure in place to bypass the pipeline. This is important because some existing and potential backup supply options use the Tualatin Supply Main and would be unavailable in this scenario.

Current System Performance. If interruption of the Tualatin Supply Main were sustained beyond a couple of days, it is likely the system would experience severe disruption of water service. The main reason for that disruption is that the main backup supply—the TVWD/Tualatin Flow and Eddy Pump Station—relies on the Tualatin Supply Main and could not be used. This would leave the City dependent on water stored in its reservoirs (which provide around two average days of water), the ASR well (that can meet around 7% of peak day demands), and local interties.

Local interties are limited in their capacity, their reliability, and their locations within the Tualatin system. Many of Tualatin’s residential customers are located within the higher zones (Zones B and C) in the southern half of the City; these Zones encompass around 45% of total system demands. Unfortunately, most of the local interties (six of seven) connect to the lowest Zone (Zone A) and most are clustered in the northeast corner of the system. Zone C has a single local intertie and Zone B has none. In this scenario, Zones B and C would mostly be reliant on the Martinazzi Pump Station to provide service—this pump station has not been regularly used for over 20 years and is not considered reliable. The locations of demands and interties are shown in Figure 4.

Conclusion. If the Tualatin Supply Main fails, the City will be unable to reliably provide water service to significant portions of the City. ***Tualatin requires a backup supply that is independent of the Tualatin Supply Main and can reach all areas of the City’s system.***

Figure 4. Geographic Location of Interties and Demands

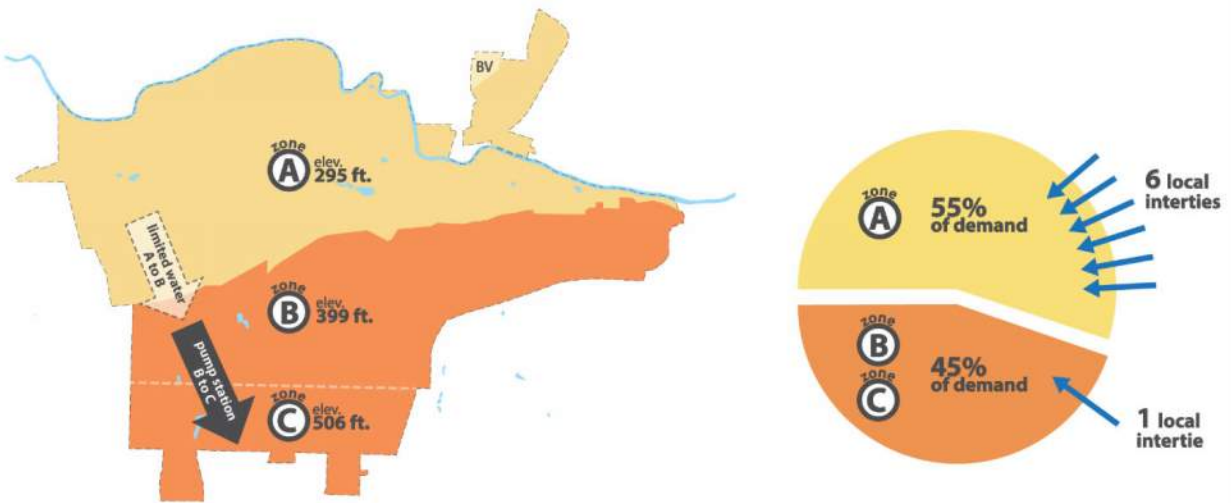

Potential New Backup Supplies and Interties

Discussions with neighboring utilities and subsequent analyses identified five opportunities to increase system reliability. Those potential improvements are summarized in Table 3, with additional information provided in *Attachment B - Regional Water Opportunities*.

Identified Opportunities

Local interties may be useful to address localized distribution system outages but do not have the capacity to serve a system-wide supply interruption. The opportunities include two local interties:

- **WWSS Intertie** would increase the diameter of the existing connection between the City's distribution system and the WWSS. The intertie was established to provide construction water to the WWSS and serves Zone A.
- **Wilsonville Intertie at Basalt Creek** would connect new areas of the Wilsonville and Tualatin distribution systems within the Basalt Creek area, within Zone B.

The above local intertie opportunities are documented here, but not further discussed as they do not significantly affect overall vulnerability of Tualatin's system.

Backup supplies have sufficient capacity to provide a reliable supply during an emergency. The opportunities include three options for a new backup supply:

- **Lake Oswego/Tigard Supply Connection** would connect the Lake Oswego-Tigard supply pipeline directly to the Tualatin Supply Main where the two pipelines cross at SW 80th Avenue and Florence Lane.
- **Improved Sherwood Emergency Supply Main** would extend the existing Sherwood Emergency Supply Main within the Sherwood system to connect directly to Sherwood's supply from the Willamette River Water Treatment Plant.

Table 3. Potential New Interties and Backup Supplies¹

Intertie	Water Source	Type	Pressure Zone Served (HGL)	HGL of Supply	Dia. (in)	Dependent on TSM
Lake Oswego/Tigard Supply Connection Connection between the Lake Oswego-Tigard supply line and the Tualatin Supply Main	Portland/WWSP	Supply-level	Zone B (399 ft)	410	24"	Yes
Improved Sherwood Emergency Supply Main Sherwood Supply Main with extension to increase capacity	Willamette River WTP	Supply-level	Zone B (399 ft)	470	24"	No
Sherwood Emergency Supply Main + WWSS Connection Delivery of WWSS supply via the Sherwood Emergency Supply Main	Willamette Water Supply System WTP	Supply-level	Zone B (399 ft)	520	24"	No
WWSS Intertie Connection to Tualatin’s distribution system at 124 th Avenue	Willamette Water Supply System WTP	Local Intertie	Zone A (295 ft)	520	12"	No
Wilsonville Intertie Intertie at Basalt Creek	Willamette River WTP	Local Intertie	Zone B (399 ft)	400	~10"	No

¹ HGL – hydraulic grade line (a measure of water pressure), Dia. – diameter of the supply pipeline, WWSS – Willamette Water Supply System.

³ Uses a section of the Tualatin Supply Main located downstream of most of the supply connections between the supply main and Tualatin’s system, so unlikely to be impacted by a Tualatin Supply Main outage affecting Portland supply.

- **Sherwood Emergency Supply Main + WWSS Connection** would connect the WWSS Water Treatment Plant to the Sherwood Emergency Supply Main, delivering WWSS water directly into Tualatin’s transmission system.

The three backup supply opportunities were screened to identify improvements that would address existing deficiencies—providing a reliable backup supply throughout the City during a failure of the Tualatin Supply Main. The screening is shown in Table 4. Two of the opportunities, both utilizing the Sherwood Emergency Supply Main, meet the requirements.

Table 4. Screening of Backup Supply Opportunities

Backup Supply	Provides Backup Supply to All Areas of the City?	Independent of Tualatin Supply Main?
Lake Oswego/Tigard Supply Connection	✓	X
Improved Sherwood Emergency Supply Main	✓	✓
Sherwood Emergency Supply Main + WWSS Connection	✓	✓

Summary of Feasible Options

There are two viable options to address Tualatin’s emergency supply deficiency. A brief summary and an order of magnitude cost for each of the two options is below.

Option 1 – Improved Sherwood Emergency Supply Main. This option would make improvements within the Sherwood system to upgrade the existing Sherwood Supply Main into a supply-level connection. The Sherwood Supply Main was designed to transfer Portland water from TVWD through Tualatin to Sherwood. To serve Tualatin, the flow in the pipeline would be reversed, feeding Sherwood’s Willamette supply into Tualatin’s Zone A and the downstream end of the Tualatin Supply Main. Though the pipeline connects to the Tualatin’s transmission system, under current conditions there is not enough water pressure to serve Tualatin’s Zone B. To achieve the required water pressure, the Sherwood Supply Main would be extended within Sherwood to the reservoir where the Willamette Supply enters the system, as shown in Figure 5.

Figure 5. Option 1 – Improved Sherwood Emergency Supply Main

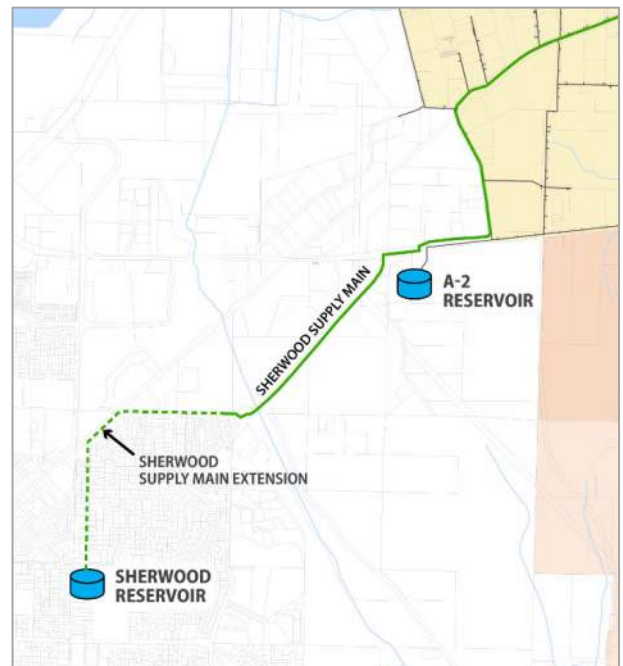

This connection would cost on the order of two million dollars, based on a required pipeline length of around three quarters of a mile. Actual cost would depend on the specific route and requirements.

Option 2 - Sherwood Emergency Supply Main + WWSS Connection. This option would connect the new WWSS Water Treatment Plant to the existing Sherwood Emergency Supply Main, as shown in Figure 6. The WWSS Water Treatment Plant has an existing 12-inch diameter connection with Tualatin's distribution system at 124th Avenue and Tualatin-Sherwood Road. Though this connection could be upsized, it is limited by its connection to the Tualatin distribution system within the lowest Zone (Zone A). It has both limited capacity and cannot reach portions of the system outside of Zone A. By connecting the WWSS Water Treatment Plant to the Sherwood Emergency Supply Main, the supply

Figure 6. Option 2 - Sherwood Emergency Supply Main + WWSS Connection

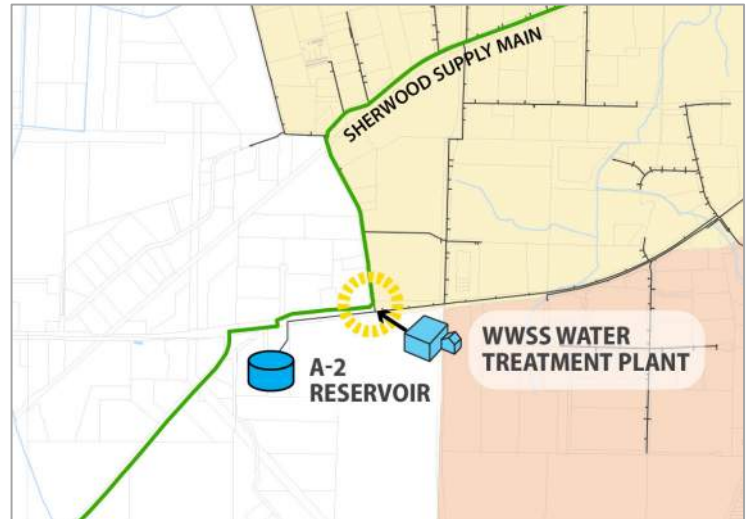

would feed directly into the Tualatin's transmission system, allowing the water to reach all areas of Tualatin's system. Because the water in the Sherwood Emergency Supply Main is stagnant, the line would need to be flushed with fresh water before it could be used, delaying use by around 48 hours. Tualatin's ASR well, storage reservoirs, and local interties would be used to meet demands during that period.

The capital cost of this project would be on the order of \$0.5 million, as the Sherwood Emergency Supply Main is located very close to the WWSS Water Treatment Plant. It is assumed there would also be 'wheeling' charges for use of the Sherwood Emergency Supply Main during an emergency, similar to the wheeling charges Sherwood paid in the past to use the Tualatin Supply Main. A wheeling charge is a cost per unit of water transferred through another agency's infrastructure and is usually documented in an interagency agreement.

Preferred Option

A comparison of the two viable options is presented in Table 5. Overall, the options provide very similar characteristics and benefits:

- Both options deliver water directly to the Tualatin transmission system via the Sherwood Emergency Supply Main, providing effective delivery of emergency water to all areas of Tualatin's system.
- Both options address vulnerability of the Tualatin Supply Main, providing reliable backup supply if the Tualatin Supply Main were out of service.
- Both options deliver water sourced from the Willamette River.

Table 5. Comparison of Backup Supply Opportunities

Backup Supply	Option 1 – Improved Sherwood Emergency Supply Main	Option 2 – Sherwood Emergency Supply Main + WWSS Connection
Provides backup supply to all areas of the system	✓	✓
Provides backup supply during failure of the Tualatin Supply Main	✓	✓
Can be designed to meet average day demands	✓	✓
Order of Magnitude Cost	~\$2 Million	~\$0.5M
Complexity of partnering relationships	Single Partner - Requires agreement with Sherwood on use of both the pipeline and use of supply	Multiple Partners Requires agreement with Sherwood on use of the Supply Main, and WWSS on use of supply.
Water Source	Willamette River water treated at the Willamette River Water Treatment Plant	Willamette River water treated at the WWSS Water Treatment Plant

The options differ in two main factors:

- Option 2 has a lower cost as the WWSS Water Treatment Plant is located very close to the Sherwood Emergency Supply Main, requiring minor improvements. Option 1 requires more extensive piping.
- Option 1 has more simple partnering requirements, as the City would be partnering with Sherwood for emergency access to both the pipeline and supply. Option 2 is more complex, requiring agreement with both Sherwood and the WWSS.

Overall, Option 2 – Sherwood Emergency Supply Main + WWSS Connection is the preferred option, based its lower cost and simpler infrastructure requirements.

Water Supply Strategy

A three-pronged strategy is recommended to continue reliable water service to the City’s customers.

Strategy 1 - Invest in a New Backup Supply. The City’s existing system is vulnerable to an outage of the Tualatin Supply Main. The preferred option to address this vulnerability is to work with the City of Sherwood and the WWSS to interconnect the WWSS Water Treatment Plant and the Sherwood Emergency Supply Main. The first step will be to approach both agencies to discuss the opportunity, identify benefits and concerns, and work towards a shared project. The Improved Sherwood

Emergency Supply Main is a viable alternative if the Sherwood/WWSS combination is determined to not be feasible or desirable.

Strategy 2 – Continue to Support Reliability of the Portland System. Portland Water Bureau will be conducting a distribution system master plan within the next 5 years. It is important that Tualatin stay engaged with those efforts to ensure the City’s demands are included in analysis of backup supply options. The City should also continue ongoing engagement related to future maintenance of the Washington County Supply Line, with the goals of maintaining reliable and affordable supply.

Strategy 3 – Increase Reliability of Local Interties. The City should work with neighboring agencies to increase the reliability of their interties: making sure agreements are in place and working together to test interties on a regular basis. The City should also continue to take advantage of future intertie opportunities, such as within the Basalt Creek area.

Attachment A

Community Conversation Summary



City of Tualatin Water Supply Strategy Community Conversation Summary

(Rev. 4/6/20)

Introduction

The City of Tualatin is developing a Water Supply Strategy to ensure a safe and reliable supply of drinking water for the community. A significant part of the study is to engage in a community conversation about water—educating the public on vulnerabilities of Tualatin’s existing water supply and receiving feedback on community values. The City reached out the community in two ways:

- **Stakeholder Interviews.** Stakeholder interviews were conducted with City Council and community leaders. The stakeholder interviews were used to develop an initial set of community values relevant to the water system.
- **Community Values Input.** Community members were asked to rank community values to identify the most important values to consider in developing reliable supply. Efforts to gain input on values included tabling at community events, including events focused on Tualatin’s Latinx community, results from the online survey, and presentations to community and City advisory groups.

This memorandum summarizes learnings from the community conversation into four sections: stakeholder interview summary, community values, additional input collected through the online survey, and overall conclusions. Community input summarized in this memorandum will be integrated into the City’s overall water supply strategy.

Stakeholder Interview Summary

In Spring 2019, interviews were conducted with 17 stakeholders representing a cross-section of community representatives, elected officials, health and safety professionals, business owners, educators, and community leaders. A list of interviewed stakeholders is provided in Appendix A and stakeholder interview questions are provided in Appendix B. This summary reflects the advice, feelings, and attitudes of the individuals interviewed. It is not intended to provide a statistically valid profile of community opinion as a whole.

Participants were asked to share their perceptions of Tualatin’s current and future water supply vulnerabilities and opportunities, along with their suggestions to improve reliability. Participants were also asked to provide insight on ways to engage the community in the planning process. The observations, insights, and suggestions provided by the interview participants were used to develop additional community outreach for the project and inform development of the strategy.

Overall Themes

Few people think about water or where it comes from. Almost across the board, stakeholders feel the public takes water for granted with limited knowledge of where their water comes from, current risks, or regional supply options. Explaining the issue—the ‘why’—to the general public is important to gain the public’s attention.

“It’s not real high on anybody’s radar.”

“For most people, you turn on the tap and you get water.”

“Explain why we should consider a change of water source, the different options, and provide information on water quality and safety, then budget.”

Understanding the risks of a single water source changes the stakes. Stakeholders are generally aware and have positive response to Bull Run as Tualatin’s primary supply. However, there is concern that the system lacks redundancy of multiple sources. Stakeholders note it is important to educate the public about the existing system and its limitations.

“Where we are today is not sustainable”

“Consensus of shock that we have no redundancy.”

“The need for a secondary source is understood—especially with regional growth, climate change, and natural disaster.”

“As far as getting emergency interties to other water supplies, I don’t understand why we haven’t done that already.”

Focus on long-term needs, not just short-term fixes or emergency conditions. Stakeholders advise the City to have a clear, long-term plan that that fits in with the City’s other priorities.

“We need to consider how the strategy fits with the future and look at the day to day impacts on the community, not just in an emergency.”

“The strategy needs to be tied into what the City envisions for itself moving forward.”

“Have a plan that is well thought out in regard to climate change and growth.”

“Make sure it’s sustained. For me that means that 5 years or 10 years down the road the supply is still there, and we can continue providing our residents with the quality and abundance we need.”

Top water supply values are supply reliability and water quality. Stakeholders worry about performance of the system in an emergency situation—whether an earthquake, or other impact such as a pipe breakage or the Salem toxic algae event. There is strong interest in water quality and knowing the water is safe.

“Some Councilors are worried about the rising cost of water, I don’t consider that important. I’m more concerned with redundancy.”

“Redundancy is number one. Having multiple suppliers contributes to system resilience as well as redundancy. Need to make sure the system is stronger and can take a hit.”

“I’ve just heard about the situation in Portland where the pipes are more than 100 years old.”

“Need to think about cleanliness of water and source.”

“Safety should be first and foremost. What good is getting water if it’s not clean and safe.”

Cost is a concern, but increased rates are acceptable if decisions are smart and well explained.

Stakeholders agree that cost and rates could be an issue but frame the concern as making best value decisions and demonstrating the return on investment.

“Incremental costs everyone understands. If Tualatin is taking a dramatic turn in water supply that would cause a significant investment, it’ll drive interest.”

“Residents will care about rates. Businesses will just factor it in.”

“If the conversation is about cost, that’s one thing. If it’s about these are the things we need to do to get water for our city, probably less so.”

The Willamette River still carries a negative perception with some. Highly knowledgeable stakeholders consider the Willamette a good source of supply and see use by others in the region as evidence of its quality. Others have a sense of the Willamette as dirty or contaminated—not as good as the Portland Bull Run supply or other regional options. Participants acknowledge the landscape shifts when a water source is being considered only as an emergency option. Changes to the charter amendment would require a heavy lift.

“Everyone says Bull Run water is the best. Everyone is fearful of the Willamette.”

“I’d worry about the quality of the Willamette based on everything the river touches on its way to us. I think others would share this concern.”

“A repeal to the Willamette River ban would fail. If it was for emergency only, it might pass.”

“If there’s an emergency, the humanitarian thing to do is to find water for citizens. No limitations in case of an emergency.”

“Nobody in Wilsonville is dying of dysentery or cholera, so I don’t have any negative feelings about it.”

Transparency and community involvement are valued. Stakeholders underscore the importance of sharing information and being transparent about current risks and vulnerabilities to help affect change. Be honest about the risks and why the study is needed.

“Having the public engaged, not just feeling a part, but being a part of the process is important.”

“As a taxpayer, it’s such a critical need, yes, we want to make it better, but we also want to see the decisions are prudent, smart, and cost effective.”

“Once the plan is pulled together, hold a large business/water user summit and clearly explain their place in the plan.”

“It’d be nice to get into the schools and talk about water.”

Use multiple forms of communication to inform and engage. Stakeholders emphasize using a mix of communication methods – City newsletter, social media, utility inserts, media outlets, community events – to reach different groups. Stakeholders advise the City to connect with engaged citizens, business owners, and community organizations who will share information within their networks.

“Go to the people and use a meeting space that’s more managed by the community and offers opportunity for conversation rather than testimony.”

“Provide something ‘splashy’ to draw children so that you can draw in families.”

“Think of the audience first. Provide information in a format that meets audience and population, including translation and material for different education levels.”

Community Values

Community members were engaged to identify community values that will guide the Water Supply Strategy. Outreach was conducted in both English and Spanish. Efforts to gain input on values included:

- **Online survey.** The online survey was developed in both English and Spanish and advertised in both languages on the City’s website, through the Tualatin Today online newsletter, and on postcards distributed at community events and available to the public in City offices.
- **Tabling at community events.** The project team hosted tables at four community events: Concert on the Commons, Reading on the Commons, and two events focused on Tualatin’s Latinx community—National Night Out and Viva Tualatin. The project team also hosted a table at the Juanita Pohl Center (Tualatin’s Active Aging Center). Community members at these events were invited to complete the online survey, fill out a paper survey that was then entered into the online survey, or identify their top three values on English- or Spanish-language posters. Most responses were included in the online survey.
- **Presentation and live polling at community organization meetings.** The project team provided a presentation on Tualatin’s current water supply and vulnerabilities at meetings of four community organizations: Chamber of Commerce, Community Emergency Response Team (CERT), Youth Advisory Committee, and Kiwanis.

All events included ranking of seven community values identified through the stakeholder interviews and previous public opinion research in the region. In the online survey and at the CERT meeting, respondents were asked to score each value on a scale from 1 (not at all important) to 5 (extremely important). At other events, attendees were asked to select the three values most important to them using live voting or by indicating selections on a poster.

Community input was gathered from a total of 267 community members through these efforts; values input is summarized in Table 1. The table identifies values input and number of participants from each outreach effort. Results from the online survey and posters at community events were combined as both measures include input from tabling at community events. To aid comparison of results, the top three values from each group are highlighted in green in Table 1. Learnings were as follows.

Top values are water quality and reliable delivery—now and in the future. All values resonate well with the community. Average scores for the seven values range from 3.7 to 4.9 on a scale from 1 (not important) to 5 (extremely important), with only climate change scoring below 4.0. Consistent with input from stakeholder interviews, the three most important community values are:

- Provides safe, high-quality water
- Provides enough water for future needs
- Prepares the community for an earthquake or natural disaster

These results are reasonably consistent among the different groups polled.

Cost matters—but water matters more. ‘Delivers the best value for customers’ ranked sixth out of the seven values. The highest this value ranked for any individual outreach effort was fourth—including for groups representing business interests. This doesn’t mean cost isn’t important. It just means that having high-quality, reliable water is more important.

Table 1. Prioritization of Community Values

<i>Value</i>	<i>Overall</i>	<i>Online Survey & Event Posters</i>		<i>Youth Advisory Council</i>	<i>Kiwanis</i>	<i>CERT</i>	<i>Chamber of Commerce</i>
		<i>English</i>	<i>Spanish</i>				
Provides safe, high-quality water	1	1	3	2	2	2	1
Provides enough water for future needs	2	2	5	5	1	3	3
Prepares the community for an earthquake or natural disaster	3	4	6	1	3	1	2
Continues conservation as an important strategy	4	3	4	2	6	4	5
Allows our community to be a good steward of our water and natural resources	5	5	1	5	4	5	7
Delivers the best value for customers	6	6	6	5	4	6	4
Prepares the community for global climate change	7	7	2	4	6	7	5
Total Responses	267	196	18	5	11	28	9

The more community members know, the greater their interest in being prepared for an emergency. As noted in stakeholder interviews, water is not ‘top of mind.’ However, when provided with information, community members are very interested in addressing water system vulnerabilities. Indeed, community members who received the most information (members of community organizations that hosted a PowerPoint presentation) ranked preparedness greater than other surveyed community members. This demonstrates the importance of educating customers on Tualatin’s water challenges and the selected strategy.

Prioritization of values differed between those who responded in Spanish versus English.

Among Spanish-language responses, the top values were environmental— ‘allows our community to be a good steward of our water and natural resources’ and ‘prepares the community for global climate change.’ Both values ranked much lower among English-language responses. This may indicate differences in values prioritization among Tualatin’s Latinx community. However, there was an insufficient number of Spanish-language responses to make that determination with confidence.

Additional Community Input

In addition to requesting input on community values, the online survey included questions about existing supply, emergency preparedness and water supply options. Results for the English- and Spanish-language surveys are provided in Appendix C and D, respectively. Separate results for English- and Spanish-language responses are provided where they differed notably.

Results included:

- Most of the English-language respondents (75%) live in single-family homes. Most Spanish-language respondents (58%) live in apartments or multi-family homes.
- Just over half of all respondents are long-term residents of Tualatin, having resided in Tualatin for 10 years or longer.
- Respondents are very happy with the quality of drinking water they receive from the City of Tualatin. English-language respondents gave an average score of 4.3 on a scale from 1 (poor) to 5 (excellent), with 85% of respondents giving a score of 4 or 5. Spanish-language responses averaged 4.0.
- Respondents are even happier with the water service they receive from the City of Tualatin, with an average score of 4.4 on a scale from 1 (poor) to 5 (excellent) and 87% of respondents giving a score of 4 or 5. Spanish-language responses averaged 4.25.
- Many respondents know the source of their water, with 72% correctly selecting either Bull Run Watershed (City of Portland) or a combination of sources. This level of knowledge was lower but still strong among Spanish-language respondents, with 58% correctly identifying the source. Overall, the high percentage may in part reflect information respondents received at community events or meetings as part of the project prior to completing the survey.
- Respondents are more prepared with emergency water than the project team has observed in similar communities, with almost 20% meeting the recommended quantity (one gallon per person per day) and over 70% having at least some emergency water stored.
- Respondents want to learn more. When asked to select from specific topics, a majority of both English- and Spanish-language respondents indicated interest in learning about emergency preparedness (64%) and drinking water quality (54%). Fewer were interested in learning about conservation (38%) or billing (10%).

- When asked whether they have questions about potential supplies from the Willamette and Clackamas Rivers, 21% of respondents asked a question or provided comment. Top response topics were: 11% expressed specific concerns about one or both sources (more frequently but not always the Willamette), 5% asked general questions about water quality of available options, and 2% asked questions about cost. Spanish-language responses included a single question about water treatment.
- When asked whether they have general questions about Tualatin’s Water Supply Strategy, 32% responded with a question or comment. The top topics were emergency water supply and preparedness (14% of respondents), project timeline (4%), and dislike of the Willamette River as a supply (3%). Two Spanish-language responses were received, on the topics of water quality and a desire to volunteer.

Conclusions

Overall conclusions of the community conversation are as follows:

- Tualatin’s customers are happy with the water and service they receive. Water isn’t top of mind because water is not perceived as a problem.
- The community has a high level of awareness and interest in being prepared for an earthquake or other emergency. With education on the vulnerability of the City’s existing water supply, this interest can translate into support for needed water system improvements.
- Water quality is a top community value. Regardless of the approach recommended in the Water Supply Strategy, the community will want thorough and accurate information on water quality and treatment of backup supplies.
- Some Tualatin residents are adamantly against using treated water from the Willamette River. From online survey responses, the proportion appears small. However, this contingent feels very strongly and is likely to engage with elected officials and the broader community on the Water Supply Strategy.

Community values and other input summarized in this memorandum will guide development of Tualatin’s Water Supply Strategy.

Appendix A

Interviewed Stakeholders

Listed individuals were interviewed as part of the stakeholder interview process for the Tualatin Water Supply Strategy.

<i>Individual</i>	<i>Organization</i>
Frank Bubenik	Tualatin Mayor
Bridget Brooks	Tualatin City Council
Maria Reyes	Tualatin City Council
Robert Kellogg	Tualatin City Council
Bob Ingber	Legacy Meridian Park Medical Center
Paul Morrison	Tualatin City Council
Jon Kawaguchi	Washington County Health Department
Candice Kelly	Tualatin Tomorrow
John Niggley	Lam Research
Linda Moholt	Tualatin Chamber of Commerce
Susan Noack	Tualatin Aging Task Force
Scott Porter	Washington County Emergency Management
Darin Barnard	Tualatin School District
Kate Stoller	Tualatin Valley Fire & Rescue
Charlie Benson	East Tualatin CIO
Cathy Holland	Commercial CIO
Angela DeMeo	Midwest CIO



Appendix B Stakeholder Discussion Guide

The below discussion guide was used to guide stakeholder interviews for the Tualatin Water Supply Strategy. The discussion guide is organized with an introduction, which was read to the interviewees, followed by a series of questions divided into four sections.

Introduction

The City of Tualatin purchases wholesale water from Portland Water Bureau and also operates a well that stores that water and delivers it to the system when needed. These supplies meet the City's daily needs under normal operations but lack system redundancy – during a supply outage or natural disaster the City may be unable to provide water to customers.

There are multiple other supplies available in the region, but the City lacks the infrastructure and agreements to reliably meet emergency needs from those suppliers. Costs to purchase water from Portland are also increasing due to Portland's investment in a new filtration plant.

The goal of the Water Supply Strategy is to evaluate Tualatin's water needs under normal and emergency operations and identify the best approach to reliably meet those needs in the future. The City is seeking your advice on its decisions for the future.

Stakeholder Questions

Introductory Questions

1. Have you been involved with previous evaluations of City of Tualatin's water supply source? (How?)
2. What's your understanding of the water supply situation for Tualatin? (Currently, and for the future?)
3. What's the current level of public awareness of the City's long-term water supply needs and source options?

Issues

4. What values or principles should guide decisions about Tualatin's Water Supply Strategy? (What factors should be considered in evaluating / choosing supply options?)
5. What issues do you expect will arise as the City involves customers in decisions on future water supply sources?
6. What persons or groups do you anticipate will be most interested? What will be their interests?
7. Cost and impact on rates are issues often raised in public when water suppliers consider water supply options. Do you expect that issue could arise here? (Explain.)

8. Some years ago, the City Council adopted a charter amendment that prohibits use of the Willamette River as a water source, even during emergencies. What's your view now on that chart amendment?

Water Supply Sources

9. There are several regional water supply sources serving communities around Tualatin. Do you have any questions, suggestions or concerns on these possible sources?
 - Portland / Bull Run
 - Willamette River at Wilsonville
 - Joint Water Commission (Tualatin, Hagg Lake)
 - Clackamas River
 - Other sources

Communications

10. What is the best way to communicate with customers about the City's Water Supply Strategy? Which sources do customers rely on as the most credible places to get information? What events are coming up where we could share information about the project?
11. What information will be of greatest interest to customers? What questions would you anticipate?
12. What key messages should customers understand about the City's future water needs and supply options?

Wrap-Up

13. If you were asked to provide your single most important piece of advice for Tualatin's Water Supply Strategy, what would it be?
14. Any further comments or suggestions?

Appendix C.1

English-Language Survey Results

The online survey was conducted using SurveyMonkey in 2019. Survey responses to individual multiple choice and ranking questions are attached. The survey also included two open ended responses:

- Q7. Two of the backup sources that may be available to Tualatin are water from the Clackamas River treated at the Lake Oswego Tigard Water Treatment Plant and water from the Willamette River treated at filtration plants in Wilsonville and Sherwood. Do you have any questions about these sources?
- Q10. What questions do you have about our community's Water Supply Strategy?

Responses received for the two open-ended questions were coded by topic; those topics are summarized in Tables C.1 and C.2 respectively.

Table C.1. Open-Ended Responses on Willamette and Clackamas River Sources¹

<i>Topic</i>	<i>Number Of Responses</i>	<i>Examples</i>
Specific concerns about the Willamette or Clackamas River sources	22	Is Willamette River water safe? In the past, there has been problems with upstream pollution and pesticide runoff into the river. Have these been properly taken care of? My family and I will not drink water from filtration plants. I will use bottled water!
Water quality	10	How does the quality of water from these sources compare to our current water source?
Cost	4	Will it change my water bill?
Fluoride	3	Is the water fluorinated? Would like to have fluorinated water if possible, even though we do not now. Can we get the fluoride out if our water supply? It's a neurotoxin and it's poison.
Desire for additional information	3	Please provide more information to the residents of Tualatin.
Being prepared for emergencies	2	If we get hit with the big earthquake, which would provide a more reliable water source?

¹ Full text of Question 7 was: Two of the backup sources that may be available to Tualatin are water from the Clackamas River treated at the Lake Oswego Tigard Water Treatment Plant and water from the Willamette River treated at filtration plants in Wilsonville and Sherwood. Do you have any questions about these sources?

Table C.2. Open-Ended Responses on Questions about the Water Supply Strategy¹

<i>Topic</i>	<i>Number Of Responses</i>	<i>Example</i>
Emergency Water Supply and Preparedness	26	Great to be looking for backup sources in case of natural disaster. Loss &/or lack of water in an emergency is real concern for our family.
Project Timeline and Results	7	What is the timeline for figuring out the solution to a backup water source?
Concerns about Willamette River water	6	What is the strategy for safe clean water other than Willamette River water?
Water quality, taste or lead	5	Testing for Lead and other contaminants?
Water conservation and reuse	4	What incentives at a residential level can be done to encourage greywater use or water-on-site reuse to reduce the impact of water needs and sewer flow?
Cost	4	How much will it cost customers long term?
Support for continued Portland supply	2	Bull Run Water is a big plus and Portland has groundwater to supplement.
Fluoride	2	Are we getting the fluoride out of our water?
Climate change	1	How to adapt to climate crisis and rapid changes.
Other	8	Where does the current water supply for the City of Tualatin come from?

¹ Full text of Question 10 was: What questions do you have about our community's Water Supply Strategy?

Q1 Which best describes you?

Answered: 191 Skipped: 1

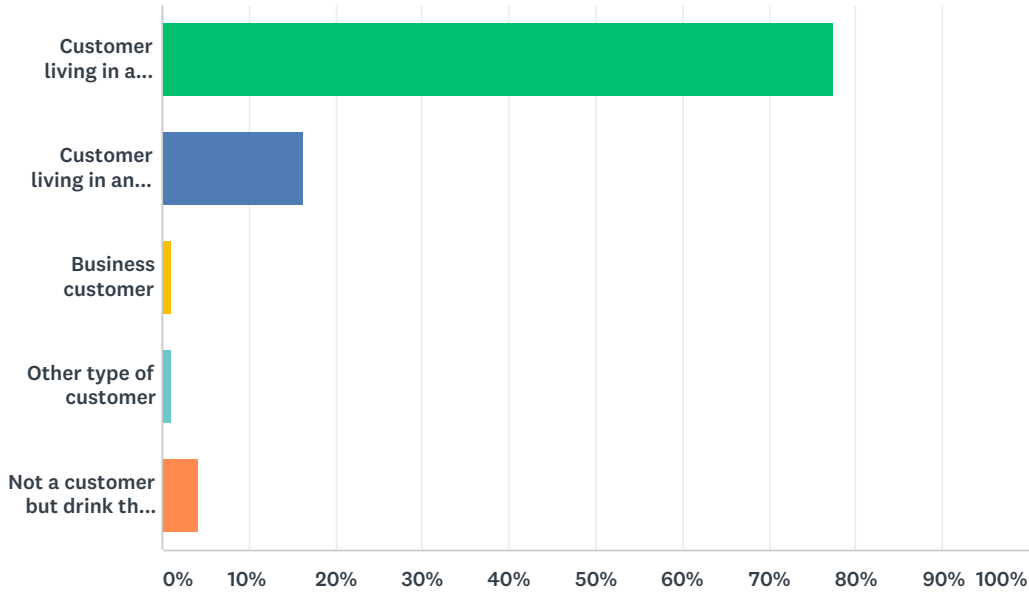

ANSWER CHOICES	RESPONSES	
Customer living in a single-family home	77.49%	148
Customer living in an apartment or multi-family residence	16.23%	31
Business customer	1.05%	2
Other type of customer	1.05%	2
Not a customer but drink the water	4.19%	8
TOTAL		191

Q2 How long have you lived in Tualatin?

Answered: 192 Skipped: 0

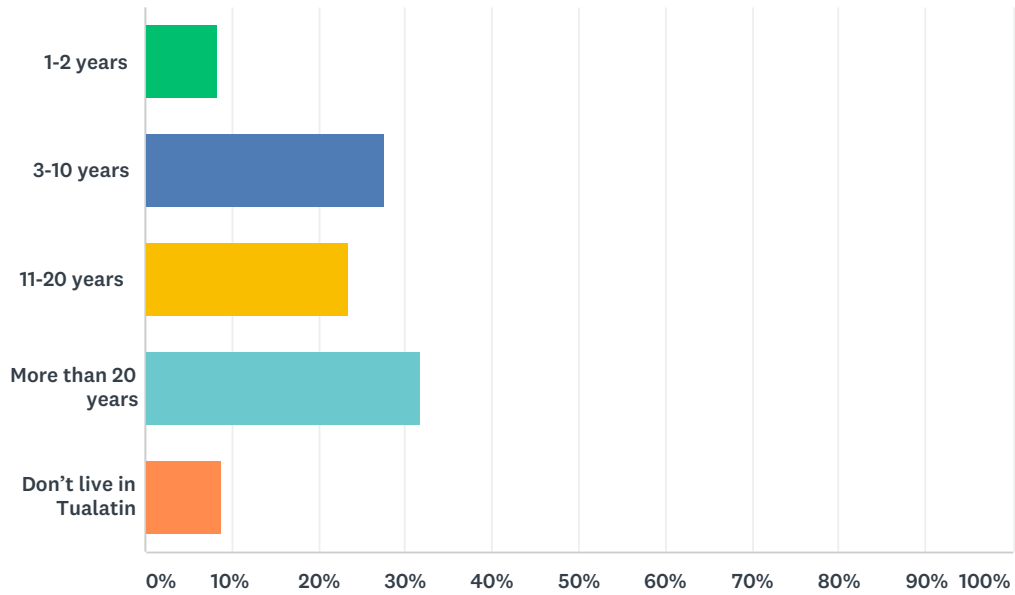

ANSWER CHOICES	RESPONSES	
1-2 years	8.33%	16
3-10 years	27.60%	53
11-20 years	23.44%	45
More than 20 years	31.77%	61
Don't live in Tualatin	8.85%	17
TOTAL		192

Q3 How would you rate the quality of the drinking water you receive from the City of Tualatin?

Answered: 189 Skipped: 3

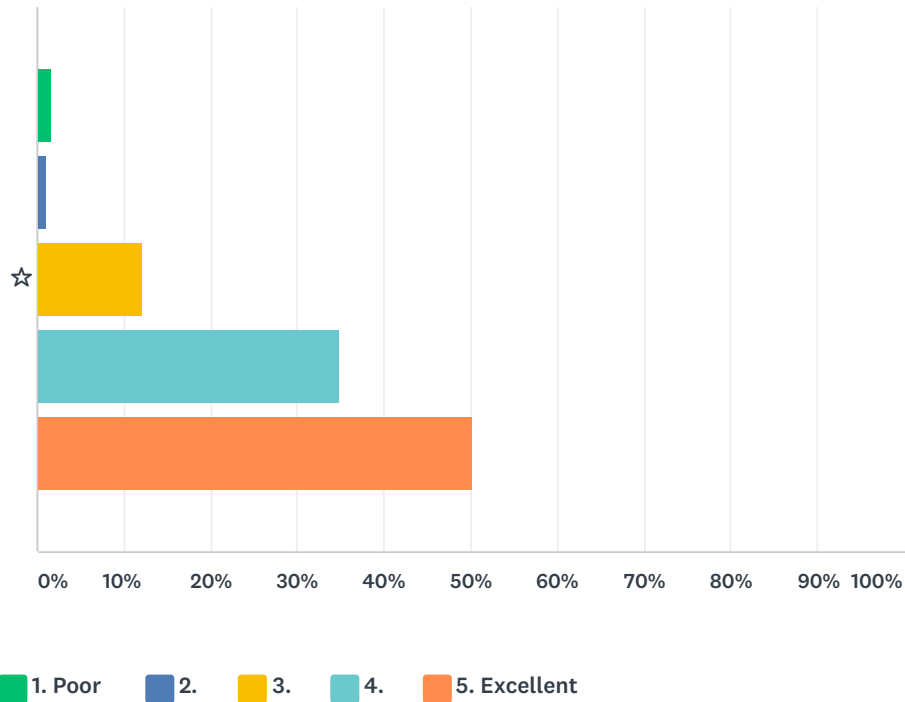

	1. POOR	2.	3.	4.	5. EXCELLENT	TOTAL	WEIGHTED AVERAGE
☆	1.59% 3	1.06% 2	12.17% 23	34.92% 66	50.26% 95	189	4.31

Q4 How would you rate the water service you receive from the City of Tualatin?

Answered: 188 Skipped: 4

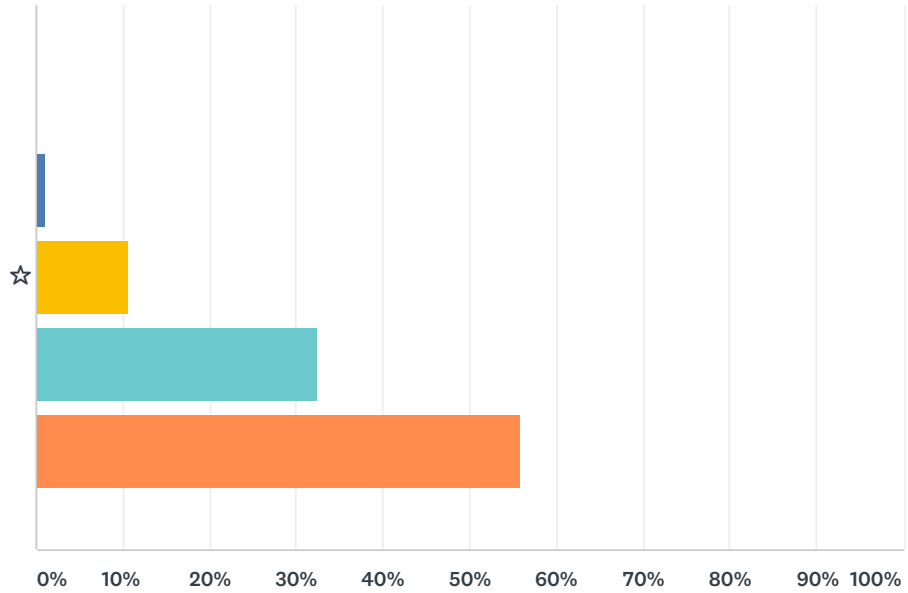

■ 1. Poor
 ■ 2.
 ■ 3.
 ■ 4.
 ■ 5. Excellent

	1. POOR	2.	3.	4.	5. EXCELLENT	TOTAL	WEIGHTED AVERAGE
☆	0.00%	1.06%	10.64%	32.45%	55.85%	188	4.43
	0	2	20	61	105		

Q5 Do you know the main source of Tualatin's drinking water?

Answered: 192 Skipped: 0

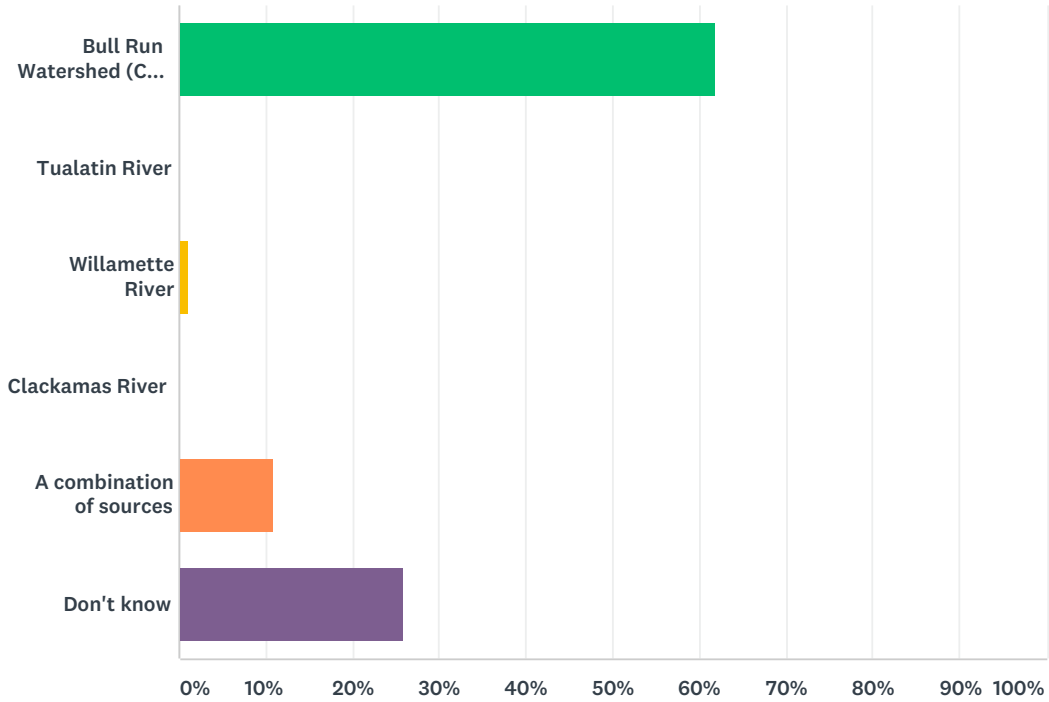

ANSWER CHOICES	RESPONSES	
Bull Run Watershed (City of Portland)	61.98%	119
Tualatin River	0.00%	0
Willamette River	1.04%	2
Clackamas River	0.00%	0
A combination of sources	10.94%	21
Don't know	26.04%	50
TOTAL		192

Q6 Tualatin is a City of Portland wholesale customer. We purchase all of our water from the City of Portland. Portland's primary source of water is the Bull Run Watershed. Tualatin currently does not have a backup source of drinking water which leaves us vulnerable if the supply from Portland is interrupted due to a pipeline break or a natural disaster. How important are the following values when considering possible backup sources?

Answered: 192 Skipped: 0

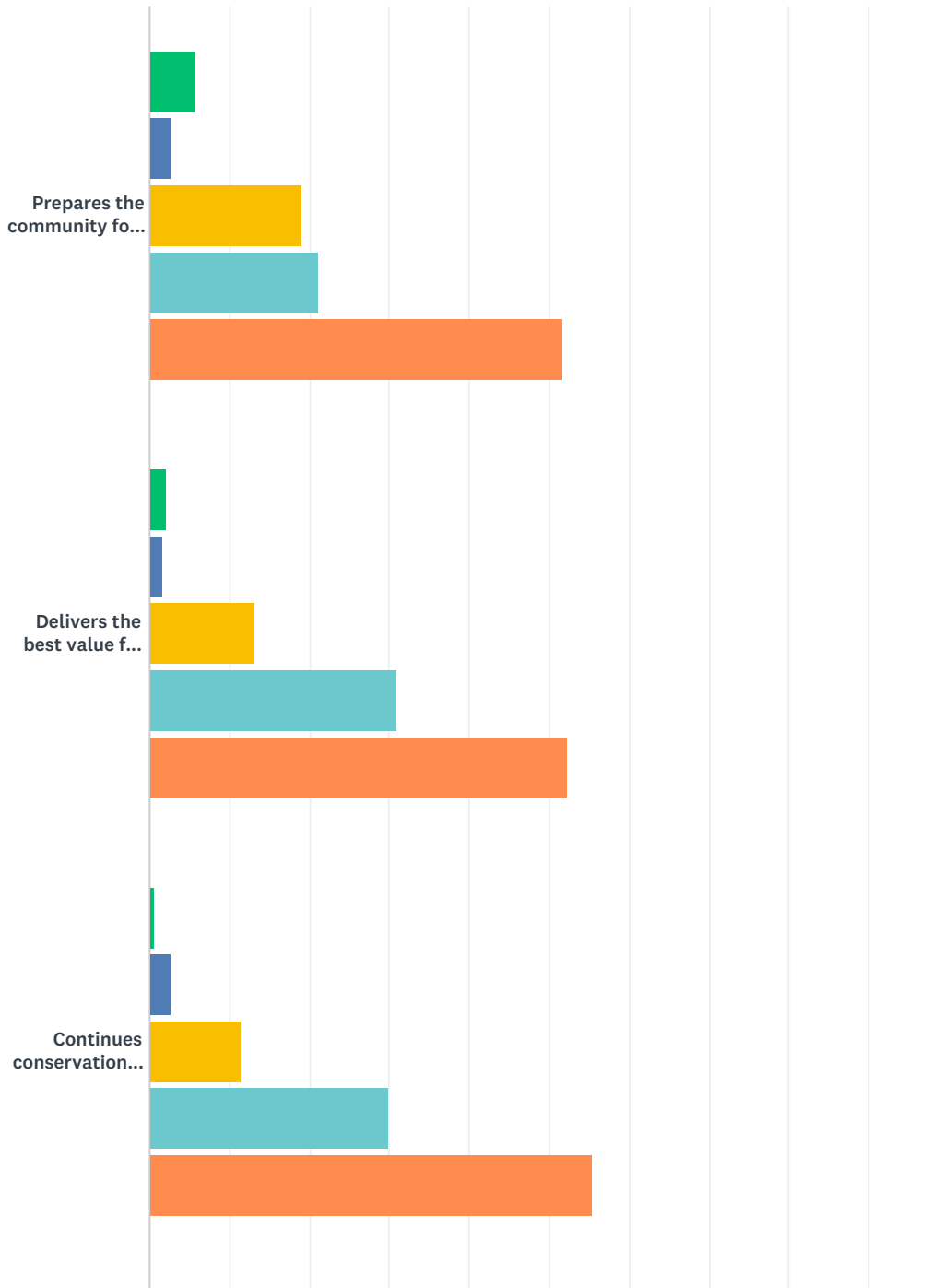

City of Tualatin Securing Our Drinking Water Future

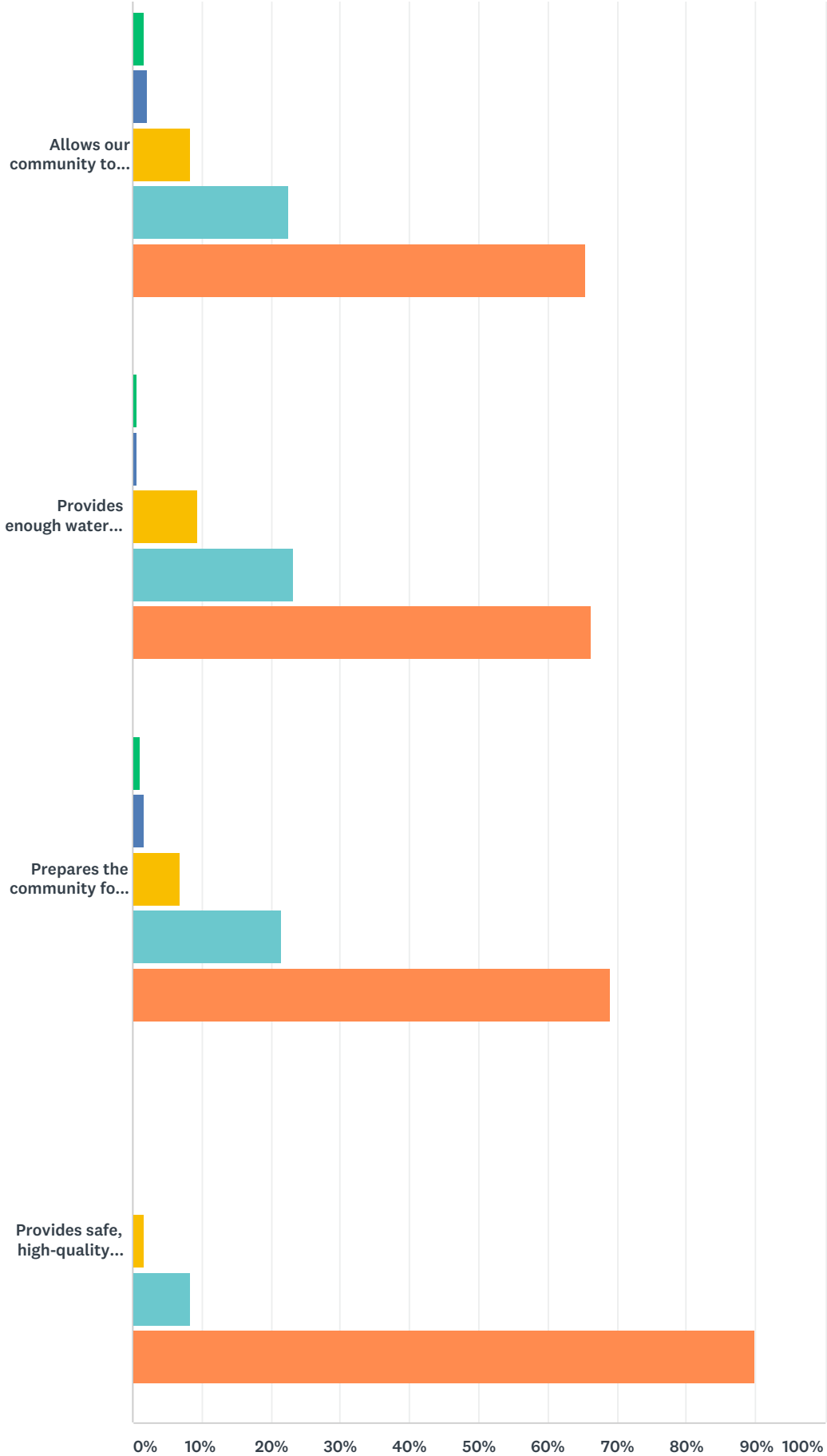

City of Tualatin Securing Our Drinking Water Future

■ 1. Not important
 ■ 2.
 ■ 3.
 ■ 4.
 ■ 5. Very important

	1. NOT IMPORTANT (1)	2. (2)	3. (3)	4. (4)	5. VERY IMPORTANT (5)	TOTAL
Prepares the community for global climate change	5.79% 11	2.63% 5	18.95% 36	21.05% 40	51.58% 98	190
Delivers the best value for customers	2.09% 4	1.57% 3	13.09% 25	30.89% 59	52.36% 100	191
Continues conservation as an important water supply strategy	0.52% 1	2.62% 5	11.52% 22	29.84% 57	55.50% 106	191
Allows our community to be a good steward of our water and natural resources	1.57% 3	2.09% 4	8.38% 16	22.51% 43	65.45% 125	191
Provides enough water for future needs	0.53% 1	0.53% 1	9.47% 18	23.16% 44	66.32% 126	190
Prepares the community for an earthquake or other natural disasters	1.05% 2	1.58% 3	6.84% 13	21.58% 41	68.95% 131	190
Provides safe, high-quality water	0.00% 0	0.00% 0	1.57% 3	8.38% 16	90.05% 172	191

BASIC STATISTICS						
	MINIMUM	MAXIMUM	MEDIAN	MEAN	STANDARD DEVIATION	
Provides enough water for future needs	1.00	5.00	5.00	4.54		0.73
Continues conservation as an important water supply strategy	1.00	5.00	5.00	4.37		0.83
Prepares the community for global climate change	1.00	5.00	5.00	4.10		1.15
Prepares the community for an earthquake or other natural disasters	1.00	5.00	5.00	4.56		0.78
Provides safe, high-quality water	3.00	5.00	5.00	4.88		0.37
Delivers the best value for customers	1.00	5.00	5.00	4.30		0.90
Allows our community to be a good steward of our water and natural resources	1.00	5.00	5.00	4.48		0.86

Q7 Two of the backup sources that may be available to Tualatin are water from the Clackamas River treated at the Lake Oswego Tigard Water Treatment Plant and water from the Willamette River treated at filtration plants in Wilsonville and Sherwood. Do you have any questions about these sources?

Answered: 189 Skipped: 3

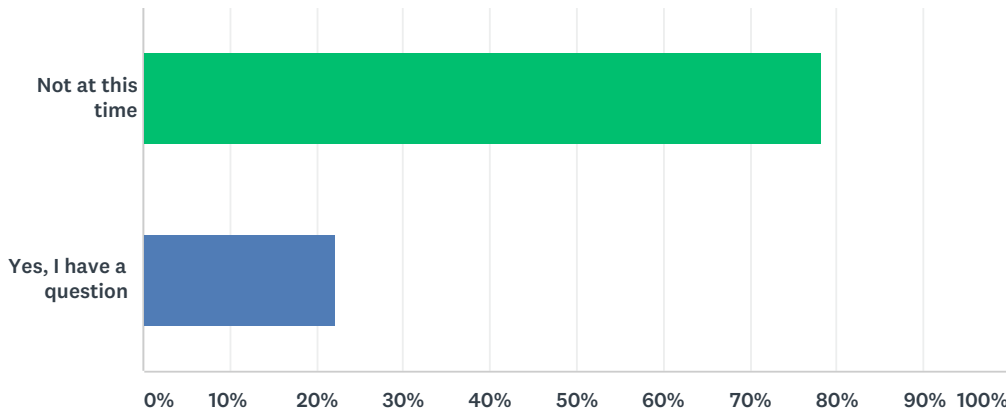

ANSWER CHOICES	RESPONSES	
Not at this time	78.31%	148
Yes, I have a question	22.22%	42
Total Respondents: 189		

Q8 Do you have emergency water stored at home? You need at least one gallon per person or pet per day for 14 days. That amount assumes you will use about half a gallon for drinking and another half-gallon to meet sanitation and food preparation needs.

Answered: 192 Skipped: 0

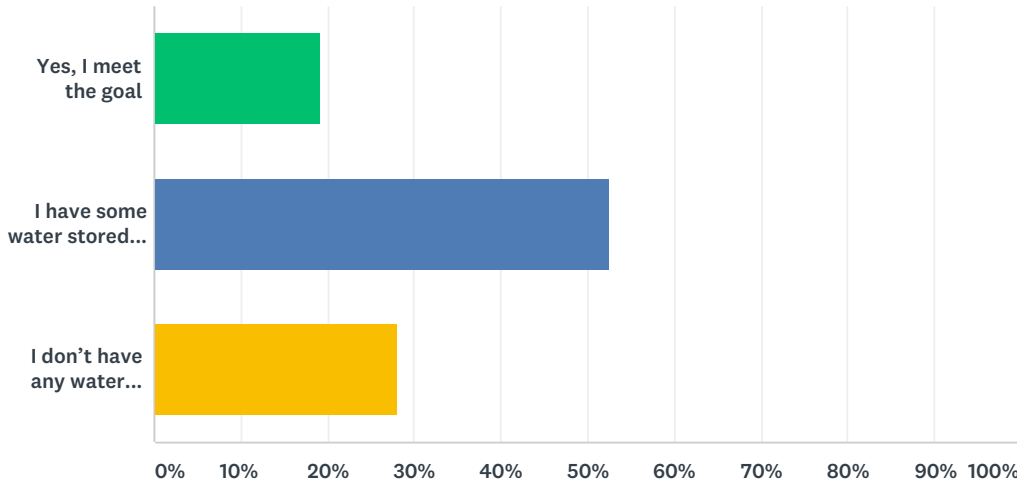

ANSWER CHOICES	RESPONSES	
Yes, I meet the goal	19.27%	37
I have some water stored, but not enough	52.60%	101
I don't have any water stored	28.13%	54
TOTAL		192

Q9 What topics would you like to learn more about? (Select all that apply)

Answered: 161 Skipped: 31

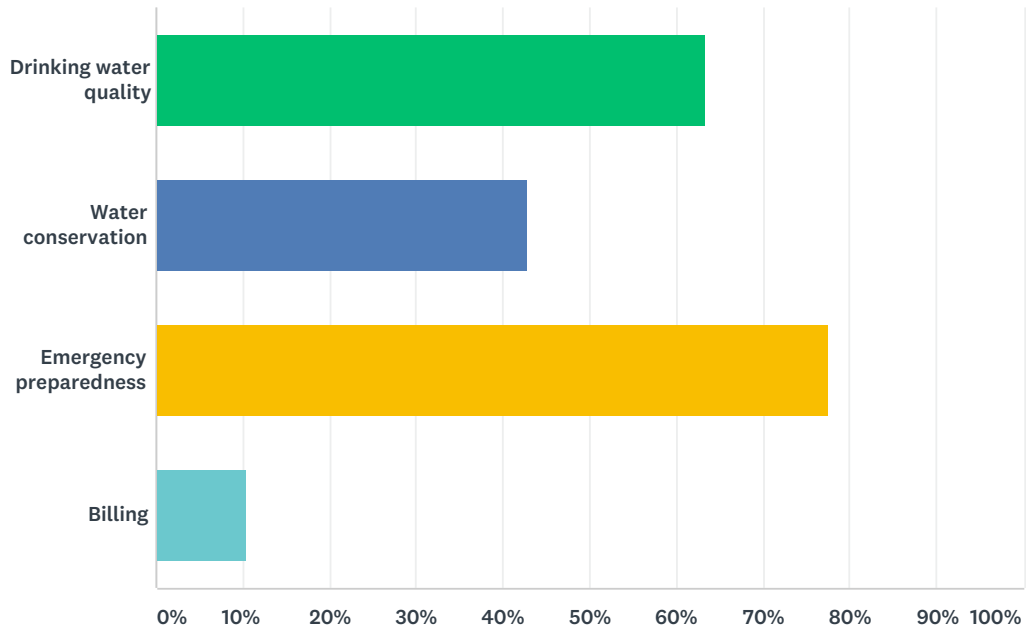

ANSWER CHOICES	RESPONSES	
Drinking water quality	63.35%	102
Water conservation	42.86%	69
Emergency preparedness	77.64%	125
Billing	10.56%	17
Total Respondents: 161		

Q10 What questions do you have about our community's Water Supply Strategy?

Answered: 91 Skipped: 101

**Q11 Enter your name in the drawing for an emergency preparedness kit!
We will not share your email with other organizations.**

Answered: 155 Skipped: 37

ANSWER CHOICES	RESPONSES	
Name	100.00%	155
Company	21.94%	34
Address	0.00%	0
Address 2	0.00%	0
City/Town	96.77%	150
State/Province	0.00%	0
ZIP/Postal Code	97.42%	151
Country	0.00%	0
Email Address	98.06%	152
Phone Number	0.00%	0

Appendix D

Spanish-Language Survey Results

The online survey was conducted using SurveyMonkey in 2019. Survey responses to all questions are attached.

Q1 ¿Cuál es la mejor descripción de usted?

Answered: 12 Skipped: 0

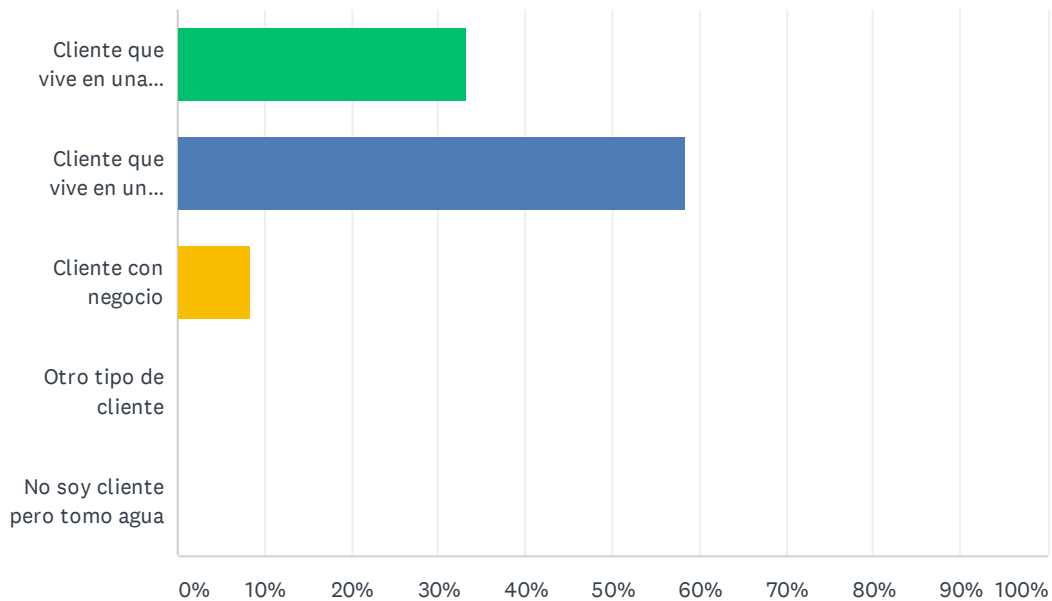

ANSWER CHOICES	RESPONSES	
Cliente que vive en una casa unifamiliar	33.33%	4
Cliente que vive en un apartamento o residencia multifamiliar	58.33%	7
Cliente con negocio	8.33%	1
Otro tipo de cliente	0.00%	0
No soy cliente pero tomo agua	0.00%	0
TOTAL		12

Q2 ¿Cuánto tiempo lleva viviendo en Tualatin?

Answered: 12 Skipped: 0

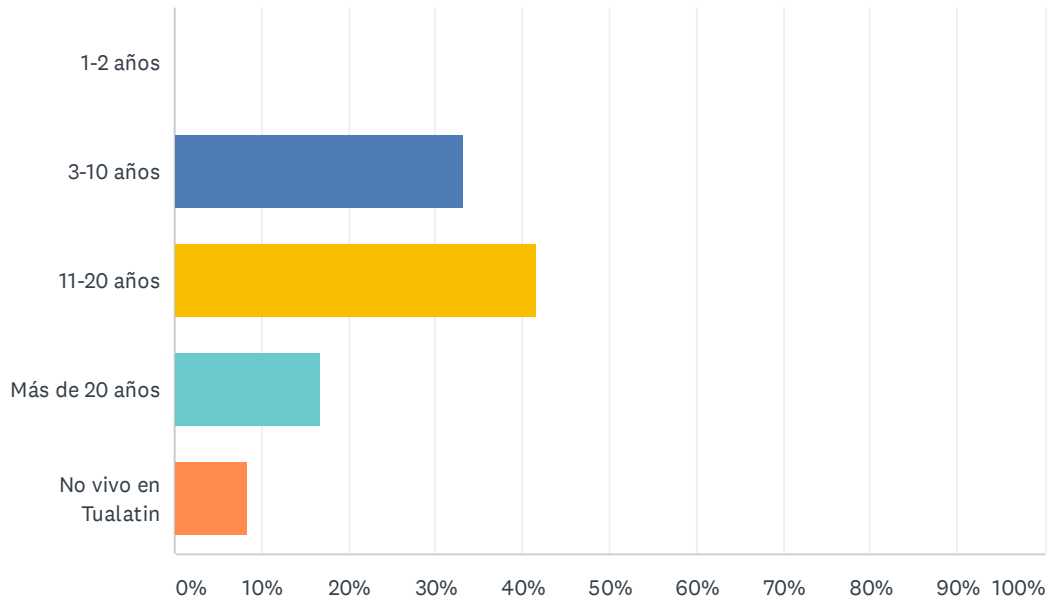

ANSWER CHOICES	RESPONSES	
1-2 años	0.00%	0
3-10 años	33.33%	4
11-20 años	41.67%	5
Más de 20 años	16.67%	2
No vivo en Tualatin	8.33%	1
TOTAL		12

Q3 ¿Cómo calificaría usted la calidad del agua potable que recibe de la Ciudad de Tualatin?

Answered: 12 Skipped: 0

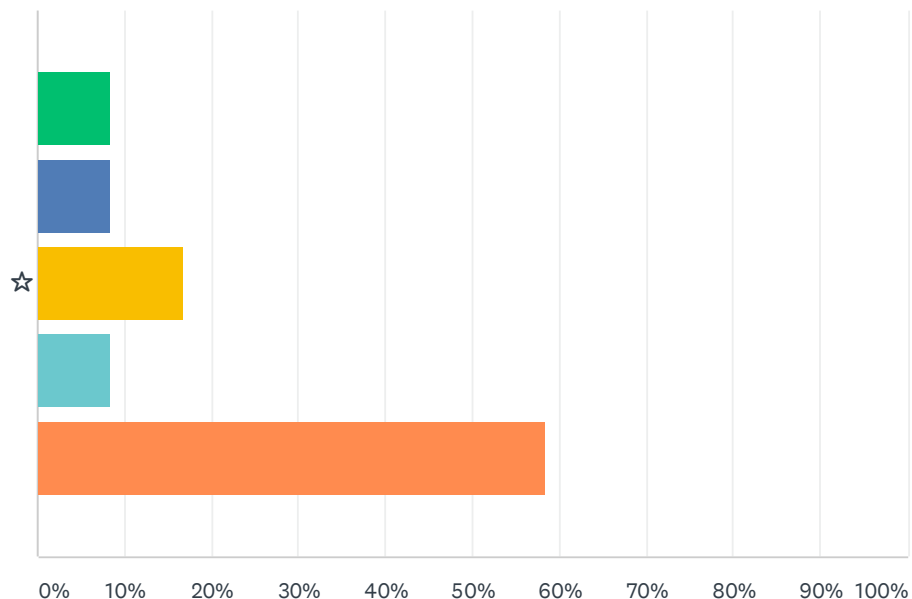

■ 1. Pobre
 ■ 2.
 ■ 3.
 ■ 4.
 ■ 5. Excelente

	1. POBRE	2.	3.	4.	5. EXCELENTE	TOTAL	WEIGHTED AVERAGE
☆	8.33% 1	8.33% 1	16.67% 2	8.33% 1	58.33% 7	12	4.00

Q4 ¿Cómo calificaría usted el servicio de agua que recibe de la Ciudad de Tualatin?

Answered: 12 Skipped: 0

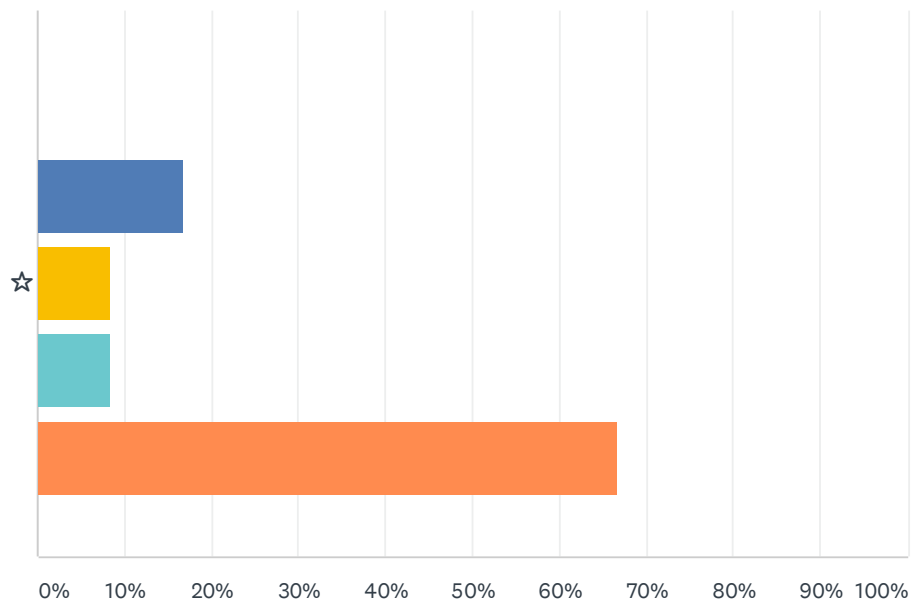

■ 1. Pobre
 ■ 2.
 ■ 3.
 ■ 4.
 ■ 5. Excelente

	1. POBRE	2.	3.	4.	5. EXCELENTE	TOTAL	WEIGHTED AVERAGE
☆	0.00% 0	16.67% 2	8.33% 1	8.33% 1	66.67% 8	12	4.25

Q5 ¿Sabe usted cuál es la fuente principal de agua potable de Tualatin?

Answered: 12 Skipped: 0

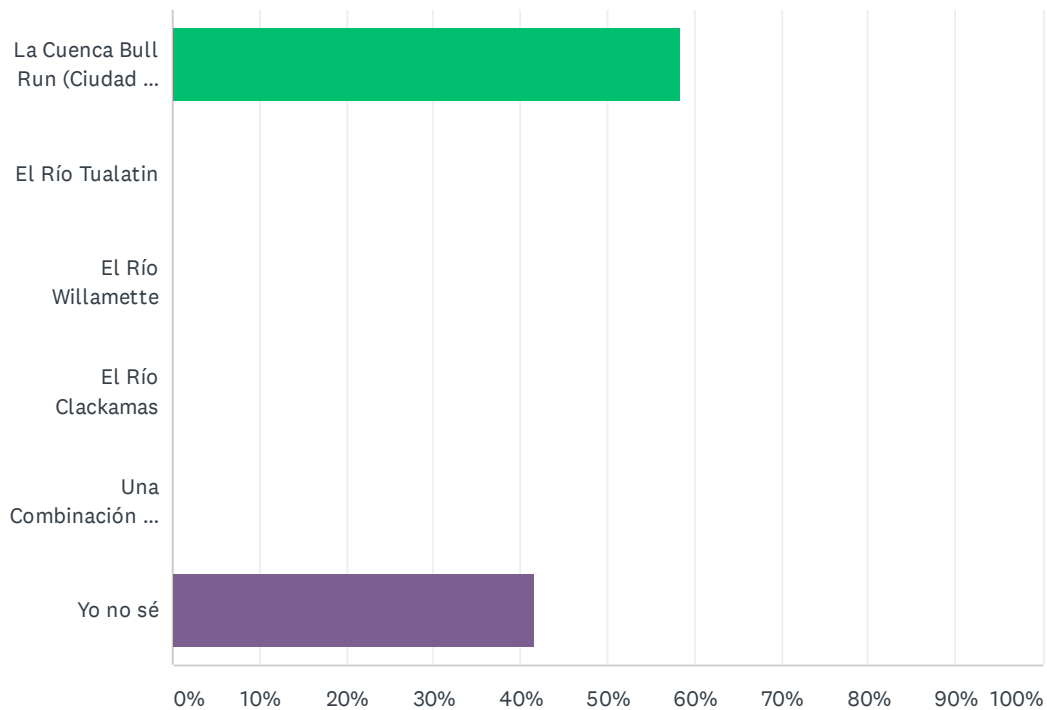

ANSWER CHOICES	RESPONSES	
La Cuenca Bull Run (Ciudad de Portland)	58.33%	7
El Río Tualatin	0.00%	0
El Río Willamette	0.00%	0
El Río Clackamas	0.00%	0
Una Combinación de Fuentes	0.00%	0
Yo no sé	41.67%	5
TOTAL		12

Q6 Tualatin es un cliente mayorista de la ciudad de Portland. Compramos toda nuestra agua de la ciudad de Portland. La principal fuente de agua de Portland es la Cuenca Bull Run. Tualatin actualmente no cuenta con una fuente alternativa de agua potable, lo que nos deja vulnerables si se interrumpe el suministro de Portland debido a una rotura de la tubería o a un desastre natural. ¿Qué importancia tienen para usted los siguientes valores al considerar posibles fuentes alternativas?

Answered: 12 Skipped: 0

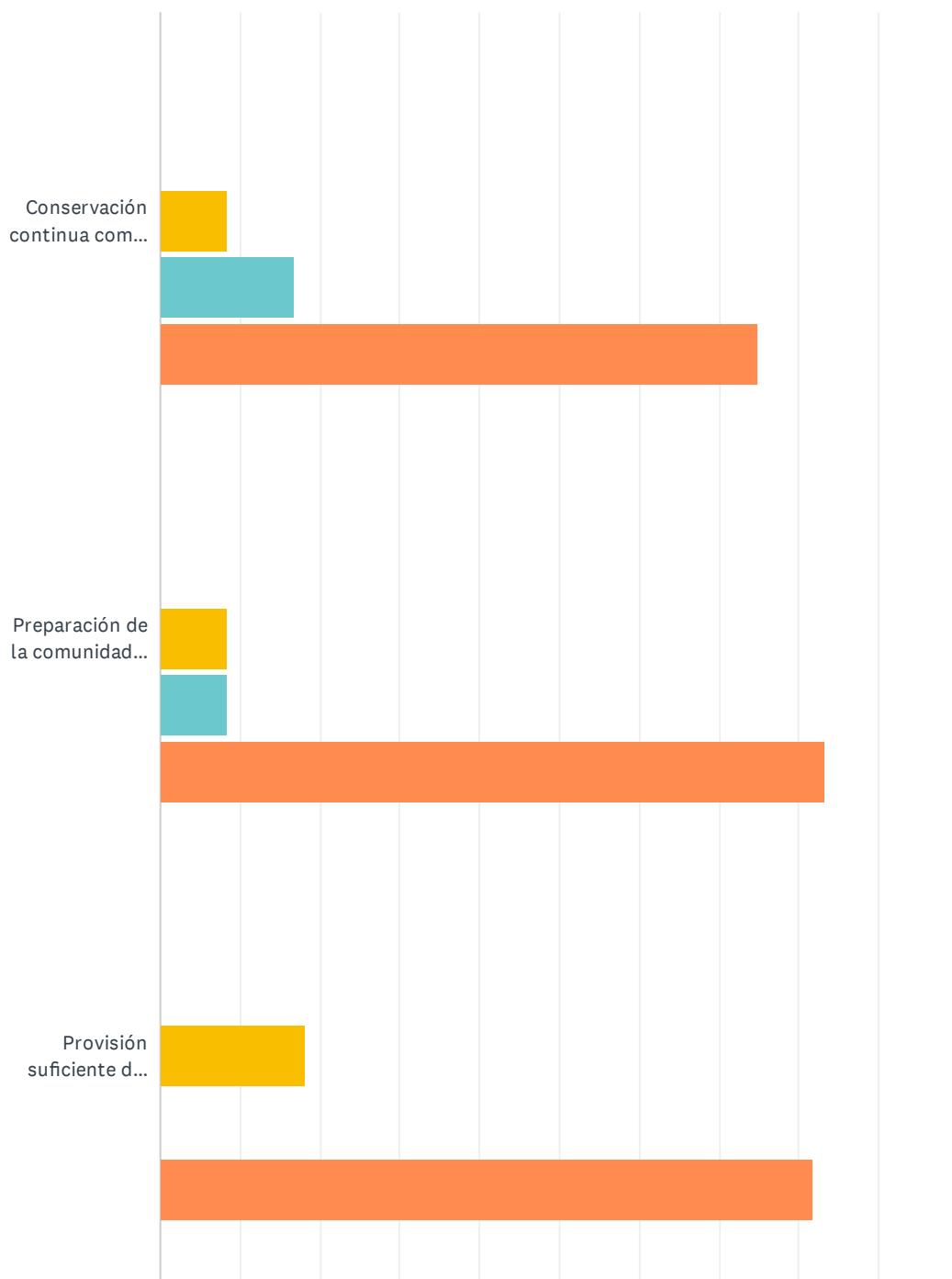

Ciudad de Tualatin Asegurando el Futuro de Nuestra Agua Potable

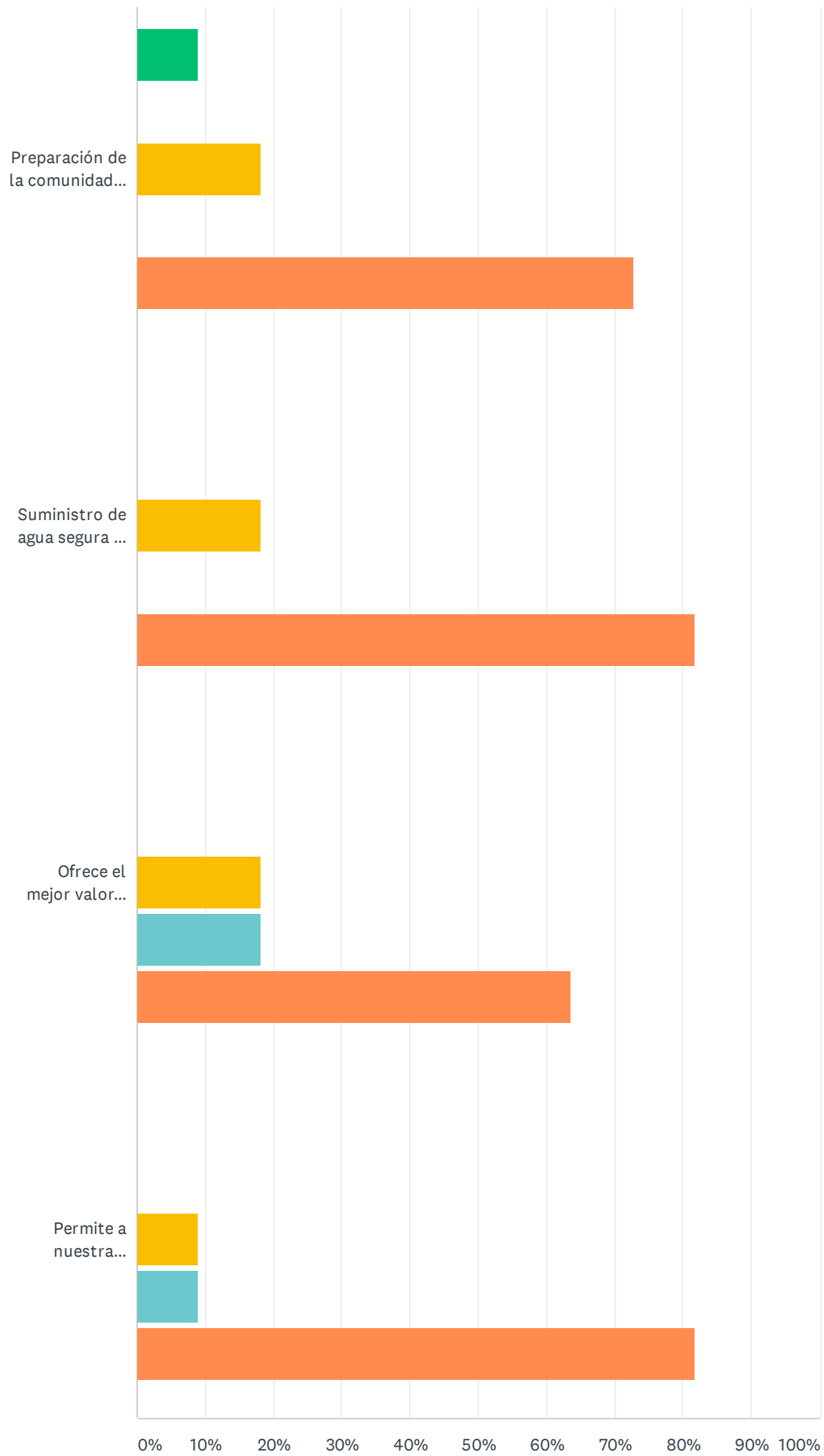

Ciudad de Tualatin Asegurando el Futuro de Nuestra Agua Potable

■ 1. No es importante
 ■ 2.
 ■ 3.
 ■ 4.
 ■ 5. Es muy importante

	1. NO ES IMPORTANTE (1)	2. (2)	3. (3)	4. (4)	5. ES MUY IMPORTANTE (5)	TOTAL
Conservación continua como una importante estrategia de la provisión del agua	0.00% 0	0.00% 0	8.33% 1	16.67% 2	75.00% 9	12
Preparación de la comunidad para el cambio climático global	0.00% 0	0.00% 0	8.33% 1	8.33% 1	83.33% 10	12
Provisión suficiente de agua para futuras necesidades	0.00% 0	0.00% 0	18.18% 2	0.00% 0	81.82% 9	11
Preparación de la comunidad para terremotos u otros desastres naturales	9.09% 1	0.00% 0	18.18% 2	0.00% 0	72.73% 8	11
Suministro de agua segura y de alta calidad	0.00% 0	0.00% 0	18.18% 2	0.00% 0	81.82% 9	11
Ofrece el mejor valor para los clientes	0.00% 0	0.00% 0	18.18% 2	18.18% 2	63.64% 7	11
Permite a nuestra comunidad ser buena administradora de nuestra agua y de nuestros recursos naturales	0.00% 0	0.00% 0	9.09% 1	9.09% 1	81.82% 9	11

BASIC STATISTICS					
	MINIMUM	MAXIMUM	MEDIAN	MEAN	STANDARD DEVIATION
Preparación de la comunidad para terremotos u otros desastres naturales	1.00	5.00	5.00	4.27	1.29
Ofrece el mejor valor para los clientes	3.00	5.00	5.00	4.45	0.78
Provisión suficiente de agua para futuras necesidades	3.00	5.00	5.00	4.64	0.77
Suministro de agua segura y de alta calidad	3.00	5.00	5.00	4.64	0.77
Conservación continua como una importante estrategia de la provisión del agua	3.00	5.00	5.00	4.67	0.62
Permite a nuestra comunidad ser buena administradora de nuestra agua y de nuestros recursos naturales	3.00	5.00	5.00	4.73	0.62
Preparación de la comunidad para el cambio climático global	3.00	5.00	5.00	4.75	0.60

Q7 Dos de las fuentes alternativas que podrían estar disponibles para Tualatin son el agua del Río Clackamas tratada en la planta de tratamiento del agua de Lake Oswego en Tigard y el agua del Río Willamette tratada en las plantas de filtración en Wilsonville y Sherwood. ¿Tiene alguna pregunta sobre estas fuentes?

Answered: 11 Skipped: 1

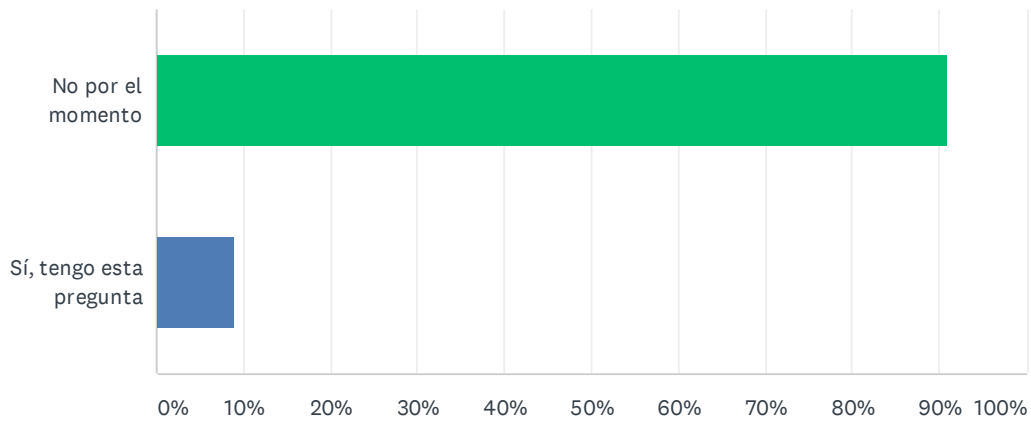

ANSWER CHOICES	RESPONSES
No por el momento	90.91% 10
Sí, tengo esta pregunta	9.09% 1
Total Respondents: 11	

#	SÍ, TENGO ESTA PREGUNTA	DATE
1	Como tratanel agua.	9/14/2019 3:34 PM

Q8 ¿Tiene usted agua almacenada en su casa en caso de alguna emergencia? Necesita tener al menos un galón por persona o por mascota por día durante 14 días. Esa cantidad supone que usted utilizará aproximadamente medio galón para beber y otro medio galón para satisfacer las necesidades de higiene y preparación de los alimentos.

Answered: 12 Skipped: 0

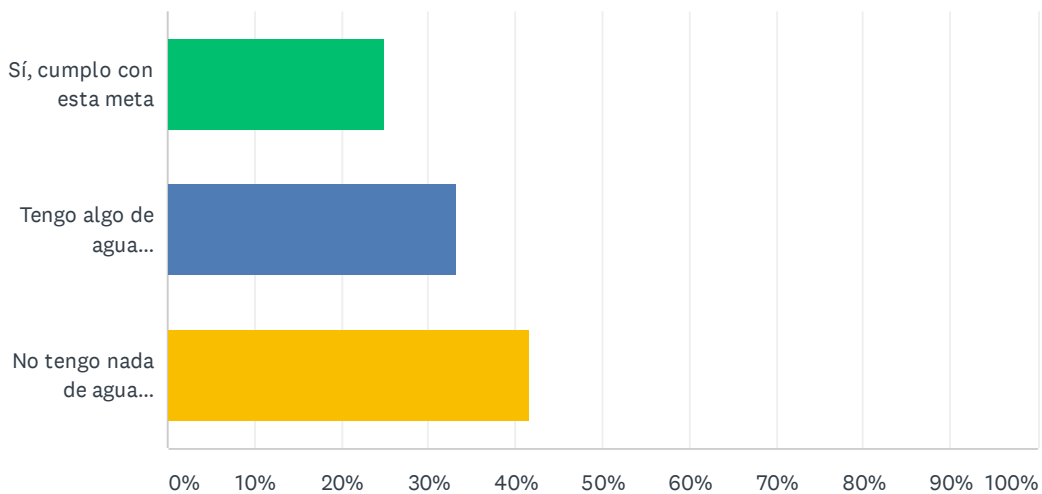

ANSWER CHOICES	RESPONSES
Sí, cumplo con esta meta	25.00% 3
Tengo algo de agua almacenada, pero no la suficiente	33.33% 4
No tengo nada de agua almacenada	41.67% 5
TOTAL	12

Q9 ¿Sobre qué otros temas le gustaría a usted saber más? (Seleccione usted todos los que se le apliquen)

Answered: 12 Skipped: 0

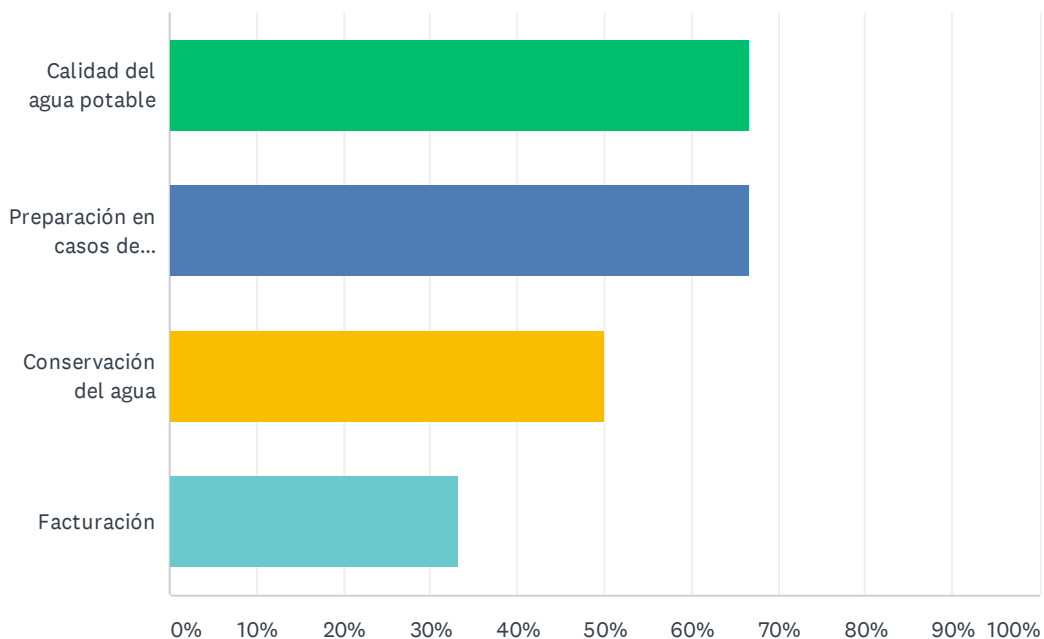

ANSWER CHOICES	RESPONSES
Calidad del agua potable	66.67% 8
Preparación en casos de emergencia	66.67% 8
Conservación del agua	50.00% 6
Facturación	33.33% 4
Total Respondents: 12	

Q10 ¿Qué otras preguntas tiene usted acerca de la estrategia del suministro de agua de nuestra comunidad?

Answered: 2 Skipped: 10

#	RESPONSES	DATE
1	Me gustaria saber si el agua potable es Buena para Tomar sin filtrar .¿	9/14/2019 4:47 PM
2	Me gustaria ser voluntario y ayudar con eventos y proyectos que van a hacer en el futuro.	8/6/2019 7:24 PM

Q11 ¡Participe escribiendo su nombre en el dibujo para un paquete de preparación en caso de alguna emergencia! No compartiremos su correo electrónico con otras organizaciones.

Answered: 12 Skipped: 0

ANSWER CHOICES	RESPONSES	
Nombre	100.00%	12
Compañía	33.33%	4
Address	0.00%	0
Address 2	0.00%	0
Ciudad/Pueblo	75.00%	9
State/Province	0.00%	0
Código Postal	58.33%	7
Country	0.00%	0
Correo Electrónico	50.00%	6
Phone Number	0.00%	0

#	NOMBRE	DATE
1	Edith Romero	9/14/2019 4:47 PM
2	Magdalena Torres	9/14/2019 3:34 PM
3	Lorenzo	9/14/2019 3:02 PM
4	Pedro Del Campo	9/14/2019 2:50 PM
5	Alva Rebolledo	9/14/2019 2:43 PM
6	Tavita rubio	9/14/2019 2:31 PM
7	Elizabeth	8/6/2019 7:35 PM
8	Omar lopez	8/6/2019 7:24 PM
9	Irania Roque	8/6/2019 7:09 PM
10	Jennypastrana	8/6/2019 7:02 PM
11	Armando Perez	8/6/2019 6:54 PM
12	Jesus vitela	8/6/2019 6:34 PM
#	COMPAÑÍA	DATE
1	971 732 09 13	9/14/2019 4:47 PM
2	5039987736	9/14/2019 3:02 PM
3	831-234-7247	9/14/2019 2:50 PM
4	AAA / Oregon	8/6/2019 6:34 PM

Ciudad de Tualatin Asegurando el Futuro de Nuestra Agua Potable

#	ADDRESS	DATE
	There are no responses.	
#	ADDRESS 2	DATE
	There are no responses.	
#	CIUDAD/PUEBLO	DATE
1	Tualatin	9/14/2019 4:47 PM
2	Tualatin	9/14/2019 3:34 PM
3	Tigard	9/14/2019 2:50 PM
4	Tualatin	9/14/2019 2:43 PM
5	Tualatin	9/14/2019 2:31 PM
6	Tualatin	8/6/2019 7:35 PM
7	Tualatin	8/6/2019 7:24 PM
8	Tualatin or	8/6/2019 6:54 PM
9	Tualatin	8/6/2019 6:34 PM
#	STATE/PROVINCE	DATE
	There are no responses.	
#	CÓDIGO POSTAL	DATE
1	97062	9/14/2019 4:47 PM
2	97062	9/14/2019 3:34 PM
3	97062	9/14/2019 2:43 PM
4	97062	9/14/2019 2:31 PM
5	97062	8/6/2019 7:35 PM
6	97062	8/6/2019 7:24 PM
7	97062	8/6/2019 6:54 PM
#	COUNTRY	DATE
	There are no responses.	
#	CORREO ELECTRÓNICO	DATE
1	torrez0403@comcast.net	9/14/2019 3:34 PM
2	uzimeldy@icloud.com	9/14/2019 2:43 PM
3	elizabethmoreno24@hotmail.com	8/6/2019 7:35 PM
4	503 9751588	8/6/2019 7:24 PM
5	willsonville97062@gmail.com	8/6/2019 6:54 PM
6	jesus1998us@yahoo.com	8/6/2019 6:34 PM
#	PHONE NUMBER	DATE
	There are no responses.	

Attachment B

Regional Water Opportunities

Regional Water Opportunities

Introduction

This attachment documents additional detail on current and potential supply connections that could be used in an emergency, in support of the Water Supply Strategy. Representatives from the City of Tualatin, The Formation Lab, and Murraysmith met with representatives from six local agencies: Portland Water Bureau, Tualatin Valley Water District (TVWD) and the Cities of Tigard, Lake Oswego, Sherwood and Wilsonville. A summary of existing and potential future water supply options based on the meetings with these providers is summarized in this memorandum.

Interviewed water agencies were also asked about their capacity to potentially provide long-term supply in the future. The intent was not to initiate a change in Tualatin's water supply, but instead to understand water supply availability in the region if Portland's water were to become unavailable or unaffordable. Though short-term supplies could be provided by several of the water agencies listed above, **there is no water agency with excess supply available to meet the long-term needs of Tualatin**. Water utilities have designed their supplies to meet their own long-term needs and have not planned for excess capacity. Portland remains the most reliable source of long-term supply for the City of Tualatin.

This summary is provided only to understand potential opportunities and does not indicate an intent to provide emergency or non-emergency supply to or from any neighboring water provider.

Information in this attachment is organized by water agency, provided in alphabetical order: City of Lake Oswego, City of Sherwood, City of Tigard, Tualatin Valley Water District, and City of Wilsonville.

City of Lake Oswego

Existing Intertie:

- Existing intertie at 65th and McEwan. The intertie is on a 16-inch line, with a 12-inch connection through the vault.
 - The Hydraulic Grade Lines (HGL) at the intertie location are ~300 ft in the Tualatin system (connecting to Zone A) and ~320 ft in the Lake Oswego system.
 - In 2010, this connection was used to supplement Tualatin's supply for around a week.
 - Some documents have mentioned an additional 12-inch intertie along Macadam Avenue. Previous efforts have been unsuccessful in locating the intertie and it appears the previous mentions were in error.

Opportunities:

- Lake Oswego-Tigard Supply Connection. This opportunity is discussed below under City of Tigard.

Long-Term Supply:

- Lake Oswego and Tigard completed their supply expansion in 2007 (the Lake Oswego-Tigard Water Partnership) to meet their projected supply needs. Excess supply is not available.

City of Sherwood

Existing Interties:

- Existing 8-inch intertie is at Cipole Road and Galbreath Drive. The intertie is located at the extreme end of both systems and would have very limited capacity. In that area, the two systems also have hydrants next to each other that could be used for an above-ground connection between two 12-inch lines.
- Sherwood Emergency Supply Main. A 24-inch pipeline was constructed in the late 90s to wheel TVWD water from Portland through the Tualatin Supply Main to Sherwood, with a design capacity of 3 MGD.
 - It was designed to deliver water to Sherwood's distribution system (HGL 380 ft). Right now, the line is filled with three-year-old water because it is not being used.
 - On Tualatin's end, it passes through Zone A and connects directly to the Tualatin Supply Main, allowing this connection to serve Zone A or connect to the A2 Reservoir. It could serve Zone B by back-feeding the Tualatin Supply Main, if more pressure were available.
 - Under current conditions, capacity to Tualatin is limited by hydraulic restrictions and system pressures (380 HGL) in Sherwood.

Opportunities:

- Improved Sherwood Emergency Supply Main. There is an opportunity to make improvements on the Sherwood side of the Sherwood Emergency Supply Main.
 - The improvements would increase both the available flow and the pressure, allowing the pipeline to serve Zone B and from there reach all areas of the Tualatin system.
 - The pipeline would need to be extended within Sherwood around $\frac{3}{4}$ of a mile to where the Willamette Supply enters the system via a 48-inch diameter line (HGL around 470 ft).
 - Cost for this project would be on the order of \$2M for $\frac{3}{4}$ mile of 24" pipe but would depend on the specific route and requirements.
 - Capacity would be anticipated to be 3+ MGD.

Long-Term Supply:

- Sherwood does not have long-term supply available. Sherwood's owned capacity in the Willamette Intake Facility is limited to their projected long-term demands. This would not leave any supply available to wholesale to Tualatin or any other agency.
- Sherwood does have excess capacity available in the short term and available capacity in their supply pipeline. A short-term arrangement would not be beneficial to the City.

City of Tigard

Existing Interties:

- Boones Ferry & Lower Boones Ferry Intertie. This is a single 10-inch to 10-inch intertie.

- Bridgeport Intertie. Located at 72nd & Boones Ferry, there is both a fire flow connection (10-inch to 10-inch) and a separate intertie (10-inch to 10-inch) near this location. The intertie is just around the corner and can connect into the distribution system in Zone A, with an HGL of ~410 ft on the Tigard side and ~295 ft on the Tualatin side. This intertie can also connect to the Tualatin Supply Main. As its pressure is lower than the normal pressure in the Tualatin Supply Main, Portland's supply would need to be valved off (which would likely be the case if the Tualatin Supply Main were out of service). There is also very limited capacity available in the Tigard system at this location. Because of the reversed hydraulics and the limited capacity, the ability to serve Zone B through the Tualatin Supply Main via this connection is questionable and this intertie is listed as serving Zone A only.

Opportunities:

- Lake Oswego/Tigard Supply Connection. There is an opportunity for a supply line intertie at Florence Lane and SW 80th Avenue, where the Lake Oswego-Tigard supply pipeline (downstream of the Bonita Pump Station) crosses the Tualatin Supply Main.
 - For Tualatin, the benefit of this connection is redundant with the TVWD/Tualatin Flow and Eddy Pump Station. It would connect just south of TVWD's Metzger Connection and is reliant on the Tualatin Supply Main being intact.
 - This is sometimes confused with a proposed regional intertie at Bradley Corners. Further to the west, the Lake Oswego-Tigard pipeline crosses near an existing 24-inch Portland water supply pipeline (formerly used by Metzger and Tigard) at Bradley Corners. Other agencies are considering a major intertie connecting the Lake Oswego-Tigard, Portland and Willamette supplies at this location. The cost for this connection would be in the millions—the pipelines are relatively close together, but the connection is deep. The Bradley Corners intertie would not connect to the Tualatin Supply Main or Tualatin's distribution system.

Long-Term Supply:

- Lake Oswego and Tigard completed their supply expansion in 2007 (the Lake Oswego-Tigard Water Partnership) to meet their projected supply needs. Excess supply is not available.

Tualatin Valley Water District

Existing Interties:

- TVWD/Tualatin Flow and Eddy Pump Station
 - TVWD and Tualatin jointly invested in the Flow and Eddy Pump Station that can wheel water through TVWD into the Washington County Supply Line to reach Metzger and Tualatin.
 - Capacity is 10 MGD, with Tualatin owning 5 MGD of the capacity. The full 10 MGD of capacity would be available to Tualatin if TVWD did not need the water at the same time.
 - This pump station relies on the Metzger-Tualatin Supply Line and Tualatin Supply Main being in good condition and available to carry water.

- The pump station is designed to be connected to the system at the existing flow meter where the Metzger-Tualatin Supply Line connects to the Washington County Supply Line.
- TVWD Metzger Bypass Opportunities
 - Though not formal interties, there are a number of ways to bypass portions of the southern main of the WCSL and the upper portion of the Tualatin Supply Main using distribution piping in Metzger (labelled in maps as the Metzger Bypass). However, the best of these will provide about half of Tualatin's average day demand.
 - This approach was recently used to enable air valve replacement on a portion of the Tualatin Supply Main. During that event, normal pressures were maintained, but flow into the system was significantly less than normal. Tualatin relied on existing storage and the reduced flow into the system for approximately 24 hours while the Metzger Tualatin Supply Line was depressurized.
- Willamette Water Supply System (WWSS) Intertie
 - The existing connection is a 12-inch tee off of the 72-inch transmission line. The connection was constructed to provide construction water to the WWSS transmission pipeline along 124th Avenue, connecting to Zone A.
 - Upsizing of the existing connection could increase flow but would still be limited in capacity by its connection to the distribution system (connecting to two pipes, 12- and 16-inches in diameter respectively). It has sufficient pressure (HGL ~530 ft) to serve Zone B, but only connects to Zone A.

Opportunities:

- Sherwood Emergency Supply Main + WWSS Water Treatment Plant Connection
 - The Sherwood Emergency Supply Main passes by the WWSS Water Treatment Plant property near the intersection of SW 124th Avenue and SW Tualatin-Sherwood Road.
 - A connection between the Sherwood Emergency Supply Main and the WWSS would allow WWSS water to be fed directly into the Tualatin Supply Main. This combined backup supply connection would likely be able to meet Tualatin's full demands and would use Tualatin's existing internal transmission pipelines and pump station to distribute water throughout the City.

Long-Term Supply:

- Similar to Sherwood, TVWD does not have long-term supply available. TVWD's capacity in the Willamette Water Supply System is designed to meet their full needs, but not to provide excess capacity for wholesale.
- Similar to Sherwood, TVWD does have excess capacity available in the short term. A short-term arrangement would not be beneficial to the City.

Wilsonville

Existing Intertie:

- C Level Intertie. Tualatin and Wilsonville prepared to use the existing 10-inch diameter intertie in 2019 because Wilsonville needed water.
 - Existing intertie does have an intertie agreement (Tualatin has a copy).

- Existing intertie connects Wilsonville's Level C to Tualatin Zone C. The reservoirs are at the same level and hydraulics are very flat. However, in a supply interruption, reservoir level will likely drop in the receiving system.

Opportunities:

- Basalt Creek Intertie. A new intertie around the Basalt Creek area could be possible, connecting Wilsonville's Level B to Tualatin's Zone B.
 - Both agencies plan to eventually build reservoirs at this level.
 - Similar to the existing intertie, reservoirs in the adjacent zones would be at similar elevation creating flat hydraulics.

Long-Term Supply:

- No long-term supply is available. Capacity in the Willamette Intake Facility (WIF) and the Willamette River Water Treatment Plant are only sufficient to meet Wilsonville's needs.

Attachment C

Portland Water Bureau's Planned Response to an Outage of the Washington County Supply Line

Portland Water Bureau’s Planned Response to an Outage of the Washington County Supply Line

The information provided here is based on discussions with Portland Water Bureau staff in April 2020. There are two main ways to serve water to the Washington County Supply Line (WCSL) in an emergency, depending on the section of pipeline that is out of service. The main backup supply connects with the Burlingame system and is not considered seismically resilient. The second option relies on the new, resilient, Willamette crossing.

Main Backup

If the WCSL is out of service from the river to the east, then there is another crossing at the Sellwood Bridge to the south. It goes to two pump stations: the Hannah Mason Pump Station (PS) in Willamette Park and the Carolina PS, located several blocks north. Both of those station pump water up the hill to the Burlingame Tanks and Westwood Tank, located a bit South of Wilson Highschool—this hydraulic area is referred to as the Burlingame System.

Downstream of those pump stations there is an intertie between the Burlingame System and the WCSL, located near the intersection of Bertha Boulevard and Beaverton Hillsdale Highway. This location is labelled “Portland Emergency Connection” in the adjacent figure. There is a large regulating station that regulates the pressure down to WCSL pressures at that location.

Secondary Backup

The WCSL can also be supplied from downtown Willamette River crossings, including the new seismically resilient crossing. There is a normally closed valve just north of the Carolina PS that connects water from the downtown crossings to the Burlingame System and then to the WCSL. This backup would connect to the WCSL at the same location as the Main Backup.

The crossing was designed to be large enough to supply the wholesale customers and the west side of the City of Portland. However, other improvements in the distribution system would need to be made to meet the full summer demands for wholesale and retail customers. Without those improvements, water would be available at an emergency level (likely somewhere between winter and average demands).

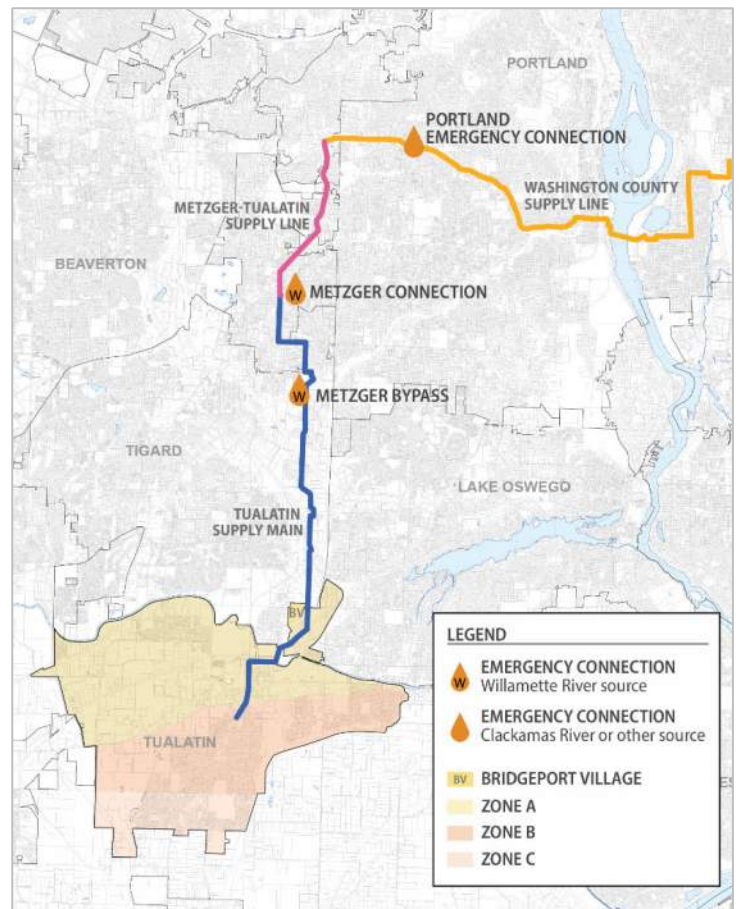

Studies

PWB is currently working on a Supply System Master Plan that applies to all pipelines upstream of terminal storage. This study did not include the WCSL because it is downstream of terminal storage. The WCSL will be included in the bureau's Distribution System Master Plan. That project has not yet been scoped and it is not known how much of the emergency capacity analysis will be included in the study.

TESTING

SECTION# 44 42 56.10

EQ TAG# PMP-0402A & PMP-0402B

**CERTIFIED PERFORMANCE & HYDROSTATIC
TESTING (NON-WITNESSED)**

**APPROVAL OF TEST RESULTS REQUIRED
PRIOR TO RELEASE OF EQUIPMENT FOR
SHIPMENT**

**NOTE:
CERTIFIED PERFORMANCE TESTS
TO BE INSERTED HERE IN THE
FINAL O & M MANUAL**



Type Test Report Three-Phase Induction Motors

Serial Number
PT16525

WEG Indústrias S.A. - Motores
Departamento de Controle da Qualidade

08/10/2009

Customer: WEG ELECTRIC MOTORS CORP.

Order: -

IDENTIFICATION

Item: -	Voltage: 208-230 / 460 / 380 V	Service Factor: 1.15
Model: 364/5T	Current: 189-171 / 85.3 / 102 A	Enclosure: IP23
Assembly: B3R	Power: 75 HP	Power Factor: -
Approximate weight: - kg	Frequency: 60 / 50 Hz	Eff. - 75%: -
Design: B	Full load Speed: 1780 / 1465 rpm	Eff. - 100%: -
Ins. Class: F (80K)	Time Rating: S1	II/In: -

TESTS - CSA C390 - Method 1

1. Resistance Measurement

Resistance: 0.1232 Ohms Ambient Temp.: 21.70 °C Connection: Delta

2. Locked Rotor Test

Voltage: 460 V Frequency: 60 Hz Current: 540.01 A Power: 195.29 kW

TI/Tn: 2.31

3. Temperature Rise Test

Voltage: 460 V Frequency: 60 Hz Service Factor: 100.00%
Coil Temperature Rise: 37.1 K DE Bearing: 21.4 K

4. Load Test

Voltage: 460 V Frequency: 60 Hz Full load torque (Tn): 30.06 mkgf (1 mkgf / mkp = 9.813 Nm)

% of Full Load	Current (A)	Speed (rpm)	Efficiency (%)	Cos Ø
50	49.43	1790	94.1	0.74
75	66.08	1785	94.2	0.83
100	84.71	1779	93.6	0.87

5. No Load Test

Voltage: 460 V Frequency: 60 Hz Current: 27.10 A Losses: 1081.00 W

6. Break-down Torque Test

Voltage: 460 V Frequency: 60 Hz Tb/Tn: 2.73

7. High Voltage Test

Voltage: 1920 V Time : 60 seconds

8. Insulation Resistance Test

Resistance: 5000 MOhms Ambient Temp.: 20.6 °C

NOTES

The values included in this report refer to an unit electrically identical.

ACCEPT

Sonia Regina Diel
Laboratory WEG
Tested on 09/29/2007

Sonia

Witness:

7/89

Speed	Impeller Dia.	Style	Solids Dia.	N _S	Suction	Discharge	No. vanes
1780	VARIOUS	ENCLOSED	1.0"	1654	8"	5"	6

DOUBLE VOLUTE MOUNTING CONFIG.: CC, VM, F, VF, EM, VC

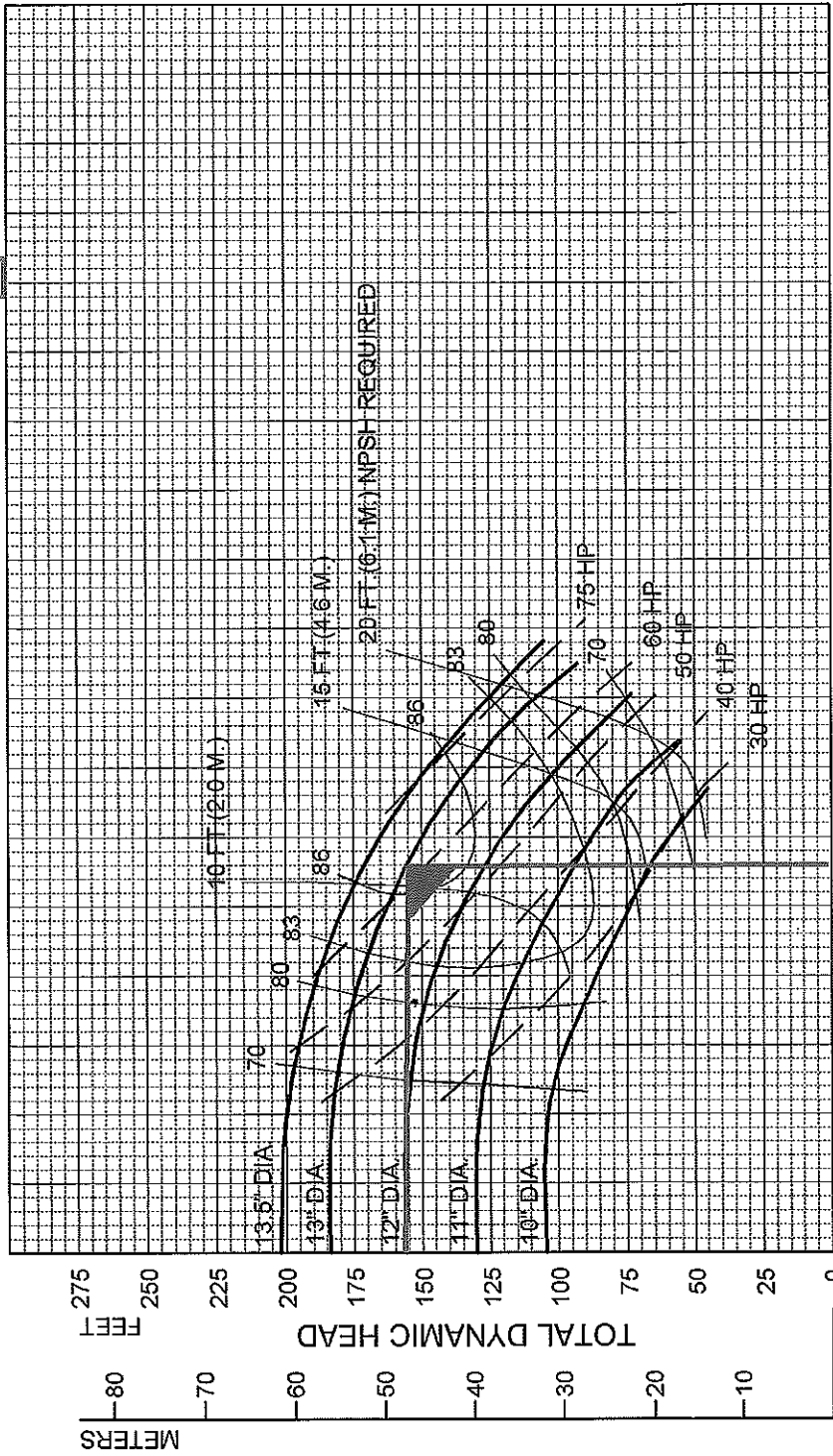

U.S. GALLONS PER MINUTE
CUBIC METERS PER HOUR

CONDITIONS: 1400 GPM @ 156' TDH



Cornell Pump Company • Portland, Oregon

5RB - 1800 RPM

Feet x .305 = Meters
Inches x 25.4 = Millimeters
GPM x .227 = Cubic Meters/Hour
GPM x 3.785 = Liters/Minute
HP x .746 = KW

Performances shown are for cool water, close-coupled electric configuration with packing. Other mounting styles or liquids may require horsepower and/or performance adjustments.

NOTE: OPERATING CONDITION ACHIEVED BY 13 1/2" IMPELLER DIAMETER @ 1725 RPM

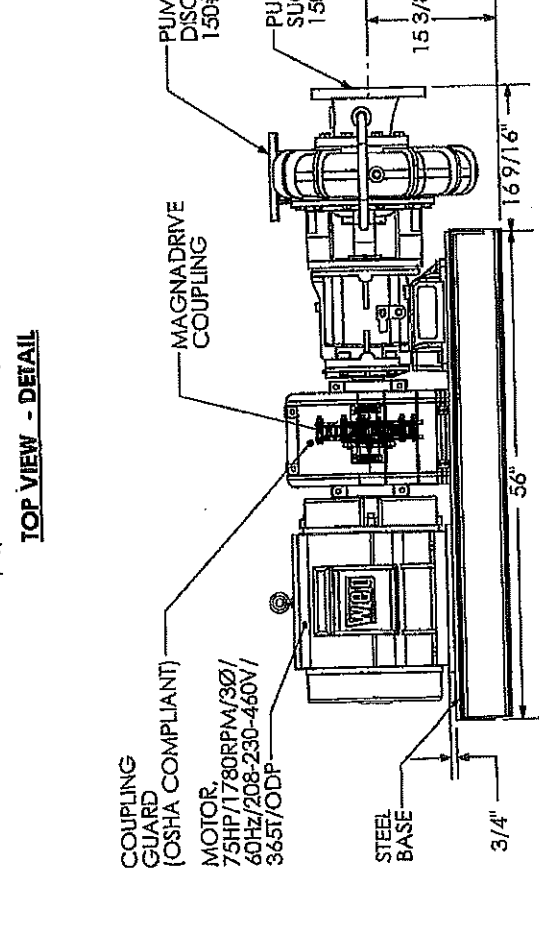
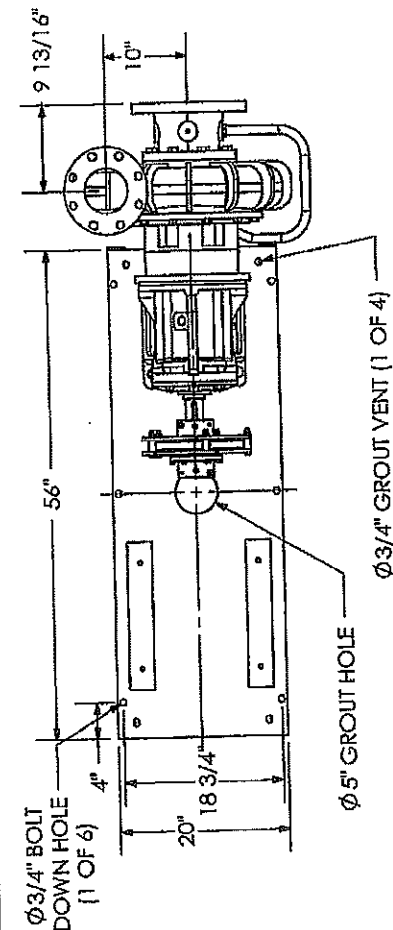
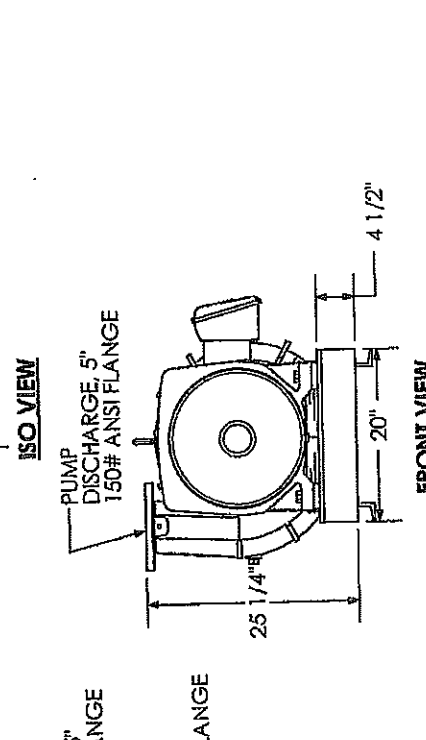
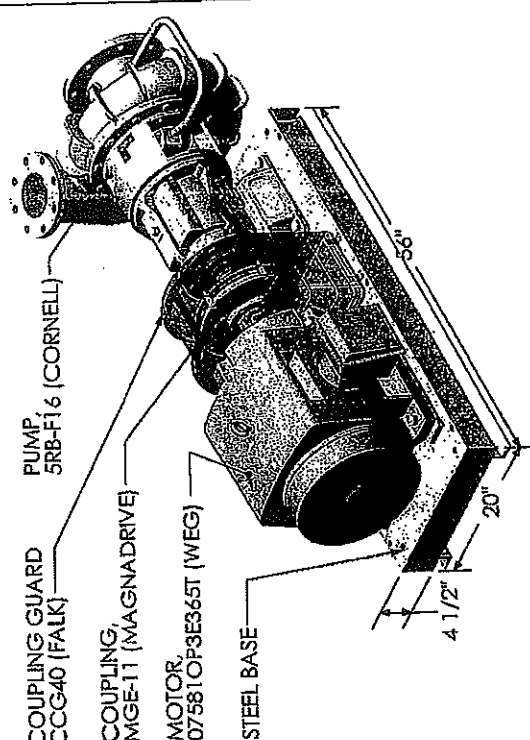

COUPLING GUARD
CCG40 (FALK)
 PUMP
5RB-F16 (CORNELL)
 COUPLING
MGE-11 (MAGNADRIVE)
 MOTOR
075810P3E365T (WEG)
 STEEL BASE

COUPLING
GUARD
(OSHA COMPLIANT)
 MOTOR
75HP/1780RPM/3Ø/
60Hz/208-230-460V/
365T/ODP
 STEEL BASE

PUMP
DISCHARGE, 5"
150# ANSI FLANGE
 PUMP
SUCTION, 8"
150# ANSI FLANGE

QUOTE# 79057 CITY OF TUALATIN NORWOOD P.S. PUMP/MOTOR BASE		SIZE A	DWG. NO. M01554	REV
NAME MAO		DATE 05-14-09		
DRAWN	CHECKED	SALES APPR.	PURCH APPR.	MFG APPR.
UNLESS OTHERWISE SPECIFIED: DIMENSIONS ARE IN INCHES TOLERANCES: FRACTIONAL: +/- 1/8 ANGULAR: 1 DEG ONE PLACE DECIMAL +/- 0.02 TWO PLACE DECIMAL +/- 0.007 INTERPRET GEOMETRIC TOLERANCING PER:				
MATERIAL Steel				
FINISH				
DO NOT SCALE DRAWING				
PROPRIETARY AND CONFIDENTIAL THE INFORMATION CONTAINED IN THIS DRAWING IS THE SOLE PROPERTY OF PUMPTECH, INC. ANY REPRODUCTION IN PART OR AS A WHOLE WITHOUT THE WRITTEN PERMISSION OF PUMPTECH, INC. IS PROHIBITED.				

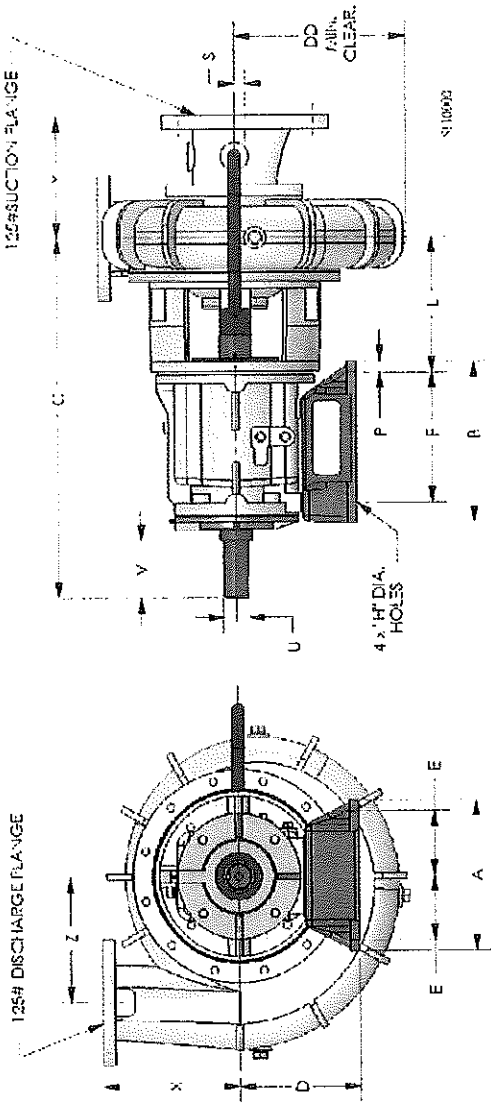

NOTES:

1. "V" Dimension is maximum useable shaft.
2. Frame mounting foot thickness is .75".
3. Flange connection dimension can vary \pm .12 inch.
4. Do not use for construction unless certified.

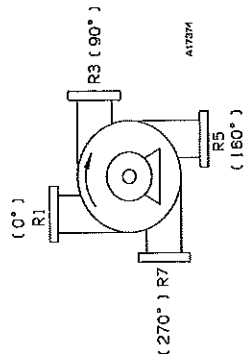
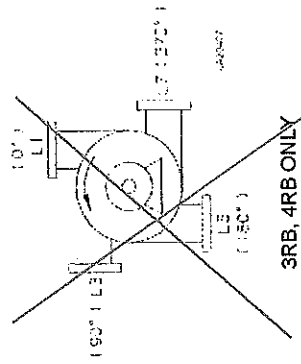

NOTES:

- a. Discharge positions viewed from the drive end.
- b. Consult factory for other discharge positions.

PUMP DIMENSIONS

MODEL	CONNECTION		A	B	C	D	DD	E	F	H	L	P	S	T	U	V	X	Y	Z	KEYWAY
	FRAME	DISCH. SUCT.																		
2.5RB	F16	2.5	12	12.88	25.5	9.75	9	5.12	10.38	0.81	7.65	0.88	-	2.87	2	4.5	9.75	6	6.75	.50X.25
3RB	F16	3	12	12.88	25.62	9.75	10	5.12	10.38	0.81	7.78	0.88	-	3	2	4.5	8.5	5.25	7.75	.50X.25
3RC	F16	3	12	12.88	25.62	9.75	10	5.12	10.38	0.81	7.78	0.88	-	3	2	4.5	8.5	5.25	7.75	.50X.25
4RB	F16	4	12	12.88	25.75	9.75	11	5.12	10.38	0.81	7.9	0.88	-	3.12	2	4.5	10	7.38	8	.50X.25
4RC	F16	4	12	12.88	25.75	9.75	11	5.12	10.38	0.81	7.9	0.88	-	3.12	2	4.5	10	7.38	8	.50X.25
5RB	F16	5	12	12.88	28.62	9.75	14.25	5.12	10.38	0.81	10.77	0.88	0.88	3.47	2	4.5	11	9.78	10	.50X.25
5RB-S	F16	5	12	12.88	25.38	9.75	14.25	5.12	10.38	0.81	7.53	0.88	0.88	3.47	2	4.5	11	9.78	10	.50X.25
5RC	F16	5	12	12.88	25.38	9.75	14.25	5.12	10.38	0.81	7.53	0.88	0.88	3.47	2	4.5	11	9.78	10	.50X.25
6RB	F16	6	12	12.88	29.06	9.75	15.38	5.12	10.38	0.81	11.21	0.88	1	3.91	2	4.5	11	9.91	9.5	.50X.25
6RB-S	F16	6	12	12.88	25.81	9.75	15.38	5.12	10.38	0.81	7.97	0.88	1	3.91	2	4.5	11	9.91	9.5	.50X.25
6RC	F16	6	12	12.88	25.81	9.75	15.38	5.12	10.38	0.81	7.97	0.88	1	3.91	2	4.5	11	9.91	9.5	.50X.25

12/15/2005



CORNELL PUMP COMPANY

**R-SERIES HORIZONTAL F16 FRAME MOUNTED PUMPS
WITH TANGENTIAL VOLUTE**

DIM2066

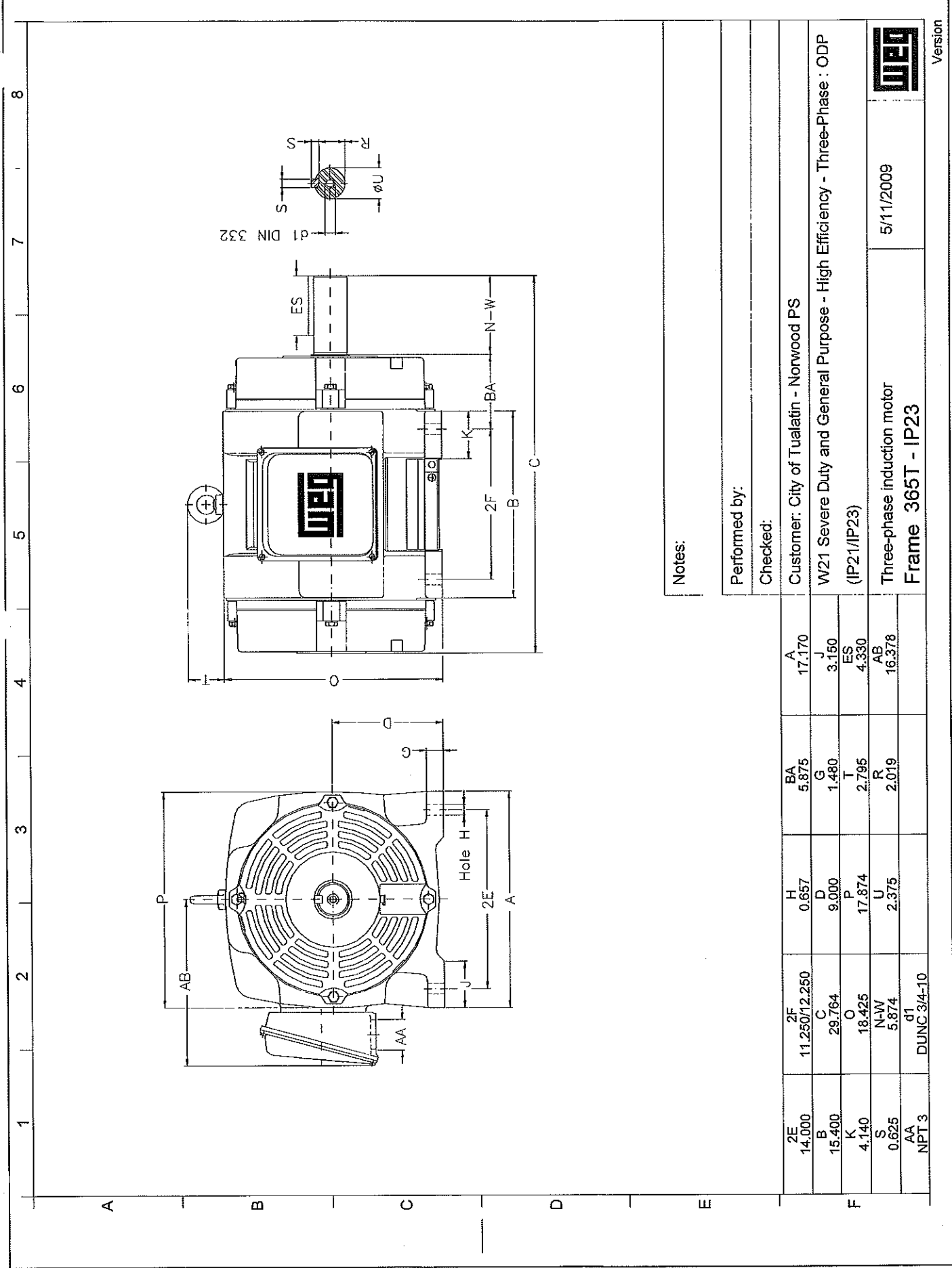

Notes:

Performed by:

Checked:

2E	14.000	2F	11.250/12.250	H	0.657	BA	5.875	A	17.170
B	15.400	C	29.764	D	9.000	G	1.480	J	3.150
K	4.140	O	18.425	P	17.874	T	2.795	ES	4.330
S	0.625	N-W	5.874	U	2.375	R	2.019	AB	16.378
AA	NPT 3	d1	DJUNC 3/4-10						

Customer: City of Tualatin - Norwood PS

W21 Severe Duty and General Purpose - High Efficiency - Three-Phase : ODP (IP21/IP23)

Three-phase induction motor
Frame 365T - IP23

5/11/2009



Version

11A. CENTRIFUGAL PUMPA. SCOPE

This section covers the work necessary for furnishing and installing the centrifugal water booster pump including the pump assembly, electric motor and accessories. The pump will be used to pump potable water to the City of Tualatin's Level B reservoir.

MANUFACTURER'S REPRESENTATIVE. The manufacturer of the centrifugal pump shall furnish the services of a qualified representative to supervise the unpacking, installation, and field testing of pump equipment at no cost to the Contractor.

Upon completion of the pump installation, the manufacturer's representative shall issue certificates showing:

- . Condition of pump upon unpacking at jobsite.
- . That the handling of pump equipment was satisfactory to the manufacturer.
- . The installation is as specified and is acceptable to the manufacturer.
- . The warranty or guarantee is in full effect with no qualifications or reservations.

B. MATERIALS

OWNER FURNISHED MATERIAL. The owner shall furnish the required pumps in accordance with the conditions in Section 1A, GENERAL REQUIREMENTS. The pumps will be Cornell Pump Co. Model 4WB vertical mounted with a 50 H.P. motor.

The pumps shall have the following characteristics:

Speed	3600 RPM
Total Dynamic Head	80 Ft. @ 1200 GPM 196 Ft. @ 600 GPM
Impeller	7 1/16" Diameter Bronze
Volute	Cast Iron
Mechanical Seal	Single

MODEL 4WB

SPEED 3600 & 1800 RPM

VARIOUS IMPELLER

60 HERTZ

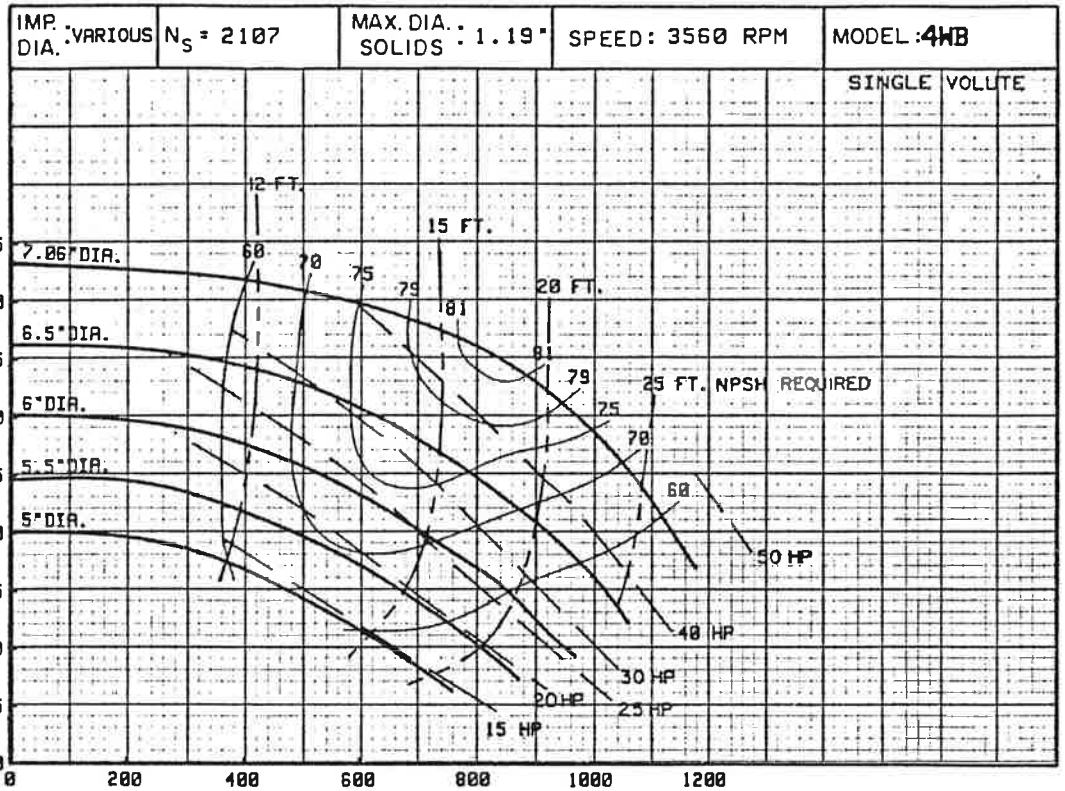

Performances shown are for close coupled electric configuration with packing. Other styles may require horsepower and/or performance adjustments.

FT. x .305 = METERS
GPM x .227 = CUBIC METERS PER HOUR

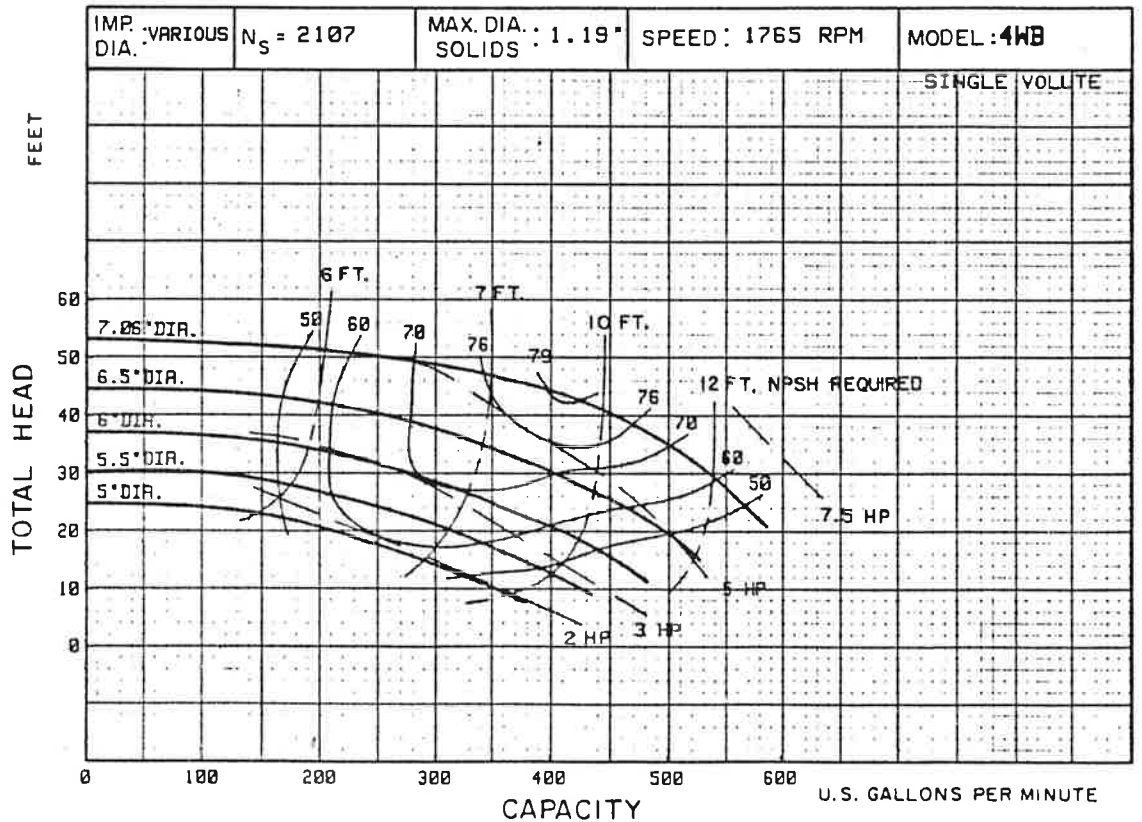

MEMORANDUM

DATE: June 6, 2017

PROJECT: 16-1826

TO: Jeff Fuchs, PE – City Engineer/Public Works Director
City of Tualatin

FROM: Brian M. Ginter, PE
Michael L. McKillip, PE
Murraysmith

RE: City of Tualatin Water System Hydraulic Model Calibration

Introduction

The City of Tualatin (City) requested Murraysmith perform a calibration update to the water system hydraulic model. The model was originally developed prior to the 2003 Water Master Plan (WMP) and more recently updated for use with the 2013 WMP. Due to budget constraints and limited calibration data, the calibration effort for the 2013 WMP was limited to spot checking of static pressure conditions. This memorandum summarizes the calibration update work.

Model Calibration Overview

Model calibration typically involves adjusting model parameters to match field data, such as pressure and flow measurements recorded at system fire hydrants. The required level of model accuracy can vary according to the intended use of the model, the type and size of water system, the available data, and how the system is controlled and operated.

Model accuracy depends on the quality of the data available for the distribution system. Accurate system modeling assumes correct pipe connectivity, diameter, internal roughness and length. Knowing the status of system facilities, including pumps and reservoirs, referred to as “boundary conditions” is also critical during calibration.

The first component of model calibration is to match field-measured static pressure with model simulated pressure. Ideally, model results would be identical to those measured in the field; however, for any system a portion of the data describing the distribution system will be inaccurate or unverified, and some assumptions will be required. During steady state calibration, demand distribution, system connectivity, service elevations, boundary conditions and any assumptions used to develop the model are verified.

The second component of calibration utilizes fire flow tests to verify pipe diameters, connectivity and friction factors along with system boundary conditions such as pump operation and reservoir level. Fire flow testing consists of recording static pressure at a hydrant and then “stressing” the system by flowing an adjacent hydrant. While the adjacent hydrant is flowing, residual pressure is measured at the first hydrant to determine the pressure drop that occurs when the system is “stressed”. Boundary condition data, such as reservoir levels and pump on/off status, must also be known to accurately model the system conditions during the time of the flow test. The recorded time of each fire hydrant flow test is used to collect boundary condition information from the City’s system supervisory control and data acquisition (SCADA) system.

City of Tualatin Model Calibration

For the City’s water system distribution model, thirty hydrant flow test were performed between September 7, 2016, and September 21, 2016. Test were conducted in all service levels (12 each in level A and B, 6 in level C). Hydrant test locations and flow test instructions were provided in the “Fire Hydrant Flow Testing for Water System Hydraulic Model Update” memo (August 1, 2016). Fire flow test location are shown on **Figure 1**. **Table 1** summarizes the field measured and model simulated static and residual pressure for each flow test.

Overall the calibration was good and model confidence can be considered Medium-High based on the calibration criteria outlined in **Table 2** below. In general, pressure drops due to fire flow tests were underestimated in the model. The fact that this model is underestimating pressure drop does not mean that it should not be used or that model results are not valid; however, this should be kept in mind when using the model for system analysis.

Table 2
Model Calibration Criteria

Confidence Level	Static Test Percent Error	Residual Fire Flow Pressure Difference
High	0 – 5%	≤10 psi
Medium	5 – 10%	10-20 psi
Low	> 10%	>20 psi

Model results are sensitive to boundary conditions such as reservoir levels and valve settings (pressure reducing valves, PRVs, and flow control valves, FCVs). In this model, results are particularly sensitive to settings at the main PRV stations from the Portland Supply line into service levels A and B. Based on flow test data it appears that flow is being controlled primarily by FCV settings as opposed to PRV settings. Settings for these valves should be considered carefully when using this model to perform analysis as the results can vary significantly if FCV or PRV valves are changed.

MLM:sam

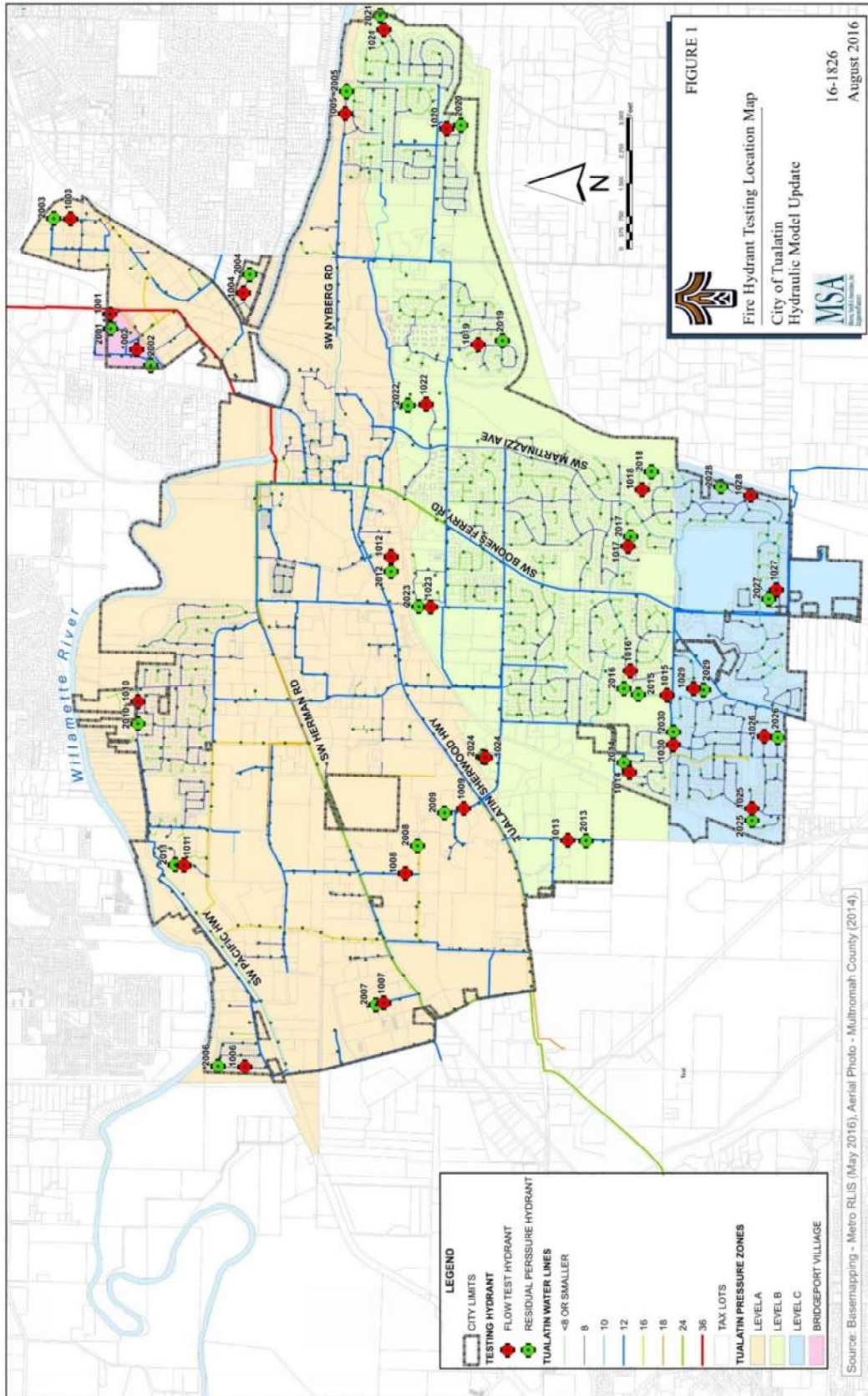

Technical Memorandum

Date: June 29, 2021

Project: 20-2737.0407

To: Mr. Casey Fergeson, PE
Ms. Kim McMillan, PE
City of Tualatin

From: Brian Ginter, PE
Claire DeVoe, PE

Re: Water System Capacity Analysis – Basalt Creek Service

Introduction

The City of Tualatin’s Basalt Creek Planning Area located at the south end of the C Level is beginning to develop with two developments currently moving into land use approval. Based on preliminary planning completed for the Water System Master Plan (WSMP, MurraySmith 2021), the system has adequate storage capacity to meet the developments’ needs. However, existing transmission limitations through the B Level and fire flow requirements that exceed existing maximum available supply in the C Level require transmission improvements in both the B and C Levels prior to development. The complete findings from this report are summarized in the last section, *Summary and Recommendations*.

Basalt Creek Development

The two proposed developments are located in the Basalt Creek Planning Area of the C Level (see **Figure 1**). Community Partners for Affordable Housing (CPAH) is a proposed multifamily development with 116 planned units located off SW Boones Ferry Road. Autumn Sunrise includes approximately 400 planned single family residential homes located east of SW Boones Ferry Road and west of I-5. Together, these developments represent an increase of 486 Equivalent Residential Units (ERUs, 0.75 multifamily units/ERU). **Table 1** summarizes the two developments.

Table 1
Basalt Creek Developments

Development	CPAH	Autumn Sunrise
Type	Multifamily	Single Family
Units	116	400
ERUs ¹	86	400
Required Fire Flow (gpm) ²	1,500	1,000

1. ERUs calculated as 1 ERU/single family unit and 0.75 ERUs/multifamily unit.
2. It is assumed that on-site fire suppression sprinklers will be installed to fire flow capacity requirements in excess of these values.

There is sufficient storage in the C Level to support the development of up to 900 ERUs (see WSMP, Section 5). However, the existing system has transmission limitations. During peak summer demands, the City has difficulties maintaining adequate water levels in both the B and C Reservoirs due to insufficient transmission capacity from the Portland Supply at Boones Ferry Road north of SW Sagert Street to the B Level Reservoir Site at SW Norwood Rd. Adding additional customers to either the B or C Levels will increase the risk associated with this deficiency, resulting in declining reservoir levels that could leave insufficient fire and emergency storage available during multiple days of high water use. Additionally, the anticipated CPAH fire flow requirement exceeds the existing gravity supplied, C Level maximum available fire flow of 1,000 gpm. The rest of this document identifies improvements required in B and C Level transmission to meet the needs of the Basalt Creek developments.

Model Scenarios for Transmission Analysis

The hydraulic model was updated to include the two planned developments in the Basalt Creek area. The following table documents boundary conditions and reasoning for both the B and C Level Transmission analyses.

Table 2
Hydraulic Model Boundary Conditions for Transmission Analysis

Facility/Setting	C Level Transmission Scenarios	B Level Transmission Scenarios
Analysis Type	Available Fire Flow	Reservoir Filling
Criteria	Meet C Level fire flow requirements during MDD.	System to provide MDD to the B and C Levels and fill the B Level at historical rates without excessive strain on B and C Level Reservoirs and over pressurizing the B Level.
System Demand	MDD plus Fire Flow. Maximum planning flow rate to evaluate system hydraulics (flow and pressure)	MDD – Reservoir filling limitations occur during peak usage. Existing demands used to understand additional capacity with improvements.
Reservoir Levels	Emergency Storage Only – Assumes all operational, equalizing and fire storage is depleted, C Reservoirs at 14’ (472.5’ HGL).	Reservoirs at 75% (36’, 388’ HGL)- Reservoirs would likely be operating within this range during the summer.
Boones Ferry FCV/PRV Setting	Not Relevant to C Level gravity supply.	Pressure Control at 112 PSI – maximum pressure allowed at Boones Ferry to limit B Level over pressurization, from historical records and prior analysis.
ASR	Off – Does not affect C Level.	On – ASR offsets Boones Ferry required supply by about 350 gpm and is assumed to be operating under peak summer conditions.
C Level Pumps	Off – Conservative assumption as there is currently no certainty the pump station is on during a fire.	Off – Co-located at the Norwood site with the B Reservoirs. Does not change how water moves through the system.

1. MDD – maximum day demand; HGL – hydraulic grade line; Boones Ferry FCV/PRV – Boones Ferry Flow Control Valve/Pressure Reducing Valve; PSI – pounds per square inch; ASR – aquifer storage and recovery; gpm – gallons per minute.

C Level Transmission

Required transmission main improvements in the C Level are governed by the need to address fire flow capacity deficiencies. When the C Level Pump Station is off, the C Level Reservoirs are the sole supply to the C Level via a single 5,000 linear foot (lf), 12-inch diameter transmission line (see **Figure 1**). Available fire flow in the C Level is currently limited to approximately 1,000 gpm.

A fire flow analysis was run under various scenarios using the City’s water system hydraulic model, summarized in **Table 2**. Deficiencies were analyzed at the maximum fire flow requirement in the zone (CPAH, 1,500 gpm) and the maximum elevation in the zone (adjacent to the ASR site, 1,000 gpm). Excess capacity was calculated in terms of ERUs under MDD conditions at a rate of 443 gpd/ERU (WSMP Section 3).

C Level transmission is currently adequate to provide 1,000 gpm fire flow required at single-family homes. However, the existing transmission is at its limit and should be upsized to serve the proposed 1,500 gpm fire flow required at CPAH. It is recommended to install a parallel transmission line from SW Norwood Road to SW Frobase Road prior to development of the Basalt Creek area (see **Figure 1** for proposed improvements). *The City may consider delaying this transmission upsizing temporarily to allow CPAH and Autumn Sunrise to develop by implementing operational changes to the C Level Pump Station, until the transmission upsizing is completed.* Operational changes to the pump station include:

- **Prior to any additional development:** Update the C Level Pump Station pump on-off settings to include pressure controls that would trigger the pumps to start in the event of a drop in C Level pressure due to a fire flow event.
- **Before Summer 2022:** Modify C Level Pump Station operations to make use of the variable frequency drives (VFDs) to pace flow to maintain constant reservoir levels with longer duration, lower rate pump run cycles. In coordination with this operational change, increasing the C Level Pump Station on setpoint (effectively reducing the operational storage volume and increasing the volume available for equalizing, fire suppression, and emergency). With active mixing of reservoir contents, deep cycling of the reservoirs is less important for maintaining water quality, especially during the peak summer season.
- **Within the next 2 years:** Add permanent onsite standby power generation and automatic transfer switch (ATS) to ensure reliable operation of the C Level Pump Station in the event of a power outage.

Within the next 5 years, the existing system will no longer have the capacity to meet the minimum 1,000 gpm fire flow and the transmission main must be upsized from the C Level Pump Station at the Norwood site to Frobase Road.

Completing transmission improvements from Frobase Road to the C Level Reservoirs is recommended once an additional 600 ERUs are constructed in the C Level, including the approximately 486 ERUs at full build-out of CPAH and Autumn Sunrise.

It is assumed that once the existing 12-inch diameter transmission main reaches the end of its usable life, it will be abandoned. The parallel main has therefore been sized to operate long-term as the only supply line. Results shown in **Table 3** maintain this assumption.

Table 3
Available FF at in the C Level

Demands	Piping Improvements	Available FF (gpm)		Meets FF?	
		CPAH	Max Elev.	CPAH	Max Elev.
2020 MDD	Existing infrastructure	1,075	1,000	No	Yes
2020 MDD	18" from Norwood access to Frobase Rd	1,675	1,375	Yes	Yes
2020 MDD	18" from Norwood access to C Reservoirs	>2,000	1,975	Yes	Yes
2040 MDD	18" from Norwood access to Frobase Rd	800	725	No	No
2040 MDD	18" from Norwood access to C Reservoirs	>2,000	>2,000	Yes	Yes

1. All scenarios leave I-5 crossing as is: 8-inch diameter main suspended from the overpass and a 12-inch diameter below-grade crossing.
2. 1,500 gpm required fire flow at CPAH, 1,000 gpm required fire flow at maximum elevation in the C Level.
3. C Reservoirs set at 14' (fire flow storage depleted).

B Level Transmission

Required transmission capacity in the B Level is primarily governed by reservoir filling under maximum ay demand conditions. The only B Level supply is the Boones Ferry FCV/PRV on the north side of the zone. This single supply facility must transmit the entire water supply needs of the B and C Levels into the B Level transmission/distribution system. The B Level Reservoirs and the C Level Pump Station at the Norwood Site are at the southern limits of the zone, with primarily 12-inch diameter piping connecting the single point of supply with the largest points of demand (reservoir filling and C Level Pumping).

With existing infrastructure, the Boones Ferry FCV/PRV has difficulties providing enough supply at acceptable pressures to fill the B Level Reservoirs, supply the C Level Pump Station, and meet B Level demands. This deficiency forces the City to either over pressurize the system near the Boones Ferry FCV/PRV to push enough water through the system up to the reservoirs or reduce supply and draw on storage while demand is greater than supply. The latter condition frequently occurs during peak demand in the summer, resulting in extended periods of time where both B and C Level Reservoirs experience unacceptably low water levels.

Without an accurately configured and calibrated Extended Period Simulation (EPS) model, reservoir turnover and reservoir upsizing scenarios are difficult to model. Adding more storage to the Norwood Site may help provide additional buffer to supply demands when the Boones Ferry Supply cannot keep up, but this volume still needs to be refilled and existing transmission is not sufficient to refill this volume between peak hours. This issue has lessened since the City increased the minimum B and C Reservoir levels to 40 ft from 36 ft, reducing the total volume of refill required. However, as demands grow, balancing flows will continue to limit distribution system operation.

The City needs to upsize transmission to reduce headloss between the Boones Ferry FCV/PRV and the B Reservoirs. This analysis focuses on upsizing transmission; developing additional reservoir storage capacity should be considered in the context of overall storage needs and not as a measure to mitigate transmission capacity limitations.

Pipe Upsizing

It is assumed that the existing B Level transmission would be upsized, rather than completed as a parallel main, recognizing that the existing main in Boones Ferry will eventually reach the end of its service life and will need to be taken out of service. Transmission upsizing was divided into the following sections. See **Table 4** and **Figure 2** for exact locations.

Table 4
Existing B Level Transmission

Section	Start Road	End Road	Existing Diameter (in)	Length (ft)
1	Norwood Site	SW Ibach St	12	4,750
2	SW Ibach St	SW Blake St	12	1,575
3	SW Blake St	SW Sagert St	12	4,200
4	SW Sagert St	Boones Ferry FCV/PRV	24	1,125

Boones Ferry Supply

The Boones Ferry FCV/PRV is currently set as flow control, with a maximum allowable pressure (pressure reducing setting). This analysis is concerned with the maximum flow available through the control valve station so the facility was modelled as a PRV set at the maximum allowed downstream pressure, set at 112 psi. This pressure setting is consistent with historical operation and limits potential over pressurization of B Level customers at the A/B Level boundary. Under this condition, static pressures for these customers are above maximum allowable pressures without individual service PRVs. It was assumed that existing locations with high static pressures already have individual PRVs, and thus this pressure is acceptable.

The total flow required from the Boones Ferry FCV/PRV should be sufficient to provide B and C Level MDD and fill the B Level Reservoirs. Based on historical operations and best practices for reservoir refilling, a refill rate of 6 feet of reservoir level in 8 hours was used for this analysis, resulting in a reservoir refill flow rate of 1,400 gpm. By 2040, it was assumed a third B Level reservoir will be constructed at the Norwood site, increasing fill rate requirements by 50% to 2,100 gpm. The C Level Reservoirs have sufficient equalizing storage to meet peak hour demand through at least 2040, therefore only C Level MDD is considered. **Table 5** summarizes the pressure and flow requirements from the Boones Ferry FCV/PRV.

Table 5
B Level Transmission Pressure and Flow Requirements

Condition	Requirement - 2020	Requirement - 2040
Maximum Allowable Pressure	112 psi/425' HGL at Boones Ferry PRV	
B + C MDD	2,600 gpm	3,300 gpm
B Filling	1,400 gpm	2,100 gpm
Required Supply from Boones Ferry FCV/PRV	4,000 gpm	5,400 gpm

Results

The maximum flow through the system was modelled under various combinations of transmission upsizing. The available capacity in excess of required supply from Boones Ferry FCV/PRV (calculated in **Table 5**) was converted into ERUs, in the same manner as for the C Level Transmission Analysis. The results of this analysis are presented below in **Table 6**.

It is recommended that the City upsize transmission to 18-inch diameter from the B Level Reservoir site to SW Ibach Street as soon as possible to support further development, in order to minimize further impacting system performance during peak demands. Beyond this initial improvement, **Table 6** summarizes the approximate number of additional ERUs that can be supported in the B and C level before additional segments of the transmission piping require upsizing to 18-inch diameter.

Table 6
B Level Transmission Analysis Results

	Improvement (18-inch diameter main)	Boones Ferry Supply (gpm)	ASR Supply (gpm)	Excess Capacity (gpm)	Available Additional ERUs with Upsized Transmission
2020	Existing	3,125	350	-525	None
	Norwood to Ibach St	3,950	350	300	976
	Norwood to Blake St	4,425	350	775	2,521
	Norwood to Sagert St	5,425	350	1,775	5,774
2040	Existing	3,050	350	-2,000	None
	Norwood to Ibach St	4,175	350	-875	None
	Norwood to Blake St	4,475	350	-575	None
	Norwood to Sagert St	5,400	350	350	1,138

Summary and Recommendations

The purpose of this memorandum is to quantify the extent of improvements in the B and C Levels required to support near-term development of the Basalt Creek area, in the context of overall transmission system improvements recommended to serve build-out of the B and C Levels. The findings of the analysis are summarized below:

- C Level transmission capacity between the C Level (Norwood) Pump Station and C Level Reservoirs is inadequate to serve continued development in the C Level and specifically for the development of the Basalt Creek area. This deficiency results in inadequate fire flow capacity to serve proposed developments east of Boones Ferry Road and south of Norwood Road (Autumn Sunrise development and CPAH development). While operation of the C Level Pump Station in a pressure maintenance mode (rather than just reservoir filling) to boost pressure during peak demand and fire flow events alleviates this deficiency in the near-term, it should not be relied upon as long-term mitigation for this deficiency.
- B Level transmission between the Boones Ferry FCV/PRV and B Level Reservoirs is inadequate to supply B and C Level peak demands while refilling the B Level Reservoirs. The resulting condition, which has been observed over the last several summers, is the sustained decline of available storage volume in the B and C Level reservoirs during multiple days of high water use. The need to manage the pressure in the B Level distribution prevents increasing the hydraulic grade of the incoming PWB wholesale supply at Boones Ferry FCV/PRV to transmit additional flow into the B Level for reservoir filling.
- While additional storage in the B Level is ultimately required, construction of additional storage volume will provide limited mitigation for the transmission capacity deficiency.

Based on the summary of findings above, the City should consider the following recommendations which will be incorporated into the Water System Master Plan.

C Level

- *Prior to CPAH and Autumn Sunrise Development:* Before any C Level development occurs, the following improvements should be completed:
 - Change C Level Pump Station operation to include activation due to C Level pressure drops and use VFD abilities at the pumps to provide longer, more consistent pump station run times. Low pressure activation will mitigate current fire flow deficiencies to support CPAH development and VFD use should reduce the impact of C Level pumping on B Level reservoir levels.
 - Install permanent standby power at C Level Pump Station
- *Prior to Further Basalt Creek Development:* Continued development in the Basalt Creek area beyond CPAH and Autumn Sunrise should not be allowed without the completion of the following improvements:
 - Upsize from SW Vermillion Dr to I-5 Crossing, 344 lf, to 18-inch diameter main

- Oversize Autumn Sunrise subdivision piping parallel to Norwood Road to 18-inch diameter when constructed
- Upsize from east of I-5 Crossing towards SW Frobase Road, approximately 2,500 lf, to 18-inch diameter main
- Upsize from C Level Pump Station to Norwood Road to 18-inch diameter when moved by developers
- *Long-term Recommendations:* Full development of the Basalt Creek area will require the build-out of a transmission main loop, as identified in the Water System Master Plan, and the following improvements to address the transmission deficiency between the C Level Pump Station and C Level Reservoirs.
 - Upsize the remaining transmission from Frobase Road to the C Level Reservoirs, approximately 2,000 lf, to 18-inch diameter

B Level

- *Prior to Basalt Creek Development:* Development in the B and C Levels should be limited until the following improvement is completed:
 - Upsize existing transmission to 18-inch diameter main from Norwood Reservoirs to SW Ibach St. In the near-term, further development will increase the risk that B and C Level reservoirs will be drawn down to levels that deplete storage for fire suppression and emergencies during peak summer demand conditions. The City is aware of this risk for the CPAH and Autumn Sunrise developments.
 - In order to mitigate for the existing deficiency until the transmission improvements described above are completed, B Level Reservoir operating setpoints (high and low level settings) for Boones Ferry FCV/PRV should be adjusted to provide a narrower range of operating storage, effectively providing more available storage for equalizing, fire and emergency uses. With active mixing in the City's reservoirs, the need for cycling of the reservoirs for water quality is not critical, especially during the summer season when the maintaining full reservoirs reduces the risk to the system. A low level setting of 43 feet would help to maintain full storage volumes, but this may require upgrade in control settings to allow Boones Ferry FCV/PRV flows to modulate incrementally between the high and low setpoints rather than step between these two setpoints.
- *Long-term Recommendations:* With full development of the B and C Levels, further transmission improvements are recommended in the B Level:
 - Upsize existing transmission to 18-inch diameter main in SW Boones Ferry Road from SW Ibach St to SW Sagert St

Long-term storage deficiencies, associated with continued B and C Level development are addressed in the Water System Master Plan. For B Level storage, the City should reserve adequate space adjacent to the existing B Level Reservoirs to construct an additional reservoir at this site.

As noted throughout this memorandum, the proposed development in the Basalt Creek area can be expected to exacerbate existing deficiencies in both the B and C Levels, and approval of these developments should be conditioned for construction of near-term improvements to mitigate these deficiencies before development is completed and water service is required. All of the improvements recommended herein address a combination of existing deficiencies and long-term capacity needs and should be considered eligible for use of system development charge (SDC) funds, as they provide expanded capacity for future development and will be incorporated into the City's Water SDC calculation.

B Level

C Level



Norwood Site
B Level Reservoirs
C Level Pump Station

12"

18"

18"

18"

18"

CPAH Development

Frobese Rd

Legend

Pipes (Existing Diameter Labelled on Map)

- Existing Pipes
- B Transmission
- B Reservoir Transmission Realignment
- Autumn Sunrise Development
- Low Income Supply
- C Pump Station Realignment
- West of I-5
- I-5 Crossing
- I-5 Crossing to Frobese Rd
- Frobese Rd to C Reservoirs
- Future Basalt Creek Pipes

Autumn Sunrise
Development

18"

C Level
Reservoirs



Data Sources:

City of Tualatin
ESRI Basemap
Disclaimer: The City of Tualatin makes no representations, express or implied, as to the accuracy, completeness and timeliness of the information displayed. This map is not suitable for legal, engineering, or surveying purposes. Notification of any errors is appreciated.

0 1,000 Feet

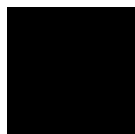
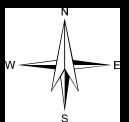

City of Tualatin
Basalt Creek Service

Figure 1
C Level Transmission
Upsizing

G:\PDX - Projects\20\2737 - Tualatin On-Call Modeling\0407 - Basalt Creek Service\Tualatin_20210226_fig 1.mxd 6/9/2021 12:28:21 PM claire.devoe

Legend

Pipes (Existing Diameter Labelled on Map)

- B Level, Existing
- A and C Level, Existing and Proposed
- - - B Reservoir Transmission Realignment
- B Transmission - Norwood to Ibach
- B Transmission - Ibach to Blake
- B Transmission - Blake to Sagert
- SL-B, B Transmission - Sagert to Boones PRV

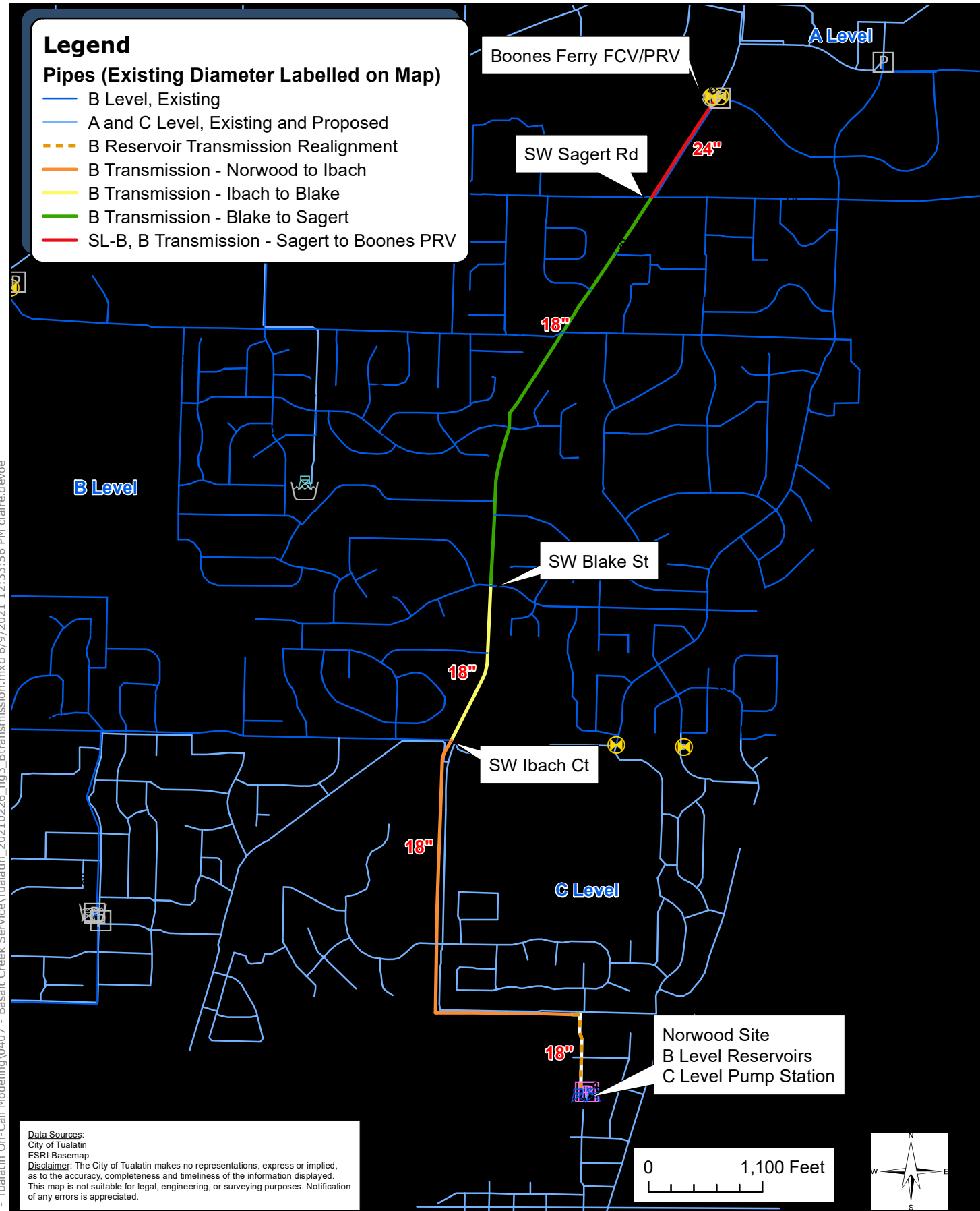

Data Sources:
 City of Tualatin
 ESRI Basemap
Disclaimer: The City of Tualatin makes no representations, express or implied, as to the accuracy, completeness and timeliness of the information displayed. This map is not suitable for legal, engineering, or surveying purposes. Notification of any errors is appreciated.

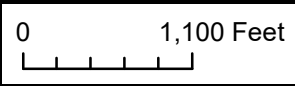

G:\PDX\Projects\20\2737 - Tualatin On-Call Modeling\0407 - Basalt Creek Service\Tualatin_20210226_fig3_Btransmission.mxd 6/9/2021 12:33:56 PM claire.devoe

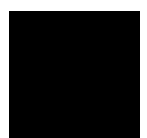

**City of Tualatin
 Basalt Creek Service**

**Figure 2
 B Level Transmission
 Upsizing**

Technical Memorandum

To: Brian Ginter, PE, Murraysmith, Inc.	Project: City of Tualatin Water System Seismic Resiliency Study
From: Wolfe Lang, PE, GE	cc:
Prepared by: Farid Sariosseiri, PE	Job No.: 5804
Date: June 22, 2018	
Subject: Seismic Hazards Evaluation	

1.0 Introduction

The City of Tualatin is conducting an update to its Water Master Plan and this seismic resiliency study is part of the update. The city has contracted Murraysmith, Inc. (Murraysmith) to provide professional engineering services for the Water Master Plan update. McMillen Jacobs Associates (McMillen Jacobs) has been retained by Murraysmith to provide a seismic hazards evaluation as part of the seismic resiliency study.

This memorandum presents the results of McMillen Jacobs’ evaluation. The following tasks were completed in accordance with our scope of work:

1. Review of DOGAMI seismic hazard maps for a magnitude 9.0 CSZ event in the city’s service area;
2. Review of available geological information;
3. Review of available geotechnical boring information provided by the city to verify DOGAMI seismic hazard maps;
4. Site reconnaissance to address key geological and geotechnical assumptions and to examine areas that are potentially prone to failures from lateral spreading and seismic landslide hazards;
5. Develop estimates of strong ground shaking, liquefaction-induced settlement, lateral spreading permanent ground displacement, and seismic landslide slope instability. Also develop maps illustrating these hazards in relation to the city’s service area; and
6. Develop this memorandum summarizing the results of our evaluations, including updated hazard maps.

These tasks were completed at the identified city’s facilities as shown on Figures 2 to 6. In the following sections, we present the results of the data review, seismic hazards evaluation, and a summary of geotechnical hazards along the backbone system.

2.0 Data Review

We reviewed previous geotechnical reports and subsurface data for various projects in the area, conducted between 1990 and 2017. A list of reviewed documents is provided below:

- Preliminary Geotechnical Engineering Report, Old Tualatin Elementary School, Tualatin, Oregon, August 22, 2008, GeoPacific Engineering, Inc.
- Report of Geotechnical Engineering Services, Myslony Site, SW Myslony Street and SW 112th Avenue, Tualatin, Oregon, March 28, 2007, GeoDesign, Inc.
- Geotechnical Engineering Report, Proposed U-Haul Expansion, 7100 SW McEwan Road, Tualatin, Oregon, August 9, 2016, PSI.
- Final Summary Report Field and Laboratory Testing, SW 65th/SW Nyberg Street Improvements, Tualatin, Oregon, April 23, 2004, Northwest Geotech, Inc.
- Geotechnical Investigation, Bluff-Cipole Sanitary Sewer Extension, Tualatin, Oregon, January 18, 1996, GRI.
- Report of Geotechnical Engineering Services, Kock Corporate Center: Earthwork and Surcharging, SW 115th Avenue and SW Tualatin Sherwood Road, Tualatin, Oregon, June 9, 2009, GeoDesign, Inc.
- Geotechnical Investigation, Hageman Way Street Project, Tualatin, Oregon, March 16, 1990, Northwest Geotech, Inc.
- Geotechnical Engineering Services, Sanderson Subdivision, Tualatin, Oregon, June 16, 2000, GeoDesign, Inc.
- Geotechnical Exploration for Proposed C-2 Reservoir, Tualatin, Oregon, July 7, 1994, CH2M HILL.
- Preliminary Assessment of Subsurface Conditions Bluff-Cipole Sanitary Sewer Extension, Tualatin, Oregon, April 30, 1998, Northwest Geotech Inc.
- Geotechnical Engineering Services Addendum No. 1, Tualatin Business Park - Building 1, SW Myslony Street and SW 112th Avenue, Tualatin, Oregon, May 13, 2016, GeoDesign, Inc.
- Public Roadway Improvements, Library Oaks Townhome Subdivision, Tualatin, Oregon, June 5, 2000, Northwest Geotech, Inc.
- Tualatin Water Master Plan, Existing Transmission Backbone, Figure 2-4, October 2017, Murraysmith, Inc.
- Geotechnical Investigation, PTI-OSB Water Treatment Tank, 9900 SW Herman Road, Tualatin, Oregon, November 24, 2014, Carlson Geotechnical.
- Hedges Construction Drawing Review, SW 112th Avenue and SW Tualatin-Sherwood Highway, Tualatin, September 10, 2014, Perlo Construction.
- Geotechnical Data Report, SW 124th Avenue Water Transmission Line Project, March 6, 2014, Jacobs Associates.
- Draft Geotechnical Data Report, Willamette Water Supply Program, Pipeline Main Stem Section 4.2 (PLM_4.2), Washington County, July 31, 2017, Shannon and Wilson, Inc.

3.0 Site Reconnaissance

On May 30, 2018, Farid Sariosseiri, PE, performed a geotechnical reconnaissance of the following sites within the city's service area:

- A-2 Reservoir
- A-1 Reservoir (Avery Reservoir)
- Norwood Reservoirs and Pump Station
- Boones Ferry Pump Station and Supply Control Valve
- City Park Supply Control Valve
- 108th Operations Supply Control Valve

We selected these facilities for site visit because they are within the mapped seismic hazard zones or considered critical facilities (Figures 3, 4 and 5). During the reconnaissance, we noted site conditions, surface or exposed soil conditions, site topography, proximity to bodies of water, and significant features (i.e. culverts). Selected photographs from the site visits are provided in Appendix A. Our assessment results from the site visits and review of available data are discussed in Section 7.

4.0 Geology and Seismic Setting

4.1 Geologic Setting

The Tualatin basin is a structural depression created by complex folding and faulting of the basement rocks, a sequence of middle Miocene age, about 17 to 6 Ma (“Mega annum” or million years ago), lava flows of the Columbia River Basalt Group (CRBG). An extensive sedimentary fill was then accumulated in the basin and overlies the CRBG basement (Trimble, 1963; Tolan and Beeson, 1984). The Tertiary sedimentary units include up to 1,300 feet of the Sandy River Mudstone, which directly overlies the CRBG, and 100 to 350 feet of sandstone and conglomerate of the Troutdale Formation, which overlies the Sandy River Mudstone (Pratt et al., 2001).

Unconsolidated sediments at the top of the basin fill sequence consist primarily of catastrophic flood sediments deposited near the end of the last ice age, between 15,300 and 12,800 radiocarbon years ago (Mullineaux et. al., 1978; Waitt, 1987; Allen et al., 2009). Forty or more catastrophic floods occurred at intervals over several decades on the Columbia River system. The flood waters swept across the Tualatin basin and deposited tremendous loads of sediment. Boulders, cobbles, and gravels were deposited near the mouth of the Columbia River Gorge and along the main channel of the Columbia River, while great cobble and gravel bars stretched westward across the Portland basin, grading to thick blankets of micaceous sand. Within the Tualatin basin, the flood deposits mantle the Troutdale Formation at elevations below about 350 feet above mean sea level. The flood deposits generally consist of unconsolidated gravel topped by fine sand and silt and range from a few feet in thickness to more than 200 feet thick.

During the late Pliocene epoch, fluvial conglomerate, volcanoclastic sandstone, siltstone, and debris flow deposits, originating in the Cascade Range, were deposited in a broad fan in the Boring Hills area at the southern margin of the Tualatin basin (Tolan and Beeson, 1984). These deposits, the Springwater Formation, interfingered with the late Troutdale Formation sediments. Deposition of the Springwater Formation continued into the Pleistocene (Madin, 1994).

During the middle to late Pleistocene (after about 2 Ma), Boring Lava erupted from several local vents in the basin and in the Boring Hills south of Gresham, intruding the Sandy River Mudstone, Troutdale

Formation, and Springwater Formation sediments (Trimble, 1963; Madin, 1994). The lava flows were relatively thin and apparently of small volume because they do not appear to have flowed far from their source. Both the Springwater Formation and the Boring Lavas are very deeply weathered and decomposed.

During the late Pleistocene, wind-blown silt, or “loess” funneled westward through the Columbia River Gorge and accumulated on hilltops around the Tualatin basin. The loess deposits were named “Portland Hills Silt” for the thick accumulation that mantled Portland’s West Hills, but the loess is also present over the Boring Hills in the southern part of the basin. Lentz (1977) observed Boring Lava interbedded in loess deposits near Elk Point in the West Hills, helping to bracket the age of the silt between 36,000 and 700,000 years before the present time.

During the Holocene epoch (the last 10,000 years), minor alluvial deposits have accumulated along the several creeks and streams that drain the area. These young alluvial sediments are largely reworked from older materials in the Boring Hills and from the catastrophic flood deposits on the basin floor. Other active geologic processes include soil creep and landslide.

4.2 Seismic Setting

The Pacific Northwest is located near an active tectonic plate boundary. Off the coast, the Juan de Fuca oceanic plate is subducting beneath the North American crustal plate. This tectonic regime has resulted in seismicity in the Pacific Northwest occurring from three primary sources:

- Shallow crustal faults within the North American plate;
- CSZ intraplate faults within the subducting Juan de Fuca plate; and
- CSZ megathrust events generated along the boundary between the subducting Juan de Fuca plate and the overriding North American plate.

Among these three sources, CSZ megathrust events are considered as having the most hazard potential due to the anticipated magnitude and duration of associated ground shaking. Recent studies indicate that the CSZ can potentially generate large earthquakes with magnitudes ranging from 8.0 to 9.2 depending on rupture length. The recurrence intervals for CSZ events are estimated at approximately 500 years for the mega-magnitude full rupture events (magnitude 9.0 to 9.2) and 200 to 300 years for the large-magnitude partial rupture events (magnitude 8.0 to 8.5). Additionally, current research indicates the probability of a future occurrence because the region is “past due” based on historic and prehistoric recurrence intervals documented in ocean sediments. For example, over the next 50 years, the CSZ earthquake has an estimated probability of occurrence off the Oregon Coast on the order of 16 to 22 percent (Goldfinger et al., 2016).

In 2013, the State of Oregon developed the Oregon Resilience Plan (ORP, 2013) to prepare for the magnitude 9.0 CSZ event. We understand that this earthquake scenario is selected as the seismic source in the City of Tualatin’s seismic hazard study.

5.0 Subsurface Conditions

The subsurface within the project area is dominated by the following geologic units:

- Alluvial Deposits: Generally consist of soft fine grained material near existing surface water locations and low lying areas. This material is highly variable in its susceptibility to seismic liquefaction and lateral spreading hazards.
- Fine Grained Missoula Flood Deposits: Generally consist of very soft to stiff silt with varying concentrations of clay and sand. When saturated, this material is generally prone to seismic liquefaction and lateral spreading hazards.
- Coarse Grained Missoula Flood Deposits: Generally consist of medium dense to very dense sand and gravel with varying concentrations of silt. This material is generally seismically stable and not susceptible to liquefaction and lateral spreading permanent ground deformations.
- Troutdale Formation: Generally consists of very dense silty sand and gravel. This material is seismically stable and not susceptible to liquefaction and lateral spreading permanent ground deformations.
- Boring Lava: Generally consists of basalt in varying states of weathering. This material is seismically stable and not susceptible to liquefaction and lateral spreading permanent ground deformations.

A geologic map, provided in Figure 1, shows the overall distribution of these geologic units. In general, the subsurface conditions vary across the City of Tualatin's service area.

6.0 Geotechnical Seismic Hazards

The effect of seismic hazards, including strong ground shaking, liquefaction settlement, lateral spreading, and seismic-induced landslides, was analyzed. These hazards have the potential to damage facilities (i.e., pipelines, reservoirs, and pump stations) through either permanent ground deformation (PGD) or intense shaking. Our analysis of these seismic hazards is based on information provided from existing geotechnical explorations, DOGAMI hazard maps, and our knowledge of the geotechnical conditions of the area. In our seismic analyses, we assumed a magnitude 9.0 earthquake and a peak ground acceleration (PGA) of 0.20g to represent the effects of a M9 CSZ seismic event in the project area. No significant geotechnical data was available for pump stations and reservoirs within the city's service areas. Therefore, DOGAMI hazard maps and some exploration data along the I-5 were used for evaluation.

6.1 Ground Shaking

6.1.1 Seismic Ground Shaking Parameters for CSZ Earthquake

To assess the hazard potential of ground shaking in the project area, we reviewed the peak ground velocity (PGV) map published by DOGAMI for the Portland Metro Area in the event of a M9 CSZ earthquake (DOGAMI O-18-02, Bauer et. al., 2018).

The estimated ground shaking intensity (PGV) depends on the subsurface materials. The ground shaking near the surface will be amplified by thick soil units. Generally, the PGV values are estimated to range between 7 and 16 inches per second. The PGV map is shown in Figure 2.

6.2 Liquefaction

Liquefaction is a phenomenon affecting saturated, granular soils in which cyclic, rapid shearing from an earthquake results in a drastic loss of shear strength and a transformation from a granular solid mass to a viscous, heavy fluid mass. The results of soil liquefaction include loss of shear strength, loss of soil materials through sand boils, flotation of buried chambers/pipes, and post liquefaction settlement.

To evaluate the hazard potential of soil liquefaction in the project area, we reviewed liquefaction hazard maps published by DOGAMI for the Portland Metro Area in the event of a M9 CSZ earthquake (Bauer, et. al., 2018). Where geotechnical data was available, we conducted site specific analyses based on the subsurface conditions shown in previous geotechnical explorations listed in Section 2, using the latest SPT-based liquefaction susceptibility and settlement assessment procedures (Boulanger and Idriss, 2014; Idriss and Boulanger, 2008). Based on our calculated post-liquefaction settlement results, we revised DOGAMI's liquefaction probability map and developed a liquefaction induced settlement map (see Figures 3 and 4).

The liquefaction hazard varies significantly across the city. The potential for liquefaction is low in the south and northeast of the project area due to shallow bedrock (at the south) and Coarse-Grained Missoula Flood Deposits (in the northeast). Liquefiable soils are present in the rest of the city area where Fine-Grained Missoula Flood Deposits and Alluvial Deposits are located. Estimated settlement ranges from a few inches in the silty Flood Deposits to more than 10 inches in the silty and sandy Alluvial soils along Tualatin River.

6.3 Lateral Spreading

Liquefaction can result in progressive deformation of the ground known as lateral spreading. The lateral movement of liquefied soil breaks the non-liquefied soil crust into blocks that progressively move downslope or toward a free face in response to the earthquake generated ground accelerations. Seismic movement incrementally pushes these blocks downslope as seismic accelerations overcome the strength of the liquefied soil column. The potential for and magnitude of lateral spreading depends on the liquefaction potential of the soil, the magnitude and duration of earthquake ground accelerations, the site topography, and the post-liquefaction strength of the soil.

To assess the hazard potential of lateral spreading in the project area we reviewed a lateral spreading hazard map published by DOGAMI for the Portland Metro Area in the event of a M9 CSZ earthquake (Bauer et. al., 2018). To verify and refine the map, we used pseudo-static slope stability analyses for areas with gentle slope with no free face and used the lateral displacement index (LDI) method (Zhang et. al., 2004) for areas with free face (gentle slope and flat ground).

The pseudo-static slope stability analyses were completed using the computer software SLIDE to calculate the approximate slope at which lateral spreading may occur. In our analyses, we used an average residual shear strength of 250 psf for the liquified soil. The residual shear strength was estimated for Missoula Flood Deposits and Alluvial soils assuming soft consistency. A pseudo-static coefficient of 0.1g, approximately ½ of PGA was applied. The results of the analyses indicate that lateral spreading may occur for slopes steeper than 12 percent (7 degrees) located within liquefaction susceptible areas.

The LDI method involves integrating shear strains over the depth of potentially liquefiable soils. The LDI method was used for areas with free face. We modified the map within the areas with free face based on the distance from the free face and the height of the free face.

The estimated lateral displacements are shown in Figure 5. The majority of the lateral spreading exists within the northern part of the service area, along the Tualatin River, and near the Nyberg Creek areas.

6.4 Seismic Landslides

Earthquake induced landslides can occur on slopes due to the inertial force from an earthquake adding load to a slope. The ground movement due to landslides can be extremely large and damaging to pipelines and other structures.

To assess the hazard potential of seismic landslides in the project area we reviewed a landslide deformation map published by DOGAMI for the Portland Metro Area in the event of a M9 CSZ earthquake (Bauer et. al., 2018). We reviewed the topography of the project area in conjunction with visual assessment of slopes during our site visit. Except for the areas near the bank of creeks and the Tualatin River, the risk of seismic landslide in the city is considered low. Seismic landslide displacements are shown in Figure 6.

7.0 Seismic Hazard Assessment and Recommendations for Critical Facilities

In addition to the seismic hazard study for the overall service area, we conducted site visits to six sites, including reservoirs, pump stations, and supply control valves, which are located within or near the mapped liquefaction areas. These facilities are listed in Table 1 and shown in Figures 1 through 6 (along with other facilities). Table 1 presents the summaries of the results of the site visit, document review, as well as the geotechnical opinions regarding the seismic hazards and geotechnical concerns at these locations. Recommendations for future studies and mitigations are also provided in Table 1.

Seismic hazards for the rest of the sites are relatively low. We recommend further evaluation of these sites to be combined with future improvement projects for the sites.

MCMILLEN JACOBS ASSOCIATES

Farid Sariosseiri, P.E.
Senior Project Engineer

Wolfe Lang, P.E., G.E.
Senior Associate

Table 1. Preliminary Seismic Hazard Assessment Summary for Critical Facilities

Structure Name	Available or Nearby Geotechnical Information	Mapped Seismic Hazards and Levels	Anticipated Subsurface Conditions and Site Topography	Preliminary Geotechnical Seismic Concerns & Issues	Recommendations/Notes
A-2 Reservoir	Review of the available geotechnical information at the City of Tualatin Operation Office indicate bedrock within 2 feet of the ground surface.	Liquefaction settlement and lateral spreading is not anticipated at the site.	The site is located at the top a hill with a gentle slope toward north. The reservoir is located approximately 250 feet behind the top of the slope. Basalt outcrop was observed at south side of the reservoir. Geologic map indicates the site is underlain by Basalt, consistent with our observation.	Subsurface data was briefly reviewed in the City of Tualatin Operations office.	Liquefaction hazard is negligible. A thorough review of the existing data is recommended to confirm the mapped subsurface conditions.
A-1 Reservoir (Avery Reservoir)	No geotechnical data available.	Risk of liquefaction settlement and lateral spread is anticipated to be relatively low.	The site is located on a flat ground, but in general the area is gently sloped toward the north. The reservoir was built in the 1960's and was seismically upgraded in 2005. No creek or water body was identified near the site. The geologic map indicates the site is near the limit of Basalt and Fine-grained Missoula Flood Deposits. Rock outcrop was not observed at or near the site. We anticipate a relatively shallow bedrock underlain Fine-grained Missoula Flood Deposits across the site.	Lack of subsurface information.	Considering the subsurface conditions, liquefaction hazard is anticipated to be low. From a seismic hazard risk perspective, a site-specific study for this reservoir may not need to be prioritized and can be combined with future site improvement design.
Noorwood Reservoirs and Pump Station	No geotechnical data available.	Liquefaction settlement and lateral spreading is not anticipated at the site.	The site is located on a flat area. The reservoirs' foundation levels are approximately 3 feet lower than adjacent ground. The pump station was built in 2009. The reservoirs appear to predate the pump station. No creek or a body of water was identified near the site. The geologic map indicates the site is underlain by Basalt. Rock outcrop was not observed at or near the site.	Lack of subsurface information.	Liquefaction hazard is anticipated to be low. From a seismic hazard risk perspective, a site-specific study for this site may not need to be prioritized, and can be combined with future site improvement design.
Boones Ferry Pump Station and Supply Control Valve	No geotechnical data available.	Liquefaction settlement: 5 to 8 inches, Lateral spreading displacement: 0.5 to 3 feet.	The site is located on a gently northern slope. A body of water (a wetland) was identified approximately 2,000 feet northwest of the site using aerial image (Google Earth). The geologic map indicates the site is underlain by Fine-grained Missoula Flood Deposits.	Lack of subsurface information.	Perform subsurface investigation and site-specific hazard evaluation.
City Park Supply Control Valve	No geotechnical data available.	Liquefaction settlement: 5 to 8 inches, Lateral spreading displacement: 0.5 to 3 feet.	The site is located on a flat area, approximately 300 feet from the Tualatin River. Geologic map indicates the site is located near the limit of alluvium and Missoula Flood Deposits.	Lack of subsurface information.	Perform subsurface investigation and site-specific stability evaluation.
108 th Operations Supply Control Valve	No geotechnical data available.	Liquefaction settlement: 5 to 8 inches, Lateral spreading displacement: 0.5 to 3 feet.	The site is located on a flat area. A body of water (a wetland) was identified approximately 1,000 feet south of the site using aerial image (Google Earth). The geologic map indicates the site is underlain by Fines-grained Missoula Flood Deposits.	Lack of subsurface information.	Perform subsurface investigation and site-specific stability evaluation.

8.0 References

- Allen, J., Burns, M., and Burns, S., 2009, *Cataclysms on the Columbia: The Great Missoula Floods*, Portland, Oregon., Ooligan Press, 211 p.
- Bauer, J.M., Burns, W.J., and Madin, I.P, 2018, Open File Report O-18-02, Earthquake Regional Impact Analysis for Clackamas, Multnomah, and Washington Counties, Oregon. Oregon Department of Geology and Mineral Industries (DOGAMI).
- Boulanger, R.W. and Idriss, I.M., 2014. CPT and SPT Based Liquefaction Triggering Procedures, Report No. UCD/CGM 14-01, Center for Geotechnical Modeling, Department of Civil and Environmental Engineering, UC Davis, April 2014.
- Goldfinger, C., Galer, S., Beeson, J., Hamilton, T., Black, B., Romsos, C., Patton, J., Hans Nelson, C., Hausmann, R., and Morey, A., 2016, *The Importance of Site Selection, Sediment Supply, and Hydrodynamics: A Case Study of Submarine Paleoseismology on the Northern Cascadia Margin*, Washington USA, Marine Geology.
- Idriss, I. and Boulanger, R., 2008, *Soil Liquefaction During Earthquakes*. Monograph MNO-12, Earthquake Engineering Research Institute, Oakland, CA, 261 p.
- Lentz, R., 1977, *The Petrology and Stratigraphy of the Portland Hills Silt—A Pacific Northwest Loess*: Oregon Geology, v. 43, n. 1, pp. 3-10.
- Madin, I., 1994, *Geologic Map of the Damascus Quadrangle, Clackamas and Multnomah Counties, Oregon*: Oregon Department of Geology and Mineral Industries Geological Map Series GMS-60, scale 1:24,000.
- Mullineaux, D., Wilcox, R., Ebaugh, W., Fryxell, R., and Rubin, M., 1978, *Age of the Last Major Scabland Flood of the Columbia Plateau in Eastern Washington*: Quaternary Research, v. 10, no. 2, p. 171-180.
- Pratt, T., Odum, T., Stephenson, W., Williams, R., Dadisman, S., Holmes, M., and Haug, B., 2001, *Late Pleistocene and Holocene Tectonics of the Portland basin, Oregon and Washington, from High-Resolution Seismic Profiling*: Bulletin of the Seismological Society of America, v. 91, n. 4., pp. 637-650.
- The Oregon Resilience Plan (ORP), 2013, *Reducing Risk and Improving Recovery for the Next Cascadia Earthquake and Tsunami*, Report to the 77th Legislative Assembly, Salem, Oregon.
- Tolan, T., and Beeson, M., 1984, *Intracanyon Flows of the Columbia River Basalt Group and their Relationship to the Troutdale Formation*: Geological Society of America Bulletin v. 95, no. 4, p. 463-477.
- Trimble, 1963, *Geology of Portland, Oregon and Adjacent Areas: A Study of Tertiary and Quaternary Deposits, Lateritic Weathering Profiles, and of Quaternary History of Part of the Pacific Northwest*: U.S. Geological Survey Bulletin 1119, 119 p.

Waite, R., 1987, Evidence for Dozens of Stupendous Floods from Glacial Lake Missoula in Eastern Washington, Idaho, and Montana, in Hill, M., ed., Cordilleran Section of the Geological Society of America: Boulder, Colo., Geological Society of America Centennial Field Guide, v. 1, p.345-350.

Zhang, G., Robertson, P.K., and Brachman, W.I., 2004, Estimating Liquefaction-induced Lateral Displacement Using the Standard Penetration Test or Cone Penetration Test, Journal of Geotechnical and Geoenvironmental Engineering, Vol. 130, No. 8, p861-871.

Figures

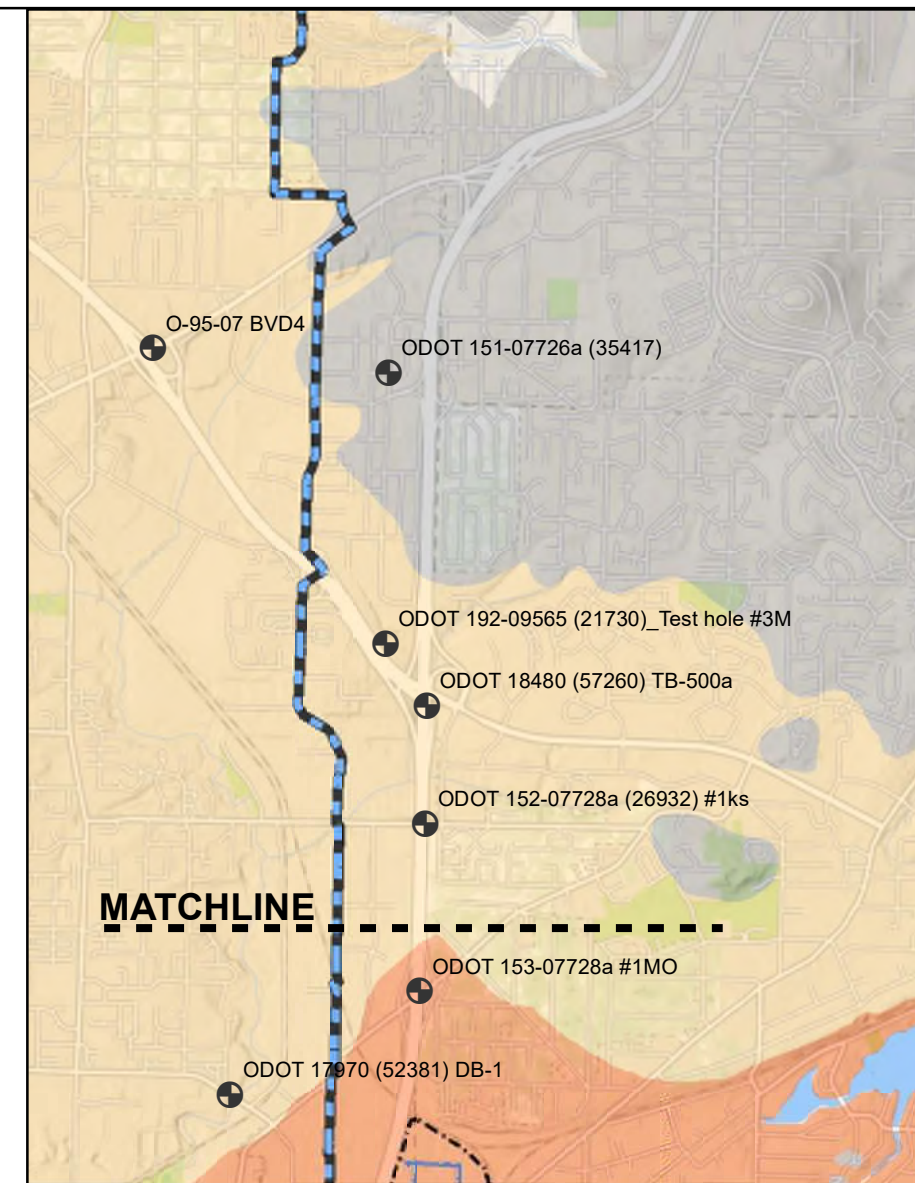
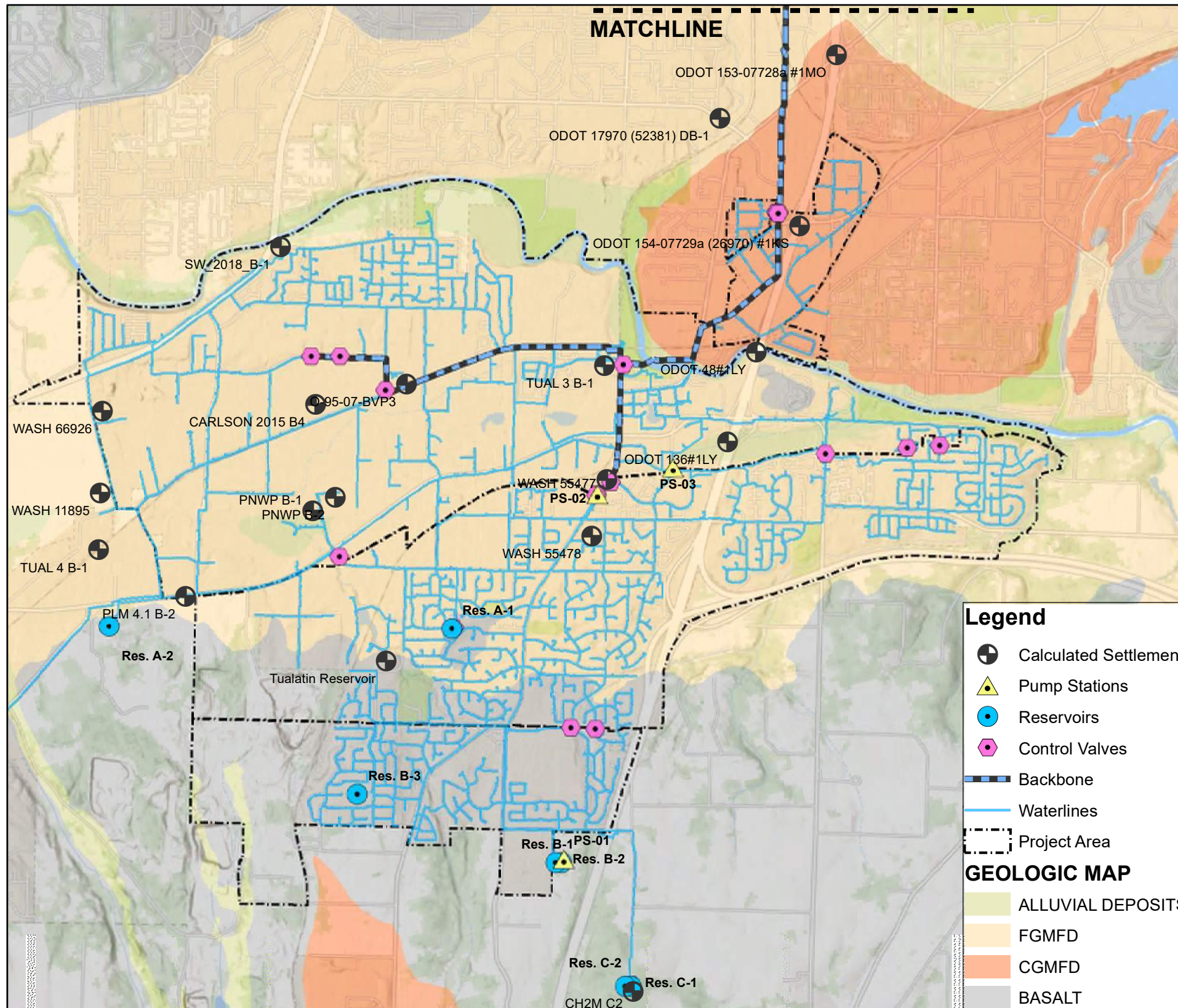

NOTES:

1. FGMFD: FINE-GRAINED MISSOULA FLOOD DEPOSITS
2. CGMFD: COARSE-GRAINED MISSOULA FLOOD DEPOSITS
3. DATA SOURCE: DOGAMI OGDC-6
Topographic Map 3D - Portland, OR USA: Esri, Esri Community Maps Contributors

GEOLOGIC MAP

1" = 3,000'

0 3,000 6,000'



TUALATIN WATER
SEISMIC HAZARD EVALUATION
TECHNICAL MEMORANDUM
SEISMIC HAZARDS
GEOLOGIC MAP

FIG. 1

Jun 2018

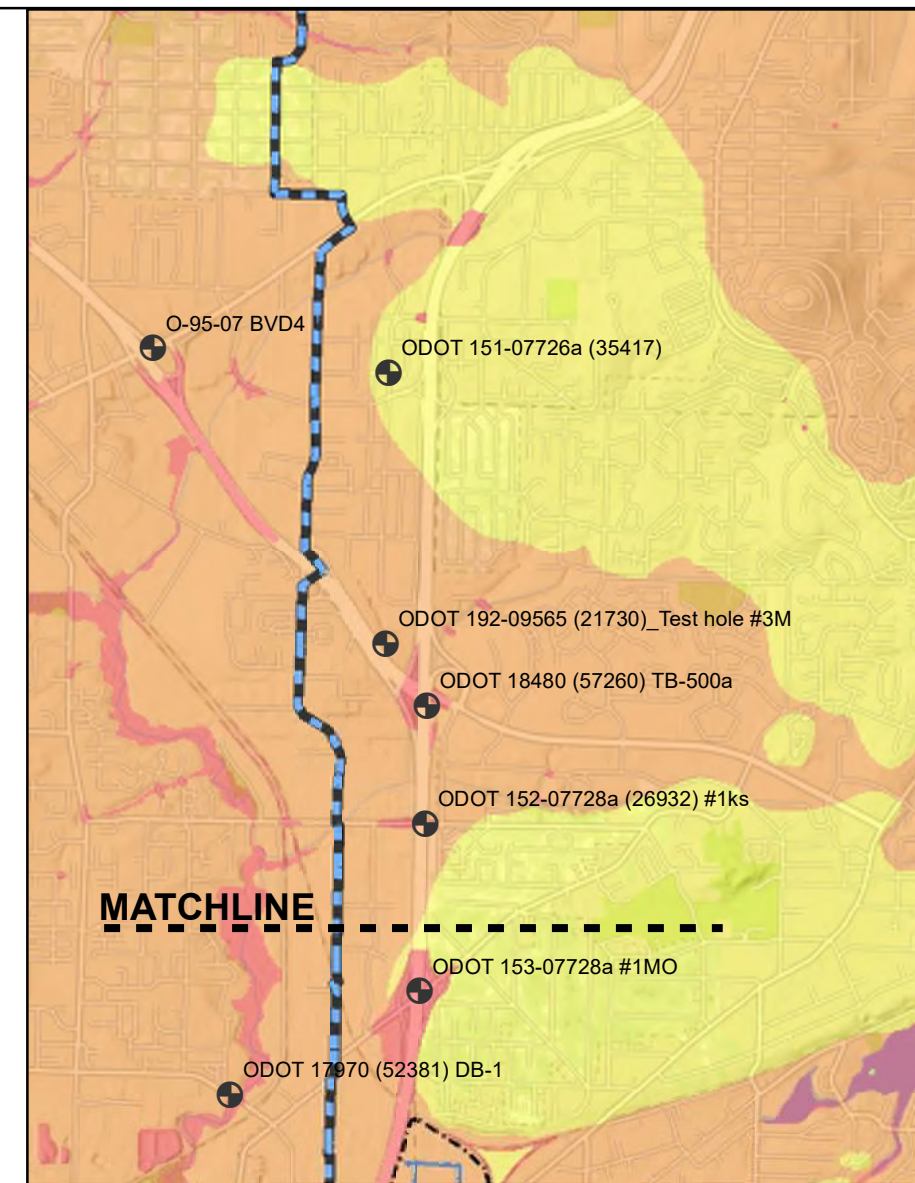
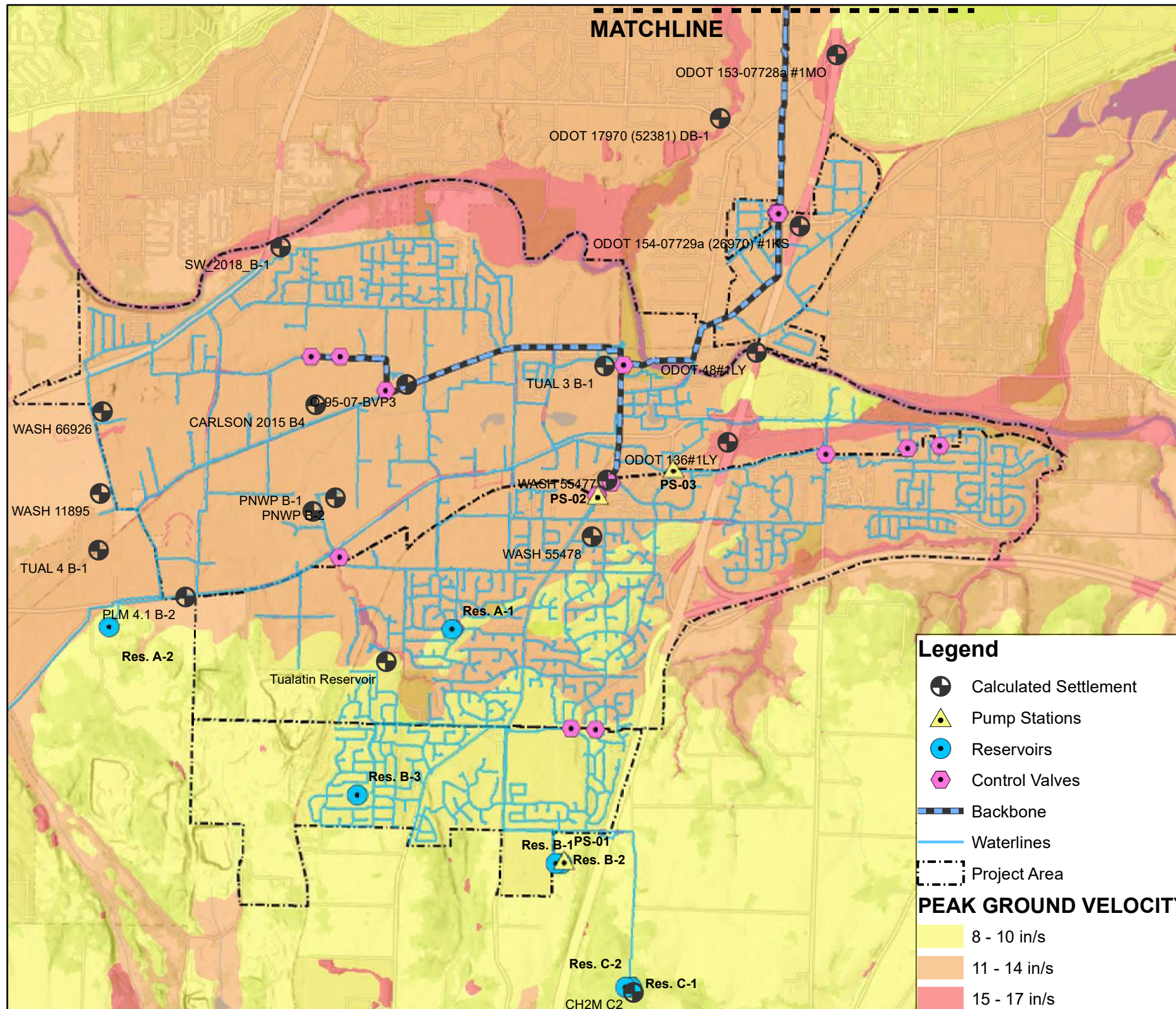

NOTES:

- ESTIMATES SHOWN ARE BASED ON HAZARD DATA FROM DOGAMI OPEN-FILE REPORT O-18-02 AND DATA FROM EXISTING BORINGS. AREAS OUTSIDE OF EXISTING BORING LOCATIONS HAVE NOT BEEN VERIFIED.
- DATA SOURCE: DOGAMI O-18-02
Topographic Map 3D - Portland, OR USA: Esri, Esri Community Maps Contributors

PEAK GROUND VELOCITY

1" = 3,000'

0 3,000 6,000'



TUALATIN WATER
SEISMIC HAZARD EVALUATION
TECHNICAL MEMORANDUM
SEISMIC HAZARDS
PEAK GROUND VELOCITY

FIG. 2

Jun 2018

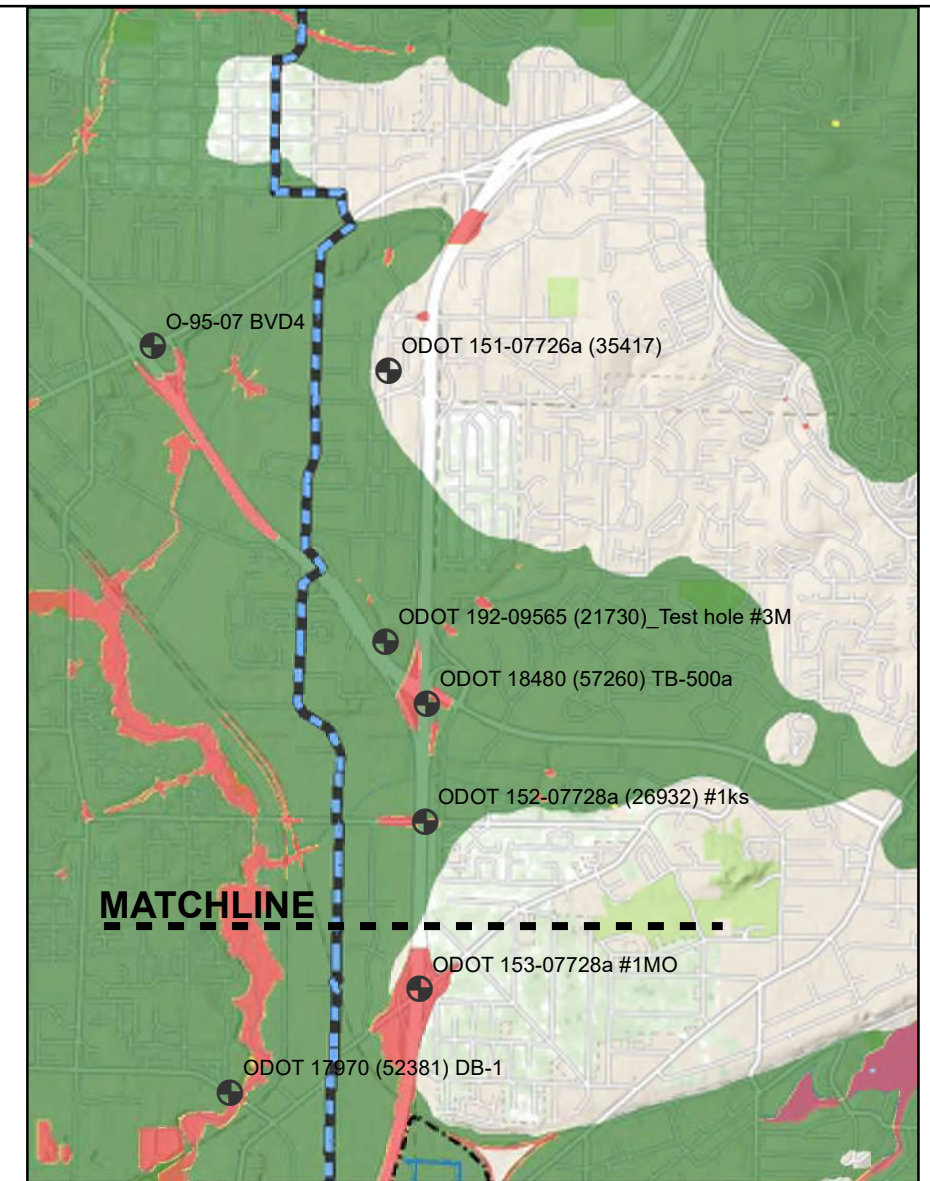
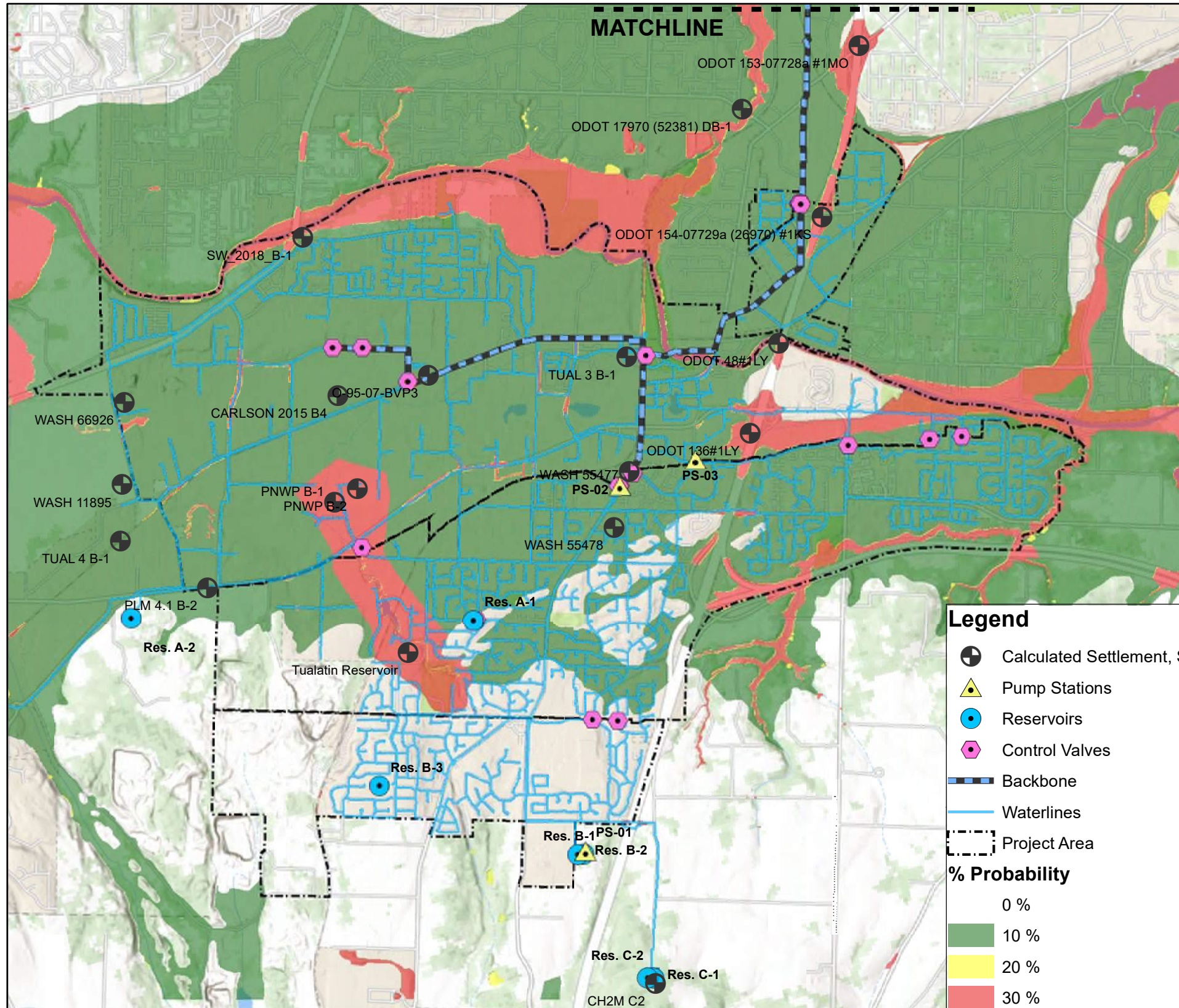

Legend

- ⊕ Calculated Settlement, S
- ▲ Pump Stations
- Reservoirs
- ⬠ Control Valves
- ▬ Backbone
- Waterlines
- ⋯ Project Area

% Probability

- 0 %
- 10 %
- 20 %
- 30 %

NOTES:

1. ESTIMATES SHOWN ARE BASED ON HAZARD DATA FROM DOGAMI OPEN-FILE REPORT O-18-02 AND DATA FROM EXISTING BORINGS. AREAS OUTSIDE OF EXISTING BORING LOCATIONS HAVE NOT BEEN VERIFIED.
2. DATA SOURCE: DOGAMI O-18-02
Topographic Map 3D - Portland, OR USA: Esri, Esri Community Maps Contributors

PROBABILITY OF LIQUEFACTION

1" = 3,000'

0 3,000 6,000'



TUALATIN WATER	FIG. 3
SEISMIC HAZARD EVALUATION	
TECHNICAL MEMORANDUM SEISMIC HAZARDS PROBABILITY OF LIQUEFACTION	

Jun 2018

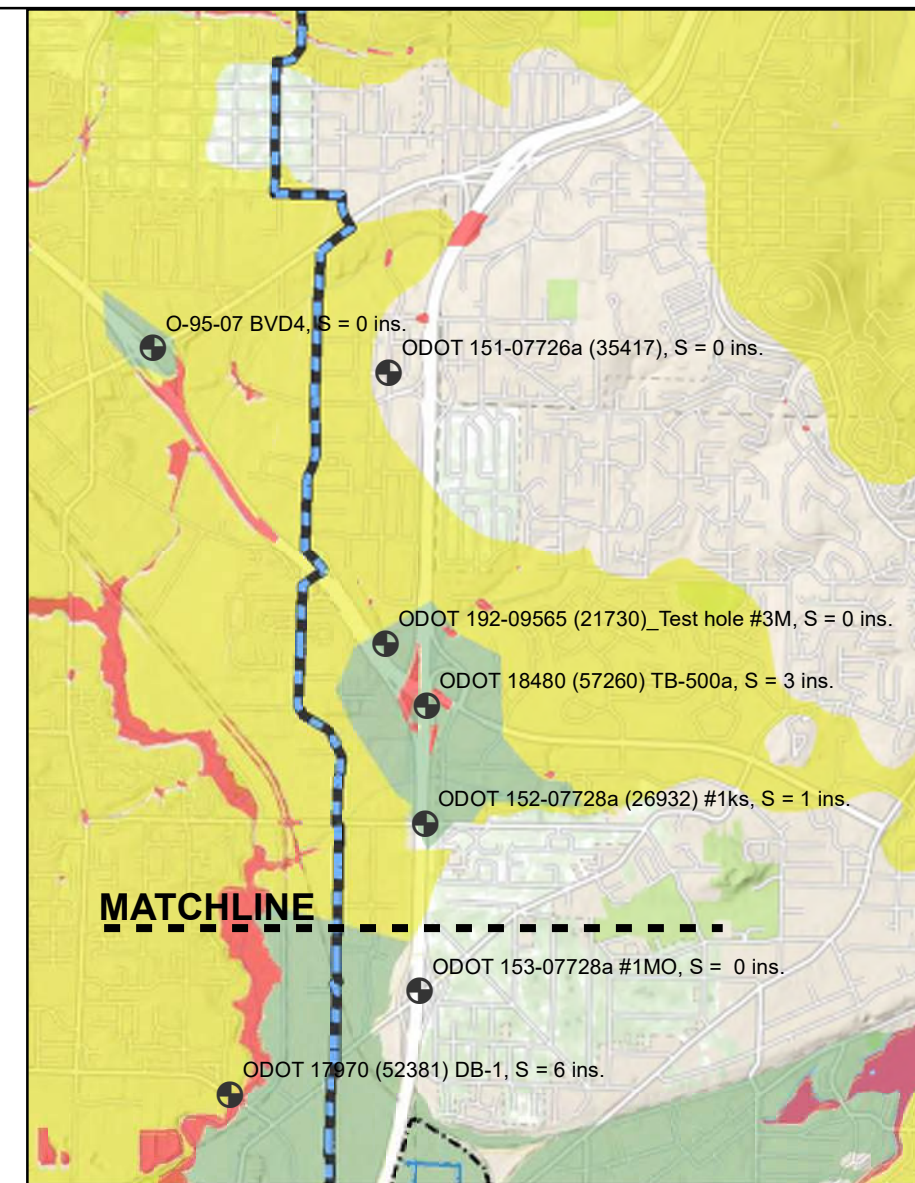
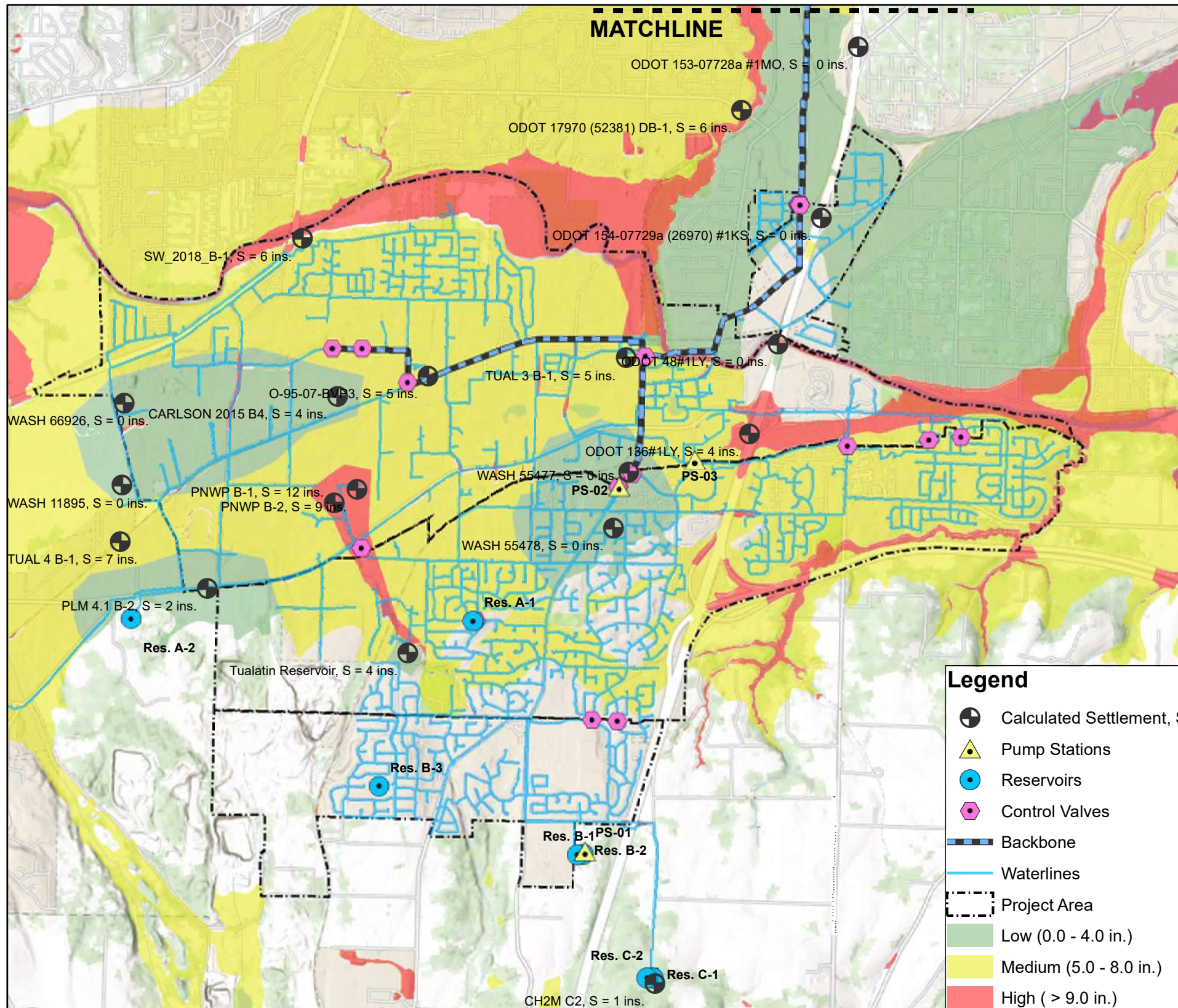

Legend

- ⊕ Calculated Settlement, S
- ▲ Pump Stations
- Reservoirs
- ⬠ Control Valves
- ▬ Backbone
- Waterlines
- - - Project Area
- Low (0.0 - 4.0 in.)
- Medium (5.0 - 8.0 in.)
- High (> 9.0 in.)

NOTES:

1. ESTIMATES SHOWN ARE BASED ON HAZARD DATA FROM DOGAMI OPEN-FILE REPORT O-18-02 AND DATA FROM EXISTING BORINGS. AREAS OUTSIDE OF EXISTING BORING LOCATIONS HAVE NOT BEEN VERIFIED.
2. DATA SOURCE: DOGAMI O-18-02
Topographic Map 3D - Portland, OR USA: Esri, Esri Community Maps Contributors

LIQUEFACTION-INDUCED SETTLEMENT

1" = 3,000'

0 3,000 6,000'



TUALATIN WATER
SEISMIC HAZARD EVALUATION
TECHNICAL MEMORANDUM
SEISMIC HAZARDS
LIQUEFACTION-INDUCED SETTLEMENT

FIG. 4

Jun 2018

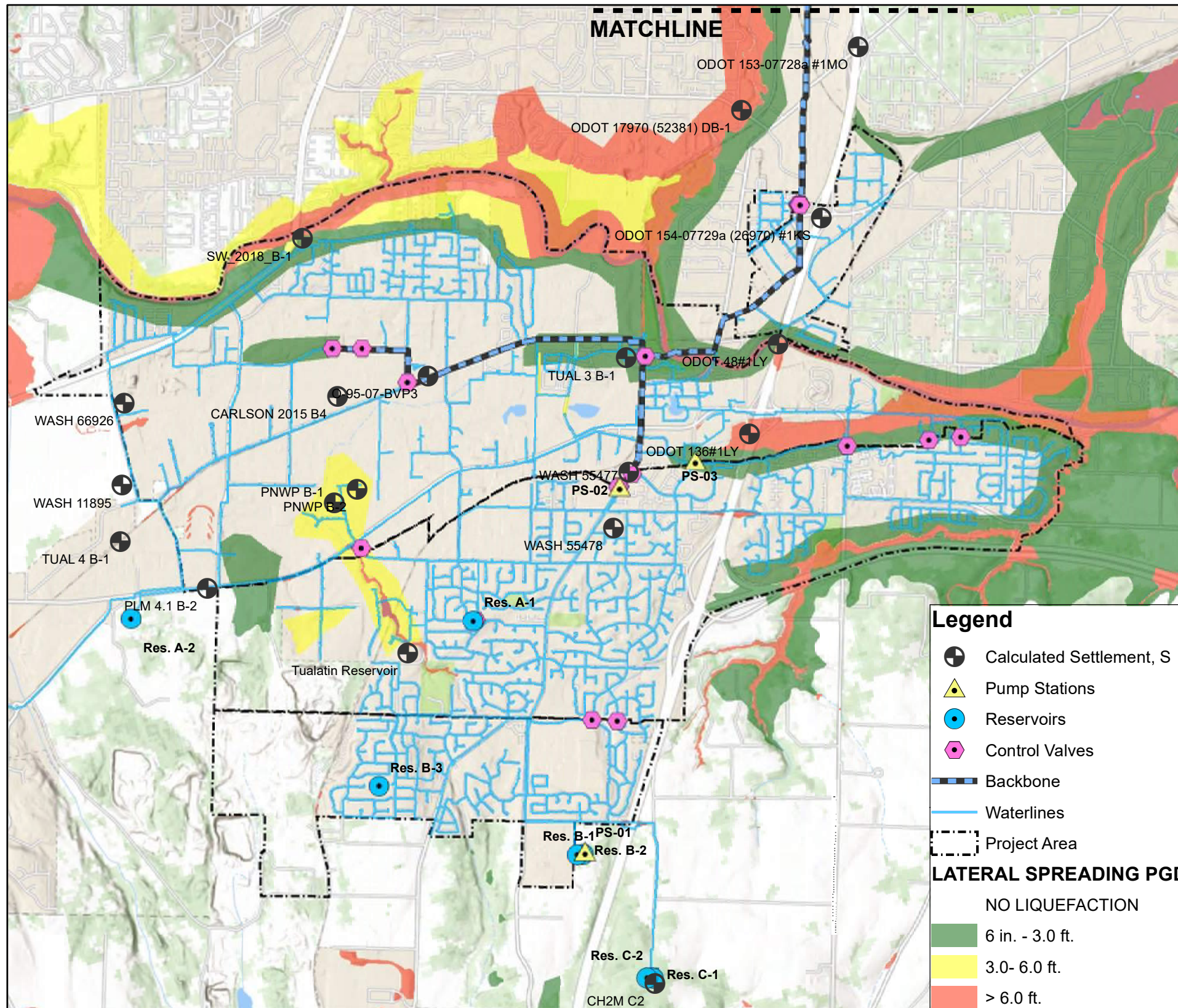

Legend

- Calculated Settlement, S
- Pump Stations
- Reservoirs
- Control Valves
- Backbone
- Waterlines
- Project Area

LATERAL SPREADING PGD

- NO LIQUEFACTION
- 6 in. - 3.0 ft.
- 3.0 - 6.0 ft.
- > 6.0 ft.

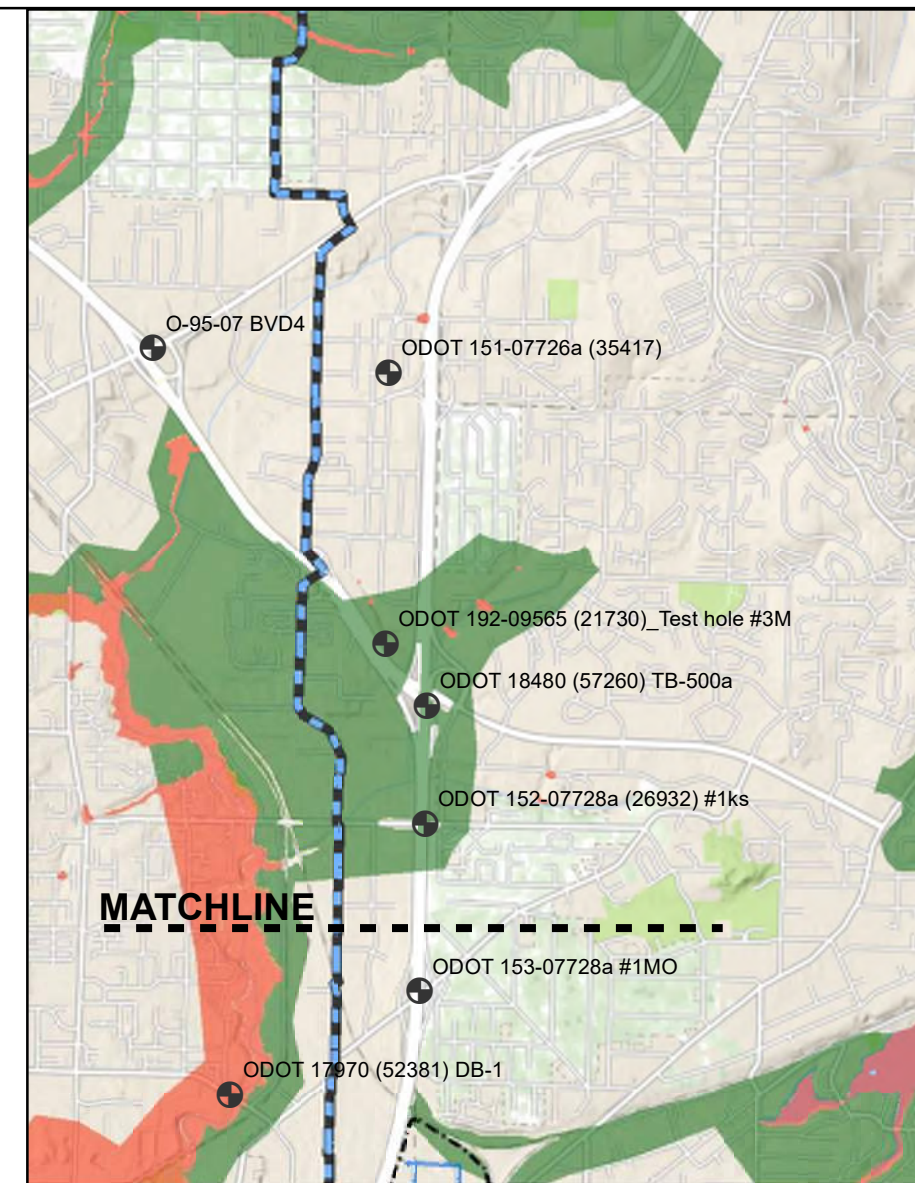

- NOTES:
- ESTIMATES SHOWN ARE BASED ON HAZARD DATA FROM DOGAMI OPEN-FILE REPORT O-18-02 AND DATA FROM EXISTING BORINGS. AREAS OUTSIDE OF EXISTING BORING LOCATIONS HAVE NOT BEEN VERIFIED.
 - DATA SOURCE: DOGAMI O-18-02
Topographic Map 3D - Portland, OR USA: Esri, Esri Community Maps Contributors



TUALATIN WATER
SEISMIC HAZARD EVALUATION
TECHNICAL MEMORANDUM
SEISMIC HAZARDS
LATERAL SPREADING DISPLACEMENT

FIG. 5
Jun 2018

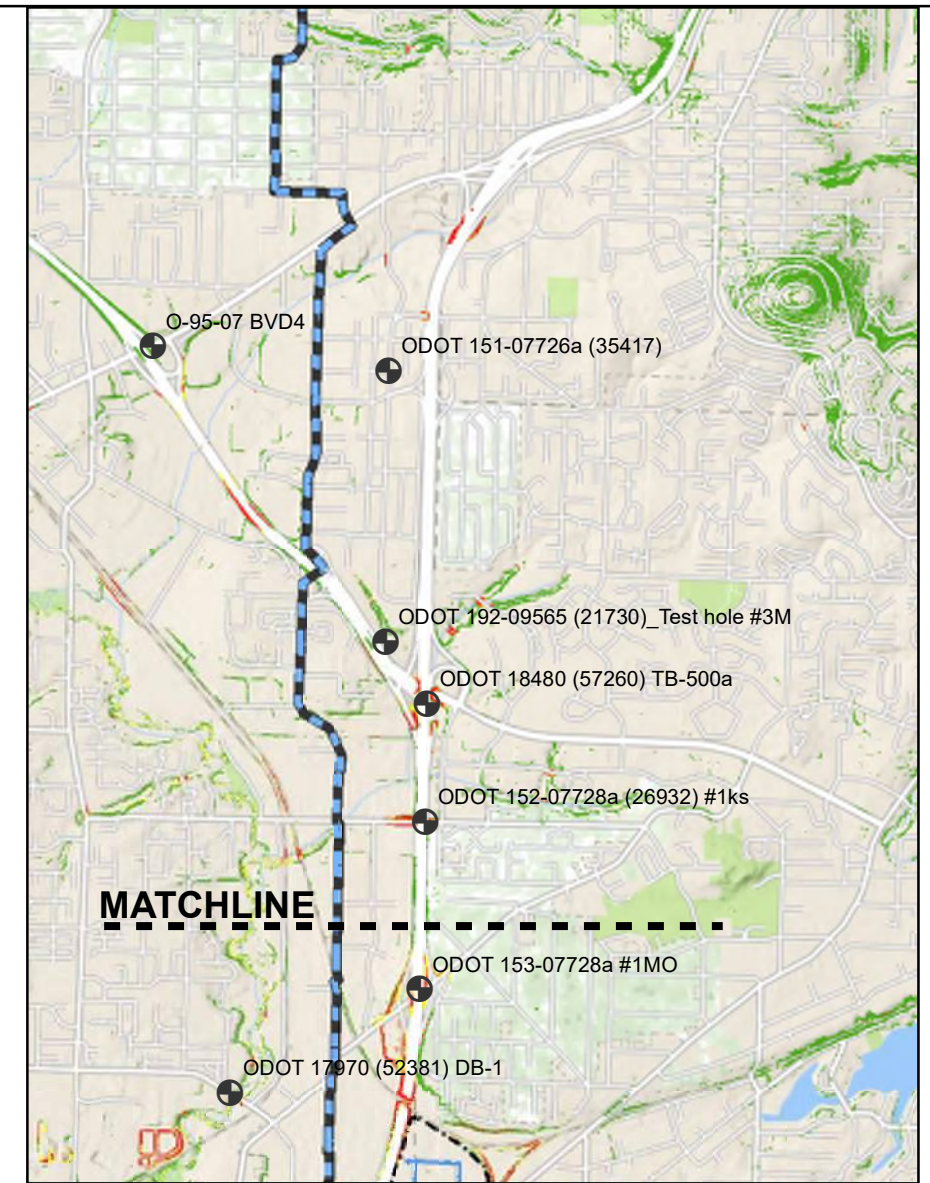
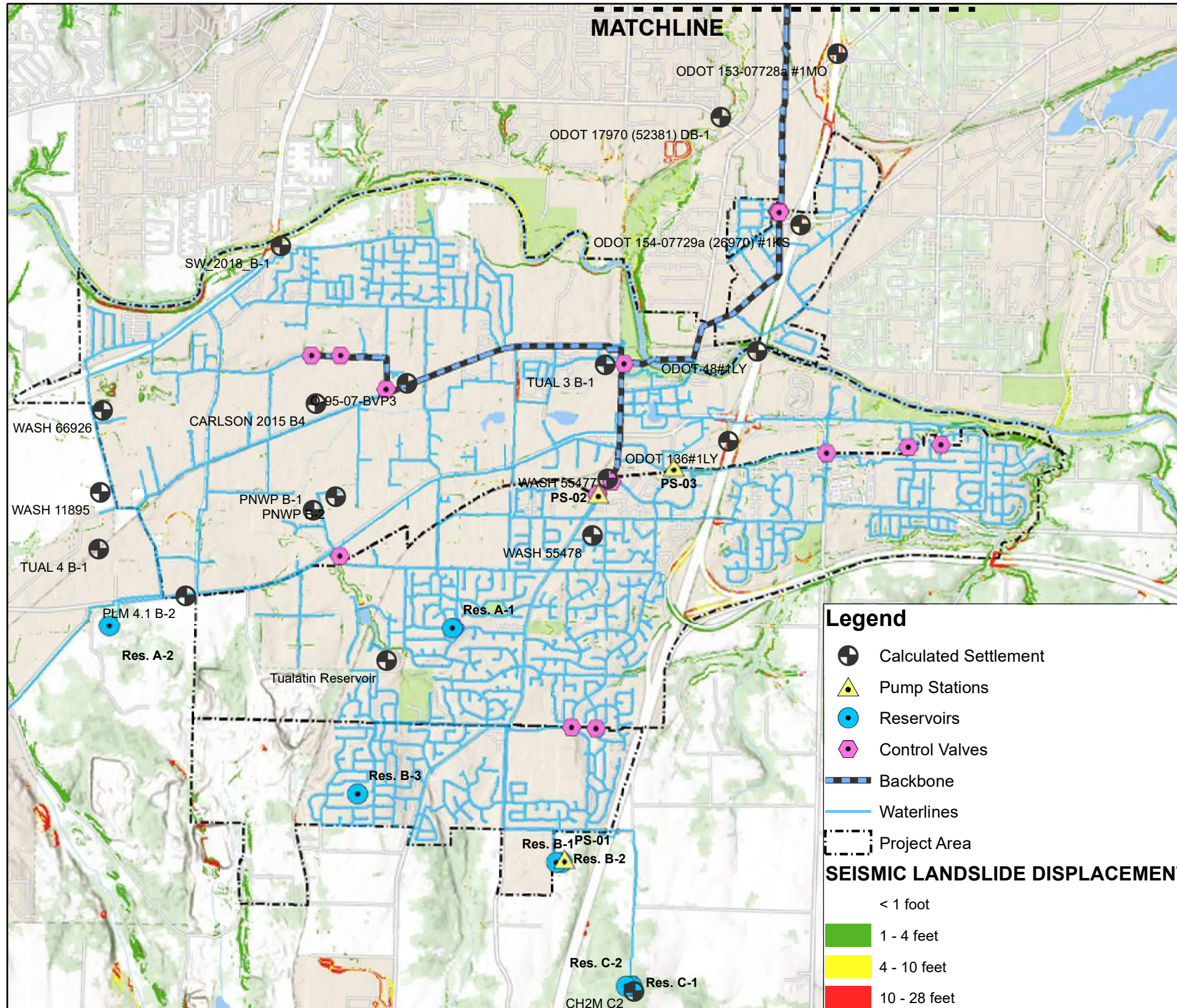

NOTES:

1. ESTIMATES SHOWN ARE BASED ON HAZARD DATA FROM DOGAMI OPEN-FILE REPORT O-18-02 AND DATA FROM EXISTING BORINGS. AREAS OUTSIDE OF EXISTING BORING LOCATIONS HAVE NOT BEEN VERIFIED.
2. DATA SOURCE: DOGAMI O-18-02
Topographic Map 3D - Portland, OR USA: Esri, Esri Community Maps Contributors

SEISMIC LANDSLIDE DISPLACEMENT

1" = 3,000'

0 3,000 6,000'



TUALATIN WATER
SEISMIC HAZARD EVALUATION
TECHNICAL MEMORANDUM
SEISMIC HAZARDS
SEISMIC LANDSLIDE DISPLACEMENT

FIG. 6

Jun 2018

Appendix A Site Visit Photos



Photo 1: A-2 Reservoir, looking south (May 30, 2018).



Photo 2: A-2 Reservoir, rock outcrop south of the reservoir (May 30, 2018).



Photo 3: A-2 Reservoir site, looking north (May 30, 2018).



Photo 4: A-1 Reservoir, foundation and structure elements (May 30, 2018).



Photo 5: Norwood reservoirs and pump station, looking south (May 30, 2018).



Photo 6: Norwood reservoirs and pump station, looking west (May 30, 2018).



Photo 7: Boones Ferry Road Pump Station and Supply Control Valve (May 30, 2018).



PORTLAND OFFICE

9400 SW Barnes Rd.
Suite 100
Portland, OR 97225
Phone: 503.292.1635

5/21/18

Brian Ginter
Murraysmith
888 SW 5th Ave., Suite 1170
Portland, OR 97204

File: PSE\17-128-12

Re: City of Tualatin Resiliency Investigation – Visual Observations Report

Dear Brian,

The following report serves to convey the results of our visual observation inspections of various water system structures for the City of Tualatin. Various facilities were selected by the City for high level inspection, review and preliminary recommendations by an engineer. The purpose of this report is to provide our visual observation comments on the general condition of each structure and to provide a condition rating and opine on the expected level of seismic performance. Please note that we have performed no load-based analysis of the subject structures and that seismic performance is based solely on building age, condition and type and the opinions of an Oregon licensed Professional Engineer.

Overview

On April 25th, 2018 members of our office joined members of the City of Tualatin staff to observe a total of 10 structures. The structures ranged from pump stations to various water storage reservoirs. Our observations were limited to the visible elements provided for inspection; the duration of each structure inspection averaged approximately 30 minutes of site time.

We've given each structure a "Condition Rating" which is indicative of the overall structural condition of the structure, with some adjustment for age. For example, a structure rated an "8" indicates that the structure is largely in good condition but shows some minor signs of wear. A structure rated a "4" indicates that the structure shows more extensive wear and will need to be repaired or replaced in the near term. The condition rating is not a descriptor of design quality and notable deficiencies are highlighted in the text.

We've also given a "Seismic Performance Expectation" for each structure. This is based on a visual inspection of the structure for obvious deficiencies and review of the original construction drawings, where available. In conjunction with our review of the construction drawings, we've also reviewed the "Benchmark Buildings" criteria from the ASCE 41 "Seismic Evaluation of Existing Buildings" to assist in our seismic performance expectation rating. The benchmark building gives a baseline code edition for many types of buildings; if the building is designed to the benchmark code (or a later iteration of that code) the building is likely to have been detailed sufficiently to prevent a catastrophic failure or life-safety risk in a seismic event.

The following is a list of structures captured in the current observations:

Pump Stations:

- ASR Pump Station
- Boones Ferry Control Station
- Martinazzi Pump Station
- C Level Norwood Pump Station

Water Storage Reservoirs:

- 2.2 MG A1 Reservoir – Welded Steel
- 5.0 MG A2 Reservoir – Welded Steel
- 2.2 MG B1 Reservoir – Welded Steel
- 2.8 MG B2 Reservoir – Welded Steel
- 0.8 MG C1 Reservoir – Welded Steel
- 1.0 MG C2 Reservoir – Welded Steel

Description of Ratings

The condition ratings show in this report are indicative of the overall structure condition, as observed and documented during our site visit. The supporting commentary for each structure was developed from further review of our photos and notes, and of the available as built drawings.

Condition Rating Scale:

<u>Rating</u>	<u>Description</u>
9-10	Very Good
7-8	Good, Shows Slight Signs of Wear
5-6	Shows Expected Level of Aging
3-4	Shows Wear and Will Need Rehabilitation or Replacement
1-2	Should be Replaced or Rehabilitated As Soon As Possible

Seismic Performance Expectation Scale:

<u>Rating</u>	<u>Description</u>
Good	Structure likely to perform well with minor damage, re-occupancy and maintained serviceability likely, some repairs necessary
Moderate	Structure likely to retain primary shape without collapse, expect moderate to heavy damage, re-occupancy and maintained serviceability possible, extensive repairs or replacement expected
Poor	Partial or comprehensive structure collapse likely with extensive damage, re-occupancy and maintained serviceability unlikely, extensive repairs or structure replacement probable

Pump Stations

ASR Pump Station

Condition Rating: 9

Seismic Performance Expectation: Good

Comments:

The ASR Pump Station is a concrete masonry unit building constructed in 2010. It has a nail plated wood truss roof and a concrete foundation. It is in good condition and with a recent design and construction date we expect it would meet the current requirements of an ASCE 41 seismic evaluation. While on site we noted a standby generator positioned near the building. The standby generator is considered temporary at this time and therefore does not require seismic anchorage, however if it becomes a permanent installation it should be anchored. Most of the piping and mechanical equipment inside the structure appeared to be adequately braced for seismic resistance. However, we noted a few elements that should be evaluated and upgraded with code compliant seismic bracing, including the electrical cabinets, vent fans, and the chemical barrels in the room at the North side of the building.



ASR Pump Station



ASR Pump Station – Temporary Generator



ASR Pump Station – Electrical Cabinets & Hanging HVAC Equipment



ASR Pump Station – Unbraced Chemical Barrels

Boones Ferry Control Station

Condition Rating: 3

Seismic Performance Expectation: Poor

Comments:

The Boones Ferry Control Station is a buried pre-cast concrete panel structure with an assumed construction date of mid to late 1980s according to city personnel. There does not appear to be a mechanical connection between the wall panels and the roof or floor panels. The structure appears to be in poor condition and shows more than the expected level of aging for assumed date of construction. It is expected during a code level seismic event that this structure will perform poorly. Because of the buried nature of the structure, performing upgrades to increase seismic performance is likely not an economically viable endeavor. Additionally, the piping is lacking modern bracing and flexible joints at wall penetrations. It is very likely that a full replacement of the structure would be a more viable approach.



Boones Ferry Control Station



Boones Ferry Control Station – Vertical Pipe Bracing Only, No Lateral Bracing



Boones Ferry Control Station – Rigid Pipe Penetration Through Vault Wall

Martinazzi Pump Station

Condition Rating: 4
Seismic Performance Expectation: Poor

Comments:

The Martinazzi Pump Station is a buried pre-cast concrete panel structure constructed around 1976. There does not appear to be a mechanical connection between the wall panels and the roof or floor panels. The structure appears in poor condition due to age and corrosion. It is expected during a code level seismic event that this structure will perform poorly. We feel it unlikely that this structure and the systems within will be functional post seismic event. Because of the buried nature of the structure, performing upgrades to increase seismic performance is likely not an economically viable endeavor. The piping is also lacking modern bracing and flexible joints at wall penetrations. It is very likely that a full replacement of the structure would be a more viable approach.



Martinazzi Pump Station



Martinazzi Pump Station – Rigid Pipe Penetrations Through Vault Wall



Martinazzi Pump Station – Bottom of Roof Panels Showing Poor Concrete Condition



Martinazzi Pump Station – Outdated Pipe Bracing

C Level Norwood Pump Station

Condition Rating: 8

Seismic Performance Expectation: Good

Comments:

The C Level Norwood Pump Station is a concrete masonry unit building constructed in 2010. It has a wood framed roof system and a concrete foundation. It is in good condition and with a recent design and construction date we expect it would meet the current requirements of an ASCE 41 seismic evaluation. While most of the piping appears to be well braced, some of the electrical and mechanical equipment appears to be inadequately braced for seismic resistance. We recommend that plumbing, piping, HVAC, tanks, pumps and control panels all be evaluated and upgraded with code compliant seismic bracing.



C Level Norwood Pump Station



C Level Norwood Pump Station – Vertical Pipe Bracing, Limited Lateral Support



C Level Norwood Pump Station – HVAC Equipment with Limited Lateral Strength



C Level Norwood Pump Station – Electrical Cabinets, Verify/Add Lateral Bracing

Water Storage Reservoirs

2.2 MG A1 Reservoir

Condition Rating: 6

Seismic Performance Expectation: Moderate

Comments:

A1 is a 2.2 MG welded steel reservoir with a concrete foundation that was constructed in 1971. This reservoir was constructed using a previously existing Hanford tank that was cut into segments and then reassembled with additional plates to obtain the desired volume. The reservoir was retrofitted in 2006 with additional concrete added to the foundation and anchorage, both of which appear to be in good condition. The exterior coating appears as expected for the age of the structure, some spots of peeling have occurred. The welds appear questionable in some areas. Some areas around the top of the tank have buckled, which may be due in part to the additional plates appearing to be tangential rather than curved to the radius of the tank. The overflow was observed to discharge directly onto the ground outside the tank. We gave the condition and seismic performance ratings largely based on the observed condition of the welds and buckling near the roof. We recommend recoating the exterior and mitigating the discharge of the overflow to prevent the potential for excess water to compromise the foundation of the reservoir. We recommend that an updated structural analysis be performed on this reservoir to bring the expected performance related to seismic resiliency up to date with the codes currently in force.



2.2 MG A1 Reservoir



2.2 MG A1 Reservoir – Foundation and Anchorage Retrofit

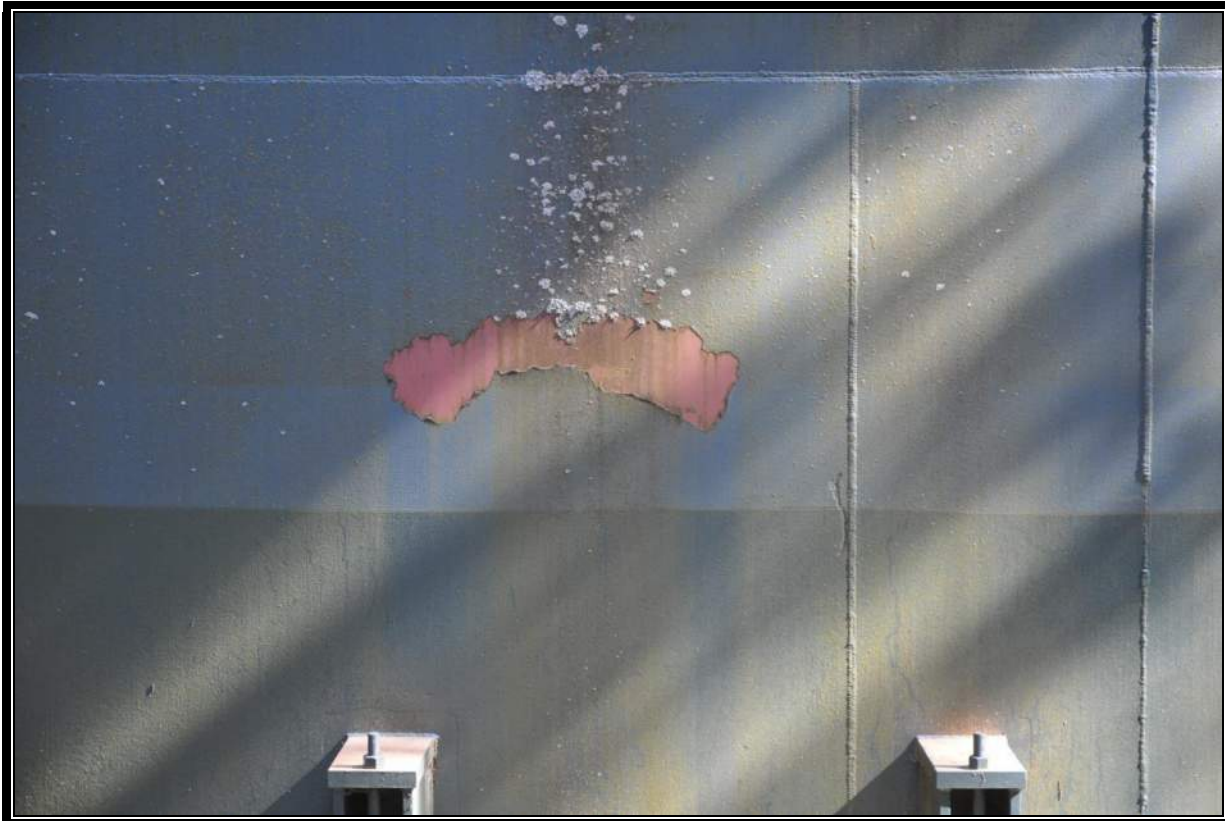

2.2 MG A1 Reservoir – Exterior Coating Peeling



2.2 MG A1 Reservoir – Buckled Wall Shell Plates



2.2 MG A1 Reservoir – Overflow Discharge

5.0 MG A2 Reservoir

Condition Rating: 8

Seismic Performance Expectation: Good

Comments:

A2 is a 5.0 MG welded steel reservoir with a concrete foundation that was constructed in 2006. With a recent construction date the reservoir is likely in conformance with most of the current seismic code requirements. The reservoir appears to have 5 feet of freeboard which is in the range of what we would expect for a reservoir designed to current seismic code requirements. The foundation concrete, anchorage, exterior coating, and welds all appear to be in good condition. There is also a small steel framed shelter for electrical equipment on site near the reservoir, the structure appears to be well anchored and in good condition. Overall the reservoir appears to be in good condition from our ground assessment.



5.0 MG A2 Reservoir



5.0 MG A2 Reservoir – Wall Shell Welds



5.0 MG A2 Reservoir - Shelter

2.2 MG B1 Reservoir

Condition Rating: 5

Seismic Performance Expectation: Poor

Comments:

B1 is a 2.2 MG welded steel reservoir with a concrete foundation that was constructed in 1971. This reservoir was constructed using a previously existing Hanford tank that was cut into segments and then reassembled with additional plates to obtain the desired volume. The reservoir was retrofitted in 2006 with additional concrete added to the foundation and anchorage, both of which appear to be in good condition. The exterior coating appears to be in good condition, no notable signs of peeling. The welds appear questionable in some areas. The overflow was observed to discharge directly onto the ground outside the tank with a minimal concrete catch. We noted some buckling near the top of the tank, which may be due in part to the additional plates appearing to be tangential rather than curved to the radius of the tank. Given the amount of buckling and the eccentricity, we expect it would lead to damage in a seismic event. We recommend mitigating the discharge of the overflow to prevent the potential for excess water to compromise the foundation of the reservoir. We recommend that an updated structural analysis be performed on this reservoir to bring the expected performance related to seismic resiliency up to date with the codes currently in force.



2.2 MG B1 Reservoir



2.2 MG B1 Reservoir – Wall Shell Plate Buckling



2.2 MG B1 Reservoir – Overflow Discharge and Catch Basin

2.2 MG B2 Reservoir

Condition Rating: 7

Seismic Performance Expectation: Moderate

Comments:

B2 is a 2.2 MG welded steel reservoir with a concrete foundation that was constructed in 1989. The reservoir was retrofitted in 2006 with additional concrete added to the foundation and anchorage, which appears to be in good condition. The exterior coating appears as expected for the age of the structure. The welds appear to be in good condition. Based on our review of the provided as-built drawings there appears to be approximately 2 feet of freeboard beyond the elevation of the overflow. From an analytical standpoint, 2 feet of freeboard would not meet current code requirements, and if the reservoir is operating at overflow elevation during a seismic event there would likely be damage to the roof. We recommend recoating the exterior. Overall the reservoir appears to be in good condition from our ground assessment.



2.2 MG B2 Reservoir



2.2 MG B2 Reservoir – Anchorage Retrofit



2.2 MG B2 Reservoir – Wall Shell Plates

0.8 MG C1 Reservoir

Condition Rating: 4

Seismic Performance Expectation: Moderate

Comments:

C1 is a 0.8 MG welded steel reservoir with a concrete foundation constructed in 1972. The reservoir was retrofitted in 2006 with the addition of a concrete ballast ring around the base. The exterior coating was in moderate condition, with some peeling noted at the interface of the ballast ring and the reservoir wall. The welds appear to be in good condition for the age of the structure. Based on our review of the provided as-built drawings there appears to be approximately 12 inches of freeboard beyond the elevation of the overflow. From an analytical standpoint, 12 inches of freeboard would not meet current code requirements, and if the reservoir is operating at overflow elevation during a seismic event there would likely be damage to the roof. Overall the reservoir appears to be in good condition from our ground assessment. We recommend recoating the exterior and providing flashing at the ballast ring and reservoir wall to prevent further water infiltration.



0.8 MG C1 Reservoir



0.8 MG C1 Reservoir – Wall Shell Plates



0.8 MG C1 Reservoir – Ballast Ring

1.0 MG C2 Reservoir

Condition Rating: 10

Seismic Performance Expectation: Good

Comments:

C2 is a 1.0 MG welded steel reservoir with a concrete foundation that was constructed in 2016. According to the provided as-builts, the reservoir was designed and constructed in conformance with the most current seismic code requirements. The reservoir appears to have 4 feet of freeboard which is in the range that we would expect for a reservoir designed to current seismic requirements. The foundation concrete, anchorage, exterior coating, and welds all appear to be in excellent condition. Overall the reservoir appears to be in excellent condition from our ground assessment.



1.0 MG C2 Reservoir



1.0 MG C2 Reservoir – Wall Shell Plates



1.0 MG C2 Reservoir – Anchors and Foundation

Summary

It is our understanding that the city wishes to use this data to develop an understanding of the potential seismic vulnerability of their facilities. We have identified a few facilities that are in generally poor condition and should be replaced soon. We understand that there may be some redundancy in the system and that a lesser level of expected seismic performance is acceptable for structures with redundancy and very low associated risk to life safety. We have identified some structures which we expect to perform poorly and some structures that are near the end of their service life – due either to wear and age or design and construction flaws.

There have been some significant changes in the code provisions for seismic design and detailing criteria that has occurred since most of these structures were designed. Many of the reservoirs were retrofitted to capture the more recent code provisions, but the anchorage for some of the pumps and other equipment likely does not meet current code. We noted a number of items that were not anchored for overturning against a seismic event, ranging from electrical to pipes and ducts. The degree to which it is necessary to address these issues is again related to the system redundancy and the risk to life-safety.

Thank you for the opportunity to serve the city, and please call if you have any questions. We are happy to provide further remediation guidance or investigation to facilities that are identified above as deficient and elsewhere as critical.

Sincerely,



Erik Peterson, P.E.



Submitted via e-mail: Brian.Ginter@murraysmith.us



888 SW 5TH AVENUE, SUITE #1170

PORTLAND, OR 97204

www.consoreng.com