

STR9[®] GEN3

INFINITY[®] UNIBODY[®]
GVA TECHNOLOGY GVA TECHNOLOGY



GVA
LIGHTING

Monochromatic Linear Wall Washing and Grazing LED Lighting

PRODUCT SPECIFICATION SHEET

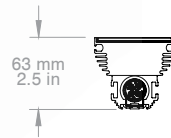
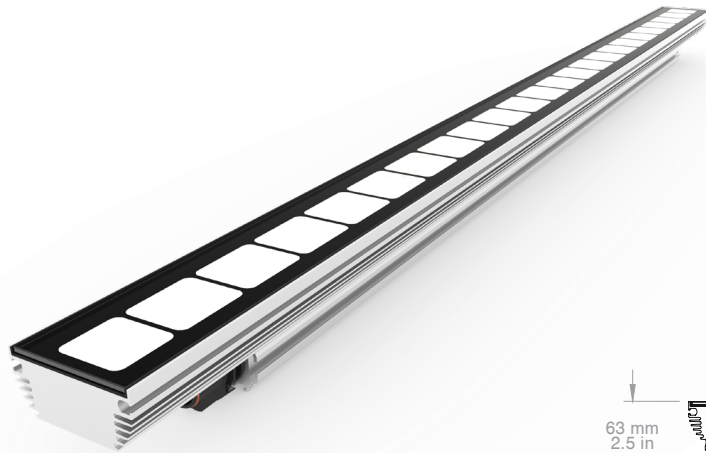

DATE: _____

TYPE: _____

COMPANY: _____

PROJECT: _____

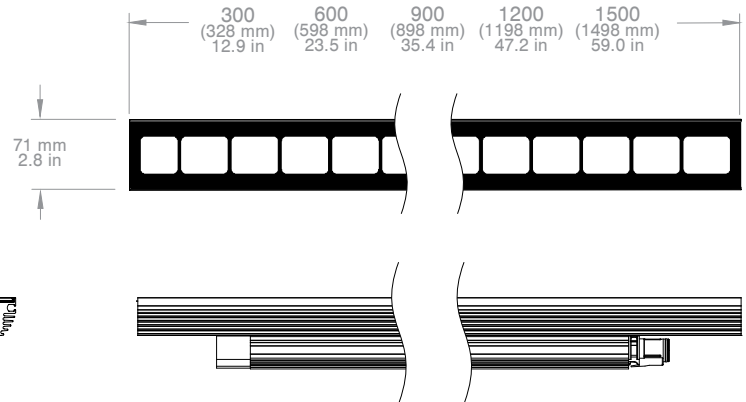

FEATURES:

Lighting Performance:

- Up to 3755 delivered lumens/meter (1144 lumens/foot)
- Superior quality of white light: excellent LED to LED color consistency
- Diffusing optical film creates uniform light output immediately adjacent to luminaire
- LED pitch is maintained within and between luminaires (no dark spots between fixtures)

Mechanical Details:

- Compact size, only 63 mm (2.5 in) high x 71 mm (2.8 in) wide
- IP66 rated with proprietary sealing process and solid extruded, anodized aluminum UNIBODY™ design
- Electronic micro leak detection test performed for each hermetically sealed fixture
- Meets 3G ANSI C136.31-2010 Vibration Standard for Bridge and Overpass Applications
- Optically clear tempered glass lens (no yellowing over time)
- Through wiring for end-to-end connection via snap-in and lock connectors
- IK06 rated fixture body construction, IK10 accessories available upon request¹

Control:

- DMX, DALI or 0-10V dimming through GVA's power-data equipment
- 300mm resolution, each 300mm section can be addressed individually, self-addressing fixtures

Projected Lifetime: L70 > 100,000hrs @ t_a = 25°C (77°F)

Operating Temperatures: -40°C to +50°C (-40°F to 122°F)

OPTIONS:

Power Source: 48VDC, 120VAC, 220-240VAC, 277VAC, 380VDC

Power Options: 3W, 5W (ASHRAE/IESNA), 10W, or 15W per 300mm (1ft)

Nominal Length: 300 mm (1ft)¹, 600mm (2ft), 900mm (3ft), 1200mm (4ft) and 1500mm (5ft)

Beam Distribution: Range of symmetrical and elliptical beam angles available
Body Color: Black matte and clear matte anodized or custom color²

Accessories:

- Adjustable and non-adjustable mounting brackets
- Glare control louvers

LED Color:

- Custom LED color combinations available

SPECIFICATION LOGIC: STR9 MONOCHROMATIC

FAMILY	NOMINAL LENGTH	BODY COLOR	POWER per 300mm (1ft)	LED COLOR	OPTICS (FWHM)	INPUT VOLTAGE	OPTIONAL
STR9-G3	300 ²	CM - Clear Matte Anodized	3W	2200K	5 - 5°x5°	ELV - 48VDC AC - 120 to 277VAC INF - 380VDC	NL - No Louver MLH- Micro Louver, Horizontal MLV- Micro Louver, Vertical
	600	BM - Black Matte Anodized	5W - ASHRAE/IESNA	2700K	8 - 8°x8°		
	900		10W	3000K	10 - 10°x10°		
	1200		15W	3500K	30 - 30°x30°		
	1500			4000K	60 - 60°x60°		
				5000K	80 - 80°x80°		
				6500K	100 - 100°x100°		
				RD - Red	5x10 - 5°x10°		
				AM - Amber	5x30 - 5°x30°		
				GR - Green	5x60 - 5°x60°		
				BL - Blue	10x30 - 10°x30°		
				RB - Royal Blue	10x60 - 10°x60°		
					10x90 - 10°x90°		
					20x60 - 20°x60°		
					30x60 - 30°x60°		

PRODUCT CONFIGURATION

1. IK10 is not a standard configuration; consult factory
2. Actual length of 328mm. Pitch is not maintained.



Monochromatic Linear Wall Washing and Grazing LED Lighting

PRODUCT SPECIFICATION SHEET

PRODUCT SPECIFICATIONS: STR9 MONOCHROMATIC			300	600	900	1200	1500
Nominal Length							
Electrical		Nominal Wattage					
	Power Consumption for 48VDC Input	3W/ft	3W	6W	9W	12W	15W
		5W/ft	5W	10W	15W	20W	25W
		10W/ft	10W	20W	30W	40W	50W
		15W/ft	15W	30W	45W	60W	75W
	Power Consumption ¹ for 120-277VAC Input	3W/ft	5.3W	8.5W	11.6W	14.8W	18.5W
		5W/ft	7.5W	12.7W	18.0W	23.7W	29.0W
		10W/ft	12.7W	23.7W	34.3W	45.0W	56.1W
		15W/ft	18.0W	34.3W	50.6W	67.5W	84.3W
Power Consumption for 380VDC Input	3W/ft	3W	6W	9W	12W	15W	
	5W/ft	5W	10W	15W	20W	25W	
	10W/ft	10W	20W	30W	40W	50W	
	15W/ft	15W	30W	45W	60W	75W	
Optical	Light Source	6 x High Power LEDs per 300mm (1ft)					
	CRI	>80					
	Lumen Output (typical) ^{2,3}	3W	240 lm	480 lm	720 lm	960 lm	1,200 lm
		5W	397 lm	794 lm	1,191 lm	1,588 lm	1,985 lm
		10W	780 lm	1,560 lm	2,340 lm	3,120 lm	3,900 lm
15W		1,119 lm	2,238 lm	3,357 lm	4,476 lm	5,595 lm	
Projected Lumen Maintenance	L70 > 100,000hrs @ t _a =25°C (77°F)						
Control	Control Protocol	DMX, DALI or 0-10V control through GVA Power-Data Equipment					
	Control Protocol for ELV and AC	DMX	300mm (1ft) resolutions				
		DALI	Each run is 1 address				
		0-10V					
	Control Protocol for INF	DMX	1 fixture resolution				
		DALI	Each run is 1 address				
0-10V							
Physical	Length	328 mm (12.9 in)	598 mm (23.54 in)	898 mm (35.35 in)	1,198 mm (47.17 in)	1,498 mm (58.98 in)	
	Width x Height	71 mm x 63 mm (2.8 in x 2.5 in)					
	Weight (ELV)	1.1 kg (2.4 lbs)	1.9 kg (4.2 lbs)	2.85 kg (6.28 lbs)	3.85 kg (8.5 lbs)	4.85 kg (10.7 lbs)	
	Weight (INF)	1.2 kg (2.6 lbs)	2 kg (4.4 lbs)	3 kg (6.6 lbs)	4 kg (8.8 lbs)	5 kg (11 lbs)	
	Weight (AC)	1.2 kg (2.6 lbs)	2 kg (4.4 lbs)	3 kg (6.6 lbs)	4 kg (8.8 lbs)	5 kg (11 lbs)	
	Housing & Lens	Aluminum body and tempered flat glass lens, IK06 rated, Optional IK10					
	Fixture Connections	IP68 sealed input and output connectors, with audible "click" snap-in & lock					
Temperature Ranges	Rated Operation Temperature	-40°C to +50°C (-22°F to 122°F)					
	Minimum Starting Temperature	-30°C (-22°F)					
	Storage Temperature	-40°C to +85°C (-22°F to 185°F)					
Certification & Safety	IES Classifications	Class 1 LED Luminaire					
	Certifications						
	Environment	QPS (US Field Evaluation) or ETL (Special Electrical Equipment Inspection) where applicable CE Certified RoHS Compliant Constructed to meet requirements outlined in UL1598 & IEC60598 Meets ANSI C136.31, 3G Vibration standard for bridge and overpass applications Dry, damp, or wet locations, 0-100% humidity, IP66					

1. Measured for 120VAC input voltage
 2. Data provided for 4000K, with 10 Degree beam angles. Warmer color temperatures typically have a lower lumen output.
 3. Please consult factory for most recent photometric data.
 4. IK10 is not a standard configuration; consult factory

These figures are subject to change due to further development and innovations of LED light sources



Monochromatic Linear Wall Washing and Grazing LED Lighting

PRODUCT SPECIFICATION SHEET

MAXIMUM RUN LENGTHS ¹										
		3W	5W	10W	15W		3W	5W	10W	15W
ELV	300	51.3 m	30.6 m	15.3 m	10.2 m		168.3 ft	100.4 ft	50.2 ft	33.5 ft
	600	51.0 m	30.6 m	15.6 m	10.2 m		167.3 ft	100.4 ft	51.2 ft	33.5 ft
	900	51.3 m	30.6 m	15.3 m	9.9 m		168.3 ft	100.4 ft	50.2 ft	32.5 ft
	1200	51.6 m	31.2 m	15.6 m	10.8 m		169.3 ft	102.4 ft	51.2 ft	35.4 ft
	1500	51.0 m	30.0 m	15.0 m	10.5 m		167.3 ft	98.4 ft	49.2 ft	34.4 ft
120VAC	300	100.2 m	71.7 m	42.3 m	29.7 m		328.7 ft	235.2 ft	138.8 ft	97.4 ft
	600	126.0 m	84.6 m	45.6 m	31.2 m		413.4 ft	277.6 ft	149.6 ft	102.4 ft
	900	137.7 m	89.1 m	46.8 m	31.5 m		451.8 ft	292.3 ft	153.5 ft	103.3 ft
	1200	144.0 m	91.2 m	46.8 m	15.6 m		472.4 ft	299.2 ft	153.5 ft	51.2 ft
	1500	148.5 m	93.0 m	48.0 m	15.0 m		487.2 ft	305.1 ft	157.5 ft	49.2 ft
240VAC	300	210.6 m	147.3 m	85.2 m	59.7 m		690.9 ft	483.3 ft	279.5 ft	195.9 ft
	600	256.8 m	170.4 m	92.4 m	63.6 m		842.5 ft	559.1 ft	303.1 ft	208.7 ft
	900	279.9 m	179.1 m	95.4 m	64.8 m		918.3 ft	587.6 ft	313.0 ft	212.6 ft
	1200	290.4 m	184.8 m	97.2 m	32.4 m		952.8 ft	606.3 ft	318.9 ft	106.3 ft
	1500	298.5 m	189.0 m	97.5 m	31.5 m		979.3 ft	620.1 ft	319.9 ft	103.3 ft
277VAC ²	300	5.4 m	5.4 m	5.4 m	5.4 m		17.7 ft	17.7 ft	17.7 ft	17.7 ft
	600	10.8 m	10.8 m	10.8 m	10.8 m		35.4 ft	35.4 ft	35.4 ft	35.4 ft
	900	16.2 m	16.2 m	16.2 m	16.2 m		53.1 ft	53.1 ft	53.1 ft	53.1 ft
	1200	21.6 m	21.6 m	21.6 m	10.8 m		70.9 ft	70.9 ft	70.9 ft	35.4 ft
	1500	27.0 m	27.0 m	27.0 m	13.5 m		88.6 ft	88.6 ft	88.6 ft	44.3 ft
INF ³	300		288.0 m	144.0 m	96.0 m			944.9 ft	472.4 ft	315.0 ft
	600		288.0 m	144.0 m	96.0 m			944.9 ft	472.4 ft	315.0 ft
	900		288.0 m	144.0 m	96.3 m			944.9 ft	472.4 ft	315.9 ft
	1200		288.0 m	144.0 m	96.0 m			944.9 ft	472.4 ft	315.0 ft
	1500		288.0 m	144.0 m	96.0 m			944.9 ft	472.4 ft	315.0 ft

Ratings are for 30°C, de-rating will be used for higher ambient temperatures. Contact factory for applications support.

1. Run lengths may vary depending on luminaire length combination chosen. Please consult factory for layout configuration. Values calculated for 3 m leader cable and end to end configuration.

2. Type D breaker required for 277VAC

3. INF run length values determined using PS-INF-6000



Monochromatic Linear Wall Washing and Grazing LED Lighting

PRODUCT SPECIFICATION SHEET

ORDERING LOGIC: STR9 MOUNTING ACCESSORIES

WX - ADJUSTABLE WALL MOUNT BRACKET KIT

W40 ADJUSTABLE WALL MOUNT

PART NUMBER	COLOR	WEIGHT	
121128 121129	Clear Matte Anodized Black Matte Anodized	0.10 kg (0.21 lbs)	

W80 ADJUSTABLE WALL MOUNT

PART NUMBER	COLOR	WEIGHT	
121130 121131	Clear Matte Anodized Black Matte Anodized	0.12 kg (0.27 lbs)	

W130 ADJUSTABLE WALL MOUNT

PART NUMBER	COLOR	WEIGHT	
121132 121133	Clear Matte Anodized Black Matte Anodized	0.15 kg (0.32 lbs)	

W155 ADJUSTABLE WALL MOUNT

PART NUMBER	COLOR	WEIGHT	
121134 121135	Clear Matte Anodized Black Matte Anodized	0.16 kg (0.35 lbs)	

W180 ADJUSTABLE WALL MOUNT

PART NUMBER	COLOR	WEIGHT	
121136 121137	Clear Matte Anodized Black Matte Anodized	0.17 kg (0.38 lbs)	

SMA-I - INSIDE ADJUSTABLE SURFACE MOUNT BRACKET KIT

PART NUMBER	COLOR	WEIGHT	
121138 121139	Clear Matte Anodized Black Matte Anodized	0.09 kg (0.20 lbs)	

SMA-O - OUTSIDE ADJUSTABLE SURFACE MOUNT BRACKET KIT

PART NUMBER	COLOR	WEIGHT	
121825 121826	Clear Matte Anodized Black Matte Anodized	0.09 kg (0.20 lbs)	

SML - SURFACE MOUNT BRACKET KIT, NON-ADJUSTABLE

PART NUMBER	COLOR	WEIGHT	
121140 121141	Clear Matte Anodized Black Matte Anodized	0.08 kg (0.18 lbs)	



Monochromatic Linear Wall Washing and Grazing LED Lighting

PRODUCT SPECIFICATION SHEET

ORDERING LOGIC: STR9 MOUNTING ACCESSORIES

CLP - CLIP MOUNT KIT, NON-ADJUSTABLE

PART NUMBER	COLOR	WEIGHT	
124859	STAINLESS STEEL	0.21 kg (0.47 lbs)	

MCD - CANTILEVER BRACKET, NON-ADJUSTABLE

PART NUMBER	COLOR	WEIGHT	
121146	STAINLESS STEEL	0.94 kg (2.08 lbs)	

CH - ADJUSTABLE HORIZONTAL CANTILEVER BRACKET KIT - 100 MM TO 500 MM

CM	BM	TYPE	WEIGHT		
123336	123355	CH-100	0.77 kg (1.69 lbs)		
123337	123356	CH-150	0.87 kg (1.92 lbs)		
123338	123357	CH-200	0.98 kg (2.16 lbs)		
123339	123358	CH-250	1.08 kg (2.39 lbs)		
123340	123359	CH-300	1.19 kg (2.62 lbs)		
123341	123360	CH-350	1.29 kg (2.85 lbs)		
123342	123361	CH-400	1.40 kg (3.08 lbs)		
123343	123362	CH-450	1.50 kg (3.31 lbs)		
123344	123363	CH-500	1.61 kg (3.54 lbs)		
					<p>*Surface mount fixture bracket not included, please order separately. Only 1 arm is shown, kit includes both arms.</p>

CV - ADJUSTABLE VERTICAL CANTILEVER BRACKET KIT - 100 MM TO 500 MM

CM	BM	TYPE	WEIGHT		
123374	123393	CV-100	0.59 kg (1.30 lbs)		
123375	123394	CV-150	0.70 kg (1.53 lbs)		
123376	123395	CV-200	0.80 kg (1.77 lbs)		
123377	123396	CV-250	0.91 kg (2.00 lbs)		
123378	123397	CV-300	1.01 kg (2.23 lbs)		
123379	123398	CV-350	1.12 kg (2.46 lbs)		
123380	123399	CV-400	1.22 kg (2.69 lbs)		
123381	123400	CV-450	1.33 kg (2.92 lbs)		
123382	123401	CV-500	1.43 kg (3.15 lbs)		
					<p>*Surface mount fixture bracket not included, please order separately. Only 1 arm is shown, kit includes both arms.</p>



Monochromatic Linear Wall Washing and Grazing LED Lighting

PRODUCT SPECIFICATION SHEET

ORDERING LOGIC: STR9 MOUNTING ACCESSORIES

CC - ADJUSTABLE CEILING MOUNT CANTILEVER BRACKET KIT - 100 MM TO 1000 MM

CM	BM	TYPE	WEIGHT
123766	123785	CC-100	0.62 kg (1.37 lbs)
123767	123786	CC-150	0.72 kg (1.60 lbs)
123768	123787	CC-200	0.83 kg (1.83 lbs)
123769	123788	CC-250	0.93 kg (2.06 lbs)
123770	123789	CC-300	1.04 kg (2.29 lbs)
123771	123790	CC-350	1.14 kg (2.52 lbs)
123772	123791	CC-400	1.25 kg (2.75 lbs)
123773	123792	CC-450	1.35 kg (2.98 lbs)
123774	123793	CC-500	1.46 kg (3.22 lbs)
123775	123794	CC-550	1.56 kg (3.45 lbs)
123776	123795	CC-600	1.67 kg (3.68 lbs)
123777	123796	CC-650	1.77 kg (3.91 lbs)
123778	123797	CC-700	1.88 kg (4.14 lbs)
123779	123798	CC-750	1.98 kg (4.37 lbs)
123780	123799	CC-800	2.09 kg (4.60 lbs)
123781	123800	CC-850	2.19 kg (4.83 lbs)
123782	123801	CC-900	2.30 kg (5.06 lbs)
123783	123802	CC-950	2.40 kg (5.30 lbs)
123784	123803	CC-1000	2.51 kg (5.53 lbs)

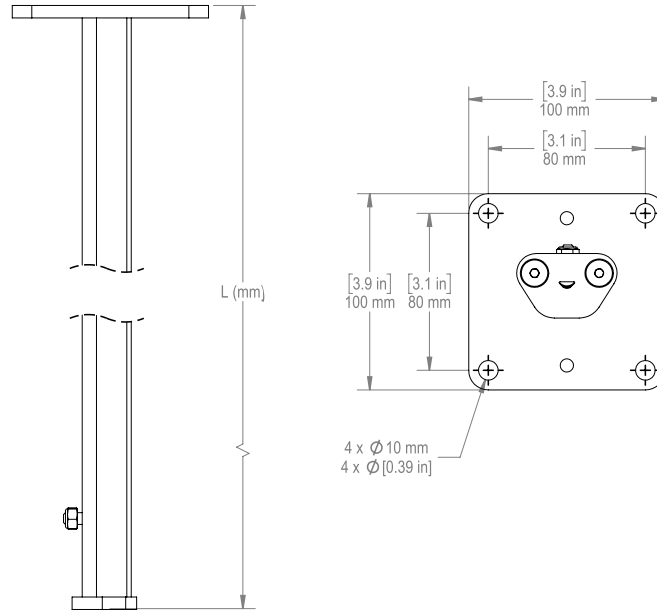

*Surface mount fixture bracket not included, please order separately. Only 1 arm is shown, kit includes both arms.

DCH - ADJUSTABLE HORIZONTAL DOUBLE CANTILEVER BRACKET KIT - 100 MM TO 500 MM

CM	BM	TYPE	WEIGHT
123709	123728	DCH-100	1.93 kg (4.25 lbs)
123710	123729	DCH-150	2.14 kg (4.71 lbs)
123711	123730	DCH-200	2.35 kg (5.17 lbs)
123712	123731	DCH-250	2.56 kg (5.63 lbs)
123713	123732	DCH-300	2.77 kg (6.10 lbs)
123714	123733	DCH-350	2.98 kg (6.56 lbs)
123715	123734	DCH-400	3.18 kg (7.02 lbs)
123716	123735	DCH-450	3.39 kg (7.48 lbs)
123717	123736	DCH-500	3.60 kg (7.95 lbs)

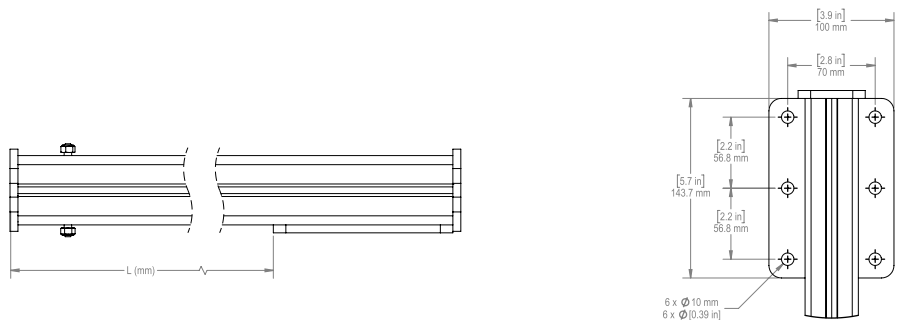

*Surface mount fixture bracket not included, please order separately. Only 1 arm is shown, kit includes both arms.



Monochromatic Linear Wall Washing and Grazing LED Lighting

PRODUCT SPECIFICATION SHEET

ORDERING LOGIC: STR9 MOUNTING ACCESSORIES

DCV-C - ADJUSTABLE VERTICAL & CEILING MOUNT DOUBLE CANTILEVER BRACKET KIT - 100 MM TO 500 MM

CM	BM	TYPE	WEIGHT	
123628	123647	DCV-C-100	1.17 kg (2.57 lbs)	
123629	123648	DCV-C-150	1.38 kg (3.04 lbs)	
123630	123649	DCV-C-200	1.58 kg (3.50 lbs)	
123631	123650	DCV-C-250	1.80 kg (3.96 lbs)	
123632	123651	DCV-C-300	2.01 kg (4.42 lbs)	
123633	123652	DCV-C-350	2.22 kg (4.88 lbs)	
123634	123653	DCV-C-400	2.46 kg (5.35 lbs)	
123635	123654	DCV-C-450	2.64 kg (5.81 lbs)	
123636	123655	DCV-C-500	2.84 kg (6.27 lbs)	

*Surface mount fixture bracket not included, please order separately. Only 1 arm is shown, kit includes both arms.

ANGLE ADJUSTMENT AND INSTALLATION TOOLS FOR SMA - ANGLES FROM 1° TO 20°

PART NUMBER	TYPE	
310168	3°	
310169	4°	
310170	5°	
310171	6°	
310172	7°	
310173	8°	
310174	9°	
310175	10°	
310176	11°	
310177	12°	
310178	13°	
310179	14°	
310180	15°	
310181	16°	
310182	17°	
310183	18°	
310184	19°	
310185	20°	



Monochromatic Linear Wall Washing and Grazing LED Lighting

PRODUCT SPECIFICATION SHEET

ORDERING LOGIC: COMMON COMPONENTS

STR9 LEADER CABLE ELV

PART NUMBER	NOMINAL LENGTH	WEIGHT	INPUT	OUTPUT
141481	3.0 m (9 ft)	420 g (0.93 lbs)		
141484	6.0 m (19 ft)	815 g (1.80 lbs)		
141487	9.0 m (30 ft)	1210 g (2.67 lbs)		
141489	15.0m (50 ft)	2000 g (4.41 lbs)		
141492	30.0 m (100 ft)	3975 g (8.76 lbs)		

STR9 REVERSE LEADER CABLE ELV (ONLY USED WITH PDR)

PART NUMBER	NOMINAL LENGTH	WEIGHT	INPUT	OUTPUT
142231	3.0 m (9 ft)	420 g (0.93 lbs)		
142234	6.0 m (19 ft)	815 g (1.80 lbs)		
142237	9.0 m (30 ft)	1210 g (2.67 lbs)		
142239	15.0m (50 ft)	2000 g (4.41 lbs)		
142242	30.0 m (100 ft)	3975 g (8.76 lbs)		

STR9 JUMPER CABLE ELV

PART NUMBER	NOMINAL LENGTH	WEIGHT	INPUT	OUTPUT
141603	END to END	105 g (0.23 lbs)		
141740	0.6 m (2 ft)	129 g (0.28 lbs)		
141741	0.9 m (3 ft)	169 g (0.37 lbs)		
141742	1.2 m (4 ft)	208 g (0.46 lbs)		
141743	1.5 m (5 ft)	248 g (0.55 lbs)		
141744	1.8 m (6 ft)	287 g (0.63 lbs)		
141758	6.0 m (20 ft)	840 g (1.85 lbs)		
141768	9.0 m (30 ft)	1235 g (2.72 lbs)		

*Not all jumper lengths are shown. Lengths available in 300mm increments. It is mandatory to include jumpers to connect STR9 GEN3 luminaires.

STR9 LEADER CABLE INF

PART NUMBER	NOMINAL LENGTH	WEIGHT	INPUT	OUTPUT
141495	3.0 m (9 ft)	420 g (0.93 lbs)		
141498	6.0 m (19 ft)	815 g (1.80 lbs)		
141501	9.0 m (30 ft)	1210 g (2.67 lbs)		
141503	15.0m (50 ft)	2000 g (4.41 lbs)		
141506	30.0 m (100 ft)	3975 g (8.76 lbs)		

STR9 REVERSE LEADER CABLE INF (ONLY USED WITH PDR)

PART NUMBER	NOMINAL LENGTH	WEIGHT	INPUT	OUTPUT
142201	3.0 m (9 ft)	420 g (0.93 lbs)		
142204	6.0 m (19 ft)	815 g (1.80 lbs)		
142207	9.0 m (30 ft)	1210 g (2.67 lbs)		
142209	15.0m (50 ft)	2000 g (4.41 lbs)		
142212	30.0 m (100 ft)	3975 g (8.76 lbs)		

STR9 LEADER CABLE AC

PART NUMBER	NOMINAL LENGTH	WEIGHT	INPUT	OUTPUT
141509	3.0 m (9 ft)	420 g (0.93 lbs)		
141512	6.0 m (19 ft)	815 g (1.80 lbs)		
141515	9.0 m (30 ft)	1210 g (2.67 lbs)		
141517	15.0m (50 ft)	2000 g (4.41 lbs)		
141520	30.0 m (100 ft)	3975 g (8.76 lbs)		

STR9 REVERSE LEADER CABLE AC (ONLY USED WITH PDR)

PART NUMBER	NOMINAL LENGTH	WEIGHT	INPUT	OUTPUT
142792	3.0 m (9 ft)	420 g (0.93 lbs)		
142795	6.0 m (19 ft)	815 g (1.80 lbs)		
142798	9.0 m (30 ft)	1210 g (2.67 lbs)		
142800	15.0m (50 ft)	2000 g (4.41 lbs)		
141803	30.0 m (100 ft)	3975 g (8.76 lbs)		

STR9 JUMPER CABLE INF & AC

PART NUMBER	NOMINAL LENGTH	WEIGHT	INPUT	OUTPUT
141602	END to END	105 g (0.23 lbs)		
141790	0.6 m (2 ft)	129 g (0.28 lbs)		
141791	0.9 m (3 ft)	169 g (0.37 lbs)		
141792	1.2 m (4 ft)	208 g (0.46 lbs)		
141793	1.5 m (5 ft)	248 g (0.55 lbs)		
141794	1.8 m (6 ft)	287 g (0.63 lbs)		
141808	6.0 m (20 ft)	840 g (1.85 lbs)		
141818	9.0 m (30 ft)	1235 g (2.72 lbs)		

*Not all jumper lengths are shown. Lengths available in 300mm increments. It is mandatory to include jumpers to connect STR9 GEN3 luminaires.



Monochromatic Linear Wall Washing and Grazing LED Lighting

PRODUCT SPECIFICATION SHEET

ORDERING LOGIC: COMMON COMPONENTS

STR9 CABLE 3X14 AWG + 1X24 AWG

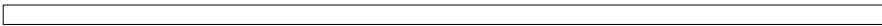
PART NUMBER	NOMINAL LENGTH	WEIGHT	
280253	Sold per m	132 g (0.291 lbs)	 <p>*Raw cable cut to length. Please specify required length.</p>

STR9 CONNECTOR CAP, IP67 (Must be used at the end of each run)

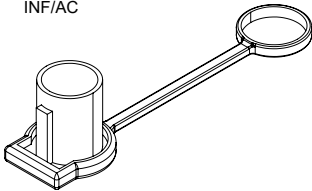
PART NUMBER	TYPE	WEIGHT	
231182	STR9-ELV	3.40 g (0.11 oz)	 <p>INF/AC</p>
230855	STR9-INF/AC	6.24 g (0.22 oz)	

STR9 GLARE CONTROL LOUVERS - 300 MM

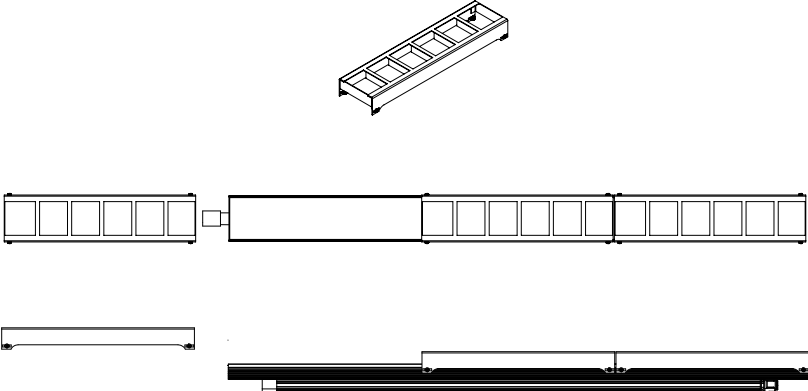
PART NUMBER	COLOR	WEIGHT	
122737	BLACK	0.08 kg (0.18 lbs)	

OPTIONAL ACCESSORIES

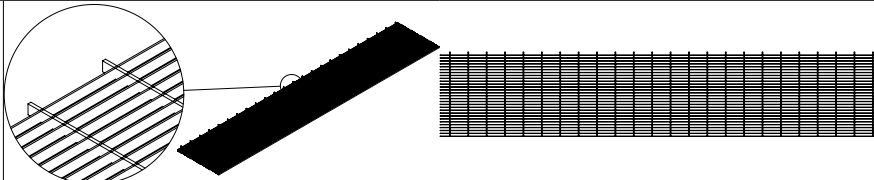
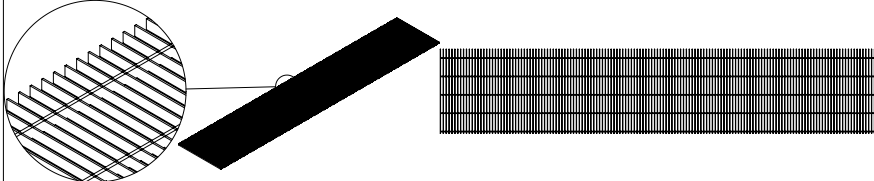
TYPE	COLOR	WEIGHT (Per 300mm)	
MLH - Micro Louver, Horizontal	BLACK	10 g 0.35 oz	 <p>*Please select option in the specification logic table if required. Item is factory installed only.</p>
MLV - Micro Louver, Vertical	BLACK	10 g 0.35 oz	 <p>*Please select option in the specification logic table if required. Item is factory installed only.</p>



Monochromatic Linear Wall Washing and Grazing LED Lighting

PRODUCT SPECIFICATION SHEET

ORDERING LOGIC: POWER SUPPLIES AND POWER DATA EQUIPMENT							
ELV POWER DATA BOXES							
FAMILY	OUTPUT VOLTAGE	POWER (Watts)		CONTROL INPUT	CONTROL OUTPUT	INPUT VOLTAGE	CONSTRUCTION
PS	ELV (48V)	240W 320W	480W 640W	-	-	120~277VAC	IP66 IP30
PDB	ELV (48V)	240W 320W	480W 640W	DALI/ 0~10V DMX	48V POWER & ZH DATA	120~277VAC	IP66 IP30
INFINITY POWER SUPPLIES IP66							
PART NUMBER	DESCRIPTION	LENGTH	WIDTH	HEIGHT	WEIGHT		
G20337 G20338 G20341	PS-INF-3000-120VAC PS-INF-3000-208/240VAC PS-INF-3000-220/230/240VAC	260 mm 10.26 in	160 mm 6.30 in	91 mm 3.58 in	10.98 kg 24.2 lbs		
POWER-DATA CONVERTERS IP66							
PART NUMBER	DESCRIPTION	LENGTH	WIDTH	HEIGHT	WEIGHT		
G20510 G20514 G20520 G20524	PDC-AC-120-1W+N+PE INPUT-1DMX PDC-AC-208~240-1W+N+PE INPUT-1DMX PDC-AC-277-1W+N+PE INPUT-1DMX PDC-AC-208~240-1W+N+PE INPUT-1DMX	260 mm 10.24 in	160 mm 6.30 in	91 mm 3.58 in	3.35 kg 7.39 lbs		
G20511 G20515 G20521 G20525	PDC-AC-120-1W+N+PE INPUT-DALI/0~10V PDC-AC-208~240-1W+N+PE INPUT-DALI/0~10V PDC-AC-277-1W+N+PE INPUT-DALI/0~10V PDC-AC-208~240-1W+N+PE INPUT-DALI/0~10V						
G20342 G20431 G20343	PDC-INF-1DMX PDC-INF-2DMX PDC-INF-DALI/0~10V	160 mm 6.30 in	160 mm 6.30 in	91 mm 3.58 in	2.06 kg 4.54 lbs		
POWER-DATA CONVERTERS IP30							
PART NUMBER	DESCRIPTION	LENGTH	WIDTH	HEIGHT	WEIGHT		
G20512 G20516 G20522 G20526	PDC-AC-120-1W+N+PE INPUT-1DMX PDC-AC-208~240-1W+N+PE INPUT-1DMX PDC-AC-277-1W+N+PE INPUT-1DMX PDC-AC-208~240-1W+N+PE INPUT-1DMX	266 mm 10.5 in	160 mm 6.30 in	90 mm 3.54 in	3.35 kg 7.39 lbs		
G00513 G20517 G20523 G20527	PDC-AC-120-1W+N+PE INPUT-DALI/0~10V PDC-AC-208~240-1W+N+PE INPUT-DALI/0~10V PDC-AC-277-1W+N+PE INPUT-DALI/0~10V PDC-AC-208~240-1W+N+PE INPUT-DALI/0~10V						
G20452 G20453 G20454	PDC-INF-1DMX PDC-INF-2DMX PDC-INF-DALI/0~10V	160 mm 6.30 in	160 mm 6.30 in	90 mm 3.54 in	2.06 kg 4.54 lbs		
POWER-DATA REPEATERS IP66							
PART NUMBER	DESCRIPTION	LENGTH	WIDTH	HEIGHT	WEIGHT		
G20445 G20446	PDR-ELV-INF PDR-AC	160 mm 6.30 in	160 mm 6.30 in	91 mm 3.58 in	2.13 kg 4.70 lbs		
POWER-DATA REPEATERS IP30							
PART NUMBER	DESCRIPTION	LENGTH	WIDTH	HEIGHT	WEIGHT		
G20442	PDR-ELV-INF	160 mm 6.30 in	160 mm 6.30 in	91 mm 3.58 in	2.06 kg 4.54 lbs		

Monochromatic Linear Wall Washing and Grazing LED Lighting

PRODUCT SPECIFICATION SHEET

TYPICAL SYSTEM DIAGRAM: ELV WITH CONTROL

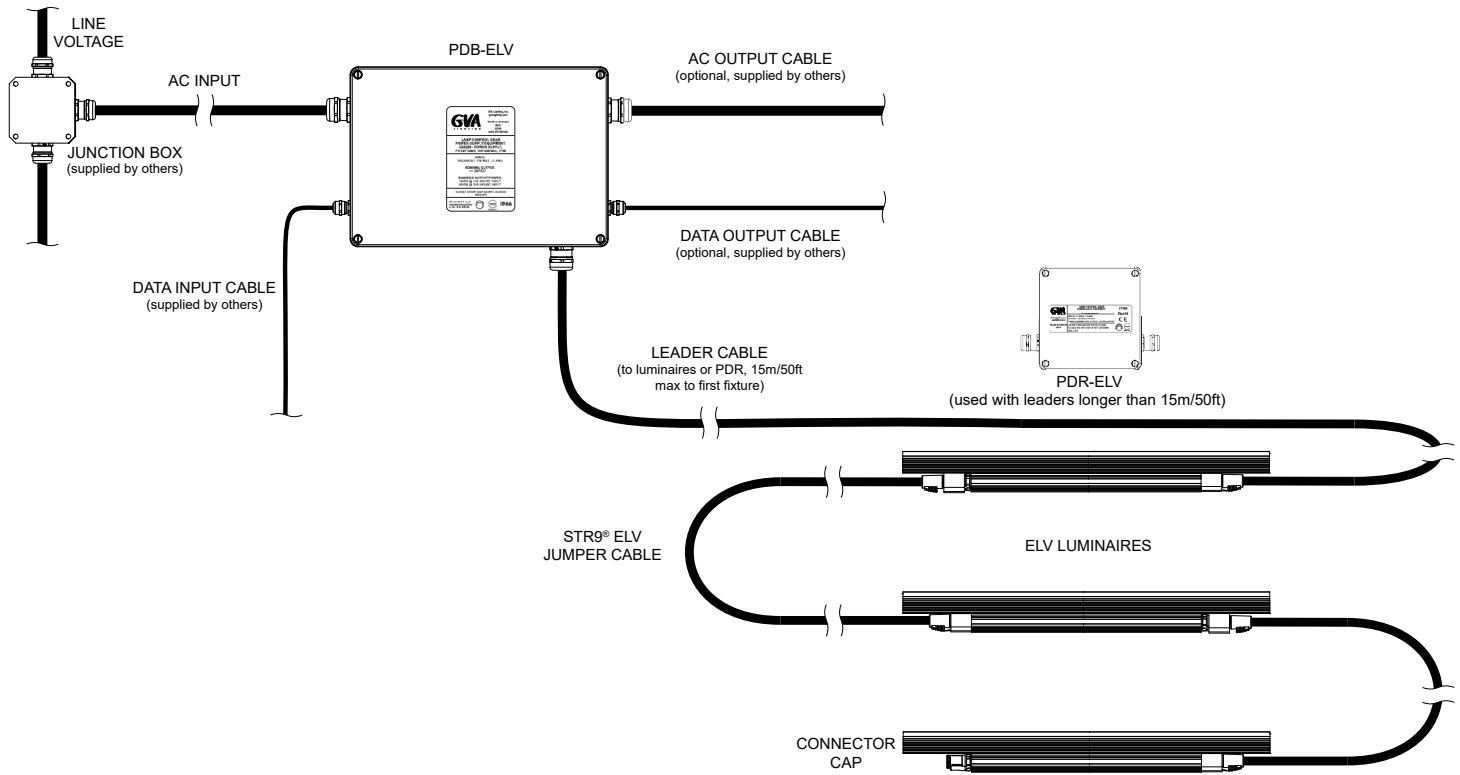

TYPICAL SYSTEM DIAGRAM: ELV WITHOUT CONTROL

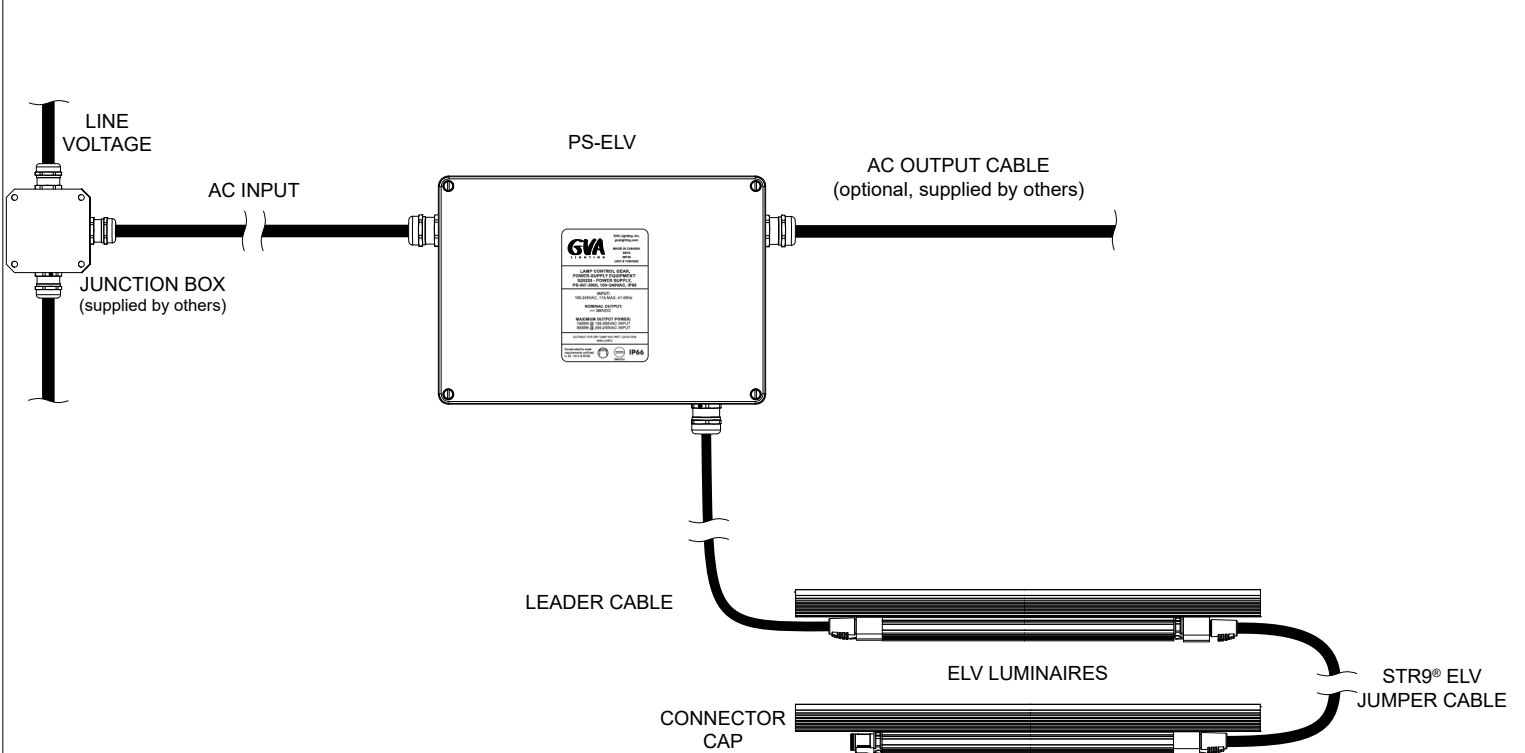

Monochromatic Linear Wall Washing and Grazing LED Lighting

PRODUCT SPECIFICATION SHEET

TYPICAL SYSTEM DIAGRAM: INFINITY WITH CONTROL

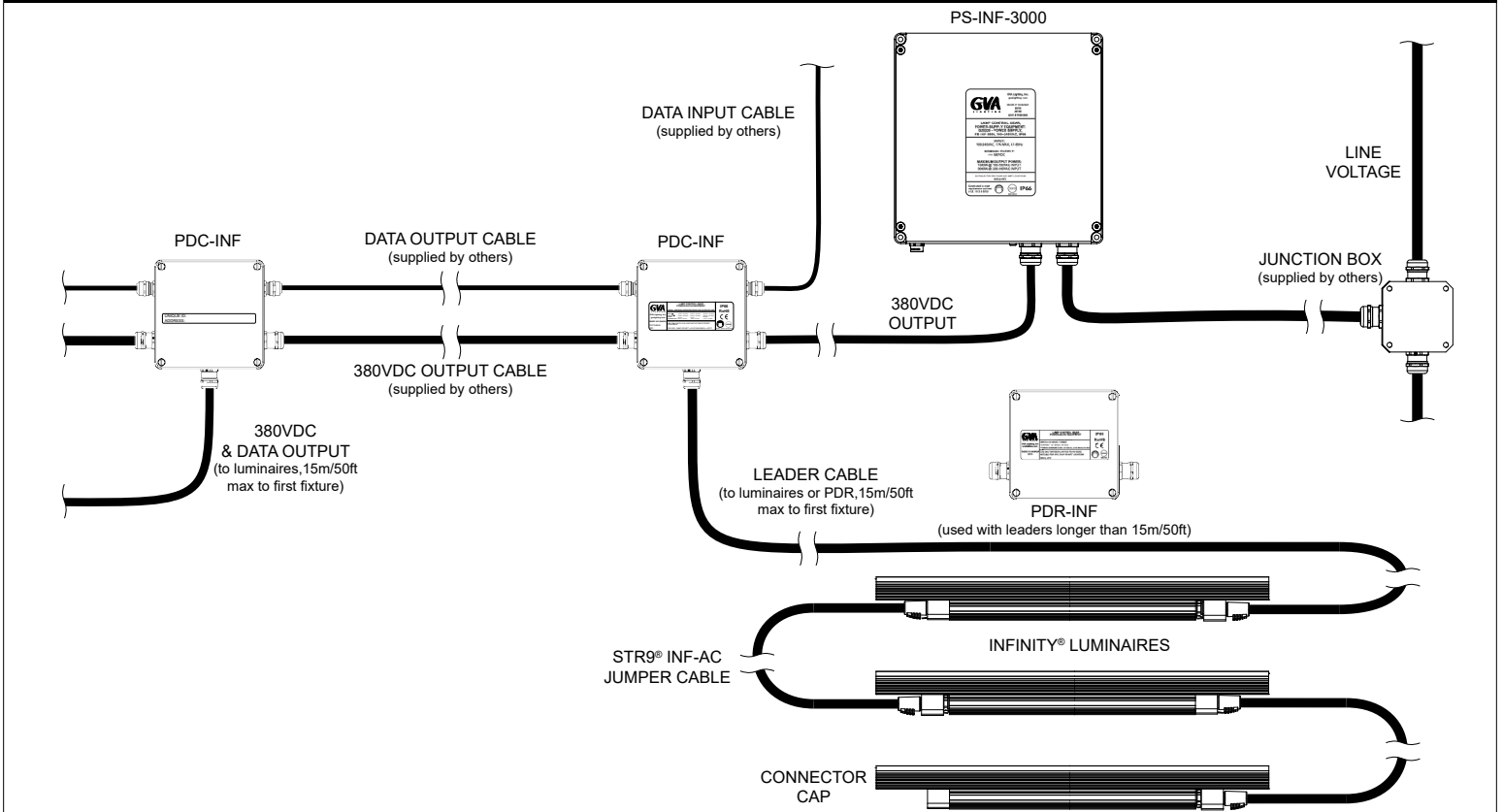

TYPICAL SYSTEM DIAGRAM: INFINITY WITHOUT CONTROL

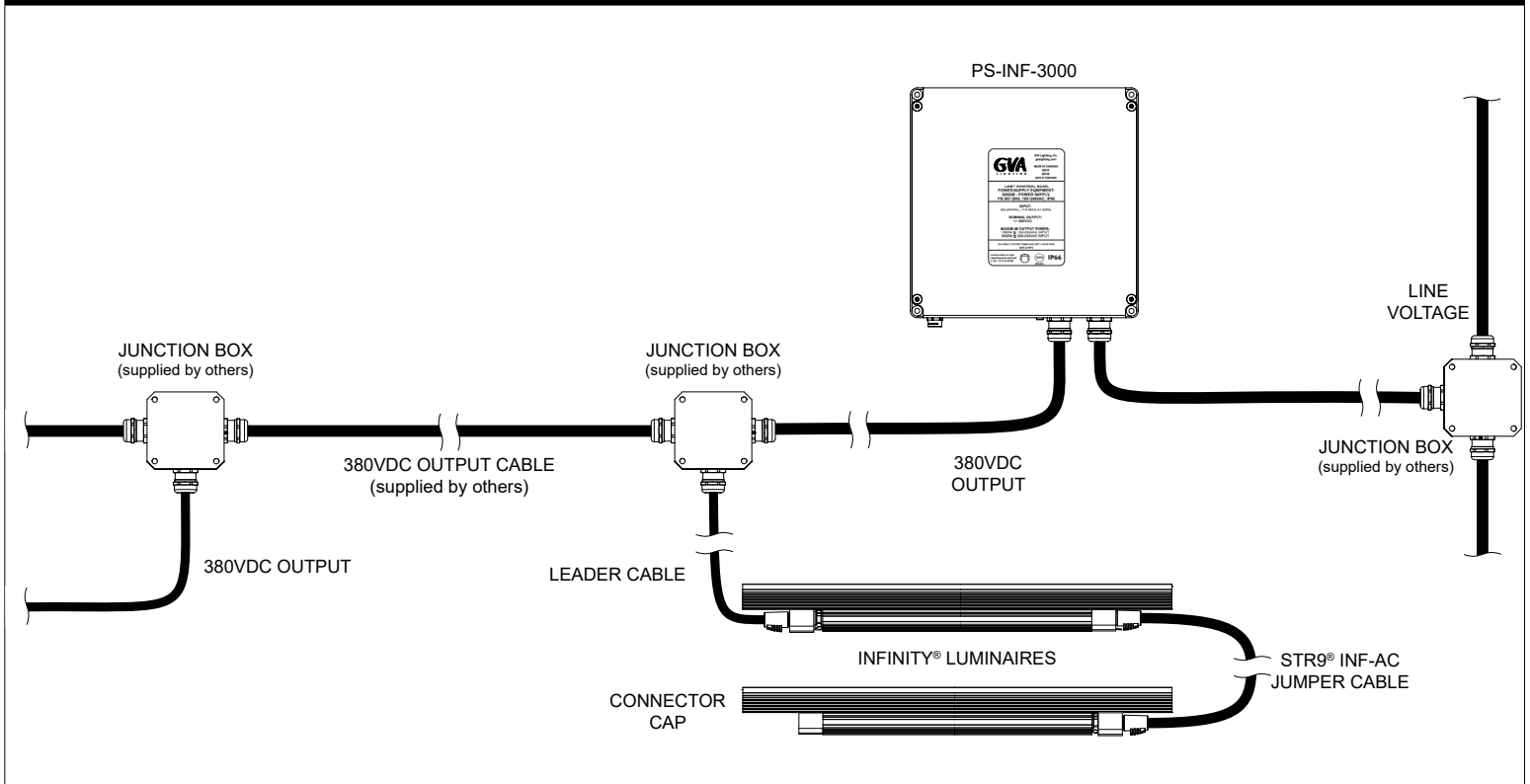

Monochromatic Linear Wall Washing and Grazing LED Lighting

PRODUCT SPECIFICATION SHEET

TYPICAL SYSTEM DIAGRAM: AC WITH CONTROL

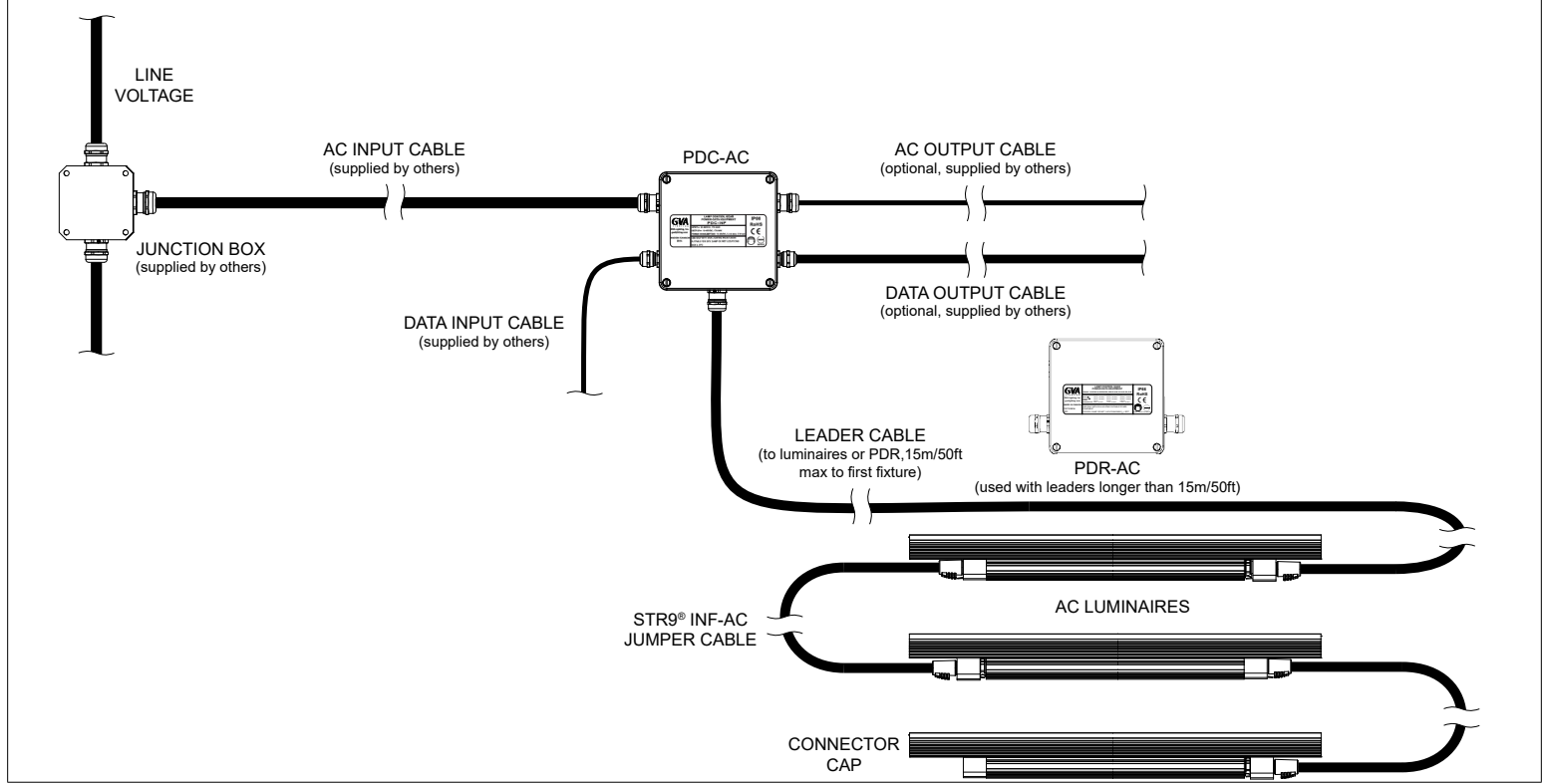

TYPICAL SYSTEM DIAGRAM: AC WITHOUT CONTROL

