



Precise Aerial Roof Measurement Report

Prepared For You by RCB Roofing



199 northview-Dorsey, Rutherfordton, NC 28139

METAL- RESIDENTIAL ROOF REPORT

APR 18, 2023

We can help you with
All Your Roofing Needs
Residential + Commercial

AMIE HANAWAY

199 northview-Dorsey
Rutherfordton, NC
28139

470-355-1500

INTRODUCTION

Hi

Thank you for the opportunity to serve you. Please find your estimate below along with upgrade options for potential improvements to your project, if applicable.

The following estimate is for:

1. Remove and disposal of old materials
2. Supply and install new materials
3. Clean up of entire work area (all nails and other materials)
4. Clean all gutters (if roof is done)
5. Your own dedicated Production Scheduling team
6. All employees are WCB and COR certified
7. We are Licensed to work in your geographical region
8. Audit of all work completed by Quality Control Officer
9. 5-year Workmanship Warranty on complete projects - (Full Roof Replacement)

We don't want you to be personally liable should a worker happen to get injured therefore we maintain current WCB for all employees and crews.

We carry two million liability insurance. As well, we have mandatory safety training for our staff to ensure safe practices always.

Once the job is complete, complete an additional full inspection on your home to ensure we did everything correct and up to our strict standards and site is spotless.

If you have any questions, please give me a call. We always want to provide the best value to our clients. If we are outside your budget, please let me know and we will do our best to work within that.

Best,

INSPECTION

Waste Calculation Table							
Waste %	0%	10%	12%	15%	17%	20%	22%
Area (sq ft)	5,284	5812.4	5918.1	6076.6	6182.3	6340.8	6446.5
Squares	52.8	58.1	59.2	60.8	61.8	63.4	64.5

This table shows the total roof area and squares (rounded up to the nearest decimal) based upon different waste percentages. The waste factor is subject to the complexity of the roof, individual roofing techniques and your experience. Please consider this when calculating appropriate waste percentages. Note that only roof area is included in these waste calculations. Additional materials needed for ridge, hip, valley, and starter lengths are not included.

Penetrations	1-2	3-5	6-10	11	12				
Area (sq ft)	0.3	1	2.2	4.3	5.2				
Perimeter (ft)	2	4	6	8.8	10				

Any measured penetration smaller than 3.0x3.0 Feet may need field verification. Accuracy is not guaranteed. The total penetration area is not subtracted from the total roof area.

All Structures Totals



Total Roof Facets = 5
 Total Penetrations = 12

Lengths, Areas and Pitches

- Ridges = 108 ft (2 Ridges)
- Hips = 0 ft (0 Hips)
- Valleys = 19 ft (2 Valleys)
- Rakes = 143 ft (8 Rakes)
- Eaves/Starter = 193 ft (7 Eaves)
- Drip Edge (Eaves + Rakes) = 336 ft (15 Lengths)
- Parapet Walls = 0 (0 Lengths)
- Flashing = 0 ft (0 Lengths)
- Step Flashing = 5 ft (4 Lengths)
- Total Penetrations Area = 25 sq ft
- Total Roof Area Less Penetrations = 5,259 sq ft
- Total Penetrations Perimeter = 65 ft
- Predominant Pitch = 6/12
- Total Area (All Pitches) = 5,284 sq ft**

Property Location

Longitude = -81.9437783
 Latitude = 35.3865951

Notes

This was ordered as a commercial property. There were no changes to the structure in the past four years.







WARRANTY



This document warrants that should a defect in workmanship, related to the work completed by RCB Roofing, occur within 10 years of the project, RCB Roofing will complete repairs within the original project's scope of work at no charge to the customer. This warranty does not cover normal wear and tear, hail damage, wind damage, sun damage, intentional or accidental damage by any person, or acts of God that may or may not merit an insurance claim. This warranty only applies to portions of the project in which RCB Roofing fully replaced any existing products, and does not cover repairs or service done to another contractor's work. Defects in the building materials used to complete work do not fall under the scope of this workmanship warranty; any building products installed will instead be covered by the product's original manufacturer warranty.

*Manufacturer's Warranty detailed in separate document.

Customer: _____

Project Address: _____

Date Project Completed: _____

Thank you again for choosing RCB Roofing to complete work on your property. We trust you had a great customer experience!

ADVANTAGE-LOK II®



Your Roof. For Life!
On Time and Complete!™



Contact your sales representative for more information.

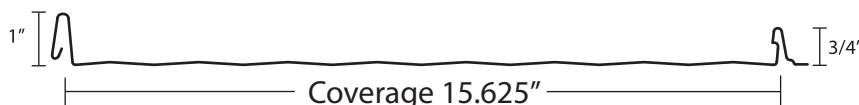
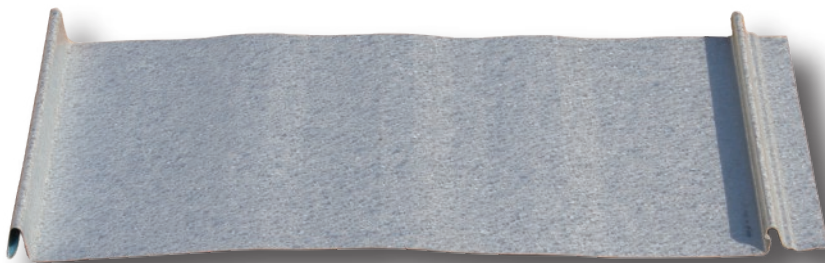

Description

Standing seam roofing panels have been used on traditional and contemporary homes for more than a century. Their clean, graceful lines have been an enduring favorite on a wide range of architecture. Advantage-Lok II is a premium standing seam panel that was designed with low profile ribs to increase strength and wind resistance. This product utilizes a high-strength snap locking system and installs in the same manner as our original Advantage-Lok panels. It's a perfect choice for up-scale residential and commercial applications in severe weather areas.

Specifications

- Standing seam concealed fastener panel for roof applications
- Snap locking ribs
- Screw flange installation
- 3:12 minimum recommended roof pitch
- Suitable for solid decking

Substrates and Coatings

- 26 and 24 gauge high strength steel
- 0.032" aluminum
- Anti-corrosion AZ50 Galvalume coating for painted and AZ55 for unpainted steel
- 26 ga available in 45 Year and Lifetime Siliconized Modified Polyester Paint System
- 24 ga and aluminum available in PVDF (Kynar 500 or Hylar 5000) Paint System

Finish Options

- PVDF (Kynar®) and Siliconized Modified Polyester Paints Available
- Energy Star Certified Colors Available
- Unpainted Galvalume®

Approvals and Certifications

- Metal Construction Association Certified
- Miami-Dade Approved
- Florida Building Code Approved
- Energy Star Certified
- Highest UL Ratings for Wind Uplift, Fire and Impact Resistance
- No Coastal Set Back



PANEL DETAILS

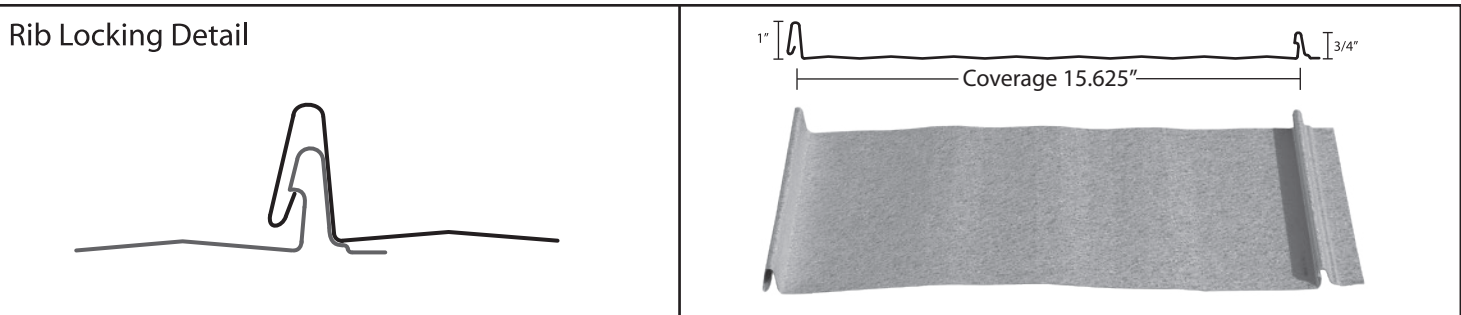

CERTIFICATIONS & TESTING

- UL 790 Fire Resistance Class A
- UL 2218 Impact Resistance Class 4
- UL 580 Uplift UL Class 90 Construction #529
- UL 1897 Uplift Test for Roof Covering
- Texas Department of Insurance Approval #156
- Miami-Dade County NOA Compliant

INSTALLATION

Advantage-Lok II is a snap locking standing seam panel that's easy to install and ideal for residential and commercial applications. Panels are installed by fastening the male panel leg screw flange to the substrate with pancake head screws. The female panel rib is simply snapped over the male leg which locks it into place and conceals the fasteners. Advantage-Lok II should be installed over solid decking with a minimum recommended roof pitch of 3:12.

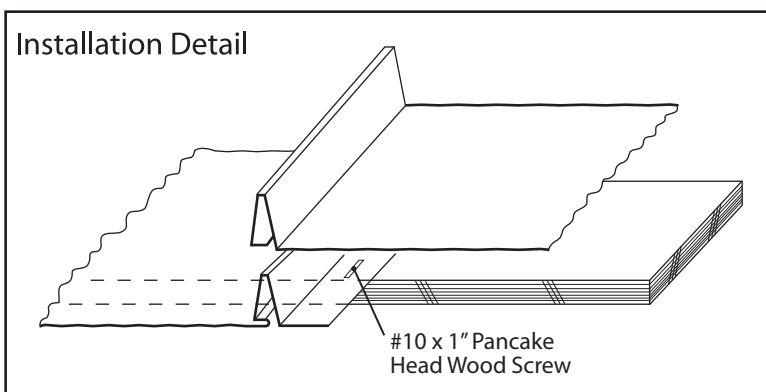

BEFORE BEGINNING INSTALLATION OF THIS PRODUCT, CHECK LOCAL BUILDING CODES.

** For more information, call (888) MTL-ROOF or visit our website at www.unioncorrugating.com **

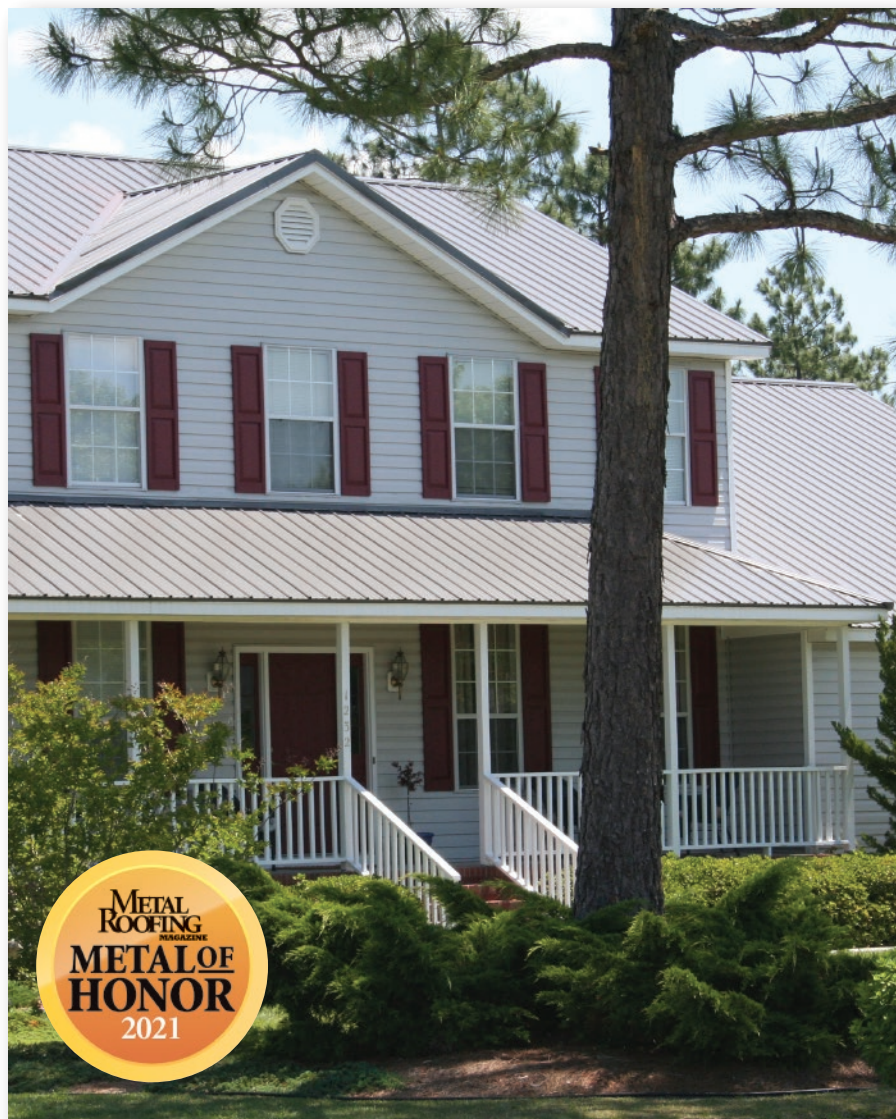

Contact your sales representative for more information.

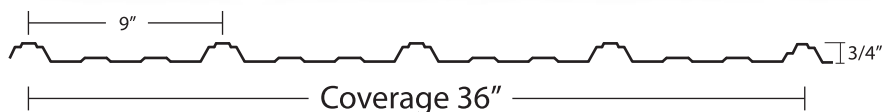

Description

An industry leader in strength and durability, this popular and versatile panel features classic looks and is used in a wide range of applications including residential, commercial, and post-frame installations. MasterRib was designed with extra-wide ribs to increase strength and ease in handling and installation. In addition, the oversized anti-siphoning channel on the underlap rib provides superior water shedding capacity in the presence of extreme wind and rain loads.

Specifications

- Exposed fastener panel for roof and wall applications
- 3:12 minimum recommended roof pitch
- Suitable for solid deck or open framing

Substrates and Coatings

- 29 and 26 gauge high strength steel
- Anti-corrosion AZ50 Galvalume coating for painted and AZ55 for unpainted steel.
- 45 Year and Lifetime Siliconized Modified Polyester Paint System

Finish Options

- 20 Paint Colors
- Energy Star Certified Color Available
- Unpainted Galvalume
- Unpainted Galvanized

Approvals and Certifications

- Metal Construction Association Certified
- Miami-Dade Approved for Wind Uplift
- Florida Building Code Approved
- Energy Star Certified
- Texas Department of Insurance Approved
- Highest UL Ratings for Wind Uplift, Fire and Impact Resistance
- No Coastal Set Back



CERTIFICATIONS & TESTING

- UL 580 Class 90 Wind Uplift Construction #584
- UL 790 Fire Resistance Class A
- UL 2218 Impact Resistance Class A
- Texas Department of Insurance Approval #116
- Metal Construction Association (MCA) Certified
- Miami Dade County NOA Compliant

ALLOWABLE UNIFORM LOADS PER SQUARE FOOT

Maximum purlin spacing for roof 2' on center and maximum girt spacing for sidewall 3' on center. Place fasteners in the pan of panel for best results. (Three spans or more)

SPAN (INCHES)	LIVE LOAD (lb/ft ²)						WIND LOAD (lb/ft ²)					
	18"	24"	30"	36"	48"	54"	18"	24"	30"	36"	48"	54"
29 Gauge	199	112	71	49	28	22	211	118	76	52	29	23
26 Gauge	268	150	96	67	37	29	276	155	99	69	38	30

NOTES:

1. Theoretical allowable loads are based on section properties and allowables calculated in accordance with 2001 AISI Specifications.
2. Theoretical allowable loads are based on three or more uniform spans.
3. For roof panels, deduct self weight for actual 'live load' capacity of the panel.
4. These loads are for panel strength. Frames, purlins, decks and fasteners must be designed to resist all loads imposed on the panel.
5. Check local building codes if panel testing is required.

RECOMMENDED FASTENING PATTERN FOR 1-1/2" SCREWS

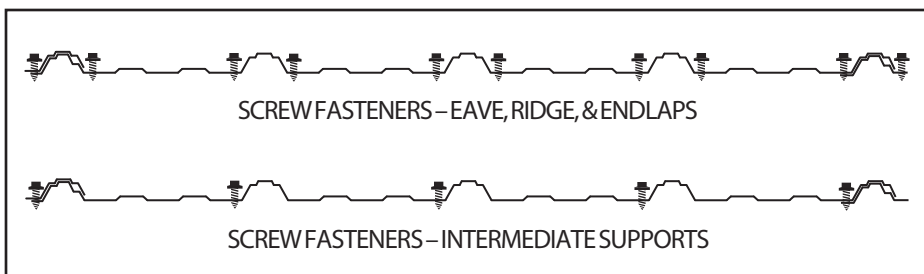

PANEL OVERLAP

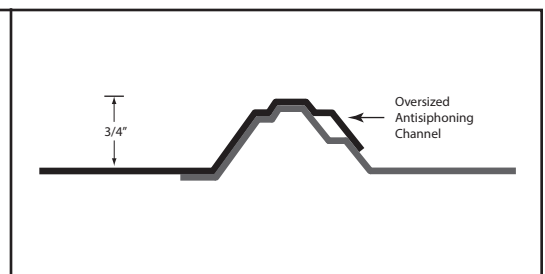

STORAGE

If the panels are not to be used immediately, store inside in a well ventilated and dry location. Condensation or other moisture can form between the sheets during storage, causing white rust or water stains, which detract from the appearance of the product, and may effect the product's useful life. Trapped moisture between sheets of painted metal can cause white rust to form underneath the paint. This can cause the paint to flake off of the panel immediately or several years later. To prevent white rust and staining, the following precautions should be taken:

1. Break the shipping bands on the metal and wipe the sheets dry.
2. Store metal on end or on an incline of at least 8" with support bands underneath to prevent sagging.
3. Fan sheets slightly at the bottom to allow for air circulation.
4. Keep the sheets off of the ground with an insulator such as wood.

Any outdoor storage is at the customer's own risk. If outdoor storage cannot be avoided, protect the metal using a canvas cover or waterproof paper. Never cover the metal with plastic as this will cause condensation to form.

BEFORE BEGINNING INSTALLATION OF THIS PRODUCT, READ OUR INSTALLATION INSTRUCTIONS.

** For more information, call (888) MTL-ROOF or visit our website at www.unioncorrugating.com **

25 YEAR LIMITED GALVALUME® WARRANTY



Your Roof. For Life.™

Union Corrugating Company warrants that its hot-dipped aluminum-zinc alloy-coated Galvalume® and Galvalume Plus® sheet steel with a coating weight of AZ50 sold for use as unpainted steel building panels erected within the continental United States, Alaska, Hawaii, Canada or the Caribbean, and exposed to normal atmospheric conditions, WILL NOT rupture, fail structurally, or perforate due to corrosion within a period of 20 years and 6 months after shipment from our mill. For a coating weight of AZ55, this period is extended to 25 years and 6 months.

This warranty **DOES NOT APPLY** to sheets exposed at any time to corrosive or aggressive atmospheric conditions, including, **BUT NOT LIMITED TO**:

1. areas subject to salt water marine atmospheres or to constant spraying of either salt or fresh water.
2. areas subject to fallout or exposure to corrosive chemicals, fumes, ash, cement dust, animal waste or its decomposition by-products, carbon black, or fallout from copper, lead, nickel or silver mining or refining operations.
3. areas subject to water run-off from lead or copper flashings or piping or areas in contact with lead or copper.
4. conditions/circumstances where corrosive fumes or condensates are generated or released inside the building.

This warranty **DOES NOT APPLY** in the event of:

1. bends less than 2T inside bend diameter for sheet thicknesses 0.030" and thinner, and less than 4T for sheet thicknesses greater than 0.030"
2. roof or sections of the roof flatter than 1/4:12 slope.
3. mechanical, chemical, or other damage sustained during shipment, storage, forming, fabrication, or during or after erection.
4. forming which incorporates severe reverse bending or which subjects the metallic coating to alternate compression and tension.
5. failure to provide free drainage of water, including, but not limited to, internal condensation, from overlaps and from all other surfaces of the sheets or panels.
6. failure to remove debris from overlaps and from all other surface of the sheets or panels.
7. damage caused to the metallic coating by improper forming (including, but not limited to, roll forming, press braking or embossing) or scouring or cleaning procedures.
8. deterioration of the panels caused by contact with green or wet or pressure-treated lumber, or wet storage stain caused by water damage or condensation.
9. presence of damp insulation, soil, vegetation or other corrosive materials in contact with or in close proximity to the sheets or panels.
10. deterioration to the panels caused by directly or indirectly by panel contact with fasteners or by overdriving the fasteners so as to damage the panel. Selection of suitable long-lasting fasteners to be used with Galvalume® and Galvalume Plus® panels rests solely with the Buyer. Fasteners are to be electrically insulated from the panel surface (e.g., with elastomeric grommets) to prevent dissimilar metal contact.
11. failures caused by acts of God, falling objects, external forces, explosions, fires, riots, civil commotions, acts of war or radiation.

This warranty shall be subject to the stipulations, limitations, and conditions hereinafter set forth:

1. This warranty shall be interpreted and enforced in accordance with the laws of the state of Maryland, USA, without regard to principles regarding conflicts of law, the courts of which State shall have exclusive jurisdiction and venue over the enforcement of this warranty. There is excluded from this warranty the application of the United Nations Convention on Contracts for the International Sale of Goods.
2. This warranty is contingent on the proper maintenance of the building, which maintenance is to be provided by the building owner.
3. Seller's liability for breach of this warranty and/or for the failure of material to conform, **whether due to Seller's negligent acts or omissions or otherwise**, shall be limited exclusively to the cost of either repairing nonconforming panels, or at Seller's sole option, of furnishing (FOB Seller's plant) sufficient sheet product to enable Buyer to fabricate replacement panels for the nonconforming panels.
4. Seller will be responsible for replacement of material only. Seller shall not in any event be liable for the cost of the labor expended by others on any nonconforming material or for any special, indirect or consequential damages to anyone caused by nonconforming material.
5. This warranty also applies to the material repaired or used to replace the nonconforming material, but only for the unexpired portion of the warranty period applicable to the original material.
6. Buyer shall promptly inspect the material and use reasonable care to protect any rejected material until Seller has time to conduct its own inspection and make or direct disposition.
7. In order for Seller to honor any claim on material shipped, Buyer must promptly document the claim with identification of material, date of installation, Seller's order number, coil number, invoice number and date of shipment and must give Seller a reasonable opportunity to inspect the material claimed to be nonconforming.
8. Except to the extent provided under applicable law, (a) Seller extends this warranty solely to the Buyer; and (b) this warranty is non-transferable and non-assignable.
9. Seller reserves the right to terminate this warranty at any time (except as to orders already accepted) upon the giving of written notice thereof.

SELLER MAKES NO GUARANTEES OR WARRANTIES, EITHER EXPRESSED OR IMPLIED, BEYOND THE DESCRIPTION ON THE FACE HEREOF, AND ALL OTHER WARRANTIES, INCLUDING, WITHOUT LIMITATION, WARRANTIES OF FITNESS FOR PARTICULAR PURPOSE AND MERCHANTABILITY, ARE HEREBY EXCLUDED; AND SELLER SHALL HAVE NO OTHER LIABILITY WITH RESPECT TO ANY OTHER GUARANTEES OR WARRANTIES.



Your Roof. For Life!
On Time and Complete!™

Residential/Post Frame Color Chart

- SMP[✓] Paint System
- 29 & 26 Gauge Galvalume[®] Steel Substrate
- 45-Year Industry Leading, Written Warranty on Painted Products with No Coastal Set Back

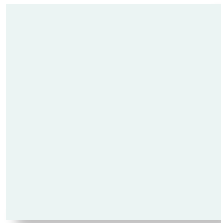

Arctic White*
TSR† = 63%

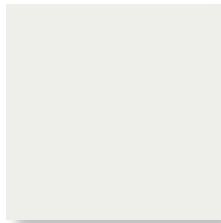

White
TSR = 46%

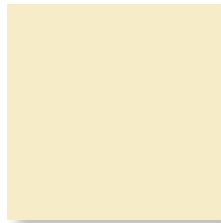

Ivory
TSR = 58%

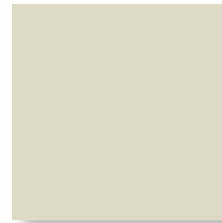

Light Stone
TSR = 51%

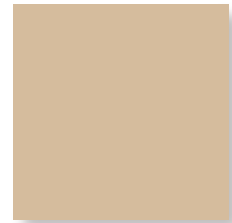

Sahara Tan
TSR = 36%

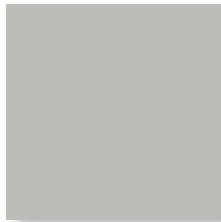

Pearl Gray
TSR = 35%



Cocoa Brown
TSR = 29%



Burnished Slate
TSR = 32%



Light Brown
TSR = 36%

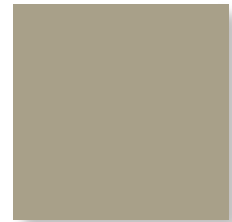

Clay
TSR = 32%

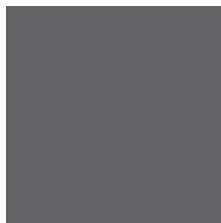

Charcoal Gray
TSR = 31%



Black
TSR = 25%



Patriot Red
TSR = 36%



Barn Red
TSR = 32%

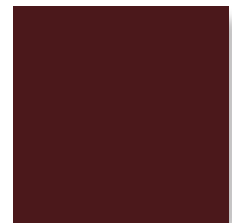

Burgundy
TSR = 25%

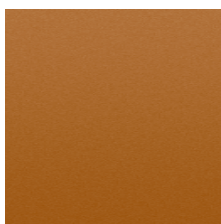

Copper Metallic‡
TSR = 46%



Gallery Blue
TSR = 25%



Royal Blue
TSR = 31%



Evergreen
TSR = 26%



Marine Green
TSR = 30%

Non-Painted



Acrylic Coated Galvalume
TSR = 55%



Denotes Energy Star™ certified high reflectance color which can reduce cooling costs.



Union utilizes the most advanced Siliconized Modified Polyester paint system in the industry, based on Akzo Nobel's Ceram-A-Star 1050 technology.

Note: Colors shown have been matched as accurately as possible to actual finish. For exact color match, please request a metal color sample. Availability of colors and materials is subject to change. Most panels are available in bare galvanized or bare galvalume.

† TSR = Total Solar Reflectance. An Energy Star™ certified color must meet the following TSR requirements: 25% initial, 15% after 3 years of exposure testing.

‡ Premium color. To ensure proper color match, orders for metallic colors should be placed so that they come from the same batch.

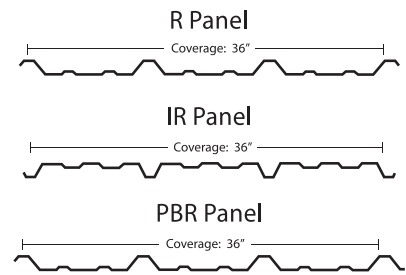
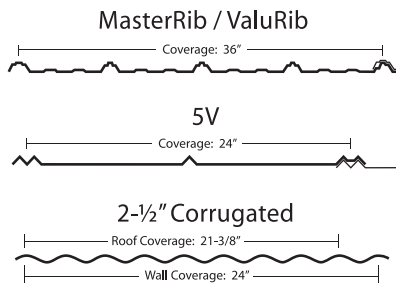
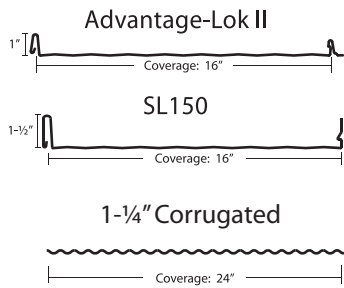

PANEL	GAUGE	COLOR																				
		Arctic White*	Barn Red	Black	Burgundy	Burnished Slate	Charcoal Grey	Clay	Cocoa Brown	Copper Metallic	Evergreen	Gallery Blue	Ivory	Light Brown	Light Stone	Marine Green	Patriot Red	Pearl Gray	Royal Blue	Sahara Tan	White	Acrylic Coated Galvalume
Advantage Lok II	26	•	•	•	•	•	•	•	•	•	•	•	•	•	•	•	•	•	•	•	•	•
SL150	26	•	•	•	•	•	•	•	•	•	•	•	•	•	•	•	•	•	•	•	•	•
MasterRib	29	•	•	•	•	•	•	•	•	•	•	•	•	•	•	•	•	•	•	•	•	•
MasterRib	26	•	•	•	•	•	•	•	•	•	•	•	•	•	•	•	•	•	•	•	•	•
^s ValuRib	29	•																				
5V	29		•							•											•	•
5V	26	•				•				•	•				•	•				•	•	•
1-1/4" Corrugated	29																					•
2-1/2" Corrugated	29		•								•										•	•
2-1/2" Corrugated	26	•									•	•			•	•				•	•	•
R Panel	26	•	•		•	•	•		•	•	•	•		•	•	•	•	•	•	•	•	•
IR Panel	26	•	•		•	•	•		•	•	•	•		•	•	•	•	•	•	•	•	•
PBR Panel	26		•			•	•		•	•	•		•	•			•	•	•	•	•	•

*ValuRib is only offered in Arctic White at the following locations: Yukon, Janesville, Dayton and Scranton. Please see a Union Sales Representative for additional information.

^sValuRib colors are not Energy Star certified. Copper is a metallic paint with higher cost than SMP.

PERFORMANCE DATA

COLOR	INITIAL SOLAR REFLECTANCE	3YR. TOTAL SOLAR REFLECTANCE	INITIAL THERMAL EMITTANCE	SOLAR REFLECTANCE INDEX
Arctic White	0.65	0.63	0.87	78
Barn Red	0.32	0.32	0.87	33
Black	0.25	0.25	0.85	24
Burgundy	0.25	0.25	0.87	24
Burnished Slate	0.31	0.32	0.88	32
Charcoal Gray	0.30	0.31	0.88	31
Clay	0.33	0.32	0.87	35
Cocoa Brown	0.28	0.29	0.89	29
Copper Metallic	0.46	0.46	0.86	52
Evergreen	0.26	0.26	0.88	26
Gallery Blue	0.25	0.25	0.87	24
Ivory	0.60	0.58	0.87	71
Light Brown	0.35	0.36	0.88	38
Light Stone	0.52	0.51	0.87	60
Marine Green	0.30	0.30	0.87	31
Patriot Red	0.35	0.36	0.88	38
Pearl Gray	0.37	0.35	0.87	40
Royal Bue	0.30	0.31	0.87	31
Sahara Tan	0.36	0.36	0.87	39
White	0.56	0.46	0.87	66
Acrylic Coated Galvalume	0.67	0.55	0.14	56

ENERGY STAR Requirements

Initial Solar Reflectivity
 Steep Slope Roofs (>2:12) ≥ 0.25
 Low Slope Roofs (≤2:12) ≥ 0.65
 3 Year Solar Reflectivity
 Steep Slope Roofs (>2:12) = 0.15
 Low Slope Roofs (≤2:12) = 0.50

LEED 2.2 Requirements

Solar Reflectance Index (SRI)
 Steep Slope Roofs = ≥29
 Low Slope Roofs = ≥78

Note: Colors shown have been matched as accurately as possible to actual finish. For exact color match, please request a metal color sample. Availability of colors and materials is subject to change. Most panels are available in bare galvanized or bare galvalume.

Plant Locations:

Corporate Headquarters**

701 S. King St.
 Fayetteville, NC 28301
 888-685-7663

Vicksburg, MS

1463 Interplex Circle
 Ceres Industrial Complex
 Vicksburg, MS 39183
 888-661-0577

Morrison, TN**

7747 Manchester Hwy.
 Morrison, TN 37357
 931-668-4393

Dayton, OH

625 N. Third St.
 Tipp City, OH 45371
 877-615-9812

Tifton, GA

3365 US Hwy 41 S.
 Tifton, GA 31794
 800-962-9131

Oklahoma City, OK*

600 N. Sara Rd. Ste B
 Yukon, OK 73099
 866-373-5286

Orange, VA

12435 James Madison Hwy.
 Orange, VA 22690
 800-762-6785

Scranton, PA*

100 Keystone Industrial
 Park Road
 Suite 2B
 Dunmore, PA 18512
 866-695-6455

Ocala, FL**

490 Oak Rd.
 Ocala, FL 34472
 800-331-3584

Janesville, WI**

3920 Kennedy Rd.
 Janesville, WI 53545
 608-563-3226

ADVANTAGE LOK II

Description

Remove existing roofing system and install Union Corrugating Advantage LOK II Standing Seam Metal Roof System

High Temperature Ice+Water Barrier (on all eaves, valleys, and protrusions)

Synthetic Underlayment - adds a second layer of protection over your entire roof.

Fasteners

Metal Hip and Ridge Caps

Ridge venting - the most efficient way to help heat exhaust from your attic

Disposal Bin - rental and disposal fees for all waste from job
(up to 35 SQ)

Quote subtotal \$62,700.00

Total \$62,700.00

MASTERRIB

Description

Remove existing roofing system and install Union Corrugated MasterRib 4x8 Sheet Metal

High Temp Ice+Water Barrier (on all eaves, valleys, and protrusions)

Synthetic Underlayment - adds a second layer of protection over your entire roof

TRI-BUILT 1-1/4" to 4" Hard Pipe Flashing Black

Fasteners

Metal Hip and Ridge Caps

Ridge venting - the most efficient way to help heat exhaust from your attic

Disposal Bin - rental and disposal fees for all waste from job
(up to 35 SQ)

Quote subtotal \$43,200.00

Total \$43,200.00

AUTHORIZATION PAGE

Advantage LOK II

\$62,700.00

Name: Amie Hanaway

MasterRib

\$43,200.00

Address: 199 northview-Dorsey, Rutherfordton, NC

Description	Qty	Unit price	Line total
<input type="checkbox"/>			

Customer Comments / Notes

Amie Hanaway:

Date:

TERMS AND CONDITIONS

You may cancel this contract from the day you enter into the contract until 7 days after you receive a copy of the contract. You do not need a reason to cancel. If you do not receive the goods or services within 30 days of the date stated in the contract, you may cancel this contract within one year of the contract date. You lose that right if you accept delivery after the 30 days. There are other grounds for extended cancellation. For more information, you may contact your provincial/territorial consumer affairs office. If you cancel this contract, the seller has 15 days to refund your money and any trade-in, or the cash value of the trade-in. You must then return the goods. To cancel, you must give notice of cancellation at the address in this contract. You must give notice of cancellation by a method that will allow you to prove that you gave notice, including registered mail, fax or by personal delivery.

I understand that if roof rot is discovered during tear-off COMPANY NAME reserves the right to replace sheathing and bill me up to \$200 in addition to the estimated cost below without notifying me in advance. COMPANY NAME will call me for authorization if wood replacement will exceed \$200.

I understand that I must remove items from the interior walls of my home that may be damaged or fall due to vibrations from the loading/installation of shingles on to my roof (if applicable), or installation of siding. COMPANY NAME is not liable for such damages.

I understand that minor stucco damage may result when the roof is torn off areas where stucco meets my roof's surface, especially where improperly applied. COMPANY NAME is not liable for repairing said damage.

I understand that any warranty for material used during the project is provided by the material manufacturer. Unless agreed upon otherwise, COMPANY NAME provides a 5-year Workmanship Warranty on portions of the project in which COMPANY NAME fully replaced any existing products. Roofing workmanship warranties will be reduced to one year when home owners have requested that full synthetic underlayment not be installed. Full warranty details available by request.

I understand that, unless agreed upon. This does not apply to products, some of which may deteriorate more rapidly (ie. sealants) and should be inspected on a regular basis, and am not responsible for material shortage and have no claim to material surpluses.

I certify that I am the registered owner of the above project property, or have the legal permission to authorize COMPANY NAME to perform the work as stated and agree to pay the total project price.

I understand that any insurance claims are subject to the specific terms and conditions outlined by my insurance company, and may be subject to insurance company approval.

I understand that payment in full is due upon completion of work as stated in contract. All invoices not paid in full after 15 days will be subject to a 2% per month interest charge.

I understand that approval of my estimate is subject to customer credit approval by COMPANY NAME.

I agree that COMPANY NAME may access my credit bureau report(s), trade references, and other credit information prior to granting credit approval.

I acknowledge that I have read and understand this page. Initials: _____