

Western Hills Athletic Club

4801 Rollingwood Drive Austin, Texas 78746

SUBMITTAL DATE
DATE: APRIL 24, 2020

Sheet List		
Sheet Index	Sheet Number	Sheet Name
1	000	COVER SHEET
2	001	GENERAL NOTES
3	010	EXISTING CONDITIONS
4	101	SITE PLAN
5	181	SITE DETAILS
6	191	SITE DETAILS
7	201	DEMOLITION PLAN
8	231	EROSION/SEDIMENTATION CONTROL & TREE PROTECTION PLAN
9	281	EROSION / SEDIMENTATION CONTROL & TREE PROTECTION DETAILS
10	301	GRADING PLAN
11	501	EXISTING DRAINAGE AREA MAP
12	502	EXISTING DRAINAGE AREA CALCULATIONS
13	503	PROPOSED DRAINAGE AREA MAP
14	504	PROPOSED DRAINAGE AREA CALCULATIONS
15	531	WATER QUALITY POND PLAN
16	541	DETENTION POND PLAN
17	542	DETENTION POND PLAN
18	543	DETENTION POND DETAILS
19	544	DETENTION POND DETAILS
20	545	DETENTION POND DETAILS
21	546	DETENTION POND DETAILS
22	700	LANDSCAPE NOTES & CALCULATIONS
23	701	LANDSCAPE PLAN
24	710	WATER QUALITY POND PLANTING PLAN
25	791	LANDSCAPE DETAILS
26	801	IRRIGATION PLAN

OWNER:
WESTERN HILLS ATHLETIC CLUB
4801 ROLLINGWOOD DR
AUSTIN, TEXAS 78746

LANDSCAPE ARCHITECT:
MWM DESIGN GROUP, INC.
305 E HUNTLAND DR, STE #200
AUSTIN, TEXAS 78752

CONTACT:
CATHERINE SCOTT, PRESIDENT
(512) 327-6373

CONTACT:
DAVID CAZARES, ASLA, LEED AP
(512) 453-0767

CIVIL ENGINEER / AGENT:
MWM DESIGN GROUP, INC.
305 E HUNTLAND DR, STE #200
AUSTIN, TEXAS 78752

CONTACT:
MATTHEW RECTOR, P.E., CFM
(512) 453-0767

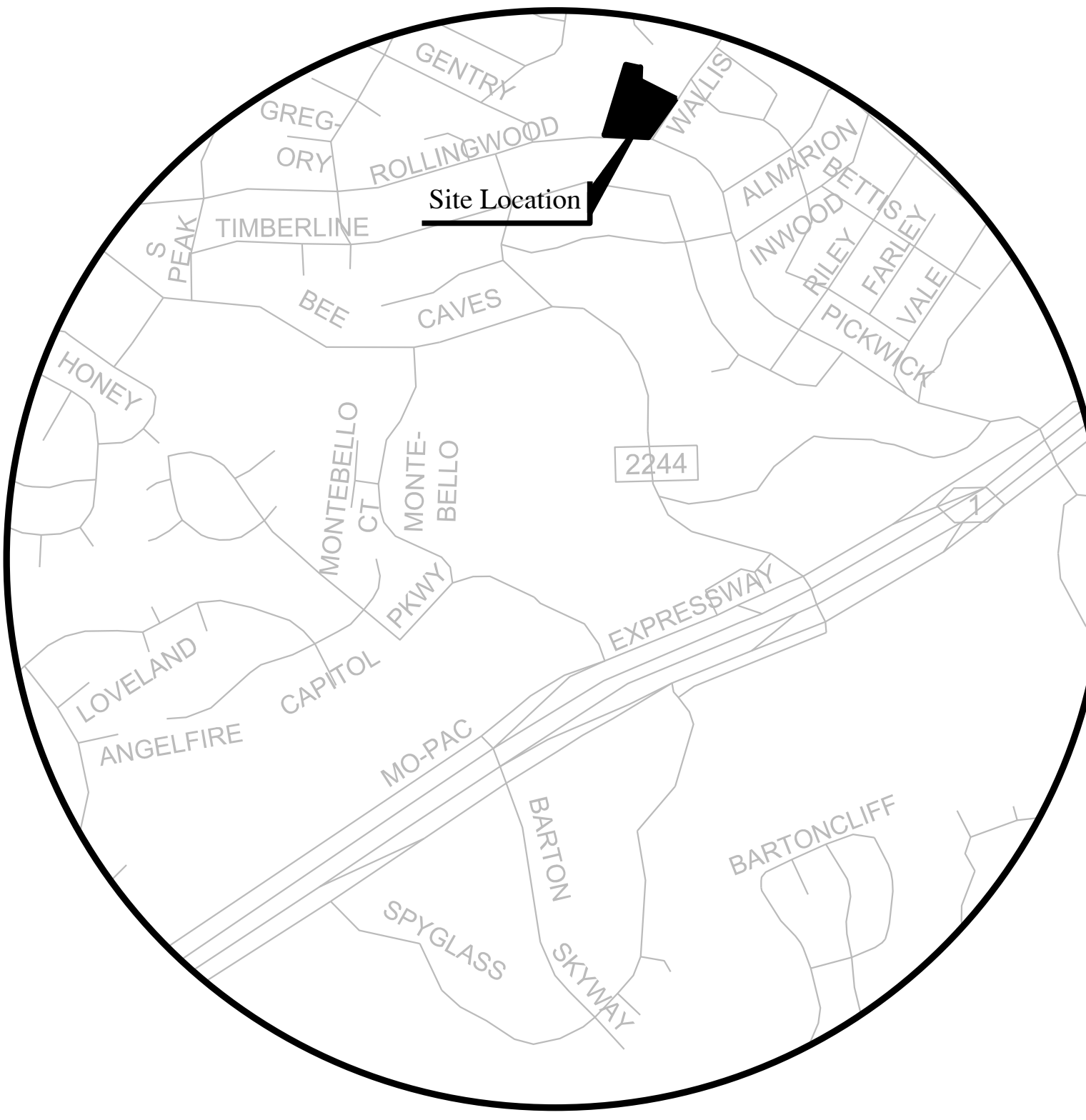

LOCATION MAP

NOTES:

1. THIS SITE LIES WITHIN THE ROLLINGWOOD FULL PURPOSE JURISDICTION.
2. NO PORTION OF THIS SITE IS WITHIN THE 100 YEAR FLOODPLAIN AS PER FEMA FIRM PANEL #48453C0445K, DATED JANUARY 22, 2020.
3. NO CRITICAL ENVIRONMENTAL FEATURES ARE KNOWN TO EXIST WITHIN 150' OF THE PROJECT SITE.
4. THIS SITE IS LOCATED OVER THE EDWARD'S AQUIFER RECHARGE ZONE.
5. TREES GREATER THAN 8" IN DIAMETER ARE KNOWN TO EXIST ON THIS SITE.
6. AS PART OF THE SITE PLAN, THE STORM WATER POLLUTION PREVENTION PLAN (SWPPP) IS REQUIRED TO BE ON SITE AT ALL TIMES.

LEGAL DESCRIPTION: LOT 1, WESTERN HILLS ATHLETIC CLUB ADDITION
 ZONED: PARK ZONING DISTRICT (P)
 PROPOSED IMPERVIOUS COVER: 68186.17 SF, 50%
 WATERSHED: LADY BIRD LAKE & EANES CREEK CLASSIFICATION: SUBURBAN

RELEASE OF THIS APPLICATION DOES NOT CONSTITUTE A VERIFICATION OF ALL DATA, INFORMATION AND CALCULATIONS SUPPLIED BY THE APPLICANT. THE ENGINEER OF RECORD IS SOLELY RESPONSIBLE FOR THE COMPLETENESS, ACCURACY AND ADEQUACY OF HIS/HER SUBMITTAL, WHETHER OR NOT THE APPLICATION IS REVIEWED FOR CODE COMPLIANCE BY CITY ENGINEERS.

SUBMITTED BY:

 MATTHEW RECTOR, P.E., CFM DATE
 MWM DESIGN GROUP
 305 E HUNTLAND DRIVE, SUITE 200
 AUSTIN, TX. 78752
 (512)453-0767

APPROVED BY: _____ DATE
 FOR DIRECTOR OF PLANNING AND
 DEVELOPMENT REVIEW DEPARTMENT

 SITE DEVELOPMENT PERMIT NUMBER

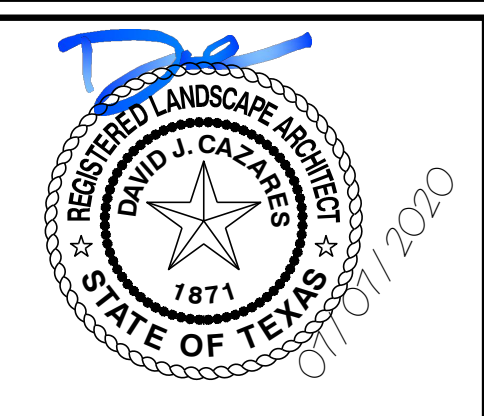

mwm Design Group
 305 East Huntland Drive
 Suite 200
 Austin, Texas 78752
 p: 512.453.0767
 f: 512.453.1734
 TBAE FIRM REGISTRATION NO.: 1452
 TBPE FIRM REGISTRATION NO.: F-1416
 TBPLS FIRM REGISTRATION NO.: 10065600

NO.	DATE	DESCRIPTION	BY

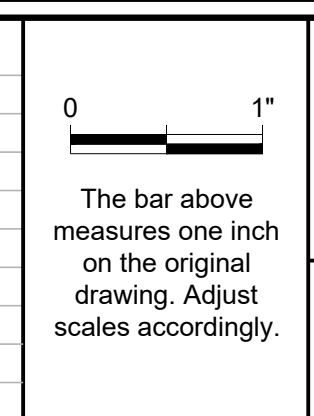

COVER SHEET

Western Hills Athletic Club
 4801 Rollingwood Drive
 Austin, TX 78746

PLOTTED: 7/7/2020
 JOB NO: 863-01
000
 1 OF 26

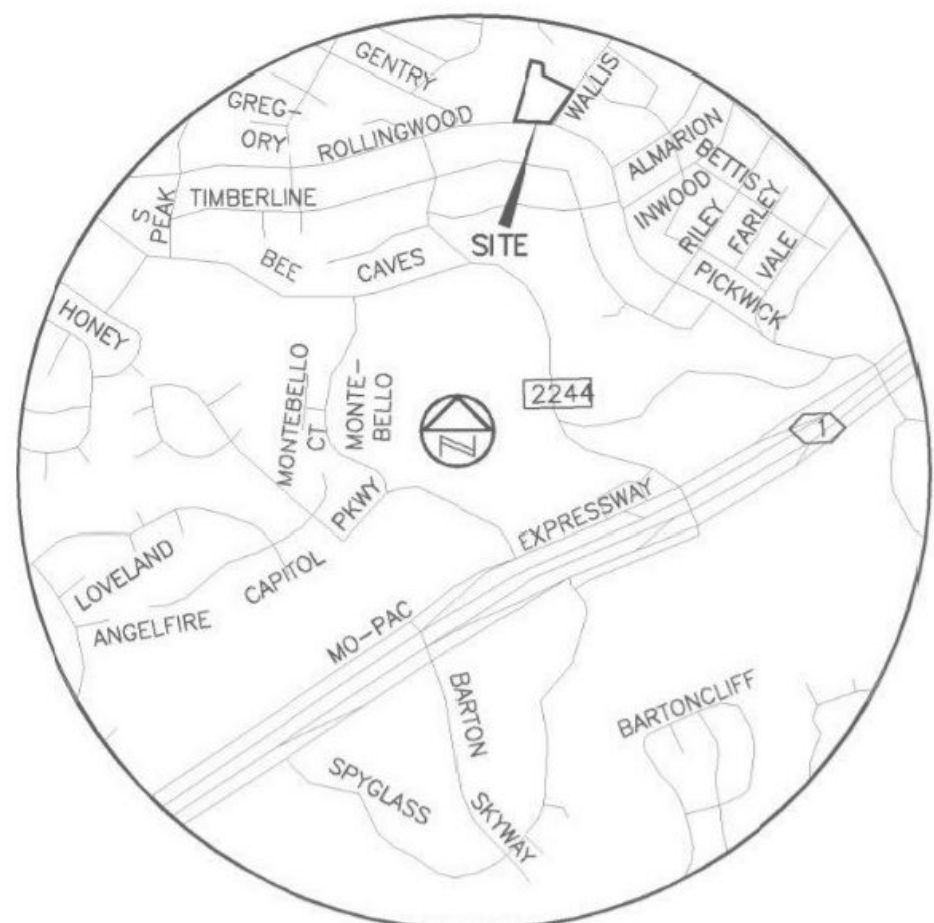

LOCATION MAP NOT TO SCALE

A SURVEY OF ALL OF LOT 1, WESTERN HILLS ATHLETIC CLUB ADDITION, A SUBDIVISION OF RECORD IN TRAVIS COUNTY, TEXAS ACCORDING TO THE MAP OR PLAT THEREOF RECORDED IN VOLUME 79, PAGE 355 OF THE THE PLAT RECORDS OF TRAVIS COUNTY, TEXAS, SAVE AND EXCEPT A 2,411 SQUARE FEET TRACT DESCRIBED IN VOLUME 11901, PAGE 1260 OF THE REAL PROPERTY RECORDS OF TRAVIS COUNTY, TEXAS.

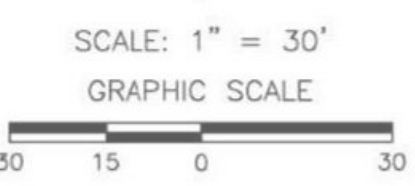

TREE LIST				
16901 HB 7 4	20027 CE 8	20055 LO 8 7	20082 LO 21	20118 CDR 7
16902 CE 6 4	20028 CE 9	20056 CDR 13	20083 LO 17	20119 CDR 9
16903 LO 9	20029 CB 14	20057 LO 16 12	20084 LO 12	20120 CDR 7
16904 LO 7	20030 CB 14	20058 CDR 14	20086 LO 12	20121 LO 7
16905 LO 9	20032 HB 13	20059 LO 13	20088 LO 14	20122 CDR 6
16906 LO 8	20033 CB 9	20060 CDR 7	20089 LO 11	20123 CDR 8
16907 CE 7 4	20034 CB 11 7 5	20061 CE 6	20090 LO 16	20124 CDR 6
16908 LO 13	20035 CB 7	20062 CDR 8	20125 LO 13	20126 LO 10
16909 LO 7	20036 CB 8	20063 LO 17	20126 LO 9	20127 LO 8
16910 CB 9	20038 CB 15	20064 CDR 10	20095 LO 10	20128 LO 8
16911 CB 7	20039 CDR 10	20065 PO 19 16	20096 LO 11	20129 CDR 6
16912 LIC 8 6	20040 CE 8	20066 CDR 6 9	20097 LO 12	20130 CDR 12
16913 BE 8	20041 CE 13	20067 LO 7	20098 LO 12	20131 CDR 7
16914 BE 6	20042 CE 12	20068 LO 10	20099 LO 15	20132 CDR 7
16915 BE 6	20043 CE 10 8	20069 LO 11 8	20100 LO 12	20133 CE 9
16916 WLNT 7	20044 LO 10	20070 CDR 7	20101 LO 13	20134 CE 10
16917 WLNT 6	20045 LO 8	20071 CE 6	20102 LO 19 17	20135 LO 13 10
16918 WLNT 6	20046 LO 13	20072 CB 7	20103 LO 20	20136 HB 6
20015 LO 23 21 19 19	20047 LO 12	20073 LO 15	20105 CE 15	20137 CDR 6
20017 CE 18	20048 LO 13	20074 LO 15	20106 LO 10	20138 CE 8
20018 LO 20	20049 HB 8	20076 LO 15	20107 LO 12	20139 CDR 8
20021 LO 19	20050 CE 10	20077 LO 17	20108 LO 7	20140 HB 9
20023 PEC 17	20051 LO 11	20078 LO 17	20109 LO 12	20114 CE 9
20024 LO 18	20052 LO 12	20079 LO 19	20110 LO 7	20141 PEC 11
20025 LO 13	20053 LO 10	20080 LO 18	20111 CDR 10	20142 PEC 10
20026 LO 8 5	20054 LO 17 16	20081 LO 11	20117 LO 9	20143 CDR 6

TREE LEGEND	
BE	BOX ELDER
CB	CHINA BERRY
CDR	CEDAR
CE	CEDAR ELM
HB	HACKBERRY
LIG	LIGUSTRUM
LO	LIVE OAK
PEC	PECAN
WLNT	WALNUT

BENCHMARK NOTE:
 B.M. #1 - SQUARE CUT ON B.O.C., NORTH SIDE OF ROLLINGWOOD DR. +/-105 FEET WEST OF WALLIS DR. ELEV.=628.77'
 B.M. #3 - SQUARE CUT ON B.O.C. ON THE WEST SIDE OF WALLIS DR. +/-190 FEET NORTH OF ROLLINGWOOD DR. ELEV.=631.07'

MANHOLE AND INLET NOTE:
 THIS SURVEY SHOWS FIELD MEASURED SIZES AND DEPTHS AS OBSERVED FROM GROUND LEVEL OPENINGS. EXACT MEASUREMENTS AND DEPTHS PARTICULARLY IN CRITICAL AREAS, SHOULD BE VERIFIED WITH UTILITY RECORD MAPS AND/OR FIELD VERIFICATION PRIOR TO FINAL PLANNING OR CONSTRUCTION.

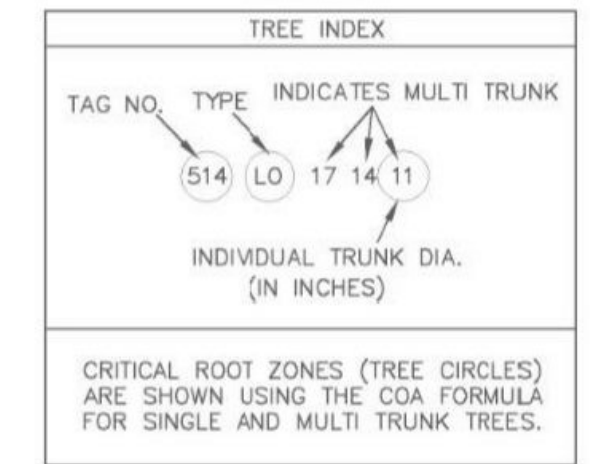

LEGEND	
●	1/2" REBAR FOUND
△	CALCULATED POINT
⊙	3/4" IRON PIPE FOUND
▲	NAIL FOUND
✱	COTTON SPINDLE FOUND
⊕	BENCHMARK LOCATION
⊠	WATER METER
⊗	WATER VALVE
⊕	FIRE HYDRANT
⊗	SPRINKLER CONTROL VALVE
⊕	UTILITY POLE
—	GUY WIRE
—	OVERHEAD UTILITIES
⊗	LIGHT POLE
⊕	WASTEWATER CLEANOUT
⊕	WASTEWATER MANHOLE
⊕	STORMSEWER MANHOLE
⊕	HANDICAP PARKING SPACE
⊕	AC PAD
⊕	GAS UTILITY
⊕	ELECTRIC UTILITY
—	SIGN
—	EDGE OF PAVEMENT
—	WROUGHT IRON FENCE
—	CHAIN LINK FENCE
⊕	PUMP BOX
⊕	PUMP

FLOOD-PLAIN NOTE:
 The tract shown hereon lies within Zone "X" (areas determined to be outside 500-year flood-plain), as identified by the Federal Emergency Management Agency, Federal Insurance Administration, as shown on map no. 484500045A, dated January 08, 2016, for Travis County, Texas and incorporated areas. If this site is not within an identified special flood hazard area, this flood statement does not imply that the property and/or the structures thereon will be free from flooding or flood damage. This flood statement shall not create liability on the part of the surveyor.

TITLE COMMITMENT NOTE:
 This Survey was prepared without the benefit of a Commitment for Title, and may be subject to additional easements or restrictions not shown hereon. No additional easement research was done for the purpose of this survey.

NOTE FROM PREVIOUS SURVEY (9/26/07):
 The Travis CAD map 01_0909 (01/04/2006) shows what appears to be additional R.O.W. for Rollingwood Drive and Wallis Drive. There was no monumented evidence in the field of a R.O.W. dedication along the north line of Rollingwood Drive. After researching Travis CAD and the Travis County Clerk records, we were not able to locate any documents reflecting additional street frontage conveyed to the City of Rollingwood. Since no title research was provided by the client, there was not enough data to accurately determine the position of the intersection of the north R.O.W. of Rollingwood Drive and the west R.O.W. of Wallis Drive, so the position is represented on the map by a calculated point for the purposes of this survey.

SURVEYOR'S CERTIFICATE:
 CERTIFIED TO:
 Julie Martinez
 Western Hills Athletic Club

PROPERTY ADDRESS: Rollingwood Drive @ Wallis Drive

DATE OF SURVEY: 09/26/07; Topographic and Tree Survey Updated 09/20/17, Updated 4/27/18

BEARING BASIS: Grid azimuth for Texas Central Zone state plane coordinates, based on GPS solutions from The National Geodetic Survey (NGS) On-line Positioning User Service (OPUS).

ATTACHMENTS: none

I hereby certify that a survey of the property shown hereon was actually made upon the ground under my direction and supervision on the date shown, and that to the best of my professional knowledge and belief, there are no apparent encroachments, overlapping of improvements, discrepancies, deed line conflicts, visible utility lines or roads in place, except as shown hereon, and that this property abuts or adjoins a dedicated road right-of-way or access easement, unless noted hereon.

Robert C. Watts, Jr. Date
 Registered Professional Land Surveyor
 State of Texas No. 4995

Professional Land Surveying, Inc.
 Surveying and Mapping
 3500 McCall Lane
 Austin, Texas 78744
 512-443-1724
 Firm No. 10124500

PROJECT NO.: 585-001
 DRAWING NO.: 585-001-BASE
 PLOT DATE: 05/10/18
 PLOT SCALE: 1"=30'
 DRAWN BY: RGH/MAW/EBD
 SHEET 01 OF 01

CURVE TABLE						
NO.	DELTA	RADIUS	TAN	ARC	CHORD	BEARING (RECORD CHORD)
C1	4°35'35"	315.81'	12.67'	25.32'	25.31'	S10°15'58"W (S11°47'W 25.26')
C2	29°33'56"	122.57'	32.34'	63.25'	62.55'	S02°21'10"E (S00°43'E 62.57')

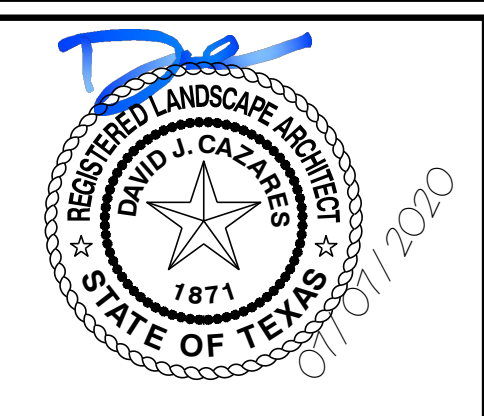
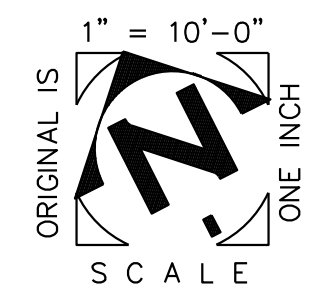
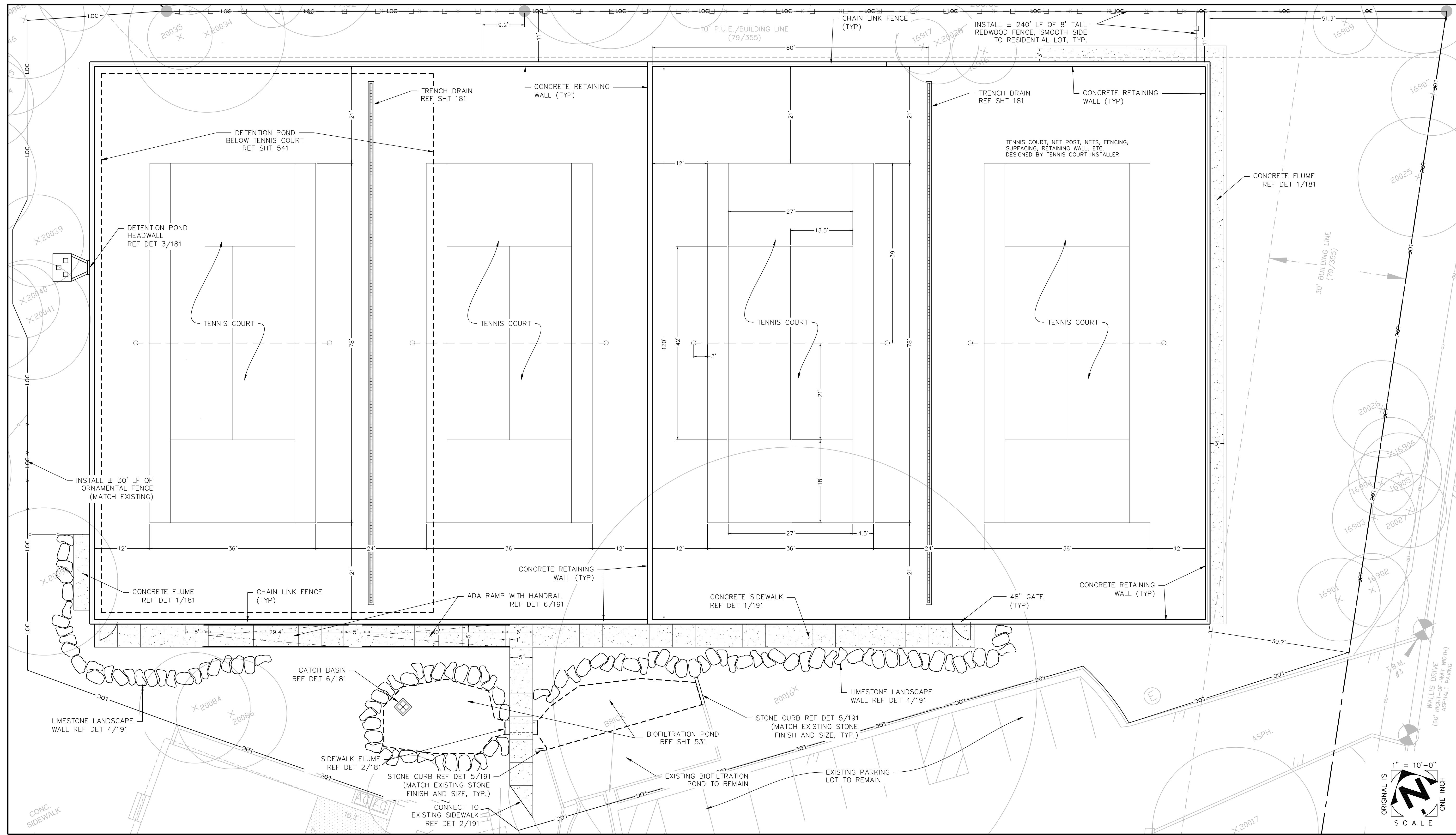

mwm
Design Group

305 East Huntland Drive
Suite 200
Austin, Texas 78752
p: 512.453.0767
f: 512.453.1734

TBAE FIRM REGISTRATION NO.: 1452
TBAE FIRM REGISTRATION NO.: F-14116
TBPLS FIRM REGISTRATION NO.: 10065600

NO.	DATE	DESCRIPTION	BY

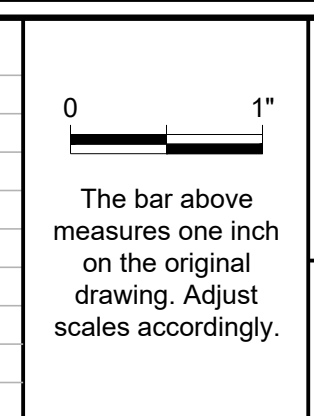

SITE PLAN

Western Hills Athletic Club
4801 Rollingwood Drive
Austin, TX 78746

PLOTTED: 7/7/2020
JOB NO: 863-01

101

4 OF 26

File: Y:\863-01_WHL_Athletic_Club\CAD\Sheets\101_Site Plan.dwg 22x34

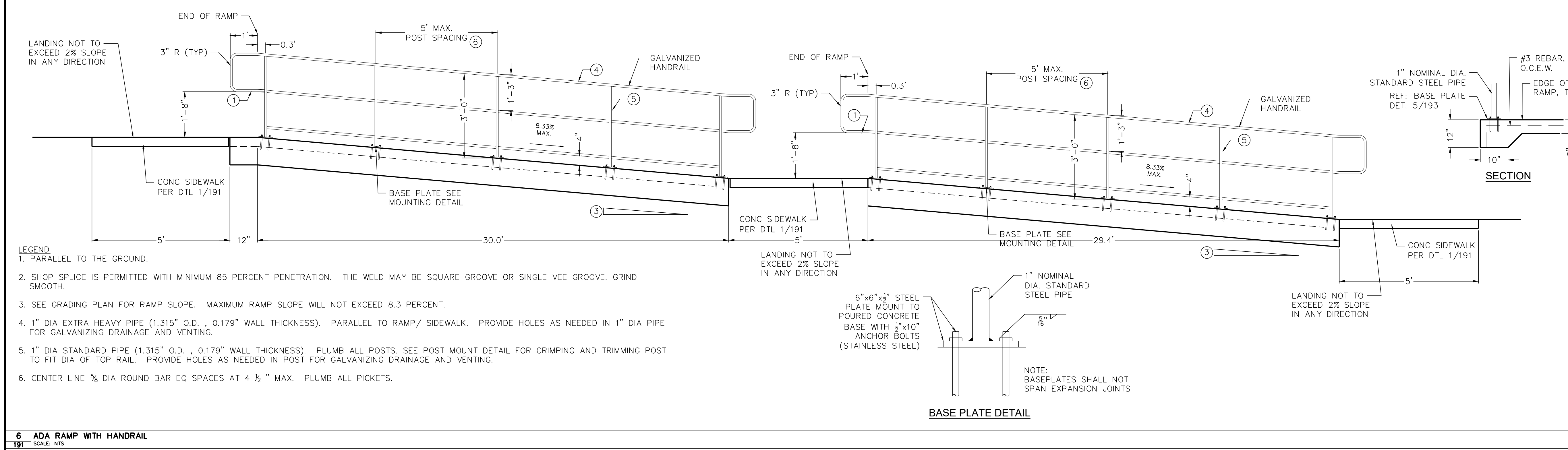
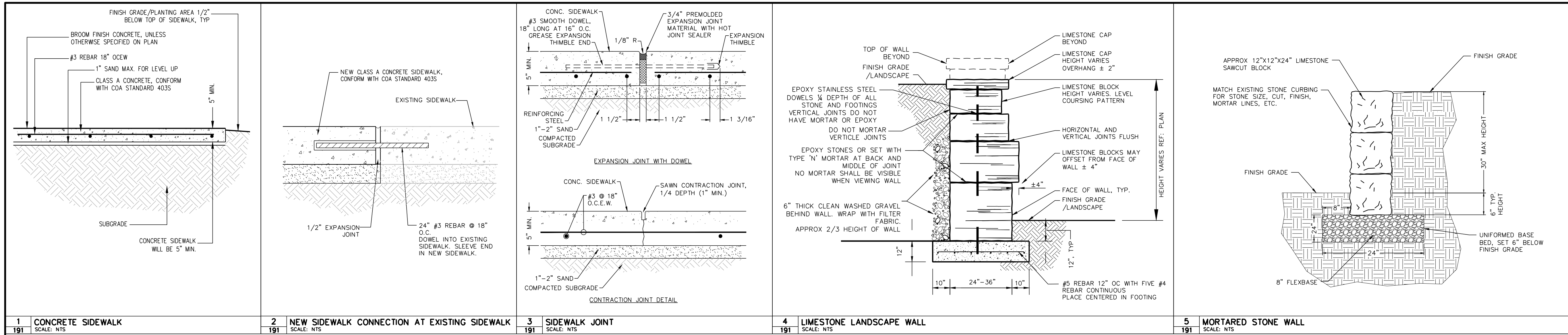

NO.	DATE	DESCRIPTION	BY

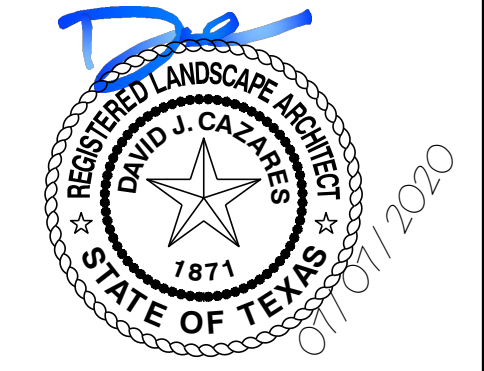

mwm Design Group
305 East Huntland Drive
Suite 200
Austin, Texas 78752
p: 512.453.0767
f: 512.453.1734
TBAE FIRM REGISTRATION NO.: 1452
TBEF FIRM REGISTRATION NO.: F-1416
TBPLS FIRM REGISTRATION NO.: 10065600



SITE DETAILS
Western Hills Athletic Club
4801 Rollingwood Drive
Austin, TX 78746

PLOTTED: 7/7/2020
JOB NO: 863-01
191
6 OF 26

File: Y:\863-01_WHP_Athletic_Club\CAD\Sheets\191_Site_Details.dwg 22x34

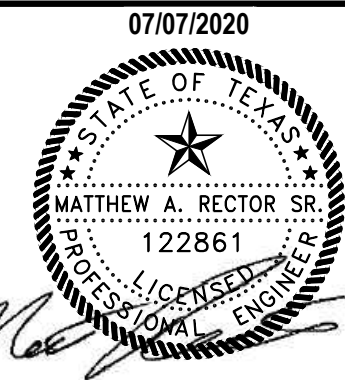
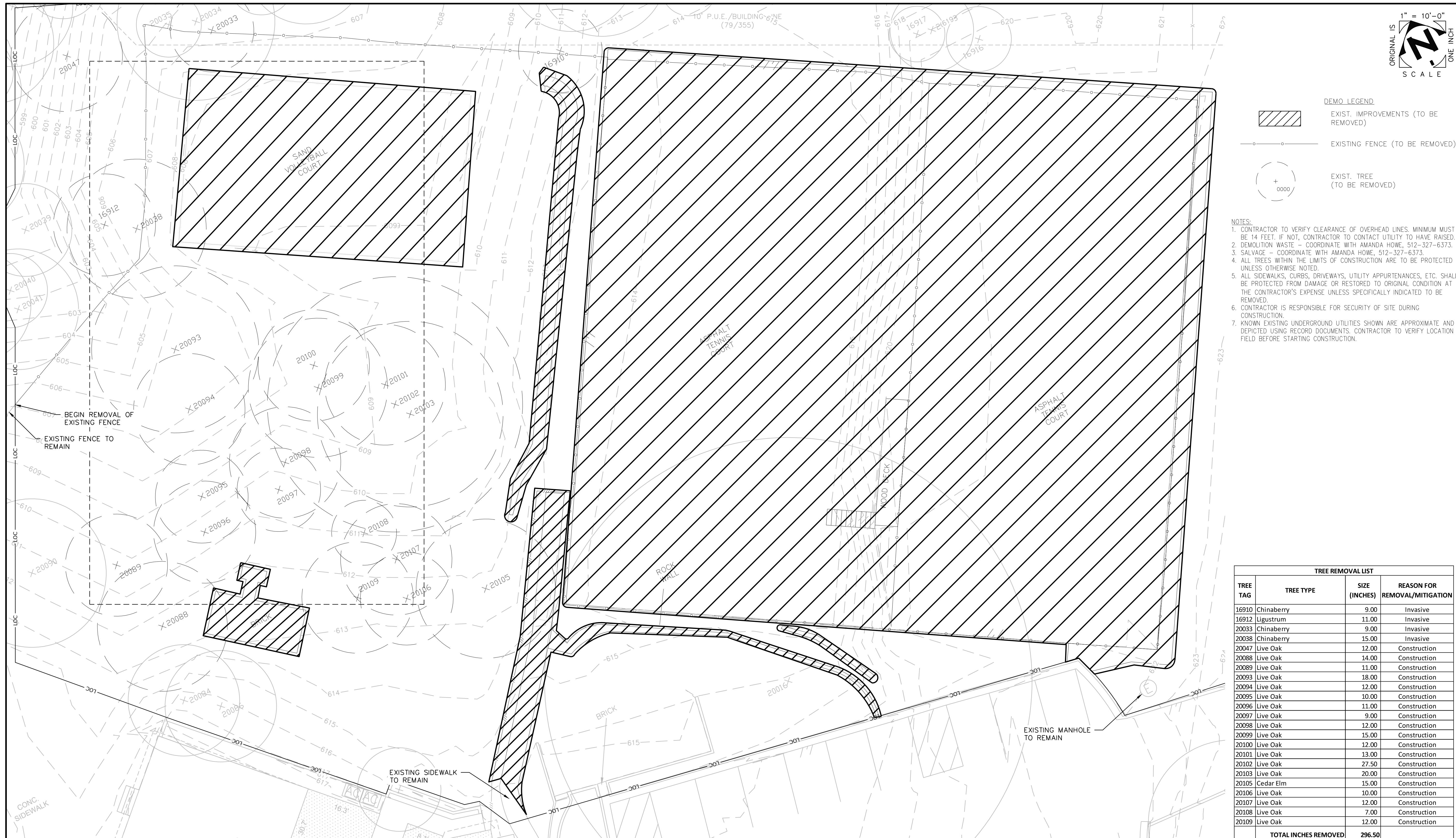

305 East Huntland Drive
Suite 200
Austin, Texas 78752
p: 512.453.0767
f: 512.453.1734

TBAE FIRM REGISTRATION NO.: 1452
TBEF FIRM REGISTRATION NO.: F-1416
TBPLS FIRM REGISTRATION NO.: 10065600

NO.	DATE	DESCRIPTION	BY

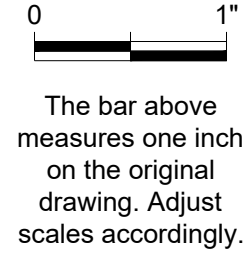

DEMOLITION PLAN

Western Hills Athletic Club
4801 Rollingwood Drive
Austin, TX 78746

PLOTTED: 7/7/2020
JOB NO: 863-01

201

7 OF 26

File: Y:\B63-01_WHL_Athletic_Club\CAD\Sheets\201_Demo_Plan.dwg 22x34

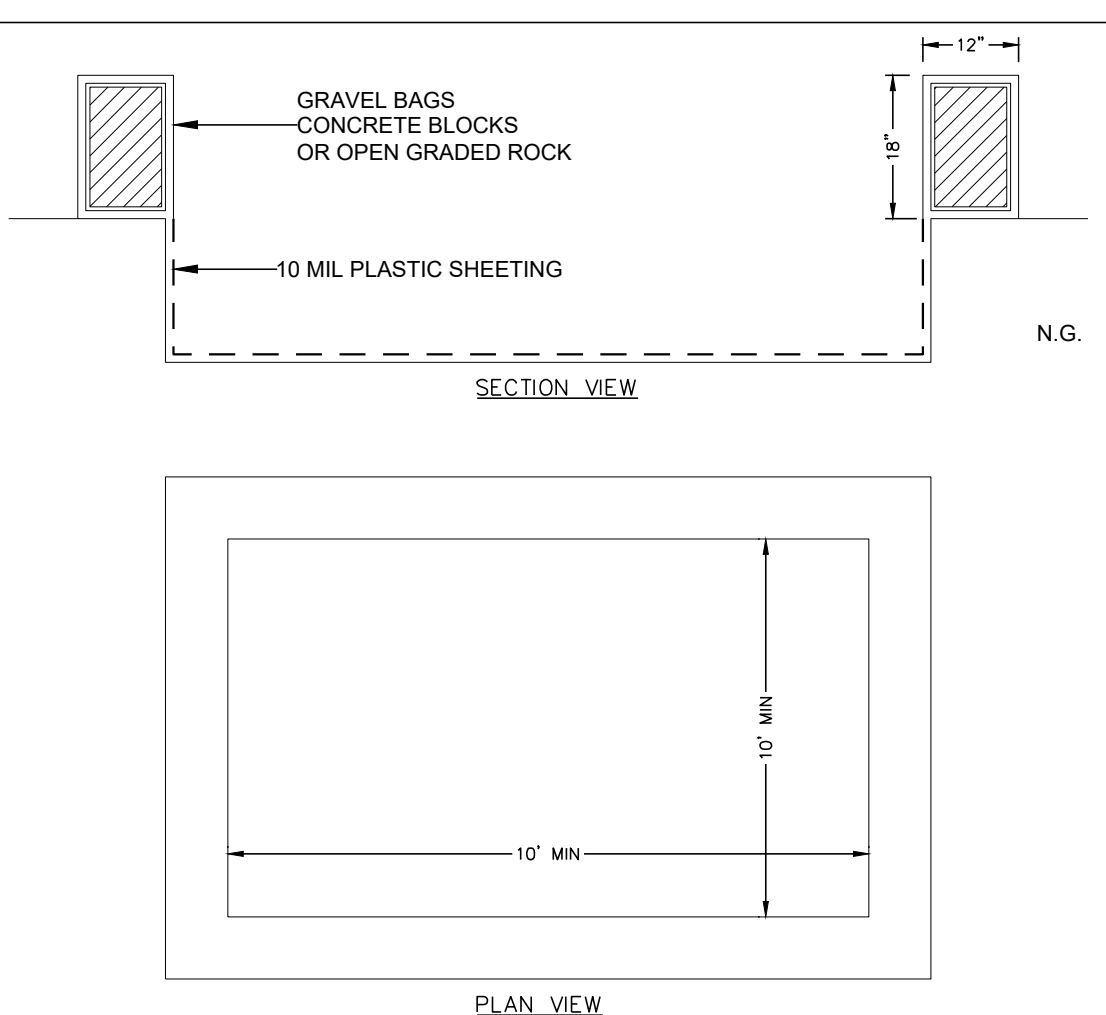
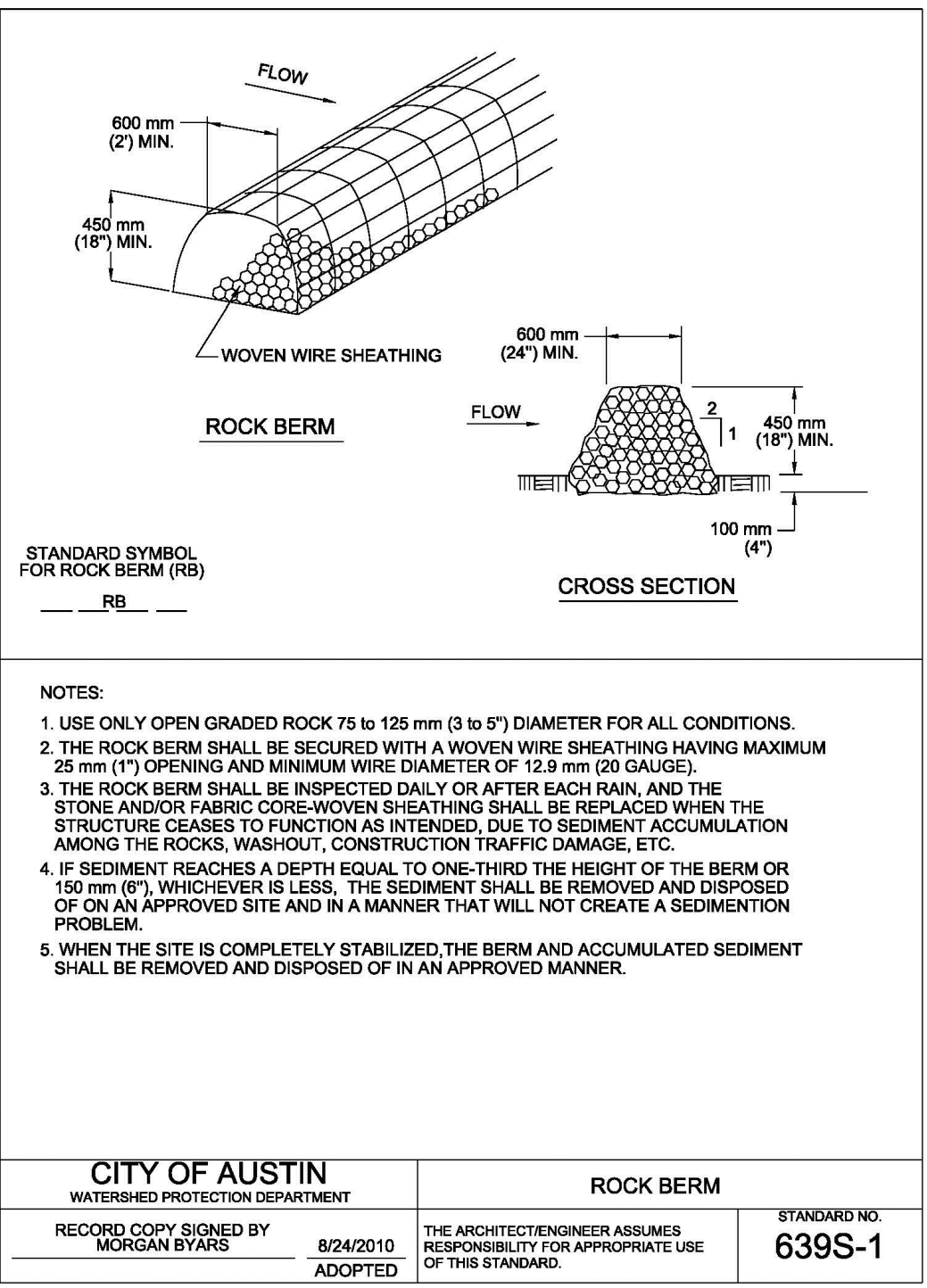
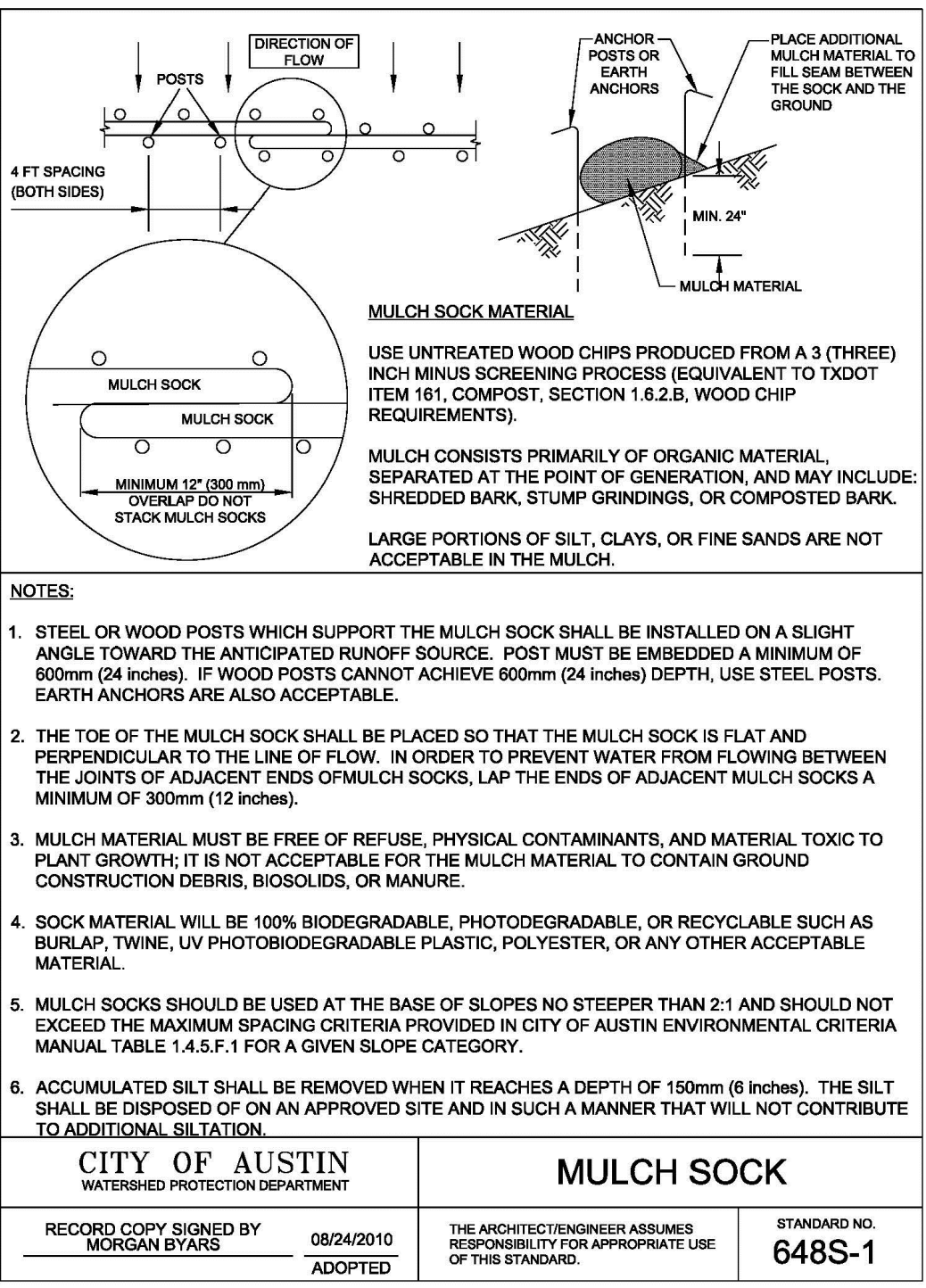
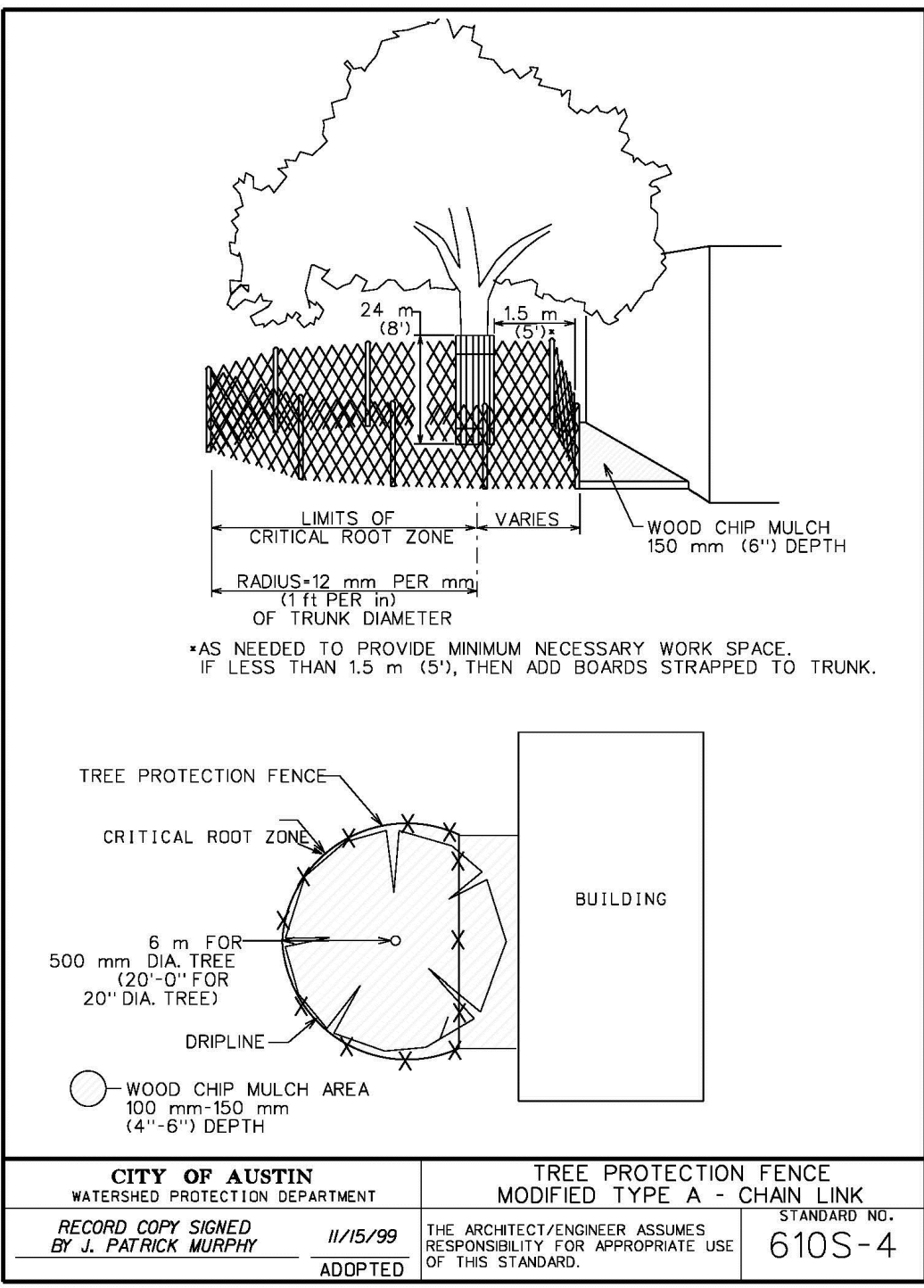
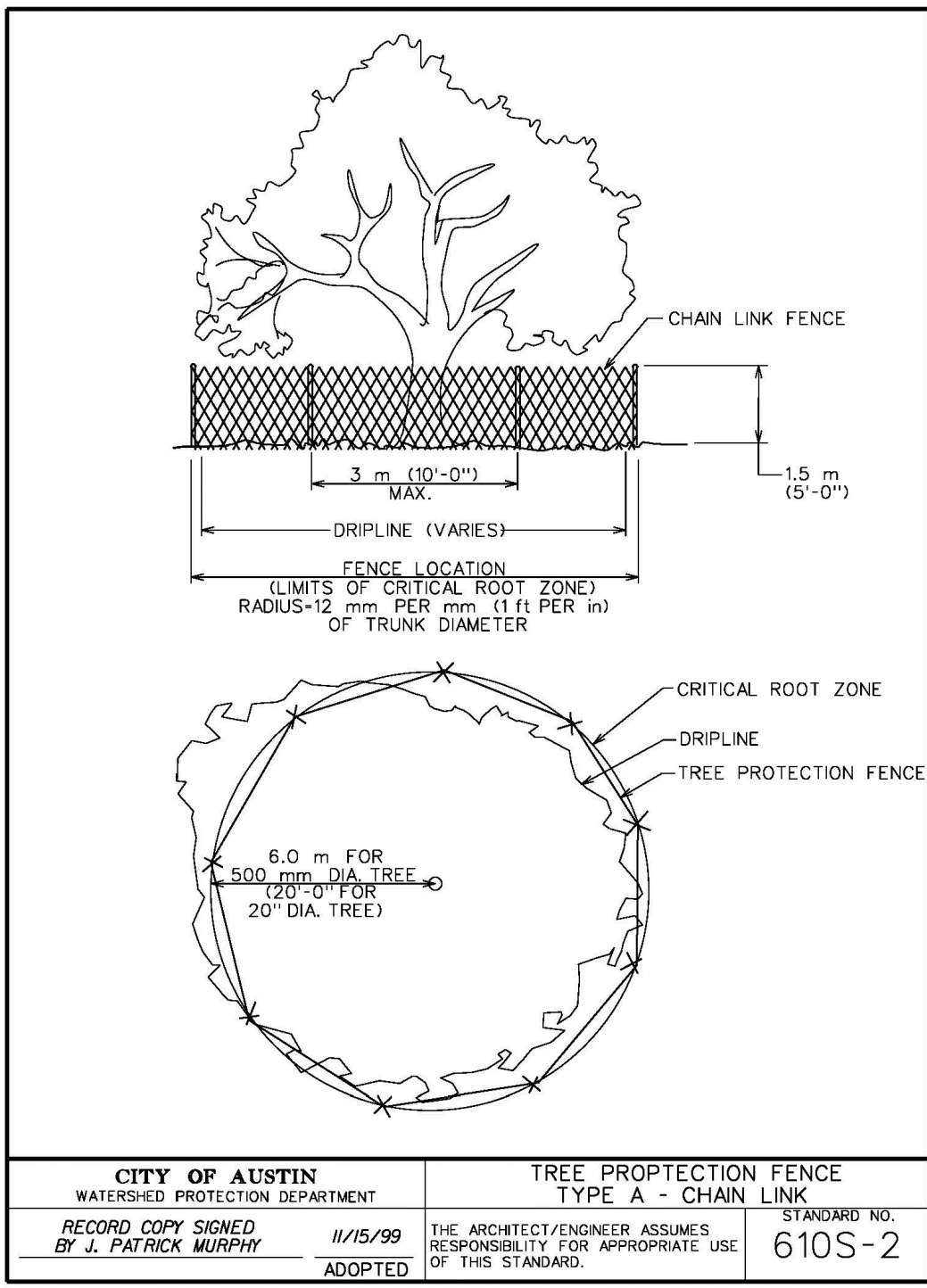
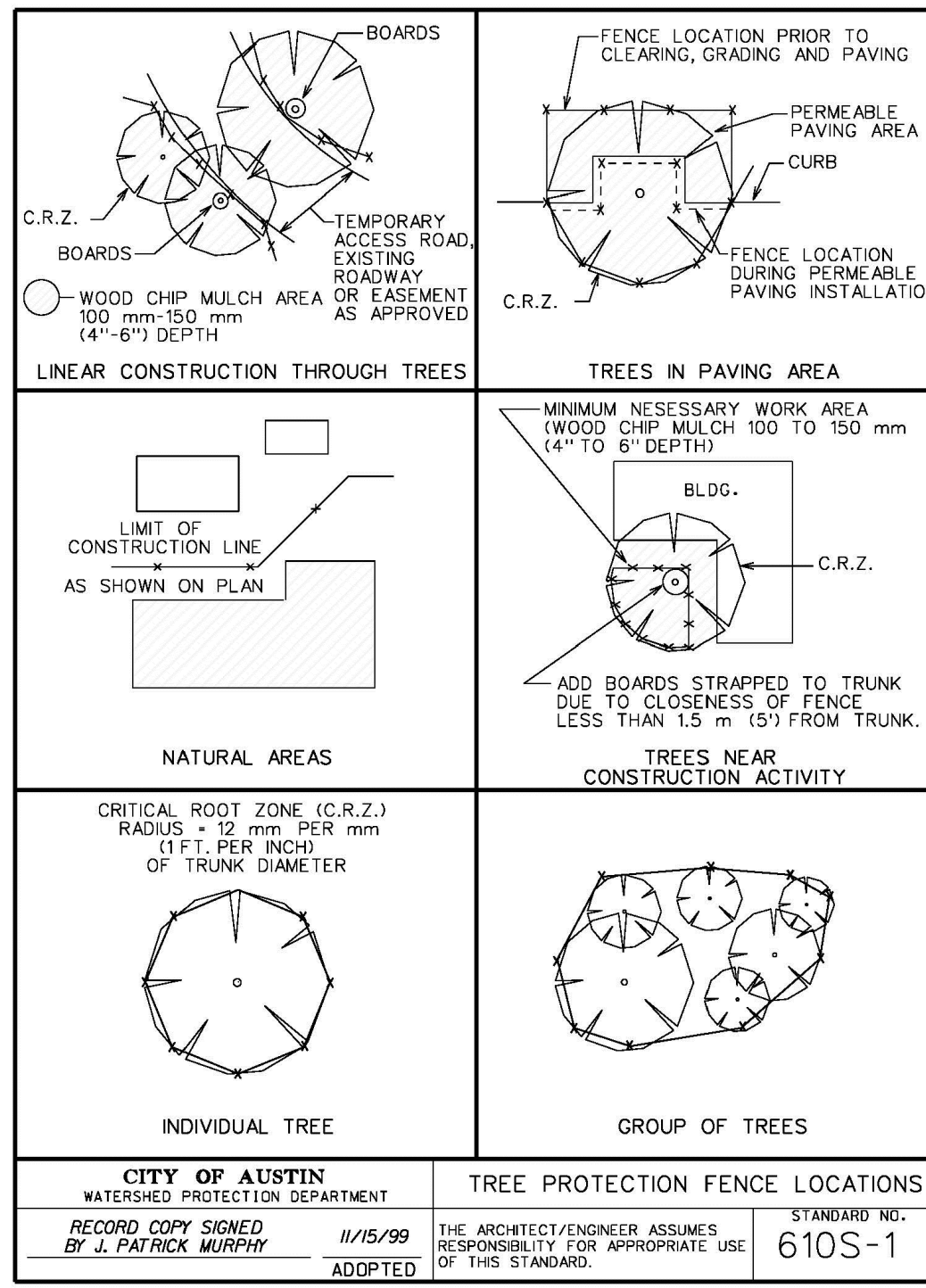

1. THE EXCAVATION FOR THE CONCRETE TRUCK WASHOUT SHALL BE A MINIMUM OF 10 FEET WIDE AND OF SUFFICIENT LENGTH AND DEPTH TO ACCOMMODATE 7 GALLONS OF WASHOUT WATER AND CONCRETE PER TRUCK PER DAY AND/OR 50 GALLONS OF WASHOUT WATER AND CONCRETE PER PUMP TRUCK PER DAY.
2. IN THE EVENT THAT THE CONCRETE TRUCK WASHOUT IS CONSTRUCTED ABOVE GROUND, IT SHALL BE 10 FEET WIDE AND 10 FEET LONG WITH THE SAME REQUIREMENTS FOR CONTAINMENT AS DESCRIBED IN ITEM 1.
3. THE CONTAINMENT AREA SHALL BE LINED WITH 10 MIL PLASTIC SHEETING WITHOUT HOLES OR TEARS, WHERE THERE ARE SEAMS, THESE SHALL BE SECURED ACCORDING TO MANUFACTURERS DIRECTIONS.
4. THE BERM CONSISTING OF GRAVEL BAGS, CONCRETE BLOCKS OR OPEN GRADED ROCK SHALL BE NO LESS THAN 18 INCHES HIGH AND NO LESS THAN 12 INCHES WIDE.
5. THE PLASTIC SHEETING SHALL BE OF SUFFICIENT SIZE SO THAT IT WILL OVERLAP THE TOP OF THE CONTAINMENT AREA AND BE WRAPPED AROUND THE GRAVEL BAGS, CONCRETE BLOCKS OR OPEN GRADED ROCK AT LEAST 2 TIMES.
6. THE GRAVEL BAGS OR CONCRETE BLOCKS SHALL BE PLACED ABUTTING EACH OTHER TO FORM A CONTINUOUS BERM AROUND THE OUTER PERIMETER OF THE CONTAINMENT AREA.
7. THE WASHOUT MATERIAL IN THE CONTAINMENT AREA SHALL NOT EXCEED 50% OF CAPACITY AT ANY ONE TIME.
8. SOLIDS SHALL BE REMOVED FROM CONTAINMENT AREA AND DISPOSED OF PROPERLY, ANY DAMAGE TO THE PLASTIC SHEETING SHALL BE REPAIRED OR SHEETING REPLACED BEFORE THE NEXT USE.

1 10' x 10' CONCRETE WASHOUT
281 SCALE: NTS



mwm Design Group

305 East Huntland Drive
Suite 200
Austin, Texas 78752
p: 512.453.0767
f: 512.453.1734

TBAE FIRM REGISTRATION NO.: 1452
TBE FIRM REGISTRATION NO.: F-1416
TBLPS FIRM REGISTRATION NO.: 10065600

NO.	DATE	DESCRIPTION	BY

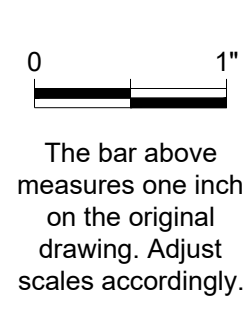

EROSION / SEDIMENTATION CONTROL & TREE PROTECTION DETAILS

Western Hills Athletic Club
4801 Rollingwood Drive
Austin, TX 78746

PLOTTED: 7/7/2020
JOB NO: 863-01

281

9 OF 26

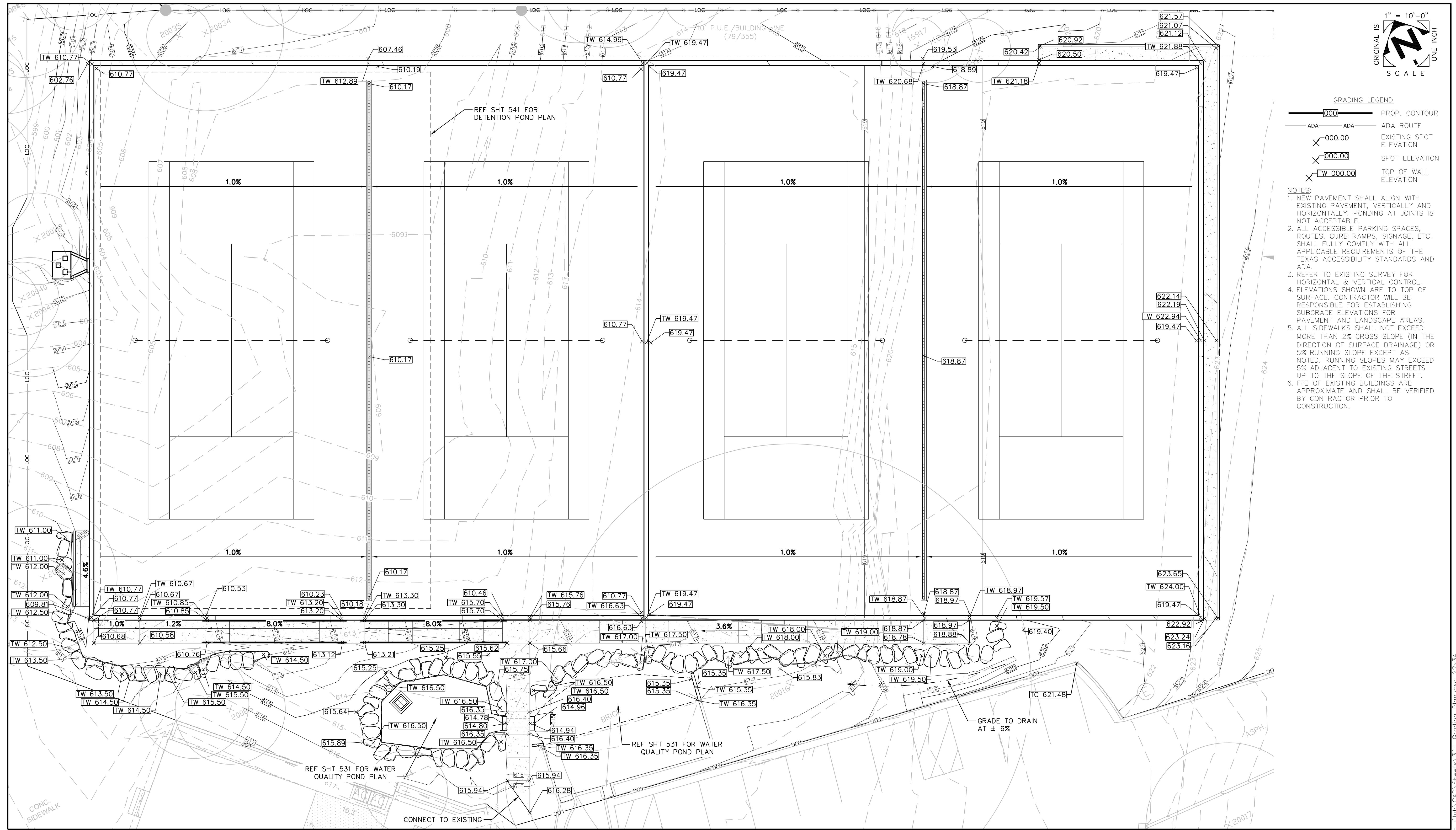

GRADING LEGEND

- PROP. CONTOUR
- ADA ROUTE
- EXISTING SPOT ELEVATION
- SPOT ELEVATION
- TOP OF WALL ELEVATION

- NOTES:**
1. NEW PAVEMENT SHALL ALIGN WITH EXISTING PAVEMENT, VERTICALLY AND HORIZONTALLY. PONDING AT JOINTS IS NOT ACCEPTABLE.
 2. ALL ACCESSIBLE PARKING SPACES, ROUTES, CURB RAMPS, SIGNAGE, ETC. SHALL FULLY COMPLY WITH ALL APPLICABLE REQUIREMENTS OF THE TEXAS ACCESSIBILITY STANDARDS AND ADA.
 3. REFER TO EXISTING SURVEY FOR HORIZONTAL & VERTICAL CONTROL.
 4. ELEVATIONS SHOWN ARE TO TOP OF SURFACE. CONTRACTOR WILL BE RESPONSIBLE FOR ESTABLISHING SUBGRADE ELEVATIONS FOR PAVEMENT AND LANDSCAPE AREAS.
 5. ALL SIDEWALKS SHALL NOT EXCEED MORE THAN 2% GROSS SLOPE (IN THE DIRECTION OF SURFACE DRAINAGE) OR 5% RUNNING SLOPE EXCEPT AS NOTED. RUNNING SLOPES MAY EXCEED 5% ADJACENT TO EXISTING STREETS UP TO THE SLOPE OF THE STREET.
 6. FFE OF EXISTING BUILDINGS ARE APPROXIMATE AND SHALL BE VERIFIED BY CONTRACTOR PRIOR TO CONSTRUCTION.

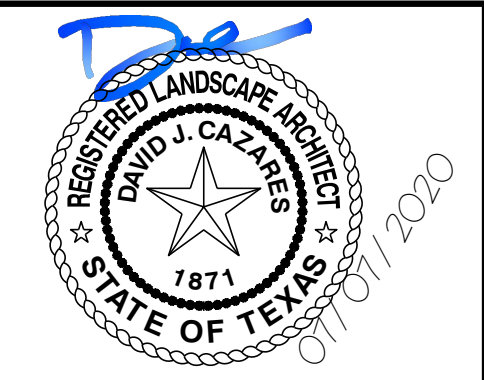

mwm Design Group

305 East Huntland Drive
Suite 200
Austin, Texas 78752
p: 512.453.0767
f: 512.453.1734

TBAE FIRM REGISTRATION NO.: 1452
TBEF FIRM REGISTRATION NO.: F-1416
TBPLS FIRM REGISTRATION NO.: 10065600

NO.	DATE	DESCRIPTION	BY

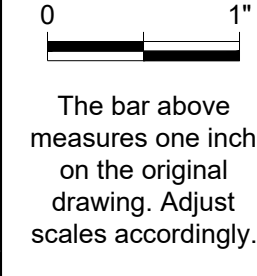

GRADING PLAN

Western Hills Athletic Club
4801 Rollingwood Drive
Austin, TX 78746

PLOTTED: 7/7/2020
JOB NO: 863-01

301

10 OF 26

File: Y:\863-01_WH_Athletic_Club\CAD\Sheets\301_Grading_Plan.dwg 22-34

ORIGINAL IS
 1" = 10'-0"
 SCALE
 ONE INCH

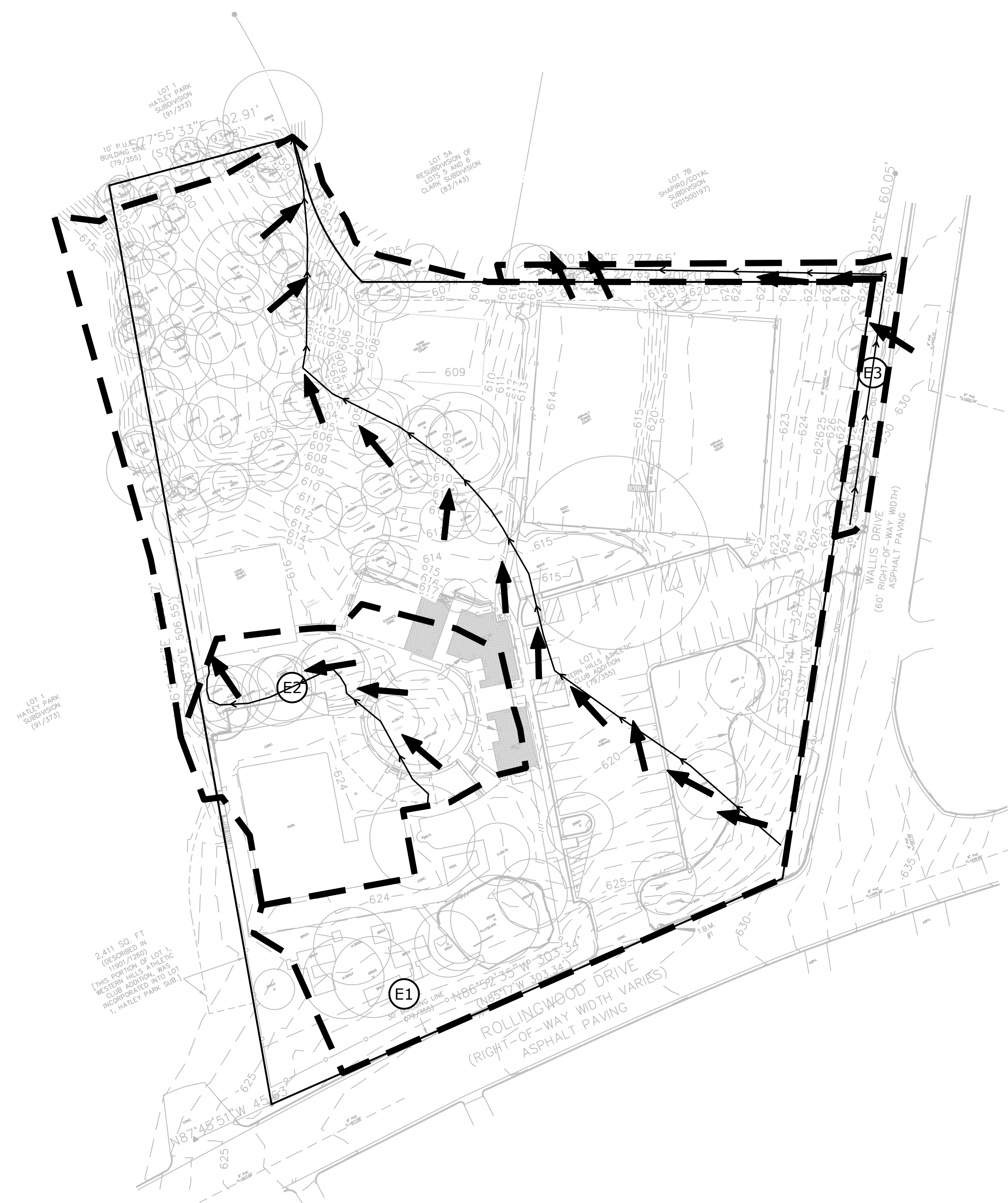
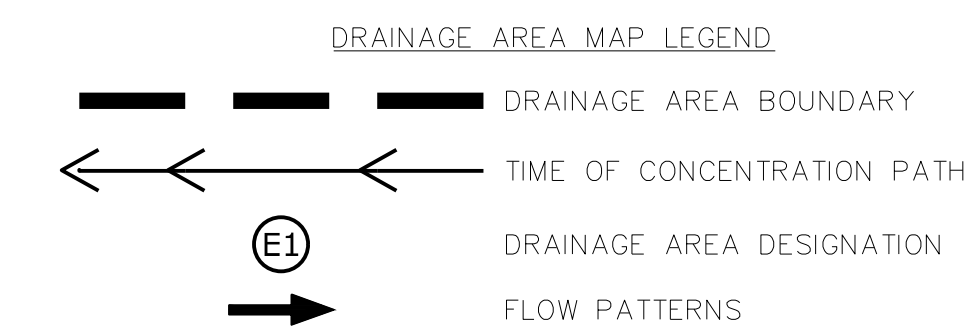

mwm
 Design Group

305 East Huntland Drive
 Suite 200
 Austin, Texas 78752
 p: 512.453.0767
 f: 512.453.1734

TBAE FIRM REGISTRATION NO.: 1452
 TBPE FIRM REGISTRATION NO.: F-14116
 TBPLS FIRM REGISTRATION NO.: 10065600

NO.	DATE	DESCRIPTION	BY

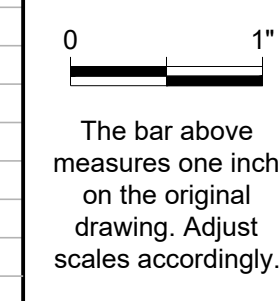

EXISTING DRAINAGE AREA MAP

Western Hills Athletic Club
 4801 Rollingwood Drive
 Austin, TX 78746

PLOTTED: 7/7/2020
 JOB NO: 863-01

501

11 OF 26

File: Y:\863-01_WHP_Athletic_CAD\Sheets\501_Existing DAM.dwg 22x34

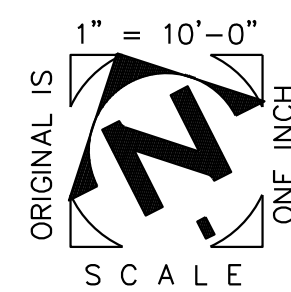

COVER TYPE	HYDROLOGIC CONDITION	CURVE NUMBERS FOR HYDROLOGIC SOIL GROUP				DRAINAGE AREA			COMPOSITE CURVE NUMBER		
		A	B	C	D	1	2	3	1	2	3
Fully developed urban areas (vegetation established)									0	0	0
Open space (lawns, parks, golf courses, cemeteries, etc.)									0	0	0
Poor condition (grass cover 50%)		68	79	86	89				0	0	0
Fair condition (grass cover 50% to 75%)		49	69	79	84				0	0	0
Good condition (grass cover 75%)		39	61	74	80	70853.43	11579.51	4361.65	5668274.4	926360.8	348932
Impervious areas:									0	0	0
Paved parking lots, roofs, driveways, etc. (excluding right of way)		98	98	98	98	44958.42	8107.42	0.00	4405925.16	794527.16	0
Streets and roads:									0	0	0
Paved; curbs and storm drains (excluding right of way)		98	98	98	98				0	0	0
Paved; open ditches (including right of way)		83	89	92	93				0	0	0
Gravel (including right of way)		76	85	89	91				0	0	0
Dirt (including right of way)		72	82	87	89				0	0	0
Developing urban area									0	0	0
Newly graded areas (pervious areas only, no vegetation)		77	86	91	94				0	0	0
Agricultural lands									0	0	0
Grassland, or range-continuous forage for grazing	Poor	68	79	86	89				0	0	0
	Fair	49	69	79	84				0	0	0
	Good	39	61	74	80				0	0	0
Meadow-continuous grass, protected from grazing and generally mowed for hay		30	58	71	78				0	0	0
Brush - brush-weed-grass mixture with brush the major element	Poor	48	67	77	83				0	0	0
	Fair	35	56	70	77				0	0	0
	Good	30	48	65	73				0	0	0
Woods - grass combination (orchard or tree farm)	Poor	57	73	82	86				0	0	0
	Fair	43	65	76	79				0	0	0
	Good	32	58	72	79				0	0	0
Woods - grass combination (orchard or tree farm)	Poor	45	66	77	83				0	0	0
	Fair	36	60	73	79				0	0	0
	Good	30	55	70	77				0	0	0
Farmstead - buildings, lanes, driveways and surrounding lots		59	74	82	86				0	0	0
						SF	115811.85	19686.93	4361.65	87	87
						AC	2.66	0.45	0.10		
						SM	0.004154171	0.00070617	0.000156452		
						% Imp	39%	41%	0%		

E1	
Start Station	0.00 ft
End Station	85.00 ft
Length (L)	85 ft
Manning's n	0.15
2-year 24-hour rain	3.44 inches
Start Elev	629.88 ft
End Elev	620.21 ft
Slope (S)	0.114 ft/ft
T _t	4 minutes
Sheet Flow	
Start Station	85.00 ft
End Station	505.00 ft
Length	420 ft
Start Elev	620.21 ft
End Elev	586.05 ft
Slope (S)	0.081 ft/ft
Surface	UnPaved
T _t	2 minutes
Shallow Concentrated Flow	
Cross Sectional Area (A)	0.25 sf
Wetted Perimeter (P)	2.00 ft
Hydraulic Radius (r)	0.125 ft
Start Elev	586.05 ft
End Elev	586.05 ft
Slope (S)	0.00 ft/ft
Manning's n	0.013
Velocity (V)	0.00 fps
Start Station	ft
End Station	ft
Length (L)	0.00 ft
T _t	0.00 minutes
Channel or Storm Drain Flow	
Time of Concentration	6 0.09534
Lag Time	3

E2	
Start Station	0.00 ft
End Station	100.00 ft
Length (L)	100 ft
Manning's n	0.15
2-year 24-hour rain	3.44 inches
Start Elev	623.981 ft
End Elev	618.12 ft
Slope (S)	0.059 ft/ft
T _t	6 minutes
Sheet Flow	
Start Station	100.00 ft
End Station	184.00 ft
Length	84 ft
Start Elev	618.12 ft
End Elev	616.38 ft
Slope (S)	0.021 ft/ft
Surface	Paved
T _t	0.5 minutes
Shallow Concentrated Flow	
Cross Sectional Area (A)	4.91 sf
Wetted Perimeter (P)	7.85 ft
Hydraulic Radius (r)	0.625 ft
Start Elev	616.382 ft
End Elev	586.362 ft
Slope (S)	0.00 ft/ft
Manning's n	0.013
Velocity (V)	0.00 fps
Start Station	ft
End Station	ft
Length (L)	ft
T _t	0.00 minutes
Channel or Storm Drain Flow	
Time of Concentration	6.5 0.108982
Lag Time	4

E3	
Start Station	0.00 ft
End Station	100.00 ft
Length (L)	100 ft
Manning's n	0.24
2-year 24-hour rain	3.44 inches
Start Elev	629.896 ft
End Elev	628.13 ft
Slope (S)	0.018 ft/ft
T _t	14 minutes
Sheet Flow	
Start Station	100.00 ft
End Station	322.65 ft
Length	223 ft
Start Elev	628.13 ft
End Elev	611.19 ft
Slope (S)	0.076 ft/ft
Surface	Unpaved
T _t	1 minutes
Shallow Concentrated Flow	
Cross Sectional Area (A)	4.91 sf
Wetted Perimeter (P)	7.85 ft
Hydraulic Radius (r)	0.625 ft
Start Elev	611.192 ft
End Elev	586.362 ft
Slope (S)	0.00 ft/ft
Manning's n	0.013
Velocity (V)	0.00 fps
Start Station	ft
End Station	ft
Length (L)	ft
T _t	0.00 minutes
Channel or Storm Drain Flow	
Time of Concentration	15 0.254832
Lag Time	9



305 East Huntland Drive
Suite 200
Austin, Texas 78752
p: 512.453.0767
f: 512.453.1734
TBAE FIRM REGISTRATION NO.: 1452
TBE FIRM REGISTRATION NO.: F-1416
TBLPS FIRM REGISTRATION NO.: 10065600

NO.	DATE	DESCRIPTION	BY

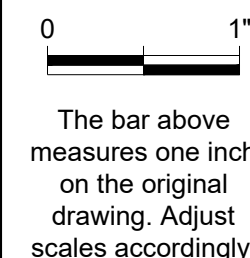

EXISTING DRAINAGE AREA CALCULATIONS

Western Hills Athletic Club
4801 Rollingwood Drive
Austin, TX 78746

PLOTTED: 7/7/2020
JOB NO: 863-01

502

12 OF 26

1" = 10'-0"
 ORIGINAL IS
 SCALE
 ONE INCH

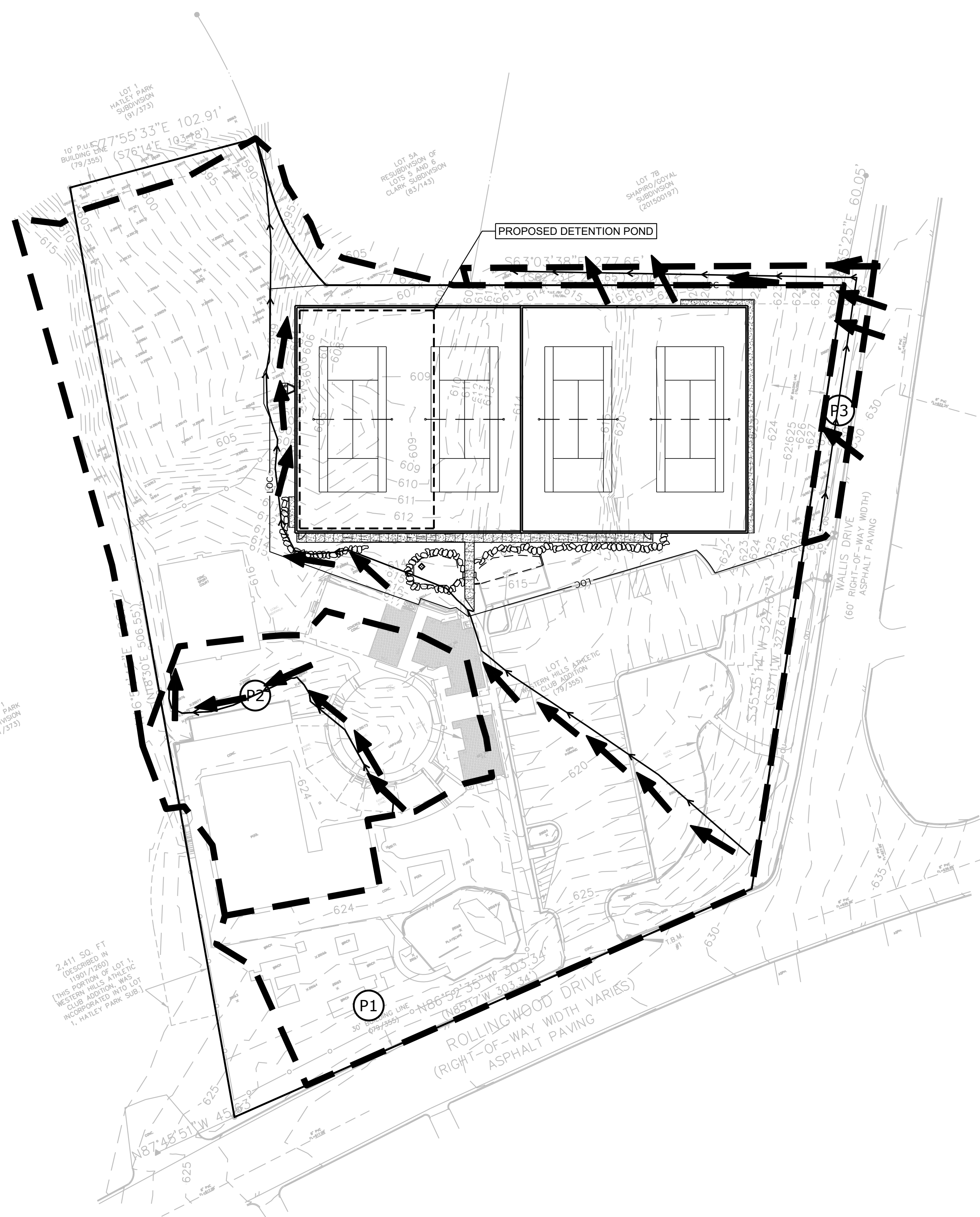
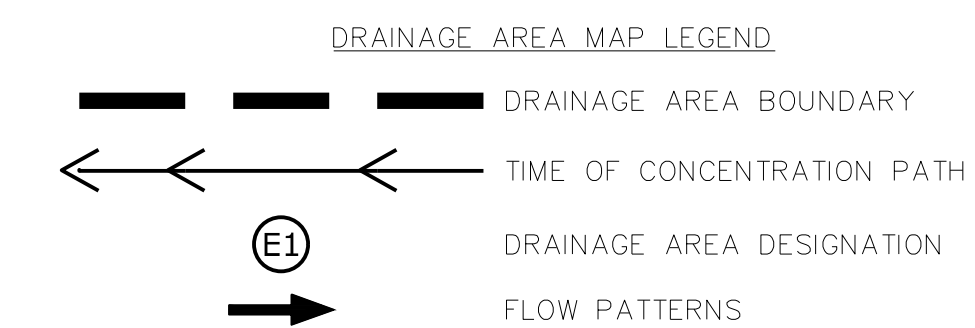

mwm
 Design Group

305 East Huntland Drive
 Suite 200
 Austin, Texas 78752
 p: 512.453.0767
 f: 512.453.1734

TBAE FIRM REGISTRATION NO.: 1452
 TBPE FIRM REGISTRATION NO.: F-14116
 TBPLS FIRM REGISTRATION NO.: 10065600

NO.	DATE	DESCRIPTION	BY

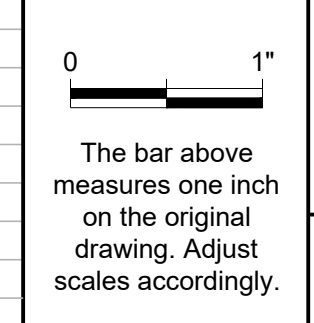

PROPOSED DRAINAGE AREA MAP

Western Hills Athletic Club
 4801 Rollingwood Drive
 Austin, TX 78746

PLOTTED: 7/7/2020
 JOB NO: 863-01

503

13 OF 26

File: Y:\863-01_WHA_Athletic_Club\CAD\Sheets\503_Proposed DAM.dwg 22x34

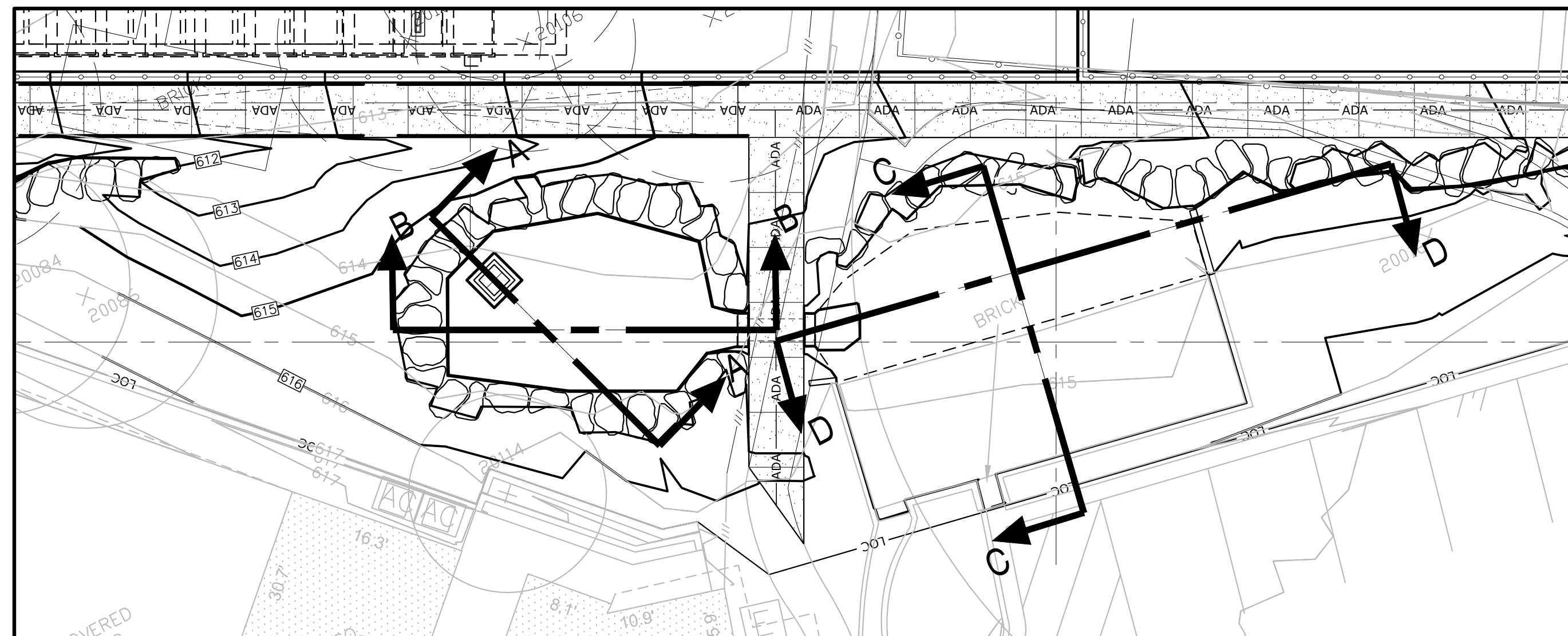

STAGE STORAGE TABLE

Elevation Area	Depth	Volume
615	341.3957	0
615.64		462.5
616	1109.3625	1 725.3791

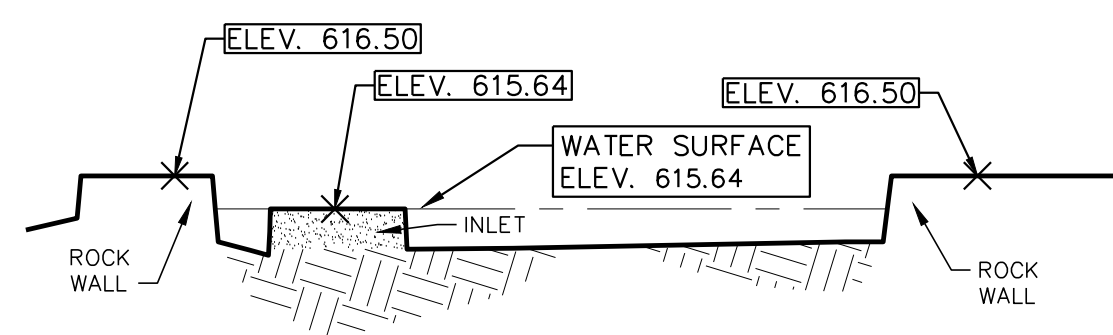

A POND - SECTION A
SCALE: 1" = 5'

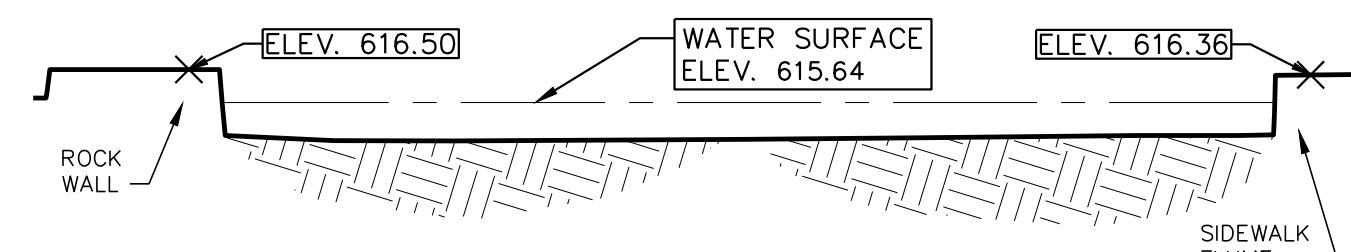

B POND - SECTION B
SCALE: 1" = 5'

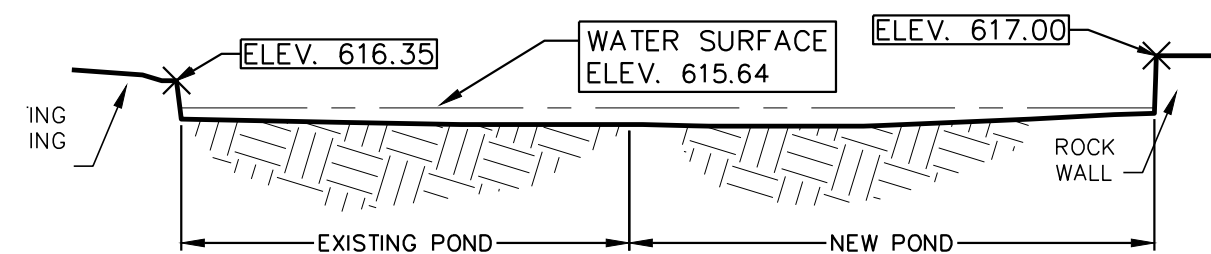

C POND - SECTION C
SCALE: 1" = 5'

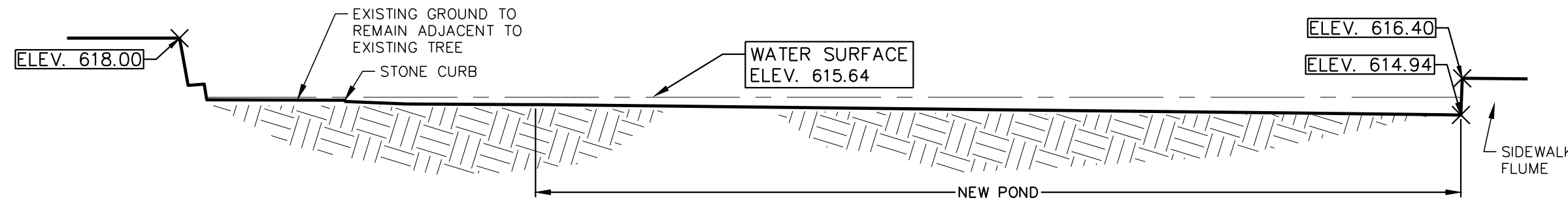

D POND - SECTION D
SCALE: 1" = 5'

Texas Commission on Environmental Quality

TSS Removal Calculations 04-20-2009

Project Name: **WESTERN HILLS ATHLETIC CENTER**
Date Prepared: **2/24/2020**

Additional information is provided for cells with a red triangle in the upper right corner. Place the cursor over the cell. Text shown in blue indicate location of instructions in the Technical Guidance Manual - RG-348. Characters shown in red are data entry fields. Characters shown in black (Bold) are calculated fields. Changes to these fields will remove the equations used in the spreadsheet.

1. The Required Load Reduction for the total project: Calculations from RG-348 Pages 3-27 to 3-30

Page 3-29 Equation 3.3: $L_d = 27.2(A_p \times P)$

where: L_d TOTAL PROJECT = Required TSS removal resulting from the proposed development = 80% of increased load
 A_p = Net increase in impervious area for the project
 P = Average annual precipitation, inches

Site Data: Determine Required Load Removal Based on the Entire Project

County =	Travis
Total project area included in plan =	3.21 acres
Predevelopment impervious area within the limits of the plan =	1.22 acres
Total post-development impervious area within the limits of the plan =	1.57 acres
Total post-development impervious cover fraction =	0.49
P =	32 inches

L_d TOTAL PROJECT = 305 lbs.

* The values entered in these fields should be for the total project area.

Number of drainage basins / outfalls areas leaving the plan area = 1

2. Drainage Basin Parameters (This information should be provided for each basin):

Drainage Basin/Outfall Area No. =	1
Total drainage basin/outfall area =	2.66 acres
Predevelopment impervious area within drainage basin/outfall area =	1.03 acres
Post-development impervious area within drainage basin/outfall area =	1.38 acres
Post-development impervious fraction within drainage basin/outfall area =	0.82
L_d THIS BASIN =	305 lbs.

3. Indicate the proposed BMP Code for this basin.

Proposed BMP = Bioretention
Removal efficiency = 89 percent

4. Calculate Maximum TSS Load Removed (L_d) for this Drainage Basin by the selected BMP Type.

RG-348 Page 3-33 Equation 3.7: $L_d = (BMP \text{ efficiency}) \times P \times (A_i \times 34.6 + A_p \times 0.54)$

where: A_i = Total On-Site drainage area in the BMP catchment area
 A_p = Impervious area proposed in the BMP catchment area
 A_p = Pervious area remaining in the BMP catchment area
 L_d = TSS Load removed from this catchment area by the proposed BMP

A_i =	1.03 acres
A_p =	0.60 acres
A_p =	0.43 acres
L_d =	598 lbs.

5. Calculate Fraction of Annual Runoff to Treat the drainage basin / outfall area

Desired L_d THIS BASIN = 139 lbs.
 F = 0.23

6. Calculate Capture Volume required by the BMP Type for this drainage basin / outfall area. Calculations from RG-348 Pages 3-34 to 3-36

Rainfall Depth =	0.14 inches
Post Development Runoff Coefficient =	0.41
On-site Water Quality Volume =	207 cubic feet

Calculations from RG-348 Pages 3-36 to 3-37

Off-site area draining to BMP =	0.00 acres
Off-site impervious cover draining to BMP =	0.00 acres
Impervious fraction of off-site area =	0
Off-site Runoff Coefficient =	0.00
Off-site Water Quality Volume =	0 cubic feet

Storage for Sediment = 41
Total Capture Volume (required water quality volume(s) x 1.20) = 248 cubic feet

The following sections are used to calculate the required water quality volume(s) for the selected BMP. The values for BMP Types not selected in cell C45 will show NA.

10. Bioretention System Designed as Required in RG-348 Pages 3-63 to 3-65

Required Water Quality Volume for Bioretention Basin = 248 cubic feet

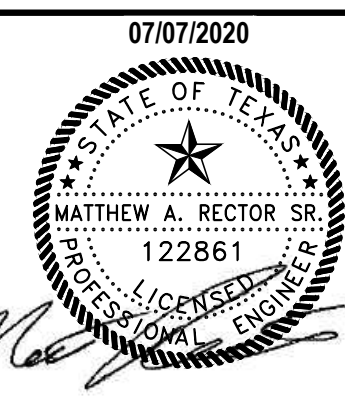

305 East Huntland Drive
Suite 200
Austin, Texas 78752
p: 512.453.0767
f: 512.453.1734
TBAE FIRM REGISTRATION NO.: 1452
TBEF FIRM REGISTRATION NO.: F-14316
TBPLS FIRM REGISTRATION NO.: 10065600

NO.	DATE	DESCRIPTION	BY

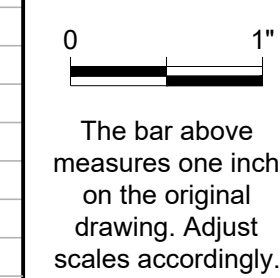

WATER QUALITY POND PLAN

Western Hills Athletic Club
4801 Rollingwood Drive
Austin, TX 78746

PLOTTED: 7/7/2020
JOB NO: 863-01

531

15 OF 26

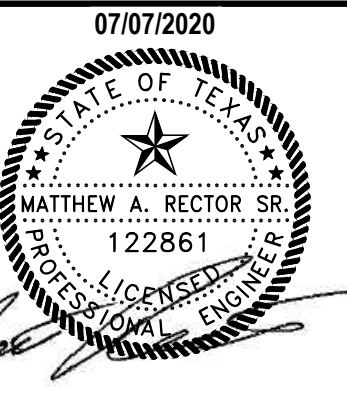
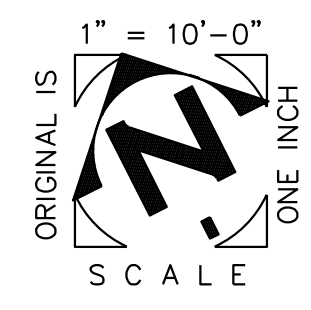
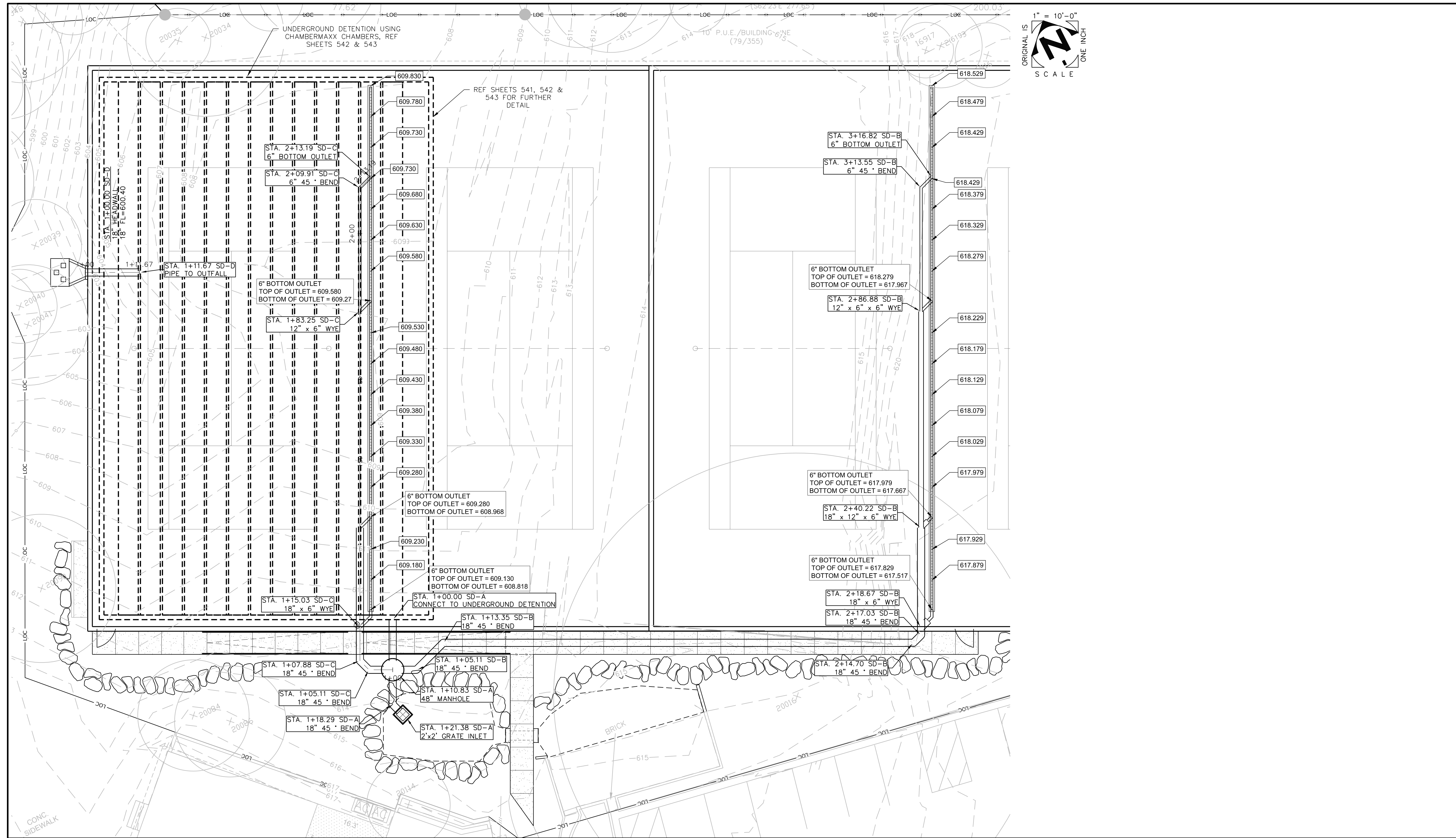

mwm
Design Group

305 East Huntland Drive
Suite 200
Austin, Texas 78752
p: 512.453.0767
f: 512.453.1734

TBAE FIRM REGISTRATION NO.: 1452
TBE FIRM REGISTRATION NO.: F-1416
TBPLS FIRM REGISTRATION NO.: 10065600

NO.	DATE	DESCRIPTION	BY

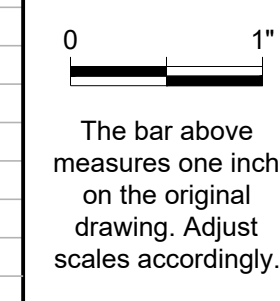

DETENTION POND PLAN

Western Hills Athletic Club
4801 Rollingwood Drive
Austin, TX 78746

PLOTTED: 7/7/2020
JOB NO: 863-01

541

16 OF 26

File: Y:\B63-01_WH_Athletic_Club\CAD\Sheets\541 Detention Pond Plan.dwg 22x34

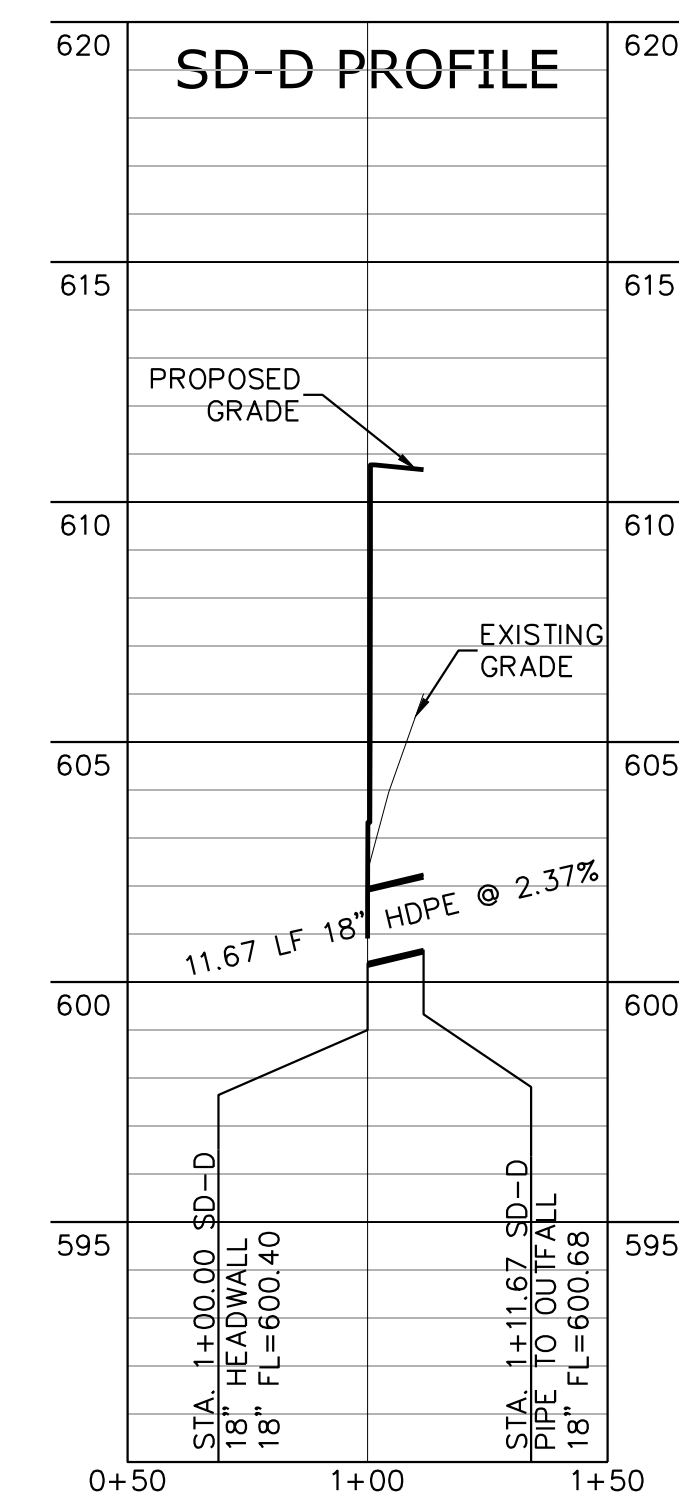
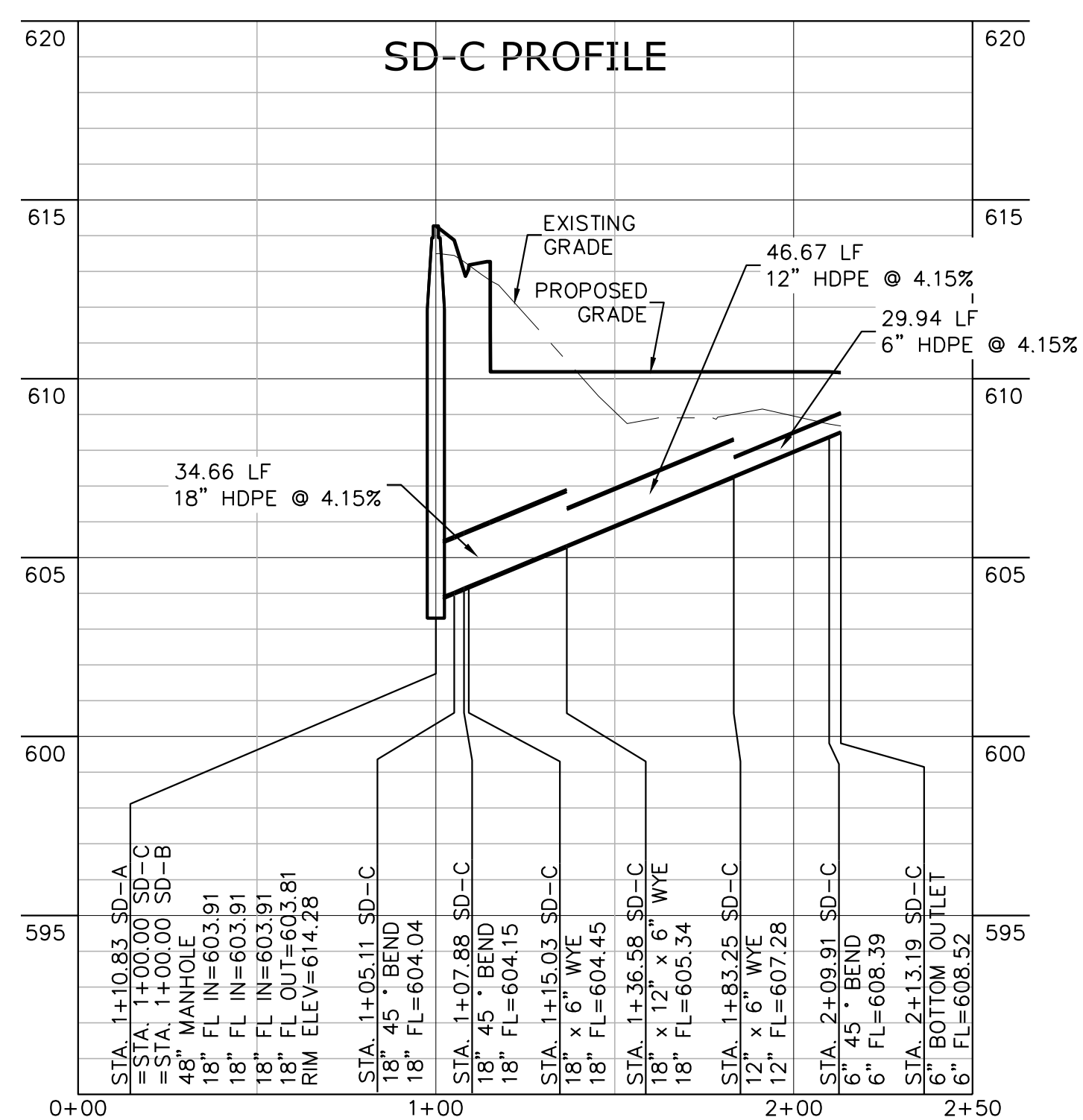
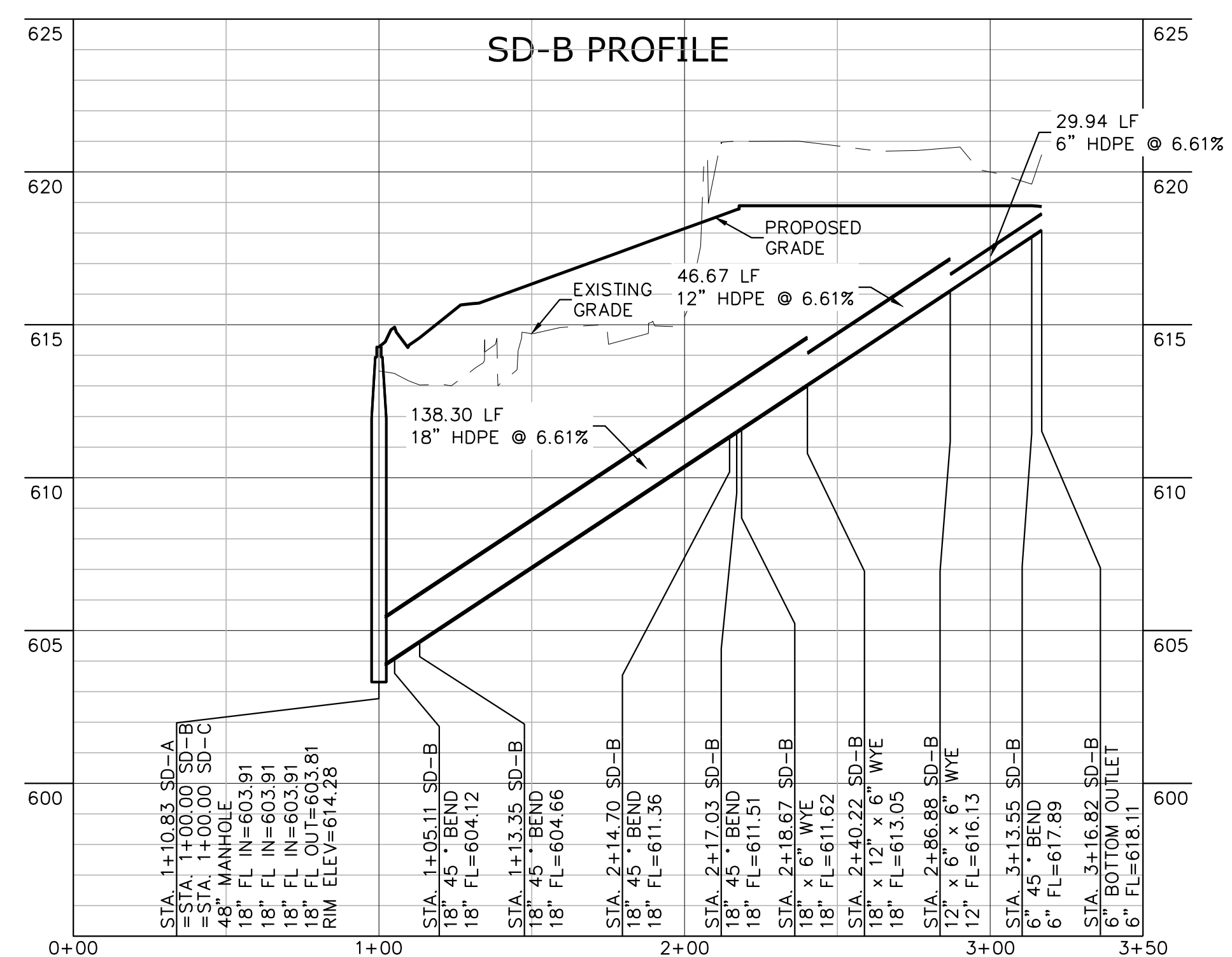
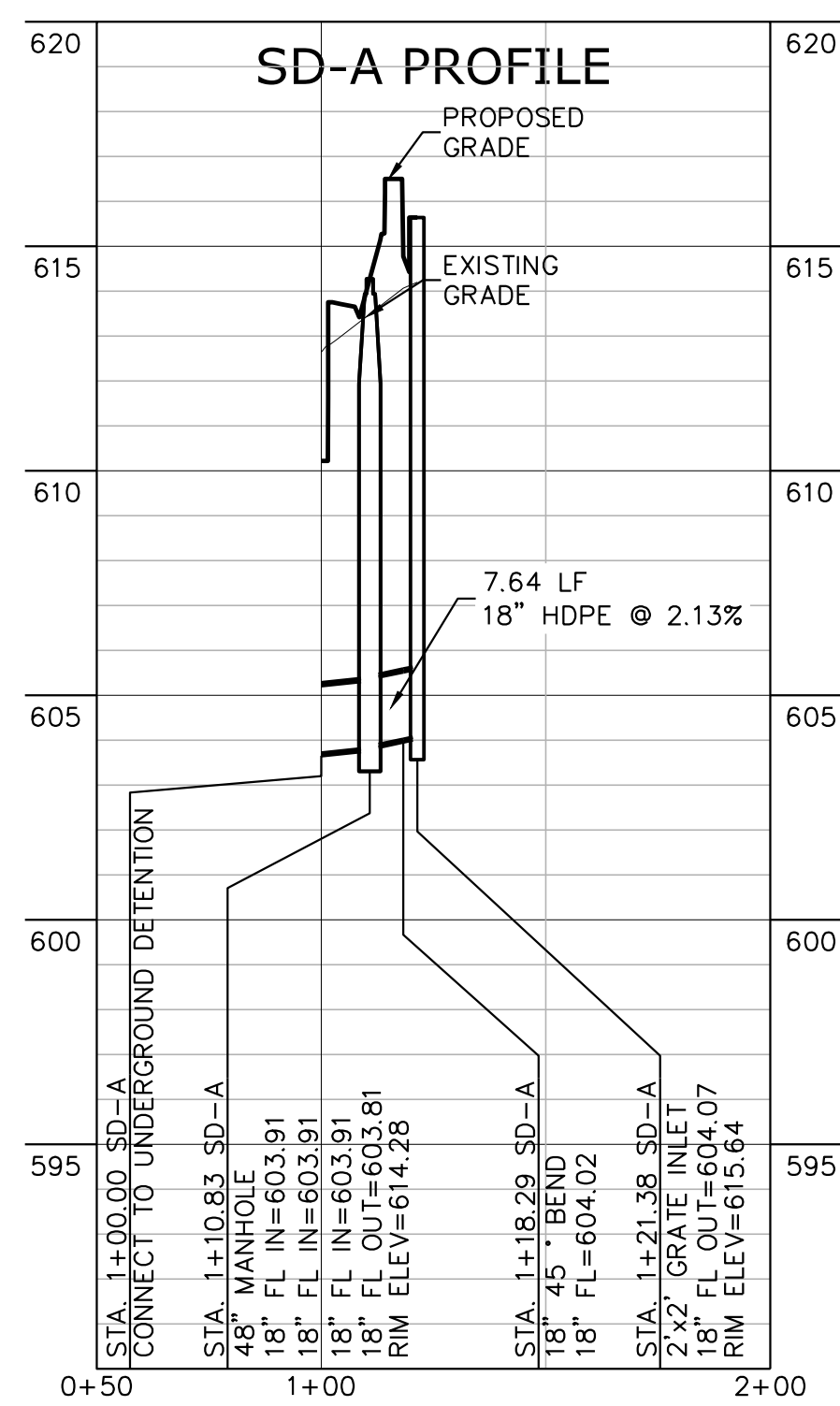

mwm Design Group
 305 East Huntland Drive
 Suite 200
 Austin, Texas 78752
 p: 512.453.0767
 f: 512.453.1734
 TBAE FIRM REGISTRATION NO.: 1452
 TSPF FIRM REGISTRATION NO.: F-1416
 TBPLS FIRM REGISTRATION NO.: 10065600

NO.	DATE	DESCRIPTION	BY

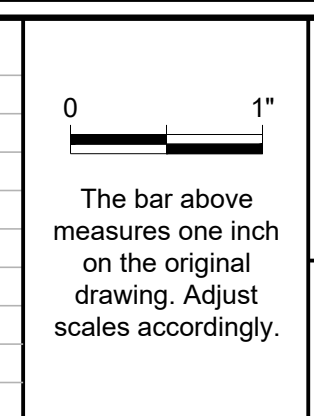

DETENTION POND PLAN

Western Hills Athletic Club
 4801 Rollingwood Drive
 Austin, TX 78746

PLOTTED: 7/7/2020
 JOB NO: 863-01

542

17 OF 26

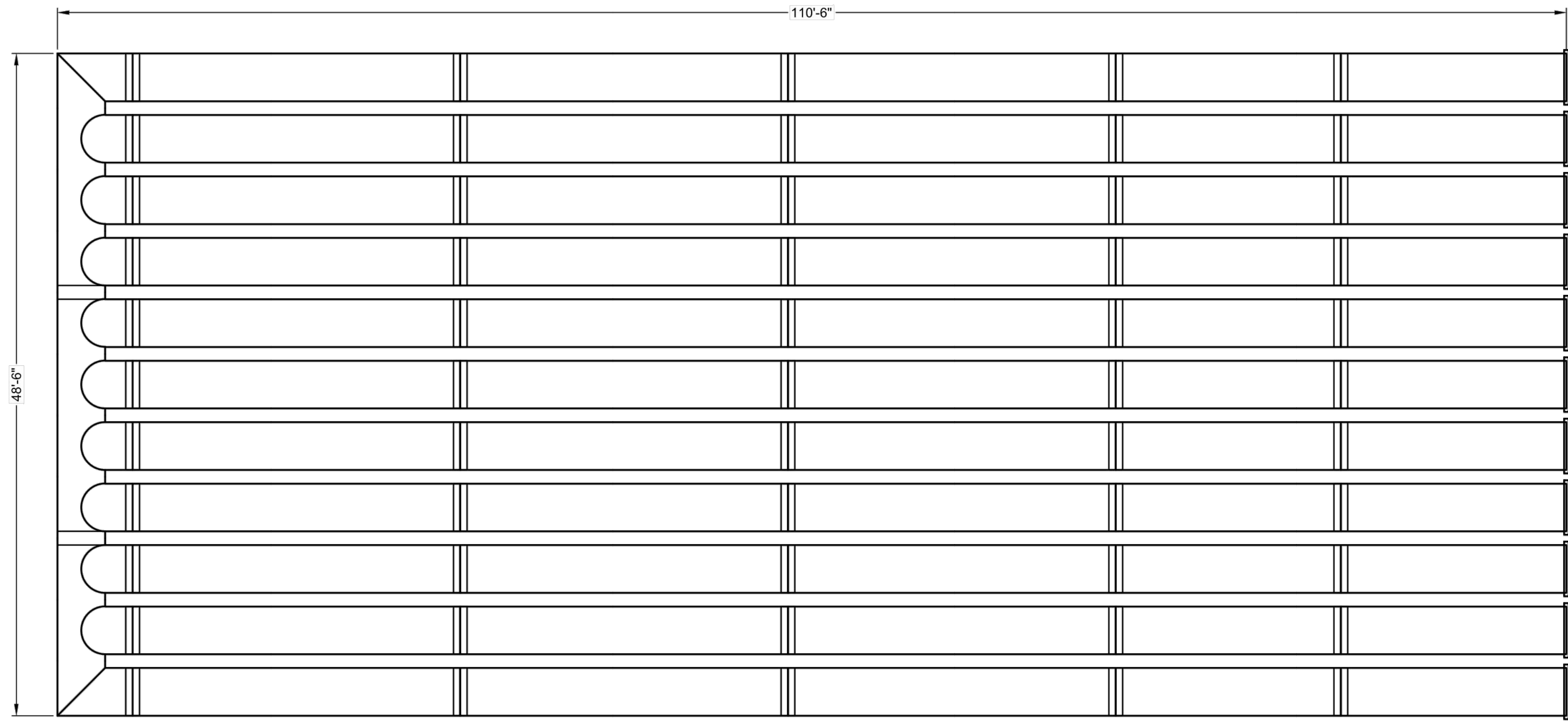

ASSEMBLY
SCALE: 1" = 10'

PROJECT SUMMARY			
CALCULATION DETAILS	STORAGE SUMMARY	PIPE DETAILS	BACKFILL DETAILS
<ul style="list-style-type: none"> LENGTH PER BARREL = 107 FT LENGTH PER HEADER = 48.50 FT LOADING = H20 & H25 APPROX. CMP FOOTAGE = 1,226 FT 	<ul style="list-style-type: none"> STORAGE VOLUME REQUIRED 15,000 CF PIPE STORAGE = 11,790 CF STRUCTURAL BACKFILL STORAGE = 3,280 CF TOTAL STORAGE PROVIDED = 15,070 CF 	<ul style="list-style-type: none"> DIAMETER = 42 IN CORRUGATION = 2-2/3" X 1/2" GAGE = 16 COATING = ALUMINIZED STEEL TYPE 2 (ALT2) WALL TYPE = PERFORATED BARREL SPACING = 12 IN 	<ul style="list-style-type: none"> WIDTH AT ENDS = 12 IN ABOVE PIPE = 6 IN WIDTH AT SIDES = 12 IN BELOW PIPE = 0 IN

- NOTES**
- ALL RISER AND STUB DIMENSIONS ARE TO CENTERLINE. ALL ELEVATIONS, DIMENSIONS, AND LOCATIONS OF RISERS AND INLETS, SHALL BE VERIFIED BY THE ENGINEER OF RECORD PRIOR TO RELEASING FOR FABRICATION.
 - ALL FITTINGS AND REINFORCEMENT COMPLY WITH ASTM A998.
 - ALL RISERS AND STUBS ARE 2 1/2" x 1/2" CORRUGATION AND 16 GAGE UNLESS OTHERWISE NOTED.
 - RISERS TO BE FIELD TRIMMED TO GRADE.
 - QUANTITY OF PIPE SHOWN DOES NOT PROVIDE EXTRA PIPE FOR CONNECTING THE SYSTEM TO EXISTING PIPE OR DRAINAGE STRUCTURES. OUR SYSTEM AS DETAILED PROVIDES NOMINAL INLET AND/OR OUTLET PIPE STUB FOR CONNECTION TO EXISTING DRAINAGE FACILITIES. IF ADDITIONAL PIPE IS NEEDED IT IS THE RESPONSIBILITY OF THE CONTRACTOR.
 - BAND TYPE TO BE DETERMINED UPON FINAL DESIGN.
 - THE PROJECT SUMMARY IS REFLECTIVE OF THE DYODS DESIGN. QUANTITIES ARE APPROX. AND SHOULD BE VERIFIED UPON FINAL DESIGN AND APPROVAL. FOR EXAMPLE, TOTAL EXCAVATION DOES NOT CONSIDER ALL VARIABLES SUCH AS SHORING AND ONLY ACCOUNTS FOR MATERIAL WITHIN THE ESTIMATED EXCAVATION FOOTPRINT.

NOTE:
THESE DRAWINGS ARE FOR CONCEPTUAL PURPOSES AND DO NOT REFLECT ANY LOCAL PREFERENCES OR REGULATIONS. PLEASE CONTACT YOUR LOCAL CONTECH REP FOR MODIFICATIONS.

The design and information shown on this drawing is provided as a service to the project owner, engineer and contractor by Contech Engineered Solutions LLC ("Contech"). Neither this drawing, nor any part thereof, may be used, reproduced or modified in any manner without the prior written consent of Contech. Failure to comply is done at the user's own risk and Contech expressly disclaims any liability or responsibility for such use.

If discrepancies between the supplied information upon which the drawing is based and actual field conditions are encountered as site work progresses, these discrepancies must be reported to Contech immediately for re-evaluation of the design. Contech accepts no liability for designs based on missing, incomplete or inaccurate information supplied by others.

MARK	DATE	REVISION DESCRIPTION	BY

CONTECH
ENGINEERED SOLUTIONS LLC
www.ContechES.com
9025 Centre Pointe Dr., Suite 400, West Chester, OH 45069
800-338-1122 513-645-7000 513-645-7993 FAX

CONTECH
CMP DETENTION SYSTEMS
CONTECH
DYODS
DRAWING

DYODS - 14673-1-0
PROJECT NAME: Western Hills Athletic Club
Austin, TX
DESCRIPTION: UDS

PROJECT No.: 14673-1	SEQ. No.: 0	DATE: 4/7/2020
DESIGNED: DYODS	DRAWN: DYODS	
CHECKED:	APPROVED:	
SHEET No.: D1		



mwm
Design Group
305 East Huntland Drive
Suite 200
Austin, Texas 78752
p: 512.453.0767
f: 512.453.1734
TBAE FIRM REGISTRATION NO.: 1452
TBRF FIRM REGISTRATION NO.: F-1416
TBPLS FIRM REGISTRATION NO.: 10065600

NO.	DATE	DESCRIPTION	BY

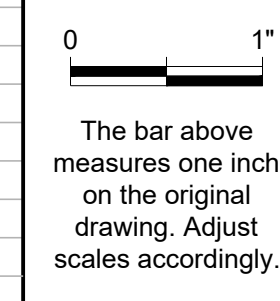

DETENTION POND DETAILS

Western Hills Athletic Club
4801 Rollingwood Drive
Austin, TX 78746

PLOTTED: 7/7/2020
JOB NO: 863-01
543
18 OF 26

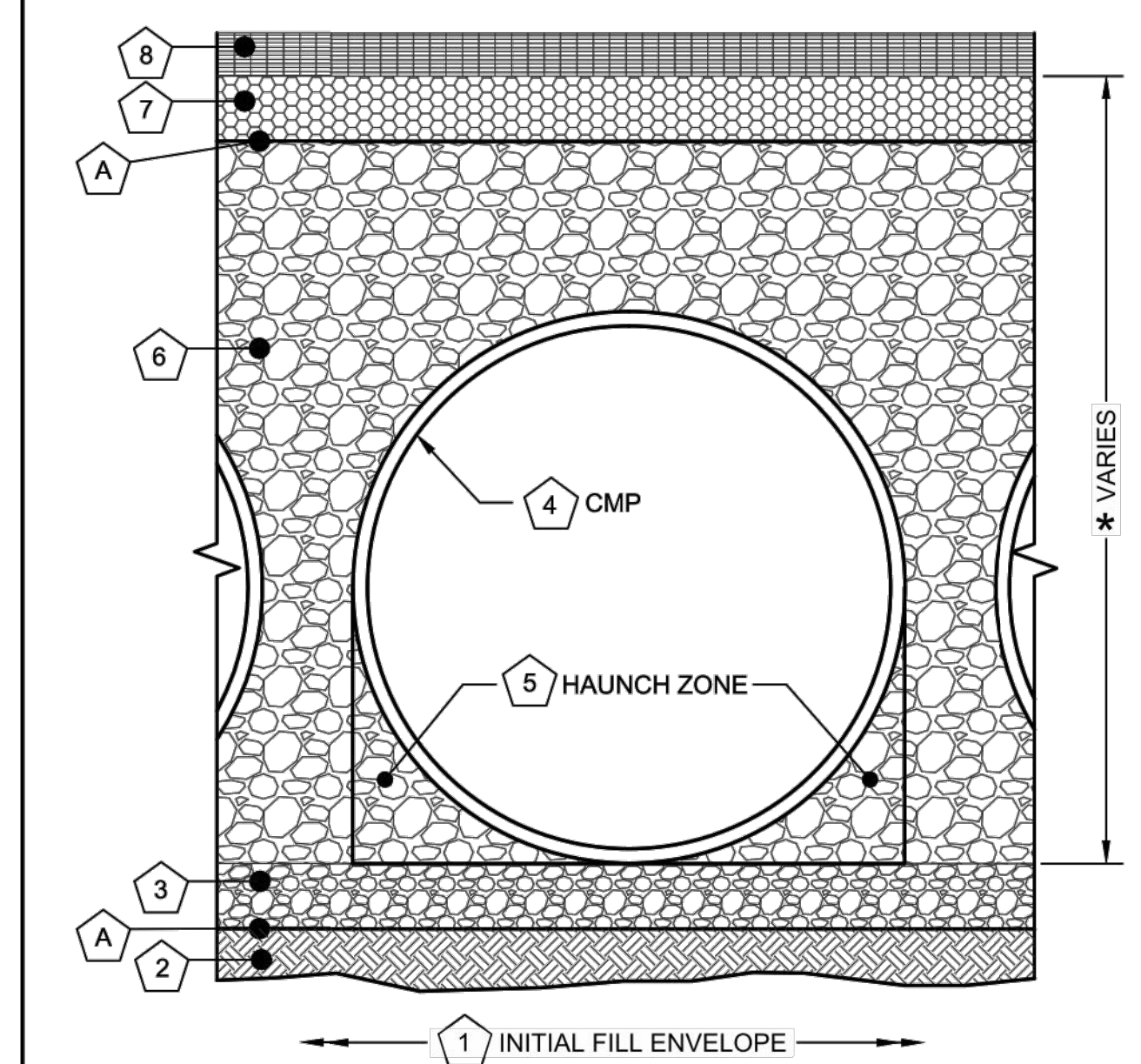

Infiltration Systems - CMP Infiltration & CMP Perforated Drainage Pipe			
Material Location	Description	Material Designation	Designation
8	Rigid or Flexible Pavement (if applicable)		
7	Road Base (if applicable)		
6	Geotextile Layer	Non-Woven Geotextile CONTECH C-40 or C-45	Engineer Decision for consideration to prevent soil migration into varying soil types. Wrap the trench only.
5	Backfill	Infiltration pipe systems have a pipe perforation sized of 3/8" diameter. An open graded, free draining stone, with a particle size of 1/2" - 2 1/2" diameter is recommended.	AASHTO M 145-A-1 or AASHTO M 43 - 3, 4
4	Bedding Stone	Well graded granular bedding material w/maximum particle size of 3"	AASHTO M 43 - 3, 357, 4, 467, 5, 56, 57
3	Geotextile Layer	None	None

* Note: The listed AASHTO designations are for gradation only. The stone must also be angular and clean.

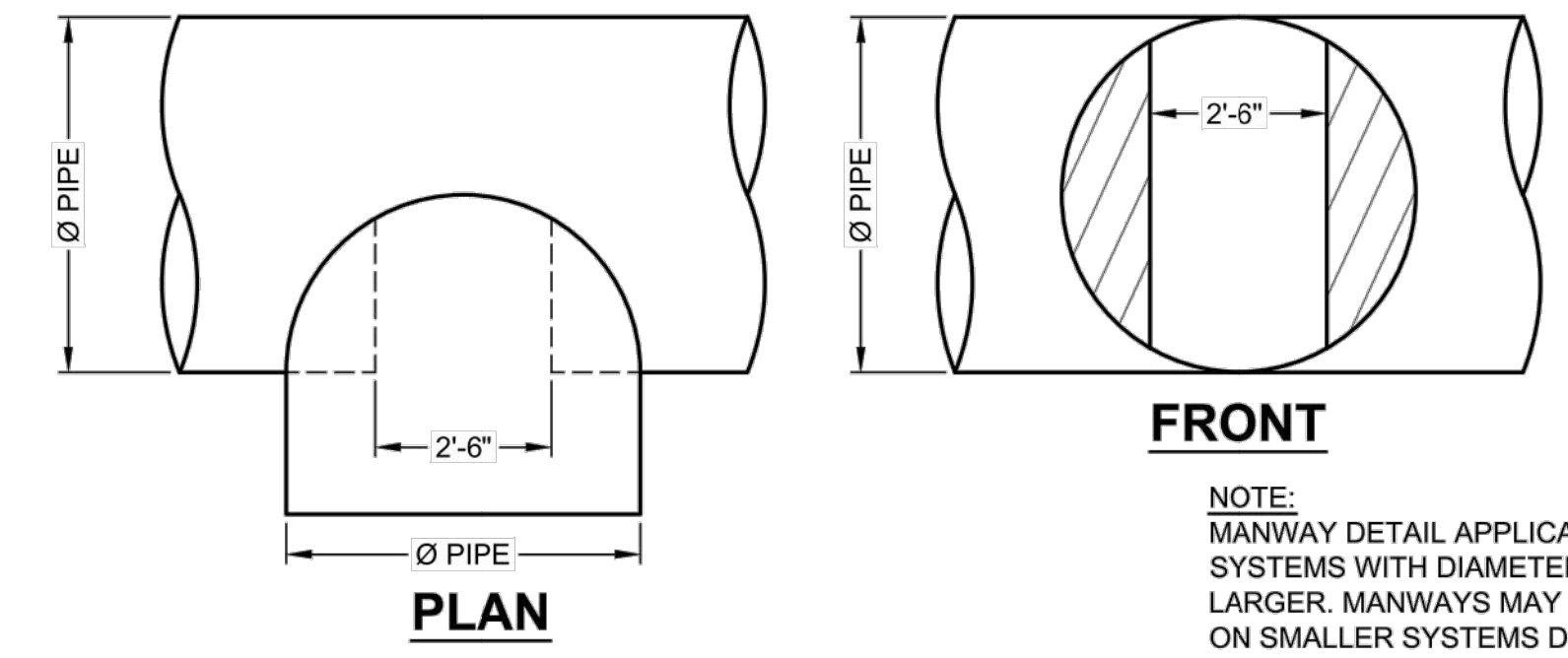

TYPICAL MANWAY DETAIL
SCALE: N.T.S.

NOTE: MANWAY DETAIL APPLICABLE FOR CMP SYSTEMS WITH DIAMETERS 48" AND LARGER. MANWAYS MAY BE REQUIRED ON SMALLER SYSTEMS DEPENDING ON ACTUAL SITE SPECIFIC CONDITIONS.

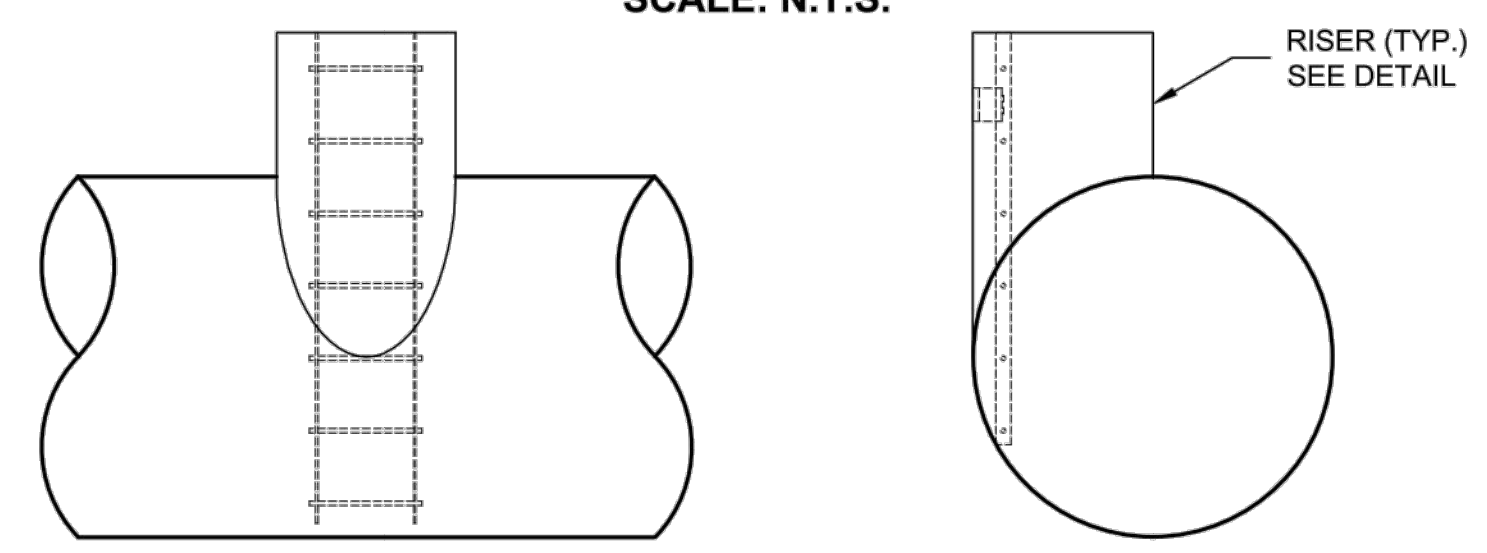

TYPICAL RISER DETAIL
SCALE: N.T.S.

NOTE: LADDERS ARE OPTIONAL AND ARE NOT REQUIRED FOR ALL SYSTEMS.

- 1 MINIMUM WIDTH DEPENDS ON SITE CONDITIONS AND ENGINEERING JUDGEMENT.
- 2 PRIOR TO PLACING THE BEDDING, THE FOUNDATION MUST BE CONSTRUCTED TO A UNIFORM AND STABLE GRADE. IN THE EVENT THAT UNSUITABLE FOUNDATION MATERIALS ARE ENCOUNTERED DURING EXCAVATION, THEY SHALL BE REMOVED AND BROUGHT BACK TO THE GRADE WITH A FILL MATERIAL AS APPROVED BY THE ENGINEER.
- 5 HAUNCH ZONE MATERIAL SHALL BE PLACED AND UNIFORMLY COMPACTED WITHOUT SOFT SPOTS.

FOUNDATION/BEDDING PREPARATION

BACKFILL
MATERIAL SHALL BE PLACED IN 8"-10" MAXIMUM LIFTS. INADEQUATE COMPACTION CAN LEAD TO EXCESSIVE DEFLECTIONS WITHIN THE SYSTEM AND SETTLEMENT OF THE SOILS OVER THE SYSTEM. BACKFILL SHALL BE PLACED SUCH THAT THERE IS NO MORE THAN A TWO-LIFT DIFFERENTIAL BETWEEN THE SIDES OF ANY PIPE IN THE SYSTEM AT ALL TIMES DURING THE BACKFILL PROCESS. BACKFILL SHALL BE ADVANCED ALONG THE LENGTH OF THE SYSTEM AT THE SAME RATE TO AVOID DIFFERENTIAL LOADING ON ANY PIPES IN THE SYSTEM.

EQUIPMENT USED TO PLACE AND COMPACT THE BACKFILL SHALL BE OF A SIZE AND TYPE SO AS NOT TO DISTORT, DAMAGE, OR DISPLACE THE PIPE. ATTENTION MUST BE GIVEN TO PROVIDING ADEQUATE MINIMUM COVER FOR SUCH EQUIPMENT. MAINTAIN BALANCED LOADING ON ALL PIPES IN THE SYSTEM DURING ALL SUCH OPERATIONS.

OTHER ALTERNATE BACKFILL MATERIAL MAY BE ALLOWED DEPENDING ON SITE SPECIFIC CONDITIONS. REFER TO TYPICAL BACKFILL DETAIL FOR MATERIAL REQUIRED.

BACKFILL DETAIL
SCALE: N.T.S.

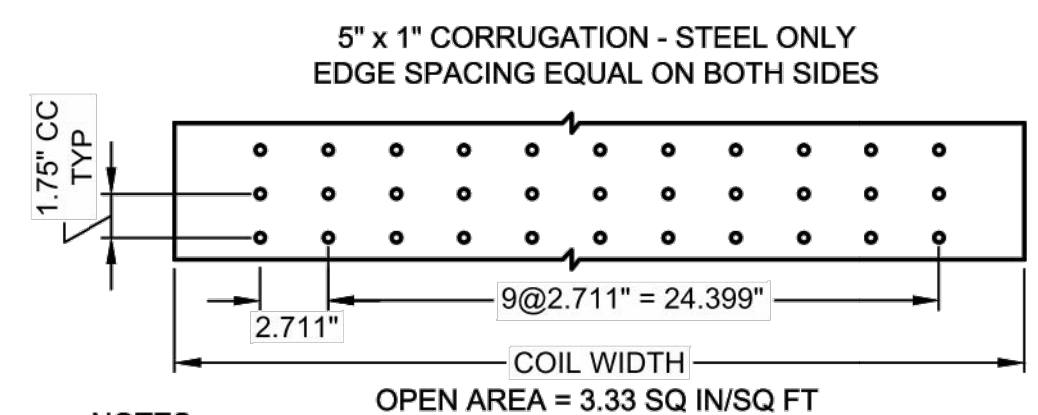
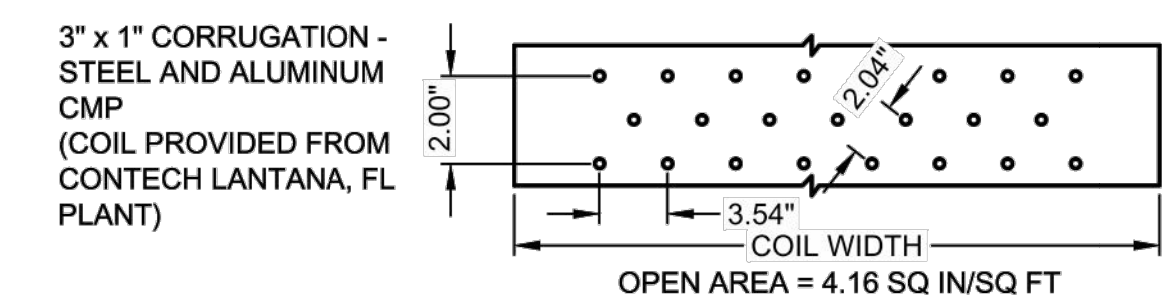
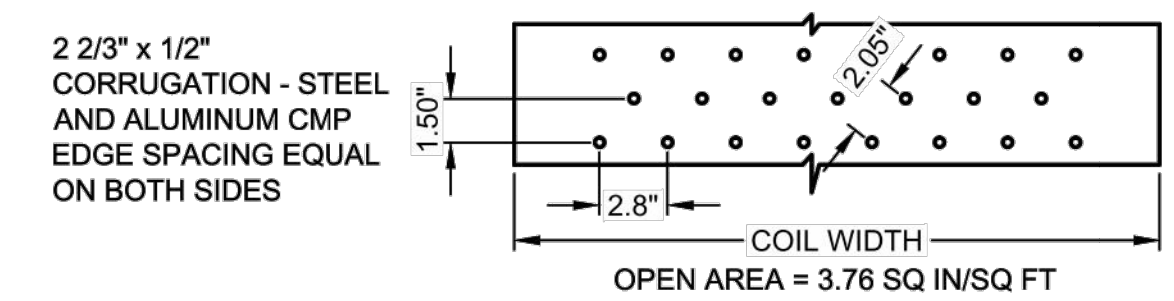

- NOTES:
- PERFORATIONS MEET AASHTO AND ASTM SPECIFICATIONS.
 - PERFORATION OPEN AREA PER SQUARE FOOT OF PIPE IS BASED ON THE NOMINAL DIAMETER AND LENGTH OF PIPE.
 - ALL DIMENSIONS ARE SUBJECT TO MANUFACTURING TOLERANCES.
 - ALL HOLES Ø3/8".

TYPICAL PERFORATION DETAIL
SCALE: N.T.S.

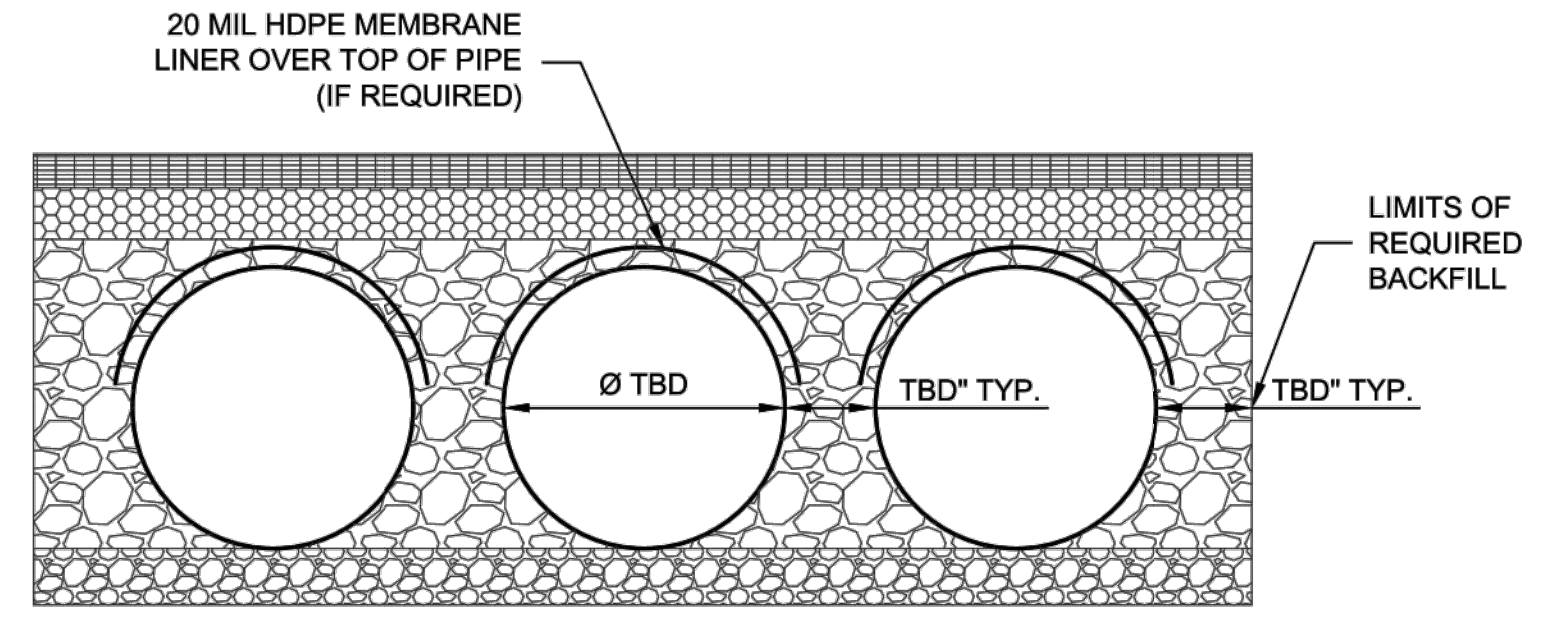

TYPICAL SECTION VIEW
LINER OVER ROWS
SCALE: N.T.S.

NOTE: IF SALTING AGENTS FOR SNOW AND ICE REMOVAL ARE USED ON OR NEAR THE PROJECT, AN HDPE MEMBRANE LINER IS RECOMMENDED WITH THE SYSTEM. THE IMPERMEABLE LINER IS INTENDED TO HELP PROTECT THE SYSTEM FROM THE POTENTIAL ADVERSE EFFECTS THAT MAY RESULT FROM A CHANGE IN THE SURROUNDING ENVIRONMENT OVER A PERIOD OF TIME. PLEASE REFER TO THE CORRUGATED METAL PIPE DETENTION DESIGN GUIDE FOR ADDITIONAL INFORMATION.

C:\DYODS\DATA\CONCEPTS - 14673-1.DWG 4/7/2020 9:59 AM

NOTE: THESE DRAWINGS ARE FOR CONCEPTUAL PURPOSES AND DO NOT REFLECT ANY LOCAL PREFERENCES OR REGULATIONS. PLEASE CONTACT YOUR LOCAL CONTECH REP FOR MODIFICATIONS.

The design and information shown on this drawing is provided as a service to the project owner, engineer and contractor by Contech Engineered Solutions LLC ("Contech"). Neither this drawing, nor any part thereof, may be used, reproduced or modified in any manner without the prior written consent of Contech. Failure to comply is done at the user's own risk and Contech expressly disclaims any liability or responsibility for such use.

If discrepancies between the supplied information upon which the drawing is based and actual field conditions are encountered as site work progresses, these discrepancies must be reported to Contech immediately for re-evaluation of the design. Contech accepts no liability for design based on missing, incomplete or inaccurate information supplied by others.

MARK	DATE	REVISION DESCRIPTION	BY

CONTECH
ENGINEERED SOLUTIONS LLC
www.ContechES.com
9025 Centre Pointe Dr., Suite 400, West Chester, OH 45069
800-338-1122 513-645-7000 513-645-7993 FAX

CONTECH
CMP DETENTION SYSTEMS
CONTECH
DYODS
DRAWING

DYODS - 14673-1-0
PROJECT NAME: Western Hills Athletic Club
Austin, TX
DESCRIPTION: UDS

PROJECT No.: 14673-1	SEQ. No.: 0	DATE: 4/7/2020
DESIGNED: DYODS	DRAWN: DYODS	
CHECKED:	APPROVED:	
SHEET NO.: D2		



mwm
Design Group
305 East Huntland Drive
Suite 200
Austin, Texas 78752
p: 512.453.0767
f: 512.453.1734
TBAE FIRM REGISTRATION NO.: 1452
TSPRE FIRM REGISTRATION NO.: F-14116
TBLPS FIRM REGISTRATION NO.: 10065600

NO.	DATE	DESCRIPTION	BY

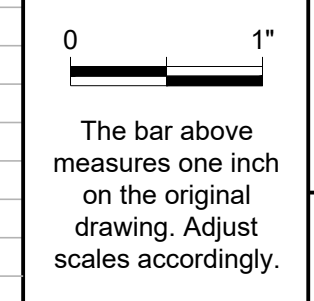

DETENTION POND DETAILS

Western Hills Athletic Club
4801 Rollingwood Drive
Austin, TX 78746

PLOTTED: 7/7/2020
JOB NO: 863-01
544
19 OF 26

File: Y:\863-01_WHP_Athletic_Club\CAD_Sheets\542 Detention Pond Details.dwg 22:34

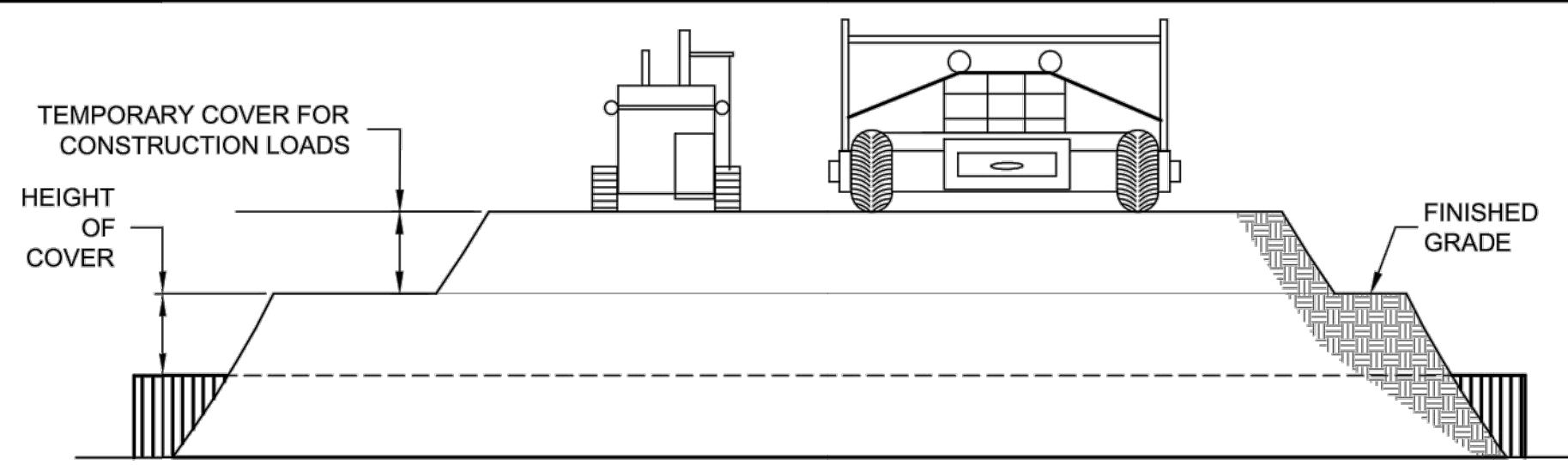

CONSTRUCTION LOADS

FOR TEMPORARY CONSTRUCTION VEHICLE LOADS, AN EXTRA AMOUNT OF COMPACTED COVER MAY BE REQUIRED OVER THE TOP OF THE PIPE. THE HEIGHT-OF-COVER SHALL MEET THE MINIMUM REQUIREMENTS SHOWN IN THE TABLE BELOW. THE USE OF HEAVY CONSTRUCTION EQUIPMENT NECESSITATES GREATER PROTECTION FOR THE PIPE THAN FINISHED GRADE COVER MINIMUMS FOR NORMAL HIGHWAY TRAFFIC.

PIPE SPAN, INCHES	AXLE LOADS (kips)			
	18-50	50-75	75-110	110-150
	MINIMUM COVER (FT)			
12-42	2.0	2.5	3.0	3.0
48-72	3.0	3.0	3.5	4.0
78-120	3.0	3.5	4.0	4.0
126-144	3.5	4.0	4.5	4.5

*MINIMUM COVER MAY VARY, DEPENDING ON LOCAL CONDITIONS. THE CONTRACTOR MUST PROVIDE THE ADDITIONAL COVER REQUIRED TO AVOID DAMAGE TO THE PIPE. MINIMUM COVER IS MEASURED FROM THE TOP OF THE PIPE TO THE TOP OF THE MAINTAINED CONSTRUCTION ROADWAY SURFACE.

CONSTRUCTION LOADING DIAGRAM
SCALE: N.T.S.

SPECIFICATION FOR DESIGNED DETENTION SYSTEM:

SCOPE

THIS SPECIFICATION COVERS THE MANUFACTURE AND INSTALLATION OF THE DESIGNED DETENTION SYSTEM DETAILED IN THE PROJECT PLANS.

MATERIAL

THE MATERIAL SHALL CONFORM TO THE APPLICABLE REQUIREMENTS LISTED BELOW:

ALUMINIZED TYPE 2 STEEL COILS SHALL CONFORM TO THE APPLICABLE REQUIREMENTS OF AASHTO M-274 OR ASTM A-92.

THE GALVANIZED STEEL COILS SHALL CONFORM TO THE APPLICABLE REQUIREMENTS OF AASHTO M-218 OR ASTM A-929.

THE POLYMER COATED STEEL COILS SHALL CONFORM TO THE APPLICABLE REQUIREMENTS OF AASHTO M-246 OR ASTM A-742.

THE ALUMINUM COILS SHALL CONFORM TO THE APPLICABLE REQUIREMENTS OF AASHTO M-197 OR ASTM B-744.

CONSTRUCTION LOADS

CONSTRUCTION LOADS MAY BE HIGHER THAN FINAL LOADS. FOLLOW THE MANUFACTURER'S OR NCSA GUIDELINES.

C:\DYODS\DATA\CAD\CAD\DYODS_14673-1.DWG 4/7/2020 8:58 AM

NOTE:

THESE DRAWINGS ARE FOR CONCEPTUAL PURPOSES AND DO NOT REFLECT ANY LOCAL PREFERENCES OR REGULATIONS. PLEASE CONTACT YOUR LOCAL CONTECH REP FOR MODIFICATIONS.

The design and information shown on this drawing is provided as a service to the project owner, engineer and contractor by Contech Engineered Solutions LLC ("Contech"). Neither this drawing, nor any part thereof, may be used, reproduced or modified in any manner without the prior written consent of Contech. Failure to comply is done at the user's own risk and Contech expressly disclaims any liability or responsibility for such use.

If discrepancies between the supplied information upon which the drawing is based and actual field conditions are encountered as site work progresses, these discrepancies must be reported to Contech immediately for re-evaluation of the design. Contech accepts no liability for designs based on missing, incomplete or inaccurate information supplied by others.

MARK	DATE	REVISION DESCRIPTION	BY

PIPE

THE PIPE SHALL BE MANUFACTURED IN ACCORDANCE TO THE APPLICABLE REQUIREMENTS LISTED BELOW:

ALUMINIZED TYPE 2: AASHTO M-36 OR ASTM A-760

GALVANIZED: AASHTO M-36 OR ASTM A-760

POLYMER COATED: AASHTO M-245 OR ASTM A-762

ALUMINUM: AASHTO M-196 OR ASTM B-745

HANDLING AND ASSEMBLY

SHALL BE IN ACCORDANCE WITH NCSP'S (NATIONAL CORRUGATED STEEL PIPE ASSOCIATION) FOR ALUMINIZED TYPE 2, GALVANIZED OR POLYMER COATED STEEL. SHALL BE IN ACCORDANCE WITH THE MANUFACTURER'S RECOMMENDATIONS FOR ALUMINUM PIPE.

INSTALLATION

SHALL BE IN ACCORDANCE WITH AASHTO STANDARD SPECIFICATIONS FOR HIGHWAY BRIDGES, SECTION 26, DIVISION II DIVISION II OR ASTM A-798 (FOR ALUMINIZED TYPE 2, GALVANIZED OR POLYMER COATED STEEL) OR ASTM B-788 (FOR ALUMINUM PIPE) AND IN CONFORMANCE WITH THE PROJECT PLANS AND SPECIFICATIONS. IF THERE ARE ANY INCONSISTENCIES OR CONFLICTS THE CONTRACTOR SHOULD DISCUSS AND RESOLVE WITH THE SITE ENGINEER.

IT IS ALWAYS THE RESPONSIBILITY OF THE CONTRACTOR TO FOLLOW OSHA GUIDELINES FOR SAFE PRACTICES.

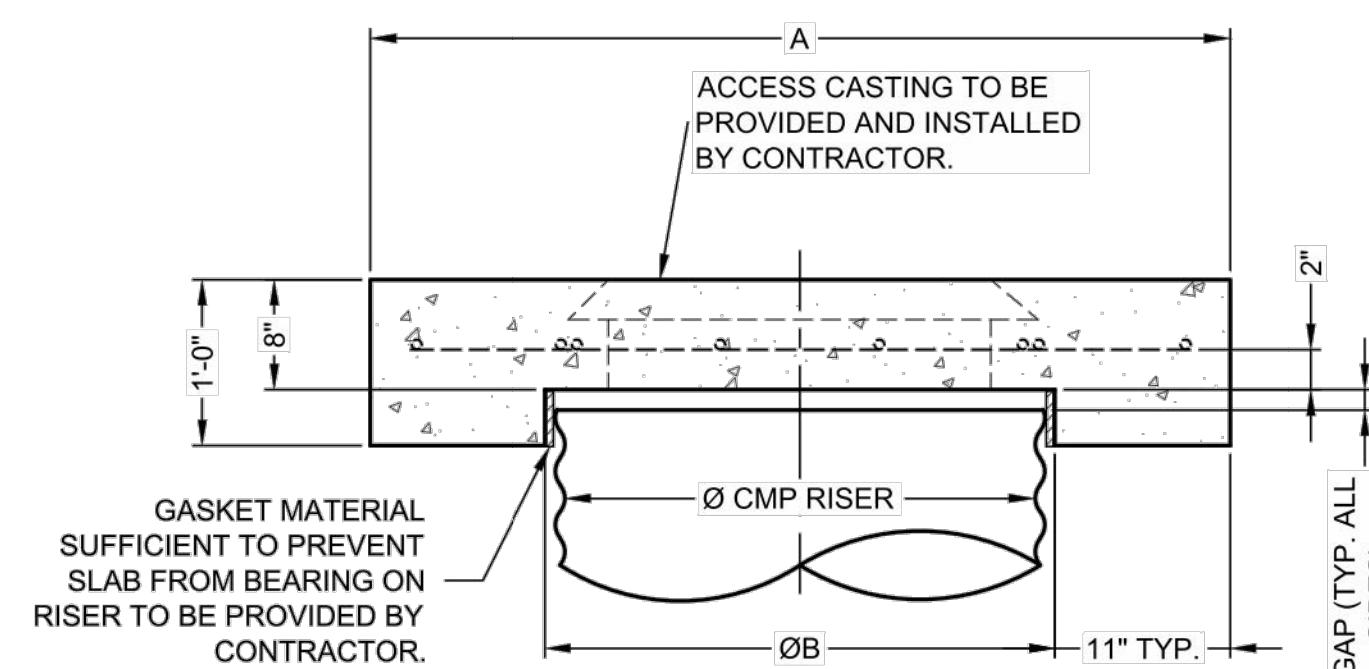

SECTION VIEW

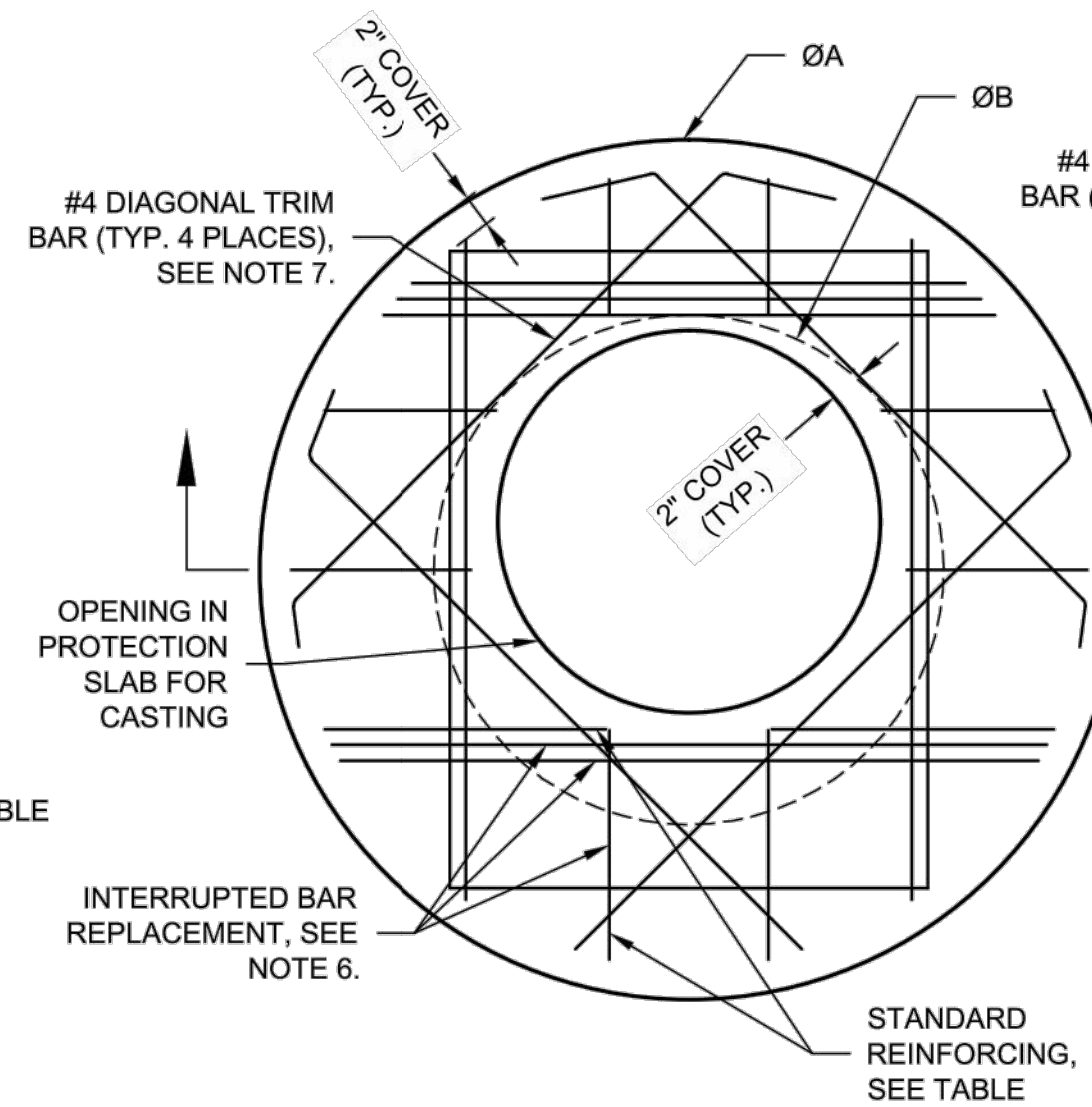

ROUND OPTION PLAN VIEW

REINFORCING TABLE				
Ø CMP RISER	A	Ø B	REINFORCING	**BEARING PRESSURE (PSF)
24"	Ø 4' 4" X 4"	26"	#5 @ 12" OCEW #5 @ 12" OCEW	2,410 1,780
30"	Ø 4'-6" 4'-6" X 4'-6"	32"	#5 @ 12" OCEW #5 @ 12" OCEW	2,120 1,530
36"	Ø 5' 5' X 5'	38"	#5 @ 10" OCEW #5 @ 10" OCEW	1,890 1,350
42"	Ø 5'-6" 5'-6" X 5'-6"	44"	#5 @ 10" OCEW #5 @ 9" OCEW	1,720 1,210
48"	Ø 6' 6' X 6'	50"	#5 @ 9" OCEW #5 @ 8" OCEW	1,600 1,100

** ASSUMED SOIL BEARING CAPACITY

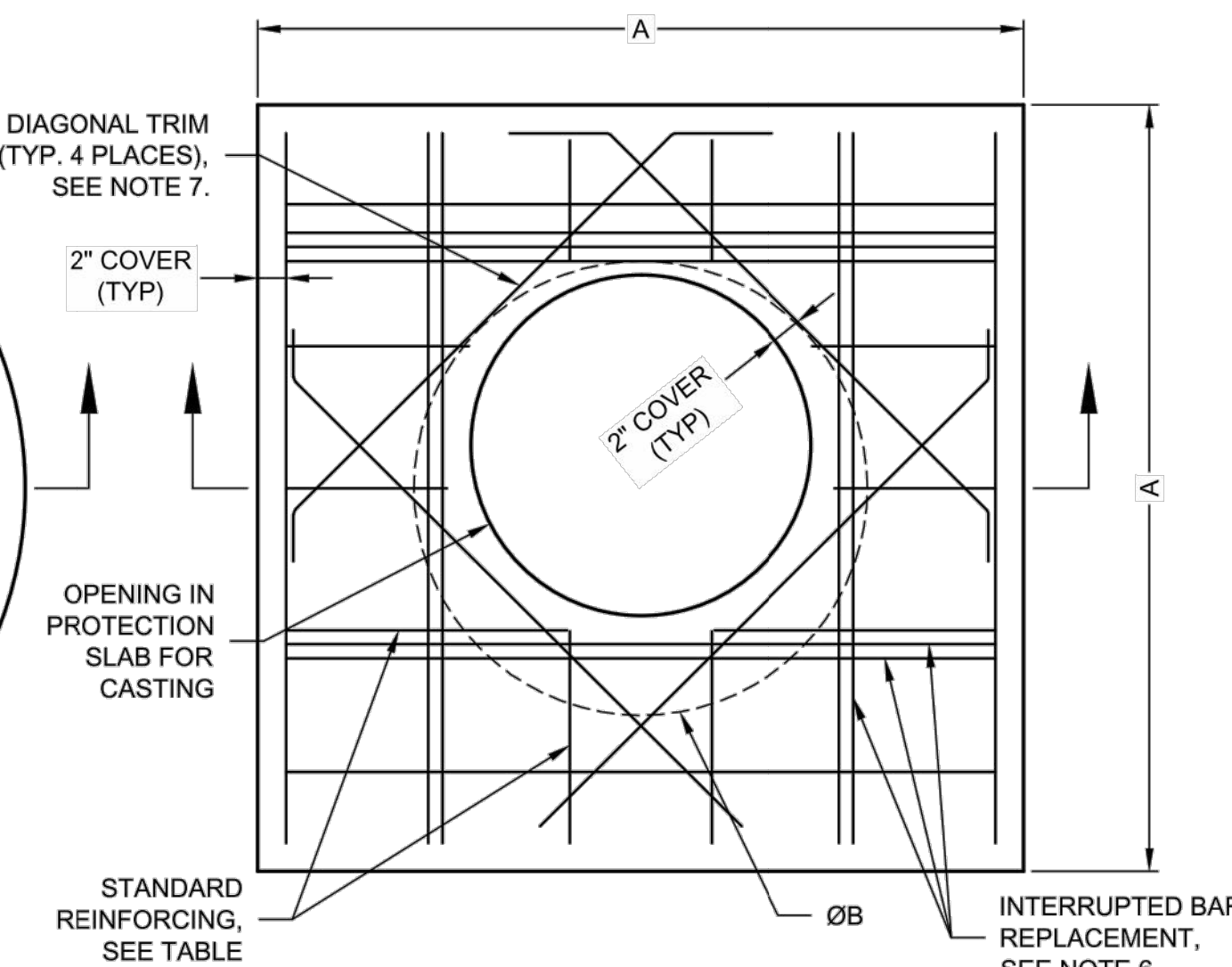

SQUARE OPTION PLAN VIEW

NOTES:

- DESIGN IN ACCORDANCE WITH AASHTO, 17th EDITION.
- DESIGN LOAD HS25.
- EARTH COVER = 1' MAX.
- CONCRETE STRENGTH = 3,500 psi
- REINFORCING STEEL = ASTM A615, GRADE 60.
- PROVIDE ADDITIONAL REINFORCING AROUND OPENINGS EQUAL TO THE BARS INTERRUPTED, HALF EACH SIDE. ADDITIONAL BARS TO BE IN THE SAME PLANE.
- TRIM OPENING WITH DIAGONAL #4 BARS, EXTEND BARS A MINIMUM OF 12" BEYOND OPENING, BEND BARS AS REQUIRED TO MAINTAIN BAR COVER.
- PROTECTION SLAB AND ALL MATERIALS TO BE PROVIDED AND INSTALLED BY CONTRACTOR.
- DETAIL DESIGN BY DELTA ENGINEERING, BINGHAMTON, NY.

MANHOLE CAP DETAIL
SCALE: N.T.S.



9025 Centre Pointe Dr., Suite 400, West Chester, OH 45069
800-338-1122 513-645-7000 513-645-7993 FAX



CONTECH
DYODS
DRAWING

DYODS - 14673-1-0
PROJECT NAME: Western Hills Athletic Club
Austin, TX
DESCRIPTION: UDS

PROJECT No.: 14673-1	SEQ. No.: 0	DATE: 4/7/2020
DESIGNED: DYODS	DRAWN: DYODS	
CHECKED:	APPROVED:	
SHEET NO.: D3		

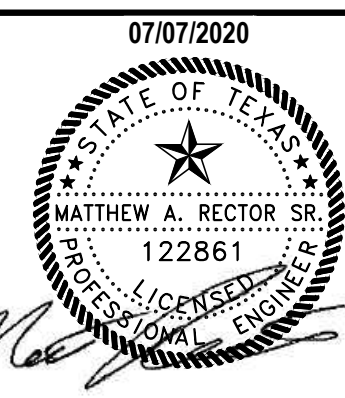

305 East Huntland Drive
Suite 200
Austin, Texas 78752
p: 512.453.0767
f: 512.453.1734
TBAE FIRM REGISTRATION NO.: 1452
TSPR FIRM REGISTRATION NO.: F-1416
TBPLS FIRM REGISTRATION NO.: 10065600

NO.	DATE	DESCRIPTION	BY

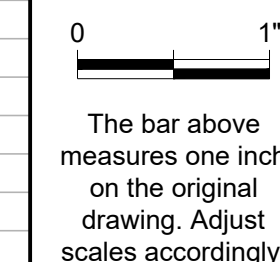

DETENTION POND DETAILS

Western Hills Athletic Club
4801 Rollingwood Drive
Austin, TX 78746

PLOTTED: 7/7/2020
JOB NO: 863-01

545

20 OF 26

File: Y:\863-01_WHP_Athletic_Club\CAD\Sheets\542 Detention Pond Details.dwg 22.34

CMP DETENTION INSTALLATION GUIDE

PROPER INSTALLATION OF A FLEXIBLE UNDERGROUND DETENTION SYSTEM WILL ENSURE LONG-TERM PERFORMANCE. THE CONFIGURATION OF THESE SYSTEMS OFTEN REQUIRES SPECIAL CONSTRUCTION PRACTICES THAT DIFFER FROM CONVENTIONAL FLEXIBLE PIPE CONSTRUCTION. CONTECH ENGINEERED SOLUTIONS STRONGLY SUGGESTS SCHEDULING A PRE-CONSTRUCTION MEETING WITH YOUR LOCAL SALES ENGINEER TO DETERMINE IF ADDITIONAL MEASURES, NOT COVERED IN THIS GUIDE, ARE APPROPRIATE FOR YOUR SITE.

FOUNDATION

CONSTRUCT A FOUNDATION THAT CAN SUPPORT THE DESIGN LOADING APPLIED BY THE PIPE AND ADJACENT BACKFILL WEIGHT AS WELL AS MAINTAIN ITS INTEGRITY DURING CONSTRUCTION.

IF SOFT OR UNSUITABLE SOILS ARE ENCOUNTERED, REMOVE THE POOR SOILS DOWN TO A SUITABLE DEPTH AND THEN BUILD UP TO THE APPROPRIATE ELEVATION WITH A COMPETENT BACKFILL MATERIAL. THE STRUCTURAL FILL MATERIAL GRADATION SHOULD NOT ALLOW THE MIGRATION OF FINES, WHICH CAN CAUSE SETTLEMENT OF THE DETENTION SYSTEM OR PAVEMENT ABOVE. IF THE STRUCTURAL FILL MATERIAL IS NOT COMPATIBLE WITH THE UNDERLYING SOILS AN ENGINEERING FABRIC SHOULD BE USED AS A SEPARATOR. IN SOME CASES, USING A STIFF REINFORCING GEOGRID REDUCES OVER EXCAVATION AND REPLACEMENT FILL QUANTITIES.

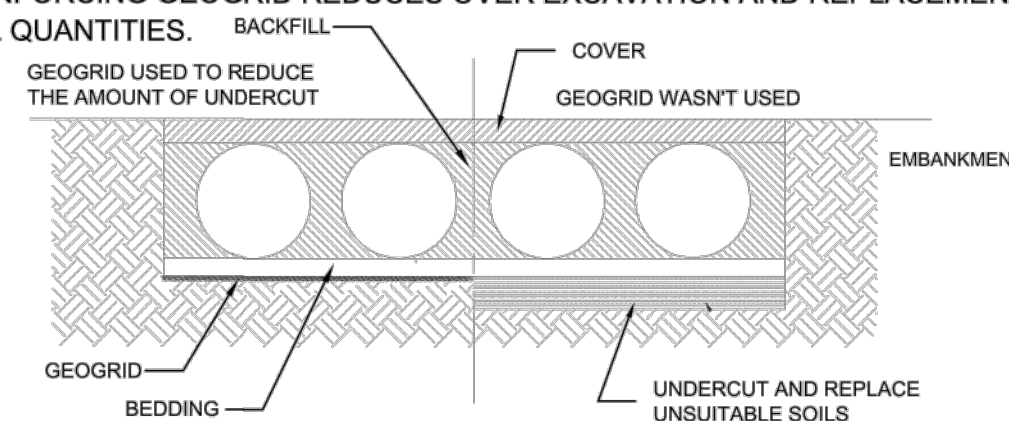

GRADE THE FOUNDATION SUBGRADE TO A UNIFORM OR SLIGHTLY SLOPING GRADE. IF THE SUBGRADE IS CLAY OR RELATIVELY NON-POROUS AND THE CONSTRUCTION SEQUENCE WILL LAST FOR AN EXTENDED PERIOD OF TIME, IT IS BEST TO SLOPE THE GRADE TO ONE END OF THE SYSTEM. THIS WILL ALLOW EXCESS WATER TO DRAIN QUICKLY, PREVENTING SATURATION OF THE SUBGRADE.

GEOMEMBRANE BARRIER

A SITE'S RESISTIVITY MAY CHANGE OVER TIME WHEN VARIOUS TYPES OF SALTING AGENTS ARE USED, SUCH AS ROAD SALTS FOR DEICING AGENTS. IF SALTING AGENTS ARE USED ON OR NEAR THE PROJECT SITE, A GEOMEMBRANE BARRIER IS RECOMMENDED WITH THE SYSTEM. THE GEOMEMBRANE LINER IS INTENDED TO HELP PROTECT THE SYSTEM FROM THE POTENTIAL ADVERSE EFFECTS THAT MAY RESULT FROM THE USE OF SUCH AGENTS INCLUDING PREMATURE CORROSION AND REDUCED ACTUAL SERVICE LIFE.

THE PROJECT'S ENGINEER OF RECORD IS TO EVALUATE WHETHER SALTING AGENTS WILL BE USED ON OR NEAR THE PROJECT SITE, AND USE HIS/HER BEST JUDGEMENT TO DETERMINE IF ANY ADDITIONAL PROTECTIVE MEASURES ARE REQUIRED. BELOW IS A TYPICAL DETAIL SHOWING THE PLACEMENT OF A GEOMEMBRANE BARRIER FOR PROJECTS WHERE SALTING AGENTS ARE USED ON OR NEAR THE PROJECT SITE.

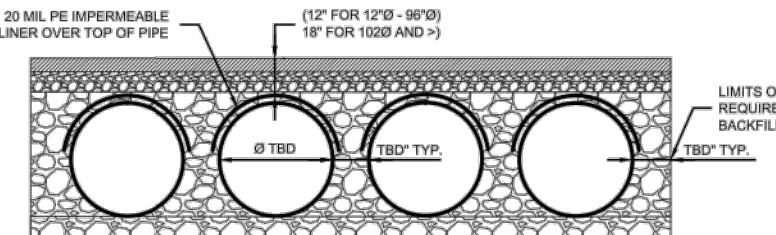

IN-SITU TRENCH WALL

IF EXCAVATION IS REQUIRED, THE TRENCH WALL NEEDS TO BE CAPABLE OF SUPPORTING THE LOAD THAT THE PIPE SHEDS AS THE SYSTEM IS LOADED. IF SOILS ARE NOT CAPABLE OF SUPPORTING THESE LOADS, THE PIPE CAN DEFLECT. PERFORM A SIMPLE SOIL PRESSURE CHECK USING THE APPLIED LOADS TO DETERMINE THE LIMITS OF EXCAVATION BEYOND THE SPRING LINE OF THE OUTER MOST PIPES.

IN MOST CASES THE REQUIREMENTS FOR A SAFE WORK ENVIRONMENT AND PROPER BACKFILL PLACEMENT AND COMPACTION TAKE CARE OF THIS CONCERN.

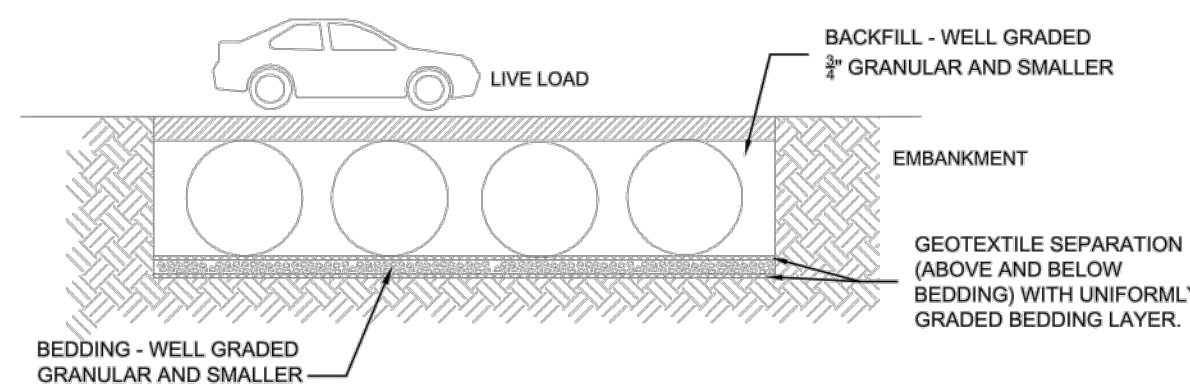

BACKFILL PLACEMENT

MATERIAL SHALL BE WORKED INTO THE PIPE HAUNCHES BY MEANS OF SHOVEL-SLICING, RODDING, AIR TAMPER, VIBRATORY ROD, OR OTHER EFFECTIVE METHODS.

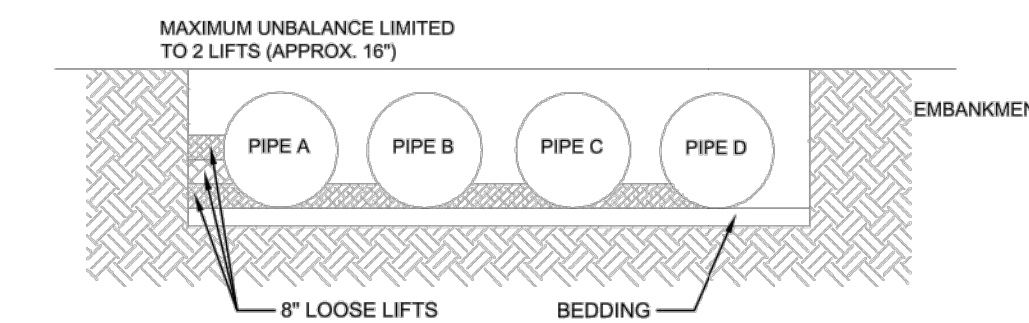

IF AASHTO T99 PROCEDURES ARE DETERMINED INFEASIBLE BY THE GEOTECHNICAL ENGINEER OF RECORD, COMPACTION IS CONSIDERED ADEQUATE WHEN NO FURTHER YIELDING OF THE MATERIAL IS OBSERVED UNDER THE COMPACTOR, OR UNDER FOOT, AND THE GEOTECHNICAL ENGINEER OF RECORD (OR REPRESENTATIVE THEREOF) IS SATISFIED WITH THE LEVEL OF COMPACTION.

FOR LARGE SYSTEMS, CONVEYOR SYSTEMS, BACKHOES WITH LONG REACHES OR DRAGLINES WITH STONE BUCKETS MAY BE USED TO PLACE BACKFILL. ONCE MINIMUM COVER FOR CONSTRUCTION LOADING ACROSS THE ENTIRE WIDTH OF THE SYSTEM IS REACHED, ADVANCE THE EQUIPMENT TO THE END OF THE RECENTLY PLACED FILL, AND BEGIN THE SEQUENCE AGAIN UNTIL THE SYSTEM IS COMPLETELY BACKFILLED. THIS TYPE OF CONSTRUCTION SEQUENCE PROVIDES ROOM FOR STOCKPILED BACKFILL DIRECTLY BEHIND THE BACKHOE, AS WELL AS THE MOVEMENT OF CONSTRUCTION TRAFFIC. MATERIAL STOCKPILES ON TOP OF THE BACKFILLED DETENTION SYSTEM SHOULD BE LIMITED TO 8- TO 10- FEET HIGH AND MUST PROVIDE BALANCED LOADING ACROSS ALL BARRELS. TO DETERMINE THE PROPER COVER OVER THE PIPES TO ALLOW THE MOVEMENT OF CONSTRUCTION EQUIPMENT SEE TABLE 1, OR CONTACT YOUR LOCAL CONTECH SALES ENGINEER.

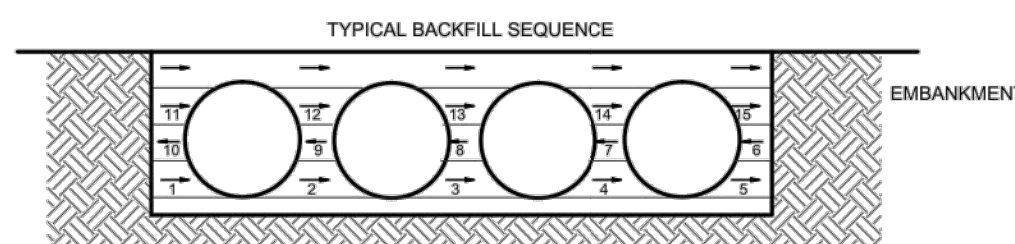

WHEN FLOWABLE FILL IS USED, YOU MUST PREVENT PIPE FLOATATION. TYPICALLY, SMALL LIFTS ARE PLACED BETWEEN THE PIPES AND THEN ALLOWED TO SET-UP PRIOR TO THE PLACEMENT OF THE NEXT LIFT. THE ALLOWABLE THICKNESS OF THE CLSM LIFT IS A FUNCTION OF A PROPER BALANCE BETWEEN THE UPLIFT FORCE OF THE CLSM, THE OPPOSING WEIGHT OF THE PIPE, AND THE EFFECT OF OTHER RESTRAINING MEASURES. THE PIPE CAN CARRY LIMITED FLUID PRESSURE WITHOUT PIPE DISTORTION OR DISPLACEMENT, WHICH ALSO AFFECTS THE CLSM LIFT THICKNESS. YOUR LOCAL CONTECH SALES ENGINEER CAN HELP DETERMINE THE PROPER LIFT THICKNESS.

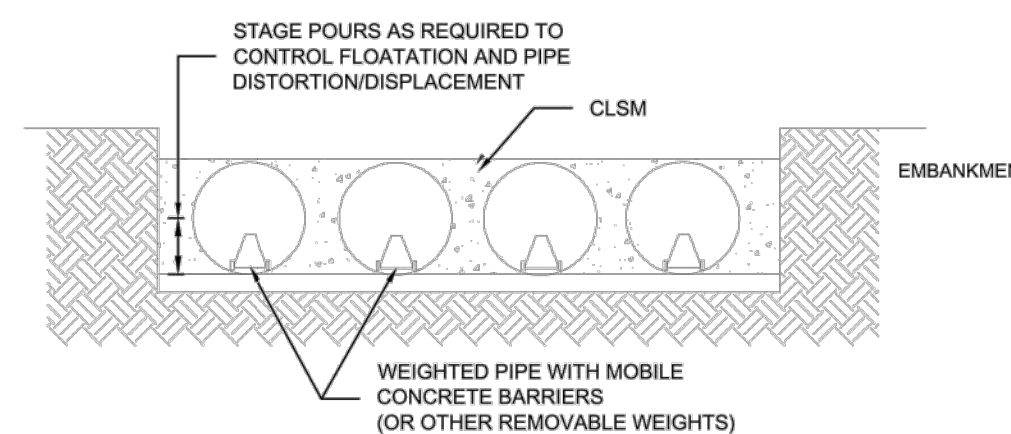

CONSTRUCTION LOADING

TYPICALLY, THE MINIMUM COVER SPECIFIED FOR A PROJECT ASSUMES H-20 LIVE LOAD. BECAUSE CONSTRUCTION LOADS OFTEN EXCEED DESIGN LIVE LOADS, INCREASED TEMPORARY MINIMUM COVER REQUIREMENTS ARE NECESSARY. SINCE CONSTRUCTION EQUIPMENT VARIES FROM JOB TO JOB, IT IS BEST TO ADDRESS EQUIPMENT SPECIFIC MINIMUM COVER REQUIREMENTS WITH YOUR LOCAL CONTECH SALES ENGINEER DURING YOUR PRE-CONSTRUCTION MEETING.

ADDITIONAL CONSIDERATIONS

BECAUSE MOST SYSTEMS ARE CONSTRUCTED BELOW-GRADE, RAINFALL CAN RAPIDLY FILL THE EXCAVATION; POTENTIALLY CAUSING FLOATATION AND MOVEMENT OF THE PREVIOUSLY PLACED PIPES. TO HELP MITIGATE POTENTIAL PROBLEMS, IT IS BEST TO START THE INSTALLATION AT THE DOWNSTREAM END WITH THE OUTLET ALREADY CONSTRUCTED TO ALLOW A ROUTE FOR THE WATER TO ESCAPE. TEMPORARY DIVERSION MEASURES MAY BE REQUIRED FOR HIGH FLOWS DUE TO THE RESTRICTED NATURE OF THE OUTLET PIPE.

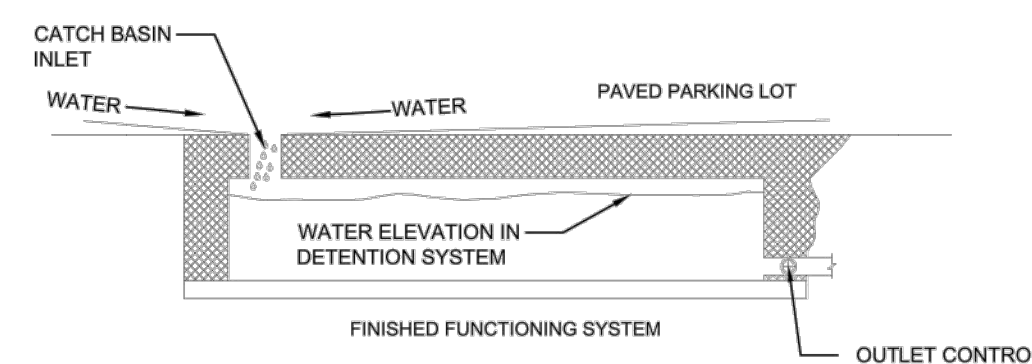

CMP DETENTION SYSTEM INSPECTION AND MAINTENANCE

UNDERGROUND STORMWATER DETENTION AND INFILTRATION SYSTEMS MUST BE INSPECTED AND MAINTAINED AT REGULAR INTERVALS FOR PURPOSES OF PERFORMANCE AND LONGEVITY.

INSPECTION

INSPECTION IS THE KEY TO EFFECTIVE MAINTENANCE OF CMP DETENTION SYSTEMS AND IS EASILY PERFORMED. CONTECH RECOMMENDS ONGOING, QUARTERLY INSPECTIONS. THE RATE AT WHICH THE SYSTEM COLLECTS POLLUTANTS WILL DEPEND MORE ON SITE SPECIFIC ACTIVITIES RATHER THAN THE SIZE OR CONFIGURATION OF THE SYSTEM.

INSPECTIONS SHOULD BE PERFORMED MORE OFTEN IN EQUIPMENT WASHDOWN AREAS, IN CLIMATES WHERE SANDING AND/OR SALTING OPERATIONS TAKE PLACE, AND IN OTHER VARIOUS INSTANCES IN WHICH ONE WOULD EXPECT HIGHER ACCUMULATIONS OF SEDIMENT OR ABRASIVE/ CORROSIVE CONDITIONS. A RECORD OF EACH INSPECTION IS TO BE MAINTAINED FOR THE LIFE OF THE SYSTEM

MAINTENANCE

CMP DETENTION SYSTEMS SHOULD BE CLEANED WHEN AN INSPECTION REVEALS ACCUMULATED SEDIMENT OR TRASH IS CLOGGING THE DISCHARGE ORIFICE.

ACCUMULATED SEDIMENT AND TRASH CAN TYPICALLY BE EVACUATED THROUGH THE MANHOLE OVER THE OUTLET ORIFICE. IF MAINTENANCE IS NOT PERFORMED AS RECOMMENDED, SEDIMENT AND TRASH MAY ACCUMULATE IN FRONT OF THE OUTLET ORIFICE. MANHOLE COVERS SHOULD BE SECURELY SEATED FOLLOWING CLEANING ACTIVITIES. CONTECH SUGGESTS THAT ALL SYSTEMS BE DESIGNED WITH AN ACCESS/INSPECTION MANHOLE SITUATED AT OR NEAR THE INLET AND THE OUTLET ORIFICE. SHOULD IT BE NECESSARY TO GET INSIDE THE SYSTEM TO PERFORM MAINTENANCE ACTIVITIES, ALL APPROPRIATE PRECAUTIONS REGARDING CONFINED SPACE ENTRY AND OSHA REGULATIONS SHOULD BE FOLLOWED.

ANNUAL INSPECTIONS ARE BEST PRACTICE FOR ALL UNDERGROUND SYSTEMS. DURING THIS INSPECTION, IF EVIDENCE OF SALTING/DE-ICING AGENTS IS OBSERVED WITHIN THE SYSTEM, IT IS BEST PRACTICE FOR THE SYSTEM TO BE RINSED, INCLUDING ABOVE THE SPRING LINE SOON AFTER THE SPRING THAW AS PART OF THE MAINTENANCE PROGRAM FOR THE SYSTEM.

MAINTAINING AN UNDERGROUND DETENTION OR INFILTRATION SYSTEM IS EASIEST WHEN THERE IS NO FLOW ENTERING THE SYSTEM. FOR THIS REASON, IT IS A GOOD IDEA TO SCHEDULE THE CLEANOUT DURING DRY WEATHER.

THE FOREGOING INSPECTION AND MAINTENANCE EFFORTS HELP ENSURE UNDERGROUND PIPE SYSTEMS USED FOR STORMWATER STORAGE CONTINUE TO FUNCTION AS INTENDED BY IDENTIFYING RECOMMENDED REGULAR INSPECTION AND MAINTENANCE PRACTICES. INSPECTION AND MAINTENANCE RELATED TO THE STRUCTURAL INTEGRITY OF THE PIPE OR THE SOUNDNESS OF PIPE JOINT CONNECTIONS IS BEYOND THE SCOPE OF THIS GUIDE.

C:\DYODS\DATA\PC\DWG\0405-14673-1.DWG 4/7/2020 9:59 AM

The design and information shown on this drawing is provided as a service to the project owner, engineer and contractor by Contech Engineered Solutions LLC ("Contech"). Neither this drawing, nor any part thereof, may be used, reproduced or modified in any manner without the prior written consent of Contech. Failure to comply is done at the user's own risk and Contech expressly disclaims any liability or responsibility for such use.

If discrepancies between the supplied information upon which the drawing is based and actual field conditions are encountered as site work progresses, these discrepancies must be reported to Contech immediately for re-evaluation of the design. Contech accepts no liability for designs based on missing, incomplete or inaccurate information supplied by others.

MARK	DATE	REVISION DESCRIPTION	BY

CONTECH
ENGINEERED SOLUTIONS LLC
www.ContechES.com
9025 Centre Pointe Dr., Suite 400, West Chester, OH 45069
800-338-1122 513-645-7000 513-645-7993 FAX

CONTECH
CMP DETENTION SYSTEMS
CONTECH DYODS DRAWING

DYODS - 14673-1-0
PROJECT NAME: Western Hills Athletic Club
Austin, TX
DESCRIPTION: UDS

PROJECT No.: 14673-1	SEQ. No.: 0	DATE: 4/7/2020
DESIGNED: DYODS	DRAWN: DYODS	
CHECKED:	APPROVED:	
SHEET No.: D4		



mwm Design Group
305 East Huntland Drive
Suite 200
Austin, Texas 78752
p: 512.453.0767
f: 512.453.1734
TBAE FIRM REGISTRATION NO.: 1452
TSRE FIRM REGISTRATION NO.: F-14116
TBPLS FIRM REGISTRATION NO.: 10065600

NO.	DATE	DESCRIPTION	BY

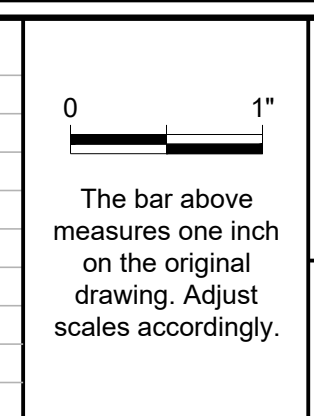

DETENTION POND DETAILS

Western Hills Athletic Club
4801 Rollingwood Drive
Austin, TX 78746

PLOTTED: 7/7/2020
JOB NO: 863-01
546
21 OF 26

File: Y:\863-01_WHL_Athletic_Club\CAD\Sheets\042 Detention Pond Details.dwg 22:34

LANDSCAPE NOTES

1. THE CONTRACTOR SHALL LOCATE AND VERIFY THE EXISTENCE OF ALL OVERHEAD AND UNDERGROUND UTILITIES (INCLUDING THOSE PROPOSED WITH THIS PROJECT, I.E. IRRIGATION, WASTEWATER, WATER, STORM SEWER, GAS, TELECOM, FIBER OPTIC, ELECTRIC, ETC.) PRIOR TO STARTING WORK.
2. INFORMATION PROVIDED ON THIS PLAN IS GENERAL IN NATURE; DIMENSIONS, AREAS, AND DISTANCES ARE APPROXIMATE AND SHOULD BE FIELD VERIFIED PRIOR TO BIDDING. DISCREPANCIES SHALL BE REPORTED TO THE LANDSCAPE ARCHITECT FOR RESOLUTION PRIOR TO STARTING WORK.
3. THE CONTRACTOR IS TO THOROUGHLY FAMILIARIZE HIM/HERSELF WITH ALL PLANS, SPECIFICATIONS AND THE SITE PRIOR TO BIDDING. FAILURE TO DO SO WILL NOT REDUCE THE CONTRACTOR'S OBLIGATION TO PERFORM THE WORK AS DESCRIBED FOR THE PRICE BID.
4. QUANTITIES SHOWN ARE INTENDED TO ASSIST CONTRACTORS IN EVALUATING THEIR OWN TAKE OFFS AND ARE NOT GUARANTEED AS ACCURATE REPRESENTATIONS OF REQUIRED MATERIALS. THE CONTRACTOR SHALL BE RESPONSIBLE FOR HIS BID QUANTITIES AND IS REQUIRED TO REFLECT THE DESIGN INTENT.
5. ALL PLANT MATERIALS SHALL CONFORM TO THE GUIDELINES ESTABLISHED BY THE CURRENT AMERICAN STANDARD FOR NURSERY STOCK, PUBLISHED BY THE AMERICAN ASSOCIATION OF NURSERYMEN, OR EQUIVALENT
6. NO SUBSTITUTIONS OF PLANT MATERIAL LOCATIONS, SPECIES OR SIZE WILL BE ALLOWED WITHOUT PRIOR APPROVAL OF THE LANDSCAPE ARCHITECT. ALL PLANT MATERIALS SHALL BE APPROVED BY THE LANDSCAPE ARCHITECT PRIOR TO INSTALLATION.
7. AS PART OF THE BASE BID, THE LANDSCAPE CONTRACTOR IS RESPONSIBLE FOR ALL LANDSCAPE MAINTENANCE AS INDICATED IN THE PROJECT SPECIFICATIONS (INCLUDING, BUT NOT LIMITED TO MOWING, WATERING, REPLACEMENT OF UNACCEPTABLE, DISEASED OR DEAD PLANTS, ETC.) AND WEED CONTROL UNTIL FINAL ACCEPTANCE BY OWNER.
8. CONTRACTOR SHALL GUARANTEE ALL PLANT MATERIAL TO BE ALIVE AND BE IN A HEALTHY, VIGOROUS CONDITION FOR A PERIOD OF ONE YEAR FROM THE DATE OF COMPLETION OF THE ENTIRE PROJECT OR OTHER DATE(S) ESTABLISHED BY THE LANDSCAPE ARCHITECT, OR OWNER, EXCEPT AS MAY RESULT FROM NEGLIGENCE OR DAMAGE BY THE OWNER, DAMAGE BY OTHERS OR UNUSUAL PHENOMENA BEYOND THE CONTRACTOR'S CONTROL.
9. CONTRACTOR SHALL REPLACE ALL DEAD, AND/OR UNHEALTHY PLANT MATERIALS AND/OR PLANT MATERIALS THAT HAVE PARTIALLY DIED PURSUANT TO THE CONDITION OF THE WARRANTY AT NO EXPENSE TO THE OWNER. DEAD MATERIALS MUST BE REPLACED WITHIN 10 BUSINESS DAYS PER TECHNICAL PROVISIONS. RE-WARRANT REPLACEMENT PLANTS FOR AN ADDITIONAL ONE YEAR UNDER THE SAME TERMS AS THE ORIGINAL WARRANTY. PLANT MATERIALS USED FOR REPLACEMENT SHALL BE THE SAME SPECIES, SIZE AND SHAPE.
10. ALL PLANTS SHALL BE HEALTHY, VIGOROUS AND REPRESENTATIVE OF THE SPECIES SPECIFIED. ALL PLANTS SHALL BE WELL BRANCHED, PROPORTIONED, AND FREE OF ALL INSECTS, DISEASES, BARK BRUISES, SCRAPES, CRACKED BRANCHES AND PHYSICAL DAMAGE. PLANTS SHALL BE BALLED AND WRAPPED OR CONTAINER GROWN AS SPECIFIED. NO PLANT MATERIALS WILL BE ACCEPTED IF IT IS ROOT BOUND. ALL ROOT WRAPPING MATERIAL SHALL BE REMOVED AT TIME OF PLANTING, AS SHOWN ON DETAILS.
11. ALL PLANTS SHALL BE INSTALLED AS PER DETAILS AND THE CONTRACT SPECIFICATIONS.
12. ALL PLANTS AND STAKES SHALL BE SET PLUMB UNLESS OTHERWISE SPECIFIED.
13. THE LANDSCAPE CONTRACTOR SHALL REFER TO THE CONTRACT SPECIFICATIONS FOR ADDITIONAL REQUIREMENTS.
14. INSTALLATION OF LANDSCAPE SHALL BE PERFORMED BY A QUALIFIED LANDSCAPE INSTALLER WITH A MINIMUM OF FIVE YEARS CONTINUOUS EXPERIENCE OF INSTALLING LANDSCAPE PLANTINGS OF SIMILAR SIZE AND SCOPE.
15. CONTRACTOR SHALL PROVIDE MAINTENANCE FOR LANDSCAPE & IRRIGATION SYSTEM FOR 12 MONTHS FOLLOWING FINAL ACCEPTANCE OF ENTIRE PROJECT.
16. LANDSCAPE MATERIALS SHALL BE LOCATED SO AS NOT TO OBSTRUCT VISUAL OR PHYSICAL ACCESS TO FIRE HYDRANTS. ALL LANDSCAPE MATERIALS SHALL BE INSTALLED IN CONFORMANCE WITH UTILITY COMPANY REQUIREMENTS AT TRANSFORMERS, METERS, OVERHEAD LINES, ETC. NOTIFY LANDSCAPE ARCHITECT OF ANY DISCREPANCIES.
17. EXECUTE ALL LANDSCAPING AND REVEGETATION PRIOR TO REQUEST FOR CERTIFICATE OF OCCUPANCY, FINAL INSPECTION OR AS OTHERWISE DIRECTED BY THE LANDSCAPE ARCHITECT OR OWNER. HOWEVER, NO PLANT MATERIALS SHALL BE INSTALLED BEFORE ROUGH GRADING HAS BEEN COMPLETED AND APPROVED BY THE LANDSCAPE ARCHITECT, OWNER OR OWNER'S DESIGNATED REPRESENTATIVE. FULLY PREPARE ALL LANDSCAPE BEDS (INCLUDING IRRIGATION) PRIOR TO INSTALLATION OF LANDSCAPE PLANTS.
18. SITE STOCKPILED TOPSOIL MAY BE USED IF IT HAS BEEN DEEMED ACCEPTABLE IN QUALITY AND APPROVED BY LANDSCAPE ARCHITECT.
19. ALL PLANTS SHALL BEAR THE SAME RELATIONSHIP TO FINISHED GRADE AS THE PLANT'S ORIGINAL GRADE BEFORE DIGGING.
20. THE LANDSCAPE CONTRACTOR SHALL PROVIDE AN IRRIGATION SYSTEM FULLY COMPLIANT WITH TCEQ REQUIREMENTS AND COMPLIANT WITH THE LANDSCAPE IRRIGATION NOTES AND CONTRACT SPECIFICATIONS.

LANDSCAPE IRRIGATION NOTES

- AUTOMATIC IRRIGATION SYSTEMS SHALL COMPLY WITH THE FOLLOWING REQUIREMENTS. THESE REQUIREMENTS SHALL BE NOTED ON THE SITE DEVELOPMENT PERMIT AND SHALL BE IMPLEMENTED AS PART OF THE LANDSCAPE INSPECTION:
1. A NEW COMMERCIAL AND MULTI-FAMILY IRRIGATION SYSTEM MUST BE DESIGNED AND INSTALLED SO THAT:
 - (A) THERE IS NOT DIRECT OVERSPRAY ONTO NON-IRRIGATED AREAS;
 - (B) THE SYSTEM DOES NOT INCLUDE SPRAY IRRIGATION ON AREAS LESS THAN SIX (6) FEET WIDE (SUCH AS MEDIANS, BUFFER STRIPS, AND PARKING LOT ISLANDS)
 - (C) ABOVE-GROUND IRRIGATION EMISSION DEVICES ARE SET BACK AT LEAST SIX (6) INCHES FROM IMPERVIOUS SURFACES;
 - (D) THE IRRIGATION SYSTEM HAS A MASTER VALVE;
 - (E) CIRCUIT REMOTE CONTROL VALVES HAVE ADJUSTABLE FLOW CONTROLS;
 - (F) SERVICEABLE IN-HEAD CHECK VALVES ARE ADJACENT TO PAVED AREAS WHERE ELEVATION DIFFERENCES MAY CAUSE LOW HEAD DRAINAGE;
 - (G) THE IRRIGATION SYSTEM HAS A CITY- APPROVED WEATHER BASED CONTROLLER;
 - (H) AN AUTOMATIC RAIN SHUT-OFF DEVICE SHUTS OFF THE IRRIGATION SYSTEM AUTOMATICALLY AFTER NOT MORE THAN A ONE-HALF INCH (1/2") RAINFALL;
 - (I) ZONE VALVES AND CIRCUITS ARE SEPARATED BASED ON PLANT WATER REQUIREMENTS;
 - (J) AN IRRIGATION EMISSION DEVICE (SUCH AS SPRAY, ROTOR, OR DRIP EMITTER) DOES NOT EXCEED THE MANUFACTURER'S RECOMMENDED OPERATING PRESSURE; AND
 - (K) NO COMPONENT OF THE IRRIGATION SYSTEM DEVIATES FROM THE MANUFACTURER'S RECOMMENDED USE OF THE PRODUCT.
 2. THE MAXIMUM SPACING BETWEEN SPRAY OR ROTARY SPRINKLER HEADS MUST NOT EXCEED THE RADIUS OF THROW OF THE HEAD UNLESS MANUFACTURER OF THE SPRINKLER HEAD SPECIFICALLY RECOMMENDS A GREATER SPACING. THE RADIUS OF THROW IS DETERMINED BY REFERENCE TO THE MANUFACTURER'S SPECIFICATIONS FOR A SPECIFIC NOZZLE AT A SPECIFIC OPERATING PRESSURE.
 3. THE IRRIGATION INSTALLER SHALL DEVELOP AND PROVIDE AN AS-BUILT DESIGN PLAN AND WATER BUDGET TO THE CITY AT THE TIME THE FINAL PLUMBING INSPECTION IS PERFORMED. THE WATER BUDGET SHALL INCLUDE:
 - (A) A CHART CONTAINING ZONE NUMBERS, PRECIPITATION RATE, AND GALLONS PER MINUTE; AND
 - (B) THE LOCATION OF THE EMERGENCY IRRIGATION SYSTEM SHUT-OFF VALVE. A LAMINATED COPY OF THE WATER BUDGET SHALL BE PERMANENTLY INSTALLED INSIDE THE IRRIGATION CONTROLLER DOOR.
 4. IRRIGATION CONTRACTOR SHALL PROVIDE A COMPLETE AS-BUILT PLAN TO OWNER, OR OWNER'S DESIGNATED REPRESENTATIVE SHOWING ALL IRRIGATION COMPONENTS AND SIZE OF COMPONENTS, INCLUDING WATER PRESSURE, MAIN LINE, LATERAL LINES, VALVES, HEADS, BACKFLOW DEVICE, CONTROLLER, QUICK COUPLERS, ETC.
 5. COMPLY WITH ALL APPLICABLE TCEQ IRRIGATION RULES AND REGULATIONS.
 6. CONTRACTOR IS TO VERIFY PRESSURE AND WATER SUPPLY CHARACTERISTICS ARE ADEQUATE FOR THIS INSTALLATION. ANY DISCREPANCIES OR INADEQUACIES SHALL BE REPORTED TO THE OWNER IMMEDIATELY, BEFORE STARTING CONSTRUCTION. DESIGN PRESSURE IS 65 PSI AT 45 GMP.
 7. CONTRACTOR SHALL OBTAIN ALL PERMITS AND HANDLE ALL INSPECTIONS FOR THIS WORK AS REQUIRED BY LOCAL REGULATIONS AND SHALL PAY ALL FEES ASSOCIATED WITH THESE PERMIT(S).
 8. VERIFY LOCATION OF CONTROLLER, WATER SUPPLY; SITE CONDITIONS MAY VARY. OPERABLE IRRIGATION EQUIPMENT (VALVES, QUICK COUPLERS, BFP, ETC.) SHALL BE INSTALLED SEPARATELY IN VALVE BOXES.
 9. ALL HEADS SHALL BE INSTALLED ON TRIPLE SWING JOINTS. HEADS SHALL BE NOT BE LOCATED CLOSER THAN 6" FROM PAVEMENT.
 10. ADJUST RADI AND SPRAY PATTERNS TO ELIMINATE OVERSPRAY ONTO BUILDINGS, SIDEWALKS, FENCES, DRIVEWAYS, ROADWAYS, ETC.
 11. ALL PAVEMENT CROSSINGS (LATERALS, WIRING, MAINLINE, ETC.) SHALL OCCUR WITHIN SLEEVES. INCLUDING SIDEWALKS, DRIVEWAYS, TRAILS, BIKE WAYS, ROADWAYS, ETC.
 12. PRIOR TO CONSTRUCTION, VERIFY WITH THE GENERAL CONTRACTOR AND ALL UTILITY COMPANIES THE EXACT LOCATION OF ALL UNDERGROUND UTILITIES. IMMEDIATELY REPORT ANY BREAKAGES TO THE APPROPRIATE UTILITY COMPANY.
 13. THE CONTRACTOR IS TO INSTALL ALL SLEEVES IN SEQUENCE WITH OTHER CONSTRUCTION ACTIVITIES, AND WILL BE RESPONSIBLE FOR COORDINATING WITH OTHER SITE CONTRACTORS FOR THIS WORK. ADEQUATELY MARK THE LOCATIONS OF ALL SLEEVES AND PIPE CONNECTION POINTS TO EXISTING LINES.
 14. INSTALL THE MAIN LINE A MINIMUM OF 15" DEEP AND LATERAL LINES MIN. 12" DEEP.
 15. PROVIDE A NEW WATER PROOF TAG WITH CONTRACTOR'S NAME AND TELEPHONE NUMBER CLEARLY SHOWN AND SECURELY ATTACHED TO THE INSIDE OF THE CONTROLLER DOOR.

TREE MITIGATION/REPLACEMENT LIST											
TREE TAG	TREE TYPE	SIZE (INCHES)				TOTAL CALIPER (INCHES)	REPLACEMENT FACTOR	REPLACEMENT INCHES REQUIRED	REASON FOR REMOVAL/MITIGATION	REPLACEMENT TREE TYPE	PROPOSED TREE CALIPER (INCHES)
16910	Chinaberry	9.00				9.0	0%	-	Invasive		
16912	Ligustrum	8.00	6.0			11.0	0%	-	Invasive		
20033	Chinaberry	9.00				9.0	0%	-	Invasive		
20038	Chinaberry	15.00				15.0	0%	-	Invasive		
20047	Live Oak	12.00				12.0	25%	3.00	Construction	MEXICAN SYCAMORE	4.00
20088	Live Oak	14.00				14.0	25%	3.50	Construction	MEXICAN SYCAMORE	4.00
20089	Live Oak	11.00				11.0	0%	-	Construction		
20093	Live Oak	18.00				18.0	25%	4.50	Construction	CEDAR ELM	6.00
20094	Live Oak	12.00				12.0	25%	3.00	Construction	MEXICAN SYCAMORE	4.00
20095	Live Oak	10.00				10.0	0%	-	Construction		
20096	Live Oak	11.00				11.0	0%	-	Construction		
20097	Live Oak	9.00				9.0	0%	-	Construction		
20098	Live Oak	12.00				12.0	25%	3.00	Construction	MEXICAN SYCAMORE	4.00
20099	Live Oak	15.00				15.0	25%	3.75	Construction	TEXAS ASH	4.00
20100	Live Oak	12.00				12.0	25%	3.00	Construction	TEXAS ASH	4.00
20101	Live Oak	13.00				13.0	25%	3.25	Construction	TEXAS ASH	4.00
20102	Live Oak*	19.00	17.0			27.5	25%	6.00	Construction	CEDAR ELM	6.00
20103	Live Oak	20.00				20.0	25%	5.00	Construction	CEDAR ELM	6.00
20105	Cedar Elm	15.00				15.0	25%	3.75	Construction	CEDAR ELM	4.00
20106	Live Oak	10.00				10.0	0%	-	Construction		
20107	Live Oak	12.00				12.0	25%	3.00	Construction	CEDAR ELM	4.00
20108	Live Oak	7.00				7.0	0%	-	Construction		
20109	Live Oak	12.00				12.0	25%	3.00	Construction	TEXAS ASH	4.00
						TOTAL INCHES REMOVED	296.50	TOTAL REPLACEMENT INCHES REQUIRED	33.75	TOTAL REPLACEMENT INCHES PROVIDED	40.00

* Only replacing 6" maximum, as allowed by code

NOTE: TOTAL CALIPER OF REPLACEMENT INCHES MUST EQUAL REQUIRED INCHES AS MEASURED AT DBH.

PLANT LIST			
COMMON NAME	BOTANICAL NAME	SIZE	COMMENT
CEDAR ELM	ULMUS CRASSIFOLIA	6" CALIPER	12' HT., SINGLE TRUNK, B&B OR CONTAINER/BOX
CEDAR ELM	ULMUS CRASSIFOLIA	4" CALIPER	12' HT., SINGLE TRUNK, B&B OR CONTAINER/BOX
MEXICAN SYCAMORE	PLATANUS MEXICANA	4" CALIPER	12' HT., SINGLE TRUNK, B&B OR CONTAINER/BOX
TEXAS ASH	FRAXINUS TEXENSIS	4" CALIPER	12' HT., SINGLE TRUNK, B&B OR CONTAINER/BOX
BLUE MISTFLOWER	CONOCLINIUM COELESTINUM	1 GAL	EQUAL SPACING
BIG MUHLY	MUHLENBERGIA LINDHEIMERI	1 GAL	EQUAL SPACING
OBEDIENT PLANT	PHYSOSTEGIA VIRGINIANA	1 GAL	EQUAL SPACING
BERMUDA SOD	CYNODON DACTYLON	SOD	AS SHOWN

NO.	DATE	DESCRIPTION	BY

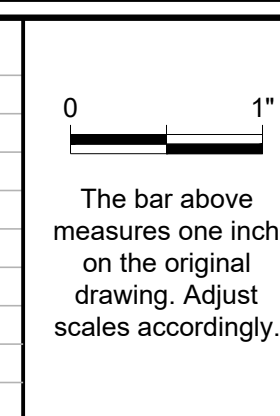

LANDSCAPE NOTES & CALCULATIONS

Western Hills Athletic Club
4801 Rollingwood Drive
Austin, TX 78746

PLOTTED: 7/7/2020
JOB NO: 863-01

700

22 OF 26

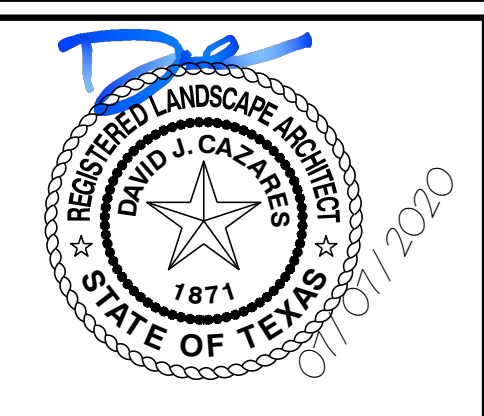

mwm Design Group

305 East Huntland Drive
Suite 200
Austin, Texas 78752
p: 512.453.0767
f: 512.453.1734

TBAE FIRM REGISTRATION NO.: 14527
TBRE FIRM REGISTRATION NO.: F-14116
TBPLS FIRM REGISTRATION NO.: 10065600

File: Y:\B63-01_WHP_Atletic_Club\CAD\Sheets\700_Landscape_Notes.dwg 22x34

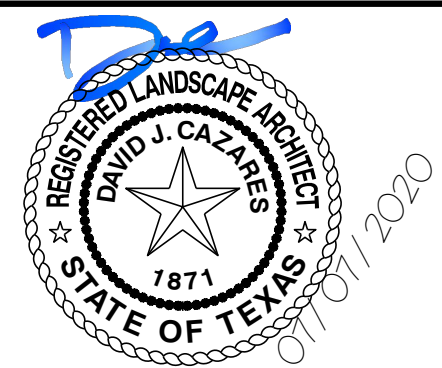
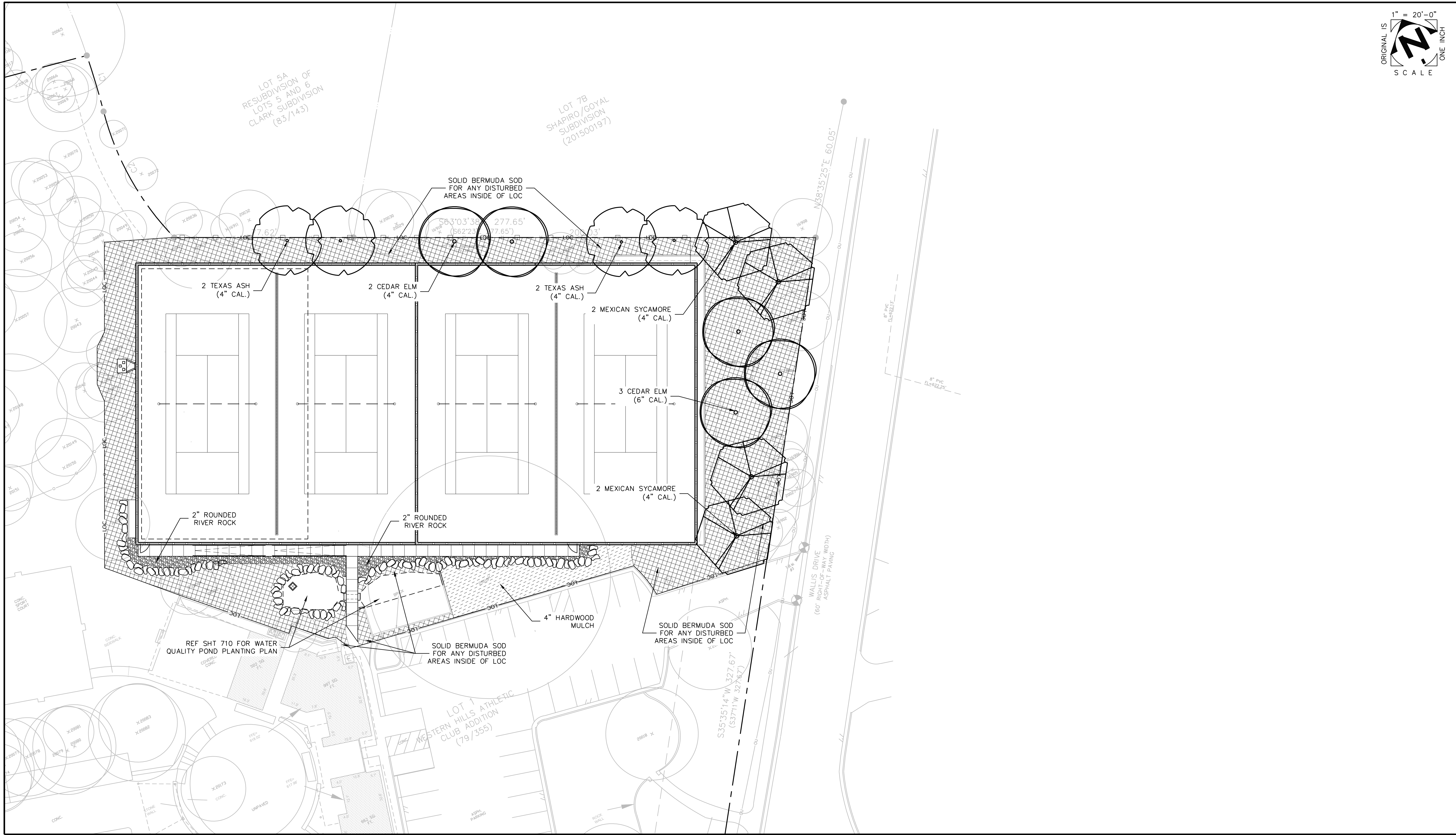
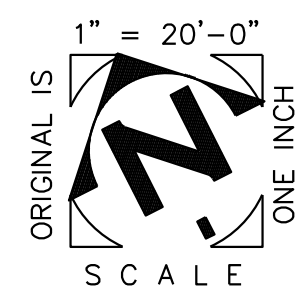

mwm
Design Group

305 East Huntland Drive
Suite 200
Austin, Texas 78752
p: 512.453.0767
f: 512.453.1734

TBAE FIRM REGISTRATION NO.: 1452
TBRF FIRM REGISTRATION NO.: F-1416
TBPLS FIRM REGISTRATION NO.: 10065600

NO.	DATE	DESCRIPTION	BY

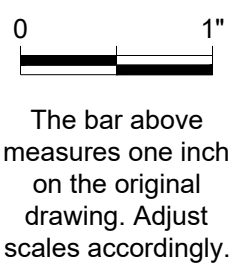

LANDSCAPE PLAN

Western Hills Athletic Club
4801 Rollingwood Drive
Austin, TX 78746

PLOTTED: 7/7/2020
JOB NO: 863-01

701

23 OF 26

File: Y:\863-01_WHP_Athletic_Club\CAD_Sheets\701_Landscape_Plan.dwg 22x34

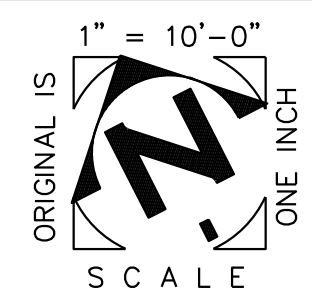
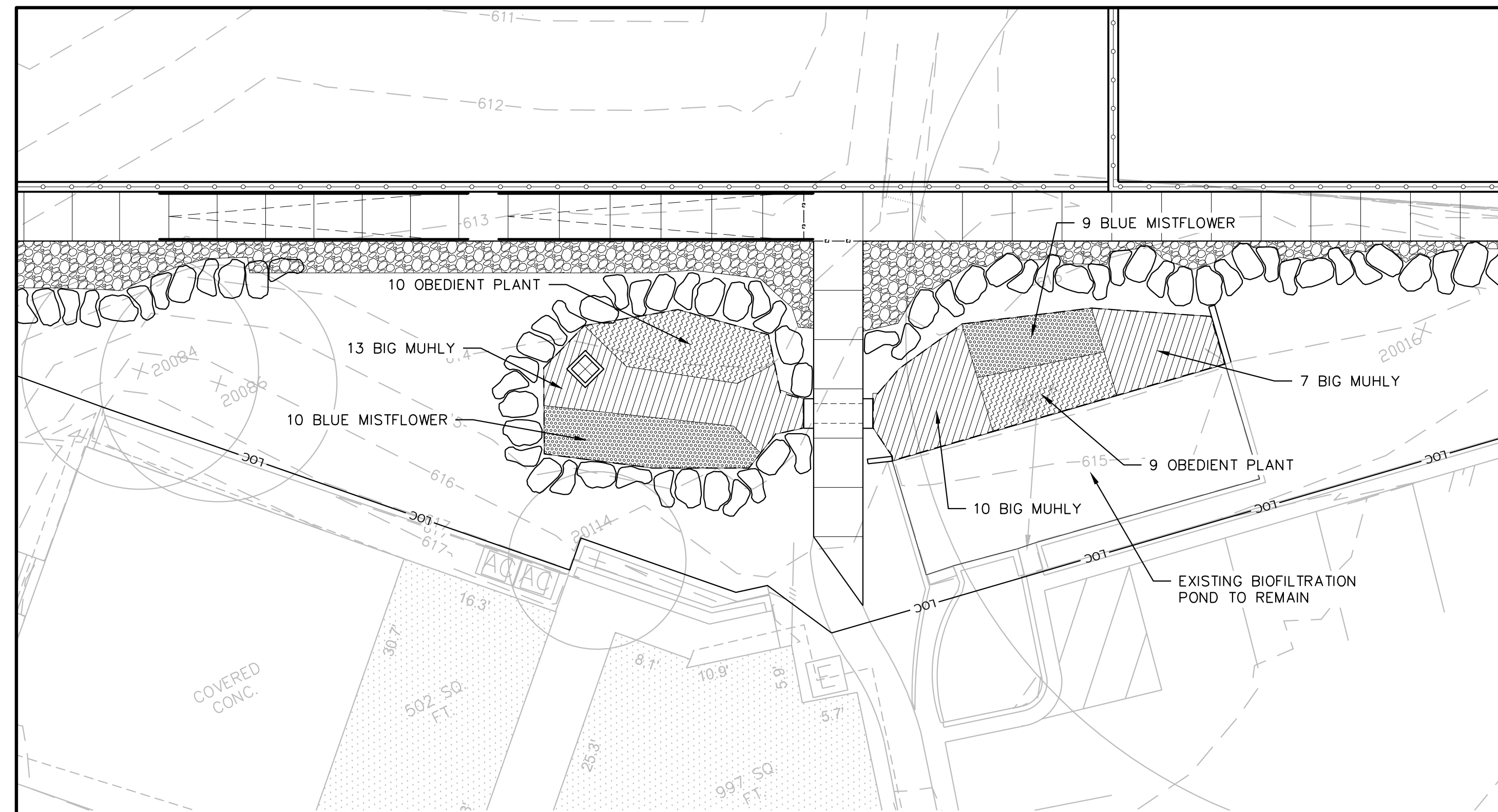

RAIN GARDEN CALCULATIONS			6-Apr-20
Biofiltration Pond Bottom	660	sf	
Biofiltration Pond Landscape		Size	Quantity
Obedient Plant		1 Gallon	19
Blue Mistflower		1 Gallon	19
Big Muhly		1 Gallon	30
			68

mwm
Design Group

305 East Huntland Drive
Suite 200
Austin, Texas 78752
p: 512.453.0767
f: 512.453.1734

TBAE FIRM REGISTRATION NO.: 1452
TBRE FIRM REGISTRATION NO.: F-1416
TBPLS FIRM REGISTRATION NO.: 10065600

NO.	DATE	DESCRIPTION	BY

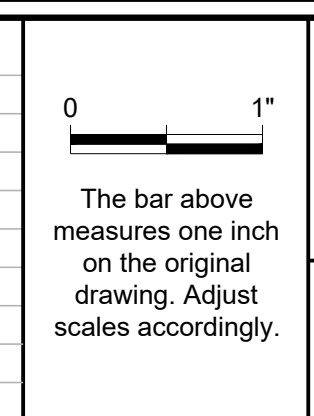

WATER QUALITY POND PLANTING PLAN

Western Hills Athletic Club
4801 Rollingwood Drive
Austin, TX 78746

PLOTTED: 7/7/2020
JOB NO: 863-01

710

24 OF 26

File: Y:\863-01_WHP_Athletic_Club\CAD\Sheets\710_Water_Quality_Pond_Planting_Plan.dwg 22x34

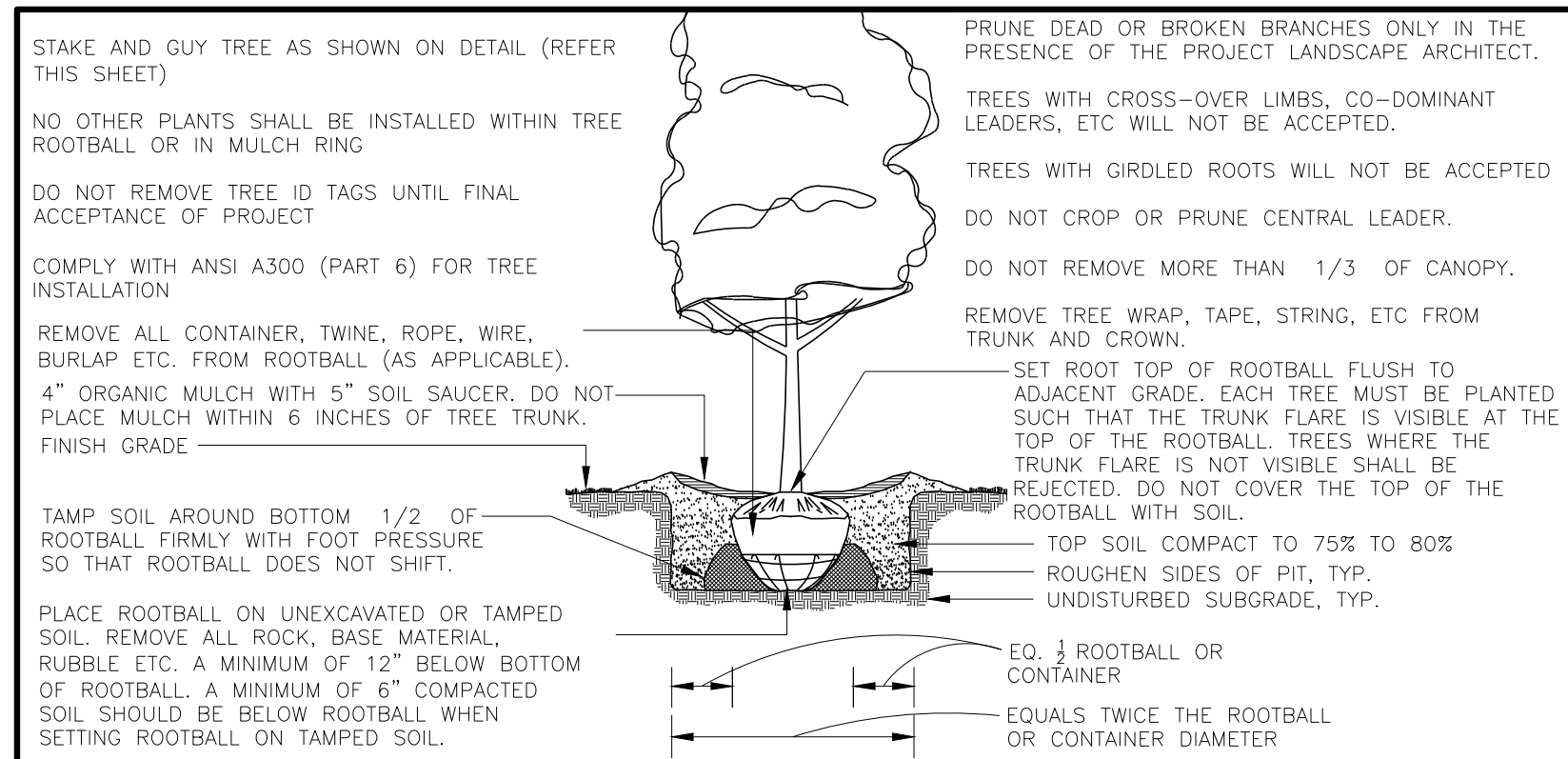

1 TREE PLANTING DETAIL (SINGLE TRUNK) GREATER THAN 3" CALIPER NO SCALE

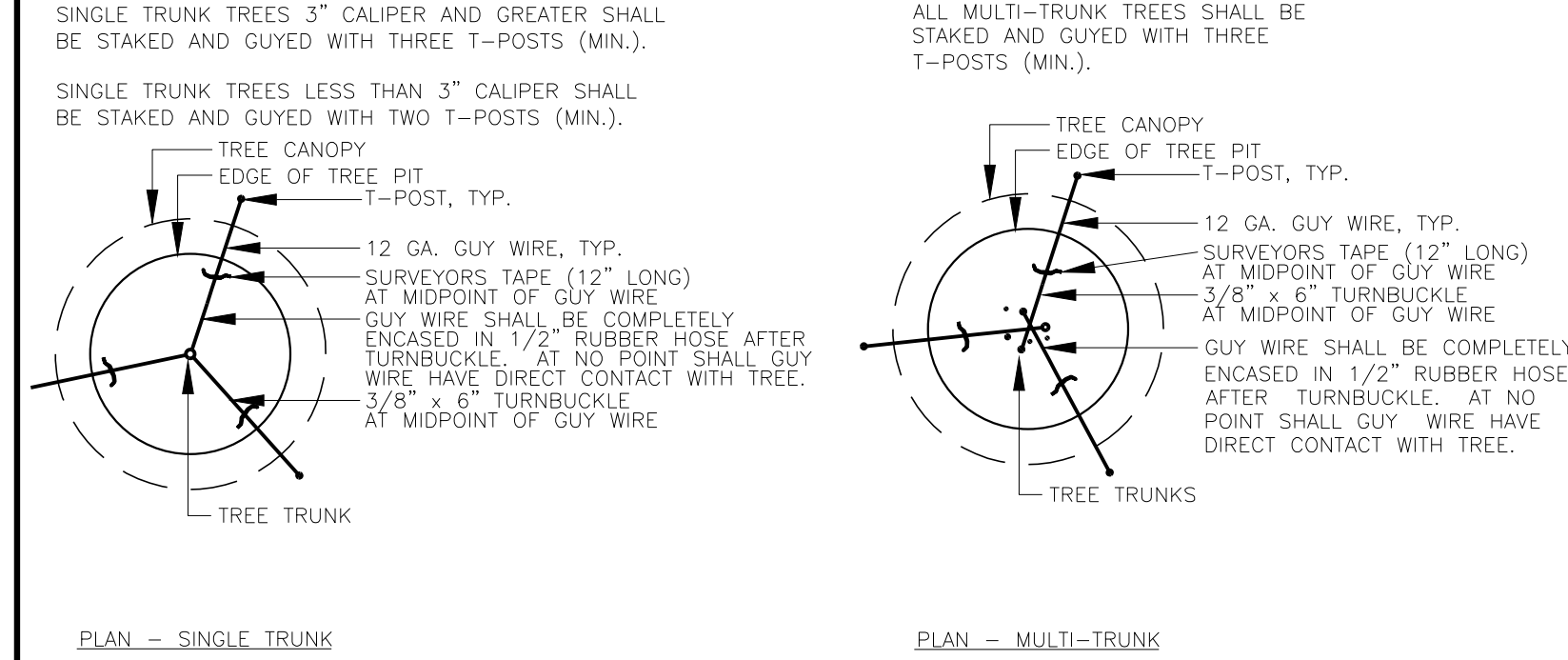

2 TREE STAKING DETAIL NO SCALE

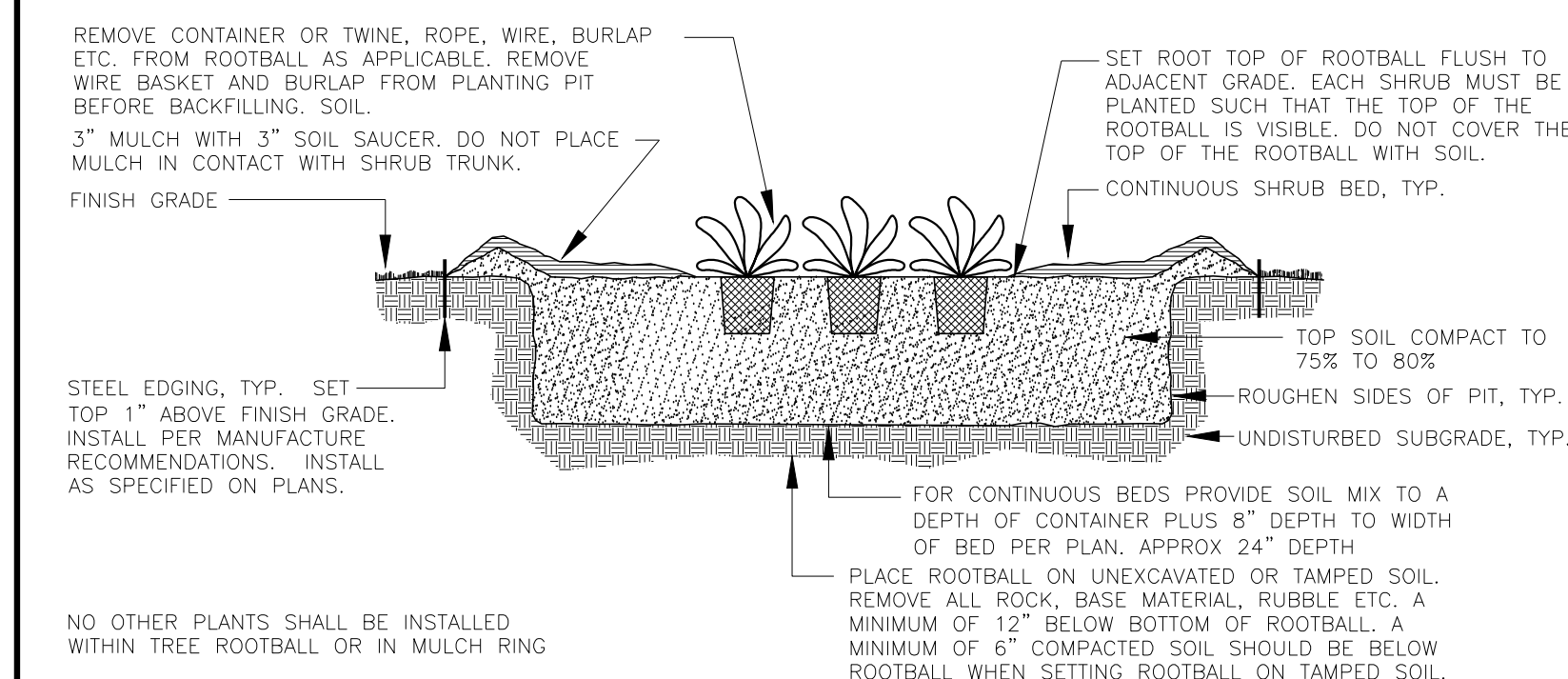

3 PERENNIAL / GROUNDCOVER PLANTING DETAIL NO SCALE

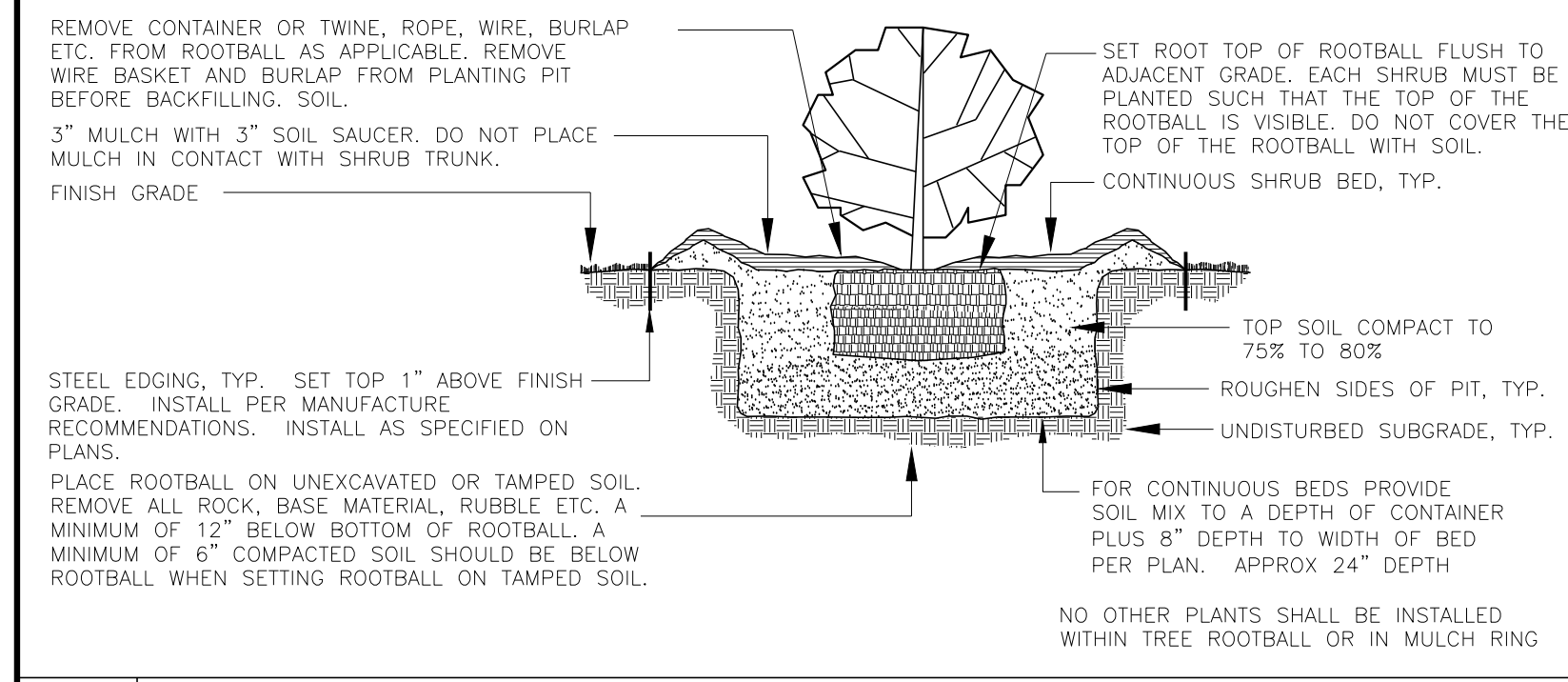

4 SHRUB PLANTING DETAIL NO SCALE

	<p>305 East Huntland Drive Suite 200 Austin, Texas 78752 p: 512.453.0767 f: 512.453.1734</p> <p>TBAE FIRM REGISTRATION NO.: 1452 TBE FIRM REGISTRATION NO.: F-14116 TBLPS FIRM REGISTRATION NO.: 10065000</p>	NO.	DATE	DESCRIPTION	BY	<p>The bar above measures one inch on the original drawing. Adjust scales accordingly.</p>	<h1>LANDSCAPE DETAILS</h1> <p>Western Hills Athletic Club 4801 Rollingwood Drive Austin, TX 78746</p>	PLOTTED: 7/7/2020 JOB NO: 863-01
		<h1>791</h1> <p>25 OF 26</p>						

File: Y:\863-01_WHP_Athletic_Club\CAD\Sheets\791_Landscape_Details.dwg 22x34

ORIGINAL IS
1" = 20'-0"
SCALE
ONE INCH

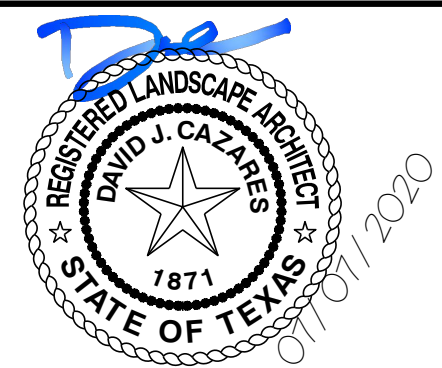
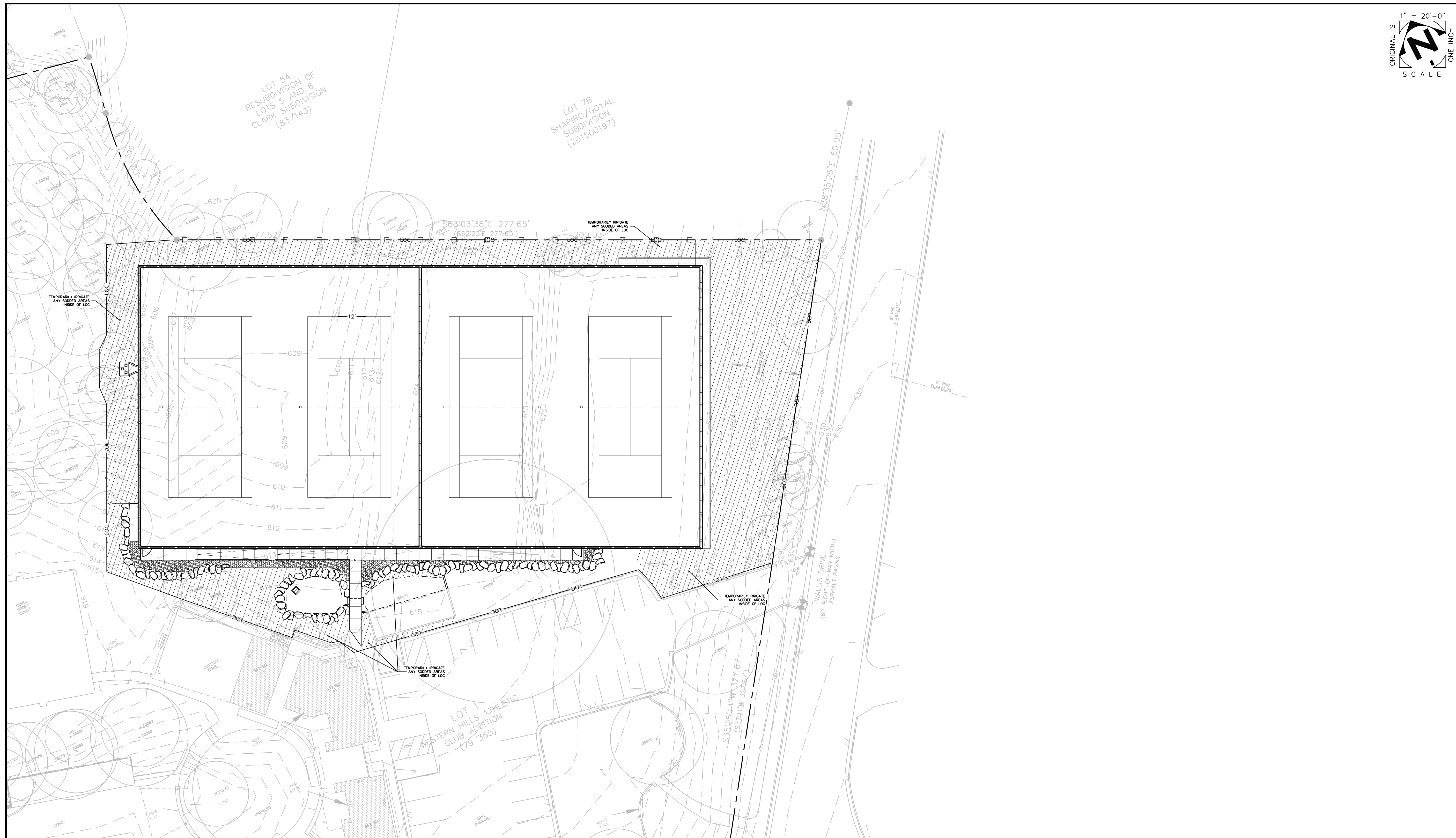

305 East Huntland Drive
Suite 200
Austin, Texas 78752
p: 512.453.0767
f: 512.453.1734

TBAE FIRM REGISTRATION NO.: 1452
TBEF FIRM REGISTRATION NO.: F-1416
TBPLS FIRM REGISTRATION NO.: 10065600

NO.	DATE	DESCRIPTION	BY

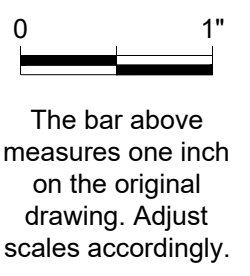

IRRIGATION PLAN

Western Hills Athletic Club
4801 Rollingwood Drive
Austin, TX 78746

PLOTTED: 7/7/2020
JOB NO: 863-01

801

26 OF 26

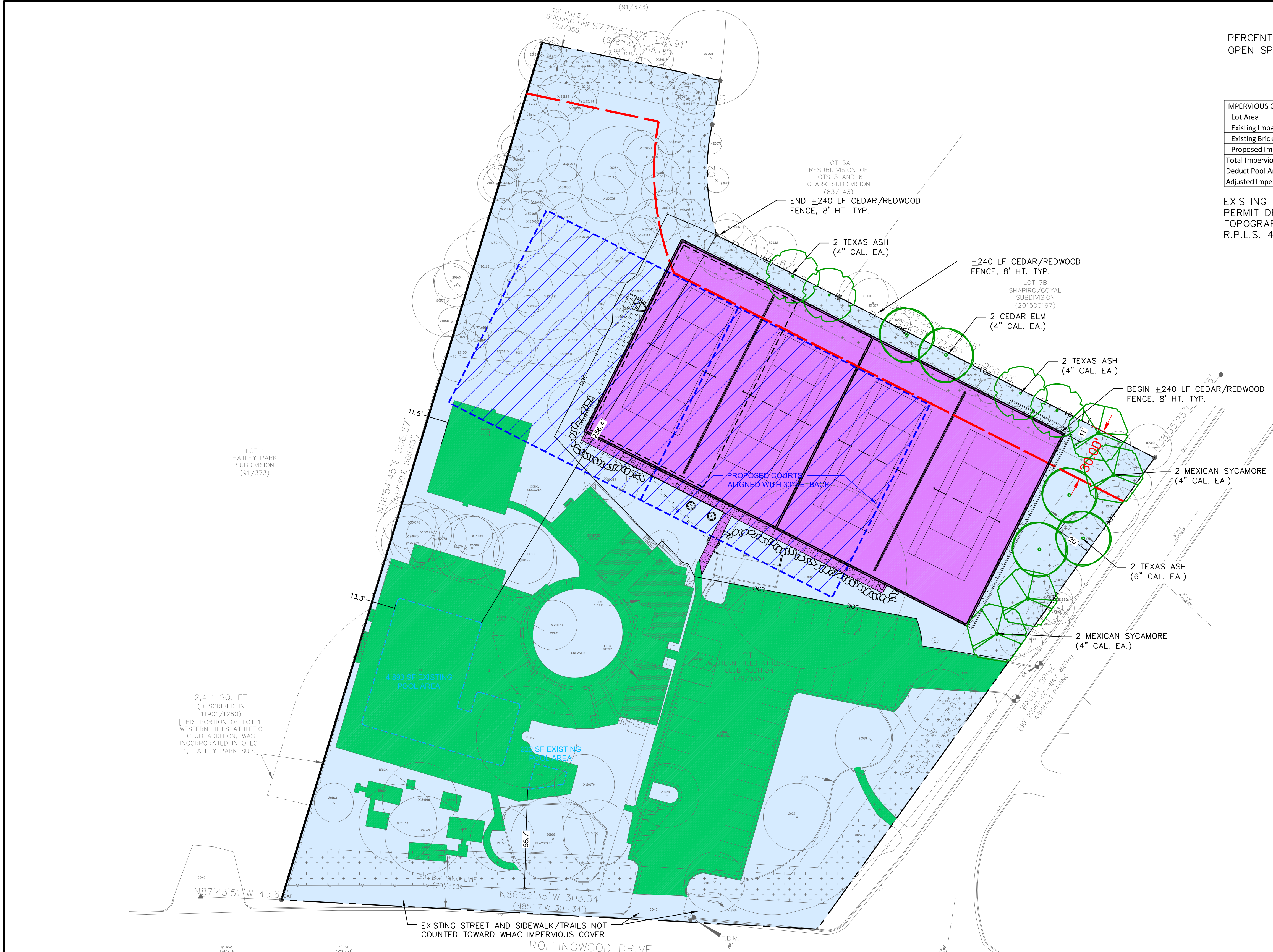

PERCENT OF LOT DEDICATED TO OPEN SPACE 50.09% (70,092 SF)

LANDSCAPE BUFFER CALCULATIONS		
20' Buffer (107-341(e))	19,658.00	SF
1 Tree / 500 SF Required	39	Required
Existing Trees	31	Trees
Provided Trees	13	Trees
Total Trees	44	Trees

IMPERVIOUS COVER CALCULATIONS				
Lot Area	139,928.00	SF	3.21	AC
Existing Impervious Cov to Remain	37,777.00	SF	100%	37,777.00 SF
Existing Brick Impervious Paving	964.00	SF	75%	723.00 SF
Proposed Impervious Cov	31,336.00	SF	100%	31,336.00 SF
Total Impervious Cover	69,836.00			49.91% 50% Allowed; Ref 107-244(a)
Deduct Pool Areas (4,893 sf + 222 sf)	(5,115.00)			
Adjusted Impervious Cover	64,721.00			46.25%

EXISTING CONDITIONS, IMPERVIOUS COVER CALCULATIONS, DRAINAGE CALCULATIONS, PERMIT DRAWINGS AND CONSTRUCTION DRAWINGS ARE BASED ON THE TOPOGRAPHIC, TREE AND BOUNDARY SURVEY SEALED BY ROBERT C. WATTS, JR. R.P.L.S. 4995 ON 10 MAY 2018.

EXISTING LOT AREA

EXISTING IMPERVIOUS COVER

PROPOSED IMPERVIOUS COVER

20' LANDSCAPE BUFFER REF 107-341(E)

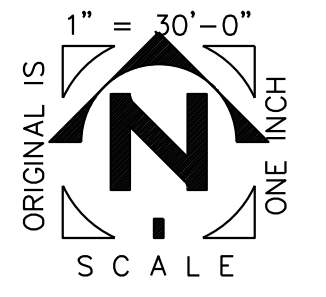

mwm DesignGroup

305 East Huntland Drive
Suite 200
Austin, Texas 78752
p: 512.453.0767
f: 512.453.1734

TBAE FIRM REGISTRATION NO.: 1452
TBPE FIRM REGISTRATION NO.: F-1416
TBPLS FIRM REGISTRATION NO.: 10065600

NO.	DATE	DESCRIPTION	BY

0 1"

The bar above measures one inch on the original drawing. Adjust scales accordingly.

IMPERVIOUS COVER CALCULATION FENCE AND TREE PLAN

Western Hills Athletic Club
4801 Rollingwood Drive
Austin, TX 78746

PLOTTED: 6/17/2021
JOB NO: 863-01

100

4 OF 26