

Pineville Industrial Development

Traffic Impact Analysis

Pineville, North Carolina

January 12, 2018

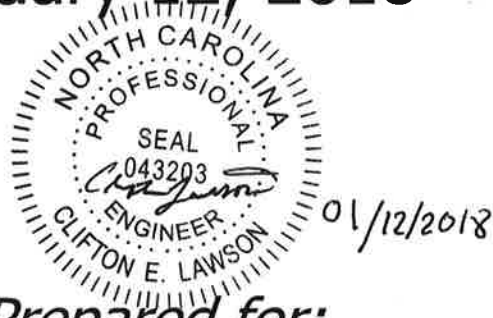

Prepared for:

MPV Properties, LLC

TIMMONS GROUP

YOUR VISION ACHIEVED THROUGH OURS.



Contact: Cliff Lawson, PE, PTOE

5410 Trinity Road, Suite 102 • Raleigh, NC 27607
(919) 866-4951 phone • (919) 859-5663 fax
www.timmons.com

TABLE OF CONTENTS

TABLE OF CONTENTS.....I

LIST OF TABLES..... II

LIST OF FIGURESIII

APPENDICESIII

1 INTRODUCTION1-1

2 EXISTING INFORMATION2-1

 2.1 STUDY LIMITS2-1

 2.2 EXISTING ROADWAYS2-1

 2.3 EXISTING INTERSECTIONS / RAILROAD CROSSINGS2-1

 2.4 TRAFFIC VOLUMES2-2

 2.5 AREA SAFETY REVIEW2-2

 2.6 CAPACITY ANALYSIS2-2

3 EXISTING AND BACKGROUND CONDITIONS AND ANALYSIS3-1

3.1 2017 EXISTING ANALYSES.....3-1

3.2 2021 BACKGROUND TRAFFIC VOLUMES3-3

3.3 2021 BACKGROUND ANALYSIS.....3-3

4 SITE TRIP GENERATION AND DISTRIBUTION4-1

4.1 TRIP GENERATION4-1

4.2 TRIP DISTRIBUTION4-1

5 2021 BUILD CONDITION AND ANALYSIS.....5-1

5.1 2021 BUILD TRAFFIC VOLUMES.....5-1

5.2 2021 BUILD ANALYSIS.....5-1

5.3 RAILROAD CROSSING.....5-5

6 CONCLUSIONS AND RECOMMENDATIONS6-1

LIST OF TABLES

TABLE 2-1: CRASH INFORMATION 2-2

TABLE 2-2: LEVEL OF SERVICE DEFINITIONS 2-3

TABLE 2-3: SIGNALIZED AND UNSIGNALIZED INTERSECTION LEVEL OF SERVICE CRITERIA 2-4

TABLE 3-1: INTERSECTION LEVEL OF SERVICE, DELAY AND 95TH PERCENTILE QUEUE SUMMARY

 2017 EXISTING TRAFFIC VOLUMES 3-2

TABLE 3-2A: INTERSECTION LEVEL OF SERVICE, DELAY AND 95TH PERCENTILE QUEUE SUMMARY

 2019 PHASE I BACKGROUND TRAFFIC VOLUMES 3-4

TABLE 3-2B: INTERSECTION LEVEL OF SERVICE, DELAY AND 95TH PERCENTILE QUEUE SUMMARY

 2024 PHASE II BACKGROUND TRAFFIC VOLUMES 3-6

TABLE 4-1A: 2019 PHASE I TRIP GENERATION SUMMARY 4-1

TABLE 4-1B: 2024 PHASE II TRIP GENERATION SUMMARY 4-1

TABLE 5-1A: INTERSECTION LEVEL OF SERVICE, DELAY AND 95TH PERCENTILE QUEUE SUMMARY

 2019 PHASE I BUILD TRAFFIC VOLUMES 5-3

TABLE 5-1B: INTERSECTION LEVEL OF SERVICE, DELAY AND 95TH PERCENTILE QUEUE SUMMARY

 2024 PHASE II BUILD TRAFFIC VOLUMES 5-5

LIST OF FIGURES

- FIGURE 1-1: SITE LOCATION MAP
- FIGURE 2-1: SURROUNDING ROADWAY NETWORK
- FIGURE 2-2: PRELIMINARY SITE LAYOUT
- FIGURE 2-3: EXISTING LANE CONFIGURATION
- FIGURE 2-4: 2017 EXISTING TRAFFIC VOLUMES
- FIGURE 3-1: APPROVED DEVELOPMENT TRAFFIC VOLUMES
- FIGURE 3-2: 2019 PHASE I BACKGROUND TRAFFIC VOLUMES
- FIGURE 3-3: 2024 PHASE II BACKGROUND TRAFFIC VOLUMES
- FIGURE 4-1: TRIP DISTRIBUTION PERCENTAGES
- FIGURE 4-2: 2019 PHASE I TRIP DISTRIBUTION VOLUMES
- FIGURE 4-3: 2024 PHASE I TRIP DISTRIBUTION VOLUMES
- FIGURE 5-1: 2019 PHASE I BUILD TRAFFIC VOLUMES
- FIGURE 5-2: 2024 PHASE I BUILD TRAFFIC VOLUMES

APPENDICES

- Appendix A – Traffic Counts
- Appendix B – Accident Data
- Appendix C – Traffic Signal Plans
- Appendix D – Synchro / SimTraffic Analysis Outputs
- Appendix E – Approved Developments

1 INTRODUCTION

This report presents the findings of the traffic impact analysis for the proposed Pineville Industrial Development (Phases I and II). The development will be located off Industrial Drive, in Pineville, NC (see **Figure 1-1**) and will consist of a 510,000 square-foot (SF) warehousing building to be constructed in 2019 as part of Phase I and a 340,000 SF industrial building to be constructed in 2024 as part of Phase II.

Analyses were completed for the 2017 Existing traffic volumes and the 2019 and 2024 (Phases I & II) Background and Build traffic volumes (background + site trips). The purpose of this assessment is as follows:

1. Verify that the existing geometry provided within the study area is sufficient to accommodate the projected traffic volumes; and
2. Determine what, if any, improvements are necessary at the proposed site driveway connection to Industrial Drive, the intersections of Industrial Drive / Pineville Road / Polk Street and Industrial Drive / Rodney Street, as well as the two railroad crossings of Industrial Drive.

The following steps were taken to determine the potential traffic impacts associated with this project:

1. Data Collection – AM (7:00 – 9:00) and PM (4:00 – 6:00) peak hour turning movement counts were collected in May and October 2017 at the following four (4) intersections / crossings:
 - Industrial Drive / Pineville Road / Polk Street (signalized);
 - Industrial Drive / Rodney Street (unsignalized);
 - Industrial Drive / Northern Railroad Crossing* (unsignalized); and
 - Industrial Drive / Southern Railroad Crossing*(signalized);

*Railroad Crossings of Industrial Drive.

2. Trip Generation/Future Traffic – Traffic generated by the proposed development was estimated using the 9th edition of the Institute of Transportation Engineers' *Trip Generation Manual*. Trip generation was calculated using the total square footage (510,000 SF & 340,000 SF respectively) as the independent variable, as well as the average rate and the equation (per NCDOT guidelines). Projected future traffic volumes were calculated using a 2% ambient growth rate and site trips from the adjacent residential development
3. Trip Distribution and Projections – The distribution of site-generated trips was based on the distribution of existing area traffic. It was assumed, for purposes of analysis, that projected trips would follow the same patterns as existing traffic.
4. Traffic Capacity Analysis – Level of service analyses were performed using SYNCHRO Version 9.1 (Build 912, Rev 4) for the following intersections:
 - Industrial Drive / Pineville Road / Polk Street;
 - Industrial Drive / Rodney Street; and
 - Site Driveway #1 / Industrial Drive.

Additionally, queue lengths along industrial drive were observed / recorded to determine if there were any impacts to the two railroad crossings with Industrial Drive.

5. Queuing Analysis – The 95th percentile queue lengths from the capacity analyses were analyzed at the intersections listed above.
6. Review of Proposed Improvements – Roadway / railroad crossing improvements proposed to accommodate projected site-generated traffic were evaluated (if applicable).



NOT TO SCALE

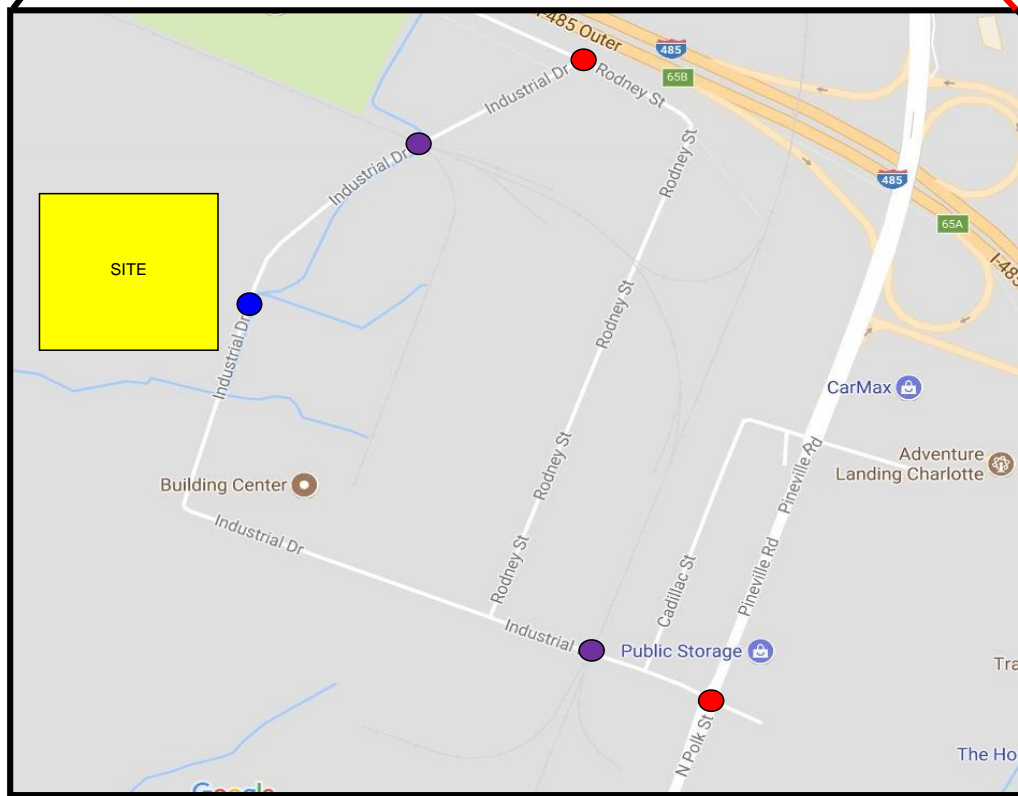
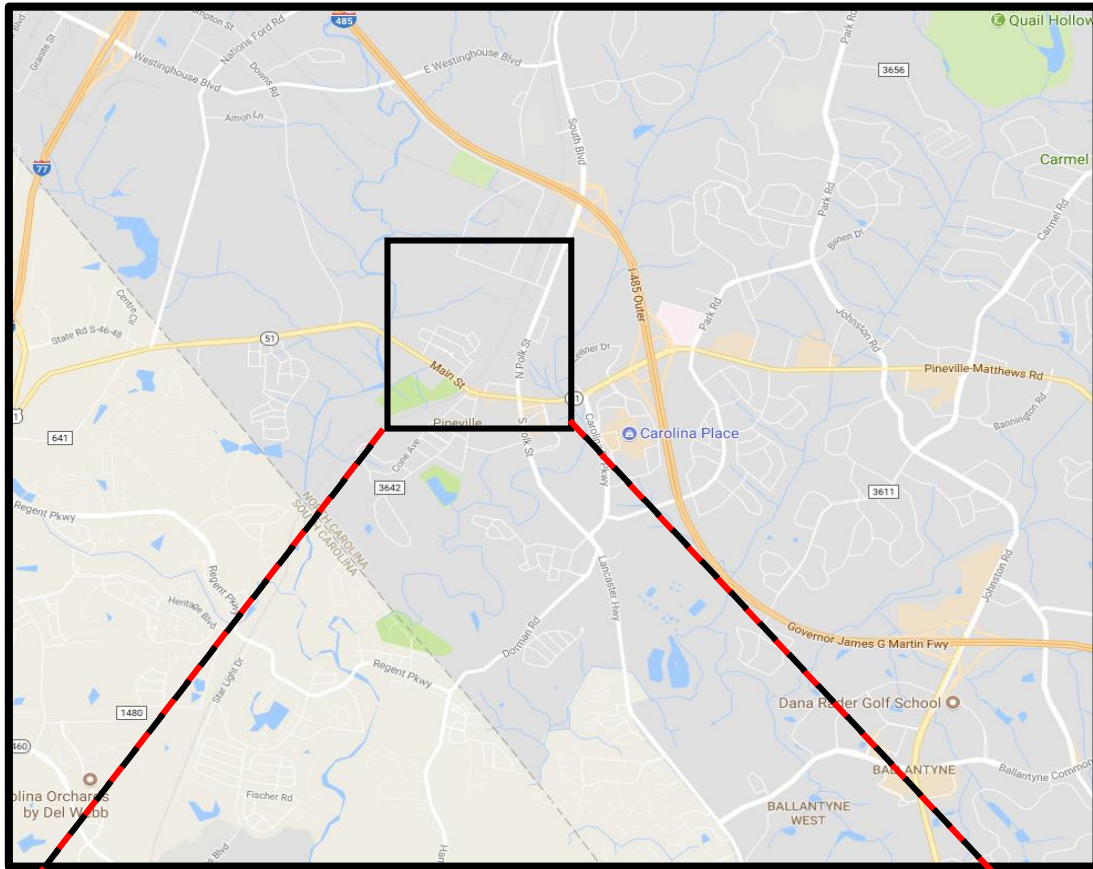

- Legend**
- = Study Area Intersection
 - = Driveway Intersection
 - = Railroad Crossing



Pineville Industrial Development Traffic Impact Analysis Site Location Map

Figure
1-1

2 EXISTING INFORMATION

The proposed development will be located off Industrial Drive west of Polk Street / Pineville Road, in Pineville, NC, as shown on **Figure 1-1**.

2.1 STUDY LIMITS

Access to the proposed site will be provided through one site driveway connection to the outside roadway network made via Industrial Drive (Site Driveway #1). Site Driveway #1 will be located approximately 2,500' (C/L to C/L) south of Rodney Street, approximately 1,650' (C/L to C/L) south of the northern railroad crossing, and approximately 2,715' (C/L to C/L) northwest of the southern railroad crossing. The northern railroad crossing is located approximately 875' (C/L to C/L) south of Rodney Street. Finally, the southern railroad crossing is located approximately 600' (C/L to C/L) west of Pineville Road / Polk Street.

The proposed entrance is shown graphically on **Figure 2-1** (all figures are located at the end of their respective chapter). **Figure 2-2** includes the preliminary site layout for the industrial development.

The study limits include the following five (5) intersections / crossings:

1. Industrial Drive / Pineville Road / Polk Street
2. Industrial Drive / Rodney Street
3. Industrial Drive / Southern Railroad Crossing*
4. Industrial Drive / Northern Railroad Crossing*
5. Site Driveway #1 / Industrial Drive

*Existing railroad crossing of Industrial Drive.

2.2 EXISTING ROADWAYS

SR 4982 (Polk Street / Pineville Road) is a four-lane facility that runs north-south, east of the project study area. The facility has a posted 45-mph speed limit and serves residential and commercial developments as well as commuter traffic. Polk Street / Pineville Road stretches from downtown Charlotte (beginning as Caldwell Street) southward to US-521 (changing names to Lancaster Highway).

Industrial Drive is a two-lane facility that runs approximately north-south in front of the proposed site before turning east-west to intersect Pineville Road / Polk Street. The facility has a posted 35-mph speed limit and primarily services the existing industrial park. Industrial Drive runs from Rodney Street to the northwest to Polk Street / Pineville Road to the east.

Rodney Street is a two-lane facility that runs approximated east-west, north of the project study area. The facility has a posted 35-mph speed limit and primarily services the existing industrial park. Rodney Street runs from Industrial Drive in the south to E Westinghouse Boulevard in the northwest.

2.3 EXISTING INTERSECTIONS / RAILROAD CROSSINGS

Using available aerial imagery and site visits, Timmons Group compiled the existing geometry for each of the study area intersections. The existing intersection geometry is shown on **Figure 2-3** and used throughout all analyses.

Polk Street / Pineville Road / Industrial Drive is an eight-phase signalized intersection with protected / permitted left-turn phasing for all four approaches. The north and southbound intersection approaches each include an exclusive left-turn lane, a through lane, and a shared through / right-turn lane. The east

and westbound approaches each include an exclusive left-turn lane and a shared through / right-turn lane.

Industrial Drive / Rodney Street is an unsignalized T-intersection with the northbound Industrial Drive approach encountering the stopped condition. The northbound approach consists of a shared left / right-turn lane. The eastbound approach consists of a shared through / right-turn lane. The westbound approach consists of a shared left-turn / through lane.

Industrial Drive / Northern Railroad Crossing is an unsignalized crossing including cross-buck signage denoting the crossing. At the crossing, Industrial Drive consists of a two-lane roadway section.

Industrial Drive / Southern Railroad Crossing is a signalized crossing including overhead flashers, gates, and cross-buck signage. At the crossing, Industrial Drive consists of a two-lane roadway section.

2.4 TRAFFIC VOLUMES

Timmons Group calculated peak hour volumes for the study area intersections using the AM (7:00 – 9:00) and PM (4:00 – 6:00) peak period turning movement counts undertaken in May and October 2017. Traffic count data is summarized in **Figure 2-4**. The complete traffic count data can be found in **Appendix A**.

2.5 AREA SAFETY REVIEW

Crash data for the past five-year period (2012 –2017) was provided by the NCDOT. Per **Table 2-1** below, the intersection of Industrial Drive / Pineville Road / Polk Street had 18 reported accidents. Crash data for the intersection of Industrial Drive / Rodney Street, was provided in December and showed only one accident occurring in 2005. No fatal crashes were reported at the intersection of Polk Street / Pineville Road / Industrial Drive or Industrial / Rodney Street. A crash summary (provided in **Appendix B**) has been included in **Table 2-1** below summarizing the number of crashes, type of crash (injury / property damage), and year of occurrence.

Table 2-1: Crash Information

Location	2012	2013	2014	2015	2016	2017	Injury	Property Damage
Polk Street / Pineville Road / Industrial Drive	2	4	7	8	4	3	10	18
Industrial Drive / Rodney Street	0	0	0	1	0	0	0	1

2.6 CAPACITY ANALYSIS

Using field observations, aerial photography, and traffic count data, traffic operations were analyzed during 2017 (existing) and 2019 / 2024 (without and with the proposed development site trips for Phases I & II).

Capacity analysis allows traffic engineers to determine the impacts of traffic on the surrounding roadway network. The Transportation Research Board's (TRB) *Highway Capacity Manual* (HCM) methodologies govern how the capacity analyses are conducted and how the results are interpreted. There are six letter grades of Levels of Service (LOS) from A to F, with LOS A representing the best operating conditions and LOS F the worst operating conditions. At signalized intersections, an overall intersection LOS E is generally considered unacceptable. At unsignalized intersections, a LOS E is generally considered acceptable only

if the side street encounters delay. Nevertheless, side streets typically function at a LOS F during peak traffic periods, because the traffic volumes often do not warrant a traffic signal to assist side street traffic. **Table 2-2** shows in detail how each of these levels of service are interpreted.

Table 2-2: Level of Service Definitions

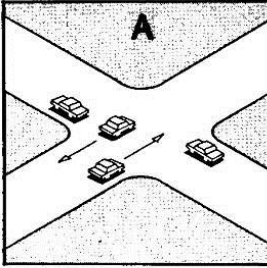
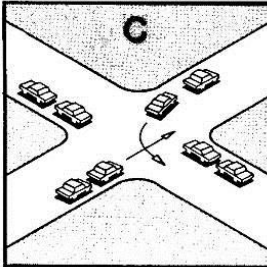
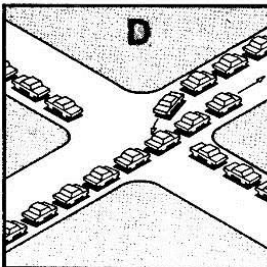
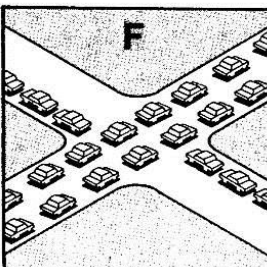
Level of Service	Roadway Segments or Controlled Access Highways	Intersections	
A	Free flow, low traffic density.	No vehicle waits longer than one signal indication.	
B	Delay is not unreasonable, stable traffic flow.	On a rare occasion motorists wait through more than one signal indication.	
C	Stable condition, movements somewhat restricted due to higher volumes, but not objectionable for motorists.	Intermittently drivers wait through more than one signal indication, and occasionally backups may develop behind left turning vehicles, traffic flow still stable and acceptable.	
D	Movements more restricted, queues and delays may occur during short peaks, but lower demands occur often enough to permit clearing, thus preventing excessive backups.	Delays at intersections may become extensive with some, especially left-turning vehicles waiting two or more signal indications, but enough cycles with lower demand occur to permit periodic clearance, thus preventing excessive backups.	
E	Actual capacity of the roadway involves delay to all motorists due to congestion.	Very long queues may create lengthy delays, especially for left-turning vehicles.	
F	Forced flow with demand volumes greater than capacity resulting in complete congestion. Volumes drop to zero in extreme cases.	Backups from locations downstream restrict or prevent movement of vehicles out of approach creating a storage area during part or all of an hour.	

SOURCE: "A Policy on Design of Design of Urban Highways and Arterial Streets" - AASHTO, 1973 based upon material published in "Highway Capacity Manual", National Academy of Sciences, 1965.

For signalized and unsignalized intersections, level of service is defined in terms of **delay**, a measure of driver discomfort, frustration, fuel consumption and lost travel time. **Table 2-3** summarizes the delay associated with each LOS category:

Table 2-3: Signalized and Unsignalized Intersection Level of Service Criteria

Signalized Intersections		Unsignalized Intersections	
Level of Service	Control Delay per Vehicle (sec/veh)	Level of Service	Average Control Delay (sec/veh)
A	≤ 10	A	0 to 10
B	> 10 to ≤ 20	B	> 10 to ≤ 15
C	> 20 to ≤ 35	C	> 15 to ≤ 25
D	> 35 to ≤ 55	D	> 25 to ≤ 35
E	> 55 to ≤ 80	E	> 35 to ≤ 50
F	> 80	F	> 50

Source: Exhibit 16-2 and Exhibit 17-2 from TRB's "Highway Capacity Manual 2000"



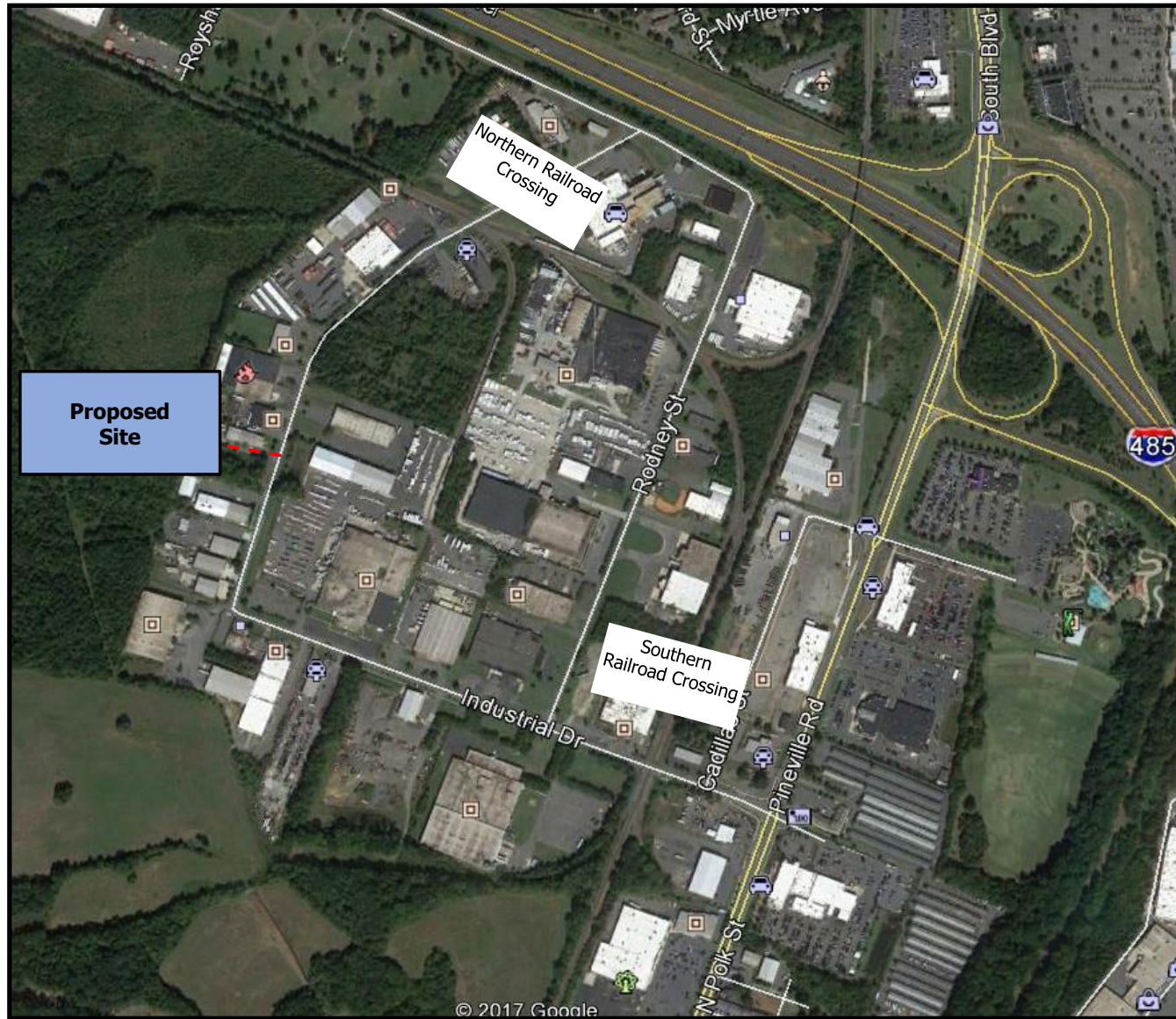

Capacity analyses were performed to assess operational conditions. Study area intersections were analyzed using SYNCHRO Version 9.1 (Build 912, Rev 4) based on Highway Capacity Manual (HCM) methodologies with the following assumptions:

- Existing grades;
- 12-foot lane widths;
- No parking activity, bus stops, or pedestrians;
- Peak hour factor (PHF) of 0.90;
- Heavy vehicle percentages 2%; and
- Existing green splits with timing values found in the provided traffic signal plans (see **Appendix C**).



 NOT TO SCALE

LEGEND:

	Existing Road
	Proposed Road
	Proposed Site
	Adjacent Site



Pineville Industrial Development
Traffic Impact Analysis
 Surrounding Road Network

Figure 2-1



SITE PLAN

Industrial Drive - June 23, 2017

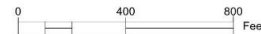

Pineville Industrial Development Traffic Impact Analysis Preliminary Site Layout

Figure 2-2

LEGEND:

- Existing Road
- - - Proposed Road
- 🚦 Signalized Intersection
- 🛑 Unsignalized Intersection
- ↷ Lane Configuration

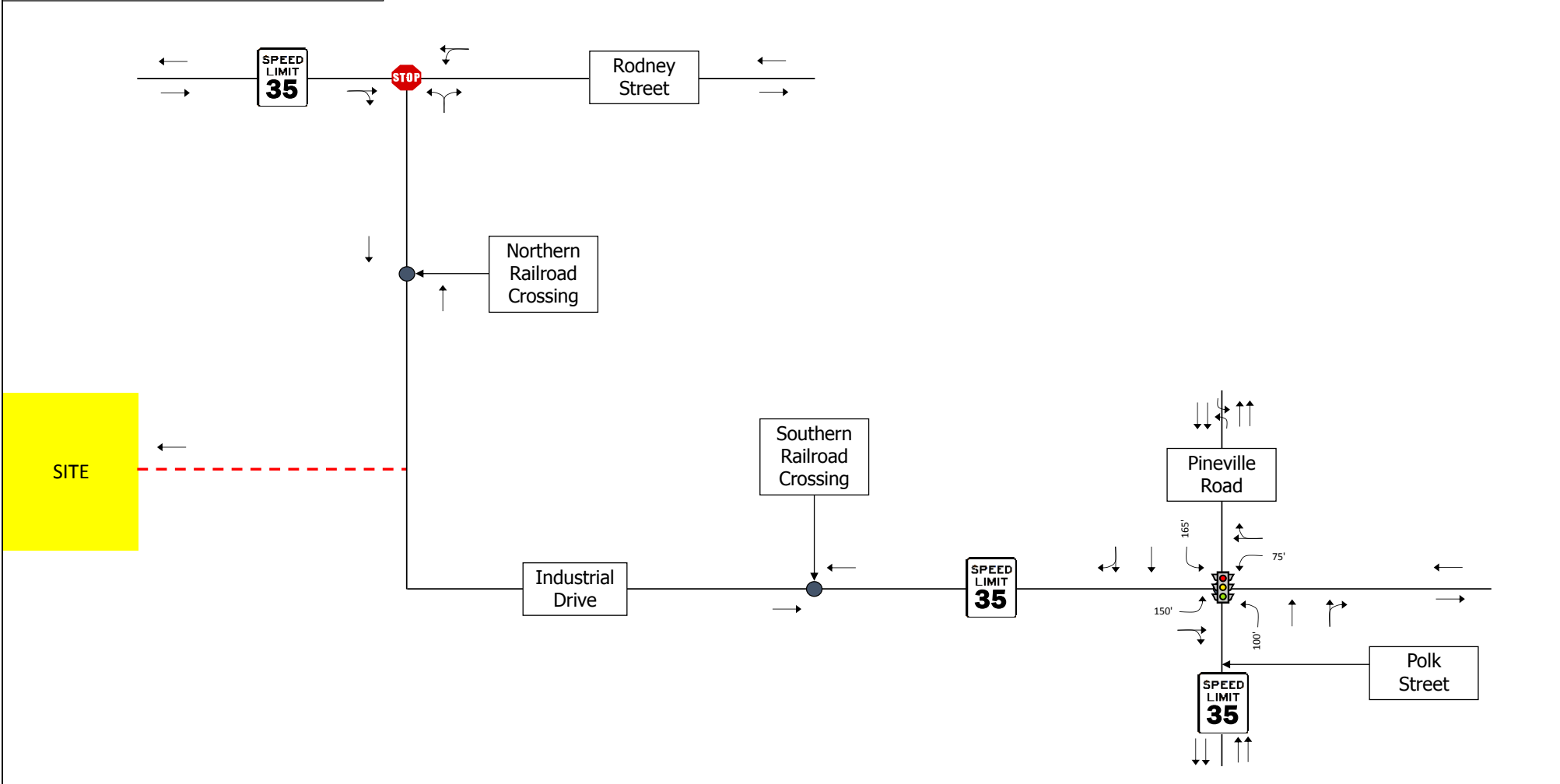

**Pineville Industrial Development
Traffic Impact Analysis
2017 Existing Lane Configuration**

Figure 2-3

LEGEND:

- Existing Road
- - - Proposed Road
- XX AM Peak Hour Volume (vph)
- (XX) PM Peak Hour Volume (vph)

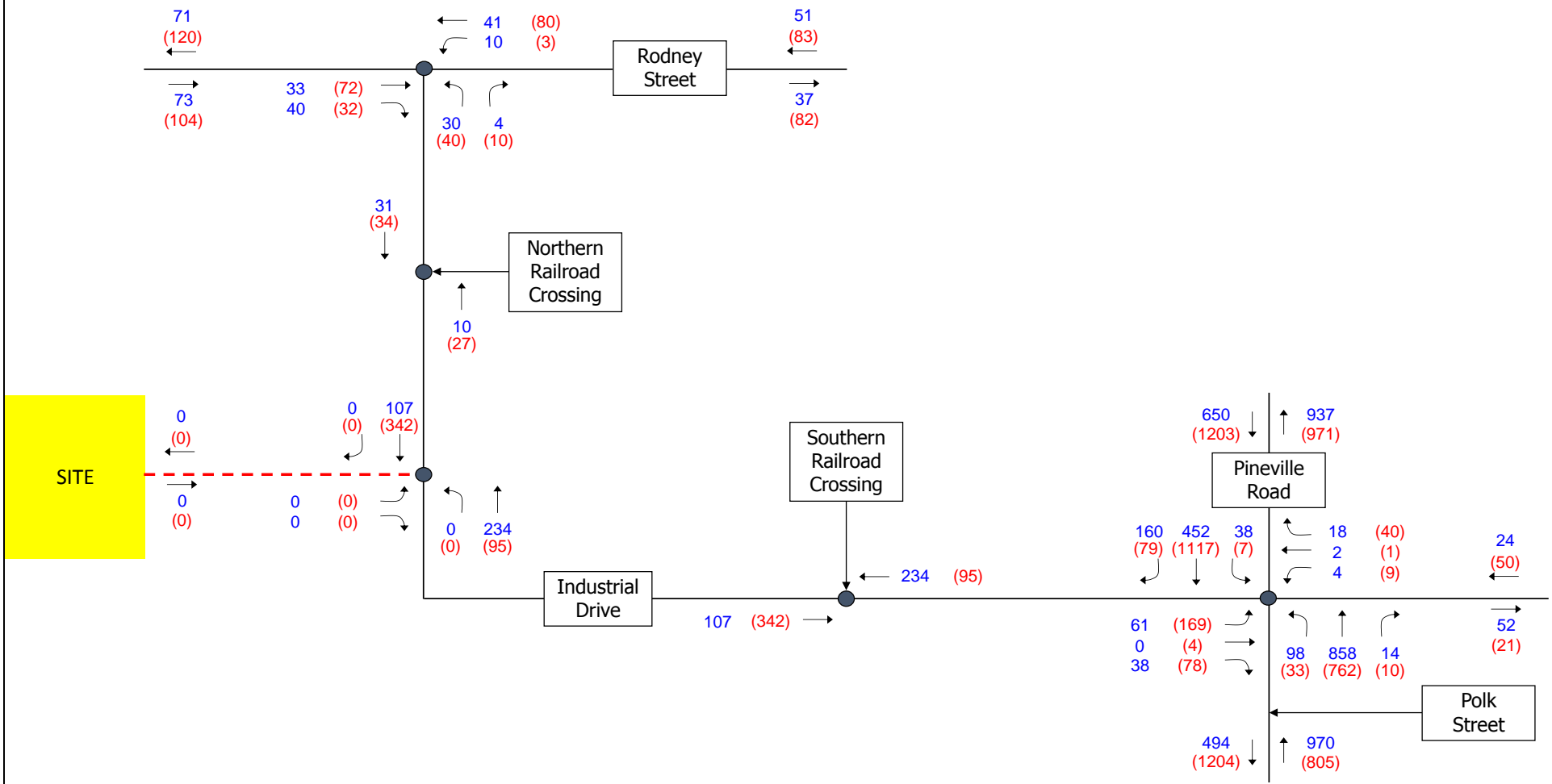

**Pineville Industrial Development
Traffic Impact Analysis
2017 Existing Traffic Volumes**

Figure 2-4

3 EXISTING AND BACKGROUND CONDITIONS AND ANALYSIS

3.1 2017 EXISTING ANALYSES

Table 3-1 summarizes the 2017 Existing intersection LOS, delay, and 95th percentile queue lengths based on the geometry shown on **Figure 2-3** and the 2017 Existing traffic volumes shown on **Figure 2-4**. The corresponding SYNCHRO output is included in **Appendix D**.

The signalized intersection of Polk Street / Pineville Road / Industrial Drive is currently operating at a LOS B during both the AM and PM peak hours. During the PM peak hour, Synchro projects that the 95th percentile queue length for the eastbound left-turn lane (170-feet) exceeds available storage (150-feet). Existing turn-lane storage is adequate to handle all remaining 95th percentile queue lengths.

All unsignalized intersection movements at the intersection of Industrial Drive / Rodney Street are currently operating at a LOS A during the AM and PM peak hours.

**Table 3-1: Intersection Level of Service, Delay and 95th Percentile Queue Summary
2017 Existing Traffic Volumes**

Intersection and Type of Control	Movement and Approach	Turn Lane Storage (ft)	AM PEAK HOUR			PM PEAK HOUR		
			Delay ¹ (sec/veh)	LOS ¹	95th Percentile Queue Length (ft)	Delay ¹ (sec/veh)	LOS ¹	95th Percentile Queue Length (ft)
1. Polk Street / Pineville Road (N-S) at Industrial Drive (E-W) Signalized	EB Left	150	19.4	B	55	33.2	C	170
	EB Thru/Right		24.1	C	48	32.1	C	106
	<i>EB Approach</i>		21.2	C	--	32.9	C	--
	WB Left	75	19.2	B	8	27.1	C	18
	WB Thru/Right		29.4	C	32	41.3	D	63
	<i>WB Approach</i>		27.9	C	--	38.7	D	--
	NB Left	100	6.9	A	43	7.9	A	20
	NB Thru/Right		11.7	B	263	11.0	B	242
	<i>NB Approach</i>		11.3	B	--	10.9	B	--
	SB Left	165	6.8	A	21	7.1	A	7
	SB Thru/Right		14.2	B	179	19.7	B	444
	<i>SB Approach</i>		13.7	B	--	19.6	B	--
	Overall			13.0	B	--	18.4	B
2. Industrial Drive (N-S) at Rodney Street (E-W) Unsignalized	EB Thru/Right		0.0	A	0	0.0	A	0
	<i>EB Approach</i>		†	†	--	†	†	--
	WB Left/Thru		1.5	A	1	0.3	A	0
	<i>WB Approach</i>		†	†	--	†	†	--
	NB Left/Right		9.3	A	3	9.7	A	5
	<i>NB Approach</i>		†	†	--	†	†	--

† SYNCHRO does not provide level of service or delay for unsignalized movements with no conflicting volumes.

- 95th percentile volume exceeds capacity, queue may be longer. Queue shown is maximum after two cycles.

m - Volume for 95th percentile queue is metered by upstream signal.

3.2 2021 BACKGROUND TRAFFIC VOLUMES

Currently there is one approved development in the project study area that will be partially or fully built-out by 2019 and 2024, respectively: Cranford Drive Residential Development (see **Appendix E**). Listed below is the approved development, site trip distribution assumptions, and proposed offsite improvements.

- Cranford Drive Residential Development
 - TIA completed by Timmons Group (sealed 8/25/17)
 - Located off Main Street in Pineville, NC
 - Assumed to be fully constructed prior to the Pineville Industrial Development*
 - 170 detached single-family residential units and 155 townhomes – Land Use Codes (LUC) 210 and 230
 - One site driveway connection to Industrial Drive
 - Trip distribution found in existing TIA
 - No assumed offsite improvements

*The build analysis year for the Cranford Drive Residential TIA was 2021; however, to provide a more conservative analysis, it was assumed the development would be fully constructed prior to 2019.

Projected and distributed trips from the approved development (see **Appendix E**) were totaled and are shown in **Figure 3-1**. These trips were added to the 2019 ambient volumes (existing traffic volumes multiplied by a 2% growth factor – found in TIAs for adjacent studies) to determine the 2019 Phase I Background traffic volumes (see **Figure 3-2**). Similarly, approved development trips were added to the 2024 ambient volumes and 2019 Phase I Trip Distribution traffic volumes (see **Figure 4-1**) to determine the 2024 Phase II Background traffic volumes (see **Figure 3-3**).

3.3 2021 BACKGROUND ANALYSIS

Table 3-2a summarizes the 2019 Phase I Background intersection LOS, delay, and 95th percentile queue lengths based on the geometry shown in **Figure 2-3** and the 2019 Phase I Background traffic volumes shown in **Figure 3-2**. The corresponding SYNCHRO output is included in **Appendix D**.

The signalized intersection of Polk Street / Pineville Road / Industrial Drive is projected to operate at a LOS B during the 2019 Phase I Background AM peak hour and LOS C during the PM peak hour. During the PM peak hour, Synchro projects that the 95th percentile queue length for the eastbound left-turn lane (238-feet) will exceed available storage (150-feet). Existing turn-lane storage is adequate to handle all remaining 95th percentile queue lengths.

All unsignalized intersection movements at the intersection of Industrial Drive / Rodney Street are projected to operate at a LOS A during the 2019 Phase I Background AM and PM peak hours.

**Table 3-2a: Intersection Level of Service, Delay and 95th Percentile Queue Summary
2019 Phase I Background Traffic Volumes**

Intersection and Type of Control	Movement and Approach	Turn Lane Storage (ft)	AM PEAK HOUR			PM PEAK HOUR		
			Delay ¹ (sec/veh)	LOS ¹	95th Percentile Queue Length (ft)	Delay ¹ (sec/veh)	LOS ¹	95th Percentile Queue Length (ft)
1. Polk Street / Pineville Road (N-S) at Industrial Drive (E-W) Signalized	EB Left	150	23.1	C	89	43.3	D	#238
	EB Thru/Right		26.0	C	67	37.2	D	133
	<i>EB Approach</i>		24.1	C	--	41.3	D	--
	WB Left	75	20.5	C	9	29.9	C	20
	WB Thru/Right		32.0	C	34	45.1	D	71
	<i>WB Approach</i>		30.3	C	--	42.5	D	--
	NB Left	100	7.8	A	48	8.2	A	26
	NB Thru/Right		15.1	B	282	10.6	B	261
	<i>NB Approach</i>		14.3	B	--	10.4	B	--
	SB Left	165	7.3	A	22	7.1	A	8
	SB Thru/Right		15.6	B	196	22.7	C	527
	<i>SB Approach</i>		15.1	B	--	22.6	C	--
Overall			15.7	B	--	21.1	C	--
2. Industrial Drive (N-S) at Rodney Street (E-W) Unsignalized	EB Thru/Right		0.0	A	0	0.0	A	0
	<i>EB Approach</i>		†	†	--	†	†	--
	WB Left/Thru		1.4	A	1	0.3	A	0
	<i>WB Approach</i>		†	†	--	†	†	--
	NB Left/Right		9.4	A	5	9.8	A	6
<i>NB Approach</i>			†	†	--	†	†	--

† SYNCHRO does not provide level of service or delay for unsignalized movements with no conflicting volumes.

- 95th percentile volume exceeds capacity, queue may be longer. Queue shown is maximum after two cycles.

m - Volume for 95th percentile queue is metered by upstream signal.

Table 3-2b summarizes the 2024 Phase II Background intersection LOS, delay, and 95th percentile queue lengths based on the geometry shown in **Figure 2-3** and the 2024 Phase II Background traffic volumes shown in **Figure 3-3**. The corresponding SYNCHRO output is included in **Appendix D**.

The signalized intersection of Polk Street / Pineville Road / Industrial Drive is projected to operate at a LOS B during the 2024 Phase II Background AM peak hour and LOS C during the PM peak hour. During the PM peak hour, Synchro projects that the 95th percentile queue length for the eastbound left-turn lane (279-feet) will exceed available storage (150-feet). Existing turn-lane storage is adequate to handle all remaining 95th percentile queue lengths.

All unsignalized intersection movements at the intersection of Industrial Drive / Rodney Street are projected to operate at a LOS B or better during the 2019 Phase II Background AM and PM peak hours.

All unsignalized intersection movements at the intersection of Industrial Drive / Site Driveway #1 are projected to operate at a LOS B or better during the 2024 Phase II Background AM and PM peak hours.

**Table 3-2b: Intersection Level of Service, Delay and 95th Percentile Queue Summary
2024 Phase II Background Traffic Volumes**

Intersection and Type of Control	Movement and Approach	Turn Lane Storage (ft)	AM PEAK HOUR			PM PEAK HOUR		
			Delay ¹ (sec/veh)	LOS ¹	95th Percentile Queue Length (ft)	Delay ¹ (sec/veh)	LOS ¹	95th Percentile Queue Length (ft)
1. Polk Street / Pineville Road (N-S) at Industrial Drive (E-W) Signalized	EB Left	150	28.0	C	117	64.5	E	#279
	EB Thru/Right		29.2	C	84	44.3	D	248
	<i>EB Approach</i>		28.4	C	--	56.5	E	--
	WB Left	75	23.0	C	12	32.9	C	21
	WB Thru/Right		34.6	C	37	50.6	D	76
	<i>WB Approach</i>		32.4	C	--	47.5	D	--
	NB Left	100	10.8	B	81	10.3	B	38
	NB Thru/Right		16.3	B	331	11.4	B	300
	<i>NB Approach</i>		15.4	B	--	11.3	B	--
	SB Left	165	7.7	A	24	7.0	A	8
	SB Thru/Right		20.3	C	248	27.5	C	674
	<i>SB Approach</i>		19.6	B	--	27.4	C	--
Overall			18.3	B	--	26.9	C	--
2. Industrial Drive (N-S) at Rodney Street (E-W) Unsignalized	EB Thru/Right		0.0	A	0	0.0	A	0
	<i>EB Approach</i>		†	†	--	†	†	--
	WB Left/Thru		1.9	A	1	0.4	A	0
	<i>WB Approach</i>		†	†	--	†	†	--
	NB Left/Right		9.6	A	6	10.1	B	8
<i>NB Approach</i>		†	†	--	†	†	--	
3. Industrial Drive (N-S) at Site Driveway #1 (E-W) Unsignalized	EB Thru/Right		9.5	A	3	13.0	B	22
	<i>EB Approach</i>		†	†	--	†	†	--
	NB Left/Thru		2.8	A	7	2.3	A	3
	<i>NB Approach</i>		†	†	--	†	†	--
	SB Thru/Right		0.0	A	0	0.0	A	0
<i>SB Approach</i>		†	†	--	†	†	--	

† SYNCHRO does not provide level of service or delay for unsignalized movements with no conflicting volumes.

- 95th percentile volume exceeds capacity, queue may be longer. Queue shown is maximum after two cycles.

m - Volume for 95th percentile queue is metered by upstream signal.

LEGEND:

- Existing Road
- - - Proposed Road
- XX AM Peak Hour Volume (vph)
- (XX) PM Peak Hour Volume (vph)

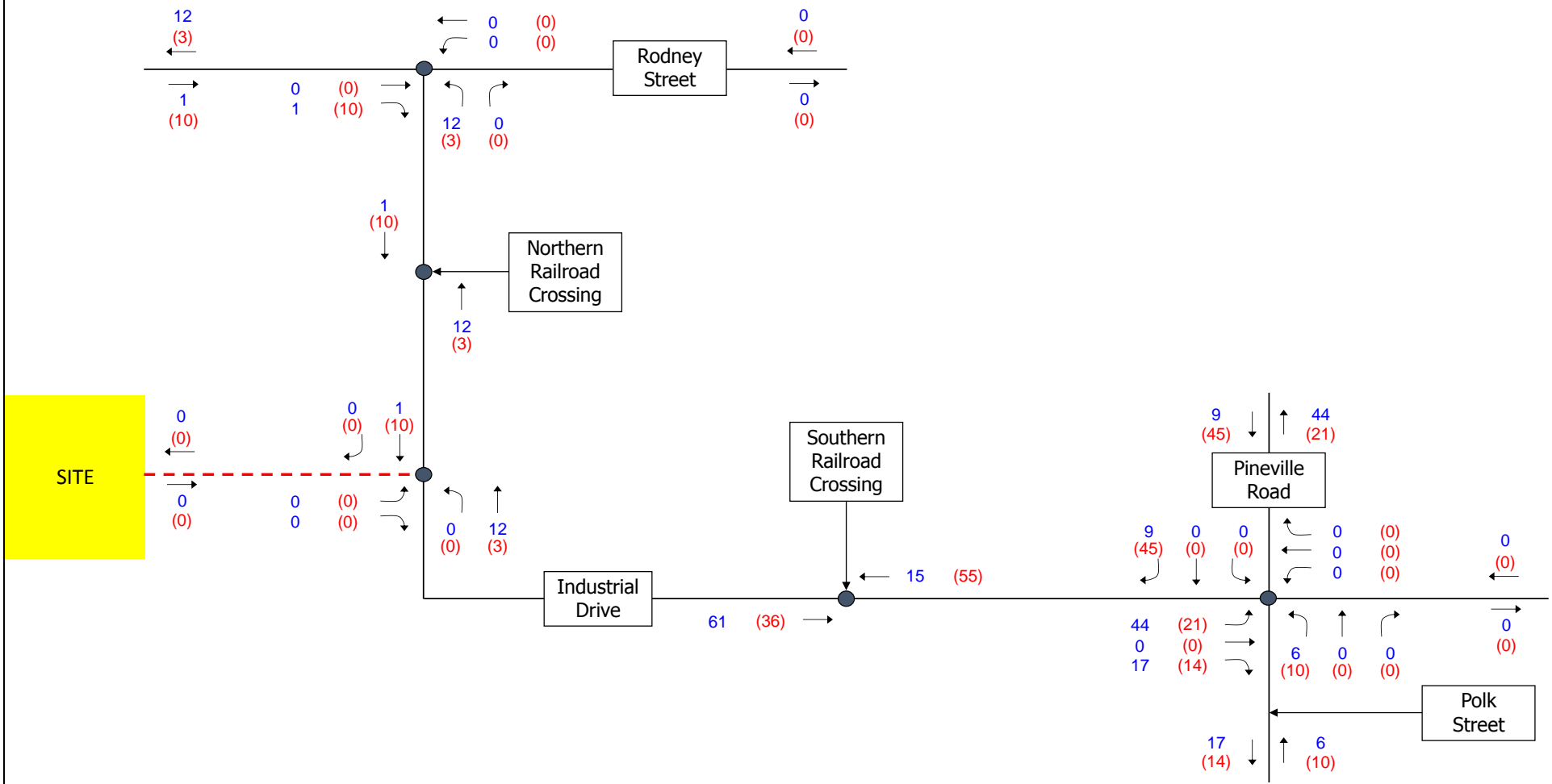

**Pineville Industrial Development
Traffic Impact Analysis**
Approved Development Traffic Volumes

Figure 3-1

LEGEND:

- Existing Road
- - - Proposed Road
- XX AM Peak Hour Volume (vph)
- (XX) PM Peak Hour Volume (vph)

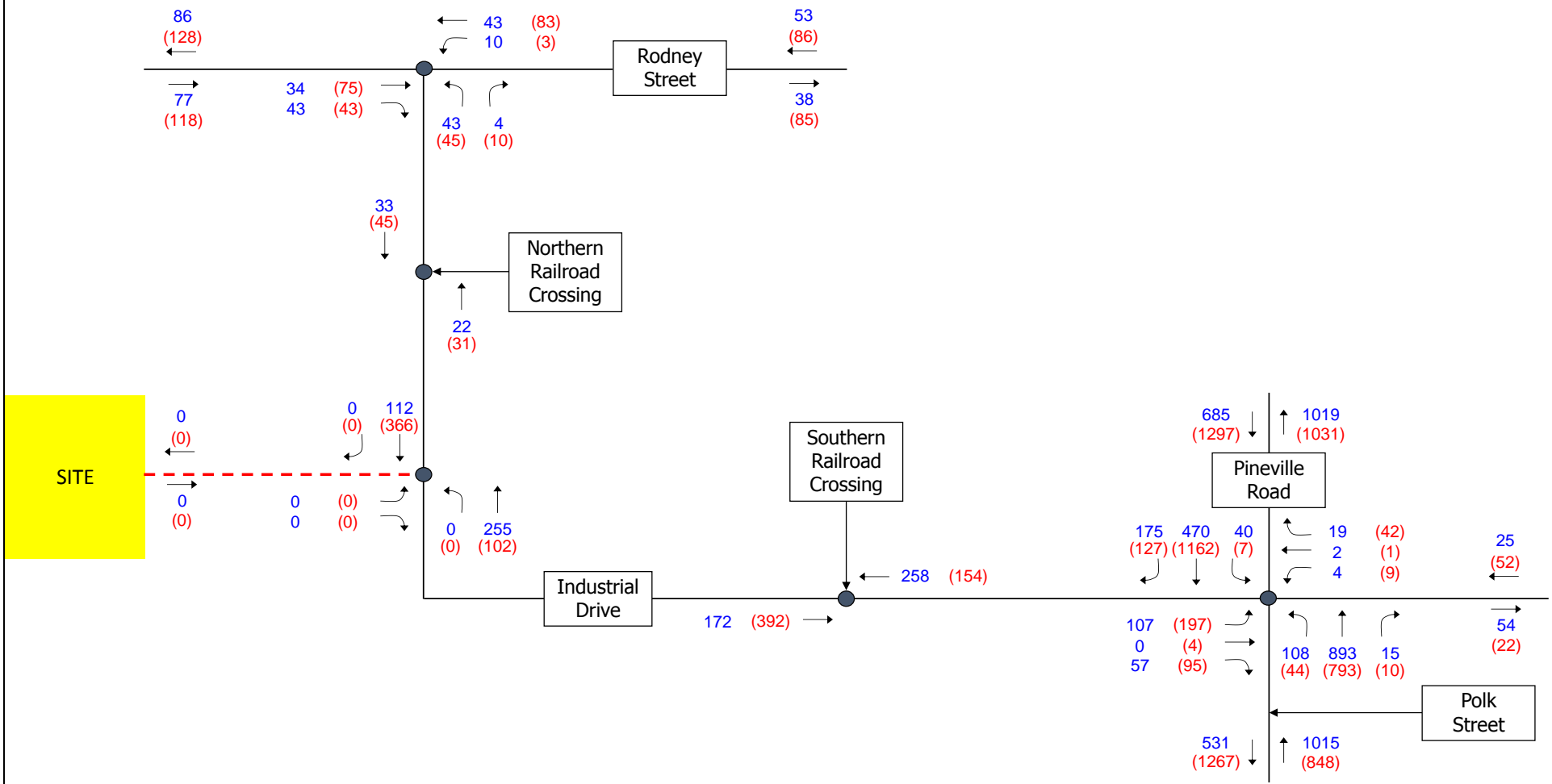

**Pineville Industrial Development
Traffic Impact Analysis
2019 Phase I Background Traffic Volumes**

Figure 3-2

LEGEND:

- Existing Road
- - - Proposed Road
- XX AM Peak Hour Volume (vph)
- (XX) PM Peak Hour Volume (vph)

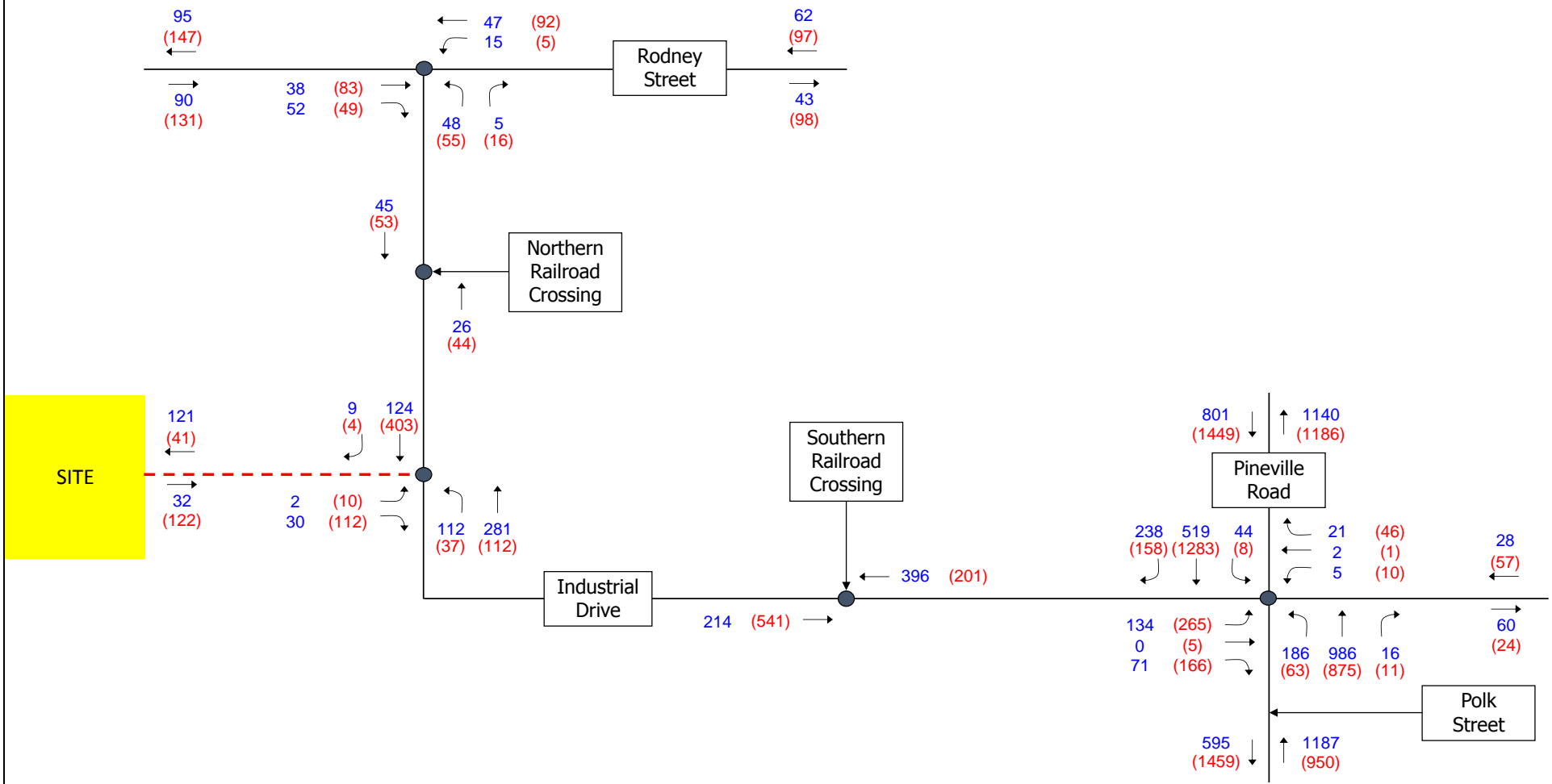

**Pineville Industrial Development
Traffic Impact Analysis**
2024 Phsae II Background Traffic Volumes

Figure 3-3

4 SITE TRIP GENERATION AND DISTRIBUTION

Site trips for the Pineville Industrial Development were estimated based on the proposed land use supplied by the developer and subsequently distributed onto the surrounding roadway network for each phase of construction.

4.1 TRIP GENERATION

The traffic generation potential of the proposed development was determined using the *ITE Trip Generation Manual* (Institute of Transportation Engineers, 9th Edition, 2012). **Tables 4-1a** and **4-1b** below list the ITE Land Use Code (LUC) and independent variable used for the development during Phase I and Phase II. Trip generation values were calculated using the total square footage (510,000 SF & 340,000 SF respectively) as the independent variable as well as the average rate and the equation (per NCDOT guidelines).

Table 4-1a: Phase I Trip Generation Summary

ITE Land Use Code	Independent Variable	Daily			AM Peak Hour			PM Peak Hour		
		In	Out	Total	In	Out	Total	In	Out	Total
510 – Warehousing	510,000 SF	908	908	1,816	121	32	153	41	122	163

SOURCE: Institute of Transportation Engineers' *Trip Generation Manual* 9th Edition (2012)

Phase I AM peak hour trips generated totaled 121 incoming and 32 outgoing where PM peak hour trips totaled 41 incoming and 122 outgoing. Average daily traffic (ADT) volumes generated by the development totaled 1,816 vehicles per day. No reduction in trips was included due to internal capture and/or pass-by trips.

Table 4-2b: Phase II Trip Generation Summary

ITE Land Use Code	Independent Variable	Daily			AM Peak Hour			PM Peak Hour		
		In	Out	Total	In	Out	Total	In	Out	Total
510 – Warehousing	510,000 SF	908	908	1,816	121	32	153	41	122	163
110 – General Light Industrial	340,000 SF	1219	1219	2,438	274	37	311	39	289	328
Total:		2,127	2,127	4,254	395	69	464	80	411	491

SOURCE: Institute of Transportation Engineers' *Trip Generation Manual* 9th Edition (2012)

Phase II AM peak hour trips generated totaled 395 incoming and 69 outgoing where PM peak hour trips totaled 80 incoming and 411 outgoing. Average daily traffic (ADT) volumes generated by the development totaled 4,254 vehicles per day. No reduction in trips was included due to internal capture and/or pass-by trips.

4.2 TRIP DISTRIBUTION

The directional traffic patterns, or trip distribution, of the site-generated traffic was determined using the existing AM and PM peak hour traffic characteristics. It was assumed, for purposes of this study, that all site traffic would enter and exit the study area in the same manner as the existing traffic. Area trip distribution is based on traffic counts performed by Timmons Group. Total trips into and out of the study area using Rodney Street, Industrial Drive, Polk Street, and Pineville Road form the basis for the percentage distribution. Distribution percentages into and out of the study area were calculated using existing traffic volumes entering and exiting the study area. The percentages were routed, via shortest path, to and from the proposed development. The distribution percentages were then applied to the generated trips to predict routes and project traffic volumes for the 2019 Phase I and 2024 Phase II build-

out scenarios. **Figure 4-1** shows the trip distribution percentages and **Figures 4-2** and **4-3** show the 2019 and 2024 Phases I and II site trip distribution volumes, respectively. 2019 Phase I Build traffic volumes were determined by applying the Phase I site trip distribution volumes to the 2019 Phase I Background traffic volumes (see **Figure 3-2**). Similarly, 2024 Phase II Build traffic volumes were determined by applying the Phase II site trip distribution volumes to the 2024 Phase II Background traffic volumes (see **Figure 3-3**).

LEGEND:

- Existing Road
- - - Proposed Road
- XX AM Peak Hour Percents
- (XX) PM Peak Hour Percents

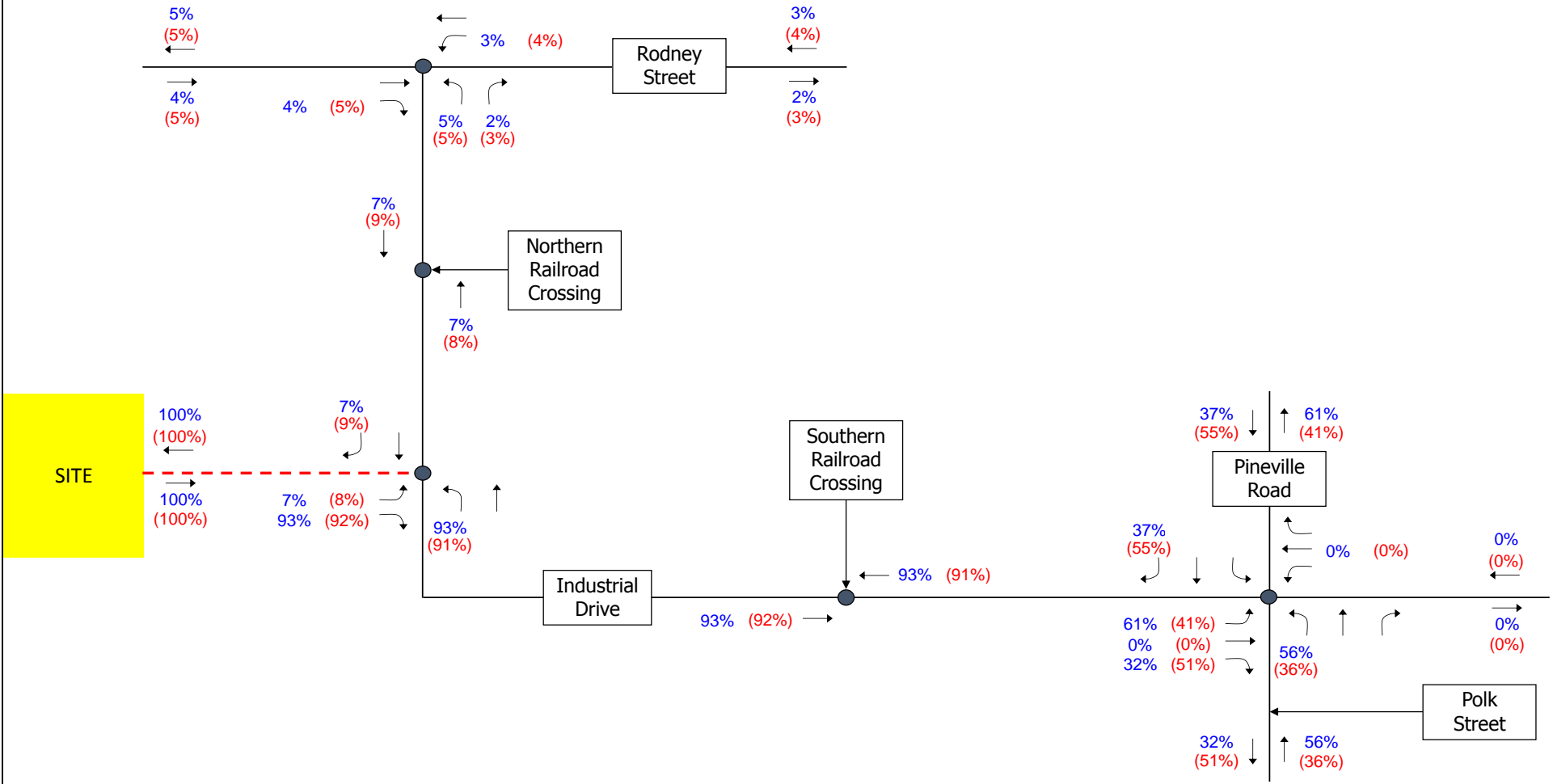

**Pineville Industrial Development
Traffic Impact Analysis
2019 Trip Distribution Percentages**

Figure 4-1

LEGEND:

- Existing Road
- - - Proposed Road
- XX AM Peak Hour Volume (vph)
- (XX) PM Peak Hour Volume (vph)

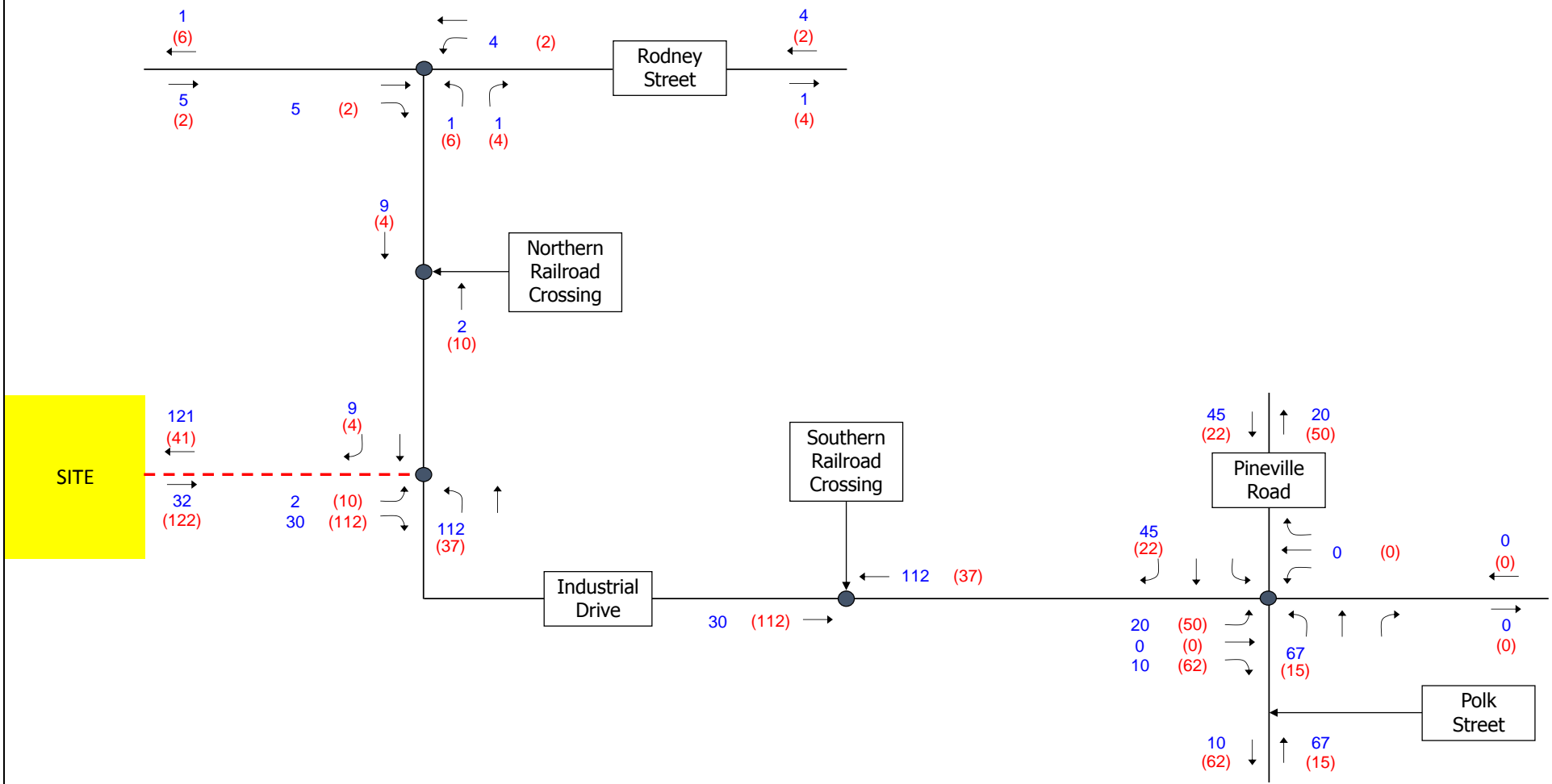

**Pineville Industrial Development
Traffic Impact Analysis**
2019 Phase I Trip Distribution Traffic Volumes

Figure 4-2

LEGEND:

- Existing Road
- - - Proposed Road
- XX AM Peak Hour Volume (vph)
- (XX) PM Peak Hour Volume (vph)

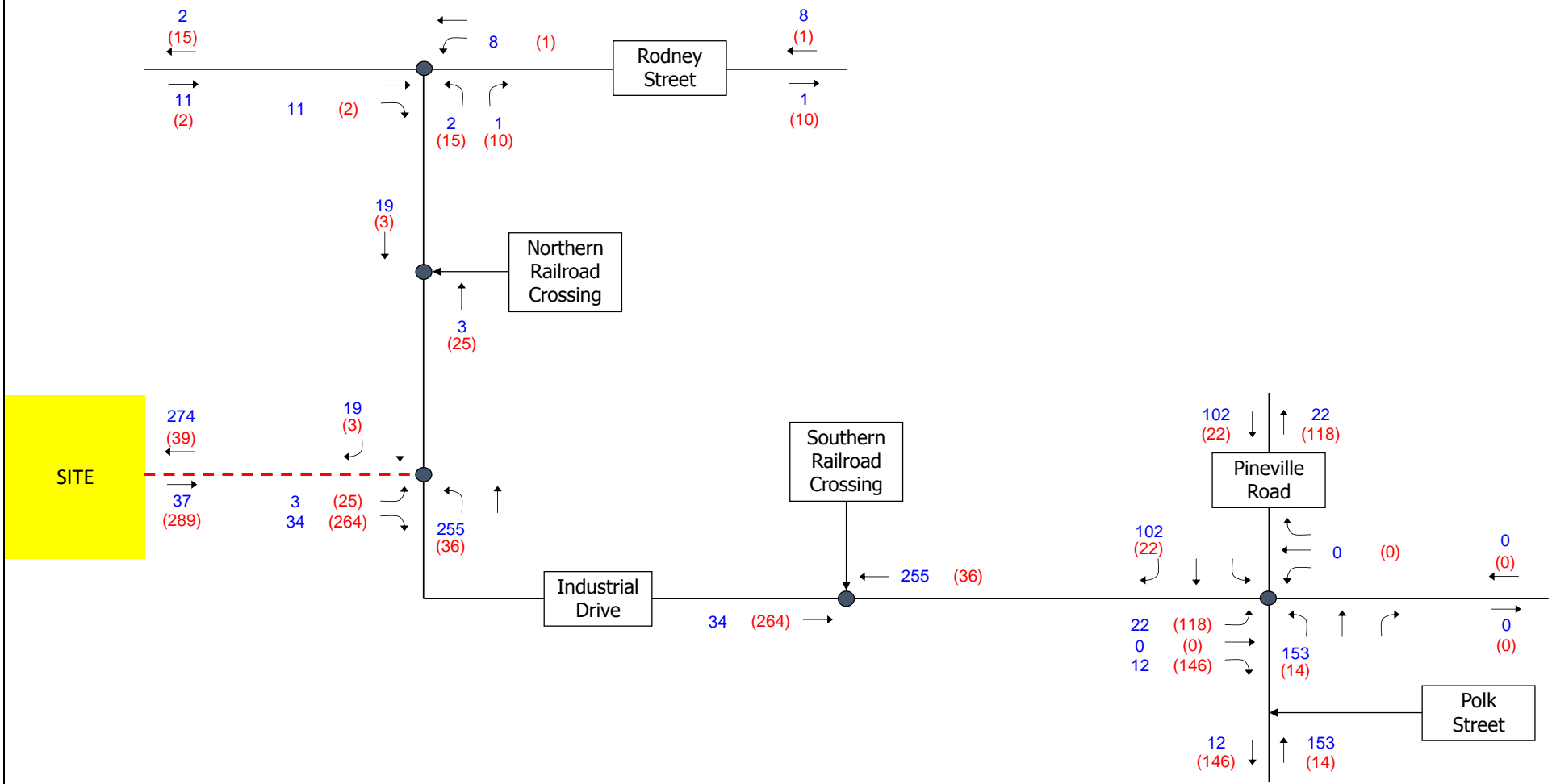

Pineville Industrial Development Traffic Impact Analysis

2024 Phase II Trip Distribution Traffic Volumes

Figure 4-3

5 PHASE I & II BUILD CONDITION AND ANALYSIS

To complete the 2019 Phase I and 2024 Phase II Build analyses (including the proposed development), the estimated site trips were added to the 2019 Phase I and 2024 Phase II Background traffic volumes, respectively. The projected total volumes, along with the existing intersection geometry, were used to complete the capacity and turn lane warrant analyses.

5.1 PHASE I & II BUILD TRAFFIC VOLUMES

The 2019 Phase I Background traffic volumes from **Figure 3-2** were added to the Phase I projected site trips from the Pineville Industrial Development (**Figure 4-2**) to generate the 2019 Phase I Build traffic volumes (background + site) shown on **Figure 5-1**. Similarly, the 2024 Phase II Background traffic volumes from **Figure 3-3** were added to the Phase II projected site trips (**Figure 4-3**) to generate the 2024 Phase II Build traffic volumes shown on **Figure 5-2**.

5.2 PHASE I & II BUILD ANALYSIS

Table 5-1a summarizes the 2019 Phase I Build intersection LOS, delay, and 95th percentile queue lengths based on 2019 Phase I Build traffic volumes (shown on **Figure 5-1**).

The signalized intersection of Polk Street / Pineville Road / Industrial Drive is projected to operate at a LOS B during the 2019 Phase I Build AM peak hour and LOS C during the PM peak hour. During the PM peak hour, Synchro projects that the 95th percentile queue length for the eastbound left-turn lane (267-feet) will exceed available storage (150-feet). Existing turn-lane storage is adequate to handle all remaining 95th percentile queue lengths. Because this intersection is projected to operate at acceptable levels of service during both peak hours, no improvement recommendations are necessary to help mitigate intersection congestion due to the construction of Phase I of the proposed development.

All unsignalized intersection movements at the intersection of Industrial Drive / Rodney Street are projected to operate at a LOS A during the 2019 Phase I Build AM and PM peak hours. Because all intersection movements are projected to operate at acceptable levels of service during both peak hours, no improvement recommendations are necessary to help mitigate intersection congestion due to the construction of Phase I of the proposed development.

All unsignalized intersection movements at the intersection of Industrial Drive / Site Driveway #1 are projected to operate at a LOS A during the 2019 Phase I Build AM and PM peak hours. No improvements are recommended to help mitigate future capacity concern at the proposed site driveway due to the construction of Phase I of the proposed development. Although Industrial Drive is not an NCDOT owned facility, Timmons Group followed standard NCDOT practices to determine the need for an exclusive turn-lane into the proposed site. Per standard NCDOT Policy on Street and Driveway Access to North Carolina Highways Manual:

"Generally left and right turn lanes and tapers shall be considered when:

- *In accordance with G.S. 136-18(29), the average daily traffic meets or exceeds 4,000 vehicles per day on any secondary route (the average daily traffic should include both the existing traffic plus traffic generated by the proposed development)"*

With the projected AADT volumes along Industrial Drive not expecting to exceed 4,000 VPD, the construction of turn lanes is not warranted.

**Table 5-1a: Intersection Level of Service, Delay and 95th Percentile Queue Summary
2019 Phase I Build Traffic Volumes**

Intersection and Type of Control	Movement and Approach	Turn Lane Storage (ft)	AM PEAK HOUR			PM PEAK HOUR		
			Delay ¹ (sec/veh)	LOS ¹	95th Percentile Queue Length (ft)	Delay ¹ (sec/veh)	LOS ¹	95th Percentile Queue Length (ft)
1. Polk Street / Pineville Road (N-S) at Industrial Drive (E-W) Signalized	EB Left	150	24.1	C	104	53.3	D	#267
	EB Thru/Right		26.3	C	76	41.5	D	#224
	<i>EB Approach</i>		24.8	C	--	48.6	D	--
	WB Left	75	20.8	C	9	30.7	C	20
	WB Thru/Right		32.0	C	34	46.2	D	72
	<i>WB Approach</i>		30.3	C	--	43.5	D	--
	NB Left	100	9.4	A	76	8.9	A	33
	NB Thru/Right		15.2	B	286	10.7	B	265
	<i>NB Approach</i>		14.3	B	--	10.5	B	--
	SB Left	165	7.5	A	22	7.1	A	8
	SB Thru/Right		19.2	B	220	24.3	C	571
	<i>SB Approach</i>		18.5	B	--	24.3	C	--
Overall			17.0	B	--	23.9	C	--
2. Industrial Drive (N-S) at Rodney Street (E-W) Unsignalized	EB Thru/Right		0.0	A	0	0.0	A	0
	<i>EB Approach</i>		†	†	--	†	†	--
	WB Left/Thru		1.9	A	1	0.5	A	0
	<i>WB Approach</i>		†	†	--	†	†	--
	NB Left/Right		9.5	A	5	9.9	A	8
<i>NB Approach</i>		†	†	--	†	†	--	
3. Industrial Drive (N-S) at Site Driveway #1 (E-W) Unsignalized	EB Thru/Right		9.4	A	3	12.4	B	21
	<i>EB Approach</i>		†	†	--	†	†	--
	NB Left/Thru		2.9	A	7	2.4	A	3
	<i>NB Approach</i>		†	†	--	†	†	--
	SB Thru/Right		0.0	A	0	0.0	A	0
<i>SB Approach</i>		†	†	--	†	†	--	

† SYNCHRO does not provide level of service or delay for unsignalized movements with no conflicting volumes.

- 95th percentile volume exceeds capacity, queue may be longer. Queue shown is maximum after two cycles.

m - Volume for 95th percentile queue is metered by upstream signal.

Table 5-1b summarizes the 2024 Phase II Build intersection LOS, delay, and 95th percentile queue lengths based on 2024 Phase II Build traffic volumes (shown on **Figure 5-2**).

The signalized intersection of Polk Street / Pineville Road / Industrial Drive is projected to operate at a LOS C during the 2024 Phase II Build AM peak hour and LOS D during the PM peak hour. During the PM peak hour, Synchro projects that the 95th percentile queue length for the eastbound left-turn lane (508-feet) will exceed available storage (150-feet). Additionally, Synchro projects that the 95th percentile queue length for the northbound left-turn lane (363-feet) will exceed available storage (100-feet) during the AM peak hour. Existing turn-lane storage is adequate to handle all remaining 95th percentile queue lengths. Because this intersection is projected to operate at acceptable levels of service during both peak hours, no improvement recommendations are necessary to help mitigate intersection congestion due to the construction of Phase II of the proposed development.

All unsignalized intersection movements at the intersection of Industrial Drive / Rodney Street are projected to operate at a LOS B or better during the 2024 Phase II Build AM and PM peak hours. Because all intersection movements are projected to operate at acceptable levels of service during both peak hours, no improvement recommendations are necessary to help mitigate intersection congestion due to the construction of Phase II of the proposed development.

All unsignalized intersection movements at the intersection of Industrial Drive / Site Driveway #1 are projected to operate at a LOS D or better during the 2024 Phase II Build AM and PM peak hours. No improvements are recommended to help mitigate future capacity concern at the proposed site driveway due to the construction of Phase II of the proposed development. Although Industrial Drive is not an NCDOT owned facility, Timmons Group followed standard NCDOT practices to determine the need for an exclusive turn-lane into the proposed site. Per standard NCDOT Policy on Street and Driveway Access to North Carolina Highways Manual:

"Generally left and right turn lanes and tapers shall be considered when:

- In accordance with G.S. 136-18(29), the average daily traffic meets or exceeds 4,000 vehicles per day on any secondary route (the average daily traffic should include both the existing traffic plus traffic generated by the proposed development)"*

With the projected AADT volumes along Industrial Drive not expecting to exceed 4,000 VPD, the construction of turn lanes is not warranted.

**Table 5-2b: Intersection Level of Service, Delay and 95th Percentile Queue Summary
2024 Phase II Build Traffic Volumes**

Intersection and Type of Control	Movement and Approach	Turn Lane Storage (ft)	AM PEAK HOUR			PM PEAK HOUR		
			Delay ¹ (sec/veh)	LOS ¹	95th Percentile Queue Length (ft)	Delay ¹ (sec/veh)	LOS ¹	95th Percentile Queue Length (ft)
1. Polk Street / Pineville Road (N-S) at Industrial Drive (E-W) Signalized	EB Left	150	30.9	C	136	142.8	F	#508
	EB Thru/Right		30.3	C	96	73.9	E	#546
	<i>EB Approach</i>		30.7	C	--	111.6	F	--
	WB Left	75	23.2	C	12	33.6	C	21
	WB Thru/Right		34.9	C	37	52.2	D	76
	<i>WB Approach</i>		32.6	C	--	49.0	D	--
	NB Left	100	46.7	D	#363	14.5	B	57
	NB Thru/Right		16.0	B	338	11.6	B	300
	<i>NB Approach</i>		23.8	C	--	11.9	B	--
	SB Left	165	7.8	A	25	7.0	A	8
	SB Thru/Right		22.8	C	301	29.7	C	#697
	<i>SB Approach</i>		22.1	C	--	29.6	C	--
Overall			23.9	C	--	42.6	D	--
2. Industrial Drive (N-S) at Rodney Street (E-W) Unsignalized	EB Thru/Right		0.0	A	0	0.0	A	0
	<i>EB Approach</i>		†	†	--	†	†	--
	WB Left/Thru		2.6	A	1	0.5	A	0
	<i>WB Approach</i>		†	†	--	†	†	--
	NB Left/Right		9.8	A	6	10.3	B	12
<i>NB Approach</i>		†	†	--	†	†	--	
3. Industrial Drive (N-S) at Site Driveway #1 (E-W) Unsignalized	EB Thru/Right		11.7	B	11	31.5	D	193
	<i>EB Approach</i>		†	†	--	†	†	--
	NB Left/Thru		6.2	A	30	3.8	A	6
	<i>NB Approach</i>		†	†	--	†	†	--
	SB Thru/Right		0.0	A	0	0.0	A	0
<i>SB Approach</i>		†	†	--	†	†	--	

† SYNCHRO does not provide level of service or delay for unsignalized movements with no conflicting volumes.

- 95th percentile volume exceeds capacity, queue may be longer. Queue shown is maximum after two cycles.

m - Volume for 95th percentile queue is metered by upstream signal.

5.3 RAILROAD CROSSING

Due to the proximity of multiple railroad crossings (along Industrial Drive) to the proposed site, Timmons Group evaluated the need for any crossing improvements due to the construction of the proposed site. Currently, there are two railroad crossings within close proximity of the proposed development.

As mentioned earlier in the document, the unsignalized northern railroad crossing includes cross-buck signage for north and southbound drivers to denote the existing crossing. The signalized southern railroad crossing includes overhead flashers, gates, and cross-buck signage for east and westbound drivers to denote the existing crossing. Site Driveway #1 will be located approximately 1,650' (C/L to C/L) south of the northern railroad crossing and approximately 2,715' (C/L to C/L) northwest of the southern railroad crossing. The northern railroad crossing is located approximately 875' (C/L to C/L) south of Rodney Street. Finally, the southern railroad crossing is located approximately 600' (C/L to C/L) west Pineville Road / Polk Street.

Per **Tables 5-1a** and **5-1b**, Synchro projects that the following:

- Site Driveway #1 / Industrial Drive
 - Shared northbound left-turn / through movement 95th percentile queue length projected not to exceed 6-feet during any peak hour for Phases I and II.
 - Shared southbound through / right-turn movement 95th percentile queue length projected to be 0-feet during both peak hours for Phases I and II.
- Industrial Drive / Rodney
 - Shared northbound left/right-turn movement 95th percentile queue length projected not to exceed 12-feet during any peak hour for Phases I and II.
- Industrial Drive / Pineville Road / Polk Street
 - Exclusive eastbound left-turn movement 95th percentile queue length projected not to exceed 508-feet during any peak hour for Phases I and II.
 - Shared eastbound through / right-turn movement 95th percentile queue length projected not to exceed 546-feet during any peak hour for Phases I and II.

Even though the queuing adjacent to the northern railroad crossing is expected to be minimal (northbound queues at Rodney Street or southbound queues at Site Driveway #1), it is recommended that stop bars be repainted and additional warning signs be placed at the existing crossing to help mitigate any potential safety concerns due to the construction of the proposed development.

Because Synchro projects that eastbound vehicles could (potentially) spillback (from Pineville Road / Polk Street) to the southern railroad crossing, it is recommended that stop bars be repainted and additional warning signs be placed at the existing crossing to help mitigate any potential safety concerns due to the construction of the proposed development. As mentioned earlier, the southern railroad crossing currently has significant enhancements (overhead flashing, crossing gates, etc.). Following the improvements mentioned above, adequate protection should exist for both vehicles and trains to allow for the crossing to operate safely and efficiently.

LEGEND:

- Existing Road
- - - Proposed Road
- XX AM Peak Hour Volume (vph)
- (XX) PM Peak Hour Volume (vph)

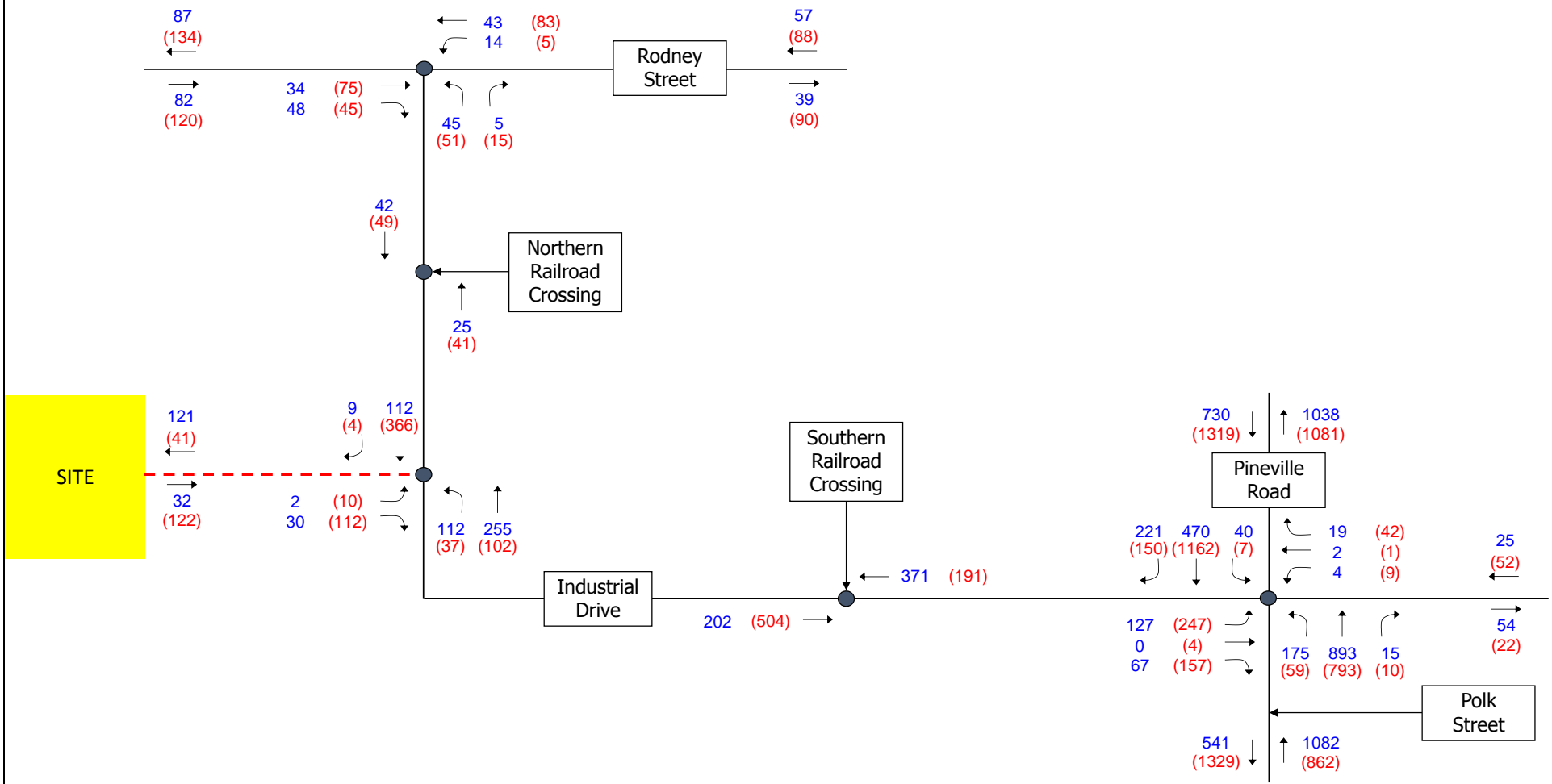

**Pineville Industrial Development
Traffic Impact Analysis
2019 Phase I Build Traffic Volumes**

Figure 5-1

LEGEND:

- Existing Road
- - - Proposed Road
- XX AM Peak Hour Volume (vph)
- (XX) PM Peak Hour Volume (vph)

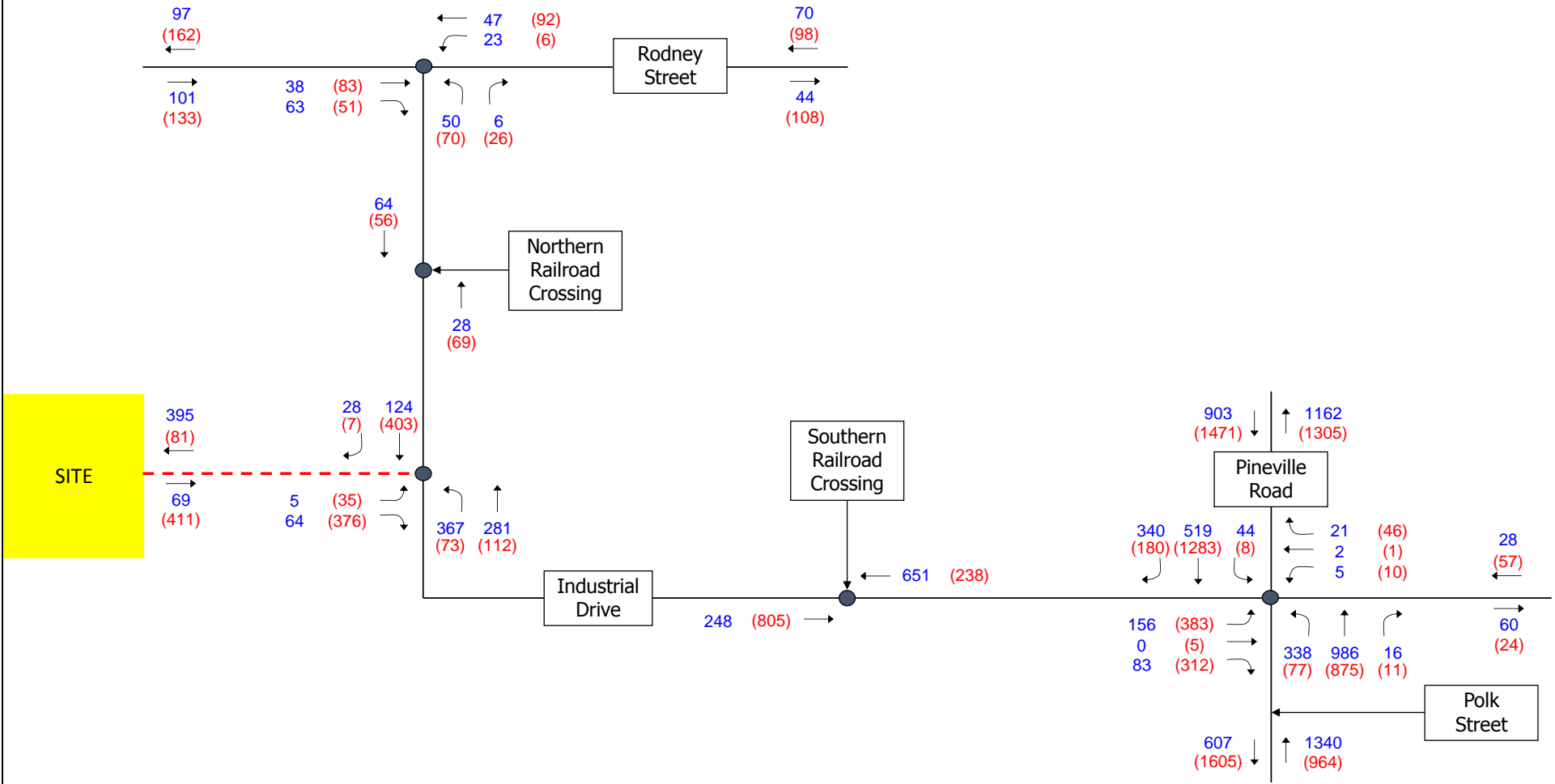

**Pineville Industrial Development
Traffic Impact Analysis
2024 Phase II Build Traffic Volumes**

Figure 5-2

6 CONCLUSIONS AND RECOMMENDATIONS

Capacity analyses were performed for 2017 Existing, 2019 Phase I Background (existing + ambient growth + approved development trips), 2024 Phase II Background (existing + ambient growth + Phase I site trips + approved development trips), 2019 Phase I Build (Phase I Background + site trips), and 2024 Phase II Build (Phase II Background + site trips) traffic volumes.

Based on the operational analyses the following is offered:

- The signalized intersection of Polk Street / Pineville Road / Industrial Drive is projected to operate at a LOS D or better during the 2019 Phase I and 2024 Phase II Build AM and PM peak hours. No improvements are recommended to help mitigate future capacity concern at the proposed site driveway.
- All unsignalized intersection movements at the intersection of Industrial Drive / Rodney Street are projected to operate at a LOS B or better during the 2019 Phase I and 2024 Phase II Build AM and PM peak hours. No improvements are recommended to help mitigate future capacity concern at the proposed site driveway.
- All unsignalized intersection movements at Industrial Drive / Site Driveway #1 are projected to operate at a LOS D or better during the 2019 Phase I and 2024 Phase II AM and PM peak hours. No improvements are recommended to help mitigate future capacity concern at the proposed site driveway.
- Queuing is not projected to affect operations at the Industrial Drive / Northern Railroad crossing.
- Queuing is projected to affect operations at Industrial Drive / Southern Railroad crossing.

In closing, the following improvements are recommended in conjunction with the construction of the proposed development:

- Industrial Drive / Northern Railroad Crossing:
 - Installation of stop bars (Phase I); and
 - Installation of additional warning signage (Phase I).
- Industrial Drive / Southern Railroad Crossing:
 - Installation of stop bars (Phase I); and
 - Installation of additional warning signage (Phase I).

Appendix A – Traffic Counts

Burns Service Inc.

1202 Langdon Terrace Drive
Raleigh, NC, 27615

File Name : Pineville(Industrial and Polk) AM Peak

Site Code :

Start Date : 5/25/2017

Page No : 1

Groups Printed- Cars + - Trucks

Start Time	Pineville Road Southbound				Industrial Drive Westbound				Polk Street Northbound				Industrial Drive Eastbound				Int. Total
	Right	Thru	Left	App. Total	Right	Thru	Left	App. Total	Right	Thru	Left	App. Total	Right	Thru	Left	App. Total	
07:00	40	66	3	109	2	0	1	3	5	160	19	184	15	1	26	42	338
07:15	38	129	11	178	10	0	1	11	4	222	36	262	10	0	12	22	473
07:30	24	93	7	124	1	1	0	2	5	219	13	237	9	0	19	28	391
07:45	51	129	16	196	3	0	2	5	4	235	34	273	6	0	14	20	494
Total	153	417	37	607	16	1	4	21	18	836	102	956	40	1	71	112	1696
08:00	47	101	4	152	4	1	1	6	1	182	15	198	13	0	16	29	385
08:15	29	150	3	182	6	1	1	8	2	210	11	223	12	1	26	39	452
08:30	13	109	8	130	2	0	0	2	2	180	15	197	4	1	15	20	349
08:45	26	132	9	167	6	1	0	7	3	138	12	153	9	6	20	35	362
Total	115	492	24	631	18	3	2	23	8	710	53	771	38	8	77	123	1548
Grand Total	268	909	61	1238	34	4	6	44	26	1546	155	1727	78	9	148	235	3244
Apprch %	21.6	73.4	4.9		77.3	9.1	13.6		1.5	89.5	9		33.2	3.8	63		
Total %	8.3	28	1.9	38.2	1	0.1	0.2	1.4	0.8	47.7	4.8	53.2	2.4	0.3	4.6	7.2	
Cars +	248	905	61	1214	33	4	6	43	26	1543	153	1722	77	9	128	214	3193
% Cars +	92.5	99.6	100	98.1	97.1	100	100	97.7	100	99.8	98.7	99.7	98.7	100	86.5	91.1	98.4
Trucks	20	4	0	24	1	0	0	1	0	3	2	5	1	0	20	21	51
% Trucks	7.5	0.4	0	1.9	2.9	0	0	2.3	0	0.2	1.3	0.3	1.3	0	13.5	8.9	1.6

Burns Service Inc.

1202 Langdon Terrace Drive
Raleigh, NC, 27615

File Name : Pineville(Industrial and Polk) AM Peak
Site Code :
Start Date : 5/25/2017
Page No : 2

Start Time	Pineville Road Southbound				Industrial Drive Westbound				Polk Street Northbound				Industrial Drive Eastbound				Int. Total
	Right	Thru	Left	App. Total	Right	Thru	Left	App. Total	Right	Thru	Left	App. Total	Right	Thru	Left	App. Total	
Peak Hour Analysis From 07:00 to 08:45 - Peak 1 of 1																	
Peak Hour for Entire Intersection Begins at 07:15																	
07:15	38	129	11	178	10	0	1	11	4	222	36	262	10	0	12	22	473
07:30	24	93	7	124	1	1	0	2	5	219	13	237	9	0	19	28	391
07:45	51	129	16	196	3	0	2	5	4	235	34	273	6	0	14	20	494
08:00	47	101	4	152	4	1	1	6	1	182	15	198	13	0	16	29	385
Total Volume	160	452	38	650	18	2	4	24	14	858	98	970	38	0	61	99	1743
% App. Total	24.6	69.5	5.8		75	8.3	16.7		1.4	88.5	10.1		38.4	0	61.6		
PHF	.784	.876	.594	.829	.450	.500	.500	.545	.700	.913	.681	.888	.731	.000	.803	.853	.882

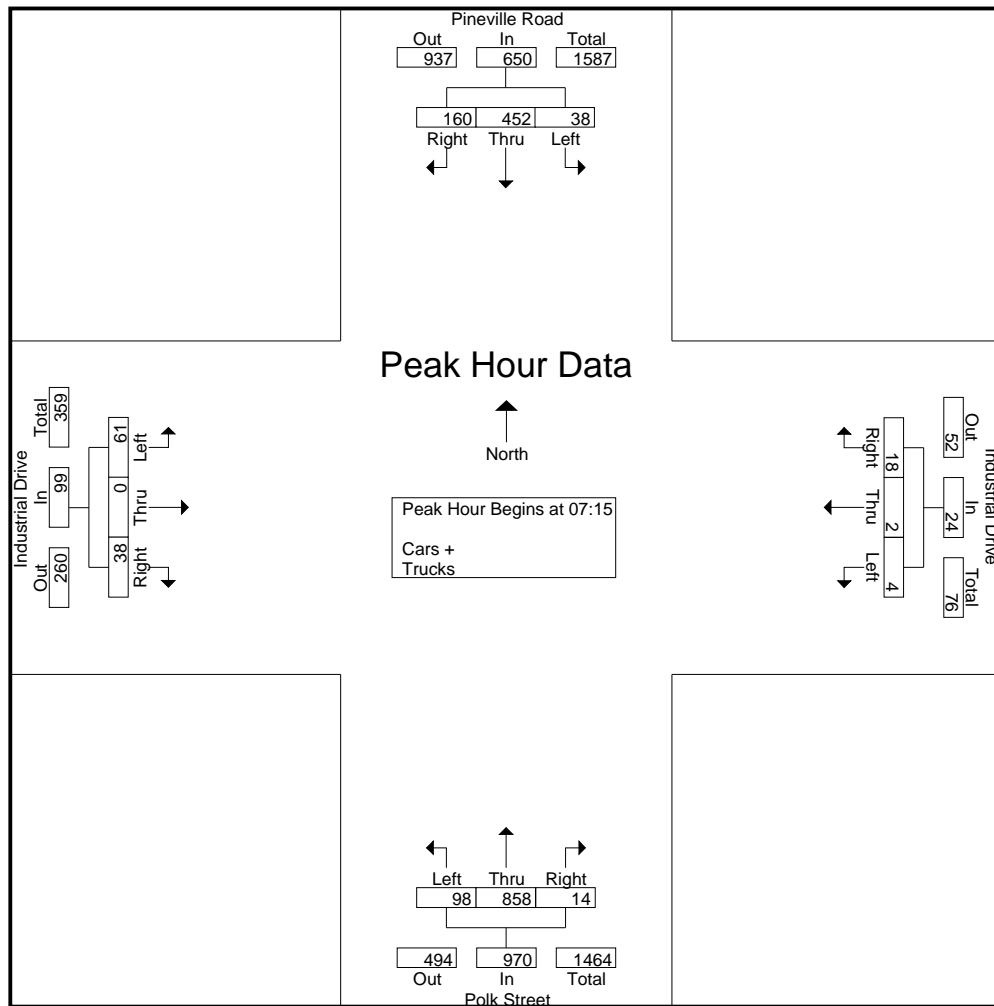

Burns Service Inc.

1202 Langdon Terrace Drive
Raleigh, NC, 27615

File Name : Pineville(Industrial and Polk) PM Peak

Site Code :

Start Date : 5/25/2017

Page No : 1

Groups Printed- Cars + - Trucks

Start Time	Pineville Road Southbound				Industrial Drive Westbound				Polk Street Northbound				Industrial Drive Eastbound				Int. Total
	Right	Thru	Left	App. Total	Right	Thru	Left	App. Total	Right	Thru	Left	App. Total	Right	Thru	Left	App. Total	
16:00	21	193	2	216	13	2	1	16	3	158	9	170	21	3	43	67	469
16:15	18	251	2	271	6	0	3	9	3	137	3	143	27	4	35	66	489
16:30	11	241	6	258	11	0	0	11	1	158	11	170	43	1	76	120	559
16:45	7	261	3	271	7	0	1	8	1	155	4	160	28	0	50	78	517
Total	57	946	13	1016	37	2	5	44	8	608	27	643	119	8	204	331	2034
17:00	20	255	2	277	13	1	4	18	2	220	8	230	31	0	59	90	615
17:15	16	277	1	294	12	0	3	15	3	213	10	226	15	3	45	63	598
17:30	24	282	3	309	11	0	0	11	2	152	9	163	19	1	49	69	552
17:45	19	303	1	323	4	0	2	6	3	177	6	186	13	0	16	29	544
Total	79	1117	7	1203	40	1	9	50	10	762	33	805	78	4	169	251	2309
Grand Total	136	2063	20	2219	77	3	14	94	18	1370	60	1448	197	12	373	582	4343
Apprch %	6.1	93	0.9		81.9	3.2	14.9		1.2	94.6	4.1		33.8	2.1	64.1		
Total %	3.1	47.5	0.5	51.1	1.8	0.1	0.3	2.2	0.4	31.5	1.4	33.3	4.5	0.3	8.6	13.4	
Cars +	125	2060	20	2205	76	3	14	93	18	1366	59	1443	196	12	363	571	4312
% Cars +	91.9	99.9	100	99.4	98.7	100	100	98.9	100	99.7	98.3	99.7	99.5	100	97.3	98.1	99.3
Trucks	11	3	0	14	1	0	0	1	0	4	1	5	1	0	10	11	31
% Trucks	8.1	0.1	0	0.6	1.3	0	0	1.1	0	0.3	1.7	0.3	0.5	0	2.7	1.9	0.7

Burns Service Inc.

1202 Langdon Terrace Drive
Raleigh, NC, 27615

File Name : Pineville(Industrial and Polk) PM Peak
Site Code :
Start Date : 5/25/2017
Page No : 2

Start Time	Pineville Road Southbound				Industrial Drive Westbound				Polk Street Northbound				Industrial Drive Eastbound				Int. Total
	Right	Thru	Left	App. Total	Right	Thru	Left	App. Total	Right	Thru	Left	App. Total	Right	Thru	Left	App. Total	
Peak Hour Analysis From 16:00 to 17:45 - Peak 1 of 1																	
Peak Hour for Entire Intersection Begins at 17:00																	
17:00	20	255	2	277	13	1	4	18	2	220	8	230	31	0	59	90	615
17:15	16	277	1	294	12	0	3	15	3	213	10	226	15	3	45	63	598
17:30	24	282	3	309	11	0	0	11	2	152	9	163	19	1	49	69	552
17:45	19	303	1	323	4	0	2	6	3	177	6	186	13	0	16	29	544
Total Volume	79	1117	7	1203	40	1	9	50	10	762	33	805	78	4	169	251	2309
% App. Total	6.6	92.9	0.6		80	2	18		1.2	94.7	4.1		31.1	1.6	67.3		
PHF	.823	.922	.583	.931	.769	.250	.563	.694	.833	.866	.825	.875	.629	.333	.716	.697	.939

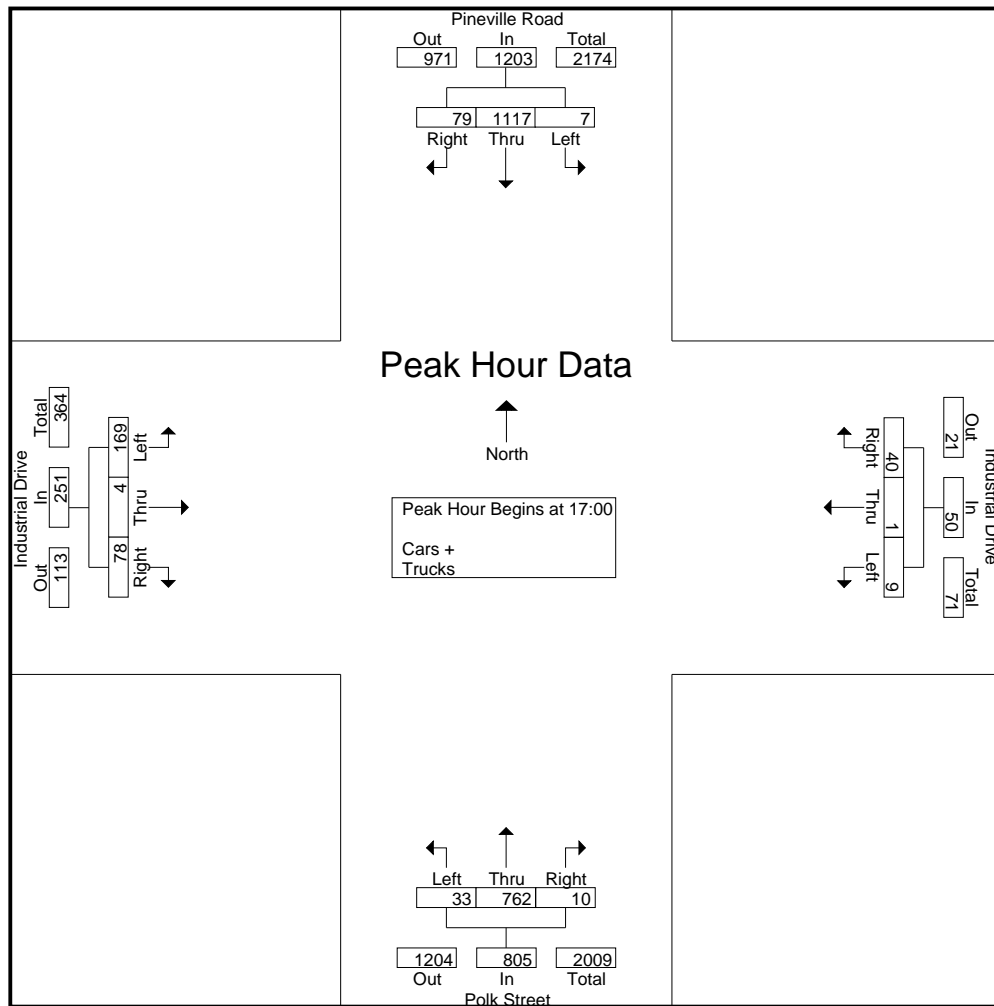

Burns Service Inc.
 1202Langdon Terrace Drive
 Indian Trail, NC, 28079

File Name : Pineville(Industrial N and Rodney)AM Peak

Site Code :

Start Date : 10/24/2017

Page No : 1

Groups Printed- Cars + - Trucks

Start Time	Rodney Street Westbound			Industrial Drive North Northbound			Rodney Street Eastbound			Int. Total
	Thru	Left	App. Total	Right	Left	App. Total	Right	Thru	App. Total	
07:00	8	4	12	2	2	4	15	4	19	35
07:15	11	2	13	1	0	1	5	10	15	29
07:30	11	0	11	0	25	25	14	8	22	58
07:45	11	4	15	1	3	4	6	11	17	36
Total	41	10	51	4	30	34	40	33	73	158
08:00	5	6	11	0	2	2	11	3	14	27
08:15	5	3	8	0	5	5	8	10	18	31
08:30	8	2	10	1	0	1	12	5	17	28
08:45	4	4	8	1	5	6	3	9	12	26
Total	22	15	37	2	12	14	34	27	61	112
Grand Total	63	25	88	6	42	48	74	60	134	270
Apprch %	71.6	28.4		12.5	87.5		55.2	44.8		
Total %	23.3	9.3	32.6	2.2	15.6	17.8	27.4	22.2	49.6	
Cars +	61	24	85	5	40	45	71	57	128	258
% Cars +	96.8	96	96.6	83.3	95.2	93.8	95.9	95	95.5	95.6
Trucks	2	1	3	1	2	3	3	3	6	12
% Trucks	3.2	4	3.4	16.7	4.8	6.2	4.1	5	4.5	4.4

Burns Service Inc.

1202 Langdon Terrace Drive
Indian Trail, NC, 28079

File Name : Pineville(Industrial N and Rodney)AM Peak
Site Code :
Start Date : 10/24/2017
Page No : 2

Start Time	Rodney Street Westbound			Industrial Drive North Northbound			Rodney Street Eastbound			Int. Total
	Thru	Left	App. Total	Right	Left	App. Total	Right	Thru	App. Total	
Peak Hour Analysis From 07:00 to 08:45 - Peak 1 of 1										
Peak Hour for Entire Intersection Begins at 07:00										
07:00	8	4	12	2	2	4	15	4	19	35
07:15	11	2	13	1	0	1	5	10	15	29
07:30	11	0	11	0	25	25	14	8	22	58
07:45	11	4	15	1	3	4	6	11	17	36
Total Volume	41	10	51	4	30	34	40	33	73	158
% App. Total	80.4	19.6		11.8	88.2		54.8	45.2		
PHF	.932	.625	.850	.500	.300	.340	.667	.750	.830	.681

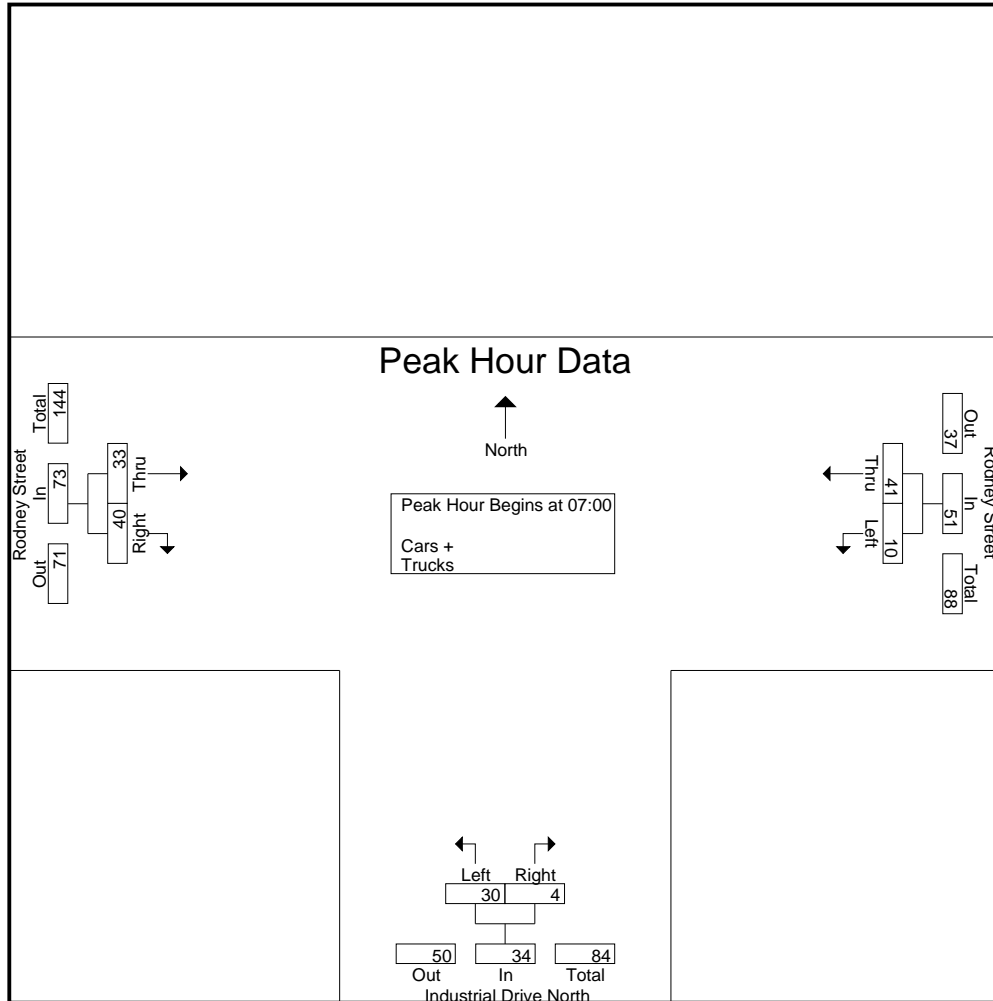

Burns Service Inc.
 1202Langdon Terrace Drive
 Indian Trail, NC, 28079

File Name : Pineville(Industrial N and Rodney)PM Peak

Site Code :

Start Date : 10/24/2017

Page No : 1

Groups Printed- Cars + - Trucks

Start Time	Rodney Street Westbound			Industrial Drive North Northbound			Rodney Street Eastbound			Int. Total
	Thru	Left	App. Total	Right	Left	App. Total	Right	Thru	App. Total	
16:00	23	4	27	7	5	12	3	10	13	52
16:15	8	3	11	5	7	12	6	12	18	41
16:30	37	1	38	3	8	11	5	15	20	69
16:45	12	1	13	4	15	19	5	15	20	52
Total	80	9	89	19	35	54	19	52	71	214
17:00	18	0	18	1	6	7	13	23	36	61
17:15	13	1	14	2	11	13	9	19	28	55
17:30	6	1	7	0	9	9	5	13	18	34
17:45	8	1	9	0	3	3	4	12	16	28
Total	45	3	48	3	29	32	31	67	98	178
Grand Total	125	12	137	22	64	86	50	119	169	392
Apprch %	91.2	8.8		25.6	74.4		29.6	70.4		
Total %	31.9	3.1	34.9	5.6	16.3	21.9	12.8	30.4	43.1	
Cars +	124	11	135	22	61	83	41	115	156	374
% Cars +	99.2	91.7	98.5	100	95.3	96.5	82	96.6	92.3	95.4
Trucks	1	1	2	0	3	3	9	4	13	18
% Trucks	0.8	8.3	1.5	0	4.7	3.5	18	3.4	7.7	4.6

Burns Service Inc.
 1202Langdon Terrace Drive
 Indian Trail, NC, 28079

File Name : Pineville(Industrial N and Rodney)PM Peak
 Site Code :
 Start Date : 10/24/2017
 Page No : 2

Start Time	Rodney Street Westbound			Industrial Drive North Northbound			Rodney Street Eastbound			Int. Total
	Thru	Left	App. Total	Right	Left	App. Total	Right	Thru	App. Total	
Peak Hour Analysis From 16:00 to 17:45 - Peak 1 of 1										
Peak Hour for Entire Intersection Begins at 16:30										
16:30	37	1	38	3	8	11	5	15	20	69
16:45	12	1	13	4	15	19	5	15	20	52
17:00	18	0	18	1	6	7	13	23	36	61
17:15	13	1	14	2	11	13	9	19	28	55
Total Volume	80	3	83	10	40	50	32	72	104	237
% App. Total	96.4	3.6		20	80		30.8	69.2		
PHF	.541	.750	.546	.625	.667	.658	.615	.783	.722	.859

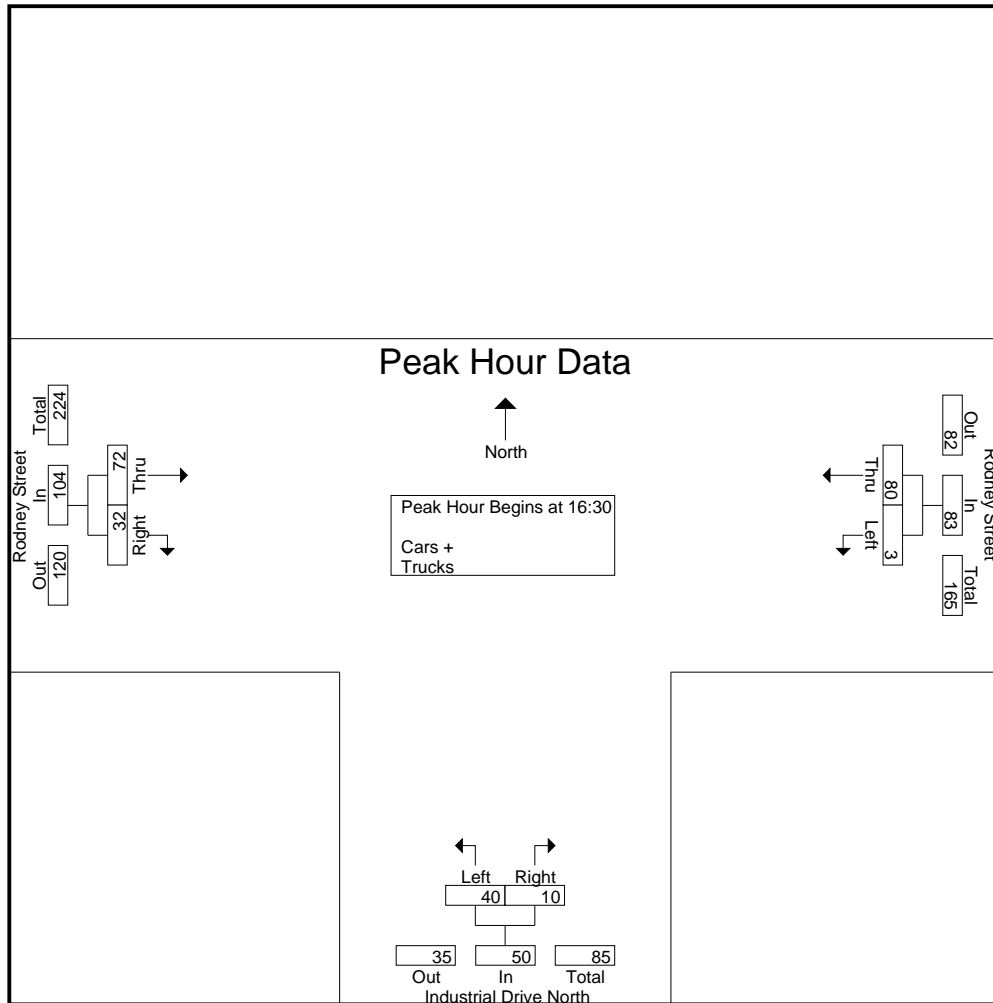

Burns Service Inc.

1202Langdon Terrace Drive
Indian Trail, NC, 28079

File Name : Pineville(Industrial Northern RR Crossing)AM Peak

Site Code :

Start Date : 10/24/2017

Page No : 1

Groups Printed- Cars + - Trucks

Start Time	Industrial Drive South Southbound		Industrial Drive North Northbound		Int. Total
	Thru	App. Total	Thru	App. Total	
07:00	9	9	5	5	14
07:15	8	8	0	0	8
07:30	11	11	2	2	13
07:45	3	3	3	3	6
Total	31	31	10	10	41
08:00	11	11	1	1	12
08:15	5	5	5	5	10
08:30	8	8	1	1	9
08:45	7	7	3	3	10
Total	31	31	10	10	41
Grand Total	62	62	20	20	82
Apprch %	100		100		
Total %	75.6	75.6	24.4	24.4	
Cars +	60	60	18	18	78
% Cars +	96.8	96.8	90	90	95.1
Trucks	2	2	2	2	4
% Trucks	3.2	3.2	10	10	4.9

Burns Service Inc.

1202 Langdon Terrace Drive
Indian Trail, NC, 28079

File Name : Pineville(Industrial Northern RR Crossing)AM Peak

Site Code :

Start Date : 10/24/2017

Page No : 2

Start Time	Industrial Drive South Southbound		Industrial Drive North Northbound		Int. Total
	Thru	App. Total	Thru	App. Total	
Peak Hour Analysis From 07:00 to 08:45 - Peak 1 of 1					
Peak Hour for Entire Intersection Begins at 07:00					
07:00	9	9	5	5	14
07:15	8	8	0	0	8
07:30	11	11	2	2	13
07:45	3	3	3	3	6
Total Volume	31	31	10	10	41
% App. Total	100		100		
PHF	.705	.705	.500	.500	.732

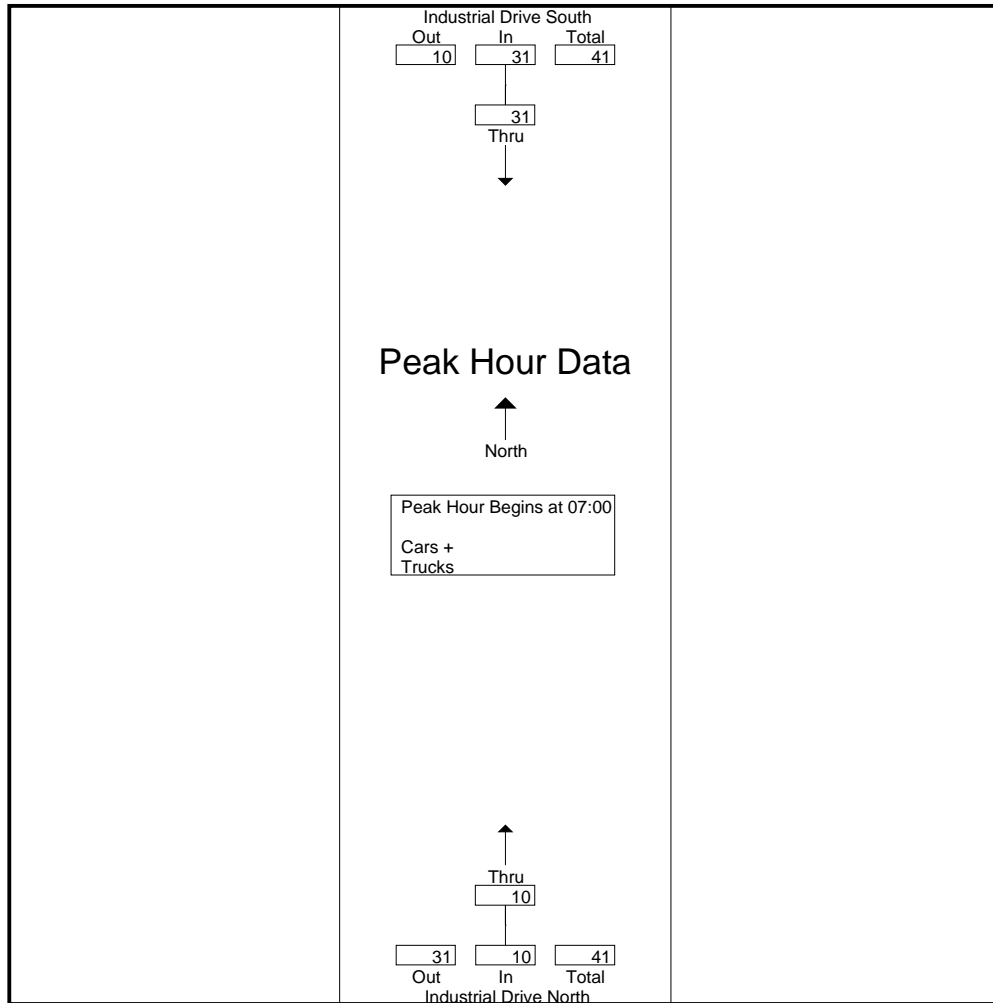

Burns Service Inc.

1202Langdon Terrace Drive
Indian Trail, NC, 28079

File Name : Pineville(Industrial Northern RR Crossing)PM Peak

Site Code :

Start Date : 10/24/2017

Page No : 1

Groups Printed- Cars + - Trucks

Start Time	Industrial Drive South Southbound		Industrial Drive North Northbound		Int. Total
	Thru	App. Total	Thru	App. Total	
16:00	0	0	0	0	0
16:15	3	3	4	4	7
16:30	2	2	2	2	4
16:45	6	6	10	10	16
Total	11	11	16	16	27
17:00	14	14	2	2	16
17:15	9	9	5	5	14
17:30	5	5	10	10	15
17:45	2	2	2	2	4
Total	30	30	19	19	49
Grand Total	41	41	35	35	76
Apprch %	100		100		
Total %	53.9	53.9	46.1	46.1	
Cars +	34	34	35	35	69
% Cars +	82.9	82.9	100	100	90.8
Trucks	7	7	0	0	7
% Trucks	17.1	17.1	0	0	9.2

Burns Service Inc.

1202 Langdon Terrace Drive
Indian Trail, NC, 28079

File Name : Pineville(Industrial Northern RR Crossing)PM Peak

Site Code :

Start Date : 10/24/2017

Page No : 2

Start Time	Industrial Drive South Southbound		Industrial Drive North Northbound		Int. Total
	Thru	App. Total	Thru	App. Total	
Peak Hour Analysis From 16:00 to 17:45 - Peak 1 of 1					
Peak Hour for Entire Intersection Begins at 16:45					
16:45	6	6	10	10	16
17:00	14	14	2	2	16
17:15	9	9	5	5	14
17:30	5	5	10	10	15
Total Volume	34	34	27	27	61
% App. Total	100		100		
PHF	.607	.607	.675	.675	.953

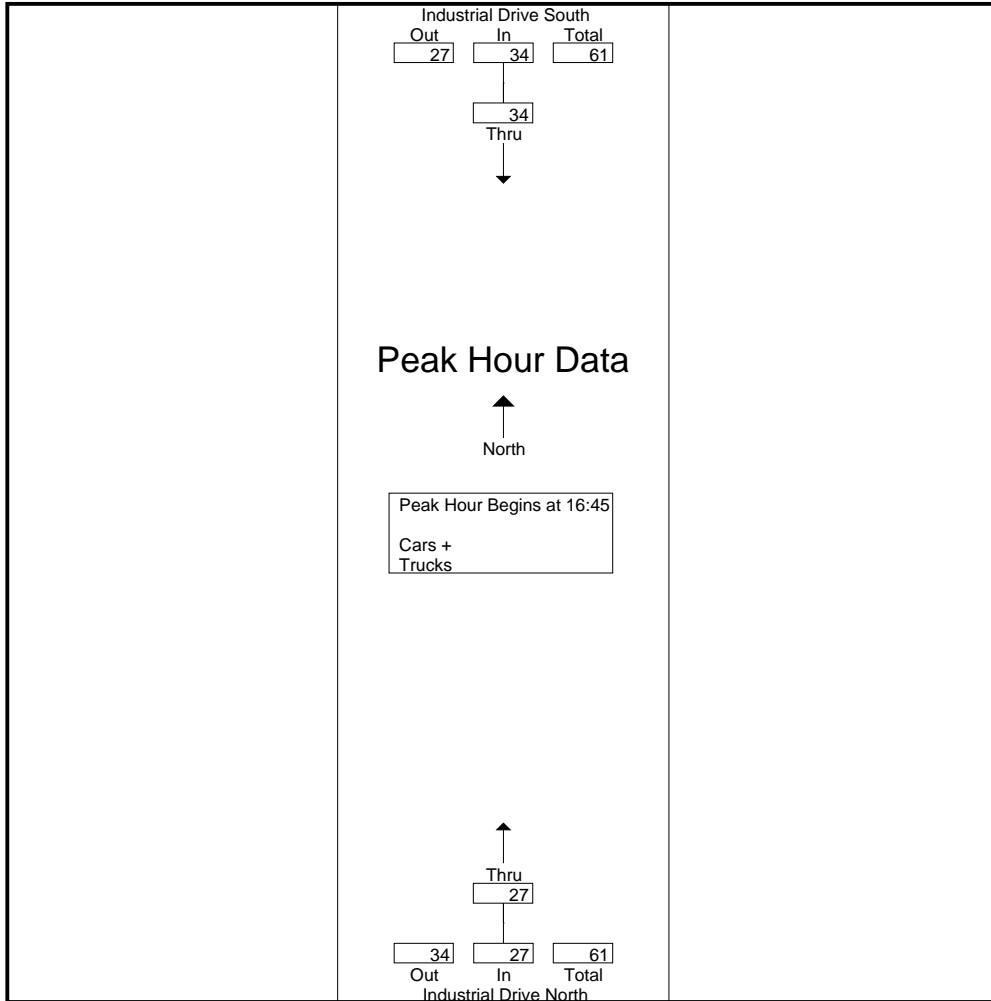

Burns Service Inc.
 1202Langdon Terrace Drive
 Indian Trail, NC, 28079

File Name : Pineville(Industrial Southern RR Crossing)AM Peak

Site Code :

Start Date : 10/24/2017

Page No : 1

Groups Printed- Cars + - Trucks

Start Time	Industrial Southern railroad Westbound		Industrial Southern railroad Eastbound		Int. Total
	Thru	App. Total	Thru	App. Total	
07:00	63	63	38	38	101
07:15	54	54	28	28	82
07:30	48	48	17	17	65
07:45	69	69	24	24	93
Total	234	234	107	107	341
08:00	66	66	19	19	85
08:15	54	54	20	20	74
08:30	36	36	30	30	66
08:45	34	34	25	25	59
Total	190	190	94	94	284
Grand Total	424	424	201	201	625
Apprch %	100		100		
Total %	67.8	67.8	32.2	32.2	
Cars +	402	402	184	184	586
% Cars +	94.8	94.8	91.5	91.5	93.8
Trucks	22	22	17	17	39
% Trucks	5.2	5.2	8.5	8.5	6.2

Burns Service Inc.

1202 Langdon Terrace Drive
Indian Trail, NC, 28079

File Name : Pineville(Industrial Southern RR Crossing)AM Peak

Site Code :

Start Date : 10/24/2017

Page No : 2

Start Time	Industrial Southern railroad Westbound		Industrial Southern railroad Eastbound		Int. Total
	Thru	App. Total	Thru	App. Total	
Peak Hour Analysis From 07:00 to 08:45 - Peak 1 of 1					
Peak Hour for Entire Intersection Begins at 07:00					
07:00	63	63	38	38	101
07:15	54	54	28	28	82
07:30	48	48	17	17	65
07:45	69	69	24	24	93
Total Volume	234	234	107	107	341
% App. Total	100		100		
PHF	.848	.848	.704	.704	.844

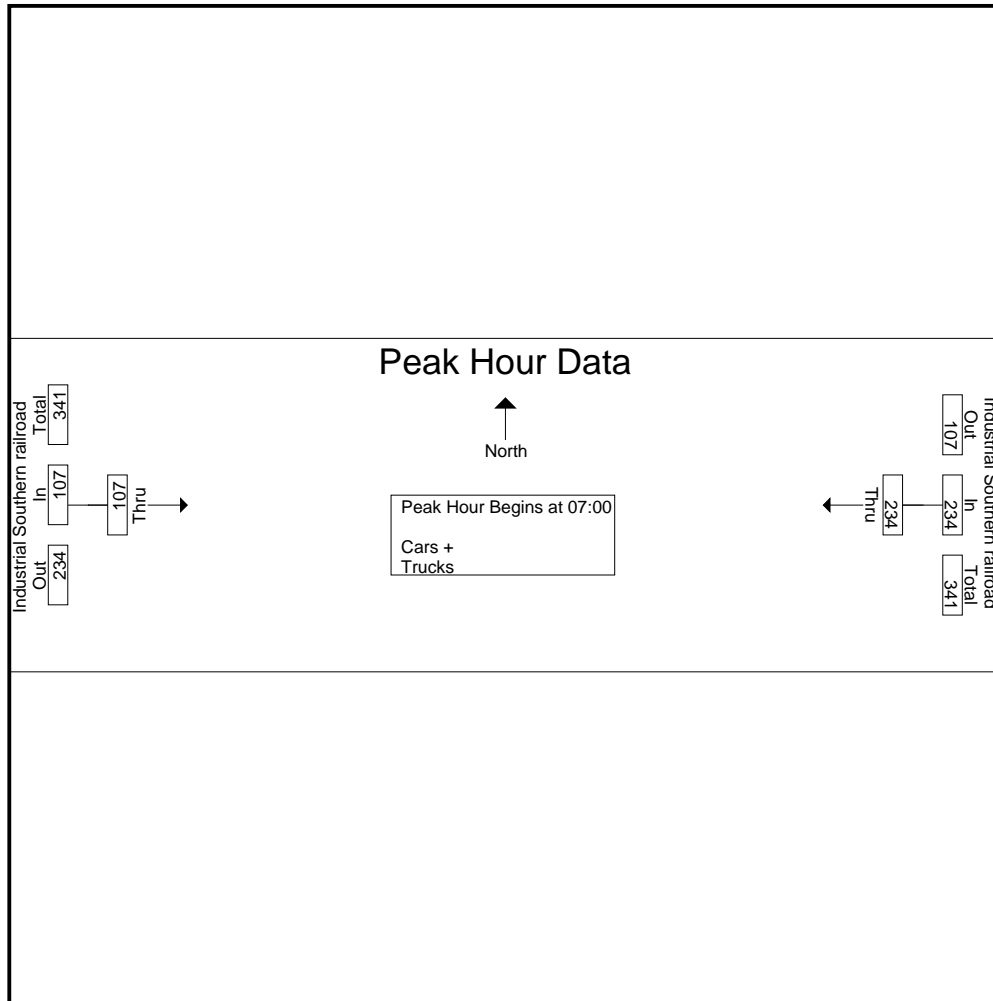

Burns Service Inc.

1202Langdon Terrace Drive
Indian Trail, NC, 28079

File Name : Pineville(Industrial Southern RR Crossing)PM Peak

Site Code :

Start Date : 10/24/2017

Page No : 1

Groups Printed- Cars + - Trucks

Start Time	Industrial Southern railroad Westbound		Industrial Southern railroad Eastbound		Int. Total
	Thru	App. Total	Thru	App. Total	
16:00	28	28	96	96	124
16:15	24	24	66	66	90
16:30	23	23	114	114	137
16:45	20	20	66	66	86
Total	95	95	342	342	437
17:00	23	23	96	96	119
17:15	22	22	66	66	88
17:30	19	19	38	38	57
17:45	21	21	44	44	65
Total	85	85	244	244	329
Grand Total	180	180	586	586	766
Apprch %	100		100		
Total %	23.5	23.5	76.5	76.5	
Cars +	158	158	564	564	722
% Cars +	87.8	87.8	96.2	96.2	94.3
Trucks	22	22	22	22	44
% Trucks	12.2	12.2	3.8	3.8	5.7

Burns Service Inc.

1202 Langdon Terrace Drive
Indian Trail, NC, 28079

File Name : Pineville(Industrial Southern RR Crossing)PM Peak

Site Code :

Start Date : 10/24/2017

Page No : 2

Start Time	Industrial Southern railroad Westbound		Industrial Southern railroad Eastbound		Int. Total
	Thru	App. Total	Thru	App. Total	
Peak Hour Analysis From 16:00 to 17:45 - Peak 1 of 1					
Peak Hour for Entire Intersection Begins at 16:00					
16:00	28	28	96	96	124
16:15	24	24	66	66	90
16:30	23	23	114	114	137
16:45	20	20	66	66	86
Total Volume	95	95	342	342	437
% App. Total	100		100		
PHF	.848	.848	.750	.750	.797

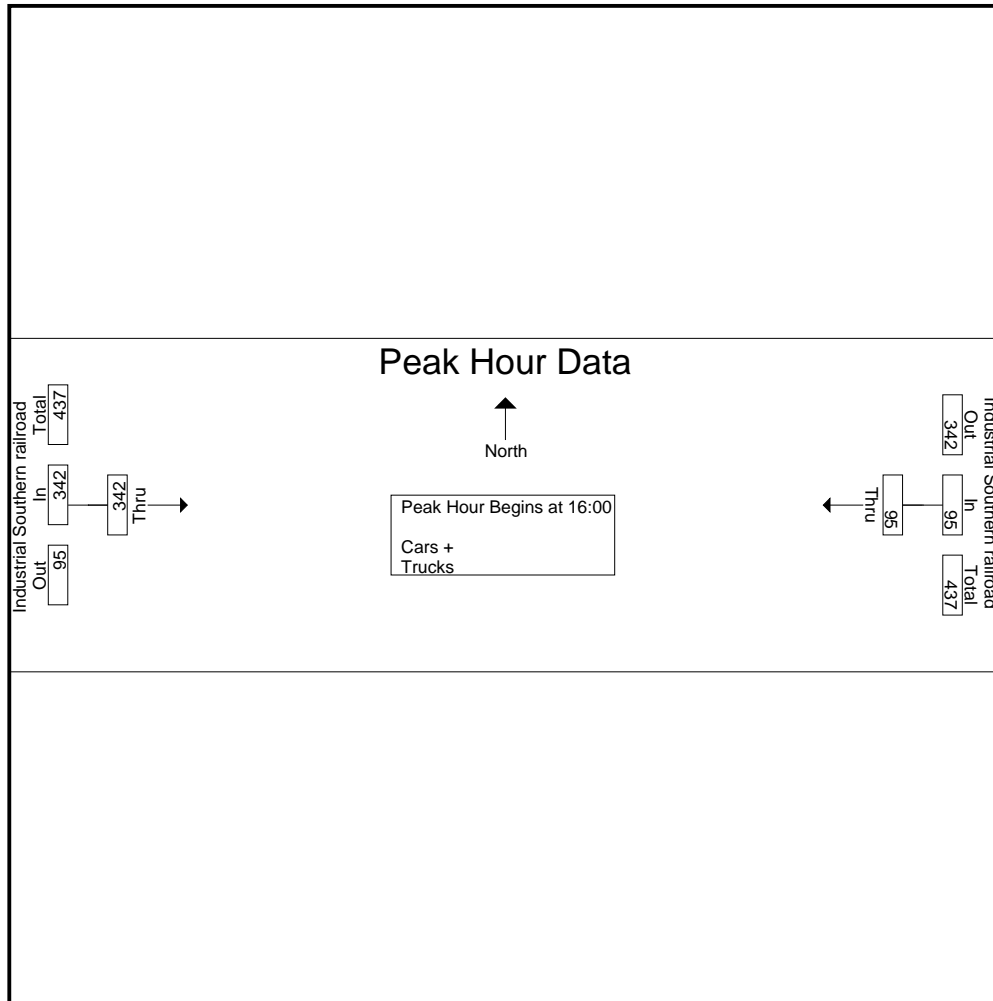

Appendix B – Accident Data

**North Carolina Department of Transportation
Traffic Engineering Accident Analysis System
Fiche, Intersection, and Strip Reports Code Index**

T - Type of Accident Codes

0 = UNKNOWN
 1 = RAN OFF ROAD - RIGHT
 2 = RAN OFF ROAD - LEFT
 3 = RAN OFF ROAD - STRAIGHT
 4 = JACKKNIFE
 5 = OVERTURN/ROLLOVER
 13 = OTHER NON-COLLISION
 14 = PEDESTRIAN
 15 = PEDALCYCLIST
 16 = RR TRAIN, ENGINE
 17 = ANIMAL
 18 = MOVABLE OBJECT
 19 = FIXED OBJECT
 20 = PARKED MOTOR VEHICLE
 21 = REAR END, SLOW OR STOP
 22 = REAR END, TURN
 23 = LEFT TURN, SAME ROADWAY
 24 = LEFT TURN, DIFFERENT ROADWAYS
 25 = RIGHT TURN, SAME ROADWAY
 26 = RIGHT TURN, DIFFERENT ROADWAYS
 27 = HEAD ON
 28 = SIDESWIPE, SAME DIRECTION
 29 = SIDESWIPE, OPPOSITE DIRECTION
 30 = ANGLE
 31 = BACKING UP
 32 = OTHER COLLISION WITH VEHICLE

F - Road Feature Codes

0 = NO SPECIAL FEATURE
 1 = BRIDGE
 2 = BRIDGE APPROACH
 3 = UNDERPASS
 4 = DRIVEWAY, PUBLIC
 5 = DRIVEWAY, PRIVATE
 6 = ALLEY INTERSECTION
 7 = FOUR-WAY INTERSECTION
 8 = T-INTERSECTION
 9 = Y-INTERSECTION
 10 = TRAFFIC CIRCLE/ROUNDBOUT
 11 = FIVE-POINT, OR MORE
 12 = RELATED TO INTERSECTION
 13 = NON-INTERSECTION MEDIAN CROSSING
 14 = END OR BEGINNING - DIVIDED HIGHWAY
 15 = OFF RAMP ENTRY
 16 = OFF RAMP PROPER
 17 = OFF RAMP TERMINAL ON CROSSROAD
 18 = MERGE LANE BETWEEN ON AND OFF RAMP
 19 = ON RAMP ENTRY
 20 = ON RAMP PROPER
 21 = ON RAMP TERMINAL ON CROSSROAD
 22 = RAILROAD CROSSING
 23 = TUNNEL
 24 = SHARED-USE PATHS OR TRAILS
 25 = OTHER

R - Road Condition Codes

1 = DRY
 2 = WET
 3 = WATER (STANDING, MOVING)
 4 = ICE
 5 = SNOW
 6 = SLUSH
 7 = SAND, MUD, DIRT, GRAVEL
 8 = FUEL, OIL
 9 = OTHER
 10 = UNKNOWN

L - Light Condition Codes

1 = DAYLIGHT
 2 = DUSK
 3 = DAWN
 4 = DARK - LIGHTED ROADWAY
 5 = DARK - ROADWAY NOT LIGHTED
 6 = DARK - UNKNOWN LIGHTING
 7 = OTHER
 8 = UNKNOWN

W - Weather Condition Codes

1 = CLEAR
 2 = CLOUDY
 3 = RAIN
 4 = SNOW
 5 = FOG, SMOG, SMOKE
 6 = SLEET, HAIL, FREEZING RAIN/DRIZZLE
 7 = SEVERE CROSSWINDS
 8 = BLOWING SAND, DIRT, SNOW
 9 = OTHER

S - Accident Severity Codes

K = FATAL
 A = A-LEVEL INJURY
 B = B-LEVEL INJURY
 C = C-LEVEL INJURY
 O = PROPERTY DAMAGE ONLY

Ch - Road Character

1 = STRAIGHT, LEVEL
 2 = STRAIGHT, HILLCREST
 3 = STRAIGHT, GRADE
 4 = STRAIGHT, BOTTOM (SAG)
 5 = CURVE, LEVEL
 6 = CURVE, HILLCREST
 7 = CURVE, GRADE
 8 = CURVE, BOTTOM (SAG)
 9 = OTHER

Op - Traffic Control Operating

1 = YES
 2 = NO
 3 = UNKNOWN

**North Carolina Department of Transportation
Traffic Engineering Accident Analysis System
Fiche, Intersection, and Strip Reports Code Index**

Veh Mnvr - Vehicle Maneuver Codes

1 = STOPPED IN TRAVEL LANE
2 = PARKED OUT OF TRAVEL LANES
3 = PARKED IN TRAVEL LANES
4 = GOING STRAIGHT AHEAD
5 = CHANGING LANES OR MERGING
6 = PASSING
7 = MAKING RIGHT TURN
8 = MAKING LEFT TURN
9 = MAKING U-TURN
10 = BACKING
11 = SLOWING OR STOPPING
12 = STARTING IN ROADWAY
13 = PARKING
14 = LEAVING PARKED POSITION
15 = AVOIDING OBJECT IN ROAD

Dv - Traffic Control Device

0 = NO CONTROL PRESENT
1 = STOP SIGN
2 = YIELD SIGN
3 = STOP AND GO SIGNAL
4 = FLASHING SIGNAL WITH STOP SIGN
5 = FLASHING SIGNAL WITHOUT STOP SIGN
6 = RR GATE AND FLASHER
7 = RR FLASHER
8 = RR CROSSBUCKS ONLY
9 = HUMAN CONTROL
10 = WARNING SIGN
11 = SCHOOL ZONE SIGNS
12 = FLASHING STOP AND GO SIGNAL
13 = DOUBLE YELLOW LINE, NO PASSING ZONE
14 = OTHER

Alchl/Drugs - Driver Alcohol/Drugs Suspected Status Codes

0 = NO
1 = YES - ALCOHOL, IMPAIRMENT SUSPECTED
2 = YES - ALCOHOL, NO IMPAIRMENT DETECTED
3 = YES - OTHER DRUGS, IMPAIRMENT SUSPECTED
4 = YES - OTHER DRUGS, NO IMPAIRMENT DETECTED
5 = YES - ALCOHOL AND OTHER DRUGS, IMPAIRMENT SUSPECTED
6 = YES - ALCOHOL AND OTHER DRUGS, NO IMPAIRMENT DETECTED
7 = UNKNOWN

Ped Actn - Pedestrian Action Codes

1 = ENTERING OR CROSSING SPECIFIED LOCATION
2 = WALKING, RIDING, RUNNING/JOGGING WITH TRAFFIC
3 = WALKING, RIDING, RUNNING/JOGGING AGAINST TRAFFIC
4 = WORKING
5 = PUSHING VEHICLE
6 = APPROACHING OR LEAVING VEHICLE
7 = PLAYING
8 = STANDING
9 = OTHER

Ci - Roadway Contributing Circumstances

0 = NONE (NO UNUSUAL CONDITIONS)
1 = ROAD SURFACE CONDITION
2 = DEBRIS
3 = RUT, HOLES, BUMPS
4 = WORK ZONE (CONSTRUCTION, MAINTENANCE, UTILITY)
5 = WORN TRAVEL-POLISHED SURFACE
6 = OBSTRUCTION IN ROADWAY
7 = TRAFFIC CONTROL DEVICE INOPERATIVE, NOT VISIBLE OR MISSING
8 = SHOULDERS LOW, SOFT OR HIGH
9 = NO SHOULDERS
10 = NON-HIGHWAY WORK
11 = OTHER
12 = UNKNOWN

**North Carolina Department of Transportation
Traffic Engineering Accident Analysis System
Fiche, Intersection, and Strip Reports Code Index**

Obj Strk - Object Struck Codes

14 = PEDESTRIAN
15 = PEDALCYCLIST
17 = ANIMAL
18 = MOVABLE OBJECT
20 = PARKED MOTOR VEHICLE
33 = TREE
34 = UTILITY POLE
35 = LUMINAIRE POLE NON-BREAKAWAY
36 = LUMINAIRE POLE BREAKAWAY
37 = OFFICIAL HIGHWAY SIGN NON-BREAKAWAY
38 = OFFICIAL HIGHWAY SIGN BREAKAWAY
39 = OVERHEAD SIGN SUPPORT
40 = COMMERCIAL SIGN
41 = GUARDRAIL END ON SHOULDER
42 = GUARDRAIL FACE ON SHOULDER
43 = GUARDRAIL END IN MEDIAN
44 = GUARDRAIL FACE IN MEDIAN
45 = SHOULDER BARRIER END
46 = SHOULDER BARRIER FACE
47 = MEDIAN BARRIER END
48 = MEDIAN BARRIER FACE
49 = BRIDGE RAIL END
50 = BRIDGE RAIL FACE
51 = OVERHEAD PART UNDERPASS
52 = PIER ON SHOULDER OF UNDERPASS
53 = PIER IN MEDIAN OF UNDERPASS
54 = ABUTMENT OF UNDERPASS
55 = TRAFFIC ISLAND CURB OR MEDIAN
56 = CATCH BASIN OR CULVERT ON SHOULDER
57 = CATCH BASIN OR CULVERT ON MEDIAN
58 = DITCH
59 = EMBANKMENT
60 = MAILBOX
61 = FENCE OR FENCE POST
62 = CONSTRUCTION BARRIER
63 = CRASH CUSHION
64 = OTHER FIXED OBJECT

Unit # - Vehicle Style Codes

1 = PASSENGER CAR
2 = PICKUP
3 = LIGHT TRUCK (MINI-VAN, PANEL)
4 = SPORT UTILITY
5 = VAN
6 = COMMERCIAL BUS
7 = SCHOOL BUS
8 = ACTIVITY BUS
9 = OTHER BUS
10 = SINGLE UNIT TRUCK (2-AXLE, 6-TIRE)
11 = SINGLE UNIT TRUCK (3 OR MORE AXLES)
12 = TRUCK/TRAILER
13 = TRUCK/TRACTOR
14 = TRACTOR/SEMI-TRAILER
15 = TRACTOR/DOULBES
16 = UNKNOWN HEAVY TRUCK
17 = TAXICAB
18 = FARM EQUIPMENT
19 = FARM TRACTOR
20 = MOTORCYCLE
21 = MOPED
22 = MOTOR SCOOTER OR MOTOR BIKE
23 = PEDALCYCLE
24 = PEDESTRIAN
25 = MOTOR HOME/RECREATIONAL VEHICLE
26 = OTHER
27 = ALL TERRAIN VEHICLE (ATV)
28 = FIRETRUCK
29 = EMS VEHICLE, AMBULANCE, RESCUE SQUAD
30 = MILITARY
31 = POLICE
32 = UNKNOWN

North Carolina Department of Transportation
Traffic Engineering Accident Analysis System
Intersection Analysis Report

Study Criteria Summary

County: MECKLENBURG City: All and Rural
Date: 05/01/2012 to 04/30/2017 Study: 41000047242
Location: US 521 (Peik St-Pineville Rd) at SR 3542 (Industrial Dr). **Crash rates contained in this analysis should not be used**

Report Details

Acc No	Crash ID	Date	Accident Type	Total Damage	Injuries			Condition			Road			Trfc Ctl	
					F	A	B	C	R	L	W	Ch	Cl	Dv	Op
1	103473281	05/23/2012 15:13	REAR END, SLOW OR STOP	\$ 2000	0	0	0	0	1	1	1	1	0	3	1
Unit	1 : 1	Alchl/Drgs: 0	Speed: 10 MPH Dir: S	Veh Mnvr / Ped Actn: 11	Obj Strk:										
Unit	2 : 1	Alchl/Drgs: 0	Speed: 0 MPH Dir: S	Veh Mnvr / Ped Actn: 11	Obj Strk:										
2	103600255	10/27/2012 10:30	REAR END, SLOW OR STOP	\$ 11200	0	0	0	2	1	1	2	1	0	3	1
Unit	1 : 1	Alchl/Drgs: 0	Speed: 35 MPH Dir: S	Veh Mnvr / Ped Actn: 4	Obj Strk:										
Unit	2 : 1	Alchl/Drgs: 0	Speed: 25 MPH Dir: S	Veh Mnvr / Ped Actn: 11	Obj Strk:	20									
Unit	3 : 1	Alchl/Drgs: 7	Speed: 0 MPH Dir: W	Veh Mnvr / Ped Actn: 2	Obj Strk:	20									
3	103720686	02/15/2013 22:34	ANGLE	\$ 3400	0	0	0	0	1	5	1	1	0	3	1
Unit	1 : 4	Alchl/Drgs: 0	Speed: 20 MPH Dir: S	Veh Mnvr / Ped Actn: 4	Obj Strk:										
Unit	2 : 10	Alchl/Drgs: 0	Speed: 15 MPH Dir: E	Veh Mnvr / Ped Actn: 7	Obj Strk:										
4	103751319	04/29/2013 13:01	LEFT TURN, SAME ROADWAY	\$ 7500	0	0	0	0	1	1	2	3	0	3	1
Unit	1 : 1	Alchl/Drgs: 0	Speed: 5 MPH Dir: W	Veh Mnvr / Ped Actn: 8	Obj Strk:										
Unit	2 : 1	Alchl/Drgs: 0	Speed: 35 MPH Dir: S	Veh Mnvr / Ped Actn: 4	Obj Strk:										
5	103918119	10/17/2013 17:53	REAR END, SLOW OR STOP	\$ 7000	0	0	0	2	2	1	3	1	0		
Unit	1 : 1	Alchl/Drgs: 0	Speed: 25 MPH Dir: N	Veh Mnvr / Ped Actn: 4	Obj Strk:										
Unit	2 : 5	Alchl/Drgs: 0	Speed: 0 MPH Dir: N	Veh Mnvr / Ped Actn: 1	Obj Strk:										
6	103983348	12/27/2013 17:37	REAR END, SLOW OR STOP	\$ 1200	0	0	0	0	1	4	1	1	0	0	
Unit	1 : 4	Alchl/Drgs: 0	Speed: 5 MPH Dir: N	Veh Mnvr / Ped Actn: 12	Obj Strk:										
Unit	2 : 4	Alchl/Drgs: 0	Speed: 5 MPH Dir: N	Veh Mnvr / Ped Actn: 1	Obj Strk:										
7	104009922	02/08/2014 16:24	REAR END, SLOW OR STOP	\$ 2500	0	0	0	0	1	1	1	1	0		
Unit	1 : 1	Alchl/Drgs: 0	Speed: 25 MPH Dir: S	Veh Mnvr / Ped Actn: 4	Obj Strk:										
Unit	2 : 1	Alchl/Drgs: 0	Speed: 5 MPH Dir: S	Veh Mnvr / Ped Actn: 11	Obj Strk:										
8	104028058	03/08/2014 10:22	REAR END, SLOW OR STOP	\$ 3250	0	0	0	0	1	1	1	1	0	3	1
Unit	1 : 4	Alchl/Drgs: 0	Speed: 40 MPH Dir: S	Veh Mnvr / Ped Actn: 4	Obj Strk:										

06/27/2017

-1-

North Carolina Department of Transportation
Traffic Engineering Accident Analysis System
Intersection Analysis Report

Acc No	Crash ID	Date	Accident Type	Total Damage	Injuries			Condition			Road			Trfc Ctl	
					F	A	B	C	R	L	W	Ch	Cl	Dv	Op
18	104448464	07/30/2015 12:05	RAN OFF ROAD - RIGHT	\$ 1805	0	0	0	1	1	1	1	1	0	5	1
Unit	1 : 2	Alchl/Drgs: 0	Speed: 35 MPH Dir: NE	Veh Mnvr / Ped Actn: 8	Obj Strk:										
Unit	2 : 1	Alchl/Drgs: 0	Speed: 35 MPH Dir: SW	Veh Mnvr / Ped Actn: 4	Obj Strk:	18									
19	104508930	10/05/2015 11:48	REAR END, SLOW OR STOP	\$ 9500	0	0	0	1	1	1	2	1	0	3	1
Unit	1 : 5	Alchl/Drgs: 0	Speed: 30 MPH Dir: S	Veh Mnvr / Ped Actn: 4	Obj Strk:										
Unit	2 : 2	Alchl/Drgs: 7	Speed: 0 MPH Dir: S	Veh Mnvr / Ped Actn: 1	Obj Strk:										
20	104551911	11/12/2015 20:10	LEFT TURN, DIFFERENT ROADWAYS	\$ 2000	0	0	0	0	1	4	1	1	0	3	1
Unit	1 : 4	Alchl/Drgs: 0	Speed: 35 MPH Dir: N	Veh Mnvr / Ped Actn: 4	Obj Strk:										
Unit	2 : 1	Alchl/Drgs: 0	Speed: 15 MPH Dir: E	Veh Mnvr / Ped Actn: 8	Obj Strk:										
21	104606113	12/04/2015 23:27	ANGLE	\$ 4000	0	0	0	2	1	4	1	1	0	3	1
Unit	1 : 4	Alchl/Drgs: 0	Speed: 35 MPH Dir: S	Veh Mnvr / Ped Actn: 4	Obj Strk:										
Unit	2 : 5	Alchl/Drgs: 0	Speed: 4 MPH Dir: E	Veh Mnvr / Ped Actn: 4	Obj Strk:										
22	104630745	02/01/2016 14:20	ANGLE	\$ 9000	0	0	0	1	1	1	1	3	0	3	1
Unit	1 : 1	Alchl/Drgs: 0	Speed: 35 MPH Dir: N	Veh Mnvr / Ped Actn: 4	Obj Strk:										
Unit	2 : 2	Alchl/Drgs: 0	Speed: 5 MPH Dir: W	Veh Mnvr / Ped Actn: 4	Obj Strk:										
23	104889056	10/25/2016 15:06	LEFT TURN, SAME ROADWAY	\$ 9000	0	0	0	0	1	1	1	1	0	3	1
Unit	1 : 1	Alchl/Drgs: 0	Speed: 8 MPH Dir: N	Veh Mnvr / Ped Actn: 8	Obj Strk:										
Unit	2 : 2	Alchl/Drgs: 0	Speed: 30 MPH Dir: S	Veh Mnvr / Ped Actn: 4	Obj Strk:										
24	104912808	11/10/2016 08:31	REAR END, SLOW OR STOP	\$ 3000	0	0	0	0	1	1	1	1	0	0	
Unit	1 : 1	Alchl/Drgs: 0	Speed: 15 MPH Dir: E	Veh Mnvr / Ped Actn: 4	Obj Strk:										
Unit	2 : 3	Alchl/Drgs: 7	Speed: 0 MPH Dir: E	Veh Mnvr / Ped Actn: 1	Obj Strk:										
25	104932924	11/29/2016 11:53	BACKING UP	\$ 1500	0	0	0	0	2	1	2	1	0	3	1
Unit	1 : 2	Alchl/Drgs: 7	Speed: 2 MPH Dir: N	Veh Mnvr / Ped Actn: 10	Obj Strk:										
Unit	2 : 1	Alchl/Drgs: 0	Speed: 1 MPH Dir: S	Veh Mnvr / Ped Actn: 1	Obj Strk:										
26	104964447	01/03/2017 13:19	ANGLE	\$ 1500	0	0	0	0	1	1	2	1	0	3	1
Unit	1 : 14	Alchl/Drgs: 0	Speed: 20 MPH Dir: E	Veh Mnvr / Ped Actn: 8	Obj Strk:										
Unit	2 : 1	Alchl/Drgs: 7	Speed: 0 MPH Dir: W	Veh Mnvr / Ped Actn: 1	Obj Strk:										

06/27/2017

-3-

North Carolina Department of Transportation
Traffic Engineering Accident Analysis System
Intersection Analysis Report

Acc No	Crash ID	Date	Accident Type	Total Damage	Injuries			Condition			Road			Trfc Ctl	
					F	A	B	C	R	L	W	Ch	Cl	Dv	Op
Unit	2 : 1	Alchl/Drgs: 0	Speed: 40 MPH Dir: S	Veh Mnvr / Ped Actn: 11	Obj Strk:										
9	104144964	07/18/2014 08:37	RIGHT TURN, SAME ROADWAY	\$ 7200	0	0	0	0	1	1	1	1	0	3	1
Unit	1 : 14	Alchl/Drgs: 0	Speed: 8 MPH Dir: N	Veh Mnvr / Ped Actn: 7	Obj Strk:										
Unit	2 : 1	Alchl/Drgs: 0	Speed: 5 MPH Dir: N	Veh Mnvr / Ped Actn: 7	Obj Strk:										
10	104156148	08/12/2014 17:27	REAR END, SLOW OR STOP	\$ 3200	0	0	0	1	1	1	1	1	0	3	1
Unit	1 : 1	Alchl/Drgs: 0	Speed: 20 MPH Dir: N	Veh Mnvr / Ped Actn: 11	Obj Strk:										
Unit	2 : 1	Alchl/Drgs: 0	Speed: 20 MPH Dir: N	Veh Mnvr / Ped Actn: 11	Obj Strk:										
Unit	3 : 2	Alchl/Drgs: 0	Speed: 20 MPH Dir: N	Veh Mnvr / Ped Actn: 1	Obj Strk:										
11	104244597	11/09/2014 22:36	REAR END, SLOW OR STOP	\$ 1000	0	0	0	0	1	4	1	1	0		
Unit	1 : 4	Alchl/Drgs: 1	Speed: 35 MPH Dir: N	Veh Mnvr / Ped Actn: 11	Obj Strk:										
Unit	2 : 1	Alchl/Drgs: 0	Speed: 0 MPH Dir: N	Veh Mnvr / Ped Actn: 1	Obj Strk:										
12	104246853	12/17/2014 17:50	ANGLE	\$ 600	0	0	0	0	1	4	1	1	0	3	1
Unit	1 : 1	Alchl/Drgs: 0	Speed: 0 MPH Dir: S	Veh Mnvr / Ped Actn: 8	Obj Strk:										
Unit	2 : 1	Alchl/Drgs: 0	Speed: 10 MPH Dir: NW	Veh Mnvr / Ped Actn: 4	Obj Strk:										
13	104281833	12/19/2014 16:03	REAR END, SLOW OR STOP	\$ 1050	0	0	0	0	1	1	1	1	0		
Unit	1 : 4	Alchl/Drgs: 0	Speed: 20 MPH Dir: N	Veh Mnvr / Ped Actn: 11	Obj Strk:										
Unit	2 : 1	Alchl/Drgs: 0	Speed: 15 MPH Dir: N	Veh Mnvr / Ped Actn: 1	Obj Strk:										
14	104271217	01/17/2015 19:17	RAN OFF ROAD - LEFT	\$ 15100	0	0	0	1	1	4	1	1	0	0	
Unit	1 : 2	Alchl/Drgs: 0	Speed: 47 MPH Dir: N	Veh Mnvr / Ped Actn: 5	Obj Strk:	55									
15	104298852	02/19/2015 18:42	REAR END, SLOW OR STOP	\$ 1500	0	0	0	0	1	4	1	1	0	0	
Unit	1 : 1	Alchl/Drgs: 0	Speed: 15 MPH Dir: N	Veh Mnvr / Ped Actn: 11	Obj Strk:										
Unit	2 : 1	Alchl/Drgs: 0	Speed: 10 MPH Dir: N	Veh Mnvr / Ped Actn: 1	Obj Strk:										
16	104438871	07/18/2015 13:19	REAR END, SLOW OR STOP	\$ 2000	0	0	0	0	1	1	1	1	0	0	
Unit	1 : 4	Alchl/Drgs: 7	Speed: 25 MPH Dir: N	Veh Mnvr / Ped Actn: 4	Obj Strk:										
Unit	2 : 1	Alchl/Drgs: 7	Speed: 0 MPH Dir: N	Veh Mnvr / Ped Actn: 1	Obj Strk:										
17	104441323	07/24/2015 14:37	REAR END, SLOW OR STOP	\$ 2200	0	0	0	1	1	1	1	1	0	3	1
Unit	1 : 5	Alchl/Drgs: 0	Speed: 20 MPH Dir: NW	Veh Mnvr / Ped Actn: 4	Obj Strk:										
Unit	2 : 4	Alchl/Drgs: 0	Speed: 0 MPH Dir: NW	Veh Mnvr / Ped Actn: 1	Obj Strk:										

06/27/2017

-2-

North Carolina Department of Transportation
Traffic Engineering Accident Analysis System
Intersection Analysis Report

Acc No	Crash ID	Date	Accident Type	Total Damage	Injuries			Condition			Road			Trfc Ctl	
					F	A	B	C	R	L	W	Ch	Cl	Dv	Op
27	105035														

Summary Statistics

High Level Crash Summary

Crash Type	Number of Crashes	Percent of Total
Total Crashes	28	100.00
Fatal Crashes	0	0.00
Non-Fatal Injury Crashes	10	35.71
Total Injury Crashes	10	35.71
Property Damage Only Crashes	18	64.29
Night Crashes	8	28.57
Wet Crashes	2	7.14
Alcohol/Drugs Involvement Crashes	1	3.57

Crash Severity Summary

Crash Type	Number of Crashes	Percent of Total
Total Crashes	28	100.00
Fatal Crashes	0	0.00
Class A Crashes	0	0.00
Class B Crashes	1	3.57
Class C Crashes	9	32.14
Property Damage Only Crashes	18	64.29

Vehicle Exposure Statistics

Annual ADT = 999999

Total Vehicle Exposure = 1826 (MEV)

Crash Rate	Crashes Per 100 Million Vehicles Entered
Total Crash Rate	1.53
Fatal Crash Rate	0.00
Non Fatal Crash Rate	0.55
Night Crash Rate	0.44
Wet Crash Rate	0.11
EPDO Rate	5.59

06/27/2017

-5-

Miscellaneous Statistics

Severity Index = 3.64
EPDO Crash Index = 102.00
Estimated Property Damage Total = \$ 134205.00

Accident Type Summary

Accident Type	Number of Crashes	Percent of Total
ANGLE	6	21.43
BACKING UP	1	3.57
LEFT TURN, DIFFERENT ROADWAYS	1	3.57
LEFT TURN, SAME ROADWAY	2	7.14
RAN OFF ROAD - LEFT	1	3.57
RAN OFF ROAD - RIGHT	1	3.57
REAR END, SLOW OR STOP	15	53.57
RIGHT TURN, SAME ROADWAY	1	3.57

Injury Summary

Injury Type	Number of Injuries	Percent of Total
Fatal Injuries	0	0.00
Class A Injuries	0	0.00
Class B Injuries	1	7.69
Class C Injuries	12	92.31
Total Non-Fatal Injuries	13	100.00
Total Injuries	13	100.00

06/27/2017

-6-

Monthly Summary

Month	Number of Crashes	Percent of Total
Jan	2	7.14
Feb	4	14.29
Mar	2	7.14
Apr	2	7.14
May	1	3.57
Jun	0	0.00
Jul	4	14.29
Aug	1	3.57
Sep	0	0.00
Oct	4	14.29
Nov	4	14.29
Dec	4	14.29

Daily Summary

Day	Number of Crashes	Percent of Total
Mon	3	10.71
Tue	5	17.86
Wed	2	7.14
Thu	5	17.86
Fri	6	21.43
Sat	7	25.00
Sun	0	0.00

Hourly Summary

Hour	Number of Crashes	Percent of Total
0000-0059	0	0.00
0100-0159	0	0.00
0200-0259	0	0.00
0300-0359	0	0.00
0400-0459	0	0.00
0500-0559	0	0.00
0600-0659	0	0.00
0700-0759	0	0.00
0800-0859	3	10.71
0900-0959	0	0.00
1000-1059	2	7.14
1100-1159	2	7.14
1200-1259	1	3.57
1300-1359	3	10.71
1400-1459	2	7.14
1500-1559	3	10.71
1600-1659	2	7.14
1700-1759	4	14.29
1800-1859	1	3.57
1900-1959	1	3.57
2000-2059	1	3.57
2100-2159	0	0.00
2200-2259	2	7.14
2300-2359	1	3.57

06/27/2017

-7-

06/27/2017

-8-

North Carolina Department of Transportation
Traffic Engineering Accident Analysis System
Intersection Analysis Report

Light and Road Conditions Summary

Condition	Dry	Wet	Other	Total
Day	18	2	0	20
Dark	8	0	0	8
Other	0	0	0	0
Total	26	2	0	28

Object Struck Summary

Object Type	Times Struck	Percent of Total
MOVABLE OBJECT	1	14.29
PARKED MOTOR VEHICLE	5	71.43
TRAFFIC ISLAND CURB OR MEDIAN	1	14.29

Vehicle Type Summary

Vehicle Type	Number Involved	Percent of Total
LIGHT TRUCK (MINI-VAN, PANEL)	2	3.39
PASSENGER CAR	31	52.54
PICKUP	9	15.25
SINGLE UNIT TRUCK (2-AXLE, 6-TIRE)	1	1.69
SPORT UTILITY	10	16.95
TRACTOR/SEMI-TRAILER	2	3.39
VAN	4	6.78

06/27/2017

-9-

North Carolina Department of Transportation
Traffic Engineering Accident Analysis System
Intersection Analysis Report

Run Off Road &

Year	Left Turn	Right Turn	Rear End	Fixed Object	Angle	Side Swipe	Other
2015	1	0	4	2	1	0	0
2016	1	0	1	0	1	0	1
2017	0	0	1	0	2	0	0
Total	3	1	15	2	6	0	1

06/27/2017

-11-

North Carolina Department of Transportation
Traffic Engineering Accident Analysis System
Intersection Analysis Report

Yearly Totals Summary

Accident Totals

Year	Total Accidents	Fatal Accidents	Injury Accidents	Property Damage Only Accidents
2012	2	0	1	1
2013	4	0	1	3
2014	7	0	1	6
2015	8	0	5	3
2016	4	0	1	3
2017	3	0	1	2
Total	28	0	10	18

Injury Totals

Year	Fatal Injuries	Class A, B, or C Injuries
2012	0	2
2013	0	2
2014	0	1
2015	0	6
2016	0	1
2017	0	1
Total	0	13

Miscellaneous Totals

Year	Property Damage	EPDO Index
2012	\$ 13200	9.40
2013	\$ 19100	11.40
2014	\$ 18800	14.40
2015	\$ 38105	45.00
2016	\$ 22500	11.40
2017	\$ 22500	10.40
Total	\$ 134205	102.00

Type of Accident Totals

Year	Run Off Road &						
	Left Turn	Right Turn	Rear End	Fixed Object	Angle	Side Swipe	Other
2012	0	0	2	0	0	0	0
2013	1	0	2	0	1	0	0
2014	0	1	5	0	1	0	0

06/27/2017

-10-

North Carolina Department of Transportation
Traffic Engineering Accident Analysis System
Intersection Analysis Report

Study Criteria

Study Name	Log No.	PH No.	TIP No.	K/A Cf.	B/C Cf.	ADT	ADT Route	
4100047242	4100047242			75.8	8.4	999999		
Request Date	Courier Service	Phone No.	Ext.	Fax No.				
County		Municipality						
Name	Code	Div.	Name	Code	Y-Line Fl.	Begin Date	End Date	Years
MECKLENBURG	60	10	All and Rural		150	05/01/2012	04/30/2017	5.00
Location Text	Requestor							
US 521 (Polk St-Pineville Rd) at SR 3542 (Industrial Dr). **Crash rates contained in this analysis should not be used**	Cliff Lawson, PE Timmons Group							

Included Accidents

103473281
105064867
104156148

Excluded Accidents

103719919
103983408
104009927
104055797
104154613
104185059
104215370
104216414
104242062
104271374
104299565
104372680
104421037

Fiche Roads

Name	Code
US 521	20009521
POLK	50024505
PINEVILLE	50024239
SOUTH	50028612
SR 3542	40003542

06/27/2017

-12-

North Carolina Department of Transportation
Traffic Engineering Accident Analysis System
Intersection Analysis Report

County: MECKLENBURG City: All and Rural
Date: 11/1/2012 to 10/31/2017 Study: 41000050292
Location: Industrial Dr at Rodney St

Study Criteria Summary

Report Details

Acc No	Crash ID	Date	Accident Type	Total Damage	Injuries			Condition			Road			Trfc Ctl
					F	A	B	C	R	L	W	Ch	Ci	
1	104283821	02/02/2015 08:26	RAN OFF ROAD - RIGHT	\$ 100	0	0	0	0	2	1	2	3	0	0

Unit 1 : 14 Alchl/Drugs: 0 Speed: 1 MPH Dir: NE Veh Mnvr / Ped Actn: 7 Obj Strk: 40

Acc No - Accident Number
Injuries: F - Fatal, A - Class A, B - Class B, C - Class C
Condition: R - Road Surface, L - Ambient Light, W - Weather
Rd Ch - Road Character
Rd Ci - Roadway Contributing Circumstances
Trfc Ctl - Traffic Control; Dv - Device, Op - Operating
Alchl/Drugs - Alcohol/Drugs Suspected
Veh Mnvr/Ped Actn - Vehicle Maneuver/Pedestrian Action
Obj Strk - Object Struck

12/06/2017

-1-

North Carolina Department of Transportation
Traffic Engineering Accident Analysis System
Intersection Analysis Report

Summary Statistics

High Level Crash Summary

Crash Type	Number of Crashes	Percent of Total
Total Crashes	1	100.00
Fatal Crashes	0	0.00
Non-Fatal Injury Crashes	0	0.00
Total Injury Crashes	0	0.00
Property Damage Only Crashes	1	100.00
Night Crashes	0	0.00
Wet Crashes	1	100.00
Alcohol/Drugs Involvement Crashes	0	0.00

Crash Severity Summary

Crash Type	Number of Crashes	Percent of Total
Total Crashes	1	100.00
Fatal Crashes	0	0.00
Class A Crashes	0	0.00
Class B Crashes	0	0.00
Class C Crashes	0	0.00
Property Damage Only Crashes	1	100.00

Vehicle Exposure Statistics

Annual ADT = 3300
Total Vehicle Exposure = 6.03 (MEV)

Crash Rate	Crashes Per 100 Million Vehicles Entered
Total Crash Rate	16.60
Fatal Crash Rate	0.00
Non Fatal Crash Rate	0.00
Night Crash Rate	0.00
Wet Crash Rate	16.60
EPDO Rate	16.60

12/06/2017

-2-

North Carolina Department of Transportation
Traffic Engineering Accident Analysis System
Intersection Analysis Report

Miscellaneous Statistics

Severity Index = 1.00
EPDO Crash Index = 1.00
Estimated Property Damage Total = \$ 100.00

Accident Type Summary

Accident Type	Number of Crashes	Percent of Total
RAN OFF ROAD - RIGHT	1	100.00

Injury Summary

Injury Type	Number of Injuries	Percent of Total
Fatal Injuries	0	0.00
Class A Injuries	0	0.00
Class B Injuries	0	0.00
Class C Injuries	0	0.00
Total Non-Fatal Injuries	0	0.00
Total Injuries	0	0.00

12/06/2017

-3-

North Carolina Department of Transportation
Traffic Engineering Accident Analysis System
Intersection Analysis Report

Monthly Summary

Month	Number of Crashes	Percent of Total
Jan	0	0.00
Feb	1	100.00
Mar	0	0.00
Apr	0	0.00
May	0	0.00
Jun	0	0.00
Jul	0	0.00
Aug	0	0.00
Sep	0	0.00
Oct	0	0.00
Nov	0	0.00
Dec	0	0.00

Daily Summary

Day	Number of Crashes	Percent of Total
Mon	1	100.00
Tue	0	0.00
Wed	0	0.00
Thu	0	0.00
Fri	0	0.00
SAT	0	0.00
Sun	0	0.00

12/06/2017

-4-

North Carolina Department of Transportation
Traffic Engineering Accident Analysis System
Intersection Analysis Report

Hourly Summary

Hour	Number of Crashes	Percent of Total
0000-0059	0	0.00
0100-0159	0	0.00
0200-0259	0	0.00
0300-0359	0	0.00
0400-0459	0	0.00
0500-0559	0	0.00
0600-0659	0	0.00
0700-0759	0	0.00
0800-0859	1	100.00
0900-0959	0	0.00
1000-1059	0	0.00
1100-1159	0	0.00
1200-1259	0	0.00
1300-1359	0	0.00
1400-1459	0	0.00
1500-1559	0	0.00
1600-1659	0	0.00
1700-1759	0	0.00
1800-1859	0	0.00
1900-1959	0	0.00
2000-2059	0	0.00
2100-2159	0	0.00
2200-2259	0	0.00
2300-2359	0	0.00

12/06/2017

-5-

North Carolina Department of Transportation
Traffic Engineering Accident Analysis System
Intersection Analysis Report

Light and Road Conditions Summary

Condition	Dry	Wet	Other	Total
Day	0	1	0	1
Dark	0	0	0	0
Other	0	0	0	0
Total	0	1	0	1

Object Struck Summary

Object Type	Times Struck	Percent of Total
COMMERCIAL SIGN	1	100.00

Vehicle Type Summary

Vehicle Type	Number Involved	Percent of Total
TRACTOR/SEMI-TRAILER	1	100.00

12/06/2017

-6-

North Carolina Department of Transportation
Traffic Engineering Accident Analysis System
Intersection Analysis Report

Yearly Totals Summary

Accident Totals

Year	Total Accidents	Fatal Accidents	Injury Accidents	Property Damage Only Accidents
2012	0	0	0	0
2013	0	0	0	0
2014	0	0	0	0
2015	1	0	0	1
2016	0	0	0	0
2017	0	0	0	0
Total	1	0	0	1

Injury Totals

Year	Fatal Injuries	Class A, B, or C Injuries
2012	0	0
2013	0	0
2014	0	0
2015	0	0
2016	0	0
2017	0	0
Total	0	0

Miscellaneous Totals

Year	Property Damage	EPDO Index
2012	\$ 0	0.00
2013	\$ 0	0.00
2014	\$ 0	0.00
2015	\$ 100	1.00
2016	\$ 0	0.00
2017	\$ 0	0.00
Total	\$ 100	1.00

Type of Accident Totals

Year	Left Turn	Right Turn	Rear End	Run Off Road & Fixed Object	Angle	Side Swipe	Other
2012	0	0	0	0	0	0	0
2013	0	0	0	0	0	0	0
2014	0	0	0	0	0	0	0

12/06/2017

-7-

North Carolina Department of Transportation
Traffic Engineering Accident Analysis System
Intersection Analysis Report

Run Off Road & Fixed Object

Year	Left Turn	Right Turn	Rear End	Run Off Road & Fixed Object	Angle	Side Swipe	Other
2015	0	0	0	1	0	0	0
2016	0	0	0	0	0	0	0
2017	0	0	0	0	0	0	0
Total	0	0	0	1	0	0	0

12/06/2017

-8-

North Carolina Department of Transportation
 Traffic Engineering Accident Analysis System
 Intersection Analysis Report

Study Criteria

Study Name	Log No.	PH No.	TIP No.	K/A Cf.	B/C Cf.	ADT	ADT Route
4100050292	4100050292			76.8	8.4	3300	

Request Date	Courier Service	Phone No.	Ext.	Fax No.

County			Municipality					
Name	Code	Div.	Name	Code	Y-Line Ft.	Begin Date	End Date	Years
MECKLENBURG	60	10	All and Rural		150	11/1/2012	10/31/2017	5.00

Location Text	Requestor
Industrial Dr at Rodney St	

Excluded Accidents
105035691
104501387
104185059
104155626
104009919
103926165

Fiche Roads	
Name	Code
RODNEY	50026333
INDUSTRIAL	50014936
SR 5436	40005436

Intersection Road Combinations			
Name	Code	Code	Name
RODNEY	50026333	50014936	INDUSTRIAL

Appendix C – Traffic Signal Plans

PHASING DIAGRAM

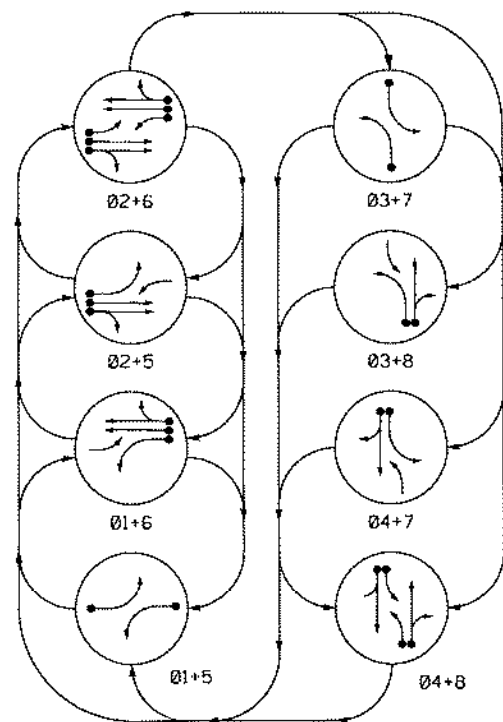

PHASING DIAGRAM DETECTION LEGEND

- DETECTED MOVEMENT
- UNDETECTED MOVEMENT (OVERLAP)
- UNSIGNALIZED MOVEMENT
- PEDESTRIAN MOVEMENT

SIGNAL FACE	PHASE							
	01+5	02+6	03+7	04+8	01+6	02+5	03+8	04+7
11	—	—	—	—	—	—	—	—
21, 22	R	R	G	G	R	R	R	Y
31	R	R	R	R	—	—	—	—
41, 42	R	R	R	R	R	G	G	R
51	—	—	—	—	—	—	—	—
61, 62	R	G	R	G	R	R	R	Y
71	R	R	R	R	—	—	—	—
81, 82	R	R	R	R	C	R	C	R

SIGNAL FACE I.D.

All Heads L.E.D.

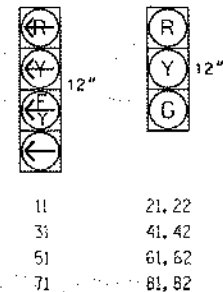

OASIS 2070 LOOP & DETECTOR INSTALLATION CHART

LOOP	SIZE (FT)	DISTANCE FROM STOPBAR (FT)	TURNS	NEW LOOP	DETECTOR PROGRAMMING					
					PHASE	CALLING	EXTENSION	STRETCH TIME	DELAY TIME	SYSTEM LOOP
1A	6X40	0	2-4-2	1	Y	Y	-	15	-	Y
2A	6X6	70	3	-	2	Y	Y	-	-	Y
2B	6X6	70	3	-	2	Y	Y	-	-	Y
3A	6X40	0	2-4-2	3	Y	Y	-	15	-	Y
4A	6X40	0	2-4-2	4	Y	Y	-	10	-	Y
5A	6X40	0	2-4-2	5	Y	Y	-	15	-	Y
6A	6X6	70	3	-	6	Y	Y	-	-	Y
6B	6X6	70	3	-	6	Y	Y	-	-	Y
7A	6X40	0	2-4-2	7	Y	Y	-	15	-	Y
8A	6X40	0	2-4-2	8	Y	Y	-	10	-	Y
S27	6X6	+160	4	-	-	-	-	-	-	Y
S28	6X6	+160	4	-	-	-	-	-	-	Y

8 Phase Fully Actuated
 NC 51 (Pineville-Matthews Rd./ SR 4982 (Polk Street) CLS

NOTES

- Refer to "Roadway Standard Drawings NCDOT" dated January 2012 and "Standard Specifications for Roads and Structures" dated January 2012.
- Do not program signal for late night flashing operation unless otherwise directed by the Engineer.
- Phase 3 and/or phase 7 may be lagged.
- Phase 3 and/or phase 7 may be lagged.
- Reposition existing signal heads numbered # 22, 42, 62, & 82.
- Set all detector units to presence mode.
- Locate new cabinet so as not to obstruct sight distance of vehicles turning right on red.
- Pavement markings are existing.
- Maximum times shown in timing chart are for free-run operation only. Coordinated signal system timing values supersede these values.
- Closed loop system data: Controller Asset # 0966.

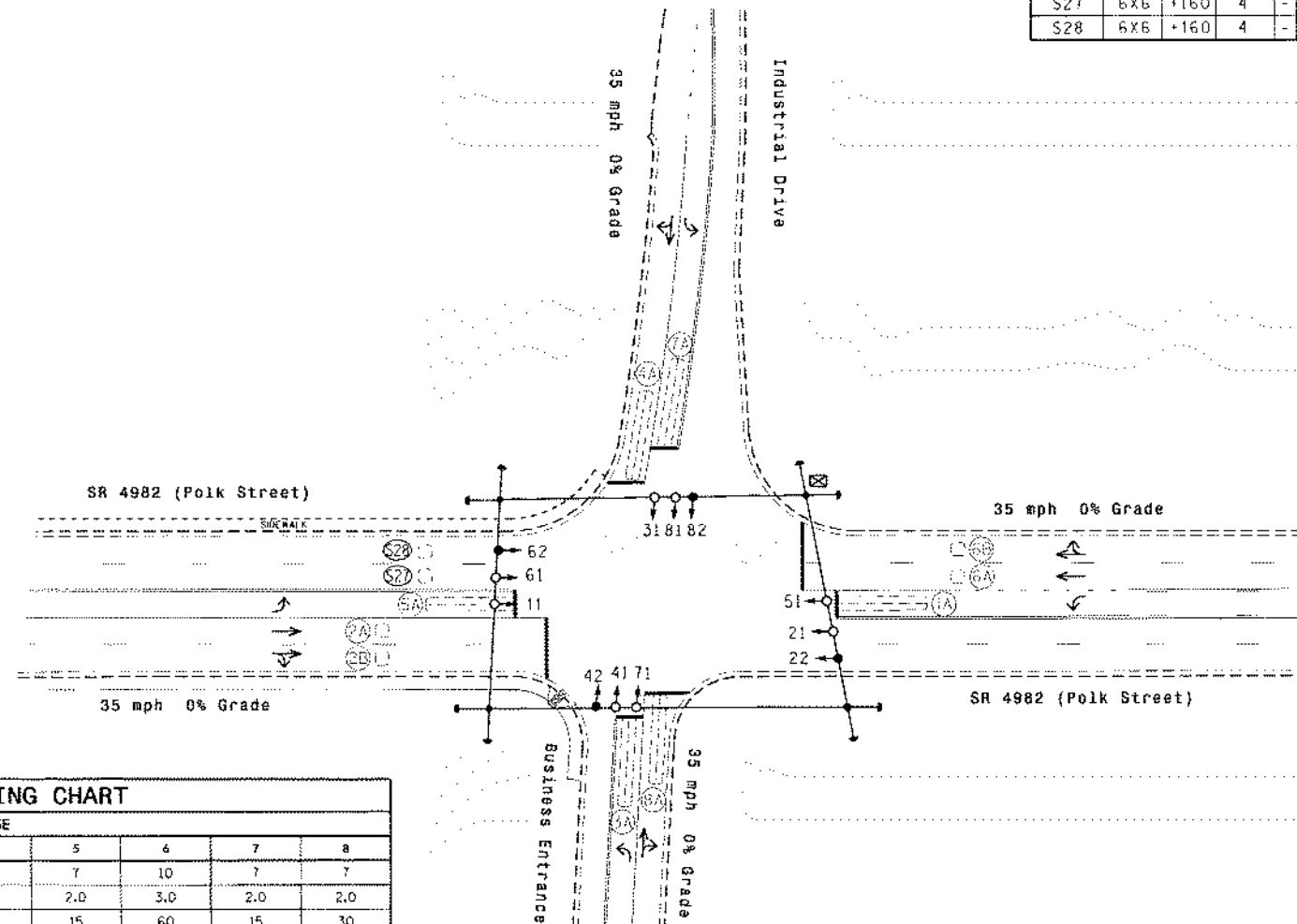

OASIS 2070L TIMING CHART

FEATURE	PHASE							
	1	2	3	4	5	6	7	8
Min Green 1*	7	10	7	7	7	10	7	7
Extension 1*	2.0	3.0	2.0	2.0	2.0	3.0	2.0	2.0
Max Green 1*	15	60	15	30	15	60	15	30
Yellow Clearance	3.0	3.8	3.0	3.8	3.0	3.8	3.0	3.8
Red Clearance	3.3	2.5	2.4	2.0	2.6	2.5	2.8	2.0
Red Revert	2.0	2.0	2.0	2.0	2.0	2.0	2.0	2.0
Walk 1*	-	-	-	-	-	-	-	-
Don't Walk 1	-	-	-	-	-	-	-	-
Seconds Per Actuation*	-	-	-	-	-	-	-	-
Max Variable Initial*	-	-	-	-	-	-	-	-
Time Before Reduction*	-	-	-	-	-	-	-	-
Time To Reduce*	-	-	-	-	-	-	-	-
Minimum Gap	-	-	-	-	-	-	-	-
Recall Mode	-	WIN RECALL	-	-	-	WTK RECALL	-	-
Vehicle Call Memory	-	YELLOW	-	-	-	YELLOW	-	-
Dual Entry	-	-	-	ON	-	-	-	ON
Simultaneous Gap	ON	ON	ON	ON	ON	ON	ON	ON

* These values may be field adjusted. Do not adjust Min Green and Extension times for phases 2 and 6 lower than what is shown. Min Green for all other phases should not be lower than 4 seconds.

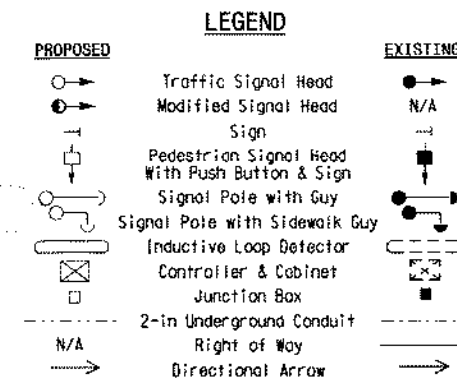

Signal Upgrade

Prepared in the Office of
 Transportation Mobility and Safety Operations
 NORTH CAROLINA
 DEPARTMENT OF TRANSPORTATION
 Signal Design Section

SR 4982 (Polk Street) at Industrial Drive / Business Entrance

Division 10 Wecklenburg County Pineville
 PLAN DATE: September 2013 REVIEWED BY: P.E.A.
 PREPARED BY: C. Pierceb REVIEWED BY:
 REVISIONS: _____ DATE: _____
 SCALE: 1" = 40'

SEAL
 NORTH CAROLINA
 PROFESSIONAL ENGINEER
 SEAL 24393
 ENGINEER
 MATHY W. WILLIAMS
 10/31/13
 SIGNATURE DATE
 SIG. INVENTORY NO. 10-0966

10-0966-001 (09/2013)
 10-0966-001 (09/2013)
 10-0966-001 (09/2013)
 10-0966-001 (09/2013)





















Appendix D – Synchro Analysis Outputs

2017 Existing Traffic Volumes

Pineville Industrial TIA

966: N Polk Street/Pineville Road & Industrial Drive/Driveway

11/03/2017

												
Lane Group	EBL	EBT	EBR	WBL	WBT	WBR	NBL	NBT	NBR	SBL	SBT	SBR
Lane Configurations												
Traffic Volume (vph)	61	0	38	4	2	18	98	858	14	38	452	160
Future Volume (vph)	61	0	38	4	2	18	98	858	14	38	452	160
Ideal Flow (vphpl)	1900	1900	1900	1900	1900	1900	1900	1900	1900	1900	1900	1900
Storage Length (ft)	150		0	0		75	100		0	165		0
Storage Lanes	1		0	1		1	1		0	1		0
Taper Length (ft)	25			25			25			25		
Lane Util. Factor	1.00	1.00	1.00	1.00	1.00	1.00	1.00	0.95	0.95	1.00	0.95	0.95
Frt		0.850			0.864			0.998			0.961	
Flt Protected	0.950			0.950			0.950			0.950		
Satd. Flow (prot)	1770	1583	0	1770	1609	0	1770	3532	0	1770	3401	0
Flt Permitted	0.597						0.299			0.257		
Satd. Flow (perm)	1112	1583	0	1863	1609	0	557	3532	0	479	3401	0
Right Turn on Red			No			No			No			No
Satd. Flow (RTOR)												
Link Speed (mph)		35			35			35			35	
Link Distance (ft)		1961			266			1652			1043	
Travel Time (s)		38.2			5.2			32.2			20.3	
Peak Hour Factor	0.90	0.90	0.90	0.90	0.90	0.90	0.90	0.90	0.90	0.90	0.90	0.90
Adj. Flow (vph)	68	0	42	4	2	20	109	953	16	42	502	178
Shared Lane Traffic (%)												
Lane Group Flow (vph)	68	42	0	4	22	0	109	969	0	42	680	0
Enter Blocked Intersection	No	No	No	No	No	No	No	No	No	No	No	No
Lane Alignment	Left	Left	Right	Left	Left	Right	Left	Left	Right	Left	Left	Right
Median Width(ft)		12			12			12			12	
Link Offset(ft)		0			0			0			0	
Crosswalk Width(ft)		16			16			16			16	
Two way Left Turn Lane												Yes
Headway Factor	1.00	1.00	1.00	1.00	1.00	1.00	1.00	1.00	1.00	1.00	1.00	1.00
Turning Speed (mph)	15		9	15		9	15		9	15		9
Turn Type	pm+pt	NA		pm+pt	NA		pm+pt	NA		pm+pt	NA	
Protected Phases	7	4		3	8		5	2		1	6	
Permitted Phases	4			8			2			6		
Detector Phase	7	4		3	8		5	2		1	6	
Switch Phase												
Minimum Initial (s)	7.0	7.0		7.0	7.0		7.0	10.0		7.0	10.0	
Minimum Split (s)	14.0	20.0		14.0	20.0		14.0	21.0		14.0	21.0	
Total Split (s)	16.0	24.0		14.0	22.0		16.0	66.0		16.0	66.0	
Total Split (%)	13.3%	20.0%		11.7%	18.3%		13.3%	55.0%		13.3%	55.0%	
Maximum Green (s)	10.2	18.2		8.6	16.2		10.4	59.7		9.7	59.7	
Yellow Time (s)	3.0	3.8		3.0	3.8		3.0	3.8		3.0	3.8	
All-Red Time (s)	2.8	2.0		2.4	2.0		2.6	2.5		3.3	2.5	
Lost Time Adjust (s)	-0.8	-0.8		-0.4	-0.8		-0.6	-1.3		-1.3	-1.3	
Total Lost Time (s)	5.0	5.0		5.0	5.0		5.0	5.0		5.0	5.0	
Lead/Lag	Lead	Lag		Lead	Lag		Lead	Lag		Lead	Lag	
Lead-Lag Optimize?	Yes	Yes		Yes	Yes		Yes	Yes		Yes	Yes	
Vehicle Extension (s)	2.0	2.0		2.0	2.0		2.0	3.0		2.0	3.0	
Recall Mode	None	None		None	None		None	Min		None	Min	
Act Effect Green (s)	12.9	11.6		10.9	9.2		34.1	35.1		31.3	26.0	

Pineville Industrial TIA
 966: N Polk Street/Pineville Road & Industrial Drive/Driveway

11/03/2017

Lane Group	EBL	EBT	EBR	WBL	WBT	WBR	NBL	NBT	NBR	SBL	SBT	SBR
Actuated g/C Ratio	0.25	0.22		0.21	0.18		0.66	0.68		0.61	0.50	
v/c Ratio	0.17	0.12		0.01	0.08		0.19	0.40		0.08	0.40	
Control Delay	19.4	24.1		19.2	29.4		6.9	11.7		6.8	14.2	
Queue Delay	0.0	0.0		0.0	0.0		0.0	0.0		0.0	0.0	
Total Delay	19.4	24.1		19.2	29.4		6.9	11.7		6.8	14.2	
LOS	B	C		B	C		A	B		A	B	
Approach Delay		21.2			27.9			11.3			13.7	
Approach LOS		C			C			B			B	
Queue Length 50th (ft)	15	9		1	5		10	57		4	76	
Queue Length 95th (ft)	55	48		8	32		43	263		21	179	
Internal Link Dist (ft)		1881			186			1572			963	
Turn Bay Length (ft)	150						100			165		
Base Capacity (vph)	506	696		440	621		677	3256		634	3135	
Starvation Cap Reductn	0	0		0	0		0	0		0	0	
Spillback Cap Reductn	0	0		0	0		0	0		0	0	
Storage Cap Reductn	0	0		0	0		0	0		0	0	
Reduced v/c Ratio	0.13	0.06		0.01	0.04		0.16	0.30		0.07	0.22	

Intersection Summary

Area Type: Other
 Cycle Length: 120
 Actuated Cycle Length: 51.7
 Natural Cycle: 75
 Control Type: Actuated-Uncoordinated
 Maximum v/c Ratio: 0.40
 Intersection Signal Delay: 13.0
 Intersection Capacity Utilization 52.5%
 Analysis Period (min) 15
 Intersection LOS: B
 ICU Level of Service A

Splits and Phases: 966: N Polk Street/Pineville Road & Industrial Drive/Driveway

Ø1 16 s	Ø2 66 s	Ø3 14 s	Ø4 24 s
Ø5 16 s	Ø6 66 s	Ø7 16 s	Ø8 22 s

Pineville Industrial TIA
 1: Industrial Drive & Rodney Street

11/03/2017























Movement	EBT	EBR	WBL	WBT	NBL	NBR
Lane Configurations	↶			↷	↶	↷
Traffic Volume (veh/h)	33	40	10	41	30	4
Future Volume (Veh/h)	33	40	10	41	30	4
Sign Control	Free		Free		Stop	
Grade	2%		-1%		5%	
Peak Hour Factor	0.90	0.90	0.90	0.90	0.90	0.90
Hourly flow rate (vph)	37	44	11	46	33	4
Pedestrians						
Lane Width (ft)						
Walking Speed (ft/s)						
Percent Blockage						
Right turn flare (veh)						
Median type	None		None			
Median storage (veh)						
Upstream signal (ft)						
pX, platoon unblocked						
vC, conflicting volume			81		127	59
vC1, stage 1 conf vol						
vC2, stage 2 conf vol						
vCu, unblocked vol			81		127	59
tC, single (s)			4.1		6.4	6.2
tC, 2 stage (s)						
tF (s)			2.2		3.5	3.3
p0 queue free %			99		96	100
cM capacity (veh/h)			1517		861	1007
Direction, Lane #	EB 1	WB 1	NB 1			
Volume Total	81	57	37			
Volume Left	0	11	33			
Volume Right	44	0	4			
cSH	1700	1517	875			
Volume to Capacity	0.05	0.01	0.04			
Queue Length 95th (ft)	0	1	3			
Control Delay (s)	0.0	1.5	9.3			
Lane LOS		A	A			
Approach Delay (s)	0.0	1.5	9.3			
Approach LOS			A			
Intersection Summary						
Average Delay			2.4			
Intersection Capacity Utilization			19.4%	ICU Level of Service	A	
Analysis Period (min)			15			

Pineville Industrial TIA

966: N Polk Street/Pineville Road & Industrial Drive/Driveway

11/03/2017

												
Lane Group	EBL	EBT	EBR	WBL	WBT	WBR	NBL	NBT	NBR	SBL	SBT	SBR
Lane Configurations												
Traffic Volume (vph)	169	4	78	9	1	40	33	762	10	7	1117	79
Future Volume (vph)	169	4	78	9	1	40	33	762	10	7	1117	79
Ideal Flow (vphpl)	1900	1900	1900	1900	1900	1900	1900	1900	1900	1900	1900	1900
Storage Length (ft)	150		0	0		75	100		0	165		0
Storage Lanes	1		0	1		1	1		0	1		0
Taper Length (ft)	25			25			25			25		
Lane Util. Factor	1.00	1.00	1.00	1.00	1.00	1.00	1.00	0.95	0.95	1.00	0.95	0.95
Frt		0.857			0.853			0.998			0.990	
Flt Protected	0.950			0.950			0.950			0.950		
Satd. Flow (prot)	1770	1596	0	1770	1589	0	1770	3532	0	1770	3504	0
Flt Permitted	0.414			0.698			0.098			0.273		
Satd. Flow (perm)	771	1596	0	1300	1589	0	183	3532	0	509	3504	0
Right Turn on Red			No			No			No			No
Satd. Flow (RTOR)												
Link Speed (mph)		35			35			35			35	
Link Distance (ft)		1961			266			1652			1043	
Travel Time (s)		38.2			5.2			32.2			20.3	
Peak Hour Factor	0.90	0.90	0.90	0.90	0.90	0.90	0.90	0.90	0.90	0.90	0.90	0.90
Adj. Flow (vph)	188	4	87	10	1	44	37	847	11	8	1241	88
Shared Lane Traffic (%)												
Lane Group Flow (vph)	188	91	0	10	45	0	37	858	0	8	1329	0
Enter Blocked Intersection	No	No	No	No	No	No	No	No	No	No	No	No
Lane Alignment	Left	Left	Right	Left	Left	Right	Left	Left	Right	Left	Left	Right
Median Width(ft)		12			12			12			12	
Link Offset(ft)		0			0			0			0	
Crosswalk Width(ft)		16			16			16			16	
Two way Left Turn Lane												Yes
Headway Factor	1.00	1.00	1.00	1.00	1.00	1.00	1.00	1.00	1.00	1.00	1.00	1.00
Turning Speed (mph)	15		9	15		9	15		9	15		9
Turn Type	pm+pt	NA		pm+pt	NA		pm+pt	NA		pm+pt	NA	
Protected Phases	7	4		3	8		5	2		1	6	
Permitted Phases	4			8			2			6		
Detector Phase	7	4		3	8		5	2		1	6	
Switch Phase												
Minimum Initial (s)	7.0	7.0		7.0	7.0		7.0	10.0		7.0	10.0	
Minimum Split (s)	14.0	20.0		14.0	20.0		14.0	21.0		14.0	21.0	
Total Split (s)	16.0	24.0		14.0	22.0		16.0	66.0		16.0	66.0	
Total Split (%)	13.3%	20.0%		11.7%	18.3%		13.3%	55.0%		13.3%	55.0%	
Maximum Green (s)	10.2	18.2		8.6	16.2		10.4	59.7		9.7	59.7	
Yellow Time (s)	3.0	3.8		3.0	3.8		3.0	3.8		3.0	3.8	
All-Red Time (s)	2.8	2.0		2.4	2.0		2.6	2.5		3.3	2.5	
Lost Time Adjust (s)	-0.8	-0.8		-0.4	-0.8		-0.6	-1.3		-1.3	-1.3	
Total Lost Time (s)	5.0	5.0		5.0	5.0		5.0	5.0		5.0	5.0	
Lead/Lag	Lead	Lag		Lead	Lag		Lead	Lag		Lead	Lag	
Lead-Lag Optimize?	Yes	Yes		Yes	Yes		Yes	Yes		Yes	Yes	
Vehicle Extension (s)	2.0	2.0		2.0	2.0		2.0	3.0		2.0	3.0	
Recall Mode	None	None		None	None		None	Min		None	Min	
Act Effect Green (s)	18.5	16.9		13.2	10.0		42.9	41.8		41.5	37.5	

Pineville Industrial TIA

966: N Polk Street/Pineville Road & Industrial Drive/Driveway

11/03/2017

Lane Group	EBL	EBT	EBR	WBL	WBT	WBR	NBL	NBT	NBR	SBL	SBT	SBR
Actuated g/C Ratio	0.25	0.23		0.18	0.14		0.58	0.57		0.56	0.51	
v/c Ratio	0.54	0.25		0.03	0.21		0.12	0.43		0.02	0.75	
Control Delay	33.2	32.1		27.1	41.3		7.9	11.0		7.1	19.7	
Queue Delay	0.0	0.0		0.0	0.0		0.0	0.0		0.0	0.0	
Total Delay	33.2	32.1		27.1	41.3		7.9	11.0		7.1	19.7	
LOS	C	C		C	D		A	B		A	B	
Approach Delay		32.9			38.7			10.9			19.6	
Approach LOS		C			D			B			B	
Queue Length 50th (ft)	80	37		4	23		7	115		2	316	
Queue Length 95th (ft)	170	106		18	63		20	242		7	444	
Internal Link Dist (ft)		1881			186			1572			963	
Turn Bay Length (ft)	150						100			165		
Base Capacity (vph)	376	517		331	425		382	2795		513	2773	
Starvation Cap Reductn	0	0		0	0		0	0		0	0	
Spillback Cap Reductn	0	0		0	0		0	0		0	0	
Storage Cap Reductn	0	0		0	0		0	0		0	0	
Reduced v/c Ratio	0.50	0.18		0.03	0.11		0.10	0.31		0.02	0.48	

Intersection Summary

Area Type:	Other
Cycle Length:	120
Actuated Cycle Length:	73.9
Natural Cycle:	80
Control Type:	Actuated-Uncoordinated
Maximum v/c Ratio:	0.75
Intersection Signal Delay:	18.4
Intersection Capacity Utilization:	57.8%
Analysis Period (min):	15
Intersection LOS:	B
ICU Level of Service:	B

Splits and Phases: 966: N Polk Street/Pineville Road & Industrial Drive/Driveway

Ø1	Ø2	Ø3	Ø4
16 s	66 s	14 s	24 s
Ø5	Ø6	Ø7	Ø8
16 s	66 s	16 s	22 s

Pineville Industrial TIA
 1: Industrial Drive & Rodney Street

11/03/2017

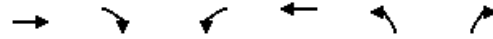





















Movement	EBT	EBR	WBL	WBT	NBL	NBR
Lane Configurations	↶			↷	↷	
Traffic Volume (veh/h)	72	32	3	80	40	10
Future Volume (Veh/h)	72	32	3	80	40	10
Sign Control	Free		Free		Stop	
Grade	2%		-1%		5%	
Peak Hour Factor	0.90	0.90	0.90	0.90	0.90	0.90
Hourly flow rate (vph)	80	36	3	89	44	11
Pedestrians						
Lane Width (ft)						
Walking Speed (ft/s)						
Percent Blockage						
Right turn flare (veh)						
Median type	None		None			
Median storage (veh)						
Upstream signal (ft)						
pX, platoon unblocked						
vC, conflicting volume			116		193	98
vC1, stage 1 conf vol						
vC2, stage 2 conf vol						
vCu, unblocked vol			116		193	98
tC, single (s)			4.1		6.4	6.2
tC, 2 stage (s)						
tF (s)			2.2		3.5	3.3
p0 queue free %			100		94	99
cM capacity (veh/h)			1473		794	958
Direction, Lane #	EB 1	WB 1	NB 1			
Volume Total	116	92	55			
Volume Left	0	3	44			
Volume Right	36	0	11			
cSH	1700	1473	822			
Volume to Capacity	0.07	0.00	0.07			
Queue Length 95th (ft)	0	0	5			
Control Delay (s)	0.0	0.3	9.7			
Lane LOS		A	A			
Approach Delay (s)	0.0	0.3	9.7			
Approach LOS			A			
Intersection Summary						
Average Delay			2.1			
Intersection Capacity Utilization			16.6%	ICU Level of Service	A	
Analysis Period (min)			15			

2019 Phase I Background Traffic Volumes

Pineville Industrial TIA

966: N Polk Street/Pineville Road & Industrial Drive/Driveway

11/03/2017

												
Lane Group	EBL	EBT	EBR	WBL	WBT	WBR	NBL	NBT	NBR	SBL	SBT	SBR
Lane Configurations												
Traffic Volume (vph)	107	0	57	4	2	19	108	893	15	40	470	175
Future Volume (vph)	107	0	57	4	2	19	108	893	15	40	470	175
Ideal Flow (vphpl)	1900	1900	1900	1900	1900	1900	1900	1900	1900	1900	1900	1900
Storage Length (ft)	150		0	0		75	100		0	165		0
Storage Lanes	1		0	1		1	1		0	1		0
Taper Length (ft)	25			25			25			25		
Lane Util. Factor	1.00	1.00	1.00	1.00	1.00	1.00	1.00	0.95	0.95	1.00	0.95	0.95
Frt		0.850			0.863			0.997			0.959	
Flt Protected	0.950			0.950			0.950			0.950		
Satd. Flow (prot)	1770	1583	0	1770	1608	0	1770	3529	0	1770	3394	0
Flt Permitted	0.471						0.294			0.202		
Satd. Flow (perm)	877	1583	0	1863	1608	0	548	3529	0	376	3394	0
Right Turn on Red			No			No			No			No
Satd. Flow (RTOR)												
Link Speed (mph)		35			35			35			35	
Link Distance (ft)		1961			266			1652			1043	
Travel Time (s)		38.2			5.2			32.2			20.3	
Peak Hour Factor	0.90	0.90	0.90	0.90	0.90	0.90	0.90	0.90	0.90	0.90	0.90	0.90
Adj. Flow (vph)	119	0	63	4	2	21	120	992	17	44	522	194
Shared Lane Traffic (%)												
Lane Group Flow (vph)	119	63	0	4	23	0	120	1009	0	44	716	0
Enter Blocked Intersection	No	No	No	No	No	No	No	No	No	No	No	No
Lane Alignment	Left	Left	Right	Left	Left	Right	Left	Left	Right	Left	Left	Right
Median Width(ft)		12			12			12			12	
Link Offset(ft)		0			0			0			0	
Crosswalk Width(ft)		16			16			16			16	
Two way Left Turn Lane												Yes
Headway Factor	1.00	1.00	1.00	1.00	1.00	1.00	1.00	1.00	1.00	1.00	1.00	1.00
Turning Speed (mph)	15		9	15		9	15		9	15		9
Turn Type	pm+pt	NA		pm+pt	NA		pm+pt	NA		pm+pt	NA	
Protected Phases	7	4		3	8		5	2		1	6	
Permitted Phases	4			8			2			6		
Detector Phase	7	4		3	8		5	2		1	6	
Switch Phase												
Minimum Initial (s)	7.0	7.0		7.0	7.0		7.0	10.0		7.0	10.0	
Minimum Split (s)	14.0	20.0		14.0	20.0		14.0	21.0		14.0	21.0	
Total Split (s)	16.0	24.0		14.0	22.0		16.0	66.0		16.0	66.0	
Total Split (%)	13.3%	20.0%		11.7%	18.3%		13.3%	55.0%		13.3%	55.0%	
Maximum Green (s)	10.2	18.2		8.6	16.2		10.4	59.7		9.7	59.7	
Yellow Time (s)	3.0	3.8		3.0	3.8		3.0	3.8		3.0	3.8	
All-Red Time (s)	2.8	2.0		2.4	2.0		2.6	2.5		3.3	2.5	
Lost Time Adjust (s)	-0.8	-0.8		-0.4	-0.8		-0.6	-1.3		-1.3	-1.3	
Total Lost Time (s)	5.0	5.0		5.0	5.0		5.0	5.0		5.0	5.0	
Lead/Lag	Lead	Lag		Lead	Lag		Lead	Lag		Lead	Lag	
Lead-Lag Optimize?	Yes	Yes		Yes	Yes		Yes	Yes		Yes	Yes	
Vehicle Extension (s)	2.0	2.0		2.0	2.0		2.0	3.0		2.0	3.0	
Recall Mode	None	None		None	None		None	Min		None	Min	
Act Effect Green (s)	13.8	12.2		10.7	8.9		34.8	32.3		33.4	28.8	

Lane Group	EBL	EBT	EBR	WBL	WBT	WBR	NBL	NBT	NBR	SBL	SBT	SBR
Actuated g/C Ratio	0.24	0.21		0.19	0.15		0.60	0.56		0.58	0.50	
v/c Ratio	0.33	0.19		0.01	0.09		0.23	0.51		0.10	0.42	
Control Delay	23.1	26.0		20.5	32.0		7.8	15.1		7.3	15.6	
Queue Delay	0.0	0.0		0.0	0.0		0.0	0.0		0.0	0.0	
Total Delay	23.1	26.0		20.5	32.0		7.8	15.1		7.3	15.6	
LOS	C	C		C	C		A	B		A	B	
Approach Delay		24.1			30.3			14.3			15.1	
Approach LOS		C			C			B			B	
Queue Length 50th (ft)	34	18		1	6		12	137		4	85	
Queue Length 95th (ft)	89	67		9	34		48	282		22	196	
Internal Link Dist (ft)		1881			186			1572			963	
Turn Bay Length (ft)	150						100			165		
Base Capacity (vph)	436	609		387	536		604	3197		531	3075	
Starvation Cap Reductn	0	0		0	0		0	0		0	0	
Spillback Cap Reductn	0	0		0	0		0	0		0	0	
Storage Cap Reductn	0	0		0	0		0	0		0	0	
Reduced v/c Ratio	0.27	0.10		0.01	0.04		0.20	0.32		0.08	0.23	

Intersection Summary

Area Type:	Other
Cycle Length:	120
Actuated Cycle Length:	57.8
Natural Cycle:	75
Control Type:	Actuated-Uncoordinated
Maximum v/c Ratio:	0.51
Intersection Signal Delay:	15.7
Intersection Capacity Utilization	56.1%
Analysis Period (min)	15
	Intersection LOS: B
	ICU Level of Service B

Splits and Phases: 966: N Polk Street/Pineville Road & Industrial Drive/Driveway

Ø1	Ø2	Ø3	Ø4
16 s	66 s	14 s	24 s
Ø5	Ø6	Ø7	Ø8
16 s	66 s	16 s	22 s

Pineville Industrial TIA
 1: Industrial Drive & Rodney Street

11/03/2017

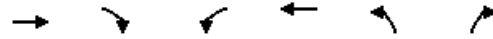

Movement	EBT	EBR	WBL	WBT	NBL	NBR
Lane Configurations	↶			↷	↶	↷
Traffic Volume (veh/h)	34	43	10	43	43	4
Future Volume (Veh/h)	34	43	10	43	43	4
Sign Control	Free		Free		Stop	
Grade	2%		-1%		5%	
Peak Hour Factor	0.90	0.90	0.90	0.90	0.90	0.90
Hourly flow rate (vph)	38	48	11	48	48	4
Pedestrians						
Lane Width (ft)						
Walking Speed (ft/s)						
Percent Blockage						
Right turn flare (veh)						
Median type	None		None			
Median storage (veh)						
Upstream signal (ft)						
pX, platoon unblocked						
vC, conflicting volume			86		132	62
vC1, stage 1 conf vol						
vC2, stage 2 conf vol						
vCu, unblocked vol			86		132	62
tC, single (s)			4.1		6.4	6.2
tC, 2 stage (s)						
tF (s)			2.2		3.5	3.3
p0 queue free %			99		94	100
cM capacity (veh/h)			1510		855	1003





















Direction, Lane #	EB 1	WB 1	NB 1
Volume Total	86	59	52
Volume Left	0	11	48
Volume Right	48	0	4
cSH	1700	1510	865
Volume to Capacity	0.05	0.01	0.06
Queue Length 95th (ft)	0	1	5
Control Delay (s)	0.0	1.4	9.4
Lane LOS		A	A
Approach Delay (s)	0.0	1.4	9.4
Approach LOS			A

Intersection Summary			
Average Delay		2.9	
Intersection Capacity Utilization	19.5%	ICU Level of Service	A
Analysis Period (min)	15		

Pineville Industrial TIA

966: N Polk Street/Pineville Road & Industrial Drive/Driveway

11/03/2017

												
Lane Group	EBL	EBT	EBR	WBL	WBT	WBR	NBL	NBT	NBR	SBL	SBT	SBR
Lane Configurations												
Traffic Volume (vph)	197	4	95	9	1	42	44	793	10	7	1162	127
Future Volume (vph)	197	4	95	9	1	42	44	793	10	7	1162	127
Ideal Flow (vphpl)	1900	1900	1900	1900	1900	1900	1900	1900	1900	1900	1900	1900
Storage Length (ft)	150		0	0		75	100		0	165		0
Storage Lanes	1		0	1		1	1		0	1		0
Taper Length (ft)	25			25			25			25		
Lane Util. Factor	1.00	1.00	1.00	1.00	1.00	1.00	1.00	0.95	0.95	1.00	0.95	0.95
Frt		0.855			0.853			0.998			0.985	
Flt Protected	0.950			0.950			0.950			0.950		
Satd. Flow (prot)	1770	1593	0	1770	1589	0	1770	3532	0	1770	3486	0
Flt Permitted	0.431			0.686			0.082			0.278		
Satd. Flow (perm)	803	1593	0	1278	1589	0	153	3532	0	518	3486	0
Right Turn on Red			No			No			No			No
Satd. Flow (RTOR)												
Link Speed (mph)		35			35			35			35	
Link Distance (ft)		1961			266			1652			1043	
Travel Time (s)		38.2			5.2			32.2			20.3	
Peak Hour Factor	0.90	0.90	0.90	0.90	0.90	0.90	0.90	0.90	0.90	0.90	0.90	0.90
Adj. Flow (vph)	219	4	106	10	1	47	49	881	11	8	1291	141
Shared Lane Traffic (%)												
Lane Group Flow (vph)	219	110	0	10	48	0	49	892	0	8	1432	0
Enter Blocked Intersection	No	No	No	No	No	No	No	No	No	No	No	No
Lane Alignment	Left	Left	Right	Left	Left	Right	Left	Left	Right	Left	Left	Right
Median Width(ft)		12			12			12			12	
Link Offset(ft)		0			0			0			0	
Crosswalk Width(ft)		16			16			16			16	
Two way Left Turn Lane												Yes
Headway Factor	1.00	1.00	1.00	1.00	1.00	1.00	1.00	1.00	1.00	1.00	1.00	1.00
Turning Speed (mph)	15		9	15		9	15		9	15		9
Turn Type	pm+pt	NA		pm+pt	NA		pm+pt	NA		pm+pt	NA	
Protected Phases	7	4		3	8		5	2		1	6	
Permitted Phases	4			8			2			6		
Detector Phase	7	4		3	8		5	2		1	6	
Switch Phase												
Minimum Initial (s)	7.0	7.0		7.0	7.0		7.0	10.0		7.0	10.0	
Minimum Split (s)	14.0	20.0		14.0	20.0		14.0	21.0		14.0	21.0	
Total Split (s)	16.0	24.0		14.0	22.0		16.0	66.0		16.0	66.0	
Total Split (%)	13.3%	20.0%		11.7%	18.3%		13.3%	55.0%		13.3%	55.0%	
Maximum Green (s)	10.2	18.2		8.6	16.2		10.4	59.7		9.7	59.7	
Yellow Time (s)	3.0	3.8		3.0	3.8		3.0	3.8		3.0	3.8	
All-Red Time (s)	2.8	2.0		2.4	2.0		2.6	2.5		3.3	2.5	
Lost Time Adjust (s)	-0.8	-0.8		-0.4	-0.8		-0.6	-1.3		-1.3	-1.3	
Total Lost Time (s)	5.0	5.0		5.0	5.0		5.0	5.0		5.0	5.0	
Lead/Lag	Lead	Lag		Lead	Lag		Lead	Lag		Lead	Lag	
Lead-Lag Optimize?	Yes	Yes		Yes	Yes		Yes	Yes		Yes	Yes	
Vehicle Extension (s)	2.0	2.0		2.0	2.0		2.0	3.0		2.0	3.0	
Recall Mode	None	None		None	None		None	Min		None	Min	
Act Effect Green (s)	19.4	17.8		13.8	10.5		51.0	49.7		48.2	42.1	

Pineville Industrial TIA
 966: N Polk Street/Pineville Road & Industrial Drive/Driveway

11/03/2017

Lane Group	EBL	EBT	EBR	WBL	WBT	WBR	NBL	NBT	NBR	SBL	SBT	SBR
Actuated g/C Ratio	0.23	0.21		0.17	0.13		0.62	0.60		0.58	0.51	
v/c Ratio	0.67	0.32		0.04	0.24		0.18	0.42		0.02	0.81	
Control Delay	43.3	37.2		29.9	45.1		8.2	10.6		7.1	22.7	
Queue Delay	0.0	0.0		0.0	0.0		0.0	0.0		0.0	0.0	
Total Delay	43.3	37.2		29.9	45.1		8.2	10.6		7.1	22.7	
LOS	D	D		C	D		A	B		A	C	
Approach Delay		41.3			42.5			10.4			22.6	
Approach LOS		D			D			B			C	
Queue Length 50th (ft)	105	50		4	26		10	123		2	363	
Queue Length 95th (ft)	#238	133		20	71		26	261		8	527	
Internal Link Dist (ft)		1881			186			1572			963	
Turn Bay Length (ft)	150						100			165		
Base Capacity (vph)	346	466		304	380		345	2611		507	2555	
Starvation Cap Reductn	0	0		0	0		0	0		0	0	
Spillback Cap Reductn	0	0		0	0		0	0		0	0	
Storage Cap Reductn	0	0		0	0		0	0		0	0	
Reduced v/c Ratio	0.63	0.24		0.03	0.13		0.14	0.34		0.02	0.56	

Intersection Summary

Area Type: Other
 Cycle Length: 120
 Actuated Cycle Length: 82.9
 Natural Cycle: 90
 Control Type: Actuated-Uncoordinated
 Maximum v/c Ratio: 0.81
 Intersection Signal Delay: 21.1
 Intersection Capacity Utilization 62.5%
 Analysis Period (min) 15
 Intersection LOS: C
 ICU Level of Service B
 # 95th percentile volume exceeds capacity, queue may be longer.
 Queue shown is maximum after two cycles.

Splits and Phases: 966: N Polk Street/Pineville Road & Industrial Drive/Driveway

Ø1 16 s	Ø2 66 s	Ø3 14 s	Ø4 24 s
Ø5 16 s	Ø6 66 s	Ø7 16 s	Ø8 22 s

Pineville Industrial TIA
 1: Industrial Drive & Rodney Street

11/03/2017























Movement	EBT	EBR	WBL	WBT	NBL	NBR
Lane Configurations	↶			↷	↶	↷
Traffic Volume (veh/h)	75	43	3	83	45	10
Future Volume (Veh/h)	75	43	3	83	45	10
Sign Control	Free		Free		Stop	
Grade	2%		-1%		5%	
Peak Hour Factor	0.90	0.90	0.90	0.90	0.90	0.90
Hourly flow rate (vph)	83	48	3	92	50	11
Pedestrians						
Lane Width (ft)						
Walking Speed (ft/s)						
Percent Blockage						
Right turn flare (veh)						
Median type	None		None			
Median storage (veh)						
Upstream signal (ft)						
pX, platoon unblocked						
vC, conflicting volume			131		205	107
vC1, stage 1 conf vol						
vC2, stage 2 conf vol						
vCu, unblocked vol			131		205	107
tC, single (s)			4.1		6.4	6.2
tC, 2 stage (s)						
tF (s)			2.2		3.5	3.3
p0 queue free %			100		94	99
cM capacity (veh/h)			1454		781	947
Direction, Lane #	EB 1	WB 1	NB 1			
Volume Total	131	95	61			
Volume Left	0	3	50			
Volume Right	48	0	11			
cSH	1700	1454	807			
Volume to Capacity	0.08	0.00	0.08			
Queue Length 95th (ft)	0	0	6			
Control Delay (s)	0.0	0.3	9.8			
Lane LOS		A	A			
Approach Delay (s)	0.0	0.3	9.8			
Approach LOS			A			
Intersection Summary						
Average Delay			2.2			
Intersection Capacity Utilization			16.8%	ICU Level of Service	A	
Analysis Period (min)			15			

2024 Phase II Background Traffic Volumes

Pineville Industrial TIA

966: N Polk Street/Pineville Road & Industrial Drive/Driveway

11/03/2017

												
Lane Group	EBL	EBT	EBR	WBL	WBT	WBR	NBL	NBT	NBR	SBL	SBT	SBR
Lane Configurations												
Traffic Volume (vph)	134	0	71	5	2	21	186	986	16	44	519	238
Future Volume (vph)	134	0	71	5	2	21	186	986	16	44	519	238
Ideal Flow (vphpl)	1900	1900	1900	1900	1900	1900	1900	1900	1900	1900	1900	1900
Storage Length (ft)	150		0	0		75	100		0	165		0
Storage Lanes	1		0	1		1	1		0	1		0
Taper Length (ft)	25			25			25			25		
Lane Util. Factor	1.00	1.00	1.00	1.00	1.00	1.00	1.00	0.95	0.95	1.00	0.95	0.95
Frt		0.850			0.862			0.998			0.953	
Flt Protected	0.950			0.950			0.950			0.950		
Satd. Flow (prot)	1770	1583	0	1770	1606	0	1770	3532	0	1770	3373	0
Flt Permitted	0.449						0.186			0.178		
Satd. Flow (perm)	836	1583	0	1863	1606	0	346	3532	0	332	3373	0
Right Turn on Red			No			No			No			No
Satd. Flow (RTOR)												
Link Speed (mph)		35			35			35			35	
Link Distance (ft)		1961			266			1652			1043	
Travel Time (s)		38.2			5.2			32.2			20.3	
Peak Hour Factor	0.90	0.90	0.90	0.90	0.90	0.90	0.90	0.90	0.90	0.90	0.90	0.90
Adj. Flow (vph)	149	0	79	6	2	23	207	1096	18	49	577	264
Shared Lane Traffic (%)												
Lane Group Flow (vph)	149	79	0	6	25	0	207	1114	0	49	841	0
Enter Blocked Intersection	No	No	No	No	No	No	No	No	No	No	No	No
Lane Alignment	Left	Left	Right	Left	Left	Right	Left	Left	Right	Left	Left	Right
Median Width(ft)		12			12			12			12	
Link Offset(ft)		0			0			0			0	
Crosswalk Width(ft)		16			16			16			16	
Two way Left Turn Lane												Yes
Headway Factor	1.00	1.00	1.00	1.00	1.00	1.00	1.00	1.00	1.00	1.00	1.00	1.00
Turning Speed (mph)	15		9	15		9	15		9	15		9
Turn Type	pm+pt	NA		pm+pt	NA		pm+pt	NA		pm+pt	NA	
Protected Phases	7	4		3	8		5	2		1	6	
Permitted Phases	4			8			2			6		
Detector Phase	7	4		3	8		5	2		1	6	
Switch Phase												
Minimum Initial (s)	7.0	7.0		7.0	7.0		7.0	10.0		7.0	10.0	
Minimum Split (s)	14.0	20.0		14.0	20.0		14.0	21.0		14.0	21.0	
Total Split (s)	16.0	24.0		14.0	22.0		16.0	66.0		16.0	66.0	
Total Split (%)	13.3%	20.0%		11.7%	18.3%		13.3%	55.0%		13.3%	55.0%	
Maximum Green (s)	10.2	18.2		8.6	16.2		10.4	59.7		9.7	59.7	
Yellow Time (s)	3.0	3.8		3.0	3.8		3.0	3.8		3.0	3.8	
All-Red Time (s)	2.8	2.0		2.4	2.0		2.6	2.5		3.3	2.5	
Lost Time Adjust (s)	-0.8	-0.8		-0.4	-0.8		-0.6	-1.3		-1.3	-1.3	
Total Lost Time (s)	5.0	5.0		5.0	5.0		5.0	5.0		5.0	5.0	
Lead/Lag	Lead	Lag		Lead	Lag		Lead	Lag		Lead	Lag	
Lead-Lag Optimize?	Yes	Yes		Yes	Yes		Yes	Yes		Yes	Yes	
Vehicle Extension (s)	2.0	2.0		2.0	2.0		2.0	3.0		2.0	3.0	
Recall Mode	None	None		None	None		None	Min		None	Min	
Act Effect Green (s)	14.5	12.9		10.7	8.7		39.0	33.5		33.6	24.7	

Pineville Industrial TIA
 966: N Polk Street/Pineville Road & Industrial Drive/Driveway

11/03/2017

Lane Group	EBL	EBT	EBR	WBL	WBT	WBR	NBL	NBT	NBR	SBL	SBT	SBR
Actuated g/C Ratio	0.22	0.20		0.16	0.13		0.59	0.51		0.51	0.38	
v/c Ratio	0.45	0.26		0.02	0.12		0.48	0.62		0.13	0.66	
Control Delay	28.0	29.2		23.0	34.6		10.8	16.3		7.7	20.3	
Queue Delay	0.0	0.0		0.0	0.0		0.0	0.0		0.0	0.0	
Total Delay	28.0	29.2		23.0	34.6		10.8	16.3		7.7	20.3	
LOS	C	C		C	C		B	B		A	C	
Approach Delay		28.4			32.4			15.4			19.6	
Approach LOS		C			C			B			B	
Queue Length 50th (ft)	53	27		2	9		24	168		5	123	
Queue Length 95th (ft)	117	84		12	37		81	331		24	248	
Internal Link Dist (ft)		1881			186			1572			963	
Turn Bay Length (ft)	150						100			165		
Base Capacity (vph)	370	511		338	447		462	3095		443	2956	
Starvation Cap Reductn	0	0		0	0		0	0		0	0	
Spillback Cap Reductn	0	0		0	0		0	0		0	0	
Storage Cap Reductn	0	0		0	0		0	0		0	0	
Reduced v/c Ratio	0.40	0.15		0.02	0.06		0.45	0.36		0.11	0.28	

Intersection Summary

Area Type: Other
 Cycle Length: 120
 Actuated Cycle Length: 65.8
 Natural Cycle: 80
 Control Type: Actuated-Uncoordinated
 Maximum v/c Ratio: 0.66
 Intersection Signal Delay: 18.3
 Intersection Capacity Utilization 60.2%
 Analysis Period (min) 15
 Intersection LOS: B
 ICU Level of Service B

Splits and Phases: 966: N Polk Street/Pineville Road & Industrial Drive/Driveway

Ø1 16 s	Ø2 66 s	Ø3 14 s	Ø4 24 s
Ø5 16 s	Ø6 66 s	Ø7 16 s	Ø8 22 s

Pineville Industrial TIA
 1: Industrial Drive & Rodney Street

11/03/2017



Movement	EBT	EBR	WBL	WBT	NBL	NBR
Lane Configurations	↶			↷	↶	↷
Traffic Volume (veh/h)	38	52	15	47	48	5
Future Volume (Veh/h)	38	52	15	47	48	5
Sign Control	Free		Free		Stop	
Grade	2%		-1%		5%	
Peak Hour Factor	0.90	0.90	0.90	0.90	0.90	0.90
Hourly flow rate (vph)	42	58	17	52	53	6
Pedestrians						
Lane Width (ft)						
Walking Speed (ft/s)						
Percent Blockage						
Right turn flare (veh)						
Median type	None		None			
Median storage (veh)						
Upstream signal (ft)						
pX, platoon unblocked						
vC, conflicting volume			100		157	71
vC1, stage 1 conf vol						
vC2, stage 2 conf vol						
vCu, unblocked vol			100		157	71
tC, single (s)			4.1		6.4	6.2
tC, 2 stage (s)						
tF (s)			2.2		3.5	3.3
p0 queue free %			99		94	99
cM capacity (veh/h)			1493		824	991
Direction, Lane #	EB 1	WB 1	NB 1			
Volume Total	100	69	59			
Volume Left	0	17	53			
Volume Right	58	0	6			
cSH	1700	1493	839			
Volume to Capacity	0.06	0.01	0.07			
Queue Length 95th (ft)	0	1	6			
Control Delay (s)	0.0	1.9	9.6			
Lane LOS		A	A			
Approach Delay (s)	0.0	1.9	9.6			
Approach LOS			A			
Intersection Summary						
Average Delay			3.1			
Intersection Capacity Utilization			20.0%	ICU Level of Service	A	
Analysis Period (min)			15			

Pineville Industrial TIA
 3: Industrial Drive & Site Driveway #1

11/03/2017























Movement	EBL	EBR	NBL	NBT	SBT	SBR
Lane Configurations						
Traffic Volume (veh/h)	2	30	112	281	124	9
Future Volume (Veh/h)	2	30	112	281	124	9
Sign Control	Stop			Free	Free	
Grade	0%			0%	0%	
Peak Hour Factor	0.90	0.90	0.90	0.90	0.90	0.90
Hourly flow rate (vph)	2	33	124	312	138	10
Pedestrians						
Lane Width (ft)						
Walking Speed (ft/s)						
Percent Blockage						
Right turn flare (veh)						
Median type				None	None	
Median storage (veh)						
Upstream signal (ft)						
pX, platoon unblocked						
vC, conflicting volume	703	143	148			
vC1, stage 1 conf vol						
vC2, stage 2 conf vol						
vCu, unblocked vol	703	143	148			
tC, single (s)	6.4	6.2	4.1			
tC, 2 stage (s)						
tF (s)	3.5	3.3	2.2			
p0 queue free %	99	96	91			
cM capacity (veh/h)	369	905	1434			
Direction, Lane #	EB 1	NB 1	SB 1			
Volume Total	35	436	148			
Volume Left	2	124	0			
Volume Right	33	0	10			
cSH	835	1434	1700			
Volume to Capacity	0.04	0.09	0.09			
Queue Length 95th (ft)	3	7	0			
Control Delay (s)	9.5	2.8	0.0			
Lane LOS	A	A				
Approach Delay (s)	9.5	2.8	0.0			
Approach LOS	A					
Intersection Summary						
Average Delay			2.5			
Intersection Capacity Utilization			41.4%	ICU Level of Service	A	
Analysis Period (min)			15			

Pineville Industrial TIA

966: N Polk Street/Pineville Road & Industrial Drive/Driveway

11/03/2017

												
Lane Group	EBL	EBT	EBR	WBL	WBT	WBR	NBL	NBT	NBR	SBL	SBT	SBR
Lane Configurations												
Traffic Volume (vph)	265	5	166	10	1	46	63	875	11	8	1283	158
Future Volume (vph)	265	5	166	10	1	46	63	875	11	8	1283	158
Ideal Flow (vphpl)	1900	1900	1900	1900	1900	1900	1900	1900	1900	1900	1900	1900
Storage Length (ft)	150		0	0		75	100		0	165		0
Storage Lanes	1		0	1		1	1		0	1		0
Taper Length (ft)	25			25			25			25		
Lane Util. Factor	1.00	1.00	1.00	1.00	1.00	1.00	1.00	0.95	0.95	1.00	0.95	0.95
Frt		0.855			0.853			0.998			0.984	
Flt Protected	0.950			0.950			0.950			0.950		
Satd. Flow (prot)	1770	1593	0	1770	1589	0	1770	3532	0	1770	3483	0
Flt Permitted	0.488			0.638			0.070			0.242		
Satd. Flow (perm)	909	1593	0	1188	1589	0	130	3532	0	451	3483	0
Right Turn on Red			No			No			No			No
Satd. Flow (RTOR)												
Link Speed (mph)		35			35			35			35	
Link Distance (ft)		1961			266			1652			1043	
Travel Time (s)		38.2			5.2			32.2			20.3	
Peak Hour Factor	0.90	0.90	0.90	0.90	0.90	0.90	0.90	0.90	0.90	0.90	0.90	0.90
Adj. Flow (vph)	294	6	184	11	1	51	70	972	12	9	1426	176
Shared Lane Traffic (%)												
Lane Group Flow (vph)	294	190	0	11	52	0	70	984	0	9	1602	0
Enter Blocked Intersection	No	No	No	No	No	No	No	No	No	No	No	No
Lane Alignment	Left	Left	Right	Left	Left	Right	Left	Left	Right	Left	Left	Right
Median Width(ft)		12			12			12			12	
Link Offset(ft)		0			0			0			0	
Crosswalk Width(ft)		16			16			16			16	
Two way Left Turn Lane												Yes
Headway Factor	1.00	1.00	1.00	1.00	1.00	1.00	1.00	1.00	1.00	1.00	1.00	1.00
Turning Speed (mph)	15		9	15		9	15		9	15		9
Turn Type	pm+pt	NA		pm+pt	NA		pm+pt	NA		pm+pt	NA	
Protected Phases	7	4		3	8		5	2		1	6	
Permitted Phases	4			8			2			6		
Detector Phase	7	4		3	8		5	2		1	6	
Switch Phase												
Minimum Initial (s)	7.0	7.0		7.0	7.0		7.0	10.0		7.0	10.0	
Minimum Split (s)	14.0	20.0		14.0	20.0		14.0	21.0		14.0	21.0	
Total Split (s)	16.0	24.0		14.0	22.0		16.0	66.0		16.0	66.0	
Total Split (%)	13.3%	20.0%		11.7%	18.3%		13.3%	55.0%		13.3%	55.0%	
Maximum Green (s)	10.2	18.2		8.6	16.2		10.4	59.7		9.7	59.7	
Yellow Time (s)	3.0	3.8		3.0	3.8		3.0	3.8		3.0	3.8	
All-Red Time (s)	2.8	2.0		2.4	2.0		2.6	2.5		3.3	2.5	
Lost Time Adjust (s)	-0.8	-0.8		-0.4	-0.8		-0.6	-1.3		-1.3	-1.3	
Total Lost Time (s)	5.0	5.0		5.0	5.0		5.0	5.0		5.0	5.0	
Lead/Lag	Lead	Lag		Lead	Lag		Lead	Lag		Lead	Lag	
Lead-Lag Optimize?	Yes	Yes		Yes	Yes		Yes	Yes		Yes	Yes	
Vehicle Extension (s)	2.0	2.0		2.0	2.0		2.0	3.0		2.0	3.0	
Recall Mode	None	None		None	None		None	Min		None	Min	
Act Effect Green (s)	23.1	21.3		15.7	10.6		59.5	57.7		55.7	49.7	

Pineville Industrial TIA
 966: N Polk Street/Pineville Road & Industrial Drive/Driveway

11/03/2017

Lane Group	EBL	EBT	EBR	WBL	WBT	WBR	NBL	NBT	NBR	SBL	SBT	SBR
Actuated g/C Ratio	0.24	0.23		0.17	0.11		0.63	0.61		0.59	0.53	
v/c Ratio	0.88	0.53		0.04	0.29		0.28	0.46		0.02	0.87	
Control Delay	64.5	44.3		32.9	50.6		10.3	11.4		7.0	27.5	
Queue Delay	0.0	0.0		0.0	0.0		0.0	0.0		0.0	0.0	
Total Delay	64.5	44.3		32.9	50.6		10.3	11.4		7.0	27.5	
LOS	E	D		C	D		B	B		A	C	
Approach Delay		56.5			47.5			11.3			27.4	
Approach LOS		E			D			B			C	
Queue Length 50th (ft)	175	107		6	33		15	143		2	458	
Queue Length 95th (ft)	#279	#248		21	76		38	300		8	674	
Internal Link Dist (ft)		1881			186			1572			963	
Turn Bay Length (ft)	150						100			165		
Base Capacity (vph)	335	415		282	321		296	2490		448	2304	
Starvation Cap Reductn	0	0		0	0		0	0		0	0	
Spillback Cap Reductn	0	0		0	0		0	0		0	0	
Storage Cap Reductn	0	0		0	0		0	0		0	0	
Reduced v/c Ratio	0.88	0.46		0.04	0.16		0.24	0.40		0.02	0.70	

Intersection Summary

Area Type: Other
 Cycle Length: 120
 Actuated Cycle Length: 94.4
 Natural Cycle: 90
 Control Type: Actuated-Uncoordinated
 Maximum v/c Ratio: 0.88
 Intersection Signal Delay: 26.9
 Intersection Capacity Utilization 80.2%
 Analysis Period (min) 15
 Intersection LOS: C
 ICU Level of Service D
 # 95th percentile volume exceeds capacity, queue may be longer.
 Queue shown is maximum after two cycles.

Splits and Phases: 966: N Polk Street/Pineville Road & Industrial Drive/Driveway

Ø1 16 s	Ø2 66 s	Ø3 14 s	Ø4 24 s
Ø5 16 s	Ø6 66 s	Ø7 16 s	Ø8 22 s

Pineville Industrial TIA
 1: Industrial Drive & Rodney Street

11/03/2017



Movement	EBT	EBR	WBL	WBT	NBL	NBR
Lane Configurations	↶			↷	↶	↷
Traffic Volume (veh/h)	83	49	5	92	55	16
Future Volume (Veh/h)	83	49	5	92	55	16
Sign Control	Free		Free		Stop	
Grade	2%		-1%		5%	
Peak Hour Factor	0.90	0.90	0.90	0.90	0.90	0.90
Hourly flow rate (vph)	92	54	6	102	61	18
Pedestrians						
Lane Width (ft)						
Walking Speed (ft/s)						
Percent Blockage						
Right turn flare (veh)						
Median type	None		None			
Median storage (veh)						
Upstream signal (ft)						
pX, platoon unblocked						
vC, conflicting volume			146		233	119
vC1, stage 1 conf vol						
vC2, stage 2 conf vol						
vCu, unblocked vol			146		233	119
tC, single (s)			4.1		6.4	6.2
tC, 2 stage (s)						
tF (s)			2.2		3.5	3.3
p0 queue free %			100		92	98
cM capacity (veh/h)			1436		752	933

Direction, Lane #	EB 1	WB 1	NB 1
Volume Total	146	108	79
Volume Left	0	6	61
Volume Right	54	0	18
cSH	1700	1436	786
Volume to Capacity	0.09	0.00	0.10
Queue Length 95th (ft)	0	0	8
Control Delay (s)	0.0	0.4	10.1
Lane LOS		A	B
Approach Delay (s)	0.0	0.4	10.1
Approach LOS			B

Intersection Summary			
Average Delay		2.5	
Intersection Capacity Utilization	19.6%	ICU Level of Service	A
Analysis Period (min)	15		

Pineville Industrial TIA
 3: Industrial Drive & Site Driveway #1

11/03/2017























Movement	EBL	EBR	NBL	NBT	SBT	SBR
Lane Configurations	Y			↑	↑	
Traffic Volume (veh/h)	10	112	37	112	403	4
Future Volume (Veh/h)	10	112	37	112	403	4
Sign Control	Stop			Free	Free	
Grade	0%			0%	0%	
Peak Hour Factor	0.90	0.90	0.90	0.90	0.90	0.90
Hourly flow rate (vph)	11	124	41	124	448	4
Pedestrians						
Lane Width (ft)						
Walking Speed (ft/s)						
Percent Blockage						
Right turn flare (veh)						
Median type				None	None	
Median storage (veh)						
Upstream signal (ft)						
pX, platoon unblocked						
vC, conflicting volume	656	450	452			
vC1, stage 1 conf vol						
vC2, stage 2 conf vol						
vCu, unblocked vol	656	450	452			
tC, single (s)	6.4	6.2	4.1			
tC, 2 stage (s)						
tF (s)	3.5	3.3	2.2			
p0 queue free %	97	80	96			
cM capacity (veh/h)	414	609	1109			
Direction, Lane #	EB 1	NB 1	SB 1			
Volume Total	135	165	452			
Volume Left	11	41	0			
Volume Right	124	0	4			
cSH	587	1109	1700			
Volume to Capacity	0.23	0.04	0.27			
Queue Length 95th (ft)	22	3	0			
Control Delay (s)	13.0	2.3	0.0			
Lane LOS	B	A				
Approach Delay (s)	13.0	2.3	0.0			
Approach LOS	B					
Intersection Summary						
Average Delay			2.8			
Intersection Capacity Utilization			46.9%	ICU Level of Service	A	
Analysis Period (min)			15			

2019 Phase I Build Traffic Volumes

Pineville Industrial TIA

966: N Polk Street/Pineville Road & Industrial Drive/Driveway

11/03/2017

												
Lane Group	EBL	EBT	EBR	WBL	WBT	WBR	NBL	NBT	NBR	SBL	SBT	SBR
Lane Configurations												
Traffic Volume (vph)	127	0	67	4	2	19	175	893	15	40	470	221
Future Volume (vph)	127	0	67	4	2	19	175	893	15	40	470	221
Ideal Flow (vphpl)	1900	1900	1900	1900	1900	1900	1900	1900	1900	1900	1900	1900
Storage Length (ft)	150		0	0		75	100		0	165		0
Storage Lanes	1		0	1		1	1		0	1		0
Taper Length (ft)	25			25			25			25		
Lane Util. Factor	1.00	1.00	1.00	1.00	1.00	1.00	1.00	0.95	0.95	1.00	0.95	0.95
Frt		0.850			0.863			0.997			0.952	
Flt Protected	0.950			0.950			0.950			0.950		
Satd. Flow (prot)	1770	1583	0	1770	1608	0	1770	3529	0	1770	3369	0
Flt Permitted	0.465						0.215			0.232		
Satd. Flow (perm)	866	1583	0	1863	1608	0	400	3529	0	432	3369	0
Right Turn on Red			No			No			No			No
Satd. Flow (RTOR)												
Link Speed (mph)		35			35			35			35	
Link Distance (ft)		1961			266			1652			1043	
Travel Time (s)		38.2			5.2			32.2			20.3	
Peak Hour Factor	0.90	0.90	0.90	0.90	0.90	0.90	0.90	0.90	0.90	0.90	0.90	0.90
Adj. Flow (vph)	141	0	74	4	2	21	194	992	17	44	522	246
Shared Lane Traffic (%)												
Lane Group Flow (vph)	141	74	0	4	23	0	194	1009	0	44	768	0
Enter Blocked Intersection	No	No	No	No	No	No	No	No	No	No	No	No
Lane Alignment	Left	Left	Right	Left	Left	Right	Left	Left	Right	Left	Left	Right
Median Width(ft)		12			12			12			12	
Link Offset(ft)		0			0			0			0	
Crosswalk Width(ft)		16			16			16			16	
Two way Left Turn Lane												Yes
Headway Factor	1.00	1.00	1.00	1.00	1.00	1.00	1.00	1.00	1.00	1.00	1.00	1.00
Turning Speed (mph)	15		9	15		9	15		9	15		9
Turn Type	pm+pt	NA		pm+pt	NA		pm+pt	NA		pm+pt	NA	
Protected Phases	7	4		3	8		5	2		1	6	
Permitted Phases	4			8			2			6		
Detector Phase	7	4		3	8		5	2		1	6	
Switch Phase												
Minimum Initial (s)	7.0	7.0		7.0	7.0		7.0	10.0		7.0	10.0	
Minimum Split (s)	14.0	20.0		14.0	20.0		14.0	21.0		14.0	21.0	
Total Split (s)	16.0	24.0		14.0	22.0		16.0	66.0		16.0	66.0	
Total Split (%)	13.3%	20.0%		11.7%	18.3%		13.3%	55.0%		13.3%	55.0%	
Maximum Green (s)	10.2	18.2		8.6	16.2		10.4	59.7		9.7	59.7	
Yellow Time (s)	3.0	3.8		3.0	3.8		3.0	3.8		3.0	3.8	
All-Red Time (s)	2.8	2.0		2.4	2.0		2.6	2.5		3.3	2.5	
Lost Time Adjust (s)	-0.8	-0.8		-0.4	-0.8		-0.6	-1.3		-1.3	-1.3	
Total Lost Time (s)	5.0	5.0		5.0	5.0		5.0	5.0		5.0	5.0	
Lead/Lag	Lead	Lag		Lead	Lag		Lead	Lag		Lead	Lag	
Lead-Lag Optimize?	Yes	Yes		Yes	Yes		Yes	Yes		Yes	Yes	
Vehicle Extension (s)	2.0	2.0		2.0	2.0		2.0	3.0		2.0	3.0	
Recall Mode	None	None		None	None		None	Min		None	Min	
Act Effect Green (s)	14.3	12.8		10.9	9.1		36.1	33.0		31.3	21.7	

Pineville Industrial TIA
 966: N Polk Street/Pineville Road & Industrial Drive/Driveway

11/03/2017

Lane Group	EBL	EBT	EBR	WBL	WBT	WBR	NBL	NBT	NBR	SBL	SBT	SBR
Actuated g/C Ratio	0.24	0.22		0.19	0.16		0.61	0.56		0.53	0.37	
v/c Ratio	0.38	0.22		0.01	0.09		0.40	0.51		0.10	0.62	
Control Delay	24.1	26.3		20.8	32.0		9.4	15.2		7.5	19.2	
Queue Delay	0.0	0.0		0.0	0.0		0.0	0.0		0.0	0.0	
Total Delay	24.1	26.3		20.8	32.0		9.4	15.2		7.5	19.2	
LOS	C	C		C	C		A	B		A	B	
Approach Delay		24.8			30.3			14.3			18.5	
Approach LOS		C			C			B			B	
Queue Length 50th (ft)	41	21		1	7		22	142		5	102	
Queue Length 95th (ft)	104	76		9	34		76	286		22	220	
Internal Link Dist (ft)		1881			186			1572			963	
Turn Bay Length (ft)	150						100			165		
Base Capacity (vph)	434	606		388	533		543	3188		539	3043	
Starvation Cap Reductn	0	0		0	0		0	0		0	0	
Spillback Cap Reductn	0	0		0	0		0	0		0	0	
Storage Cap Reductn	0	0		0	0		0	0		0	0	
Reduced v/c Ratio	0.32	0.12		0.01	0.04		0.36	0.32		0.08	0.25	

Intersection Summary

Area Type: Other
 Cycle Length: 120
 Actuated Cycle Length: 58.7
 Natural Cycle: 75
 Control Type: Actuated-Uncoordinated
 Maximum v/c Ratio: 0.62
 Intersection Signal Delay: 17.0
 Intersection Capacity Utilization 57.2%
 Analysis Period (min) 15
 Intersection LOS: B
 ICU Level of Service B

Splits and Phases: 966: N Polk Street/Pineville Road & Industrial Drive/Driveway

Ø1 16 s	Ø2 66 s	Ø3 14 s	Ø4 24 s
Ø5 16 s	Ø6 66 s	Ø7 16 s	Ø8 22 s

Pineville Industrial TIA
 1: Industrial Drive & Rodney Street

11/03/2017

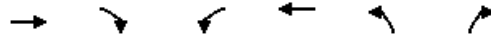

Movement	EBT	EBR	WBL	WBT	NBL	NBR
Lane Configurations	↶			↷	↶	↷
Traffic Volume (veh/h)	34	48	14	43	45	5
Future Volume (Veh/h)	34	48	14	43	45	5
Sign Control	Free		Free		Stop	
Grade	2%		-1%		5%	
Peak Hour Factor	0.90	0.90	0.90	0.90	0.90	0.90
Hourly flow rate (vph)	38	53	16	48	50	6
Pedestrians						
Lane Width (ft)						
Walking Speed (ft/s)						
Percent Blockage						
Right turn flare (veh)						
Median type	None		None			
Median storage (veh)						
Upstream signal (ft)						
pX, platoon unblocked						
vC, conflicting volume			91		144	64
vC1, stage 1 conf vol						
vC2, stage 2 conf vol						
vCu, unblocked vol			91		144	64
tC, single (s)			4.1		6.4	6.2
tC, 2 stage (s)						
tF (s)			2.2		3.5	3.3
p0 queue free %			99		94	99
cM capacity (veh/h)			1504		839	1000
Direction, Lane #	EB 1	WB 1	NB 1			
Volume Total	91	64	56			
Volume Left	0	16	50			
Volume Right	53	0	6			
cSH	1700	1504	853			
Volume to Capacity	0.05	0.01	0.07			
Queue Length 95th (ft)	0	1	5			
Control Delay (s)	0.0	1.9	9.5			
Lane LOS		A	A			
Approach Delay (s)	0.0	1.9	9.5			
Approach LOS			A			
Intersection Summary						
Average Delay			3.1			
Intersection Capacity Utilization			19.7%	ICU Level of Service	A	
Analysis Period (min)			15			

Pineville Industrial TIA
 3: Industrial Drive & Site Driveway #1

11/03/2017























Movement	EBL	EBR	NBL	NBT	SBT	SBR
Lane Configurations						
Traffic Volume (veh/h)	2	30	112	255	112	9
Future Volume (Veh/h)	2	30	112	255	112	9
Sign Control	Stop			Free	Free	
Grade	0%			0%	0%	
Peak Hour Factor	0.90	0.90	0.90	0.90	0.90	0.90
Hourly flow rate (vph)	2	33	124	283	124	10
Pedestrians						
Lane Width (ft)						
Walking Speed (ft/s)						
Percent Blockage						
Right turn flare (veh)						
Median type				None	None	
Median storage (veh)						
Upstream signal (ft)						
pX, platoon unblocked						
vC, conflicting volume	660	129	134			
vC1, stage 1 conf vol						
vC2, stage 2 conf vol						
vCu, unblocked vol	660	129	134			
tC, single (s)	6.4	6.2	4.1			
tC, 2 stage (s)						
tF (s)	3.5	3.3	2.2			
p0 queue free %	99	96	91			
cM capacity (veh/h)	391	921	1451			
Direction, Lane #	EB 1	NB 1	SB 1			
Volume Total	35	407	134			
Volume Left	2	124	0			
Volume Right	33	0	10			
cSH	855	1451	1700			
Volume to Capacity	0.04	0.09	0.08			
Queue Length 95th (ft)	3	7	0			
Control Delay (s)	9.4	2.9	0.0			
Lane LOS	A	A				
Approach Delay (s)	9.4	2.9	0.0			
Approach LOS	A					
Intersection Summary						
Average Delay			2.6			
Intersection Capacity Utilization			39.4%	ICU Level of Service	A	
Analysis Period (min)			15			

Pineville Industrial TIA

966: N Polk Street/Pineville Road & Industrial Drive/Driveway

11/03/2017

												
Lane Group	EBL	EBT	EBR	WBL	WBT	WBR	NBL	NBT	NBR	SBL	SBT	SBR
Lane Configurations												
Traffic Volume (vph)	247	4	157	9	1	42	59	793	10	7	1162	150
Future Volume (vph)	247	4	157	9	1	42	59	793	10	7	1162	150
Ideal Flow (vphpl)	1900	1900	1900	1900	1900	1900	1900	1900	1900	1900	1900	1900
Storage Length (ft)	150		0	0		75	100		0	165		0
Storage Lanes	1		0	1		1	1		0	1		0
Taper Length (ft)	25			25			25			25		
Lane Util. Factor	1.00	1.00	1.00	1.00	1.00	1.00	1.00	0.95	0.95	1.00	0.95	0.95
Frt		0.853			0.853			0.998			0.983	
Flt Protected	0.950			0.950			0.950			0.950		
Satd. Flow (prot)	1770	1589	0	1770	1589	0	1770	3532	0	1770	3479	0
Flt Permitted	0.435			0.645			0.079			0.280		
Satd. Flow (perm)	810	1589	0	1201	1589	0	147	3532	0	522	3479	0
Right Turn on Red			No			No			No			No
Satd. Flow (RTOR)												
Link Speed (mph)		35			35			35			35	
Link Distance (ft)		1961			266			1652			1043	
Travel Time (s)		38.2			5.2			32.2			20.3	
Peak Hour Factor	0.90	0.90	0.90	0.90	0.90	0.90	0.90	0.90	0.90	0.90	0.90	0.90
Adj. Flow (vph)	274	4	174	10	1	47	66	881	11	8	1291	167
Shared Lane Traffic (%)												
Lane Group Flow (vph)	274	178	0	10	48	0	66	892	0	8	1458	0
Enter Blocked Intersection	No	No	No	No	No	No	No	No	No	No	No	No
Lane Alignment	Left	Left	Right	Left	Left	Right	Left	Left	Right	Left	Left	Right
Median Width(ft)		12			12			12			12	
Link Offset(ft)		0			0			0			0	
Crosswalk Width(ft)		16			16			16			16	
Two way Left Turn Lane												Yes
Headway Factor	1.00	1.00	1.00	1.00	1.00	1.00	1.00	1.00	1.00	1.00	1.00	1.00
Turning Speed (mph)	15		9	15		9	15		9	15		9
Turn Type	pm+pt	NA		pm+pt	NA		pm+pt	NA		pm+pt	NA	
Protected Phases	7	4		3	8		5	2		1	6	
Permitted Phases	4			8			2			6		
Detector Phase	7	4		3	8		5	2		1	6	
Switch Phase												
Minimum Initial (s)	7.0	7.0		7.0	7.0		7.0	10.0		7.0	10.0	
Minimum Split (s)	14.0	20.0		14.0	20.0		14.0	21.0		14.0	21.0	
Total Split (s)	16.0	24.0		14.0	22.0		16.0	66.0		16.0	66.0	
Total Split (%)	13.3%	20.0%		11.7%	18.3%		13.3%	55.0%		13.3%	55.0%	
Maximum Green (s)	10.2	18.2		8.6	16.2		10.4	59.7		9.7	59.7	
Yellow Time (s)	3.0	3.8		3.0	3.8		3.0	3.8		3.0	3.8	
All-Red Time (s)	2.8	2.0		2.4	2.0		2.6	2.5		3.3	2.5	
Lost Time Adjust (s)	-0.8	-0.8		-0.4	-0.8		-0.6	-1.3		-1.3	-1.3	
Total Lost Time (s)	5.0	5.0		5.0	5.0		5.0	5.0		5.0	5.0	
Lead/Lag	Lead	Lag		Lead	Lag		Lead	Lag		Lead	Lag	
Lead-Lag Optimize?	Yes	Yes		Yes	Yes		Yes	Yes		Yes	Yes	
Vehicle Extension (s)	2.0	2.0		2.0	2.0		2.0	3.0		2.0	3.0	
Recall Mode	None	None		None	None		None	Min		None	Min	
Act Effect Green (s)	20.6	19.1		13.9	10.4		53.1	51.5		49.4	43.3	

Pineville Industrial TIA
 966: N Polk Street/Pineville Road & Industrial Drive/Driveway

11/03/2017

Lane Group	EBL	EBT	EBR	WBL	WBT	WBR	NBL	NBT	NBR	SBL	SBT	SBR
Actuated g/C Ratio	0.24	0.22		0.16	0.12		0.62	0.60		0.58	0.51	
v/c Ratio	0.81	0.50		0.04	0.25		0.24	0.42		0.02	0.83	
Control Delay	53.3	41.5		30.7	46.2		8.9	10.7		7.1	24.3	
Queue Delay	0.0	0.0		0.0	0.0		0.0	0.0		0.0	0.0	
Total Delay	53.3	41.5		30.7	46.2		8.9	10.7		7.1	24.3	
LOS	D	D		C	D		A	B		A	C	
Approach Delay		48.6			43.5			10.5			24.3	
Approach LOS		D			D			B			C	
Queue Length 50th (ft)	140	87		4	27		13	123		2	380	
Queue Length 95th (ft)	#267	#224		20	72		33	265		8	571	
Internal Link Dist (ft)		1881			186			1572			963	
Turn Bay Length (ft)	150						100			165		
Base Capacity (vph)	340	441		288	360		328	2588		495	2501	
Starvation Cap Reductn	0	0		0	0		0	0		0	0	
Spillback Cap Reductn	0	0		0	0		0	0		0	0	
Storage Cap Reductn	0	0		0	0		0	0		0	0	
Reduced v/c Ratio	0.81	0.40		0.03	0.13		0.20	0.34		0.02	0.58	

Intersection Summary

Area Type: Other
 Cycle Length: 120
 Actuated Cycle Length: 85.7
 Natural Cycle: 90
 Control Type: Actuated-Uncoordinated
 Maximum v/c Ratio: 0.83
 Intersection Signal Delay: 23.9
 Intersection Capacity Utilization 75.6%
 Analysis Period (min) 15
 Intersection LOS: C
 ICU Level of Service D
 # 95th percentile volume exceeds capacity, queue may be longer.
 Queue shown is maximum after two cycles.

Splits and Phases: 966: N Polk Street/Pineville Road & Industrial Drive/Driveway

Ø1	Ø2	Ø3	Ø4
16 s	66 s	14 s	24 s
Ø5	Ø6	Ø7	Ø8
16 s	66 s	16 s	22 s

Pineville Industrial TIA
 1: Industrial Drive & Rodney Street

11/03/2017



Movement	EBT	EBR	WBL	WBT	NBL	NBR
Lane Configurations	↔			↔	↔	
Traffic Volume (veh/h)	75	45	5	83	51	15
Future Volume (Veh/h)	75	45	5	83	51	15
Sign Control	Free			Free	Stop	
Grade	2%			-1%	5%	
Peak Hour Factor	0.90	0.90	0.90	0.90	0.90	0.90
Hourly flow rate (vph)	83	50	6	92	57	17
Pedestrians						
Lane Width (ft)						
Walking Speed (ft/s)						
Percent Blockage						
Right turn flare (veh)						
Median type	None		None			
Median storage (veh)						
Upstream signal (ft)						
pX, platoon unblocked						
vC, conflicting volume			133		212	108
vC1, stage 1 conf vol						
vC2, stage 2 conf vol						
vCu, unblocked vol			133		212	108
tC, single (s)			4.1		6.4	6.2
tC, 2 stage (s)						
tF (s)			2.2		3.5	3.3
p0 queue free %			100		93	98
cM capacity (veh/h)			1452		773	946

Direction, Lane #	EB 1	WB 1	NB 1
Volume Total	133	98	74
Volume Left	0	6	57
Volume Right	50	0	17
cSH	1700	1452	807
Volume to Capacity	0.08	0.00	0.09
Queue Length 95th (ft)	0	0	8
Control Delay (s)	0.0	0.5	9.9
Lane LOS		A	A
Approach Delay (s)	0.0	0.5	9.9
Approach LOS			A

Intersection Summary			
Average Delay		2.6	
Intersection Capacity Utilization	18.9%	ICU Level of Service	A
Analysis Period (min)	15		

Pineville Industrial TIA
 3: Industrial Drive & Site Driveway #1

11/03/2017























Movement	EBL	EBR	NBL	NBT	SBT	SBR
Lane Configurations	Y			↑	↑	
Traffic Volume (veh/h)	10	112	37	102	366	4
Future Volume (Veh/h)	10	112	37	102	366	4
Sign Control	Stop			Free	Free	
Grade	0%			0%	0%	
Peak Hour Factor	0.90	0.90	0.90	0.90	0.90	0.90
Hourly flow rate (vph)	11	124	41	113	407	4
Pedestrians						
Lane Width (ft)						
Walking Speed (ft/s)						
Percent Blockage						
Right turn flare (veh)						
Median type				None	None	
Median storage (veh)						
Upstream signal (ft)						
pX, platoon unblocked						
vC, conflicting volume	604	409	411			
vC1, stage 1 conf vol						
vC2, stage 2 conf vol						
vCu, unblocked vol	604	409	411			
tC, single (s)	6.4	6.2	4.1			
tC, 2 stage (s)						
tF (s)	3.5	3.3	2.2			
p0 queue free %	98	81	96			
cM capacity (veh/h)	445	642	1148			
Direction, Lane #	EB 1	NB 1	SB 1			
Volume Total	135	154	411			
Volume Left	11	41	0			
Volume Right	124	0	4			
cSH	620	1148	1700			
Volume to Capacity	0.22	0.04	0.24			
Queue Length 95th (ft)	21	3	0			
Control Delay (s)	12.4	2.4	0.0			
Lane LOS	B	A				
Approach Delay (s)	12.4	2.4	0.0			
Approach LOS	B					
Intersection Summary						
Average Delay			2.9			
Intersection Capacity Utilization	44.4%		ICU Level of Service	A		
Analysis Period (min)	15					

2024 Phase II Build Traffic Volumes

Pineville Industrial TIA

966: N Polk Street/Pineville Road & Industrial Drive/Driveway

11/03/2017

												
Lane Group	EBL	EBT	EBR	WBL	WBT	WBR	NBL	NBT	NBR	SBL	SBT	SBR
Lane Configurations												
Traffic Volume (vph)	156	0	83	5	2	21	338	986	16	44	519	340
Future Volume (vph)	156	0	83	5	2	21	338	986	16	44	519	340
Ideal Flow (vphpl)	1900	1900	1900	1900	1900	1900	1900	1900	1900	1900	1900	1900
Storage Length (ft)	150		0	0		75	100		0	165		0
Storage Lanes	1		0	1		1	1		0	1		0
Taper Length (ft)	25			25			25			25		
Lane Util. Factor	1.00	1.00	1.00	1.00	1.00	1.00	1.00	0.95	0.95	1.00	0.95	0.95
Frt		0.850			0.862			0.998			0.941	
Flt Protected	0.950			0.950			0.950			0.950		
Satd. Flow (prot)	1770	1583	0	1770	1606	0	1770	3532	0	1770	3330	0
Flt Permitted	0.435						0.141			0.191		
Satd. Flow (perm)	810	1583	0	1863	1606	0	263	3532	0	356	3330	0
Right Turn on Red			No			No			No			No
Satd. Flow (RTOR)												
Link Speed (mph)		35			35			35			35	
Link Distance (ft)		1961			266			1652			1043	
Travel Time (s)		38.2			5.2			32.2			20.3	
Peak Hour Factor	0.90	0.90	0.90	0.90	0.90	0.90	0.90	0.90	0.90	0.90	0.90	0.90
Adj. Flow (vph)	173	0	92	6	2	23	376	1096	18	49	577	378
Shared Lane Traffic (%)												
Lane Group Flow (vph)	173	92	0	6	25	0	376	1114	0	49	955	0
Enter Blocked Intersection	No	No	No	No	No	No	No	No	No	No	No	No
Lane Alignment	Left	Left	Right	Left	Left	Right	Left	Left	Right	Left	Left	Right
Median Width(ft)		12			12			12			12	
Link Offset(ft)		0			0			0			0	
Crosswalk Width(ft)		16			16			16			16	
Two way Left Turn Lane												Yes
Headway Factor	1.00	1.00	1.00	1.00	1.00	1.00	1.00	1.00	1.00	1.00	1.00	1.00
Turning Speed (mph)	15		9	15		9	15		9	15		9
Turn Type	pm+pt	NA		pm+pt	NA		pm+pt	NA		pm+pt	NA	
Protected Phases	7	4		3	8		5	2		1	6	
Permitted Phases	4			8			2			6		
Detector Phase	7	4		3	8		5	2		1	6	
Switch Phase												
Minimum Initial (s)	7.0	7.0		7.0	7.0		7.0	10.0		7.0	10.0	
Minimum Split (s)	14.0	20.0		14.0	20.0		14.0	21.0		14.0	21.0	
Total Split (s)	16.0	24.0		14.0	22.0		16.0	66.0		16.0	66.0	
Total Split (%)	13.3%	20.0%		11.7%	18.3%		13.3%	55.0%		13.3%	55.0%	
Maximum Green (s)	10.2	18.2		8.6	16.2		10.4	59.7		9.7	59.7	
Yellow Time (s)	3.0	3.8		3.0	3.8		3.0	3.8		3.0	3.8	
All-Red Time (s)	2.8	2.0		2.4	2.0		2.6	2.5		3.3	2.5	
Lost Time Adjust (s)	-0.8	-0.8		-0.4	-0.8		-0.6	-1.3		-1.3	-1.3	
Total Lost Time (s)	5.0	5.0		5.0	5.0		5.0	5.0		5.0	5.0	
Lead/Lag	Lead	Lag		Lead	Lag		Lead	Lag		Lead	Lag	
Lead-Lag Optimize?	Yes	Yes		Yes	Yes		Yes	Yes		Yes	Yes	
Vehicle Extension (s)	2.0	2.0		2.0	2.0		2.0	3.0		2.0	3.0	
Recall Mode	None	None		None	None		None	Min		None	Min	
Act Effect Green (s)	14.8	13.2		10.8	8.7		42.2	36.3		35.3	26.6	

Pineville Industrial TIA

966: N Polk Street/Pineville Road & Industrial Drive/Driveway

11/03/2017

Lane Group	EBL	EBT	EBR	WBL	WBT	WBR	NBL	NBT	NBR	SBL	SBT	SBR
Actuated g/C Ratio	0.21	0.19		0.16	0.13		0.61	0.53		0.51	0.39	
v/c Ratio	0.54	0.30		0.02	0.12		0.91	0.60		0.14	0.75	
Control Delay	30.9	30.3		23.2	34.9		46.7	16.0		7.8	22.8	
Queue Delay	0.0	0.0		0.0	0.0		0.0	0.0		0.0	0.0	
Total Delay	30.9	30.3		23.2	34.9		46.7	16.0		7.8	22.8	
LOS	C	C		C	C		D	B		A	C	
Approach Delay		30.7			32.6			23.8			22.1	
Approach LOS		C			C			C			C	
Queue Length 50th (ft)	64	33		2	9		88	168		5	151	
Queue Length 95th (ft)	136	96		12	37		#363	338		25	301	
Internal Link Dist (ft)		1881			186			1572			963	
Turn Bay Length (ft)	150						100			165		
Base Capacity (vph)	348	478		324	416		414	3073		434	2897	
Starvation Cap Reductn	0	0		0	0		0	0		0	0	
Spillback Cap Reductn	0	0		0	0		0	0		0	0	
Storage Cap Reductn	0	0		0	0		0	0		0	0	
Reduced v/c Ratio	0.50	0.19		0.02	0.06		0.91	0.36		0.11	0.33	

Intersection Summary

Area Type: Other

Cycle Length: 120

Actuated Cycle Length: 69

Natural Cycle: 90

Control Type: Actuated-Uncoordinated

Maximum v/c Ratio: 0.91

Intersection Signal Delay: 23.9

Intersection LOS: C

Intersection Capacity Utilization 71.8%

ICU Level of Service C

Analysis Period (min) 15

95th percentile volume exceeds capacity, queue may be longer.

Queue shown is maximum after two cycles.

Splits and Phases: 966: N Polk Street/Pineville Road & Industrial Drive/Driveway

Ø1	Ø2	Ø3	Ø4
16 s	66 s	14 s	24 s
Ø5	Ø6	Ø7	Ø8
16 s	66 s	16 s	22 s

Pineville Industrial TIA
 1: Industrial Drive & Rodney Street

11/03/2017



Movement	EBT	EBR	WBL	WBT	NBL	NBR
Lane Configurations	↶			↷	↶	↷
Traffic Volume (veh/h)	38	63	23	47	50	6
Future Volume (Veh/h)	38	63	23	47	50	6
Sign Control	Free		Free		Stop	
Grade	2%		-1%		5%	
Peak Hour Factor	0.90	0.90	0.90	0.90	0.90	0.90
Hourly flow rate (vph)	42	70	26	52	56	7
Pedestrians						
Lane Width (ft)						
Walking Speed (ft/s)						
Percent Blockage						
Right turn flare (veh)						
Median type	None		None			
Median storage (veh)						
Upstream signal (ft)						
pX, platoon unblocked						
vC, conflicting volume			112		181	77
vC1, stage 1 conf vol						
vC2, stage 2 conf vol						
vCu, unblocked vol			112		181	77
tC, single (s)			4.1		6.4	6.2
tC, 2 stage (s)						
tF (s)			2.2		3.5	3.3
p0 queue free %			98		93	99
cM capacity (veh/h)			1478		794	984

Direction, Lane #	EB 1	WB 1	NB 1
Volume Total	112	78	63
Volume Left	0	26	56
Volume Right	70	0	7
cSH	1700	1478	811
Volume to Capacity	0.07	0.02	0.08
Queue Length 95th (ft)	0	1	6
Control Delay (s)	0.0	2.6	9.8
Lane LOS		A	A
Approach Delay (s)	0.0	2.6	9.8
Approach LOS			A

Intersection Summary			
Average Delay			3.2
Intersection Capacity Utilization	20.4%		ICU Level of Service
Analysis Period (min)	15		A

Pineville Industrial TIA
 3: Industrial Drive & Site Driveway #1

11/03/2017























Movement	EBL	EBR	NBL	NBT	SBT	SBR
Lane Configurations						
Traffic Volume (veh/h)	5	64	367	281	124	28
Future Volume (Veh/h)	5	64	367	281	124	28
Sign Control	Stop			Free	Free	
Grade	0%			0%	0%	
Peak Hour Factor	0.90	0.90	0.90	0.90	0.90	0.90
Hourly flow rate (vph)	6	71	408	312	138	31
Pedestrians						
Lane Width (ft)						
Walking Speed (ft/s)						
Percent Blockage						
Right turn flare (veh)						
Median type				None	None	
Median storage (veh)						
Upstream signal (ft)						
pX, platoon unblocked						
vC, conflicting volume	1282	154	169			
vC1, stage 1 conf vol						
vC2, stage 2 conf vol						
vCu, unblocked vol	1282	154	169			
tC, single (s)	6.4	6.2	4.1			
tC, 2 stage (s)						
tF (s)	3.5	3.3	2.2			
p0 queue free %	95	92	71			
cM capacity (veh/h)	130	892	1409			
Direction, Lane #	EB 1	NB 1	SB 1			
Volume Total	77	720	169			
Volume Left	6	408	0			
Volume Right	71	0	31			
cSH	612	1409	1700			
Volume to Capacity	0.13	0.29	0.10			
Queue Length 95th (ft)	11	30	0			
Control Delay (s)	11.7	6.2	0.0			
Lane LOS	B	A				
Approach Delay (s)	11.7	6.2	0.0			
Approach LOS	B					
Intersection Summary						
Average Delay			5.5			
Intersection Capacity Utilization			57.6%	ICU Level of Service		B
Analysis Period (min)			15			

Pineville Industrial TIA

966: N Polk Street/Pineville Road & Industrial Drive/Driveway

11/03/2017

												
Lane Group	EBL	EBT	EBR	WBL	WBT	WBR	NBL	NBT	NBR	SBL	SBT	SBR
Lane Configurations												
Traffic Volume (vph)	383	5	312	10	1	46	77	875	11	8	1283	180
Future Volume (vph)	383	5	312	10	1	46	77	875	11	8	1283	180
Ideal Flow (vphpl)	1900	1900	1900	1900	1900	1900	1900	1900	1900	1900	1900	1900
Storage Length (ft)	150		0	0		75	100		0	165		0
Storage Lanes	1		0	1		1	1		0	1		0
Taper Length (ft)	25			25			25			25		
Lane Util. Factor	1.00	1.00	1.00	1.00	1.00	1.00	1.00	0.95	0.95	1.00	0.95	0.95
Frt		0.853			0.853			0.998			0.982	
Flt Protected	0.950			0.950			0.950			0.950		
Satd. Flow (prot)	1770	1589	0	1770	1589	0	1770	3532	0	1770	3476	0
Flt Permitted	0.494			0.400			0.067			0.242		
Satd. Flow (perm)	920	1589	0	745	1589	0	125	3532	0	451	3476	0
Right Turn on Red			No			No			No			No
Satd. Flow (RTOR)												
Link Speed (mph)		35			35			35			35	
Link Distance (ft)		1961			266			1652			1043	
Travel Time (s)		38.2			5.2			32.2			20.3	
Peak Hour Factor	0.90	0.90	0.90	0.90	0.90	0.90	0.90	0.90	0.90	0.90	0.90	0.90
Adj. Flow (vph)	426	6	347	11	1	51	86	972	12	9	1426	200
Shared Lane Traffic (%)												
Lane Group Flow (vph)	426	353	0	11	52	0	86	984	0	9	1626	0
Enter Blocked Intersection	No	No	No	No	No	No	No	No	No	No	No	No
Lane Alignment	Left	Left	Right	Left	Left	Right	Left	Left	Right	Left	Left	Right
Median Width(ft)		12			12			12			12	
Link Offset(ft)		0			0			0			0	
Crosswalk Width(ft)		16			16			16			16	
Two way Left Turn Lane												Yes
Headway Factor	1.00	1.00	1.00	1.00	1.00	1.00	1.00	1.00	1.00	1.00	1.00	1.00
Turning Speed (mph)	15		9	15		9	15		9	15		9
Turn Type	pm+pt	NA		pm+pt	NA		pm+pt	NA		pm+pt	NA	
Protected Phases	7	4		3	8		5	2		1	6	
Permitted Phases	4			8			2			6		
Detector Phase	7	4		3	8		5	2		1	6	
Switch Phase												
Minimum Initial (s)	7.0	7.0		7.0	7.0		7.0	10.0		7.0	10.0	
Minimum Split (s)	14.0	20.0		14.0	20.0		14.0	21.0		14.0	21.0	
Total Split (s)	16.0	24.0		14.0	22.0		16.0	66.0		16.0	66.0	
Total Split (%)	13.3%	20.0%		11.7%	18.3%		13.3%	55.0%		13.3%	55.0%	
Maximum Green (s)	10.2	18.2		8.6	16.2		10.4	59.7		9.7	59.7	
Yellow Time (s)	3.0	3.8		3.0	3.8		3.0	3.8		3.0	3.8	
All-Red Time (s)	2.8	2.0		2.4	2.0		2.6	2.5		3.3	2.5	
Lost Time Adjust (s)	-0.8	-0.8		-0.4	-0.8		-0.6	-1.3		-1.3	-1.3	
Total Lost Time (s)	5.0	5.0		5.0	5.0		5.0	5.0		5.0	5.0	
Lead/Lag	Lead	Lag		Lead	Lag		Lead	Lag		Lead	Lag	
Lead-Lag Optimize?	Yes	Yes		Yes	Yes		Yes	Yes		Yes	Yes	
Vehicle Extension (s)	2.0	2.0		2.0	2.0		2.0	3.0		2.0	3.0	
Recall Mode	None	None		None	None		None	Min		None	Min	
Act Effect Green (s)	25.4	23.5		15.4	10.2		62.0	60.1		57.6	51.5	

Pineville Industrial TIA

966: N Polk Street/Pineville Road & Industrial Drive/Driveway

11/03/2017

Lane Group	EBL	EBT	EBR	WBL	WBT	WBR	NBL	NBT	NBR	SBL	SBT	SBR
Actuated g/C Ratio	0.26	0.24		0.16	0.10		0.63	0.61		0.58	0.52	
v/c Ratio	1.18	0.93		0.06	0.32		0.36	0.46		0.02	0.89	
Control Delay	142.8	73.9		33.6	52.2		14.5	11.6		7.0	29.7	
Queue Delay	0.0	0.0		0.0	0.0		0.0	0.0		0.0	0.0	
Total Delay	142.8	73.9		33.6	52.2		14.5	11.6		7.0	29.7	
LOS	F	E		C	D		B	B		A	C	
Approach Delay		111.6			49.0			11.9			29.6	
Approach LOS		F			D			B			C	
Queue Length 50th (ft)	~390	238		6	34		18	143		2	483	
Queue Length 95th (ft)	#508	#546		21	76		57	300		8	#697	
Internal Link Dist (ft)		1881			186			1572			963	
Turn Bay Length (ft)	150						100			165		
Base Capacity (vph)	360	378		229	291		273	2500		429	2269	
Starvation Cap Reductn	0	0		0	0		0	0		0	0	
Spillback Cap Reductn	0	0		0	0		0	0		0	0	
Storage Cap Reductn	0	0		0	0		0	0		0	0	
Reduced v/c Ratio	1.18	0.93		0.05	0.18		0.32	0.39		0.02	0.72	

Intersection Summary

Area Type: Other
 Cycle Length: 120
 Actuated Cycle Length: 98.6
 Natural Cycle: 110
 Control Type: Actuated-Uncoordinated
 Maximum v/c Ratio: 1.18
 Intersection Signal Delay: 42.6
 Intersection Capacity Utilization 87.4%
 Analysis Period (min) 15
 ~ Volume exceeds capacity, queue is theoretically infinite.
 Queue shown is maximum after two cycles.
 # 95th percentile volume exceeds capacity, queue may be longer.
 Queue shown is maximum after two cycles.

Splits and Phases: 966: N Polk Street/Pineville Road & Industrial Drive/Driveway

Ø1 16 s	Ø2 66 s	Ø3 14 s	Ø4 24 s
Ø5 16 s	Ø6 66 s	Ø7 16 s	Ø8 22 s

Pineville Industrial TIA
 1: Industrial Drive & Rodney Street

11/03/2017



Movement	EBT	EBR	WBL	WBT	NBL	NBR
Lane Configurations	↔			↔	↔	
Traffic Volume (veh/h)	83	51	6	92	70	26
Future Volume (Veh/h)	83	51	6	92	70	26
Sign Control	Free			Free	Stop	
Grade	2%			-1%	5%	
Peak Hour Factor	0.90	0.90	0.90	0.90	0.90	0.90
Hourly flow rate (vph)	92	57	7	102	78	29
Pedestrians						
Lane Width (ft)						
Walking Speed (ft/s)						
Percent Blockage						
Right turn flare (veh)						
Median type	None			None		
Median storage (veh)						
Upstream signal (ft)						
pX, platoon unblocked						
vC, conflicting volume			149		236	120
vC1, stage 1 conf vol						
vC2, stage 2 conf vol						
vCu, unblocked vol			149		236	120
tC, single (s)			4.1		6.4	6.2
tC, 2 stage (s)						
tF (s)			2.2		3.5	3.3
p0 queue free %			100		90	97
cM capacity (veh/h)			1432		748	931
Direction, Lane #	EB 1	WB 1	NB 1			
Volume Total	149	109	107			
Volume Left	0	7	78			
Volume Right	57	0	29			
cSH	1700	1432	790			
Volume to Capacity	0.09	0.00	0.14			
Queue Length 95th (ft)	0	0	12			
Control Delay (s)	0.0	0.5	10.3			
Lane LOS		A	B			
Approach Delay (s)	0.0	0.5	10.3			
Approach LOS			B			
Intersection Summary						
Average Delay			3.2			
Intersection Capacity Utilization			21.9%	ICU Level of Service		A
Analysis Period (min)			15			

Pineville Industrial TIA
 3: Industrial Drive & Site Driveway #1

11/03/2017



Movement	EBL	EBR	NBL	NBT	SBT	SBR
Lane Configurations						
Traffic Volume (veh/h)	35	376	73	112	403	7
Future Volume (Veh/h)	35	376	73	112	403	7
Sign Control	Stop			Free	Free	
Grade	0%			0%	0%	
Peak Hour Factor	0.90	0.90	0.90	0.90	0.90	0.90
Hourly flow rate (vph)	39	418	81	124	448	8
Pedestrians						
Lane Width (ft)						
Walking Speed (ft/s)						
Percent Blockage						
Right turn flare (veh)						
Median type				None	None	
Median storage (veh)						
Upstream signal (ft)						
pX, platoon unblocked						
vC, conflicting volume	738	452	456			
vC1, stage 1 conf vol						
vC2, stage 2 conf vol						
vCu, unblocked vol	738	452	456			
tC, single (s)	6.4	6.2	4.1			
tC, 2 stage (s)						
tF (s)	3.5	3.3	2.2			
p0 queue free %	89	31	93			
cM capacity (veh/h)	357	608	1105			
Direction, Lane #						
	EB 1	NB 1	SB 1			
Volume Total	457	205	456			
Volume Left	39	81	0			
Volume Right	418	0	8			
cSH	573	1105	1700			
Volume to Capacity	0.80	0.07	0.27			
Queue Length 95th (ft)	193	6	0			
Control Delay (s)	31.5	3.8	0.0			
Lane LOS	D	A				
Approach Delay (s)	31.5	3.8	0.0			
Approach LOS	D					
Intersection Summary						
Average Delay			13.6			
Intersection Capacity Utilization			66.7%	ICU Level of Service	C	
Analysis Period (min)			15			

Appendix E – Approved Developments



NOT TO SCALE

LEGEND:

- Existing Road
- Proposed Road
- XX AM Peak Hour Volume (vph)
- (XX) PM Peak Hour Volume (vph)

