

An aerial photograph of John's Pass Village, Florida, showing a mix of residential buildings, a marina with numerous boats, and a waterfront promenade. The image is overlaid with a white rectangular border.

John's Pass Village Activity Center Plan

Alternative Compromise

WHY

- Protect the Village
- Compatible redevelopment
- Consistency with the Countywide Plan
- Proactive instead of Reactive Planning

Legend

— John's Pass Village Activity Center Study Area

0.1 0.05 0 0.1 Miles



Relationship with Local Land Regulations

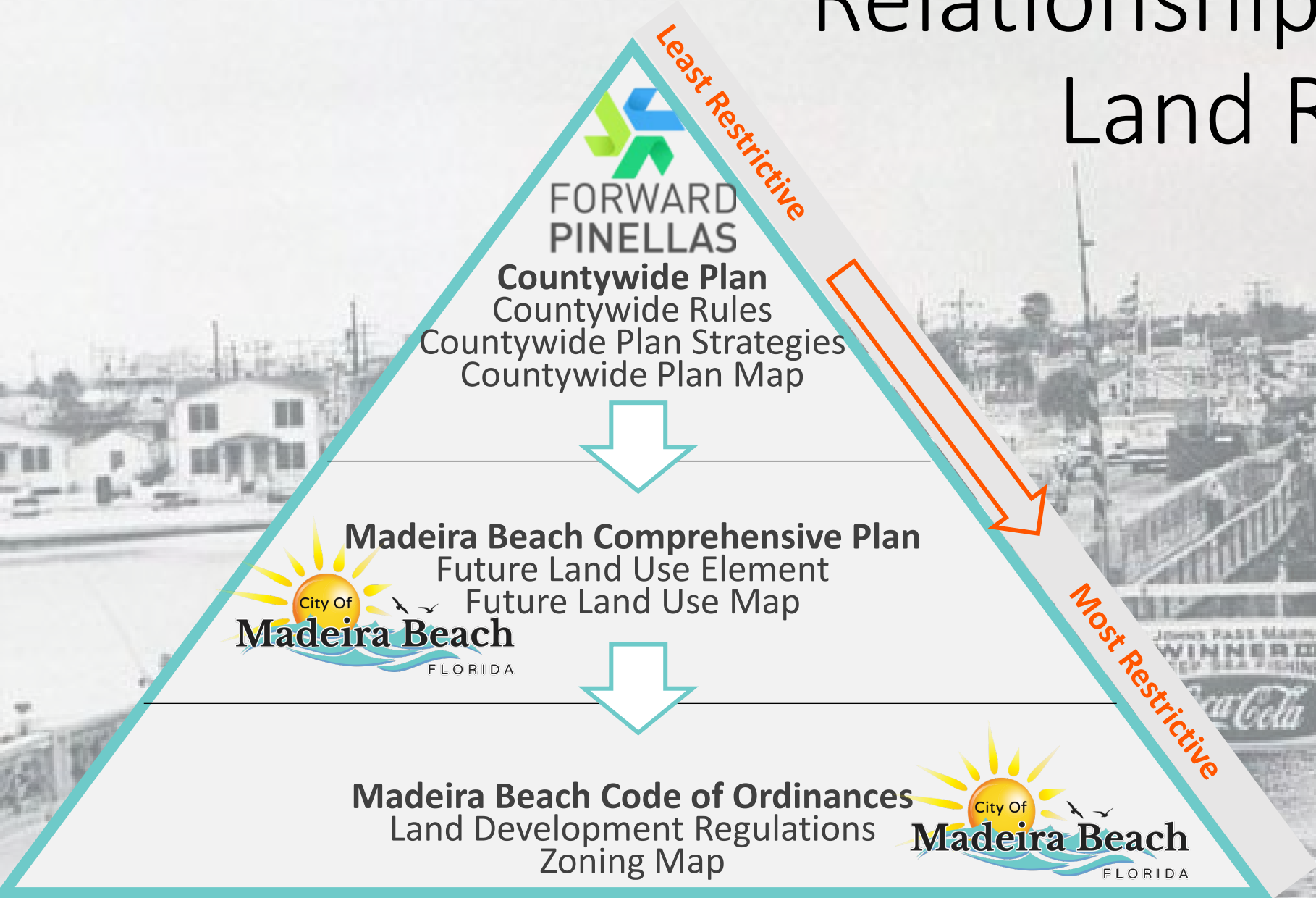

COUNTYWIDE PLAN MAP

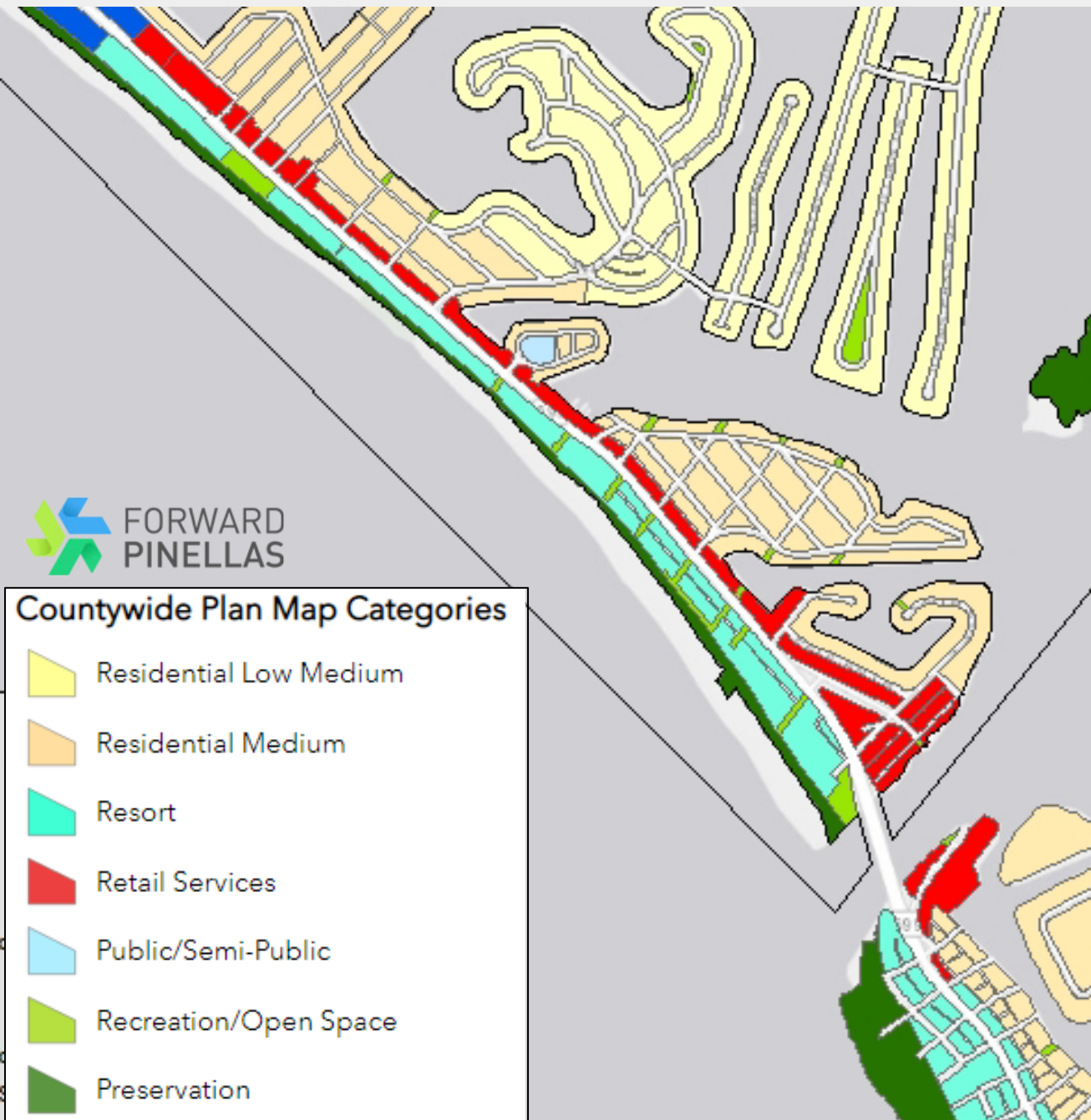

Countywide Plan Map Categories

- Residential Low Medium
- Residential Medium
- Resort
- Retail Services
- Public/Semi-Public
- Recreation/Open Space
- Preservation

MADEIRA BEACH ZONING MAP

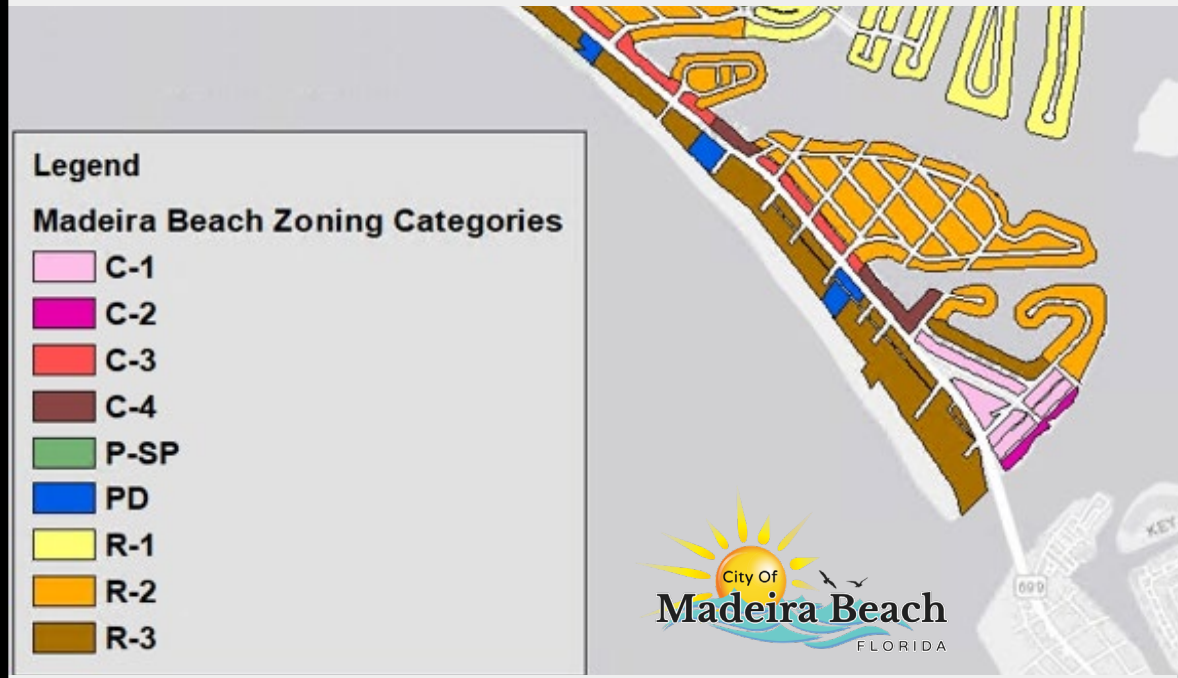

- Legend**
- Madeira Beach Zoning Categories**
- C-1
 - C-2
 - C-3
 - C-4
 - P-SP
 - PD
 - R-1
 - R-2
 - R-3



MADEIRA BEACH FUTURE LAND USE MAP

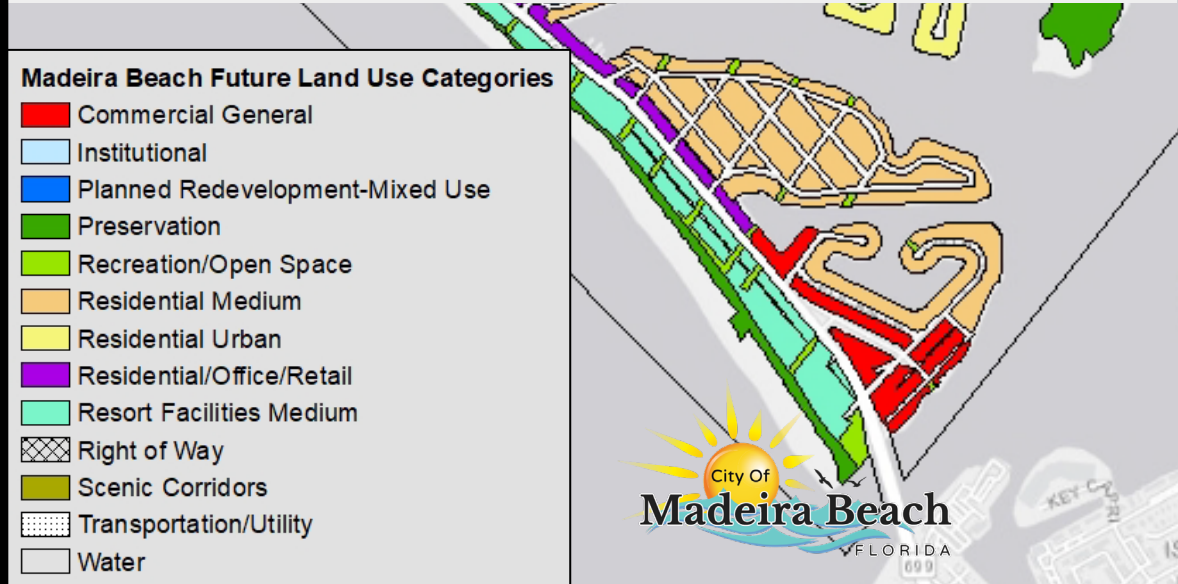

- Madeira Beach Future Land Use Categories**
- Commercial General
 - Institutional
 - Planned Redevelopment-Mixed Use
 - Preservation
 - Recreation/Open Space
 - Residential Medium
 - Residential Urban
 - Residential/Office/Retail
 - Resort Facilities Medium
 - Right of Way
 - Scenic Corridors
 - Transportation/Utility
 - Water



COUNTYWIDE PLAN MAP

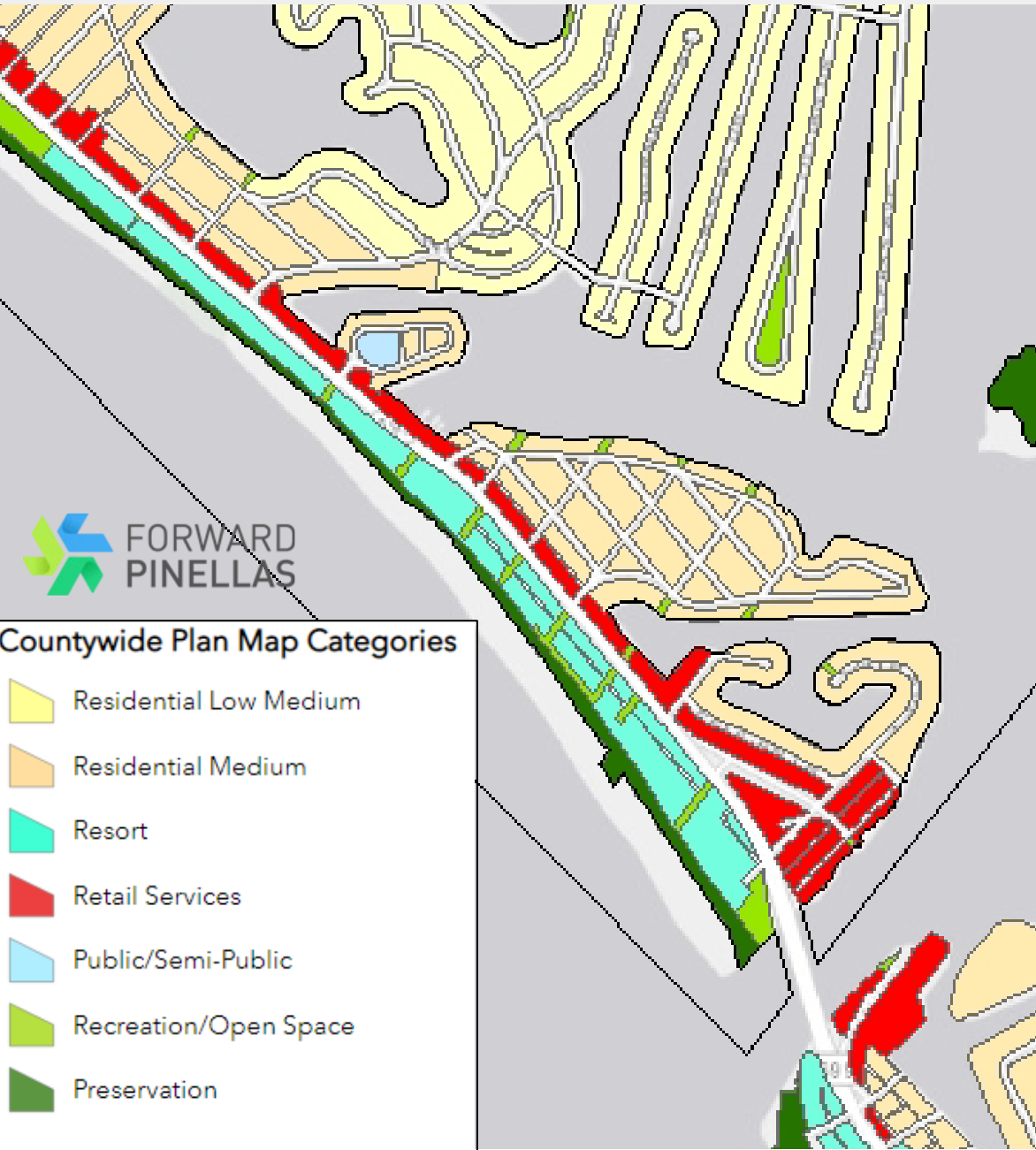

MADEIRA BEACH FUTURE LAND USE MAP

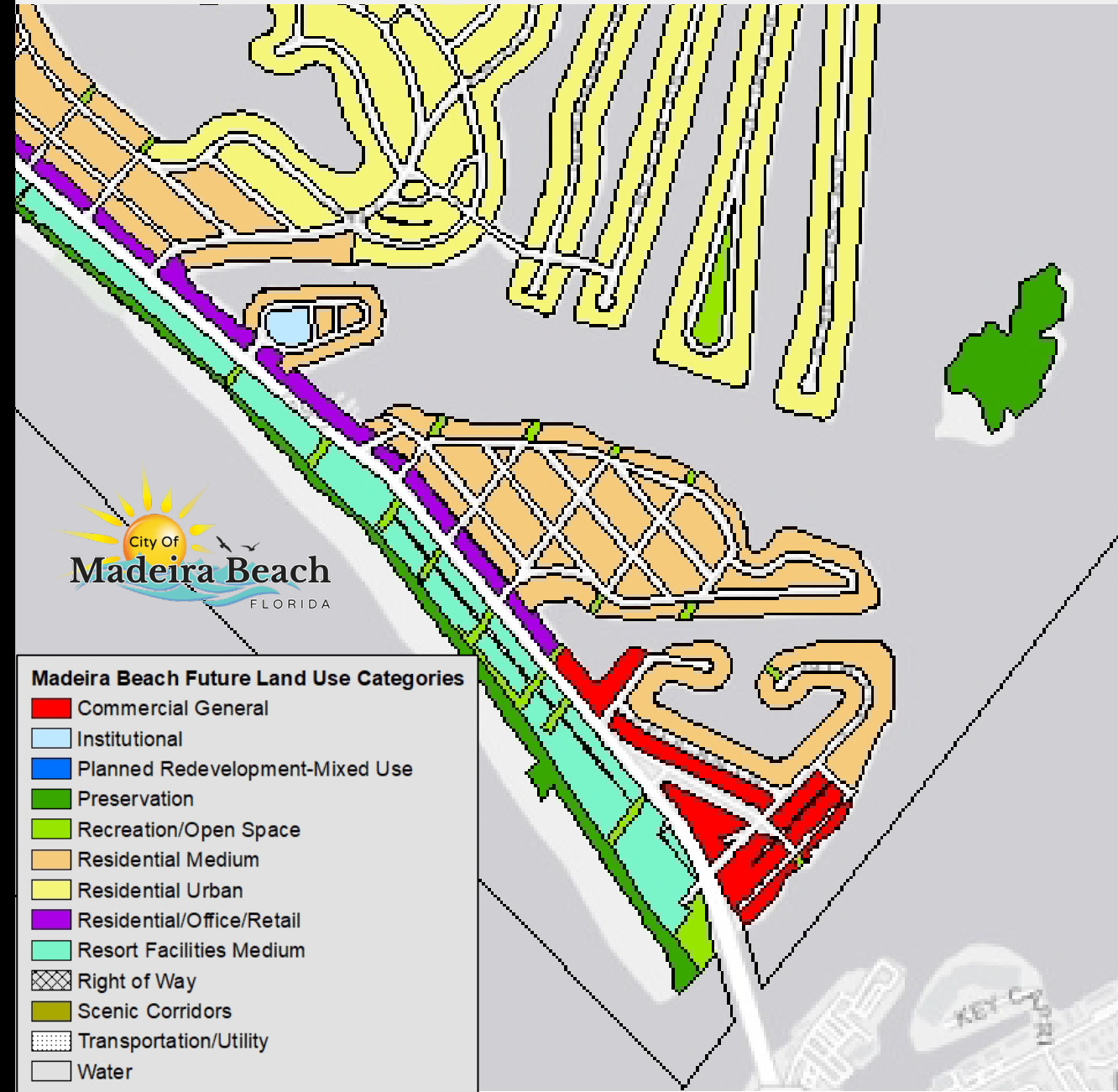

Countywide Plan Map Categories

- Residential Low Medium
- Residential Medium
- Resort
- Retail Services
- Public/Semi-Public
- Recreation/Open Space
- Preservation

Madeira Beach Future Land Use Categories

- Commercial General
- Institutional
- Planned Redevelopment-Mixed Use
- Preservation
- Recreation/Open Space
- Residential Medium
- Residential Urban
- Residential/Office/Retail
- Resort Facilities Medium
- Right of Way
- Scenic Corridors
- Transportation/Utility
- Water

Background and Context

- **2008** the city adopted inconsistent standards, PPC reviewed the amendments and informed the city of the inconsistencies
- **2020** the city rediscovered the inconsistencies and began working with Forward Pinellas
- **2023** the city submits an Activity Center application to Forward Pinellas (Ordinance 2023-01 and Ordinance 2023-02)
 - 9/2023 Forward Pinellas Board recommends approval of an alternative compromise
 - 11/2023 the city (BOC) will vote on the alternative compromise
 - TBD CPA will review and vote on alternative compromise
 - TBD the city (BOC) will vote on adoption of the alternative compromise/Activity Center (Ordinance 2023-01 and Ordinance 2023-02)

EXISTING DENSITIES AND INTENSITIES

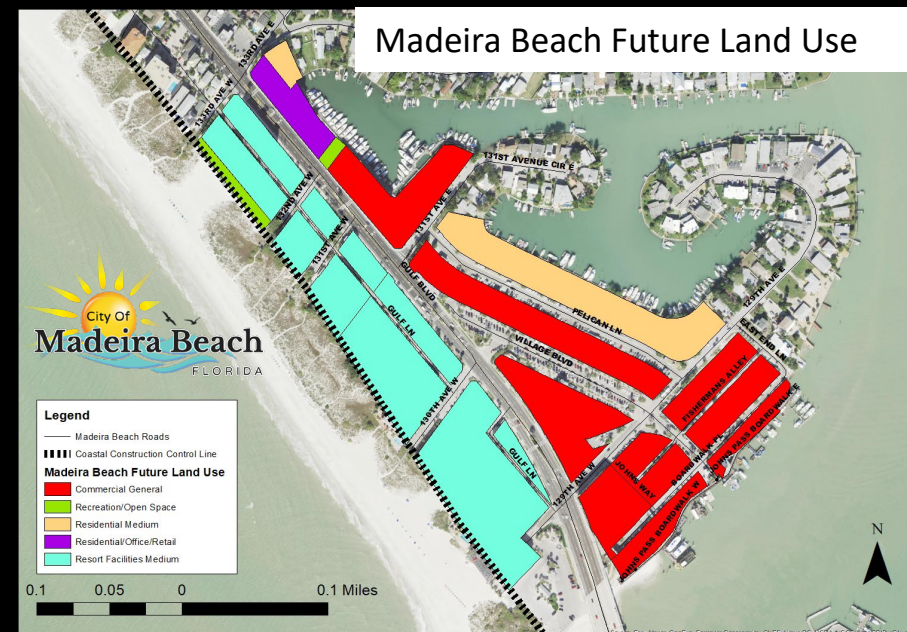
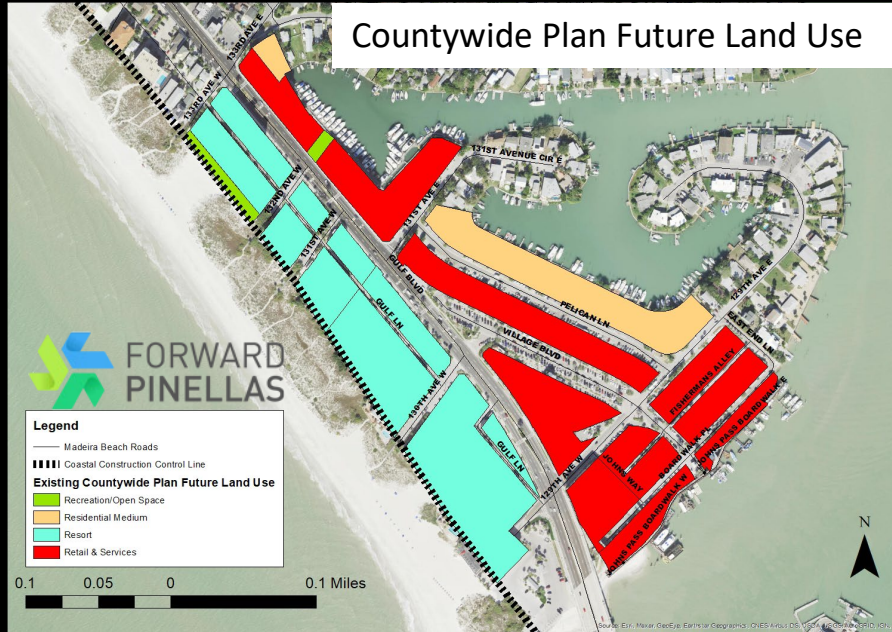

Countywide Plan Future Land Use			Madeira Beach Comprehensive Plan Future Land Use		
Retail and Services	FAR 0.55	RES UPA: 24 TEMP UPA: 40	Commercial General	FAR 1.2	RES UPA: 15 TEMP UPA: 60
Resort	FAR 1.2	RES UPA: 30 TEMP UPA: 50	Residential/Office/Retail	FAR 1.0	RES UPA: 18 TEMP UPA: 45
Residential Medium	FAR 0.5	RES UPA: 15 TEMP UPA: 0	Resort Facilities Medium	FAR 1.0 – 2.0 (Depends on Lot Area)	RES UPA: 18 TEMP UPA: 45-75
Recreation/Open Space	FAR 0.25	RES UPA: 0 TEMP UPA: 0	Residential Medium	Not specified in Comp Plan. In Zoning	RES UPA: 15 TEMP UPA: 0
			Recreation/Open Space	FAR 0.25	RES UPA: 0 TEMP UPA: 0

Example of existing LDRs

C-1 typical lot: what is currently built vs what can be built with current setbacks and 0.55 FAR

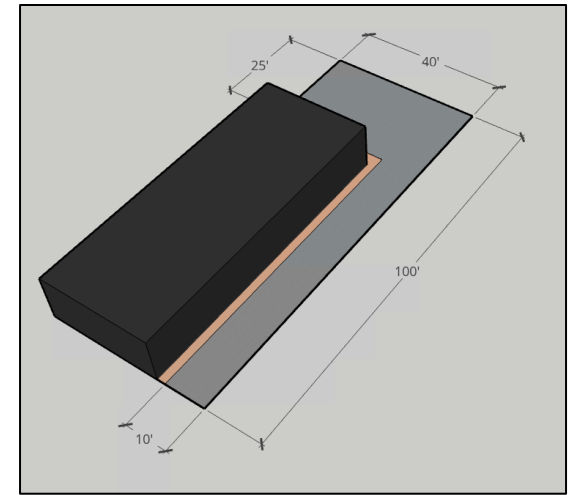
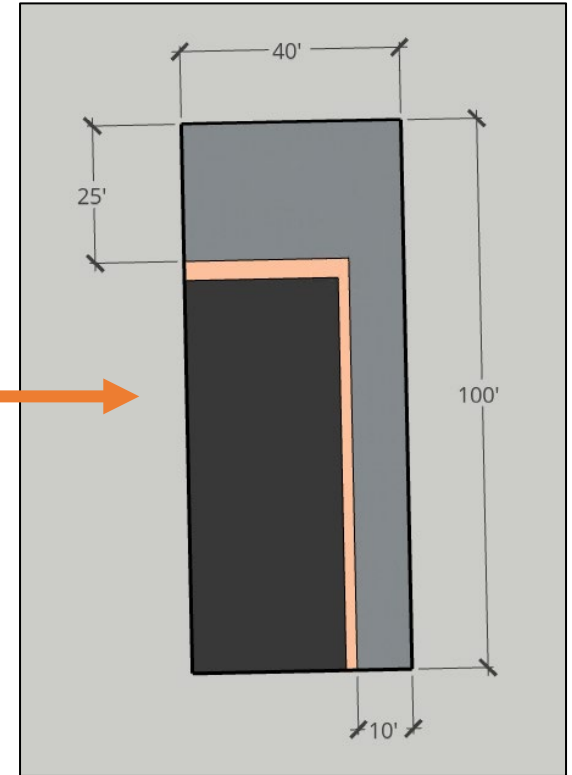
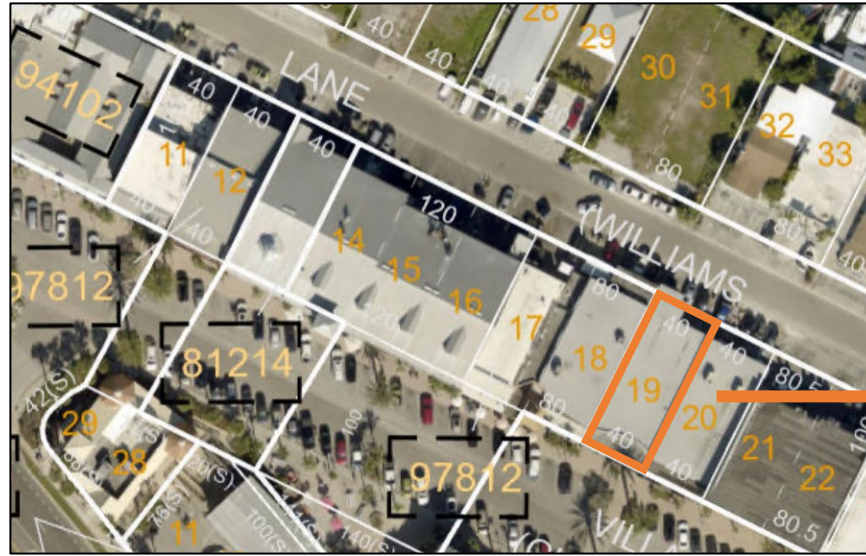

EXISTING FAR AND DENSITY/INTENSITY



TABLE 3.3
EXISTING FAR AND DENSITY RANGE

Character District	Residential Density Range (UPA)	Temporary Lodging Density Range (UPA)	FAR Range
Boardwalk	0	0	0.4 - 1.3
Commercial Core	14.5	12.4	0.2 - 1.1
John's Pass Resort	4.8 - 70	36.4	0.1 - 1.6
Low Int. Mixed Use	9.4 - 37.7	17.5 - 34.0	0.2 - 0.7
Traditional Village	10.9	0	0.03 - 1.7
Transitional	8.3 - 45.5	42 - 58.9	0.2 - 1.3

Why does the boundary go to 133rd Ave?

Looking south towards John's Pass Village



Looking north away from John's Pass Village

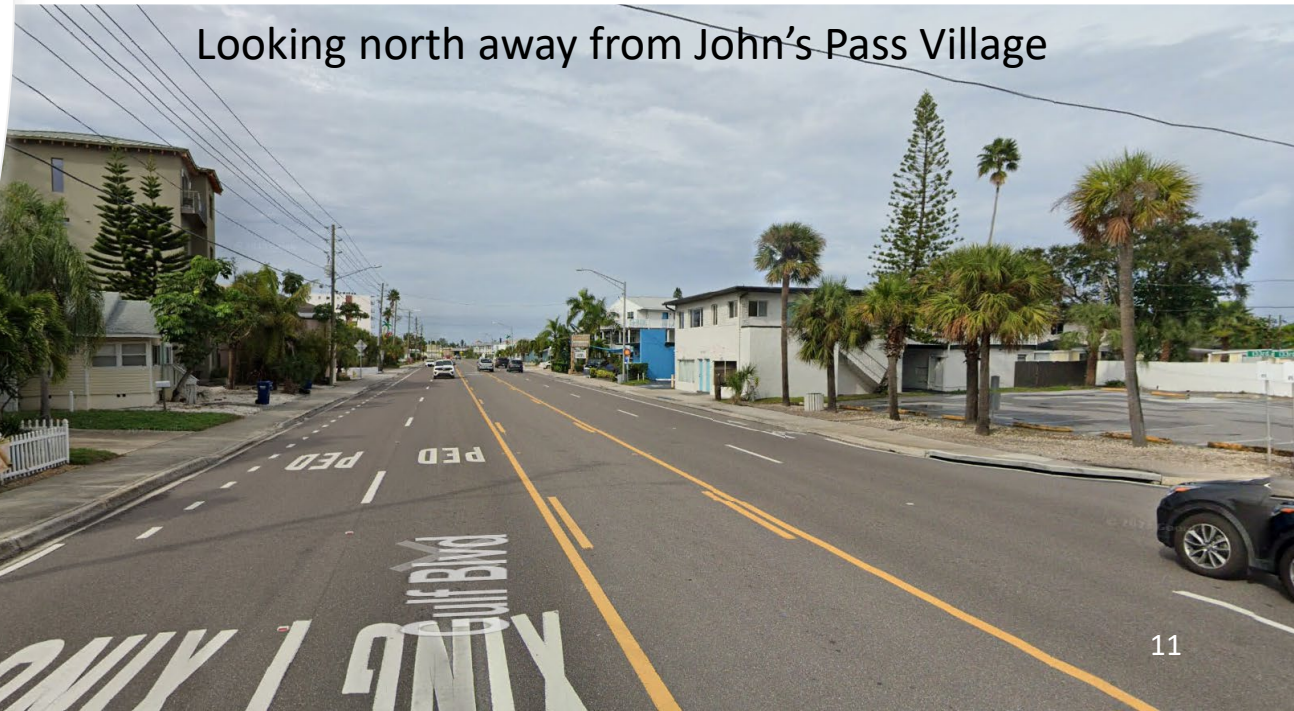

CITY OF MADEIRA BEACH MASTER PLAN

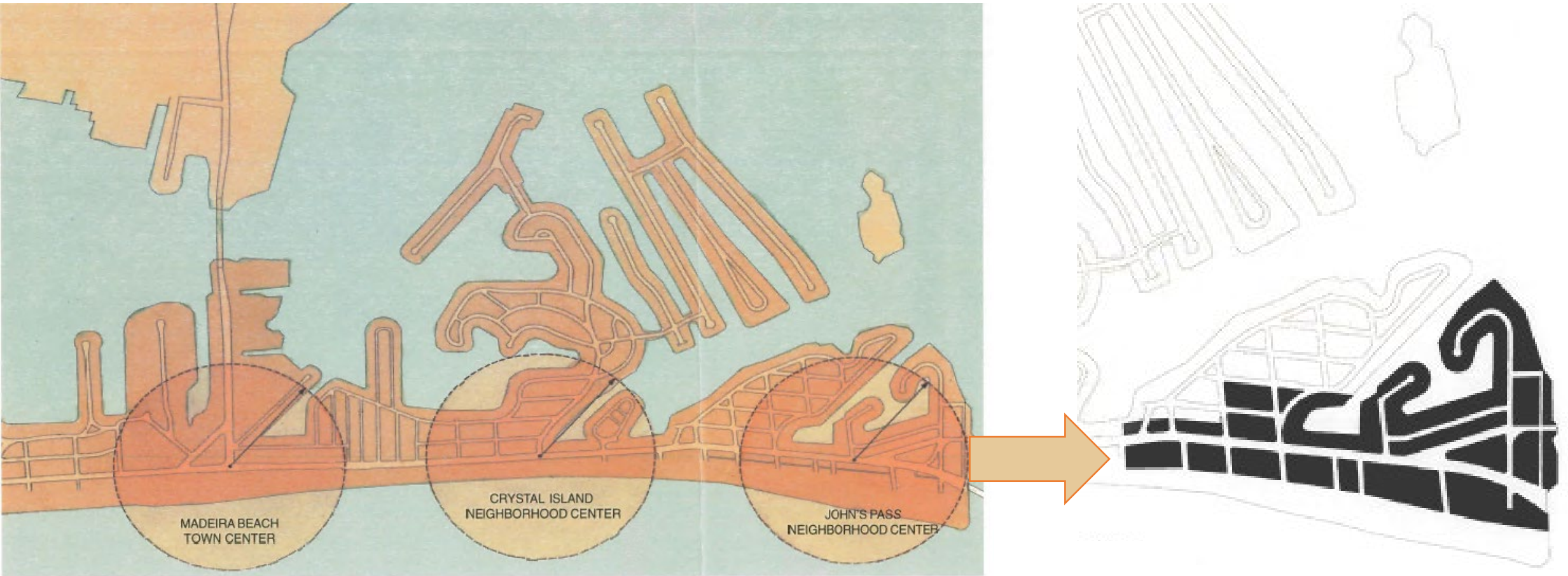

Map Delimiting the Areas to Be included Within the Three Proposed Pedestrian Sheds

Existing Madeira Beach Future Land Use Transitional Character District

- Inconsistent Future Land Use (Recreation Open/Space and Residential Medium) with current development
 - Madeira Bay Resort
 - Areas landward of CCCL
- The proposed John's Pass Village Activity Center Plan corrects these inconsistencies

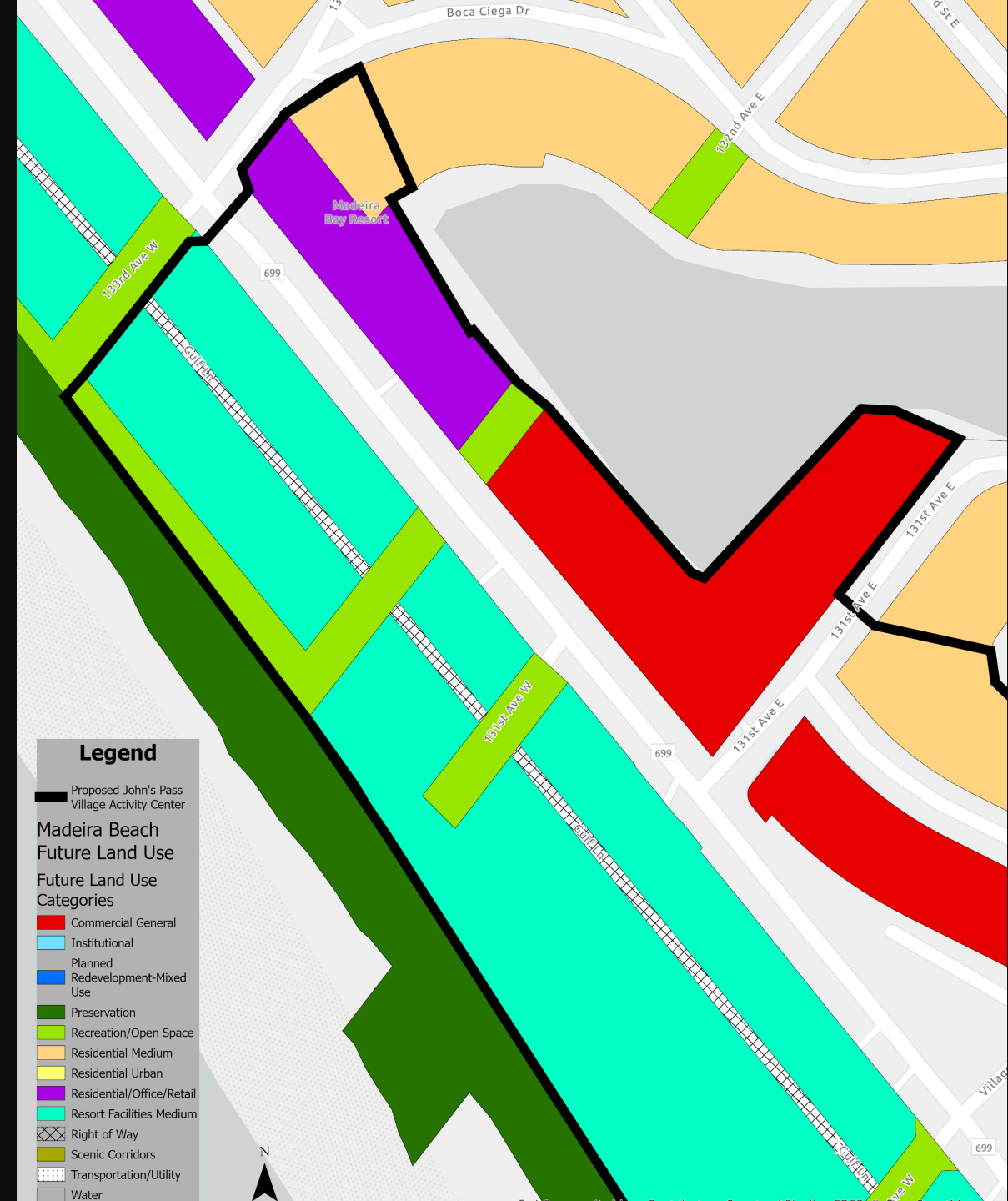

John's Pass Village Activity Center



Proposed Activity Center Plan: Character Districts

Traditional Village

Commercial Core

Boardwalk

John's Pass Resort

Low Intensity Mixed Use

Transitional



Recommendation – Alternative Compromise

Proposed Countywide Plan Map Amendment Findings

- The proposed Activity Center, character districts, associated uses and maximum allowable densities and intensities would address and reconcile existing inconsistencies within John's Pass Village, while recognizing existing development within the amendment area.
- Forward Pinellas staff is in support of a Neighborhood Center designation:
 - Less intense Activity Center subcategory
 - Not identified as an existing or planned Activity Center
 - Amendment area size of 27 acres
 - Limited walkability
- The proposed amendment does involve impacts to the Coastal High Hazard Area. These impacts have been addressed in detail in the attached staff report. Forward Pinellas Staff is not in support of residential density increase.

It is recommended that the board recommend an alternative compromise recommendation as per Section 6.2.1 of the Countywide Rules to approve an amendment to the Activity Center category for 27 acres (m.o.l.) of amendment area.

Community vs Neighborhood Center

Standards Applicable to Activity Center Subcategories

Activity Center Subcategory	Acreage Range	Maximum Density/Intensity Standard ¹			Traffic Generation Rate (Average Daily Trips Per Acre)
		Residential Density (Units Per Acre) ³	Temporary Lodging Density (Units Per Acre) ²	Nonresidential or Mixed-Use Intensity (Floor Area Ratio) ³	
Urban Center	200 to 500	200	330	8.0	724
Major Center	100 to 500	150	250	5.0	542
Community Center	50 to 500	90	150	3.0	325
Neighborhood Center	20 to 500	60	100	2.0	216

Notes:

- ¹ Maximum density/intensity may be calculated on an average areawide basis pursuant to Section 5.2.1.2.
- ² For residential or temporary lodging units, either the applicable UPA or the nonresidential FAR standard may be used. In the alternative, upon adoption of provisions for compliance with Section 5.2.1.3, the density and intensity standards set forth in Table 6 may be used.
- ³ For mixed-use projects, either an all-inclusive FAR standard or a proportionate share of residential density and nonresidential intensity may be used. In the alternative, the mixed-use bonus provisions of Section 4.2.3.6 may be used.



Optional Alternative Temporary Lodging Use Standards

- The Alternative Temporary Lodging Use Standards have stricter requirements compared to what could be built by right
- A Development Agreement would need to include requirements related to design standards, concurrency management standards, hurricane evacuation plans, and mobility management
- The Floor Area Ratio (FAR) would include the parking structure and various other accessory uses
- This would give the Board of Commissioners and residents additional tools to make sure future temporary lodging use developments fit within the character and scale for John’s Pass Village

5.2.2.2

Design Considerations. The purpose of the design considerations is to enable the local government to authorize the increased density and intensity provided for in Table 5-1, subject to a determination that the project is compatible with the size, location, configuration and character of the site, its relationship to the Countywide Plan Map category in which it is located, and to adjoining uses; and that the overall principles of quality urban design as set forth in *Pinellas By Design: An Economic Development and Redevelopment Plan for the Pinellas Community* are furthered.

In particular, design considerations applicable to the proposed use shall address the following in the Development Agreement so as to ensure compatibility in terms of context-sensitive design, and the scale and placement of the proposed use so as to achieve a harmonious relationship and fit relative to its location and surroundings:

- Building scale, including height, width, location, alignment, and spacing.
- Building design, including elevations, façade treatment, entrance and porch or balcony projections, window patterns and roof forms.
- Site improvements, including building and site coverage, accessory structures, service and amenity features, walkway and parking areas, open space, and view corridors.
- Adjoining property use, including density/intensity, and building location, setbacks, and height.

**Table 5-1
Alternative Temporary Lodging Density and Intensity Standards**

Plan Category	Temporary Lodging On Property That Is:	Maximum Density/Intensity Standards		
		Units/Acre	FAR	ISR
R, AC, MMC, PRD	Less Than One Acre	75	2.2	0.95
	Between One Acre And Three Acres	100	3.0	0.95
	Greater Than Three Acres	125	4.0	0.95
R&S	No Property Size Limitations	60	1.2	0.90
E	Subject To 5-Acre Property Size Limitation Per Section 2.3.3.8	75	1.5	0.85

White box: current
Colored box: proposed

EAST SIDE
 FAR: 1.0/1.2
 Temp: 60
 Res: 15

WEST SIDE
 FAR: 1.0-2.0
 Temp: 45-75
 Res: 18

FAR: N/A
 Temp: N/A
 Res: 15

FAR: 1.5/2.0*
 Temp: 40/60*
 Res: 18

FAR: 1.2
 Temp: 60
 Res: 15

FAR: 2.0
 Temp: 45
 Res: 15

FAR: 1.2
 Temp: 60
 Res: 15

FAR: 2.0/2.2-3.0*
 Temp: 60/75-100*
 Res: 15

FAR: 1.2
 Temp: 60
 Res: 15

FAR: 1.5
 Temp: 0
 Res: 0

FAR: 2.0/2.2-2.5*
 Temp: 60/75-100*
 Res: 18

FAR: 1.0-2.0
 Temp: 45-75
 Res: 18

Legend

- Madeira Beach Roads
- ▬▬▬ Coastal Construction Control Line

John's Pass Village Activity Center Character Districts

- Boardwalk
- Commercial Core
- John's Pass Resort
- Low Intensity Mixed Use
- Tradional Village
- Transitional

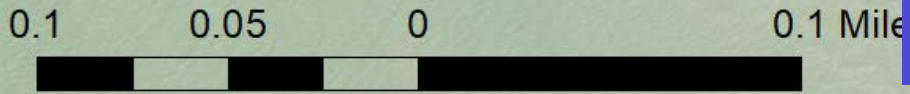

Average Lot Size

**TABLE 3.4
AVERAGE LOT SIZES IN EACH CHARACTER DISTRICT**

Character District	Average Lot Size (Square Feet)	Average Lot Size (Acres)
Boardwalk	6,419.2	0.15
Commercial Core	7,964.9	0.18
John's Pass Resort	17,542.2	0.40
Low Int. Mixed Use	7,478.4	0.17
Traditional Village	8,822.0	0.20
Transitional	12,401.8	0.28
John's Pass Activity Center	11,720.5	0.27

The average lot size of approximately one-quarter acre, which varies somewhat by Character District, is relatively small and reflects the original platting of this area. Lot size is relevant to both the types of use that can be accommodated and the resultant density/intensity that can be achieved.

John's Pass Village Activity Center Character District Proposed Densities and Intensities

John's Pass Activity Center Character Districts	Residential Units Per Acre (UPA)	Temporary Lodging Units Per Acre (UPA)*	FAR by District*	Avg Lot Size	Maximum Temp Lodging Density of avg lot size with DA*
Boardwalk	0	0	1.5	0.15	0
Commercial Core	15	60/75-100*	2.0/2.2-3.0*	0.18	13-18*
John's Pass Resort	18	60/75-100*	2.0/2.2-2.5*	0.40	30-40*
Low Intensity Mixed Use	18	40/60*	1.5/2.0*	0.17	10*
Traditional Village	15	45	2.0	0.20	9
Transitional	18	50/75*	1.5/2.0*	0.28	21*

*Allows for higher densities and intensities only if accompanied by an approved Development Agreement

IMPLEMENTATION STRATEGIES

Plan Adoption and Implementation Steps

01

Amend City's Comprehensive Plan to create Activity Center category Ordinance 2023-15

02

Initial City action to adopt Activity Center Plan Ordinance 2023-01
Initial City action to amend Future Land Use map Ordinance 2023-02

03

Amend Countywide Plan to establish Activity Center on the Countywide Plan Map and the Land Use Strategy Map (PAC/PPC/CPA)

04

Final City action to adopt Activity Center Plan Ordinance 2023-01
Final City action to amend Future Land Use map Ordinance 2023-02

05

Amend City's Land Development Code to establish Activity Center zoning districts
Administer and implement the Activity Center Plan