

**CODE SUMMARY**

**SITE**

ADDRESS: 7547 7TH STREET  
MACKINAC ISLAND, MI 49757

PARCEL NUMBER: 051-630-043-00

ZONING: R-4 HARRISONVILLE RESIDENTIAL  
OVERLAY: N/A

**BUILDING SETBACKS:**

FRONT: 25 FT MIN  
SIDE: 5 FT MIN / 10 FT MIN OTHER  
REAR: 25 FT MIN

SITE AREA: 12,590 SF

BUILDING COVERAGE: 16%

**BUILDING & AREA SUMMARY**

**(E) COTTAGE AREA**

1ST FLOOR: ±870 SF  
UNFINISHED BASEMENT: ±850 SF  
TOTAL: 1720 SF

**(E) APARTMENT AREA**

1ST FLOOR: ±764 SF  
2ND FLOOR: ±780 SF  
LOFT: ±140 SF OCCUPIABLE  
UNFINISHED GARAGE: ±153 SF  
TOTAL: 1837 SF

(E) IMPERVIOUS AREA: ± 2000 SF (17% SITE AREA, 40% MAX)  
NO CHANGE PROPOSED

CONSTRUCTION TYPE: VB

FIRE PROTECTION SYSTEM: NONE EXISTING  
NFA 13-R FOR FLOW PROPOSED  
NFA 13 FOR COVERAGE IN ATTIC

STORIES: 1 BELOW GRADE PLANE, 1 ABOVE GRADE PLANE  
2 ABOVE GRADE PLANE + MEZZANINE LOFT (2.5)

HEIGHT: 35 FT MAX / 2 1/2 STORIES MAX  
PROPOSED HEIGHT PER A3.1

NO PROPOSED CHANGES TO SITE  
DRAINAGE, UTILITY SERVICES, OR  
WASTE STORAGE & DISPOSAL

PROPOSED 3' - 0" WIDE  
LANDSCAPE BUFFER W/  
(E) 6' - 7" TALL FENCE

LANDSCAPE BUFFER  
PER SECTION 4.09

(E) TWO-STORY  
STRUCTURE IS IN BUFFER  
ZONE

ADJACENT HOME

INCLUDE BUFFER W/  
PROPOSED PLANTING &  
(E) FENCE

ACCESS FOR ADJACENT HOME

**CADOTTE AVENUE**

File No. R424-043-011

Exhibit C

Date 2-27-24

Initials KP

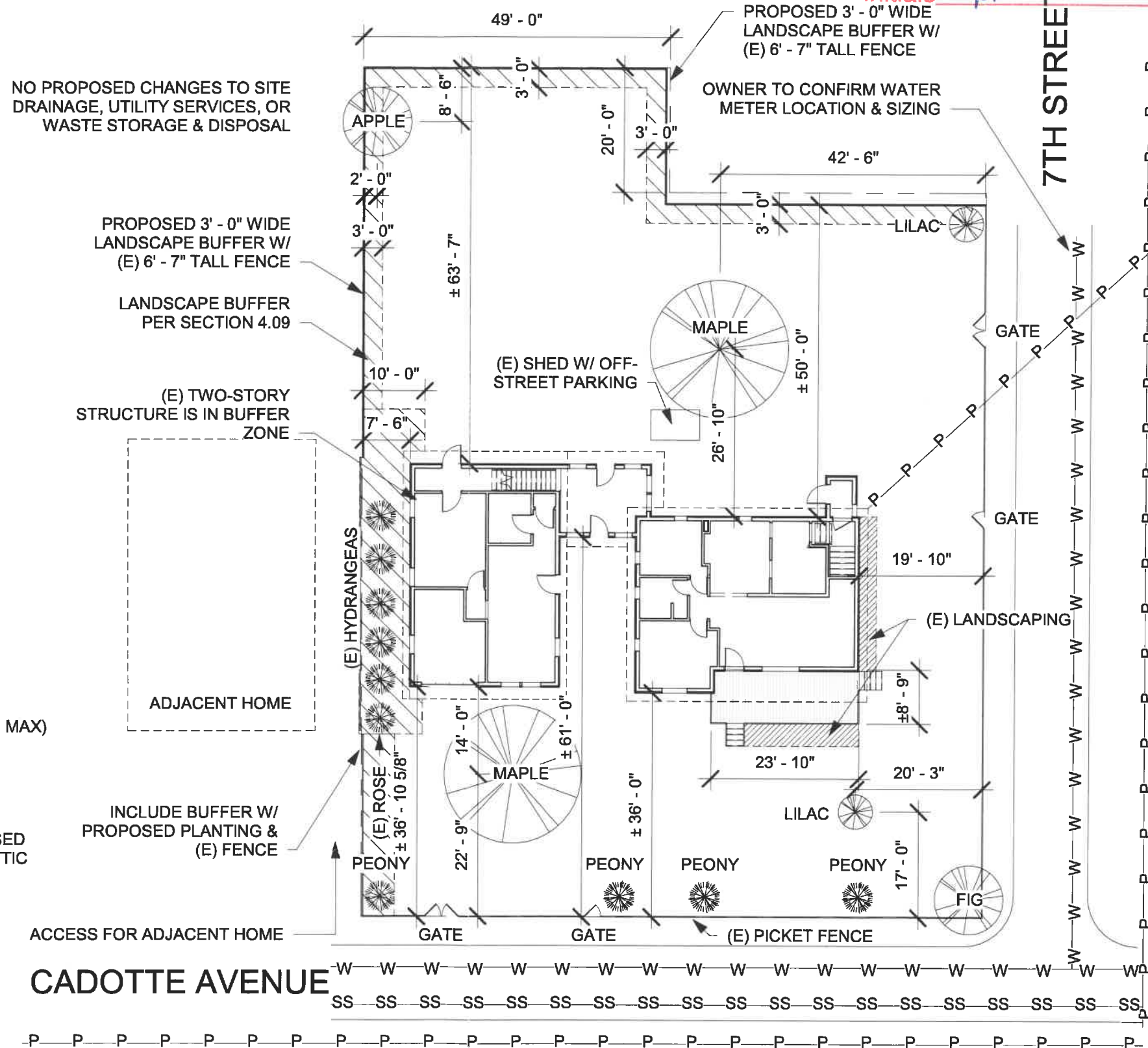

1 SITE PLAN PROPOSED  
1" = 20'-0"

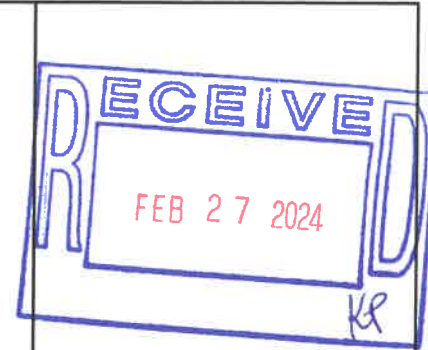

**NOT FOR CONSTRUCTION**



Kaleido Studio Architecture  
1661 SE 3rd Ave, # C201  
Portland, OR 97214  
www.kaleidopnw.com  
B-Corp Certified

**MACKINAC ISLAND HOMES**

7547 7TH ST & 2827 CADOTTE AVE APT 101, 201  
MACKINAC ISLAND, MI 49757

02/23/24

A0.6

**OWNERS**  
 GFAK LLC  
 5114 WELSHEIMER ROAD  
 HARBOR SPRINGS, MI 49740  
 june.hetman@gmail.com

**ARCHITECT**  
 KALEIDO STUDIO ARCHITECTURE, LLC  
 1661 SE 3RD AVE, SUITE D #201  
 PORTLAND, OR 97214  
 OFFICE: 503.224.1282  
 COREY OMEY, PROJECT ARCHITECT  
 comey@EMAarchitecture.com  
 SCOTT DUFRECHE, PROJECT MANAGER  
 sdufreche@EMAarchitecture.com

**CONTRACTOR**  
 TBD

**STRUCTURAL ENGINEER**  
 TBD

**MEP**  
 BIDDER DESIGN

**ATTACHMENTS:**

- N/A

**BIDDER DESIGN BY SEPARATE TRADE PERMIT**

THE FOLLOWING WILL BE DESIGN BUILD BY DESIGN/BUILD CONTRACTORS TO BE SELECTED. CONTRACTOR SHALL ISSUE FOR SEPARATE PERMIT AFTER REVIEW AND APPROVAL OF DESIGN CONCEPT BY ARCHITECT AND OWNER: DESIGN BUILD CONTRACTOR IS RESPONSIBLE FOR DESIGN, DRAWINGS, AND CALCULATIONS AS REQUIRED FOR PERMIT AND CODE COMPLIANT INSTALLATION / CONSTRUCTION.

- ELECTRICAL - ELEC METER, TYP OUTLETS, SWITCHES, LIGHTING
- PLUMBING - NFPA-13 R SPRINKLER SYSTEM

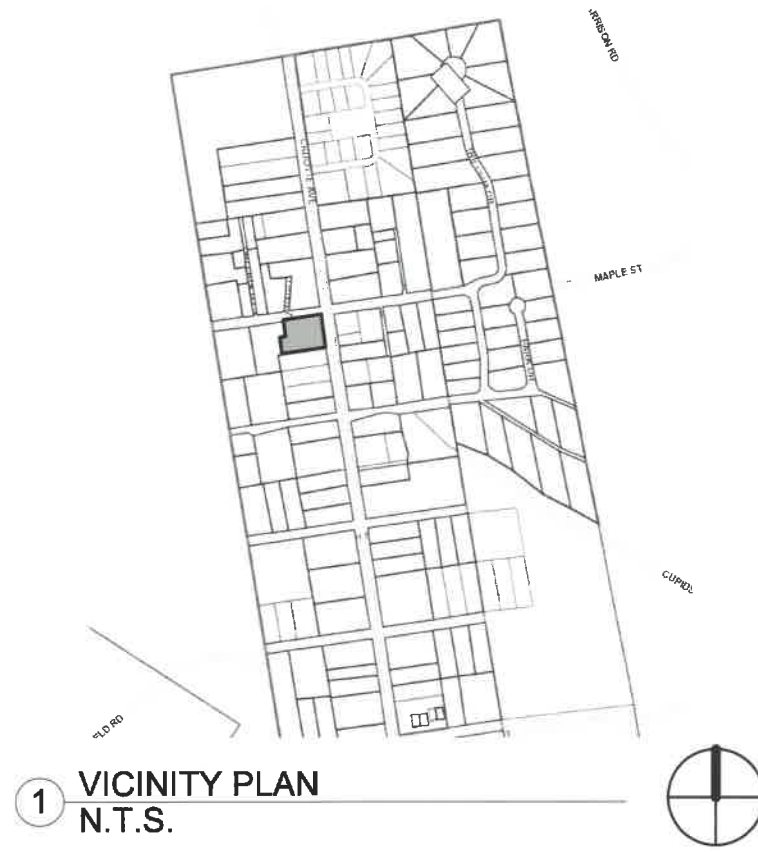

**SCOPE**

FINALIZE AND CONVERT (E) COTTAGE HOME TO CODE-COMPLIANT WORKER HOUSING.

File No. R424-043-011

Exhibit D

Date 2-27-24

Initials HP

**SHEET INDEX**

**ARCHITECTURAL**

- A0.0 COVER
- A0.1 GENERAL NOTES & ABBREVIATIONS
- A0.2 LIFE SAFETY
- A0.3 LIFE SAFETY
- A0.4 LIFE SAFETY
- A0.5 CODE SUMMARY
- A0.6 SITE PLAN
- A1.1 EXISTING FLOOR PLANS
- A1.2 EXISTING FLOOR PLANS
- A1.3 EXISTING FLOOR PLANS
- A1.4 EXISTING FLOOR PLANS
- A2.1 PROPOSED FLOOR PLANS
- A4.1 EXTERIOR ELEVATIONS
- A4.2 EXTERIOR ELEVATIONS
- A4.3 EXTERIOR ELEVATIONS
- A9.0 EXTERIOR IMAGES
- A9.1 LANDSCAPING
- A9.2 COTTAGE INTERIOR
- A9.3 NEIGHBORING PROPERTIES

**REFERENCED CODES**

- STATE 2015 MICHIGAN RESIDENTIAL CODE
- LOCAL MACKINAC ISLAND CODE OF ORDINANCES

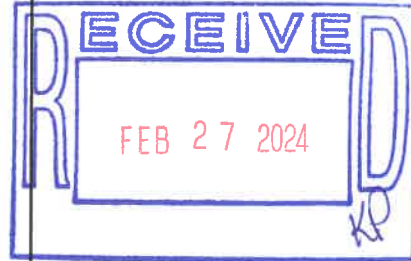

**NOT FOR CONSTRUCTION**

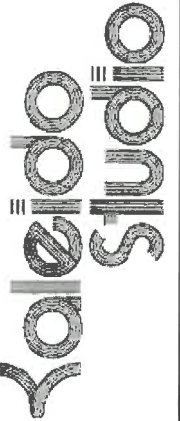

Kaleido Studio Architecture  
 1661 SE 3rd Ave. # D201  
 Portland, OR 97214  
 www.kaleidopnw.com  
 B-Corp Certified

**MACKINAC ISLAND HOMES**  
 7547 7TH ST & 2827 CADOTTE AVE APT 101, 201  
 MACKINAC ISLAND, MI 49757

02/23/24

A0.0

**GENERAL NOTES**

1. BEFORE CONSTRUCTION IS TO BEGIN, THE CONTRACTOR IS TO VERIFY THAT ALL REQUIRED APPROVALS & PERMITS HAVE BEEN OBTAINED. THE CONSTRUCTION OR FABRICATION OF ANY BUILDING COMPONENT MAY BEGIN ONLY AFTER THE CONTRACTOR HAS RECEIVED PLANS & ANY ADDITIONAL DOCUMENTS FROM THE PERMITTING & OTHER REGULATORY AGENCY. IF THE CONTRACTOR FAILS TO DO SO, THE CONTRACTOR SHALL BE RESPONSIBLE FOR ANY RESULTING MODIFICATION OF WORK REQUIRED BY ANY REGULATORY AGENCY.
2. IF DISCREPANCIES OR INCONSISTENCIES ARE FOUND WITHIN THE DOCUMENTS, THEY SHALL BE REPORTED TO THE ARCHITECT & RESOLVED BY THE ARCHITECT PRIOR TO PROCEEDING WITH WORK IN THE AFFECTED AREA.
3. IT IS THE RESPONSIBILITY OF THE CONTRACTOR TO VERIFY IN THE FIELD ALL DIMENSIONS, ELEVATIONS, & EXISTING CONDITIONS PRIOR TO PROCEEDING WITH THE WORK, ORDERING OR FABRICATION OF ANY MATERIALS. IF DISCREPANCIES ARE FOUND BETWEEN THE CONSTRUCTION DOCUMENTS & EXISTING CONDITIONS, THEY SHALL BE REPORTED TO THE ARCHITECT & RESOLVED BY THE ARCHITECT PRIOR TO PROCEEDING WITH WORK IN THE AFFECTED AREA.
4. DIMENSIONS ARE TO FACE OF STRUCTURAL OR FRAMING MEMBERS, U.N.O.
5. WHERE IT IS CLEAR THAT A DRAWING REPRESENTS ONE ITEM OF A NUMBER, OR ONLY A PART OF AN ASSEMBLY, THE OTHER WORK SHALL BE CONSTRUCTED REPETITIVELY.

**ABBREVIATIONS**

AFF	ABOVE FINISHED FLOOR	MAX	MAXIMUM
ALUM	ALUMINUM	MECH	MECHANICAL
ANOD	ANODIZED	MEMBR	MEMBRANE
BOT	BOTTOM	MIN	MINIMUM
B.O.	BOTTOM OF	NIC	NOT IN CONTRACT
CJ	CONTROL JOINT	NO	NUMBER
CLNG	CEILING	NOM	NOMINAL
CLR	CLEAR	OC	ON CENTER
COL	COLUMN	OFCI	OWNER FURNISHED, CONTRACTOR INSTALLED
CONC	CONCRETE	PL	PROPERTY LINE
DBL	DOUBLE	PLY	PLYWOOD
DIA	DIAMETER	PT	PRESSURE TREATED
DIM	DIMENSION	PTD	PAINTED
DN	DOWN	RB	RUBBER BASE
DS	DOWNSPOUT	RCP	REFLECTED CEILING PLAN
DWG	DRAWING	RD	ROOF DRAIN
EA	EACH	REQD	REQUIRED
EJ	EXPANSION JOINT	RM	ROOM
EL	ELEVATION	SIM	SIMILAR
ELEC	ELECTRICAL	SPEC	SPECIFIED OR SPECIFICATION
EP	ELECTRICAL PANEL	SS	STAINLESS STEEL
EQ	EQUAL	STL	STEEL
EXIST OR (E)	EXISTING	STRUCT	STRUCTURE OR STRUCTURAL
EXT	EXTERIOR	T&G	TONGUE AND GROOVE
FD	FLOOR DRAIN	T.O.	TOP OF
FIXT	FIXTURE	TOC	TOP OF CONCRETE
FLR	FLOOR	TOS	TOP OF STEEL
FO	FACE OF	TYP	TYPICAL
FDN	FOUNDATION	UNO	UNLESS NOTED OTHERWISE
GA	GAUGE	VIF	VERIFY IN FIELD
GALV	GALVANIZED	W/	WITH
GWB/GYP BD	GYPSUM WALL BOARD	WD	WOOD
HB	HOSE BIB		
INSUL	INSULATION		
INT	INTERIOR		

**NOT FOR CONSTRUCTION**

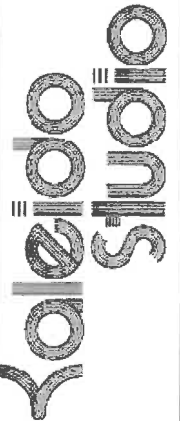

Kaleido Studio Architecture  
1661 SE 3rd Ave, # D201  
Portland, OR 97214  
www.kaleidopriv.com  
B-Corp Certified

**MACKINAC ISLAND HOMES**

7547 7TH ST & 2827 CADOTTE AVE APT 101, 201  
MACKINAC ISLAND, MI 49757

02/23/24

**A0.1**

## MACKINAC ISLAND CODES

### SEC. 10-112. - REQUIRED EQUIPMENT AND FACILITIES.

(A) WATER CLOSET; LAVATORY BASIN; BATHTUB OR SHOWER. AT LEAST ONE FLUSH WATER CLOSET, LAVATORY BASIN AND BATHTUB OR SHOWER, PROPERLY CONNECTED TO A WATER AND SEWER SYSTEM APPROVED BY THE HEALTH OFFICER AND IN GOOD WORKING CONDITION, SHALL BE SUPPLIED FOR EACH EIGHT PERSONS OR FRACTION THEREOF RESIDING WITHIN A ROOMINGHOUSE, INCLUDING MEMBERS OF THE OPERATOR'S FAMILY WHENEVER THEY SHARE THE USE OF SUCH FACILITIES, PROVIDED:

- (1) IN A ROOMINGHOUSE WHERE ROOMS ARE LET ONLY TO MALES, FLUSH URINALS MAY BE SUBSTITUTED FOR NOT MORE THAN HALF THE REQUIRED NUMBER OF WATER CLOSETS AND PROVIDED THAT THERE SHALL BE AT LEAST ONE WATER CLOSET.
- (2) ALL SUCH FACILITIES SHALL BE SO LOCATED WITHIN THE DWELLING AS TO BE REASONABLY ACCESSIBLE TO ALL PERSONS SHARING SUCH FACILITIES AND FROM A COMMON HALL OR PASSAGEWAY AND PROVIDED THAT SUCH FACILITIES ARE NOT LOCATED MORE THAN ONE FLOOR ABOVE OR BELOW THE ROOMING UNIT OR UNITS SERVED.
- (3) EVERY LAVATORY BASIN AND BATHTUB OR SHOWER STALL BE SUPPLIED WITH HEATED AND UNHEATED WATER UNDER PRESSURE AT ALL TIMES.
- (4) IF THE ROOMINGHOUSE HAS ONLY ONE BATHROOM FOR USE BY THE OCCUPANTS OF THE ROOMING UNITS, SUCH BATHROOM SHALL NOT BE LOCATED BELOW GRADE.
- (5) EVERY WATER CLOSET MUST BE LOCATED IN A ROOM, OR STALL IN A ROOM, THAT AFFORDS PRIVACY, AND EVERY BATHING FACILITY MUST BE LOCATED IN A ROOM THAT AFFORDS PRIVACY.

(B) HEATING FACILITIES. EVERY DWELLING USED DURING THE WINTER SHALL HAVE HEATING FACILITIES WHICH ARE PROPERLY INSTALLED AND MAINTAINED IN A SAFE AND GOOD WORKING CONDITION AND CAPABLE OF HEATING ALL HABITABLE ROOMS WITHIN THE DWELLING, UNDER ORDINARY WINTER CONDITIONS, TO AT LEAST 70 DEGREES FAHRENHEIT.

(C) WINDOWS. EVERY HABITABLE ROOM OF A DWELLING SHALL HAVE ONE OR MORE WINDOWS WITH A MINIMUM GLASS AREA EQUAL TO AT LEAST TEN PERCENT OF THE FLOOR AREA OF THE ROOM, WITH 45 PERCENT OF THAT MINIMUM GLASS AREA CAPABLE OF BEING OPENED. THE WINDOWS SHALL FACE DIRECTLY TO THE OUTDOORS.

(D) MEANS OF EGRESS. EVERY DWELLING UNIT SHALL HAVE TWO SAFE, UNOBSTRUCTED MEANS OF EGRESS LEADING TO A SAFE AND OPEN SPACE AT GROUND LEVEL.

### SEC. 10-113. - MAINTENANCE.

(A) FOUNDATION, WALLS, ROOF, ETC.; SCREENS. EVERY FOUNDATION, FLOOR, WALL, WINDOW, CEILING AND ROOF OF A DWELLING SHALL BE REASONABLY WATERTIGHT, WEATHERTIGHT AND VERMINPROOF; SHALL BE CAPABLE OF AFFORDING PRIVACY; AND SHALL BE KEPT IN GOOD REPAIR. SCREENS SHALL BE PROVIDED AND KEPT IN GOOD REPAIR, FROM APRIL 1 TO NOVEMBER 1, ON ALL OPENABLE DOORS AND WINDOWS.

(B) PLUMBING FIXTURES; PIPES. EVERY PLUMBING FIXTURE OF A DWELLING, AND WATER AND WASTE PIPE, SHALL BE PROPERLY INSTALLED AND MAINTAINED IN GOOD SANITARY WORKING CONDITION, FREE FROM DEFECTS, LEAKS AND OBSTRUCTION.

(C) MAINTAIN IN SATISFACTORY WORKING CONDITION. EVERY SUPPLIED FACILITY, PIECE OF EQUIPMENT OR UTILITY OF A DWELLING SHALL BE SO CONSTRUCTED AND INSTALLED THAT IT WILL FUNCTION SAFELY AND EFFECTIVELY AND SHALL BE MAINTAINED IN A SATISFACTORY WORKING CONDITION.

(D) FITNESS FOR HUMAN OCCUPANCY. NO PERSON SHALL OCCUPY OR LET TO ANY OTHER OCCUPANT ANY DWELLING UNIT UNLESS IT IS CLEAN, SANITARY AND FIT FOR HUMAN OCCUPANCY.

(E) SUBSTANDARD DWELLINGS PROHIBITED. NO ROOMINGHOUSE AND/OR BOARDINGHOUSE SHALL BE A SUBSTANDARD DWELLING, AND NO ROOMINGHOUSE AND/OR BOARDINGHOUSE SHALL BE PERMITTED TO CONTINUE IN BUSINESS WITH CONDITIONS PRESENT, AS DEFINED UNDER SECTION 10-71.

(ORD. NO. 224, ART. VI, § 6, ART. VII, §§ 1—4, 6-2-1976)

### SEC. 10-114. - SPACE, USE AND LOCATION.

(A) FLOOR SPACE; CEILING HEIGHT; NUMBER OF OCCUPANTS. EVERY ROOMING UNIT SHALL COMPLY WITH ALL THE REQUIREMENTS OF THE FOLLOWING PERTAINING TO A HABITABLE ROOM:

- (1) EVERY ROOMING UNIT OCCUPIED BY ONE PERSON SHALL CONTAIN AT LEAST 85 SQUARE FEET OF FLOOR SPACE; EVERY ROOMING UNIT OCCUPIED BY TWO TO FOUR PERSONS SHALL CONTAIN AT LEAST 50 SQUARE FEET OF FLOOR SPACE PER OCCUPANT; AND EVERY ROOM UNIT OCCUPIED BY FIVE OR SIX PERSONS SHALL CONTAIN AT LEAST 70 SQUARE FEET PER OCCUPANT. NO ROOMING UNIT SHALL CONTAIN MORE THAN SIX PERSONS.
- (2) AT LEAST HALF OF EVERY HABITABLE ROOM SHALL HAVE A CEILING HEIGHT OF AT LEAST SEVEN FEET. NO FLOOR SPACE IN A HABITABLE ROOM THAT DOES NOT HAVE AT LEAST FIVE FEET CLEAR FLOOR-TO-CEILING HEIGHT MAY BE UTILIZED IN DETERMINING MINIMUM FLOOR SPACE.

(B) CELLAR OR BASEMENT SPACE. NO CELLAR OR BASEMENT SPACE LOCATED PARTIALLY OR WHOLLY UNDER GROUND AND HAVING HALF OR MORE THAN HALF OF ITS CLEAR FLOOR-TO-CEILING HEIGHT BELOW THE AVERAGE GRADE OF ADJOINING GROUND SHALL BE USED AS A DWELLING UNIT UNLESS:

- (1) THE FLOORS AND WALLS ARE IMPERVIOUS TO LEAKAGE OF UNDERGROUND AND SURFACE RUNOFF WATER, AND ARE INSULATED AGAINST DAMPNESS.
- (2) THE TOTAL WINDOW AREA IN EACH ROOM IS EQUAL TO TEN PERCENT OF THE FLOOR AREA OF SUCH ROOM, WITH 45 PERCENT OF THE MINIMUM GLASS AREA CAPABLE OF BEING OPENED. SUCH WINDOW AREA SHALL BE ENTIRELY ABOVE THE ADJOINING GRADE.

NOT FOR CONSTRUCTION

Kaleido  
Studio

Kaleido Studio Architecture  
1661 SE 3rd Ave. # D201  
Portland, OR 97214  
www.kaleidopriv.com

B-Corp Certified

MACKINAC ISLAND HOMES

7547 7TH ST & 2827 CADOTTE AVE APT 101, 201  
MACKINAC ISLAND, MI 49757

02/23/24

A0.2



# MACKINAC ISLAND CODES

## ARTICLE IV. - RENTAL HOUSING

### SEC. 10-131. - PURPOSE.

THE PURPOSE OF THIS ARTICLE IS TO PROVIDE INSPECTION, REGULATION AND LICENSING OF RENTAL HOUSING ACCOMMODATIONS ON MACKINAC ISLAND, INTENDING TO BENEFIT THE OCCUPANTS THEREOF THROUGH BETTER ENFORCEMENT OF BUILDING AND LIFE SAFETY CODE REQUIREMENTS AND BY REGULATION OF THE ACTIVITIES THAT OCCUR WITHIN SUCH HOUSING ACCOMMODATIONS.

### SEC. 10-132. - SCOPE.

BRIEF VISUAL INSPECTION OF EACH RENTAL PREMISE WITH THE PRIMARY PURPOSE OF THE INSPECTION BEING THE IDENTIFICATION AND/OR CORRECTION OF VISIBLE CONDITIONS THAT VIOLATE APPLICABLE CITY ORDINANCES AND PRESENT A DANGER TO THE HEALTH, SAFETY AND WELFARE OF THE OCCUPANTS OF THE PREMISES AND THE COMMUNITY IN GENERAL.

### SEC. 10-134. - LICENSING.

(A) NO OWNER, OR OWNER'S AGENT, SHALL ALLOW ANOTHER PERSON TO OCCUPY A RENTAL UNIT WITHOUT A LICENSE TO DO SO PURSUANT TO THIS ARTICLE.

(B) ALL RENTAL UNIT LICENSES SHALL EXPIRE ON MAY 1ST OF THE CALENDAR YEAR FOLLOWING ISSUANCE OF THE LICENSE.

(C) ANY OWNER DESIRING TO UTILIZE OR OPERATE A RENTAL UNIT SHALL FILE AN APPLICATION FOR A LICENSE WITH THE CITY CLERK BY WAY OF A WRITTEN APPLICATION ON A FORM APPROVED BY THE CITY COUNCIL AND ANY SAID APPLICATION SHALL BE APPROVED IF ALL OF THE FOLLOWING APPLY:

(1) THE INSPECTOR(S) HAVE COMPLETED THE INSPECTION CHECKLIST ADOPTED BY THE CITY COUNCIL WITH A DETERMINATION THAT THE CONDITIONS COVERED BY THE CHECKLIST ARE SATISFACTORY.

(2) THE OWNER'S PREVIOUS LICENSE IS NOT IN A PERIOD OF REVOCATION PURSUANT TO SECTION 10-136.

(3) OWNER HAS PAID THE APPROPRIATE LICENSE FEE FOR EACH RENTAL UNIT.

(4) THE NAME, ADDRESS AND TELEPHONE NUMBER OF A LOCAL DESIGNATED AGENT WHO SHALL RESIDE WITHIN THE CITY OF MACKINAC ISLAND ON A YEAR ROUND BASIS.

(5) THE APPROPRIATE CITY OFFICIAL(S) HAS INSPECTED THE PREMISES AND DETERMINED THAT ALL ORDINANCES, LAWS, AND BUILDING AND LIFE SAFETY CODE REQUIREMENTS APPEAR TO BE IN COMPLIANCE. THE CITY OFFICIAL SHALL CONSIST OF THE POLICE CHIEF, THE FIRE CHIEF AND THE BUILDING INSPECTOR, OR THEIR DESIGNEES, OR ANY COMBINATION THEREOF. SAID DETERMINATION WILL GENERALLY BE MADE UPON INSPECTION OF EACH RENTAL UNIT, BUT IF THE INSPECTION CANNOT OCCUR WITHIN A REASONABLE TIME DUE TO THE ANTICIPATED SEASONAL INFLUX OF APPLICATIONS, THE CITY COUNCIL MAY ISSUE THE LICENSE BASED ON WRITTEN REPRESENTATION BY THE OWNER THAT THE UNIT IS IN COMPLIANCE WITH ALL BUILDING AND LIFE SAFETY CODE REQUIREMENTS AND THAT SAID REPRESENTATION BE BASED ON CREDIBLE INFORMATION. IN SUCH CASES, THE INSPECTION WILL BE SCHEDULED AND COMPLETED AS SOON AS POSSIBLE WITH PRIOR NOTICE GIVEN TO THE OWNER OF NOT LESS THAN 48 HOURS THAT THE CITY INSPECTION WILL TAKE PLACE. IF THE CITY INSPECTION REVEALS CODE VIOLATIONS OF A NATURE THAT THE INSPECTOR BELIEVES COULD BE LIFE THREATENING, THE LICENSE SHALL BE IMMEDIATELY REVOKED, CONSISTENT WITH THE PROCEDURE SET FORTH IN SECTION 10-136 HEREOF. IF THE VIOLATIONS ARE NOT OF A LIFE THREATENING NATURE, THE LICENSEE SHALL BE GIVEN A REASONABLE TIME PERIOD IN WHICH TO CORRECT THE DEFECTS BEFORE REVOCATION WOULD OCCUR.

(6) THE OWNER HAS PROVIDED A COPY OF A FLOOR PLAN ON 8½ × 11 SIZE PAPER DEPICTING ALL RELEVANT INFORMATION FOR EMERGENCY EVACUATION, INCLUDING BUT NOT LIMITED TO, ROOMS, STAIRWAYS AND PATH OF EGRESS, WHICH WILL BE DISPLAYED IN EVERY SLEEPING ROOM.

(D) ANY LICENSE ISSUED PURSUANT TO THIS ARTICLE SHALL BE NONTRANSFERABLE AND SHALL EXPIRE UPON ANY TRANSFER OF OWNERSHIP.

(E) THE RENTAL UNIT SHALL BE CONSIDERED TO INCLUDE ALL UNITS LOCATED ON A CONTIGUOUS PARCEL OF LAND UNDER COMMON OWNERSHIP AND CONTROL.

### SEC. 10-135. - RULES OF OPERATION.

A LICENSEE SHALL OPERATE THE LICENSED RENTAL UNIT IN ACCORDANCE WITH THE FOLLOWING RULES:

(1) NOISE FROM THE LICENSED PROPERTY SHALL BE HELD TO A MINIMUM SUCH THAT NOISE EMANATING FROM CONGREGATIONS OF PEOPLE, MUSIC, FIREWORKS AND OTHER SOURCES MUST BE IN KEEPING WITH RESIDENTIAL NEIGHBORHOODS.

(2) THE LICENSED PREMISES MUST BE MAINTAINED FREE FROM LITTER AND DEBRIS.

(3) THAT THE PREMISES BE UTILIZED ONLY IN COMPLIANCE WITH THE REPRESENTATIONS MADE BY THE OWNER ON THE APPLICATION FOR LICENSE, INCLUDING BUT NOT LIMITED TO THE AREAS OF THE UNIT TO BE OCCUPIED AND THE NUMBER OF OCCUPANTS UTILIZING THE UNIT.

(4) THAT THE PREMISES BE UTILIZED AND MAINTAINED IN COMPLIANCE WITH ALL LOCAL ORDINANCES, STATE AND FEDERAL LAWS, SPECIFICALLY THE NFPA LIFE SAFETY CODE.

(5) EACH LICENSED PREMISES SHALL POST A MAP SHOWING ALL EXIT ROUTES FROM THE BUILDING ON THE INSIDE OF THE DOOR OF EACH SLEEPING ROOM.

### SEC. 10-136. - PENALTY.

IN THE EVENT A LICENSEE OPERATES A RENTAL UNIT WITHOUT A LICENSE, THE OWNER SHALL BE RESPONSIBLE FOR A CIVIL INFRACTION AND UPON FINDING OF RESPONSIBILITY BY A COURT OF COMPETENT JURISDICTION, THE VIOLATION SHALL BE PUNISHABLE BY A FINE OF NOT MORE THAN \$500.00 FOR EACH OFFENSE PLUS THE COSTS OF ACTION, INCLUDING ALL DIRECT AND INDIRECT EXPENSES INCURRED BY THE CITY IN THE ADMINISTRATION OF SAID ACTION. EACH DAY OF OPERATION WITHOUT A LICENSE SHALL BE CONSIDERED A SEPARATE OFFENSE.

NOT FOR CONSTRUCTION

Kaleido Studio

Kaleido Studio Architecture  
1661 SE 3rd Ave. # D201  
Portland, OR 97214  
www.kaleidopnw.com

B-Corp Certified

MACKINAC ISLAND HOMES

7547 7TH ST & 2827 CADOTTE AVE APT 101, 201  
MACKINAC ISLAND, MI 49757

02/23/24

A0.3

# MACKINAC ISLAND CODES

## ARTICLE 7A. - "R-4" HARRISONVILLE RESIDENTIAL

### SECTION 7A.02 - PERMITTED USES R-4.

SINGLE-FAMILY AND TWO-FAMILY RESIDENTIAL DWELLINGS AND ACCESSORY BUILDINGS ARE PERMITTED IN THIS DISTRICT.

### SECTION 7A.03 - SPECIAL LAND USES.

THE FOLLOWING USES ARE PERMITTED BY SPECIAL LAND USE APPROVAL OF THE PLANNING COMMISSION, PROVIDED THAT THEY ARE IN COMPLIANCE WITH THE STANDARDS THAT FOLLOW AND THE PROCEDURES AND STANDARDS IN ARTICLE 19:

#### A.MULTIPLE-FAMILY RESIDENTIAL, PROVIDED:

- 1.THAT A LANDSCAPE BUFFER IS PROVIDED ALONG ALL PROPERTY BOUNDARIES, WHICH ABUT SINGLE-FAMILY OR TWO-FAMILY RESIDENTIAL USES, IN ACCORDANCE WITH THE REQUIREMENTS OF SECTION 4.09.
- 2.THAT THE MULTIPLE-FAMILY USE AND/OR STRUCTURE COMPLIES WITH ALL OTHER DISTRICT REGULATIONS.

#### B.BOARDINGHOUSE, PROVIDED:

- 1.THAT A LANDSCAPE BUFFER IS PROVIDED ALONG ALL PROPERTY BOUNDARIES, WHICH ABUT RESIDENTIAL USES, IN ACCORDANCE WITH THE REQUIREMENTS OF SECTION 4.09.
- 2.THAT OFF-STREET BICYCLE PARKING BE PROVIDED FOR EACH TENANT OR GUEST RESIDING AT OR VISITING THE BOARDINGHOUSE DURING THE TOURIST SEASON (MEMORIAL DAY THROUGH LABOR DAY).
- 3.THAT THE BOARDINGHOUSE USE AND/OR STRUCTURE COMPLIES WITH ALL OTHER DISTRICT REGULATIONS.

### SECTION 7A.04 - AREA, BULK, HEIGHT, LOT COVERAGE, AND DENSITY REQUIREMENTS.

A.LOT SIZE. 10,000 SF MIN

B.BUILDINGS, AND STRUCTURES SHALL BE SETBACK FROM PROPERTY LINES AS FOLLOWS:

- 1.FRONT YARD. 25' - 0" MIN OR IN LINE W/ ADJACENT
- 2.SIDE YARD. 5'-0" MIN ONE SIDE, 10'-0" MIN OTHER
- 3.REAR YARD. 25' - 0" MIN

C.NO PRINCIPAL BUILDING SHALL BE LESS THAN 12 FEET IN HEIGHT, NOR SHALL ANY BUILDING EXCEED 35 FEET, OR 2½ STORIES, IN HEIGHT.

D. 40% MAX IMPERVIOUS SURFACE

E.MAX 10 DWELLING UNITS PER ACRE.

FOR USE AS A BOARDINGHOUSE, THE MAXIMUM ALLOWABLE DENSITY SHALL BE ONE OCCUPANT PER 500 SQUARE FEET OF LOT AREA WITHIN WHICH THE BUILDING IS PLACED. (12,590 / 500 SF PER OCC = ±25 OCC)

AN OCCUPANT IS A PERSON WHO OCCUPIES A BED OR SLEEPING AREA WITHIN THE BUILDING FOR ONE OR MORE OVERNIGHT PERIODS. IN THE EVENT THE BUILDING CONTAINS BOTH FAMILY RESIDENTIAL USE AND BOARDINGHOUSE USE (NONFAMILY RESIDENTIAL USE), THE ONE OCCUPANT PER 500 SQUARE FEET OF LOT AREA DENSITY LIMITATION SHALL APPLY TO THE ENTIRE BUILDING.

### SECTION 4.09 - LANDSCAPE BUFFERS.

UPON ANY IMPROVEMENT FOR WHICH A SITE PLAN IS REQUIRED, A LANDSCAPE BUFFER SHALL BE CONSTRUCTED ALONG ALL ADJOINING BOUNDARIES BETWEEN A PROPERTY ZONED C OR HB DISTRICT AND ANY PROPERTY ZONED R-1, R-3, R-4 OR CD DISTRICT. A LANDSCAPE BUFFER MAY ALSO BE REQUIRED AS A CONDITION OF APPROVAL FOR SITE PLANS, SPECIAL LAND USES, PLANNED UNIT DEVELOPMENTS, OR AS DIRECTLY STATED AS A REQUIREMENT OF A PARTICULAR ZONING DISTRICT. THE FOLLOWING REQUIREMENTS SHALL APPLY:

A.LANDSCAPE BUFFERS SHALL HAVE A MINIMUM WIDTH OF TEN FEET AND SHALL BE PLANTED WITH GRASS, GROUND COVER, SHRUBBERY, OR OTHER SUITABLE PLANT MATERIAL. THE LOCATION, PLACEMENT, SPACING AND TYPES OF PLANT MATERIALS WILL BE SUCH THAT AN EFFICIENT HORIZONTAL AND VERTICAL OBSCURING OR SCREENING EFFECT BETWEEN LAND USES WILL BE ACHIEVED.

B.ALL PLANTS COMPRISING THE BUFFER WILL BE CONTINUOUSLY MAINTAINED IN A SOUND, HEALTHY, VIGOROUS GROWING CONDITION, FREE OF DISEASES, INSECT PESTS, REFUSE AND DEBRIS.

C.MINIMUM SIZES OF TREES AND SHRUBS PLANTED AS A PART OF A LANDSCAPE BUFFER ARE AS FOLLOWS:

- 1.DECIDUOUS SHRUBS. MINIMUM TWO FEET IN HEIGHT.
- 2.DECIDUOUS TREES. MINIMUM TWO INCHES IN CALIPER (DIAMETER).
- 3.EVERGREEN SHRUBS. MINIMUM TWO FEET IN HEIGHT.
- 4.EVERGREEN TREES. MINIMUM FIVE FEET IN HEIGHT.

D.THE CHOICE AND SELECTION OF PLANT MATERIALS WILL BE SUCH THAT THE ROOT SYSTEM WILL NOT INTERFERE WITH PUBLIC UTILITIES AND THAT FRUIT AND OTHER PLANT DEBRIS (EXCEPT LEAVES) WILL NOT CONSTITUTE A NUISANCE WITHIN PUBLIC RIGHTS-OF-WAY, OR TO ABUTTING PROPERTY OWNERS.

E.ALL PLANT MATERIALS MUST MEET CURRENT RECOMMENDED MINIMUM STANDARDS OF THE AMERICAN ASSOCIATION OF NURSERYMEN.

F.LANDSCAPE BUFFERS SHALL BE IN PLACE AT THE DATE OF OCCUPANCY APPROVAL, AS PROVIDED IN SECTION 21.06, UNLESS AN EXTENSION OF UP TO SIX MONTHS IS GRANTED BY THE PLANNING COMMISSION AND A PERFORMANCE GUARANTEE IS DEPOSITED TO ENSURE COMPLETION OF THE IMPROVEMENTS IN ACCORDANCE WITH SECTION 4.18.

G.BERMS (EARTHEN MOUNDS) AND/OR CERTAIN TYPES OF FENCES MAY BE INSTALLED IN LIEU OF A LANDSCAPE BUFFER FOR THE PURPOSES OF SCREENING WHEN THE PLANNING COMMISSION DETERMINES, BASED UPON A PARTICULAR SITUATION, THAT A FENCE AND/OR BERM WOULD EFFECTIVELY ACHIEVE THE PUBLIC PURPOSES AND PRIVATE BENEFITS INHERENT IN THIS PROVISION. FENCES INSTALLED IN LIEU OF OR IN CONJUNCTION WITH A LANDSCAPE BUFFER WILL BE CONSTRUCTED OF WOOD, STONE OR BRICK TO PROVIDE AN EFFECTIVE SCREEN AND TO MAINTAIN THE NATURAL AND HISTORIC CHARACTER OF THE ISLAND. CHAIN LINK OR OTHER WIRE MESH TYPE FENCES MAY BE PERMITTED ONLY IF COVERED WITH WOOD STRIPS OR PLANT MATERIALS.

NOT FOR CONSTRUCTION

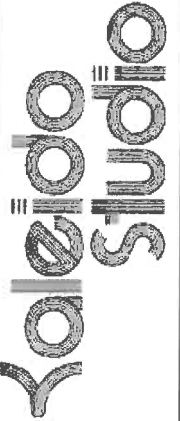

Kaleido Studio Architecture  
1661 SE 3rd Ave. # D201  
Portland, OR 97214  
www.kaleidopnw.com

B-Corp Certified

MACKINAC ISLAND HOMES

7547 7TH ST & 2827 CADOTTE AVE APT 101, 201  
MACKINAC ISLAND, MI 49757

02/23/24

A0.4

**MACKINAC ISLAND CODE RESPONSES**

**ARTICLE 7A. - "R-4" HARRISONVILLE RESIDENTIAL**

**SECTION 7A.02 - PERMITTED USES R-4.**

SINGLE-FAMILY AND TWO-FAMILY RESIDENTIAL DWELLINGS ALLOWED OUTRIGHT.

**SECTION 7A.03 - SPECIAL LAND USES.**

A.MULTIPLE-FAMILY RESIDENTIAL, PROVIDED:

- 1.LANDSCAPE BUFFERS PROVIDED PER A0.6
- 2.MULTIPLE-FAMILY STRUCTURE COMPLIES WITH ALL OTHER DISTRICT REGULATIONS.

B.BOARDINGHOUSE, PROVIDED:

- 1.LANDSCAPING BUFFERS PROVIDED PER A0.6
- 2.OFF-STREET BIKE PARKING PROVIDED PER A0.3
- 3.BOARDING HOUSE COMPLIES WITH ALL OTHER DISTRICT REGULATIONS

**SECTION 7A.04 - AREA, BULK, HEIGHT, LOT COVERAGE, AND DENSITY REQUIREMENTS.**

A.LOT SIZE. 10,000 SF MIN

**12,950 SF EXISTING**

B.BUILDINGS, AND STRUCTURES SHALL BE SETBACK FROM PROPERTY LINES AS FOLLOWS:

- 1.FRONT YARD. 25' - 0" MIN OR IN LINE W/ ADJACENT
- 2.SIDE YARD. 5'-0" MIN ONE SIDE, 10'-0" MIN OTHER
- 3.REAR YARD. 25' - 0" MIN

**SETBACK ADHERENCES SHOWN PER A0.6**

C.NO PRINCIPAL BUILDING SHALL BE LESS THAN 12 FEET IN HEIGHT, NOR SHALL ANY BUILDING EXCEED 35 FEET, OR 2½ STORIES, IN HEIGHT.

**BUILDING HEIGHT SHOWN PER ELEVATIONS**

D. 40% MAX IMPERVIOUS SURFACE

**IMPERVIOUS SURFACE CALCULATION SHOWN PER A0.6**

E.MAX 10 DWELLING UNITS PER ACRE.

FOR USE AS A BOARDINGHOUSE, THE MAXIMUM ALLOWABLE DENSITY SHALL BE ONE OCCUPANT PER 500 SQUARE FEET OF LOT AREA WITHIN WHICH THE BUILDING IS PLACED.

**12,590 / 500 SF PER OCC = ±25 OCC**

**DWELLING DENSITY SHOWN TO THE RIGHT**

**SECTION 4.09 - LANDSCAPE BUFFERS.**

A LANDSCAPE BUFFER SHALL BE CONSTRUCTED ALONG ALL ADJOINING BOUNDARIES BETWEEN A PROPERTY ZONED R-4. A LANDSCAPE BUFFER MAY ALSO BE REQUIRED AS A CONDITION OF APPROVAL FOR SITE PLANS, SPECIAL LAND USES, PLANNED UNIT DEVELOPMENTS, OR AS DIRECTLY STATED AS A REQUIREMENT OF A PARTICULAR ZONING DISTRICT. THE FOLLOWING REQUIREMENTS SHALL APPLY:

A.LANDSCAPE BUFFERS SHALL HAVE A MINIMUM WIDTH OF TEN FEET AND SHALL BE PLANTED WITH GRASS, GROUND COVER, SHRUBBERY, OR OTHER SUITABLE PLANT MATERIAL. THE LOCATION, PLACEMENT, SPACING AND TYPES OF PLANT MATERIALS WILL BE SUCH THAT AN EFFICIENT HORIZONTAL AND VERTICAL OBSCURING OR SCREENING EFFECT BETWEEN LAND USES WILL BE ACHIEVED.

**LANDSCAPE BUFFERS SHOWN PER A0.6** PROPOSED TO HAVE THREE FOOT WIDE PLANTED BUFFER WHERE ADJACENT TO EXISTING 6'+ TALL FENCES

G.BERMS (EARTHEN MOUNDS) AND/OR CERTAIN TYPES OF FENCES MAY BE INSTALLED IN LIEU OF A LANDSCAPE BUFFER FOR THE PURPOSES OF SCREENING WHEN THE PLANNING COMMISSION DETERMINES

**BERMS NOT PROPOSED**

**FENCES PROPOSED AS PART OF THE LANDSCAPE BUFFER, NOT IN LIEU OF**

THE EXISTING TWO STORY APARTMENT STRUCTURE IS WITHIN THE LANDSCAPE BUFFER ZONE, BUT MEETS SET-BACK REQUIREMENTS ALSO SERVES AS A BUFFER BETWEEN WORKER HOUSING AND ADJACENT PROPERTY.

2 STORIES + 1/2 STORY (MEZZANINE LOFT)  
MAXIMUM DENSITY ACHIEVED

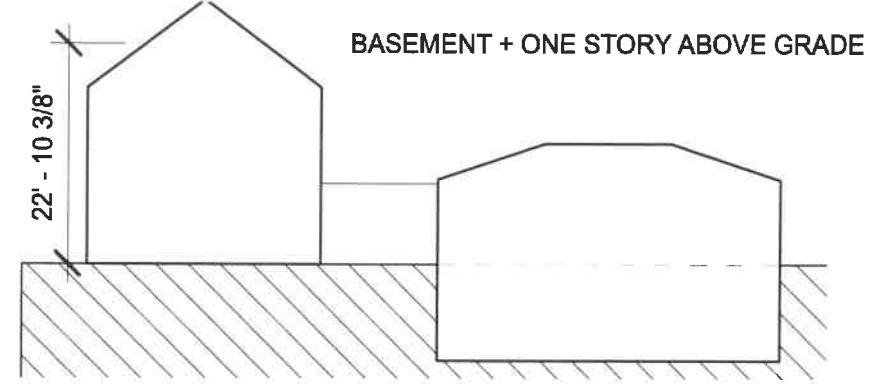

② DENSITY SECTION  
1" = 20'-0"

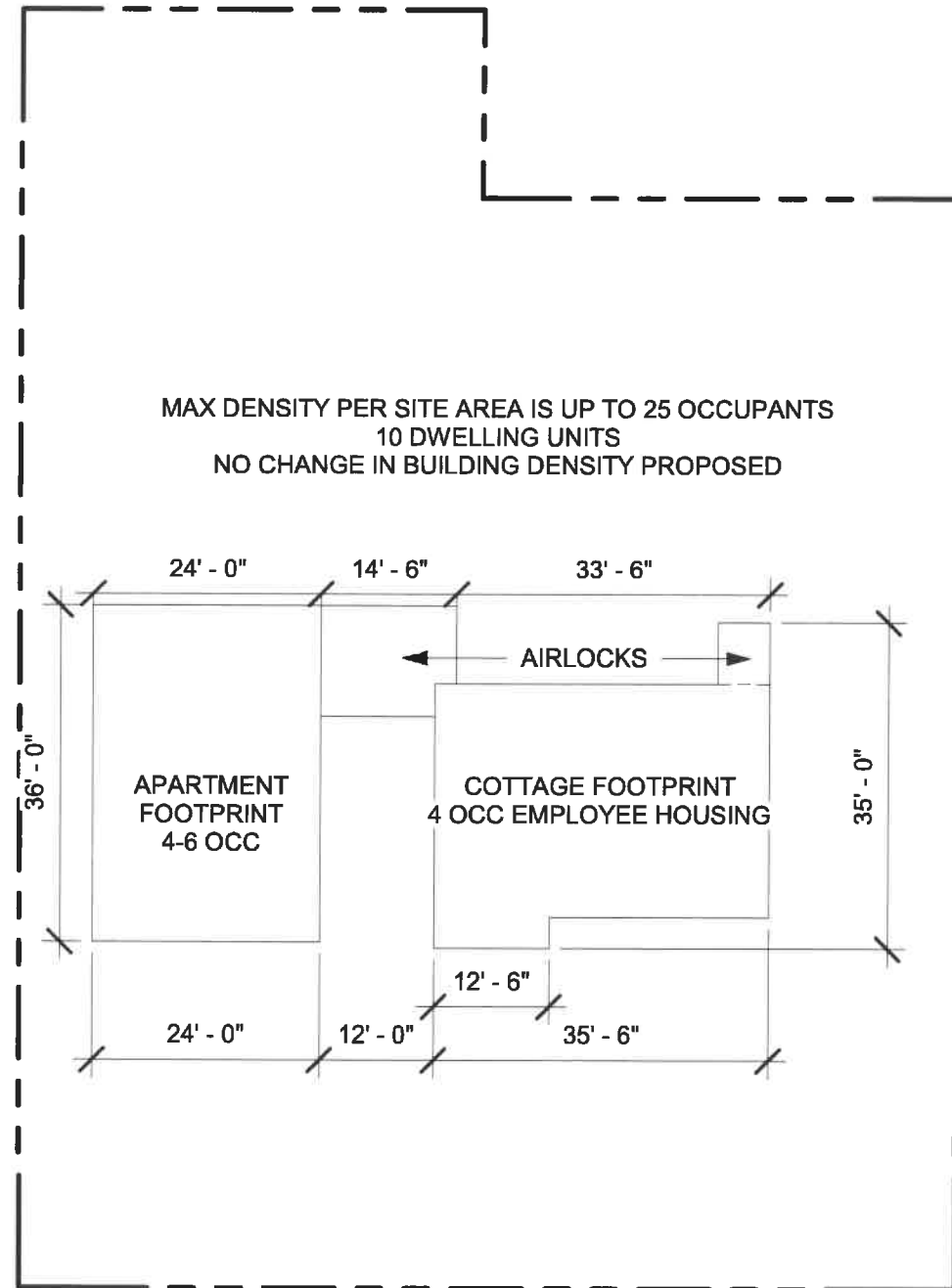

① 0 - DENSITY DIAGRAM  
1" = 20'-0"

**NOT FOR CONSTRUCTION**

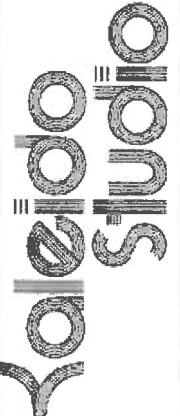

Kaleido Studio Architecture  
1661 SE 3rd Ave. # D201  
Portland, OR 97214  
www.kaleidoprjw.com  
B-Corp Certified

**MACKINAC ISLAND HOMES**



7547 7TH ST & 2827 CADOTTE AVE APT 101, 201  
MACKINAC ISLAND, MI 49757

02/23/24

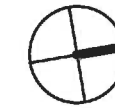
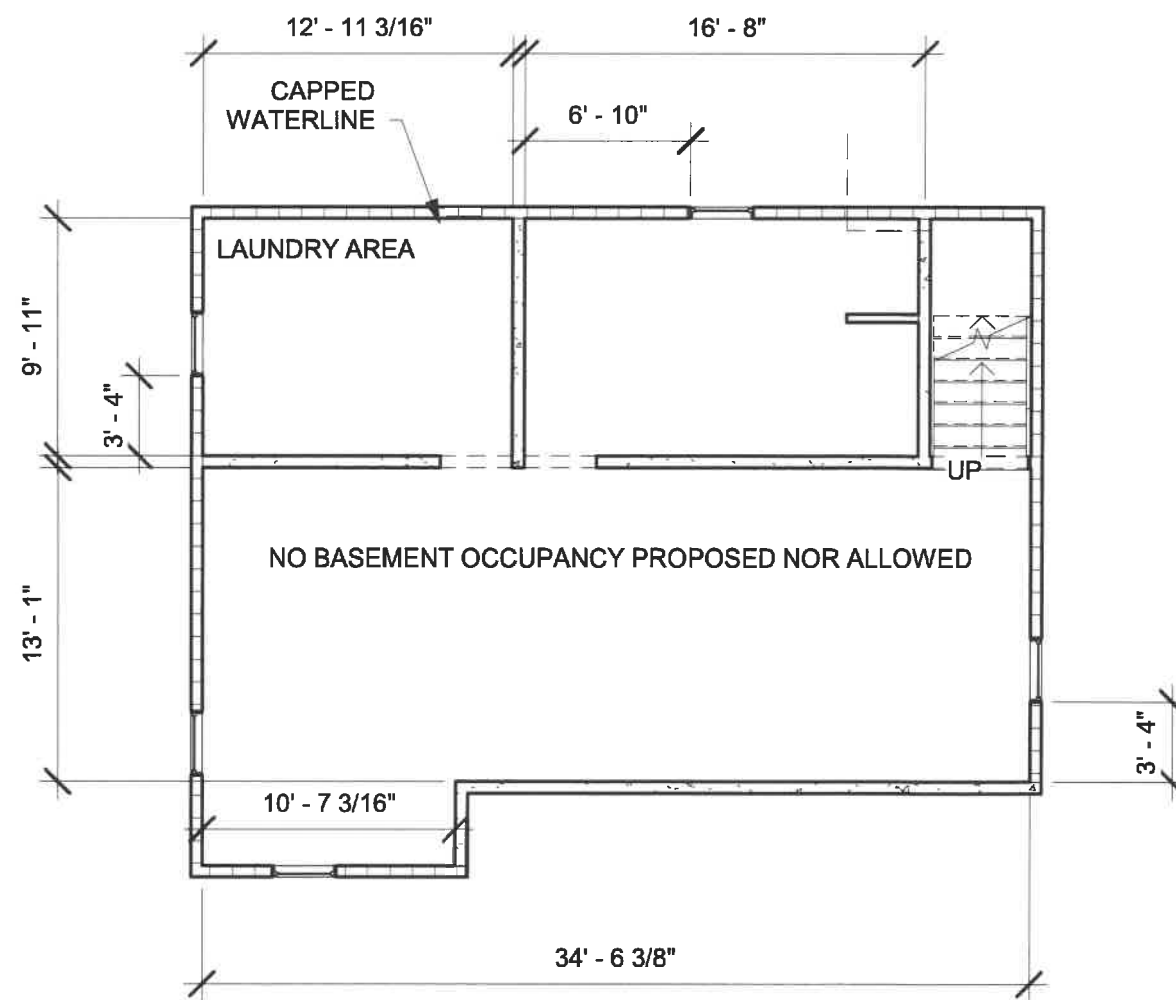
**A0.5**



**LEGEND**

-  WALL
-  WALL OR ELEMENT TO BE DEMOLISHED
-  GRID LINE

**DEMOLITION GENERAL NOTES**

1. COORDINATE BUILDING COMPONENT AND FIXTURE SALVAGE AND PROTECTION WITH OWNER.
2. PROVIDE ADEQUATE TEMPORARY SHORING, BRACING, AND SUPPORT PRIOR TO REMOVING EXISTING STRUCTURAL ELEMENTS.
3. WHEN REMOVING EXISTING FRAMING MEMBER USE CARE AND PROTECT FRAMING TO REMAIN AND LINES AS NEEDED TO ALLOW FOR NEW WORK.
4. REMOVE ELECTRICAL AND PLUMBING FIXTURE AND LINES AS NEEDED TO ALLOW FOR NEW WORK.
5. REMOVE INTERIOR FLOOR, WALL, AND CEILING FINISHES AS NEEDED TO ALLOW FOR NEW WORK.
6. ALL MATERIALS TO BE REMOVED SHALL BE RECYCLED TO THE GREATEST EXTENT POSSIBLE.

**NOTES ON EXISTING CONDITIONS**

THIS DOCUMENT HAS BEEN CREATED TO INCORPORATE INFORMATION MEASURED IN FIELD OR FROM HISTORICAL RECORD DOCUMENTATION. EXISTING AND/OR HIDDEN CONDITIONS SHOULD BE FIELD VERIFIED PRIOR TO COMMENCEMENT OF NEW WORK. ARCHITECT OF RECORD SHALL NOT BE LIABLE NOR RESPONSIBLE FOR PAST & EXISTING CONDITIONS. ARCHITECT OF RECORD HAS MADE REASONABLE ATTEMPT TO REVIEW EXISTING CONDITIONS AND IDENTIFY AREAS WHERE IMPROVEMENTS ARE REQUIRED TO MEET CURRENT CODE.

**NOT FOR CONSTRUCTION**

1 0 - BASEMENT EXISTING/DEMO  
1/8" = 1'-0"

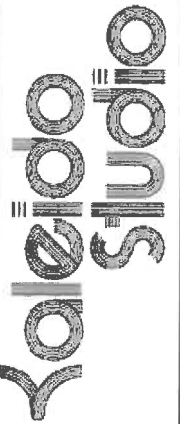

Kaleido Studio Architecture  
1661 SE 3rd Ave. # D201  
Portland, OR 97214  
www.kaleidopnw.com  
B-Corp Certified

**MACKINAC ISLAND HOMES**  
7547 7TH ST & 2827 CADOTTE AVE APT 101, 201  
MACKINAC ISLAND, MI 49757

02/23/24

A1.1



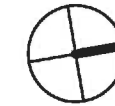
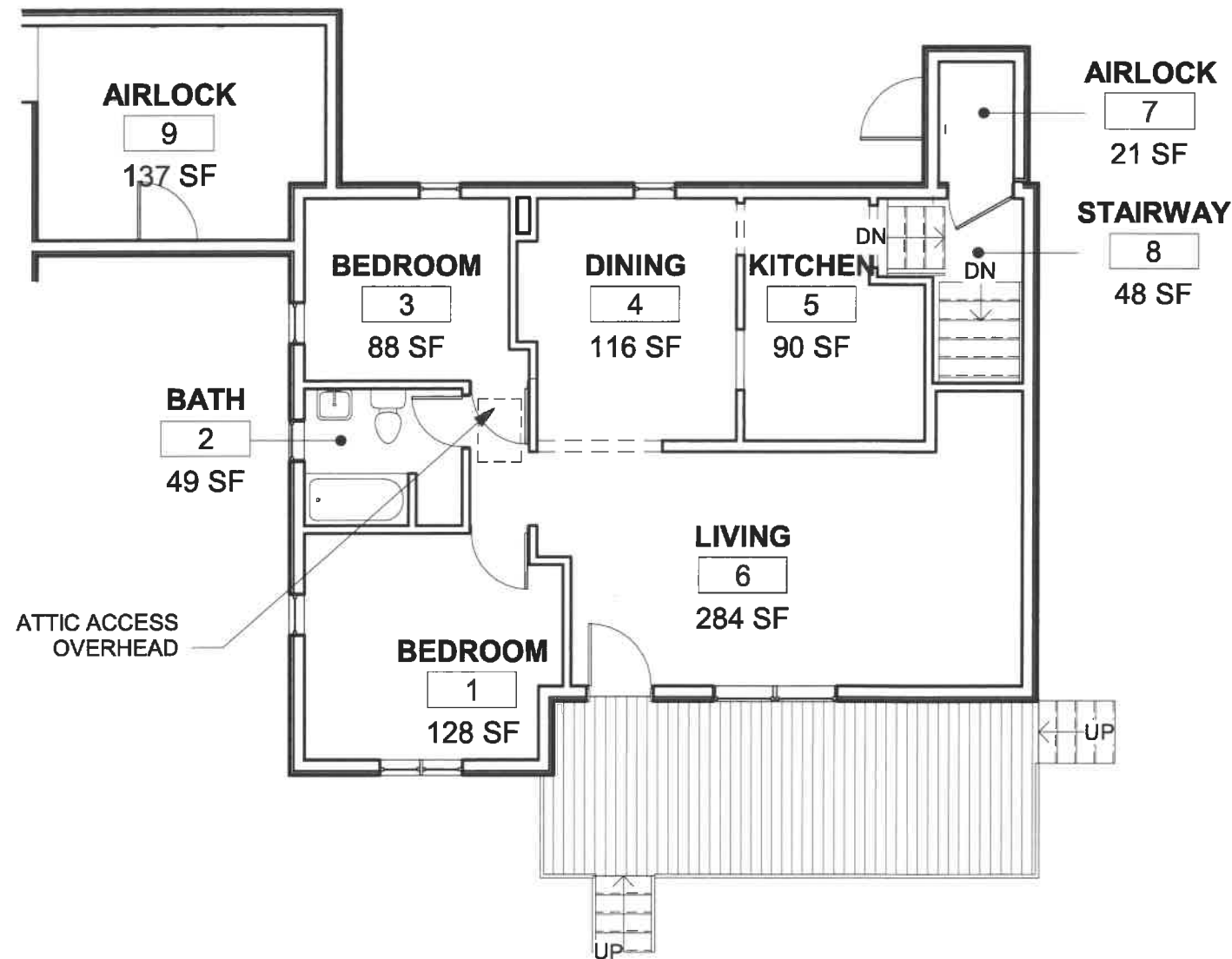

**LEGEND**

- WALL
- WALL OR ELEMENT TO BE DEMOLISHED
- GRID LINE

**DEMOLITION GENERAL NOTES**

1. COORDINATE BUILDING COMPONENT AND FIXTURE SALVAGE AND PROTECTION WITH OWNER.
2. PROVIDE ADEQUATE TEMPORARY SHORING, BRACING, AND SUPPORT PRIOR TO REMOVING EXISTING STRUCTURAL ELEMENTS.
3. WHEN REMOVING EXISTING FRAMING MEMBER USE CARE AND PROTECT FRAMING TO REMAIN.
4. REMOVE ELECTRICAL AND PLUMBING FIXTURE AND LINES AS NEEDED TO ALLOW FOR NEW WORK.
5. REMOVE INTERIOR FLOOR, WALL, AND CEILING FINISHES AS NEEDED TO ALLOW FOR NEW WORK.
6. ALL MATERIALS TO BE REMOVED SHALL BE RECYCLED TO THE GREATEST EXTENT POSSIBLE.

**NOTES ON EXISTING CONDITIONS**

THIS DOCUMENT HAS BEEN CREATED TO INCORPORATE INFORMATION MEASURED IN FIELD OR FROM HISTORICAL RECORD DOCUMENTATION. EXISTING AND/OR HIDDEN CONDITIONS SHOULD BE FIELD VERIFIED PRIOR TO COMMENCEMENT OF NEW WORK. ARCHITECT OF RECORD SHALL NOT BE LIABLE NOR RESPONSIBLE FOR PAST & EXISTING CONDITIONS. ARCHITECT OF RECORD HAS MADE REASONABLE ATTEMPT TO REVIEW EXISTING CONDITIONS AND IDENTIFY AREAS WHERE IMPROVEMENTS ARE REQUIRED TO MEET CURRENT CODE.

**NOT FOR CONSTRUCTION**

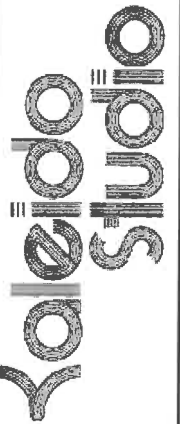

Kaleido Studio Architecture  
1661 SE 3rd Ave, # D201  
Portland, OR 97214  
www.kaleidopnw.com  
B-Corp Certified

**MACKINAC ISLAND HOMES**  
7547 7TH ST & 2827 CADOTTE AVE APT 101, 201  
MACKINAC ISLAND, MI 49757

① 1 - FIRST FLOOR EXISTING/DEMO  
1/8" = 1'-0"

02/23/24

A1.2

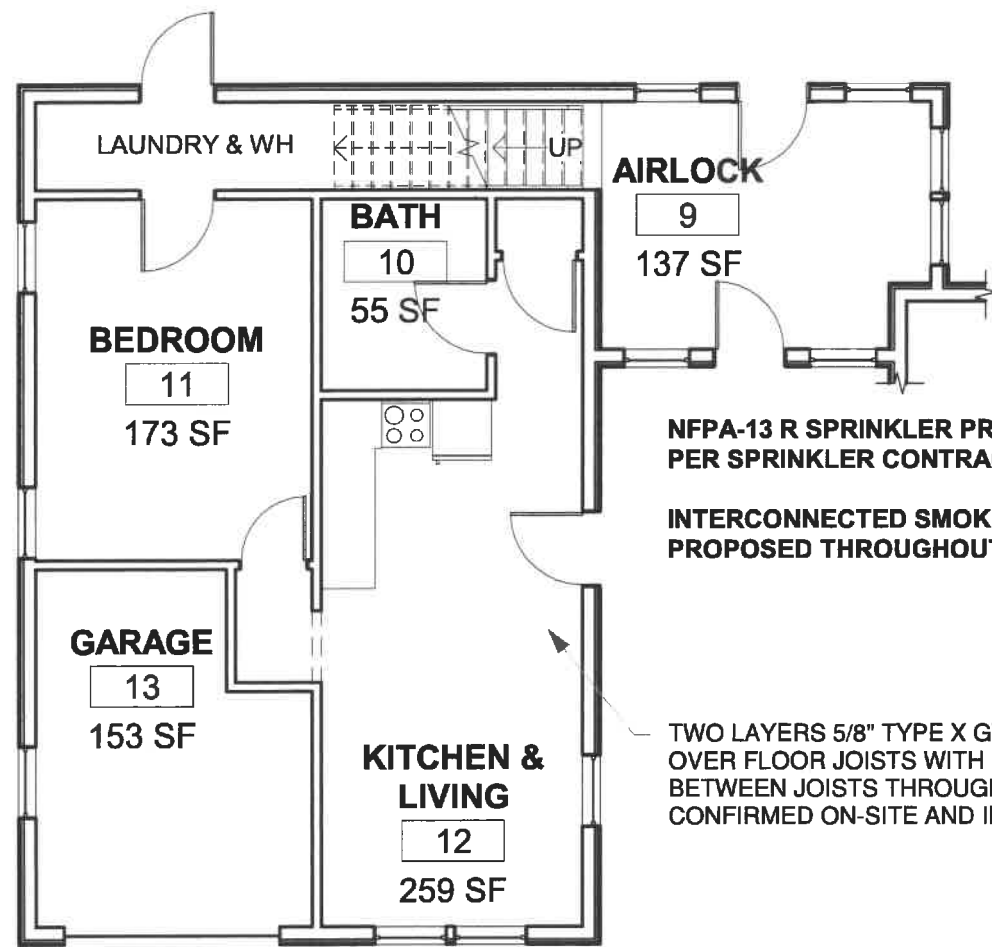

NFPA-13 R SPRINKLER PROPOSED  
PER SPRINKLER CONTRACTOR

INTERCONNECTED SMOKE DETECTORS  
PROPOSED THROUGHOUT BOTH STRUCTURES

TWO LAYERS 5/8" TYPE X GYPSUM CELING  
OVER FLOOR JOISTS WITH INSULATION  
BETWEEN JOISTS THROUGHOUT TO BE  
CONFIRMED ON-SITE AND INSPECTED



LEGEND

- WALL
- WALL OR ELEMENT TO BE DEMOLISHED
- GRID LINE

DEMOLITION GENERAL NOTES

1. COORDINATE BUILDING COMPONENT AND FIXTURE SALVAGE AND PROTECTION WITH OWNER.
2. PROVIDE ADEQUATE TEMPORARY SHORING, BRACING, AND SUPPORT PRIOR TO REMOVING EXISTING STRUCTURAL ELEMENTS.
3. WHEN REMOVING EXISTING FRAMING MEMBER USE CARE AND PROTECT FRAMING TO REMAIN.
4. REMOVE ELECTRICAL AND PLUMBING FIXTURE AND LINES AS NEEDED TO ALLOW FOR NEW WORK.
5. REMOVE INTERIOR FLOOR, WALL, AND CEILING FINISHES AS NEEDED TO ALLOW FOR NEW WORK.
6. ALL MATERIALS TO BE REMOVED SHALL BE RECYCLED TO THE GREATEST EXTENT POSSIBLE.

NOTES ON EXISTING CONDITIONS

THIS DOCUMENT HAS BEEN CREATED TO INCORPORATE INFORMATION MEASURED IN FIELD OR FROM HISTORICAL RECORD DOCUMENTATION. EXISTING AND/OR HIDDEN CONDITIONS SHOULD BE FIELD VERIFIED PRIOR TO COMMENCEMENT OF NEW WORK. ARCHITECT OF RECORD SHALL NOT BE LIABLE NOR RESPONSIBLE FOR PAST & EXISTING CONDITIONS. ARCHITECT OF RECORD HAS MADE REASONABLE ATTEMPT TO REVIEW EXISTING CONDITIONS AND IDENTIFY AREAS WHERE IMPROVEMENTS ARE REQUIRED TO MEET CURRENT CODE.

**NOT FOR CONSTRUCTION**



Kaleido Studio Architecture  
1661 SE 3rd Ave, # D201  
Portland, OR 97214  
www.kaleidopnw.com  
B-Corp Certified

**MACKINAC ISLAND HOMES**

7547 7TH ST & 2827 CADOTTE AVE APT 101, 201  
MACKINAC ISLAND, MI 49757

02/23/24

A1.3

A4.1 2

1 0 - APT 101  
1/8" = 1'-0"

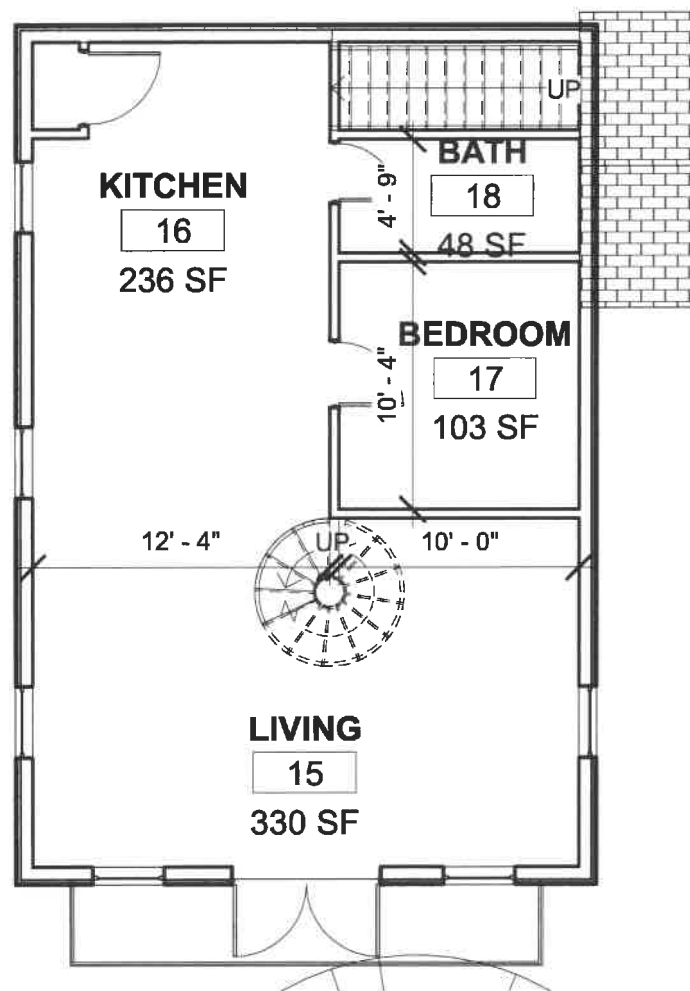

1 - APT 201  
1/8" = 1'-0"

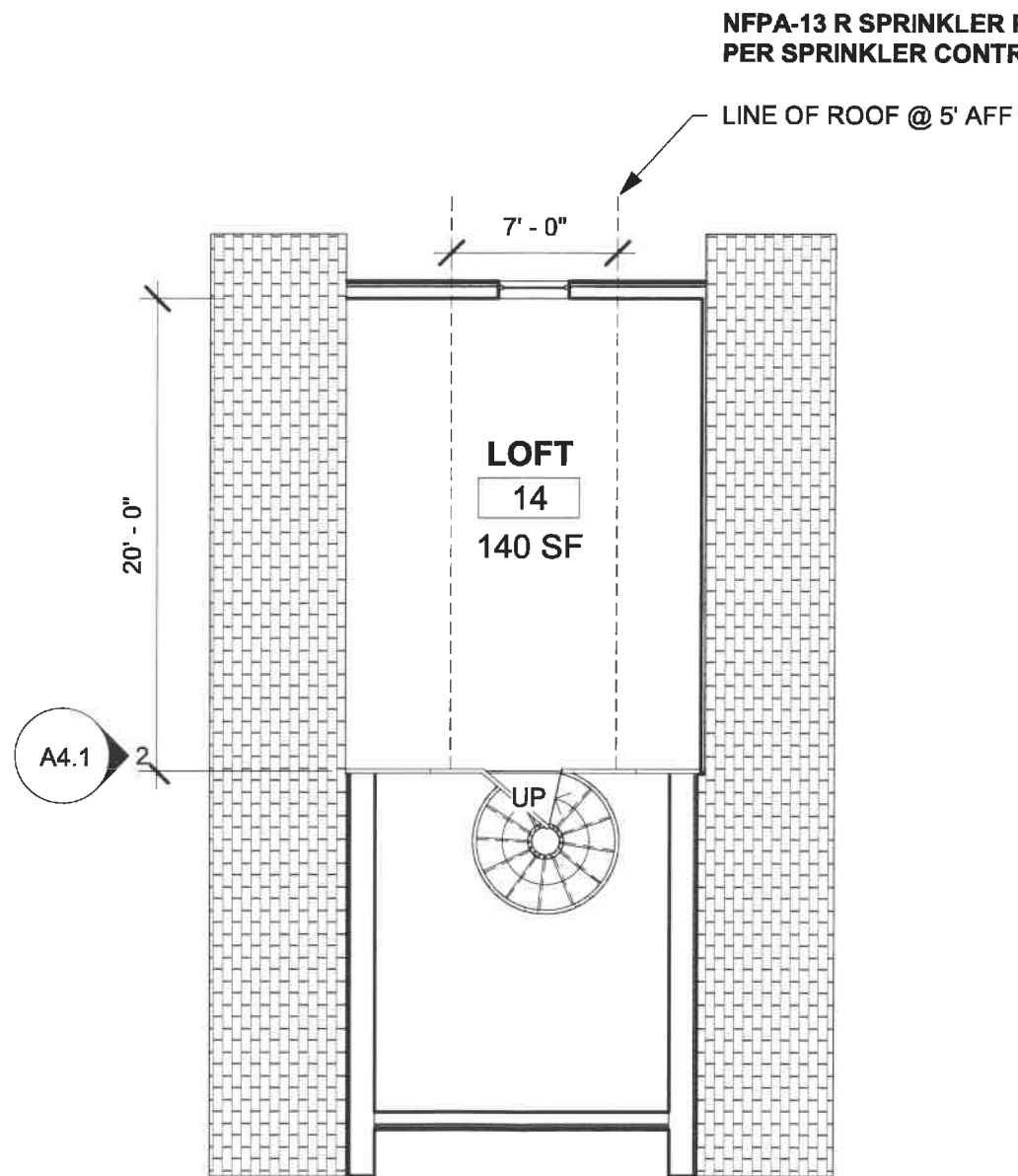

2 - APT 201  
1/8" = 1'-0"

NFPA-13 R SPRINKLER PROPOSED  
PER SPRINKLER CONTRACTOR

LINE OF ROOF @ 5' AFF



LEGEND

- WALL
- WALL OR ELEMENT TO BE DEMOLISHED
- GRID LINE

DEMOLITION GENERAL NOTES

1. COORDINATE BUILDING COMPONENT AND FIXTURE SALVAGE AND PROTECTION WITH OWNER.
2. PROVIDE ADEQUATE TEMPORARY SHORING, BRACING, AND SUPPORT PRIOR TO REMOVING EXISTING STRUCTURAL ELEMENTS.
3. WHEN REMOVING EXISTING FRAMING MEMBER USE CARE AND PROTECT FRAMING TO REMAIN.
4. REMOVE ELECTRICAL AND PLUMBING FIXTURE AND LINES AS NEEDED TO ALLOW FOR NEW WORK.
5. REMOVE INTERIOR FLOOR, WALL, AND CEILING FINISHES AS NEEDED TO ALLOW FOR NEW WORK.
6. ALL MATERIALS TO BE REMOVED SHALL BE RECYCLED TO THE GREATEST EXTENT POSSIBLE.

NOTES ON EXISTING CONDITIONS

THIS DOCUMENT HAS BEEN CREATED TO INCORPORATE INFORMATION MEASURED IN FIELD OR FROM HISTORICAL RECORD DOCUMENTATION. EXISTING AND/OR HIDDEN CONDITIONS SHOULD BE FIELD VERIFIED PRIOR TO COMMENCEMENT OF NEW WORK. ARCHITECT OF RECORD SHALL NOT BE LIABLE NOR RESPONSIBLE FOR PAST & EXISTING CONDITIONS. ARCHITECT OF RECORD HAS MADE REASONABLE ATTEMPT TO REVIEW EXISTING CONDITIONS AND IDENTIFY AREAS WHERE IMPROVEMENTS ARE REQUIRED TO MEET CURRENT CODE.

**NOT FOR CONSTRUCTION**

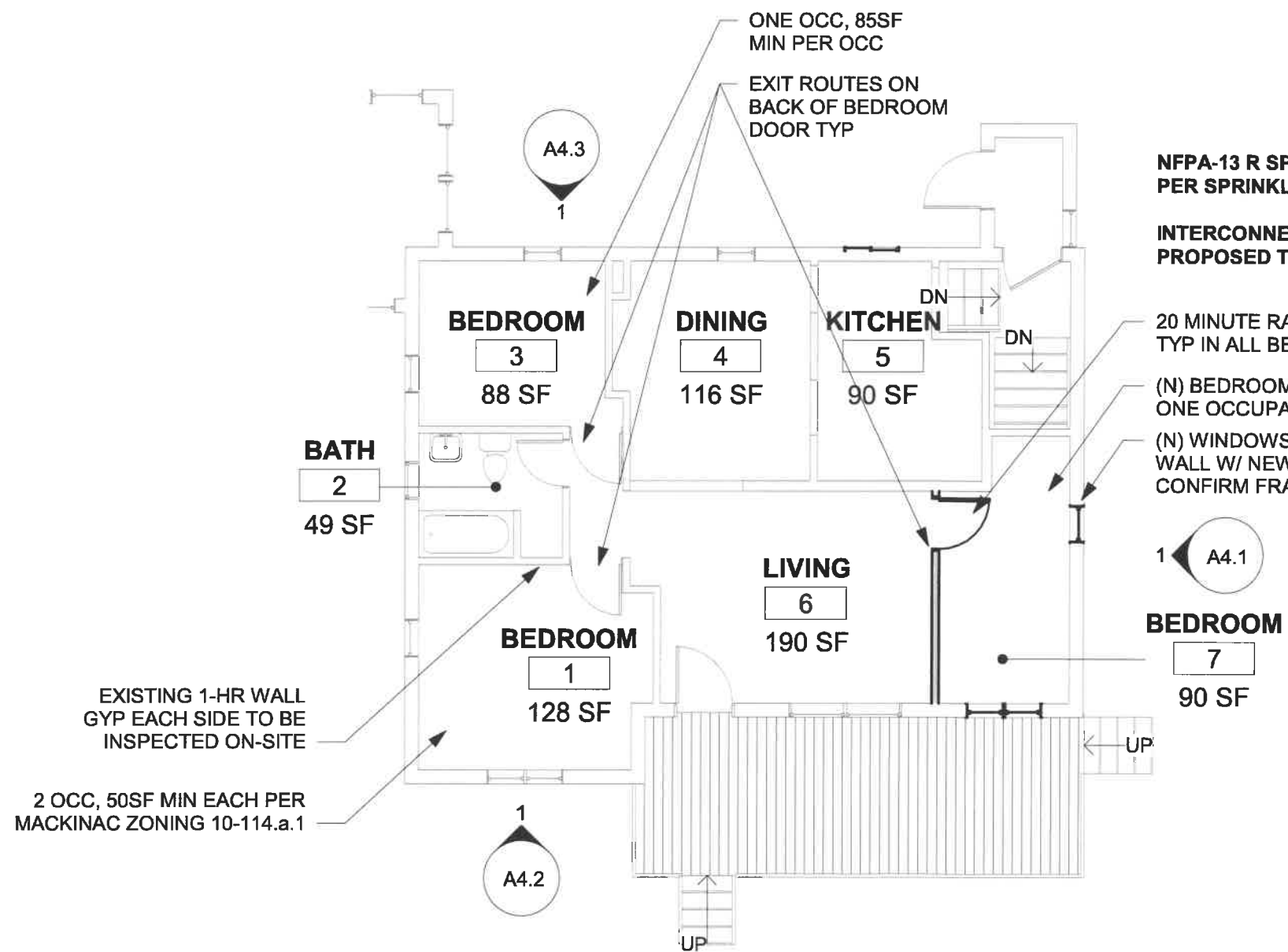

EXISTING 1-HR WALL GYP EACH SIDE TO BE INSPECTED ON-SITE

2 OCC, 50SF MIN EACH PER MACKINAC ZONING 10-114.a.1

**NFFA-13 R SPRINKLER PROPOSED PER SPRINKLER CONTRACTOR**

**INTERCONNECTED SMOKE DETECTORS PROPOSED THROUGHOUT BOTH STRUCTURES**

**PLAN SYMBOL LEGEND**

	WALL - NEW		DOOR TAG
	WALL - EXISTING		WINDOW TAG
	WALL - TO BE DEMOLISHED		WALL TAG

**1 - FIRST FLOOR PROPOSED**  
1/8" = 1'-0"

**NOT FOR CONSTRUCTION**

**Kaleido Studio**

Kaleido Studio Architecture  
1661 SE 3rd Ave. # D201  
Portland, OR 97214  
www.kaleidopnw.com  
B-Corp Certified

**MACKINAC ISLAND HOMES**  
7547 7TH ST & 2827 CADOTTE AVE APT 101, 201  
MACKINAC ISLAND, MI 49757

02/23/24

**A2.1**

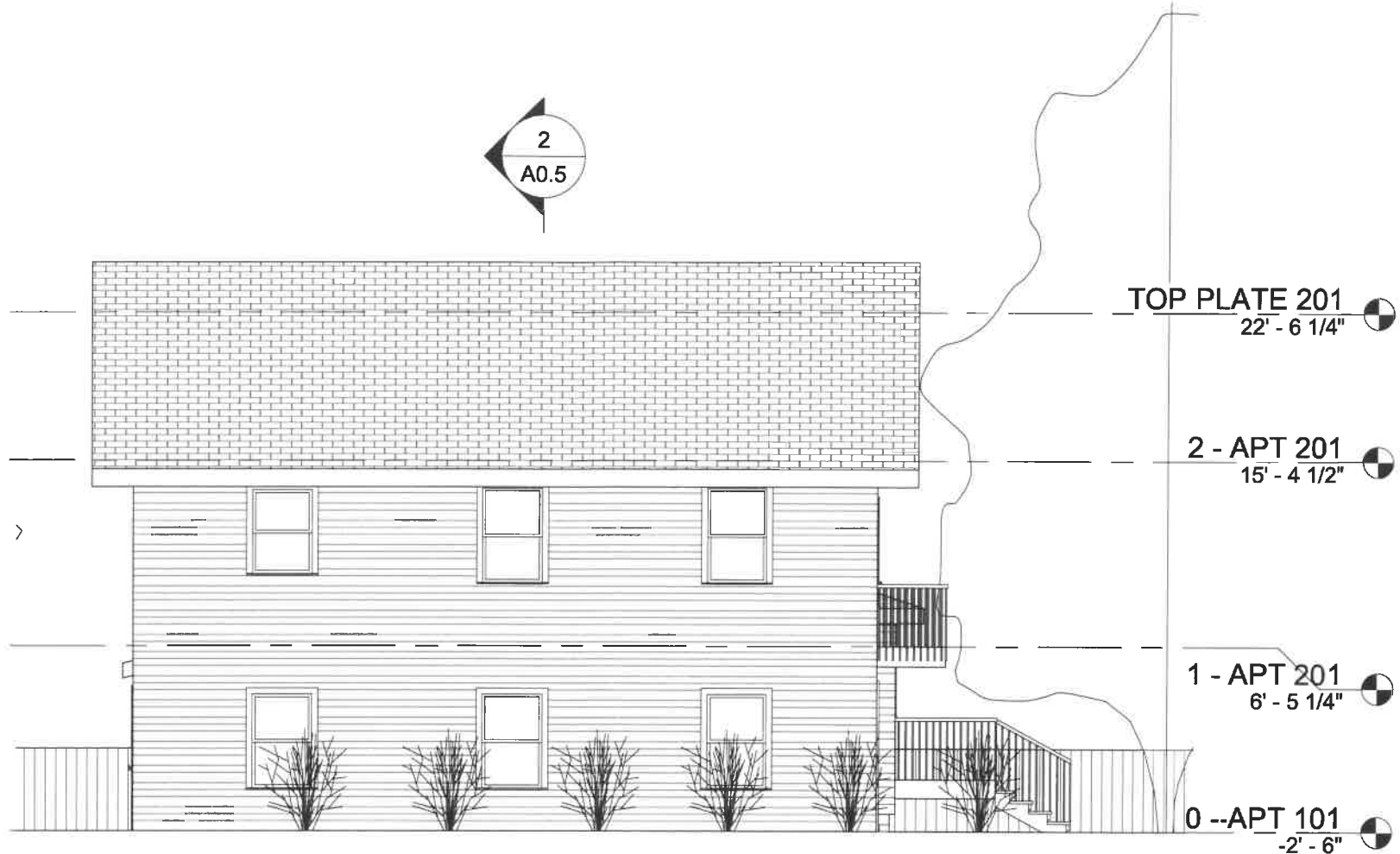
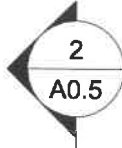

2 SOUTH ELEVATION  
1/8" = 1'-0"

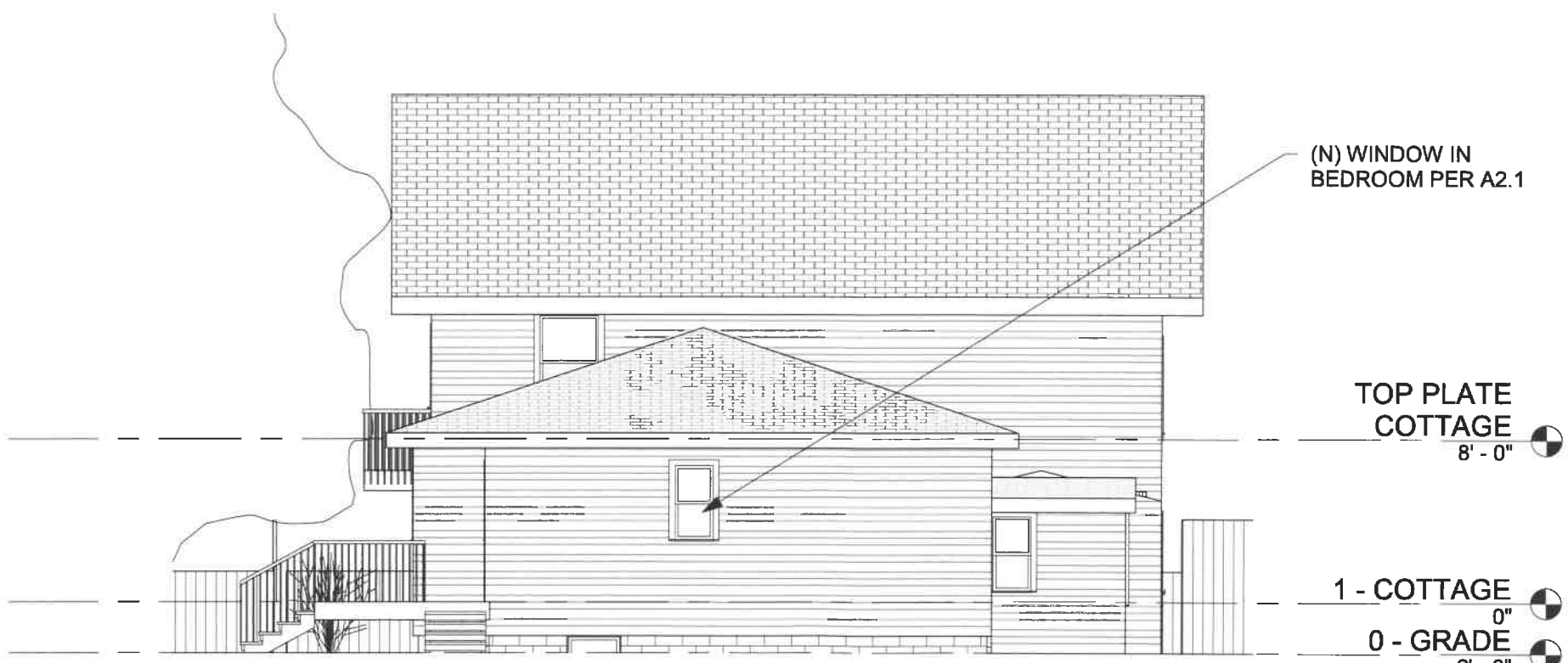

1 NORTH ELEVATION  
1/8" = 1'-0"

NOT FOR CONSTRUCTION

**Kaleido Studio**

Kaleido Studio Architecture  
1661 SE 3rd Ave. # D201  
Portland, OR 97214  
www.kaleidopnw.com  
B-Corp Certified

**MACKINAC ISLAND HOMES**  
7547 7TH ST & 2827 CADOTTE AVE APT 101, 201  
MACKINAC ISLAND, MI 49757

02/23/24

A4.1



TOP PLATE 201  
22' - 6 1/4"

2 - APT 201  
15' - 4 1/2"

1 - APT 201  
6' - 5 1/4"

0 - APT 101  
-2' - 6"



TOP PLATE  
COTTAGE  
8' - 0"

1 - COTTAGE  
0"  
0 - GRADE  
-2' - 6"

1 EAST ELEVATION  
1/8" = 1'-0"

NOT FOR CONSTRUCTION

Kaleido  
Studio

Kaleido Studio Architecture  
1661 SE 3rd Ave. # D201  
Portland, OR 97214  
www.kaleidopnw.com  
B-Corp Certified

MACKINAC ISLAND HOMES  
7547 7TH ST & 2827 CADOTTE AVE APT 101, 201  
MACKINAC ISLAND, MI 49757

02/23/24

A4.2



**NOT FOR CONSTRUCTION**

1 WEST ELEVATION  
1/8" = 1'-0"

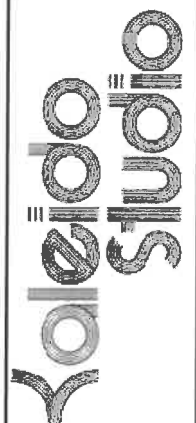

Kaleido Studio Architecture  
1661 SE 3rd Ave. # D201  
Portland, OR 97214  
www.kaleidopnw.com  
B-Corp Certified

**MACKINAC ISLAND HOMES**  
7547 7TH ST & 2827 CADOTTE AVE APT 101, 201  
MACKINAC ISLAND, MI 49757

02/23/24

A4.3





BACK OF HOUSE FROM 7TH STREET



BACK OF HOUSE

File No. R424 043-011

Exhibit E

Date 2-27-24

Initials KP

RECEIVED  
FEB 27 2024  
KP



FRONT OF HOUSE FROM CADOTTE STREET W/ NEIGHBOR ACCESS SHOWN



FRONT OF HOUSE

NOT FOR CONSTRUCTION

Kaleido Studio

Kaleido Studio Architecture  
1661 SE 3rd Ave, # D201  
Portland, OR 97214  
www.kaleidopnw.com

B-Corp Certified

MACKINAC ISLAND HOMES  
7547 7TH ST & 2827 CADOTTE AVE APT 101, 201  
MACKINAC ISLAND, MI 49757

02/23/24

A9.0





LANDSCAPING BACK



LANDSCAPING NORTH

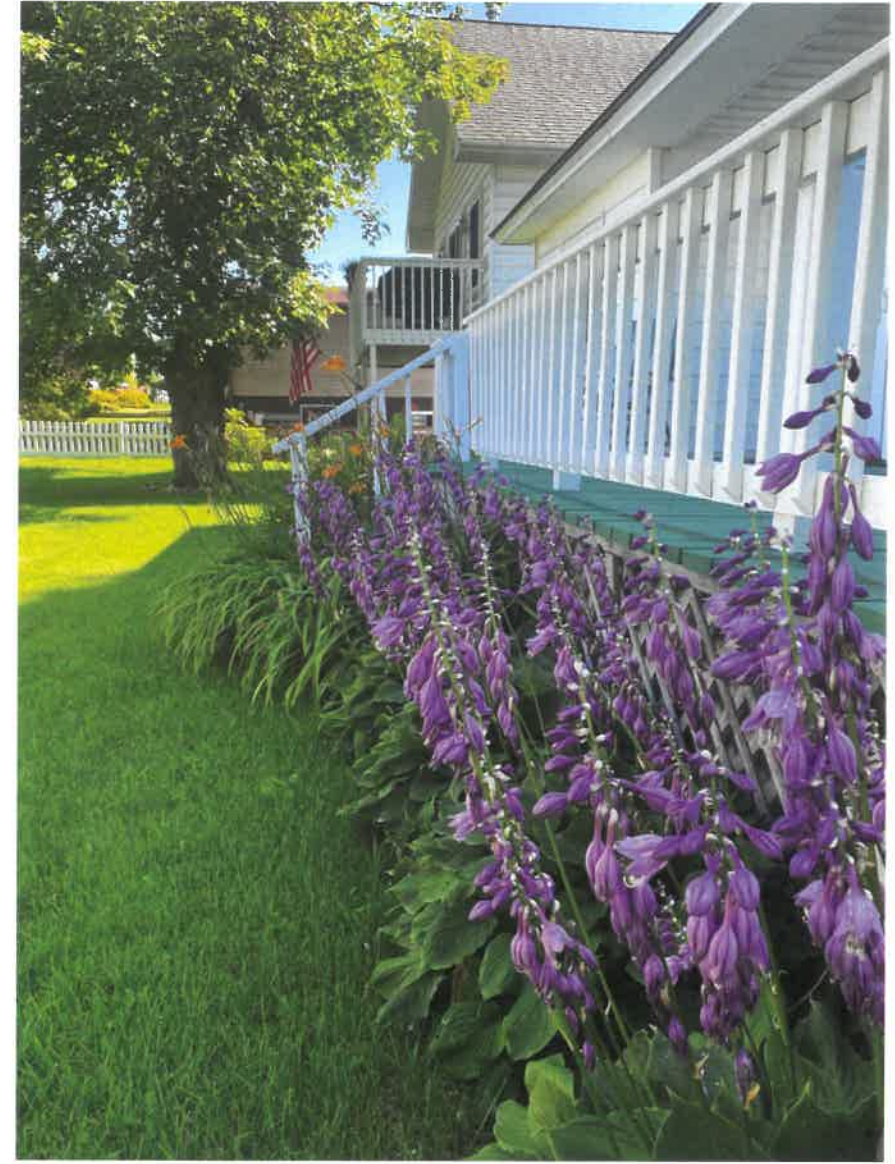

LANDSCAPING EAST

**NOT FOR CONSTRUCTION**

**Kaleido  
Studio**

Kaleido Studio Architecture  
1661 SE 3rd Ave. # D201  
Portland, OR 97214  
www.kaleidopnw.com

B-Corp Certified

**MACKINAC ISLAND HOMES**

7547 7TH ST & 2827 CADOTTE AVE APT 101, 201  
MACKINAC ISLAND, MI 49757

02/23/24

**A9.1**





COTTAGE DINING ROOM



COTTAGE KITCHEN



COTTAGE BEDROOM 1



COTTAGE BEDROOM 2



COTTAGE BATHROOM

**NOT FOR CONSTRUCTION**

**Kaleido  
Studio**

Kaleido Studio Architecture  
1661 SE 3rd Ave. # D201  
Portland, OR 97214  
www.kaleidopnw.com  
B-Corp Certified

**MACKINAC ISLAND HOMES**

7547 7TH ST & 2827 CADOTTE AVE APT 101, 201  
MACKINAC ISLAND, MI 49757

02/23/24

**A9.2**





NEIGHBORS (ACROSS CADOTTE STREET)



NEIGHBOR (ACROSS 7TH STREET)



NEIGHBOR'S ACCESS



NEIGHBORS BEHIND

**NOT FOR CONSTRUCTION**

**Kaleido  
Studio**

Kaleido Studio Architecture  
1661 SE 3rd Ave. # D201  
Portland, OR 97214  
www.kaleidopnw.com  
B-Corp Certified

**MACKINAC ISLAND HOMES**  
7547 7TH ST & 2827 CADOTTE AVE APT 101, 201  
MACKINAC ISLAND, MI 49757

02/23/24

**A9.3**