

**Assessment of and Protection Recommendations for 13 Regulated Trees
At And Adjacent To**

**116 Vallecitos
Los Gatos, California**

**SEE MY
RESPONSES IN RED
BELOW**

Prepared for:
Mr. Ryan Safty, Associate Planner
Town of Los Gatos Community Development Department
110 E. Main Street
Los Gatos, CA 95030

Field Visit Date:
Walter Levison, Contract Town Arborist (CTA)
11/24/2025

Report by CTA
12/16/2025

Table of Contents

1.0 Summary with Table 1.0(a)	3
1.1 Quick-View Single-Page Summary (Bullet Style) / 13 Trees in Study	10
2.0 Assignment & Background	10
3.0 Town of Los Gatos – What Trees are Protected?	11
4.0 Recommendations	13
5.0 Tree Protection and Maintenance Directions per Town Code	23
6.0 Tree Replacement Standards & Fees – Los Gatos Town Code and 2025 Fee Schedule	27
7.0 Author’s Qualifications (Partial)	31
8.0 Assumptions and Limiting Conditions	32
9.0 Certification	33
10.0 Digital Images	34
11.0 Tree Data Table	46
12.0 Tree Map Mark-up by the CTA (2025) on Applicant Site Plan Sheet 4 of 19	52

1.0 Summary with Table 1.0(a)

- a. Below is a matrix style overview of protected-size trees (non-exempt species, 4-inches diameter at 4.5 feet above grade).

Mitigation replacement rate and size is noted for each tree in the case that removal or damage to trees occurs.

The proposed site plan sheet 4, from plan set date October, 2025, was used by the CTA as the basis sheet to create a tree map markup showing tree tag numbers of regulated size trees both on site (trees 22 through 33) and adjacent to the site (tree 21 Town-owned “street tree”).

Trees were tagged with numeric tags at eye level by the CTA as “21” through “33”.

General Overview of Applicant’s Site Plan Layout vs. Tree Preservation:

- Tree 21 may experience severe negative impacts if the proposed new gas line trenching and proposed new property line wall are built out at the current proposed locations shown on the applicant’s site plan sheet 4 of 19.

The CTA suggests either pushing these two items farther offset from the mainstem of tree 21, such as 6 feet offset for gas line and 10 feet offset for wall work.

If relocation of the gas line and/or wall position is/are not possible, then “trenchless technology” could be utilized to safely bore the gas line underneath the root system of the tree at depth such as at 3 to 4 feet depth, and a “floating over-grade beam suspended on vertical piers” could be used to build the proposed new wall above the lateral woody root system of the tree.

- Trees 22, 32, and 33 are to be removed due to their proximity to the proposed new residence massing. The proposed new two-story residence & ADU foundation excavation work will be too close in proximity to the base of tree 33 in terms of the tree’s lateral woody anchor root system, at a distance of approximately 6 feet east of trunk edge. Staff will need to make a decision to either require tree 33 be protected in place and redesign the entire site plan to push the building footprint to 10 feet east of the trunk edge (i.e. to the location of the existing single family residence foundation edge), or allow the removal of tree 33 per the applicant’s proposed project plan set. The CTA suggests allowing removal of the tree per plan.
- Trees 23, 24, 25, 26, 27, 29, 30, and 31 are far enough offset from proposed construction that they appear to be retainable, if chain link fencing protection barriers are erected along the red dashed lines indicated on the CTA’s tree map markup in this report.
- Tree 28 is a very large specimen of native Northern California black walnut with very extensive wood tissue decay progression in the lower mainstem area where a third mainstem was removed at 4 feet elevation in the past. The tree has been extensively pruned by PG&E to clear the overhead high voltage electrical wire right of way. The remaining remnant tree has a compromised structural root system with visible decay in the lower trunk, and a canopy that is lopsided northward toward the proposed residence. The CTA recommends removal of this tree for safety purposes.

The tree is considered either a “moderate” or a “high” TRAQ risk in terms of likelihood of tree or tree part failure and impact with high value targets, causing significant to severe damage. Risk rating determination is outside of the scope of this CTA arborist report preparation assignment. However,

for the purposes of this report, the tree is suggested to be considered by Town Staff to be a “high risk” tree specimen, which allows the tree to be removed as a no-fee removal with no canopy replacement plantings required by the applicant. See box on report page 4 below for details.

Staff Protocols 2022 Onward / High Risk Trees & Extreme Risk Trees & Dead Trees

Per my communications with Town Planning Division Staff in 2022, all trees with a TRAQ risk rating of “high” or “extreme”, and all trees in “dead” (i.e. 0 to 5% overall condition ratings) are allowed to be removed as no-fee removals, without any canopy replacement fees or plantings required, when a land plot is undergoing entitlement review. The reference for this no-fee/no-replacement removal standard is tree ordinance section 29.10.0985.

Table 1.0(a) **WE ARE PLANNING TO KEEP THIS TREE**

(Refer also to the CTA’s tree data table and tree map markup in this report when reviewing Table 1.0(a)).

Tree Tag Number	Tree Disposition Per Applicant Drawings	Position in Landscape	Common Name	Large Protected Tree (LPT)?	Appraised Value per newest (2019) Trunk Formula Technique	Site plan changes or restrictions required to reduce impacts to “less than significant” are noted in black bold type for quick reference.	Replacement Rate Per Canopy Lost	Replacement Size Tree or In-Lieu Fees, Based on \$250 per any size replacement tree
21	Not Verified. Depends on Locations of Site Work (New Gas Line and Structural Wall).	Street	Sweetgum	No	\$2,990.	<p>Push proposed new gas pipe alignment to approximately 6 feet offset from trunk edge. If this is not possible, then use pit to pit directional bore (trenchless technology) to bore 3 to 4 feet underneath the root plate of the tree.</p> <p>Push the proposed property perimeter wall to at least 10 feet offset from trunk edge. If this is not possible, then build at current proposed location, using a modified specification, such as a wall with foundation that utilizes a floating “over-grade” beam set over existing surface soil grade elevation, suspended on small diameter vertical pier footings.</p>	4	15 gallon size tree. (\$1,000.)

Tree Tag Number	Tree Disposition Per Applicant Drawings	Position in Landscape	Common Name	Large Protected Tree (LPT)?	Appraised Value per newest (2019) Trunk Formula Technique	Site plan changes or restrictions required to reduce impacts to "less than significant" are noted in black bold type for quick reference.	Replacement Rate Per Canopy Lost	Replacement Size Tree or In-Lieu Fees, Based on \$250 per any size replacement tree
22	Remove	Front entrance area	Crabapple cultivar	No	n/a	n/a	3 WE HAVE 3 – 15 GALLON PITTOSPORUM	15 gallon size tree. (\$750.) (Note that this is technically a "fruit tree", but the fruits are extremely small in size, and not used for human consumption.)
23	Protect in Place (PIP)	Southeast corner	Douglas fir	No	\$8,800.	No site work adjustments necessary. Fence off at canopy dripline per the CTA's tree map markup embedded in this report.	6	15 gallon size tree. (\$1,500.)
24	Protect in Place (PIP)	Rear fence	Xylosma (Not 100% Verified)	No	\$7,300.	No site work adjustments necessary. Fence off at canopy dripline per the CTA's tree map markup embedded in this report.	4	15 gallon size tree. (\$1,000.)

Tree Tag Number	Tree Disposition Per Applicant Drawings	Position in Landscape	Common Name	Large Protected Tree (LPT)?	Appraised Value per newest (2019) Trunk Formula Technique	Site plan changes or restrictions required to reduce impacts to "less than significant" are noted in black bold type for quick reference.	Replacement Rate Per Canopy Lost	Replacement Size Tree or In-Lieu Fees, Based on \$250 per any size replacement tree
25	Protect in Place (PIP)	Rear fence	Australian brush cherry (Syzygium)	No	\$740.	No site work adjustments necessary. Fence off at canopy dripline per the CTA's tree map markup embedded in this report.	3	15 gallon size tree. (\$750.)
26	Protect in Place (PIP)	Rear fence	Victorian box pittosporum	No	\$760.	No site work adjustments necessary. Fence off at canopy dripline per the CTA's tree map markup embedded in this report.	3	15 gallon size tree. (\$750.)
27	Protect in Place (PIP)	Rear fence	Victorian box pittosporum	No	\$660.	No site work adjustments necessary. Fence off at canopy dripline per the CTA's tree map markup embedded in this report.	3	15 gallon size tree. (\$750.)

Tree Tag Number	Tree Disposition Per Applicant Drawings	Position in Landscape	Common Name	Large Protected Tree (LPT)?	Appraised Value per newest (2019) Trunk Formula Technique	Site plan changes or restrictions required to reduce impacts to "less than significant" are noted in black bold type for quick reference.	Replacement Rate Per Canopy Lost	Replacement Size Tree or In-Lieu Fees, Based on \$250 per any size replacement tree
28	Remove	Rear fence	Northern California black walnut (native tree, nut producing tree, but larger than 18" diameter.	No	n/a	<p>Tree to be removed at the recommendation of the CTA, given that risk rating was determined to be approximately "high", for tree or tree part failure and impact with persons or property (tree risk rating determination was outside the scope of this report preparation assignment, but was determined as a "rough approx. risk rating" in order to note this important safety situation for Town Planning Dept Staff.</p> <p>This tree qualifies for the "no fee / no mitigation planting" protocol.</p> <p>The reference for this no-fee/no-replacement tree removal standard is Town of Los Gatos tree ordinance section 29.10.0985.</p>	(NO FEE)	(NO FEE)
29	Protect in Place (PIP)	Rear fence	Victorian box pittosporum	No	\$600.	No site work adjustments necessary. Fence off at canopy dripline per the CTA's tree map markup embedded in this report.	3	15 gallon size tree. (\$750.)



Tree Tag Number	Tree Disposition Per Applicant Drawings	Position in Landscape	Common Name	Large Protected Tree (LPT)?	Appraised Value per newest (2019) Trunk Formula Technique	Site plan changes or restrictions required to reduce impacts to "less than significant" are noted in black bold type for quick reference.	Replacement Rate Per Canopy Lost	Replacement Size Tree or In-Lieu Fees, Based on \$250 per any size replacement tree
30	Protect in Place (PIP)	Rear fence	Holly tree	No	\$740.	No site work adjustments necessary. Fence off at canopy dripline per the CTA's tree map markup embedded in this report.	3	15 gallon size tree. (\$750.)
31	Protect in Place (PIP)	Rear fence	Holly tree	No	\$3,790.	No site work adjustments necessary. Fence off at canopy dripline per the CTA's tree map markup embedded in this report.	3	15 gallon size tree. (\$750.)
32	Remove	Rear courtyard	Japanese maple	No	n/a	n/a	4 WE HAVE 4 – 15 GALLON PITTOSPORUM	15 gallon size tree. (\$1,000.)

Tree Tag Number	Tree Disposition Per Applicant Drawings	Position in Landscape	Common Name	Large Protected Tree (LPT)?	Appraised Value per newest (2019) Trunk Formula Technique	Site plan changes or restrictions required to reduce impacts to "less than significant" are noted in black bold type for quick reference.	Replacement Rate Per Canopy Lost	Replacement Size Tree or In-Lieu Fees, Based on \$250 per any size replacement tree
33	Remove	Right side yard	Douglas fir	No	n/a	<p>Tree to be removed per applicant, due to very close proximity to proposed new residence footprint. Work will significantly compromise tree's structural woody anchor root system that is visible along the east side of tree as of the date of writing.</p> <p>Existing residence is approximately 9.5 feet from trunk edge.</p> <p>Proposed new residence foundation will be approximately 6 feet from trunk edge, with a new concrete walk encroaching to (zero) feet from trunk edge.</p>	6 WE HAVE 6 – 15 GALLON PITTOSPORUM	15 gallon size tree. (\$1,500.)

The existing site is less than 10,000 square feet total. Therefore, use of 15 gallon box size trees for canopy replacement plantings is allowable instead of the standard Town 24" box size replacement tree planting size rule.

1.1 Quick-View Single-Page Summary (Bullet Style) / 13 Trees in Study

1. Removals:

Tree 22 remove due to proximity to proposed residence. \$750 canopy replacement standard fee, plus applicable tree removal permit fees.

Tree 28 remove for safety, as a “high” risk no fee/no replacement tree per code.

Tree 32 remove due to proximity to proposed residence. \$1,000 canopy replacement standard fee, plus applicable tree removal permit fees.

Tree 33 remove due to proximity to proposed residence. \$1,500 canopy replacement standard fee, plus applicable tree removal permit fees.

2. Protect in Place (PIP):

All other trees are to be protected in place using the CTA’s red dashed lines on the tree map markup in section 12.0 of this report as basis for erection of chain link standard robust fencing throughout the entire demolition and construction periods. In most cases, the CTA attempted to show the root protection zone fence lines as red dashed lines drawn at or beyond each tree’s “critical root zone” offset radius, defined as 6 times the trunk diameter, measured horizontally outward from the trunk edge of each tree. **TREE PROTECTION SHOWN ON SITE PLAN PER THIS REPORT**

3. Trees to be Impacted by Site Work:

No impacts are expected to trees being protected in place, except possible required moderate airspace clearance pruning in the holly tree 30 and 31 canopy area where the canopies of these two trees currently extend far northward.

2.0 Assignment & Background

Walter Levison, Contract Town Arborist (CTA) was directed by Staff Planner Ryan Safty to visit the 116 Vallecitos site and assess all regulated size trees on or adjacent to the property.

The CTA was directed to tag, map, photograph, and record standard arboriculture data for regulated trees, and prepare a formalized written arborist report per Town of Los Gatos planning division standards.

The assessment was a ground-based visual assessment only.

Trees were tagged with racetrack shaped aluminum numbered tags at eye level.

Trees were noted by tag number on a tree map markup by the CTA, included in this report document. The map indicates utility alignments as magenta highlighted lines, new wall alignments as yellow highlighted lines, and suggested tree root protection zone chain link fencing alignments as red dashed lines. The background basis sheet used for the tree map markup is applicant sheet 4 of 19 “site plan” dated October, 2025.

Heights were either estimated or shot using a Nikon 550 Forestry Pro hypsometer/rangefinder.

Canopy spreads were estimated by pacing.

Diameters were determined (for on site trees) using a Spencer forestry tape which converts actual trunk circumference into a diameter readout, by dividing the circumference by Pi. The diameter is therefore a calculation conversion data point.

Digital images were archived by the CTA and included in this report.

All “non regulated” or “non protected” trees were excluded from this tree study, based on the Town of Los Gatos tree ordinance exceptions list in code section 29.10.0970. Trees excluded from this study can be removed or severely pruned without issuance of a Town tree removal permit. Refer to CTA arborist report section 3.0 below for a full list of exclusion tree species and sizes.

Site Note: The CTA’s assignment did not include determination of TRAQ risk rating(s) for regulated trees. However, for the purposes of this report, the CTA did prepare a rough rating for walnut tree 28, given that the presence of this tree in the landscape represents a known safety risk above background normal “low” risk to life or property. The CTA is recommending that this tree be removed for safety purposes as a no fee/no replacement “high risk” specimen per Town Code.

3.0 Town of Los Gatos – What Trees are Protected?

Per the most recent (2015) iteration of the Town of Los Gatos tree ordinance (Town Code Chapter 29 – Zoning Regulations, Article 1), the following regulations apply to all trees within the Town’s jurisdiction (wordage adjusted):

1. All trees with at least a single mainstem measuring four (4) inches diameter or greater at 4.5 feet above grade are considered “**Protected Trees**” when removal relates to any development review.
2. 12 inch diameter (18 inch multistem total) trees on developed residential property not currently subject to development review.
3. 8 inch diameter (8 inch multistem total) blue oak (*Quercus douglasii*), black oak (*Quercus kelloggii*), California buckeye (*Aesculus californica*), and Pacific madrone (*Arbutus menziesii*) on developed residential lots not currently subject to development review.
4. 8 inch diameter (8 inch multistem total) trees on developed residential property not currently subject to development review, on lots in the designated **Hillside Area** per the official Town map.



5. All trees with a single mainstem or sum of multiple mainstems totaling 48 inches diameter or greater at 4.5 feet above grade are considered “**Large Protected Trees**” (LPT).
6. All oak species (*Quercus spp.*), California buckeye (*Aesculus californica*), and Pacific madrone (*Arbutus menziesii*) with one or more mainstems totaling 24 inches diameter or more at 4.5 feet above grade are considered “**Large Protected Trees**” (LPT).
7. Section 29.10.0965. Prohibitions: A **permit** is required to prune, trim, cut off, or perform any work, on a single occasion or cumulatively, over a three-year period, affecting 25% or more of any **Protected Tree** (including below ground root system).
8. Section 29.10.0965. Prohibitions: A **permit** is required to prune, trim, or cut any branch or root greater than four (4) inches in diameter of a **Large Protected Tree**.
9. Section 29.10.0965. Prohibitions: A permit is required to conduct severe pruning on any protected tree. Severe pruning is defined in section 29.10.0955 as “topping or removal of foliage or significant scaffold limbs or large diameter branches so as to cause permanent damage and/or disfigurement of a tree, and/or which does not meet specific pruning goals and objectives as set forth in the current version of the International Society of Arboriculture Best Management Practices-Tree Pruning and ANSI A300-Part 1 Tree, Shrub, and Other Woody Plant Management-Standard Practices, (Pruning).”
10. Exceptions:

Severe Pruning Exception in Town Code section 29.10.1010(3) “.....except for pollarding of fruitless mulberry (*Morus alba*) or other species approved by the Town Arborist....”.

Protected Tree Exceptions:

- a. **Edible fruit or nut bearing trees less than 18 inches diameter (multistem total or single stem)**
 - b. *Acacia melanoxylon* (blackwood acacia) less than 24 inches (multistem total or single stem)
 - c. *Liriodendron tulipifera* (tulip tree) less than 24 inches (multistem total or single stem)
 - d. *Ailanthus altissima* (tree of heaven) less than 24 inches (multistem total or single stem)
 - e. *Eucalyptus globulus* (Tasmanian blue gum) less than 24 inches (multistem total or single stem)
 - f. *Eucalyptus camaldulensis* (River red gum) less than 24 inches (multistem total or single stem)
 - g. *Other eucalyptus species* (E. spp.) not noted above, less than 24 inches (multistem total or single stem)
- (REMOVAL O.K. ONLY AT HILLSIDE AREA LOCATIONS PER OFFICIAL TOWN MAP):**
www.losgatosca.gov/documentcenter/view/176
- h. All palm species (except *Phoenix canariensis*) less than 24 inches (multistem total or single stem)
 - i. *Ligustrum lucidum* (glossy privet) less than 24 inches (multistem total or single stem)

Note that per the exception in part ‘a’ above, fruiting olive trees with stems totaling less than 18 inches are considered non-protected.

4.0 Recommendations

4.01 PROJECT ARBORIST

Project Arborist (“PA”):

Initial Signoff

A third party ASCA registered consulting arborist or ISA Certified Arborist with extensive experience regarding tree protection during construction shall be retained by the applicant, to provide pre-project verification that tree protection and maintenance measures outlined in this section of the arborist report are adhered to. Periodic (e.g. monthly) inspections and summary reporting, if required as a project condition of approval, are suggested in order to verify contractor compliance with tree protection throughout the site plan project. This person will be referred to as the project arborist (“PA”). The PA should monitor soil moisture within the root protection zones of trees being retained, using a Lincoln soil moisture probe/meter or equivalent. If required, inspection reports shall be sent to Mr. Ryan Safty, Associate Planner, at rsafty@losgatosca.gov.

Sample wordage for a condition of approval regarding monitoring of tree protection and tree condition (subject to editing by the project planner):

“The required protective fencing shall remain in place until final landscaping (if applicable) and final Town inspection of the project. Project arborist approval must be obtained and documented in a monthly site tree activity report sent to the Town. The mandatory **Monthly Tree Activity Report** shall be sent electronically, at least once-monthly, to the Town planner associated with this project (rsafty@losgatosca.gov) beginning with the initial pre-demolition tree protection verification approval letter”.

SUGGESTIONS FOR TOWN STAFF:

4.1 ADJUSTMENTS TO AND CLARIFICATIONS OF THE APPLICANT’S PROPOSED PLAN SET TO OPTIMIZE LONG TERM TREE VIGOR AND STABILITY:

(REFER ALSO TO QUICK-VIEW SUMMARY SECTION 1.1 IN THIS REPORT)

- GAS PIPE: Adjust the gas pipe alignment to at least 6 feet offset from trunk edge of street tree #21, or use trenchless technology to bore the gas pipe underneath the tree’s root system at depth. **THIS IS NOTED ON SITE PLAN**
- PERIMETER WALL: Adjust the location of the property line wall near street tree #21 such that it is 10 feet offset from the trunk edge, or alternatively, build the wall as a floating system that uses an over-surface-grade beam suspended on vertical piers, such that the work is completely above existing soil surface grade elevation, thereby allowing the tree #21 lateral woody root system to be preserved in the area south of the tree.
NOTES ADDED TO SITE PLAN ABOUT FENCE NEAR THIS TREE

4.2 SECURITY BOND:

It is suggested that Town Staff condition this project on receiving security bond monetary funds from the applicant as a hedge against potential decline or death of one or more of the survey trees to remaining on-site or off-site in close proximity to the proposed site plan project. **UNDERSTOOD**

The Town tree ordinance indicates that the bond should be equivalent to \$5,000 per each single tree being preserved and protected in place, or a total of \$25,000, whichever is less. **UNDERSTOOD, OWNER WILL PAY TREE BOND BEFORE PERMIT GRANTED**

The proposed project scope of tree impact should invoke the **\$25,000 minimum tree security bond assessment**, given that greater than 5 regulated status trees are being retained at the project site.

4.3 CHAIN LINK PROTECTIVE FENCING FOR TREE PROTECTION ZONES (TPZ):

Prior to commencing site demolition, erect chain link fencing panels set on moveable concrete block footings. Wire the fence panels to iron layout stakes pounded 24 inches into the ground at the ends of each fence panel to keep the fence route stabilized and in its correct position. Do not wire the fence panels to the trunks of the trees.

Alternatively, use two-inch diameter iron tube posts driven 24 inches into the ground, at a spacing 8 feet on-center (O.C.), and hang chain link steel fencing on those posts. Both the chain link panel fence method and the “tube post with hung steel chain link fencing material” fence method of tree protection are acceptable. See images at right.



Protection shall be at the farthest possible offset distances from trees being protected in place. See the CTA’s tree map markup in section 12.0 of this report which indicates red dashed lines as suggested fence routes, which are shown as being offset to at least the calculated “critical root zone” distance from each tree, or a greater linear offset distance.

This fencing must be erected prior to any heavy machinery traffic or construction material arrival on site.

The protective fencing must not be temporarily moved during construction. No materials, tools, excavated soil, liquids, substances, etc. are to be placed or dumped, even temporarily, inside the root protection zone or “RPZ”.

No storage, staging, work, or other activities will be allowed inside the RPZ except with PA monitoring.
ADDED TO SITE PLAN



4.4 SIGNAGE:

The RPZ/TPZ fencing shall have one sign affixed with UV-stabilized zip ties to the chain link at eye level (minimum of one or two signs per each single tree being fenced), minimum 8”X11” size each, plastic laminated, with wordage that includes the Town Code section that refers to tree fence protection requirements (wordage can be adjusted):

**TREE PROTECTION ZONE FENCE
ZONA DE PROTECCION PARA ARBOLES**

**-NO ENTRE SIN PERMISO-
-LLAME EL ARBOLISTA-**

**REMOVAL OF THIS FENCE IS
SUBJECT TO PENALTY ACCORDING TO
LOS GATOS TOWN CODE 29.10.1025**

**PROJECT ARBORIST:
TELEFONO CELL:**

EMAIL:

NOTE: THE CTA IS NOT THE “PROJECT ARBORIST”.

The project arborist is a private arborist contracted by the applicant or applicant’s team of professionals who then monitors the project and reports to Town of Los Gatos planning division on a monthly basis with written tree condition and tree protection inspection reports submitted to Planning Staff per planning division conditions of project approval (COPA).

ADDED TO SITE PLAN

4.5 TRUNK BUFFER WRAP SPECIFICATION:

Per the sample image at right, wrap at least two (2) or three (3) entire rolls of orange plastic snow fencing around the lowermost six feet of the trunk of **every tree** proposed to be protected in place on-site, unless otherwise noted in the list of trees below.

Wrap between zero feet (grade elevation) and 6 feet elevation above grade).

For added protection, place wooden boards over the **OUTSIDE** of the orange plastic, and duct tape them in place (do **not** use wires to secure the boards).

Important: Wood boards must be placed last, over the **OUTSIDE** of the orange plastic.

Trees to wrap:

Trees in relatively close proximity to proposed new work, such as trees 21, 30, and 31, where TPZ fencing will only be offset by 10 feet radius (trees 30 and 31), or where no TPZ will be able to be erected at all (tree 21).

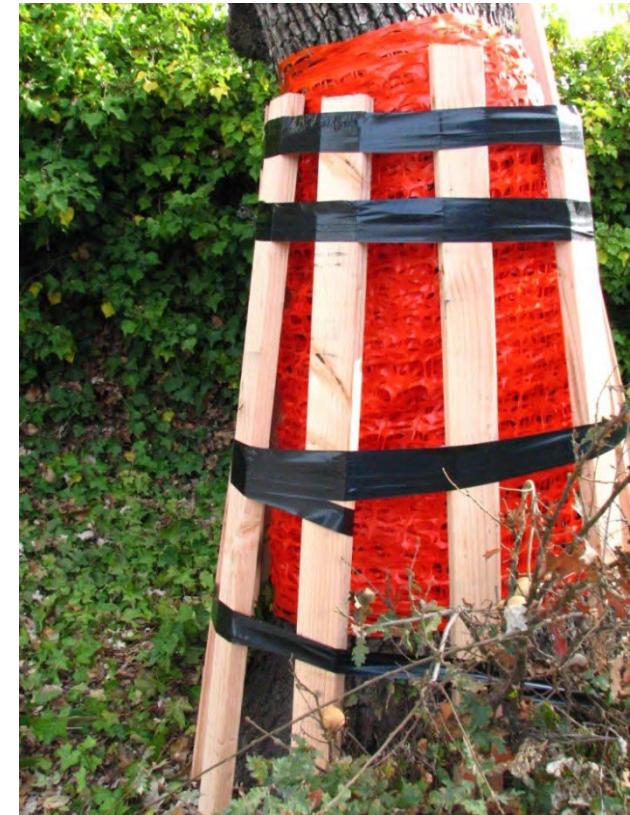

4.6 IRRIGATION TEMPORARY:

Irrigate **trees 23, 24, 25, 26, 27, 29, 30, 31.**

1x/month.

Volume of Water Application (Can be Adjusted As-Needed): 200 to 300 gallons total for all of the above trees combined.

Irrigation can be achieved through use of a tow-behind water tank (see image at right), domestic spigot with garden hose, and/or other means.

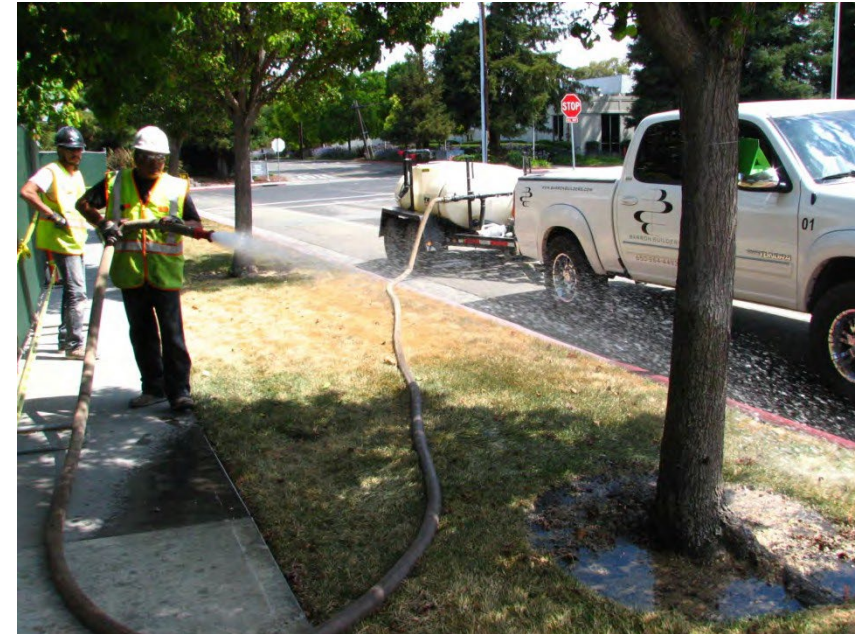

4.7 ROOT PRUNING:

When roots are unearthed measuring greater than 1.0 inches diameter each during proposed site work within 25 feet of any tree being preserved and protected in place, proceed to prune those roots using a Sawzall or other brand of reticulating saw, using a blade designed specifically for “green wood pruning” or “wood” or “pruning” (see images below and right).

Sever roots at right angles to root growth direction.

Immediately (same day) smear wet mud on the cut ends of the roots, and bury ASAP, preferably within 48 hours of severing.

Backfill within 48 hours of root severing if possible.

Saturate the roots with water as soon as possible, preferably the same day as root pruning.

Saturate the soil profile down to 24 inches below soil surface grade elevations.

NOTE: If a root is shattered, broken, or otherwise damaged, with visible damage to the bark, then dig out the damaged section of root until the original undamaged root is visible, and proceed to cut out all damaged portions of the root(s) when the final clean cut is performed with a Sawzall. This is called “back digging” (see image at right, showing a clean cut being performed after first back-digging all around the root to expose undamaged root material).



4.8 TREE REMOVALS / FEES:

As noted above in this report, trees 22, 32, and 33 are expected to be removed due to their locations in close proximity to the proposed new residence exterior.

The tree canopy replacement loss fee for these two trees is **\$3,250**, plus any applicable tree removal permit application fees to be determined by Staff.

Tree 28, the 4th removal of 4 total tree specimens to be removed, is suggested by the CTA to be removed as a “no removal permit fee / no mitigation planting” removal, per Town Code 29.10.0985, for safety purposes. The tree is deemed a high risk tree specimen in terms of risk of tree or tree part failure and impact with persons or property, causing significant damage.

4.9 TREE MAINTENANCE / AIRSPACE CLEARANCE PRUNING:

Holly trees 30 and 31 may require airspace clearance of unknown degree or severity, to clear the proposed new residence and a construction corridor of estimated 5 foot width along the south side of the residence exterior siding. If possible, use cuts of less than or equal to 2 inches diameter each when performing stem length reduction cuts on the stems that extend northward toward the proposed residence footprint.

See the following page of this report for pruning spec images.

STANDARDS :All pruning shall conform to the most current iterations of **ANSI-A300 tree, shrub, and other woody plant maintenance / standard practices / pruning**.

SITE SUPERVISOR: An **ISA-Certified Arborist** retained by the tree care company performing the work will need to be present to oversee and actively supervise the 116 Vallecitos airspace stem length reduction pruning cut work. Side note: most consulting arborists cannot directly supervise this type of work, due to the California requirement that a tree care supervisor be associated with a company holding the new **C-49 Tree and Palm Contractor License** classification, issued by the **California State License Board (CSLB)**.

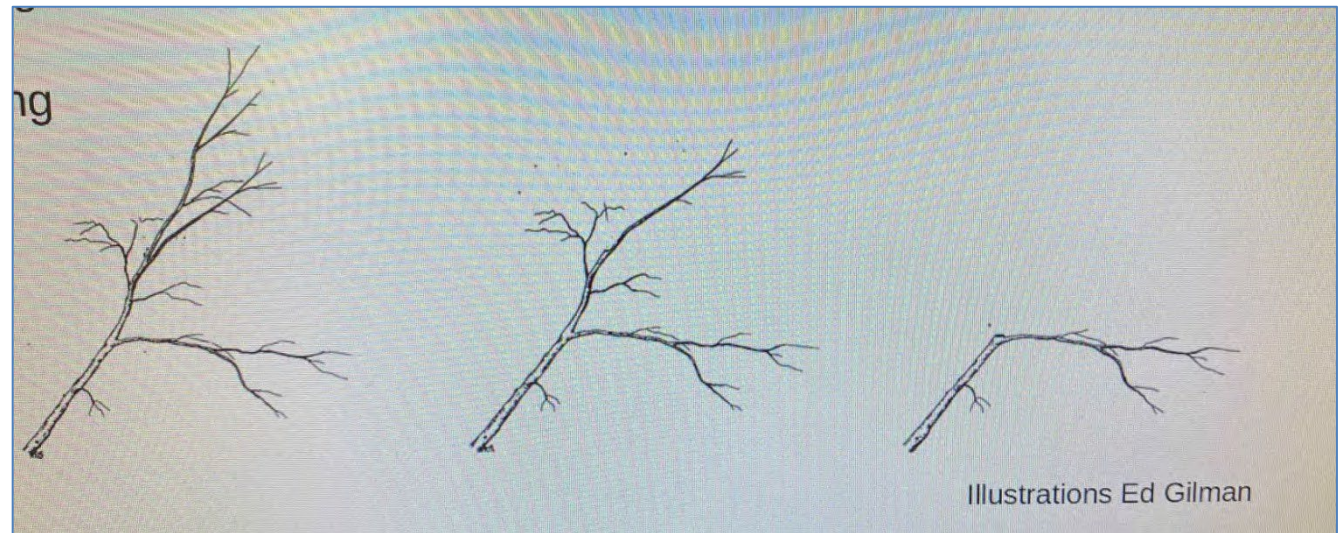

Above Right:

Sketches showing correct stem length reduction pruning or “**endweight reduction pruning**”.

- The stem at left is unpruned.
- The stem in the center of the image has received minor stem length reduction pruning.
- The stem at the right has received heavy stem length reduction pruning, and was redirectionalized to the right as a result.

Below right:

Mike Wilson’s excellent illustration that shows how a “three-step cut” is performed, per ANSI A300 standards, in order to avoid a stem tearout or a stem peel situation, which can be permanently damaging to a tree.

- The 1st cut is an undercut.
- The 2nd cut occurs above and slightly beyond the first cut in terms of its position away from the main trunk, which allows the stem to break off downward with gravity, without any tearing or peeling of bark or wood.
- The 3rd cut is the final finish cut at the tree branch collar where the stem interfaces with the main trunk.



4.10 STREET TREE 21 / GAS PIPE DIRECTIONAL BORE:

If the alignment of the proposed new gas pipe line cannot be adjusted to 6 feet offset from street tree 21, then install it using a trenchless technique such as **directional bore** (see sample image below right).



4.11 STREET TREE 21 / PERIMETER WALL ALTERNATIVE CONSTRUCTION METHOD “ABOVE-GRADE”:

If the alignment of the proposed new property line structural wall at the streetside of front yard cannot be adjusted to 10 feet offset distance from the trunk edge of street tree 21, then either:

- A. Redesign the wall to be a non-structural wall with no excavation work required below existing soil grade, other than vertical piers, or
- B. Redesign the wall to be a structural wall with a floating “over-grade” beam that is built completely over existing soil surface grade elevation, suspended or otherwise stitched to vertical drilled pier supports, in order to allow for the majority of the tree 21 lateral woody roots to remain as-is below grade, in the front yard area between zero (0) feet and ten (10) feet south of the tree trunk (mainstem).

At right is a sample image showing a real world example of such a floating beam at a site project for which Walter Levison consulted as the project arborist. The project team created this compromise solution to the tree root preservation issue at hand, by showing a grade beam embedment of only two (2) inches below existing soil surface elevation, thereby causing very minimal loss of or damage to tree roots. The plan also indicates a pier separation of “12 feet on center”, which is moderately good in terms of allowing for nearby tree lateral woody roots to be retained and preserved in place, because it allows for roots to remain in between the pier locations.

Note that this plan was created for a single family residence structural foundation. The wall at 116 Vallecitos may require less robust engineering than that shown at right. Optimally, the Vallecitos site should strive for a structural pier diameter of 10 or 12 inches, and a structural pier horizontal separation of 12 to 18 feet on center, for good or very good tree root retention.

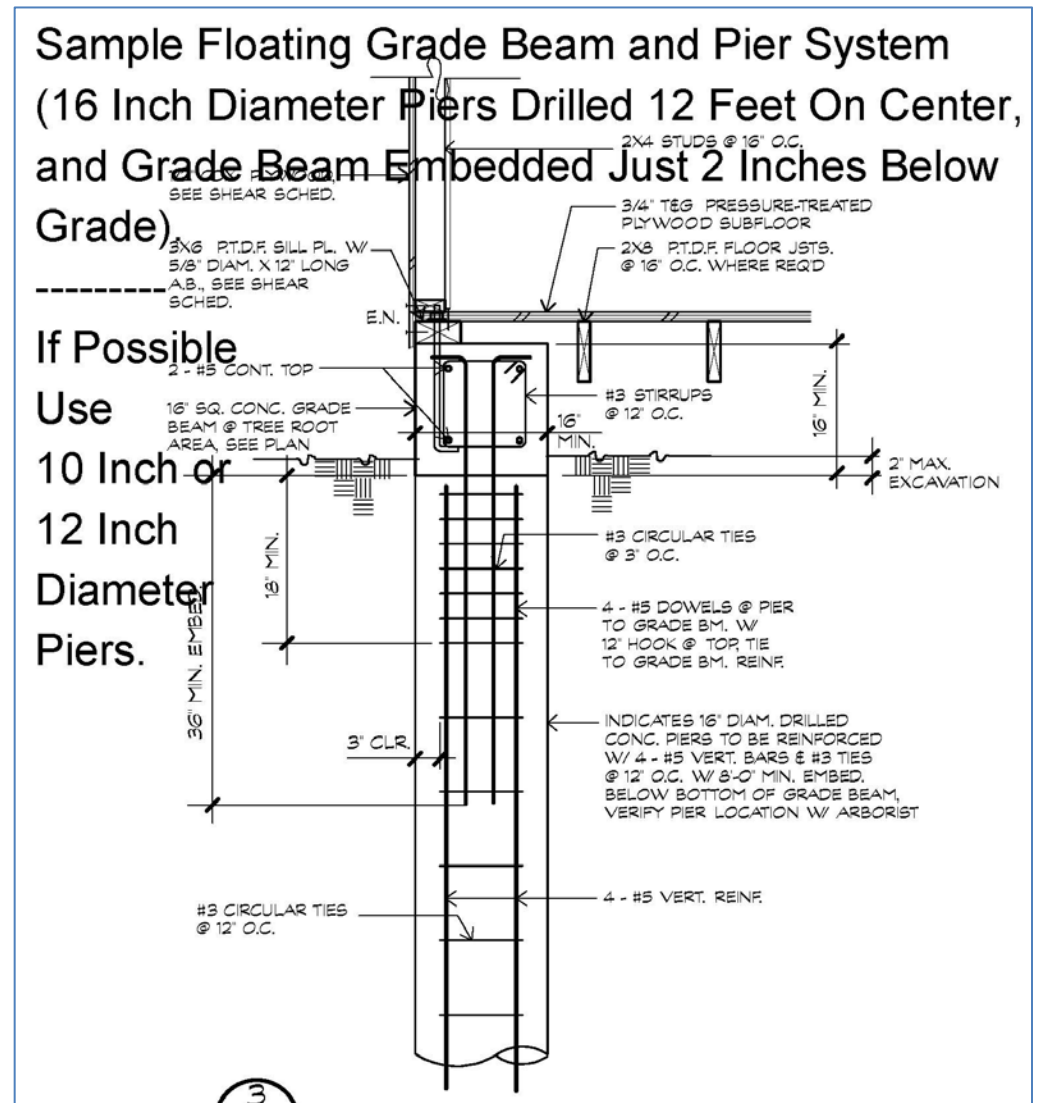

5.0 Tree Protection and Maintenance Directions per Town Code

The following is excerpted directly from the 2015 iteration of the Town of Los Gatos tree ordinance sections which provide specific tree protection directions and limitations on root pruning and above-ground pruning:

Sec. 29.10.1000. New property development.

(a) A tree survey shall be conducted prior to submittal of any development application proposing the removal of or impact to one or more protected trees. The development application shall include a Tree Survey Plan and Tree Preservation Report based on this survey. The tree survey inventory numbers shall correspond to a numbered metal tag placed on each tree on site during the tree survey. The tree survey plan shall be prepared by a certified or consulting arborist, and shall include the following information:

- (1) Location of all existing trees on the property as described in section 29.10.0995;
- (2) Identify all trees that could potentially be affected by the project (directly or indirectly- immediately or in long term), such as upslope grading or compaction outside of the dripline;
- (3) Notation of all trees classified as protected trees;
- (4) In addition, for trees four (4) inches in diameter or larger, the plan shall specify the precise location of the trunk and crown spread, and the species, size (diameter, height, crown spread) and condition of the tree.

(b) The tree survey plan shall be reviewed by the Town's consulting arborist who shall, after making a field visit to the property, indicate in writing or as shown on approved plans, which trees are recommended for preservation (based on a retention rating of high/moderate/low) using, as a minimum, the Standards of Review set forth in section 29.10.0990. This plan shall be made part of the staff report to the Town reviewing body upon its consideration of the application for new property development;

(c) When development impacts are within the dripline of or will affect any protected tree, the applicant shall provide a tree preservation report prepared by a certified or consulting arborist. The report, based on the findings of the tree survey plan and other relevant information, shall be used to determine the health and structure of existing trees, the effects of the proposed development and vegetation removal upon the trees, recommendations for specific precautions necessary for their preservation during all phases of development (demolition, grading, during construction, landscaping); and shall also indicate which trees are proposed for removal. The tree preservation report shall stipulate a required tree protection zone (TPZ) for trees to be retained, including street trees, protected trees and trees whose canopies are hanging over the project site from adjacent properties. The TPZ shall be fenced as specified in section 29.10.1005:

- (1) The final approved tree preservation report shall be included in the building permit set of development plans and printed on a sheet titled: Tree Preservation Instructions (Sheet T-1). Sheet T-1 shall be referenced on all relevant sheets (civil, demolition, utility, landscape, irrigation) where tree impacts from improvements may be shown to occur;
- (2) The Town reviewing body through its site and design plan review shall endeavor to protect all trees recommended for preservation by the Town's consulting arborist. The Town reviewing body may determine if any of the trees recommended for preservation should be removed, if based upon the evidence submitted the reviewing body determines that due to special site grading or other unusual characteristics associated with the property, the preservation of the tree(s) would significantly preclude feasible development of the property as described in

section 29.10.0990;

- (3) Approval of final site or landscape plans by the appropriate Town reviewing body shall comply with the following requirements and conditions of approval:
- a. The applicant shall, within ninety (90) days of final approval or prior to issuance of a grading or building permit, whichever occurs first, secure an appraisal of the condition and value of all trees included in the tree report affected by the development that are required to remain within the development using the Tree Value Standard methodology as set forth in this Chapter. The appraisal of each tree shall recognize the location of the tree in the proposed development. The appraisal shall be performed in accordance with the current edition of the Guide for Plant Appraisal published by the Council of Tree and Landscape Appraisers (CTLA) and the Species and Group Classification Guide published by the Western Chapter of the International Society of Arboriculture. The appraisal shall be performed at the applicant's expense, and the appraisal shall be subject to the Director's approval.
 - b. The site or landscape plans shall indicate which trees are to be removed. However, the plans do not constitute approval to remove a tree until a separate permit is granted. The property owner or applicant shall obtain a protected tree removal permit, as outlined in section 29.10.0980, for each tree to be removed to satisfy the purpose of this division.
- (d) Prior to acceptance of proposed development or subdivision improvements, the developer shall submit to the Director a final tree preservation report prepared by a certified or consulting arborist. This report shall consider all trees that were to remain within the development. The report shall note the trees' health in relation to the initially reported condition of the trees and shall note any changes in the trees' numbers or physical conditions. The applicant will then be responsible for the loss of any tree not previously approved for removal. For protected trees, which were removed, the developer shall pay a penalty in the amount of the appraised value of such tree in addition to replacement requirements contained in section 29.10.0985 of this Code. The applicant shall remain responsible for the health and survival of all trees within the development for a period of five (5) years following acceptance of the public improvements of the development or certificate of occupancy.
- (e) Prior to issuance of any demolition, grading or building permit, the applicant or contractor shall submit to the Building Department a written statement and photographs verifying that the required tree protection fence is installed around street trees and protected trees in accordance with the tree preservation report.
- (f) If required by the Director and conditioned as part of a discretionary approval, a security guarantee shall be provided to the Town. Prior to the issuance of any permit allowing construction to begin, the applicant shall post cash, bond or other security satisfactory to the Director, in the penal sum of five thousand dollars (\$5,000.00) for each tree required to be preserved, or twenty-five thousand dollars (\$25,000.00), whichever is less. The cash, bond or other security shall be retained for a period of one (1) year following acceptance of the public improvements for the development and shall be forfeited in an amount equal to five thousand dollars (\$5,000.00) per tree as a civil penalty in the event that a tree or trees required to be preserved are removed, destroyed or severely damaged.
- (g) An applicant with a proposed development which requires underground utilities shall avoid the installation of said utilities within the dripline of existing trees whenever possible. In the event that this is unavoidable, all trenching shall be done using directional boring, air-spade excavation or by hand, taking extreme caution to avoid damage to the root structure. Work within the dripline of existing trees shall be supervised at all times by a certified or consulting arborist.
- (h) It shall be a violation of this division for any property owner or agent of the owner to fail to comply with any development approval condition concerning preservation, protection, and maintenance of any protected tree.

(Ord. No. 2114, §§ I, II, 8-4-03)

Sec. 29.10.1005. Protection of trees during construction.

(a) Protective tree fencing shall specify the following:

- (1) Size and materials. Six (6) foot high chain link fencing, mounted on two-inch diameter galvanized iron posts, shall be driven into the ground to a depth of at least two (2) feet at no more than 10-foot spacing. For paving area that will not be demolished and when stipulated in a tree preservation plan, posts may be supported by a concrete base.
- (2) Area type to be fenced. Type I: Enclosure with chain link fencing of either the entire dripline area or at the tree protection zone (TPZ), when specified by a certified or consulting arborist. Type II: Enclosure for street trees located in a planter strip: chain link fence around the entire planter strip to the outer branches. Type III: Protection for a tree located in a small planter cutout only (such as downtown): orange plastic fencing shall be wrapped around the trunk from the ground to the first branch with 2-inch wooden boards bound securely on the outside. Caution shall be used to avoid damaging any bark or branches.
- (3) Duration of Type I, II, III fencing. Fencing shall be erected before demolition, grading or construction permits are issued and remain in place until the work is completed. Contractor shall first obtain the approval of the project arborist on record prior to removing a tree protection fence.
- (4) Warning sign. Each tree fence shall have prominently displayed an 8.5 x 11-inch sign stating: "Warning—Tree Protection Zone-this fence shall not be removed and is subject to penalty according to Town Code 29.10.1025".

(b) All persons, shall comply with the following precautions:

- (1) Prior to the commencement of construction, install the fence at the dripline, or tree protection zone (TPZ) when specified in an approved arborist report, around any tree and/or vegetation to be retained which could be affected by the construction and prohibit any storage of construction materials or other materials, equipment cleaning, or parking of vehicles within the TPZ. The dripline shall not be altered in any way so as to increase the encroachment of the construction.
- (2) Prohibit all construction activities within the TPZ, including but not limited to: excavation, grading, drainage and leveling within the dripline of the tree unless approved by the Director.
- (3) Prohibit disposal or depositing of oil, gasoline, chemicals or other harmful materials within the dripline of or in drainage channels, swales or areas that may lead to the dripline of a protected tree.
- (4) Prohibit the attachment of wires, signs or ropes to any protected tree.
- (5) Design utility services and irrigation lines to be located outside of the dripline when feasible.
- (6) Retain the services of a certified or consulting arborist who shall serve as the project arborist for periodic monitoring of the project site and the health of those trees to be preserved. The project arborist shall be present whenever activities occur which may pose a potential threat to the health of the trees to be preserved and shall document all site visits. **UNDERSTOOD AND THIS NOTE IS ADDED TO SITE PLAN**
- (7) The Director and project arborist shall be notified of any damage that occurs to a protected tree during construction so that proper treatment may

be administered.

(Ord. No. 2114, §§ I, II, 8-4-03)

Sec. 29.10.1010. Pruning and maintenance.

All pruning shall be in accordance with the current version of the International Society of Arboriculture Best Management Practices—Tree Pruning and ANSI A300-Part 1 Tree, Shrub and Other Woody Plant Management—Standard Practices, (Pruning) and any special conditions as determined by the Director. For developments, which require a tree preservation report, a certified or consulting arborist shall be in reasonable charge of all activities involving protected trees, including pruning, cabling and any other work if specified.

- (1) Any public utility installing or maintaining any overhead wires or underground pipes or conduits in the vicinity of a protected tree shall obtain permission from the Director before performing any work, including pruning, which may cause injury to a protected tree. (e.g. cable TV/fiber optic trenching, gas, water, sewer trench, etc.).
- (2) Pruning for clearance of utility lines and energized conductors shall be performed in compliance with the current version of the American National Standards Institute (ANSI) A300 (Part 1)- Pruning, Section 5.9 Utility Pruning. Using spikes or gaffs when pruning, except where no other alternative is available, is prohibited.
- (3) No person shall prune, trim, cut off, or perform any work, on a single occasion or cumulatively, over a three-year period, affecting twenty-five percent or more of the crown of any protected tree without first obtaining a permit pursuant to this division except for pollarding of fruitless mulberry trees (*Morus alba*) or other species approved by the Town Arborist. Applications for a pruning permit shall include photographs indicating where pruning is proposed.
- (4) No person shall remove any Heritage tree or large protected tree branch or root through pruning or other method greater than four (4) inches in diameter (12.5" in circumference) without first obtaining a permit pursuant to this division.

(Ord. No. 2114, §§ I, II, 8-4-03)

6.0 Tree Replacement Standards & Fees – Los Gatos Town Code and 2025 Fee Schedule

2025 Town of Los Gatos Tree Removal/Damage In-Lieu Fees:

- a. \$250 or \$125 tree removal application permit fee per each tree to be removed, and
- b. Tree cost for each 24" box size tree will be the "market price plus the installation cost, as determined by the Director" (2025 Town of Los Gatos Fee Schedule). Typical Bay Area installed cost of a 24" box size tree is roughly 3 times the wholesale price, which is roughly \$250 x 3 = \$750/tree as of 2025, per the CTA's communication with various tree installation service providers. Thus, the fee schedule per Town of Los Gatos is contrary to the actual "market price" (installed cost) of a 24" box size tree, which is more on the order of \$750 per each single 24" box size tree: a difference of 300% between expected actual 2025/2026 "market price" versus the in-lieu fee of \$250 established as a per-tree fee by the Town as of 2025. Refer to the snippet below from the Town's Fee Schedule.

Tree Related Fees

24	Tree Removal Permit Application*	One Tree \$250.00
		Additional Tree \$125.00/each
		If application is denied 50% refund
25	Illegal Tree Removal Administrative Fee	\$330.00
26	Replacement Trees - Town Forestry Fund Per Tree Ordinance Section 29.10.0985	Tree cost for each 24", 36", and/or 48" box size will be the Market Price plus the installation cost, determined by the Director

****Fee will be waived if tree removal is done to implement or maintain Defensible Space.***

(Below text is excerpted from [Private Trees | The Los Gatos CA Official Site!](#)):

Tree Related Fees

\$250 - Tree Removal (One tree)

\$125 - Tree Removal (Each additional tree on same application)

If application is denied, 50% refund

\$330 - Illegal Tree Removal Administrative Fee

\$250 for each 15 gallon and each 24" Box Size Replacement Tree In-Lieu Fee*

\$500 for each 36" Box Replacement Tree In-Lieu Fee*

Tree Replacement Requirements

A condition of a tree removal permit requires two or more replacement trees, of a species and size designated by the Town, be planted on the subject private property. Table 3-1, Tree Canopy-Replacement Standard of the Town Code shall be used as a basis for this requirement. The person requesting the permit shall pay the cost of purchasing and planting the replacement trees.

Replacement trees shall be approved by the Town Arborist and shall be of a species suited to the available planting location, proximity to structures, overhead clearances, soil type, compatibility with surrounding canopy and other relevant factors. Replacement with native species shall be strongly encouraged. Most fruit and nut trees, palm trees, or "nuisance" species are generally not considered suitable replacement trees. Section 29.10.0970(2) of the Town Code lists nuisance species.

Replacement requirements in the Hillside shall comply with the Hillside Development Standards and Guidelines Appendix A and Section 29.10.0987 Special Provisions-Hillside.

Single Family Residential Replacement Option is available for developed single family residential lots under ten thousand (10,000) square feet that are not subject to the Town's Hillside Development Standards and Guidelines. All 15-gallon trees must be planted on-site. Any in-lieu fees for single family residential shall be based on 24" box tree rates.

*If a tree or trees cannot be reasonably planted on the subject property and approved by the Town Arborist, a Replacement Tree In-Lieu Fee shall be paid to the Town Tree Replacement Fund to:

- a. Add or replace trees on public property in the vicinity of the subject property; or
- b. Add or replace trees or landscaping on other Town property; or
- c. Support the Town's urban forestry management program.

Permits are valid for 90 days and replacement trees must be planted on the property prior to the permit expiration, unless the removal and replacements are part of an approved development application. Permits which include Replacement Tree In-Lieu fees will not be approved until all fees are paid in full.

(Excerpted from Town Code 29.10.0985 and 29.10.0987)

- (1) Two (2) or more replacement trees, of a species and size designated by the Director, shall be planted on the subject private property. Table 3-1 The Tree Canopy—Replacement Standard shall be used as a basis for this requirement. The person requesting the permit shall pay the cost of purchasing and planting the replacement trees.
- (2) If a tree or trees cannot be reasonably planted on the subject property, an in-lieu payment in an amount set forth by the Town Council by resolution shall be paid to the Town Tree Replacement Fund to:
 - a. Add or replace trees on public property in the vicinity of the subject property; or
 - b. Add or replace trees or landscaping on other Town property; or
 - c. Support the Town’s urban forestry management program. (Ord. No. 2114, §§ I, II, 8-4-03)

Table 3-1 - Tree Canopy - Replacement Standard

Canopy Size of Removed Tree ¹	(Staff is using 24” box size as the Replacement Standard for SFR Projects as of 2016) ^{2,4}	Single Family Residential Replacement ^{3,4}
10 feet or less	Two 24 inch box trees	Two 15 gallon trees
More than 10 feet to 25 feet	Three 24 inch box trees	Three 15 gallon trees
More than 25 feet to 40 feet	Four 24 inch box trees; or Two 36 inch box trees	Four 15 gallon trees
More than 40 feet to 55 feet	Six 24 inch box trees; or Three 36 inch box trees	Not Available
Greater than 55 feet	Ten 24 inch box trees; or Five 36 inch box trees	Not Available

Notes

- ¹To measure an asymmetrical canopy of a tree, the widest measurement shall be used to determine canopy size.
- ²Often, it is not possible to replace a single large, older tree with an equivalent tree(s). In this case, the tree may be replaced with a combination of both the Tree Canopy Replacement Standard and in-lieu payment in an amount set forth by Town Council resolution paid to the Town Tree Replacement Fund.
- ³Single Family Residential Replacement Option is available for developed single family residential lots under 10,000 square feet that are not subject to the Town's Hillside Development Standards and Guidelines. All 15-gallon trees must be planted on-site. Any in-lieu fees for single family residential shall be based on 24" box tree rates as adopted by Town Council.
- ⁴Replacement Trees shall be approved by the Town Arborist and shall be of a species suited to the available planting location, proximity to structures, overhead clearances, soil type, compatibility with surrounding canopy and other relevant factors. Replacement with native species shall be strongly encouraged. Replacement requirements in the Hillside Development Standards and Guidelines Appendix A and Section 29.10.0987 Special Provisions--Hillsides.

Sec. 29.10.0987. Special Provisions—Hillsides

The Town of Los Gatos recognizes its hillsides as an important natural resource and sensitive habitat which is also a key component of the Town's identity, character and charm. In order to maintain and encourage restoration of the hillside environment to its natural state, the Town has established the following special provisions for tree removal and replacement in the hillsides:

- (1) All protected trees located 30 or more feet from the primary residence that are removed shall be replaced with native trees listed in *Appendix A Recommended Native Trees for Hillside Areas of the Town of Los Gatos Hillside Development Standards and Guidelines* (HDS&G).
- (2) All protected trees located within 30 feet of the primary residence that are removed shall be replaced as follows:
 - (a) If the removed tree is a native tree listed in Appendix A of the HDS&G, it shall only be replaced with a native tree listed in Appendix A of the HDS&G.
 - (b) If the removed tree is not listed in Appendix A, it may be replaced with a tree listed in Appendix A, or replaced with another species of tree as approved by the Director.
 - (c) Replacement trees listed in Appendix A may be planted anywhere on the property.
 - (d) Replacement trees not listed in Appendix A may only be planted within 30 feet of the primary residence.
- (3) Replacement requirements shall comply with the requirements in Table 3-1 Tree Canopy Replacement Standard of this Code.
- (4) Property owners should be encouraged to retain dead or declining trees where they do not pose a safety or fire hazard, in order to foster wildlife habitat and the natural renewal of the hillside environment.

7.0 Author's Qualifications (Partial)

- Continued education through The American Society of Consulting Arborists, The International Society of Arboriculture (Western Chapter), and various governmental and non-governmental entities.
- Contract Town Arborist, Town of Los Gatos, California
Community Development Department / Planning Division
2015-present
- Tree Risk Assessment Qualified (ISA TRAQ Course Graduate, Palo Alto, California)
- Millbrae Community Preservation Commission (Tree Board)
2001-2006
- ASCA Registered Consulting Arborist (RCA) #401
- ASCA Arboriculture Consulting Academy graduate, class of 2000
- Associate Consulting Arborist
Barrie D. Coate and Associates
4/99-8/99
- Contract City Arborist, City of Belmont, California
Planning and Community Development Department
5/1999-5/2020 (21 years)
- ISA Certified Arborist #WE-3172A since 1996.
- Peace Corps Soil and Water Conservation Extension Agent
Chiangmai Province, Thailand 1991-1993
- B.A. Environmental Studies/Soil and Water Resources
UC Santa Cruz, Santa Cruz, California 1990

UCSC Chancellor's Award, 1990

(My full curriculum vitae is available upon request)

8.0 Assumptions and Limiting Conditions

Any legal description provided to the consultant/appraiser is assumed to be correct. Any titles and ownership to any property are assumed to be good and marketable. No responsibility is assumed for matters legal in character. Any and all property is appraised and evaluated as through free and clean, under responsible ownership and competent management.

It is assumed that any property is not in violation of any applicable codes, ordinance, statutes, or other government regulations.

Care has been taken to obtain all information from reliable sources. All data has been verified insofar as possible; however, the consultant/appraiser can neither guarantee nor be responsible for the accuracy of information provided by others.

The consultant/appraiser shall not be required to give testimony or to attend court by reason of this report unless subsequent contractual arrangements are made, including payment of an additional fee for such services as described in the fee schedule and contract of engagement.

Unless required by law otherwise, the possession of this report or a copy thereof does not imply right of publication or use for any other purpose by any other than the person to whom it is addressed, without the prior expressed written or verbal consent of the consultant/appraiser.

Unless required by law otherwise, neither all nor any part of the contents of this report, nor copy thereof, shall be conveyed by anyone, including the client, to the public through advertising, public relations, news, sales, or other media, without the prior expressed conclusions, identity of the consultant/appraiser, or any reference to any professional society or institute or to any initiated designation conferred upon the consultant/appraiser as stated in his qualifications.

This report and any values expressed herein represent the opinion of the consultant/appraiser, and the consultant's/appraiser's fee is in no way contingent upon the reporting of a specified value, a stipulated result, the occurrence of a subsequent event, nor upon any finding to be reported.

Sketches, drawings, and photographs in this report, being intended for visual aids, are not necessarily to scale and should not be construed as engineering or architectural reports or surveys unless expressed otherwise. The reproduction of any information generated by engineers, architects, or other consultants on any sketches, drawings, or photographs is for the express purpose of coordination and ease of reference only. Inclusion of said information on any drawings or other documents does not constitute a representation by Walter Levison to the sufficiency or accuracy of said information.

Unless expressed otherwise:

- a. information contained in this report covers only those items that were examined and reflects the conditions of those items at the time of inspection; and
- b. the inspection is limited to visual examination of accessible items without dissection, excavation, probing, or coring. There is no warranty or guarantee, expressed or implied, that problems or deficiencies of the plants or property in question may not arise in the future.

Loss or alteration of any part of this report invalidates the entire report.

Arborist Disclosure Statement:

Arborists are tree specialists who use their education, knowledge, training, and experience to examine trees, recommend measures to enhance the beauty and health of trees, and attempt to reduce the risk of living near trees. Clients may choose to accept or disregard the recommendations of the arborist, or to seek additional advice.

Arborists cannot detect every condition that could possibly lead to the structural failure of a tree. Trees are living organisms that fail in ways we do not fully understand. Conditions are often hidden within trees and below ground. Arborist cannot guarantee that a tree will be healthy or safe under all circumstances, or for a specified period of time. Likewise, remedial treatments, like any medicine, cannot be guaranteed.

Treatment, pruning, and removal of trees may involve considerations beyond the scope of the arborist's services such as property boundaries, property ownership, site lines, disputes between neighbors, and other issues. Arborists cannot take such considerations into account unless complete and accurate information is disclosed to the arborist. An arborist should then be expected to reasonably rely upon the completeness and accuracy of the information provided.

Trees can be managed, but they cannot be controlled. To live near trees is to accept some degree of risk. The only way to eliminate all risk associated with trees is to eliminate the trees.

9.0 Certification

I hereby certify that all the statements of fact in this report are true, complete, and correct to the best of my knowledge and belief, and are made in good faith.



Signature of Consultant

DIGITAL BADGES:

ISA CERTIFIED ARBORIST CREDENTIAL:

https://certificates.isa-arbor.com/f1918723-df46-48cc-ace2-c12625530fec?record_view=true

ISA TREE RISK ASSESSMENT QUALIFIED (TRAQ):

https://certificates.isa-arbor.com/d180515f-ab75-440b-9c66-106005e3cf10?record_view=true#gs.hpb30w

10.0 Digital Images

Trees are noted by numeric tag numbers "21" through "33" below in the table.



21



21



22

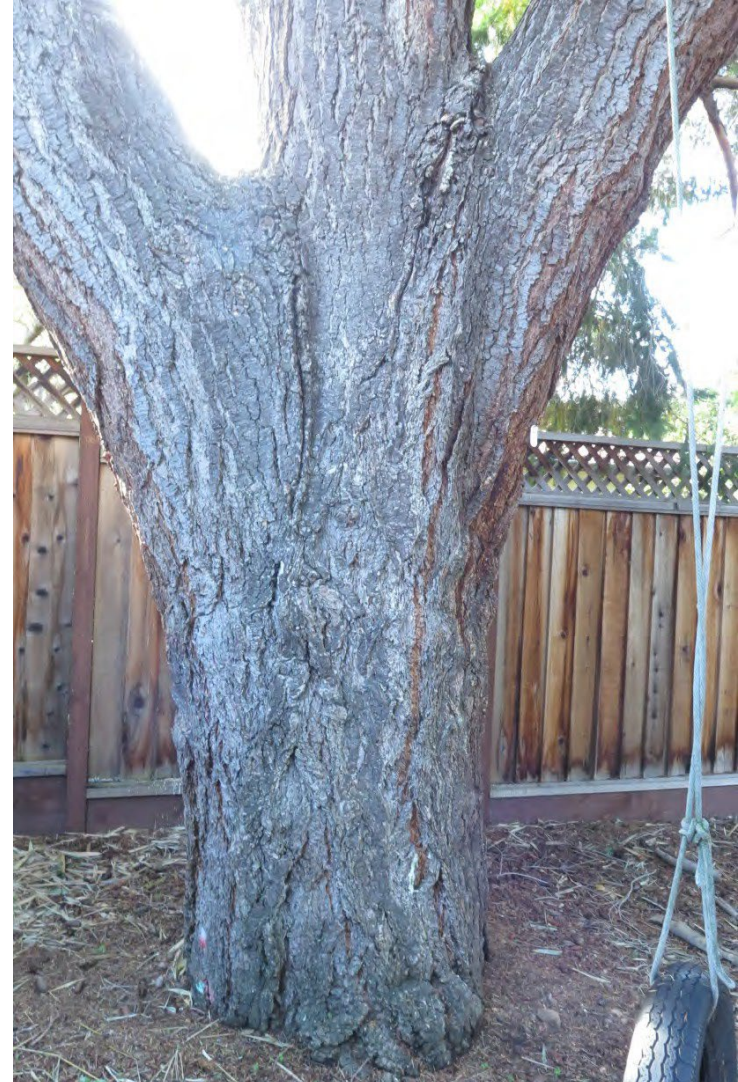

23



23



23



23



24



25



25

Close up of Eugenia psyllid insect that causes decline of and death of tree portions, including severe leaf distortion, resulting in loss of vigor and longevity of this tree, as well as reduced aesthetics.

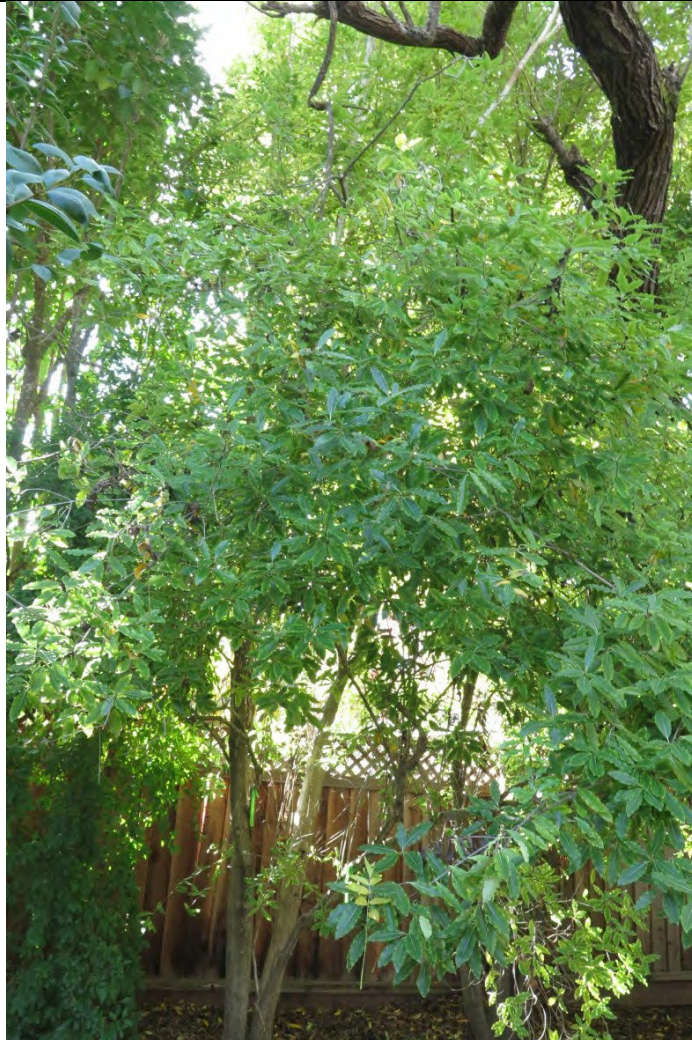

26

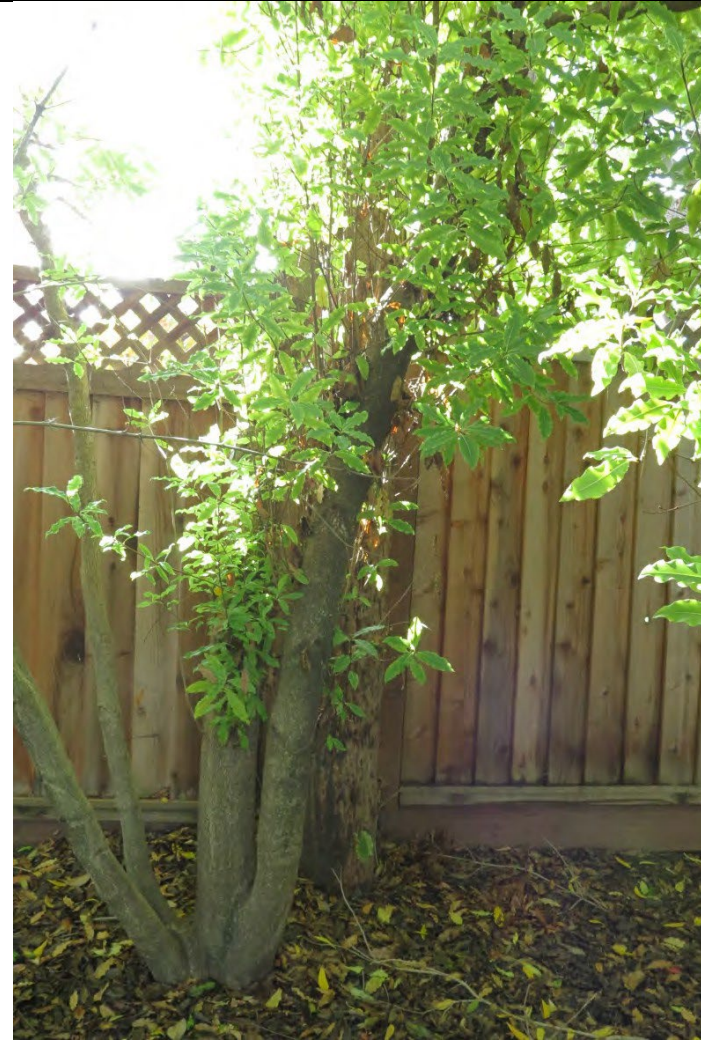

27



28

Wood tissue decay of a very advanced degree.

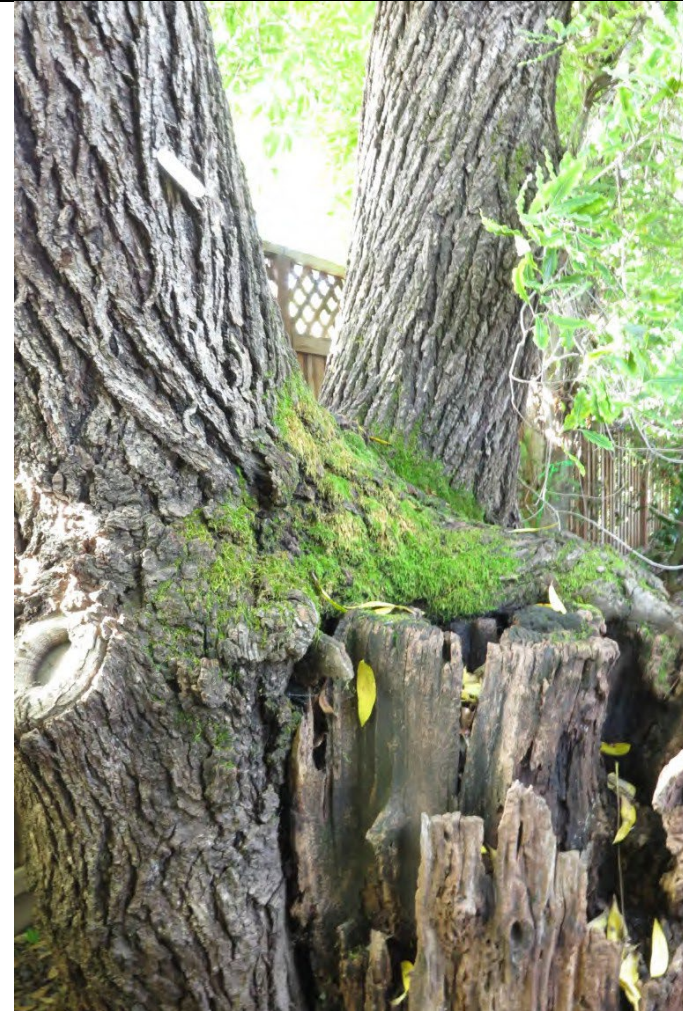

28



28

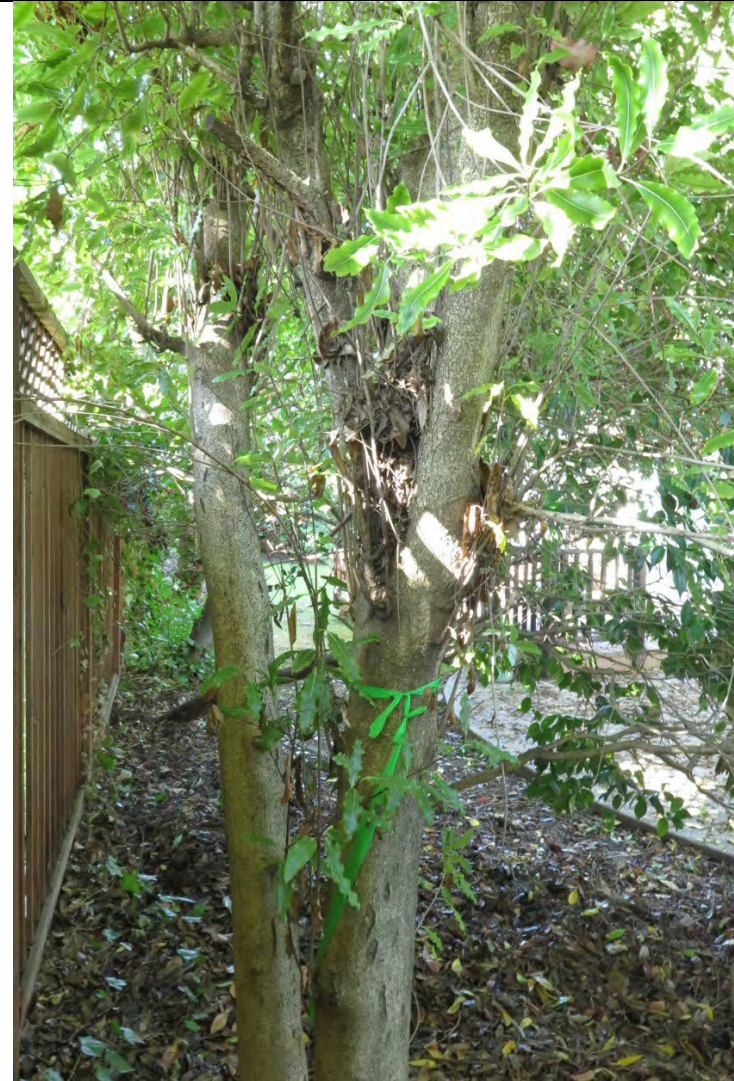

29

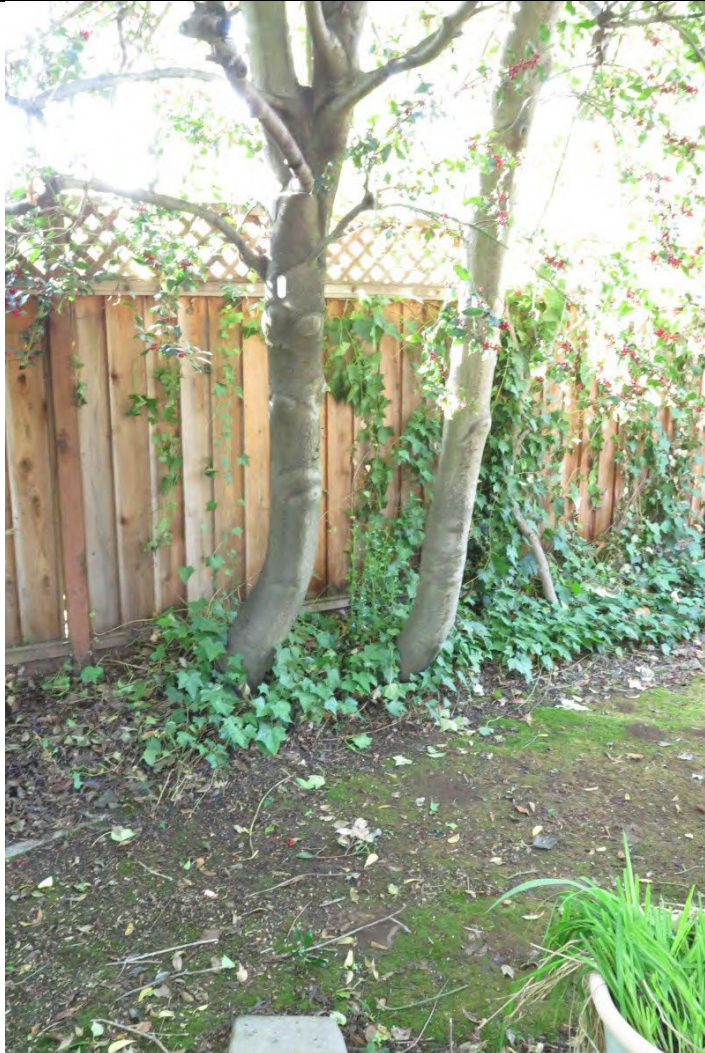

30



31

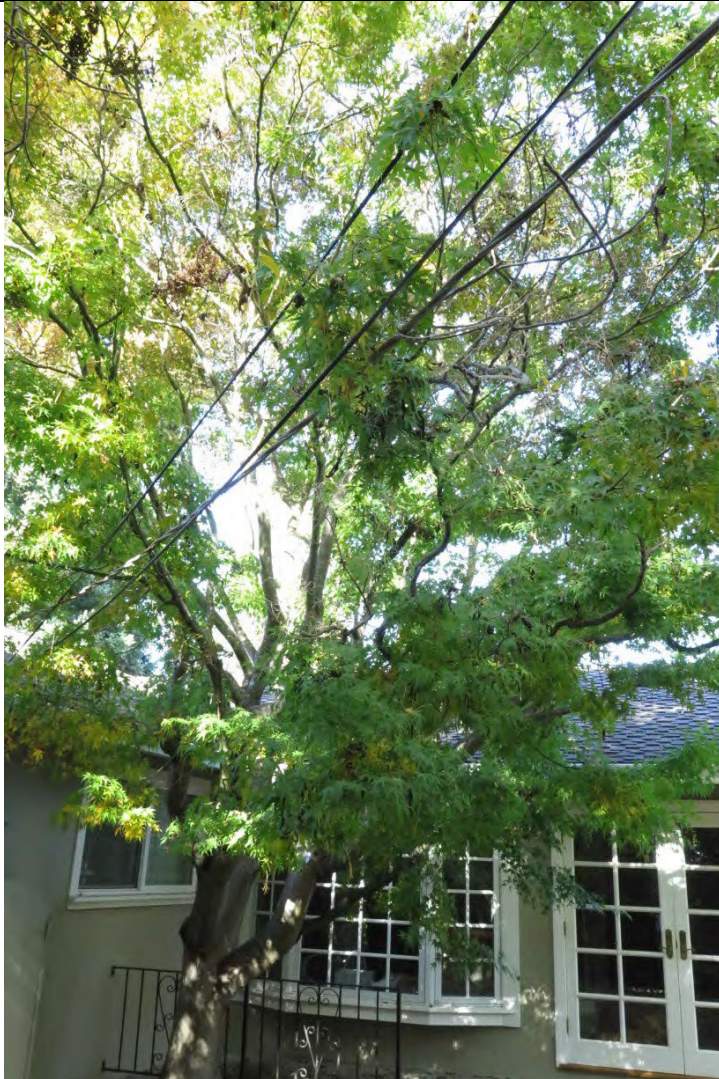

32



33



33



33



33



33

11.0 Tree Data Table

Tree Tag Number	Genus & Species	Common Name	Trunk1 Diameter	Trunk2 Diameter	Trunk3 Diameter	Sum of All Trunk Diameters	Height & Canopy Spread (Ft.)	Health & Structural Rating (100% Each)	Overall Condition Rating (0 to 100%)	(R) Remove Tree	(S) Save Tree	(D) Is Position Unclear	Lopsided Canopy (note direction)	Trunk Lean (note direction)	(GR) Girdling Roots	(BI) Bark Inclusion Fork	Pests and Disease Presence, and Other Notes	SUGGESTED ROOT PROTECTION FENCE RADIUS (Ft.)	MAINTENANCE AND PROTECTION CODES
21	<i>Liquidambar styraciflua</i>	American sweetgum	11.2	--	--	11.2	42/28	75/50	60% Fair			X				Possible BI fork noted at 11 feet.		Suggest offset the gas pipe line 6 feet or more from trunk edge, and the new wall work 10 feet offset. If this is not possible, then use trenchless technology to bore gas pipe under the root system, and set the wall footing above-grade as a floating grade beam suspended on vertical piers.	TB (trunk buffer). RPZ chain link fencing where possible. Realign proposed gas pipe, or use directional bore under the root system of tree. Reposition the proposed wall to 10 feet offset, or set it on a floating over-grade beam footing suspended on vertical piers.
22	<i>Malus</i> (Cult.)	Crabapple cultivar*	7.0	--	--	7.0	22/17	75/65	70% Good	X					Root barrier restricts normal root elongation			*It is not clear whether this is considered a "fruiting tree", given that tiny ornamental crabapples are not actually used for human consumption.	(Tree to be removed).
23	<i>Pseudotsuga menziesii</i>	Douglas fir	41.6	--	--	4.16	75/55	70/50	60% Fair		X		See notes at right.				Tree has been severely pruned to clear overhead high voltage electrical wires, by removing the vertical mainstem	Use 20 foot radius for fencing offset, at the canopy dripline, per the CTA's tree map markup.	TPZ chain link fencing erection at 20 feet offset radius.

Tree Tag Number	Genus & Species	Common Name	Trunk1 Diameter	Trunk2 Diameter	Trunk3 Diameter	Sum of All Trunk Diameters	Height & Canopy Spread (Ft.)	Health & Structural Rating (100% Each)	Overall Condition Rating (0 to 100%)	(R)emove Tree	(S)lave Tree	(D)isposition Unclear	Lopsided Canopy (note direction)	Trunk Lean (note direction)	(GR) Girdling Roots	(BI) Bark Inclusion Fork	Pests and Disease Presence, and Other Notes	SUGGESTED ROOT PROTECTION FENCE RADIUS (Ft.)	MAINTENANCE AND PROTECTION CODES
24	<i>Xylosma congestum</i> (not 100% verified)	Xylosma	14.3	--	--	14.3	30/32	80/70	75%		X							Use critical root zone of 13 feet offset radius for fence erection.	TPZ fence erection at 13 feet north of trunk edge (or at the canopy dripline, whichever is greater).
25	<i>Syzygium paniculatum</i> (or similar)	Australian brush cherry	6.7	--	--	6.7	40/12	55/40	48% Fair		X						Eugenia psyllid damage extensive on foliage, which is normal for this species.	Use critical root zone of 10 feet (i.e. a distance beyond the normal 6 foot CRZ for a tree of this size class).	TPZ fencing erection at 10 feet north of trunk edge.
26	<i>Pittosporum undulatum</i>	Victorian box	6	5	3	14	30/20	40/30	35% Poor		X						Tree has been severely hedge-pruned by PG&E to clear high voltage wires.	Erect fencing at 15 feet north of trunk.	TPZ fencing erection at 15 feet north of trunk edge.
27	<i>Pittosporum undulatum</i>	Victorian box	6	5	2	15 (dia of four stems)	30/15	40/30	35% Poor		X						Tree has been severely hedge-pruned by PG&E to clear high voltage wires.	Erect fencing at 15 feet north of trunk.	TPZ fencing erection at 15 feet north of trunk edge.

Tree Tag Number	Genus & Species	Common Name	Trunk1 Diameter	Trunk2 Diameter	Trunk3 Diameter	Sum of All Trunk Diameters	Height & Canopy Spread (Ft.)	Health & Structural Rating (100% Each)	Overall Condition Rating (0 to 100%)	(R)Remove Tree	(S)Slave Tree	(D)Disposition Unclear	Lopsided Canopy (note direction)	Trunk Lean (note direction)	(GR) Girdling Roots	(BI) Bark Inclusion Fork	Pests and Disease Presence, and Other Notes	SUGGESTED ROOT PROTECTION FENCE RADIUS (Ft.)	MAINTENANCE AND PROTECTION CODES
28	<i>Juglans hindsii</i>	Northern California black walnut	40.7	--	--	40.7	35/55	30/10	15% Very Poor	X			North ward				Tree has been severely pruned by PG&E to clear high voltage wires. 1 of 3 mainstems was removed at 4 feet elev, resulting in extensive advanced degree of wood tissue decay.	The CTA suggests considering this tree to be a "high risk" specimen that can be removed without fees, and without any canopy replacement planting requirement, per Town Code 29.10.0985.	(Tree to be removed per recommendation of the CTA, for safety purposes).
29	<i>Pittosporum undulatum</i>	Victorian box	6	5	--	11	30/15	50/25	35% Poor		X						Tree has been top-pruned by PG&E to clear high voltage wires (a severely damaging practice).	Erect fencing at 10 feet north of trunk.	TPZ fencing erection at 10 feet north of trunk edge.

Tree Tag Number	Genus & Species	Common Name	Trunk1 Diameter	Trunk2 Diameter	Trunk3 Diameter	Sum of All Trunk Diameters	Height & Canopy Spread (Ft.)	Health & Structural Rating (100% Each)	Overall Condition Rating (0 to 100%)	(R)Remove Tree	(S)Slave Tree	(D)isposition Unclear	Lopsided Canopy (note direction)	Trunk Lean (note direction)	(GR) Girdling Roots	(BI) Bark Inclusion Fork	Pests and Disease Presence, and Other Notes	SUGGESTED ROOT PROTECTION FENCE RADIUS (Ft.)	MAINTENANCE AND PROTECTION CODES
30	<i>Ilex aquifolium</i>	English holly tree	7.5	-	-	7.5	30/15	50/50	50% Fair		X		Norh ward				Previously topped at 20 feet.	Erect fencing at 10-15 feet north of trunk. Note that the proposed new residence and a construction corridor around the south side of the exterior siding will need to be cleared, which will probably require airspace clearance pruning.	TPZ fencing erection at 10 to 15 feet north of trunk edge. TB (trunk buffer wraps). Pruning on north side as needed to clear construction corridor airspace and the proposed new residence footprint airspace.
31	<i>Ilex aquifolium</i>	English holly tree	7.0	--	--	7.0	30/15	50/50	50% Fair		X		Norh ward				Previously topped at 20 feet.	Erect fencing at 10-15 feet north of trunk. Note that the proposed new residence and a construction corridor around the south side of the exterior siding will need to be cleared, which will probably require airspace clearance pruning.	TPZ fencing erection at 10 to 15 feet north of trunk edge. TB (trunk buffer wraps). Pruning on north side as needed to clear construction corridor airspace and the proposed new residence footprint airspace.

Tree Tag Number	Genus & Species	Common Name	Trunk1 Diameter	Trunk2 Diameter	Trunk3 Diameter	Sum of All Trunk Diameters	Height & Canopy Spread (Ft.)	Health & Structural Rating (100% Each)	Overall Condition Rating (0 to 100%)	(R)Remove Tree	(S)ave Tree	(D)isposition Unclear	Lopsided Canopy (note direction)	Trunk Lean (note direction)	(GR) Girdling Roots	(BI) Bark Inclusion Fork	Pests and Disease Presence, and Other Notes	SUGGESTED ROOT PROTECTION FENCE RADIUS (Ft.)	MAINTENANCE AND PROTECTION CODES
32	<i>Acer palmatum</i>	Japanese maple	8.9	7.9	7.8	24.6	28/32	80/75	77% Good	X							Tree is situated in very close proximity to the proposed residence, and is proposed to be removed per the applicant.	(Tree to be removed).	(Tree to be removed).



Tree Tag Number	Genus & Species	Common Name	Trunk1 Diameter	Trunk2 Diameter	Trunk3 Diameter	Sum of All Trunk Diameters	Height & Canopy Spread (Ft.)	Health & Structural Rating (100% Each)	Overall Condition Rating (0 to 100%)	(R)remove Tree	(S)lave Tree	(D)isposition Unclear	Lopsided Canopy (note direction)	Trunk Lean (note direction)	(GR) Girdling Roots	(BI) Bark Inclusion Fork	Pests and Disease Presence, and Other Notes	SUGGESTED ROOT PROTECTION FENCE RADIUS (Ft.)	MAINTENANCE AND PROTECTION CODES
33	<i>Pseudotsuga menziesii</i>	Douglas fir	41.2	--	--	41.2	80/45	80/55	66% Good	X								(Tree to be removed per applicant plan).	(Tree to be removed per applicant plan).

12.0 Tree Map Mark-up by the CTA (2025) on Applicant Site Plan Sheet 4 of 19

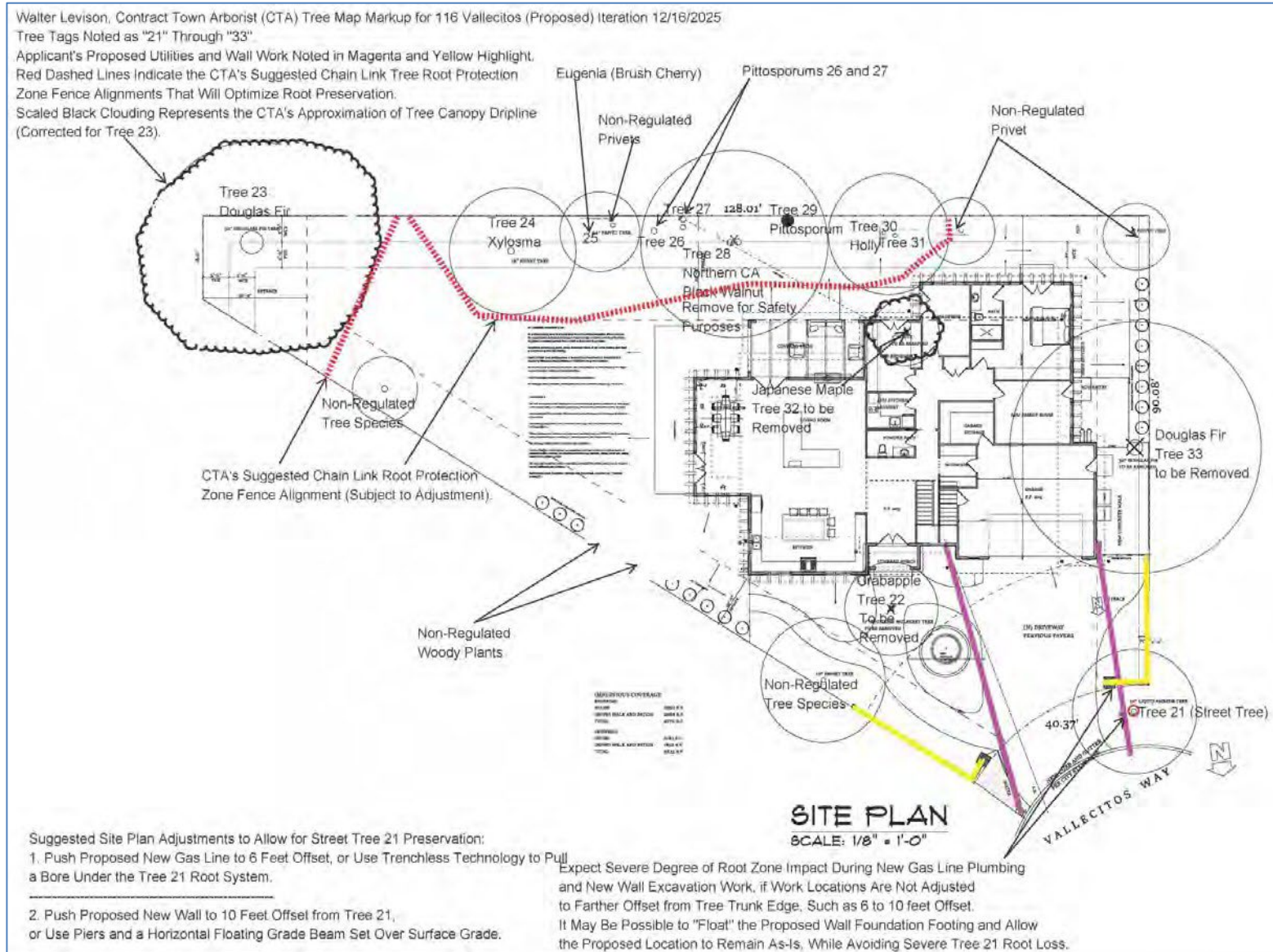

*This Page
Intentionally
Left Blank*