

# Annual Comprehensive Financial Report

Fiscal Year Ended June 30, 2021



City of Los Altos





**CITY OF LOS ALTOS, CALIFORNIA  
ANNUAL COMPREHENSIVE FINANCIAL REPORT  
FOR THE YEAR ENDED June 30, 2021**

**Prepared by  
FINANCE DEPARTMENT**



*This Page Left Intentionally Blank*

## **INTRODUCTORY SECTION**



**CITY OF LOS ALTOS**  
**Annual Comprehensive Financial Report**  
**For the Year Ended June 30, 2021**

**INTRODUCTORY SECTION:**

Letter of Transmittal.....	i
List of Principal Officials .....	viii
Organizational Chart .....	ix
<b>GFOA Certificate of Achievement</b> .....	x

**FINANCIAL SECTION:**

<i>Independent Auditor's Report</i> .....	1
<i>Management's Discussion and Analysis</i> .....	5
<b>Basic Financial Statements:</b>	
Government-wide Financial Statements	
Statement of Net Position .....	33
Statement of Activities .....	34
Fund Financial Statements	
Governmental Funds:	
Balance Sheet .....	38
Reconciliation of the Governmental Funds - Balance Sheet with the Statement of Net Position.....	39
Statement of Revenues, Expenditures, and Changes in Fund Balances.....	40
Reconciliation of the Net Change in Fund Balances - Total Governmental Funds with the Statement of Activities .....	41
Proprietary Funds	
Statement of Net Position.....	44
Statement of Revenues, Expenses and Changes in Fund Net Position .....	45
Statement of Cash Flows.....	46
Fiduciary Funds	
Statement of Net Position .....	48
Statement of Activities.....	49

**CITY OF LOS ALTOS**  
**Annual Comprehensive Financial Report**  
**For the Year Ended June 30, 2021**

**FINANCIAL SECTION (Continued):**

Notes to Basic Financial Statements ..... 51

***Required Supplementary Information:***

Cost-Sharing Multiple-Employer Defined Pension Plan:

Schedule of Proportionate Share of the Net Pension Liability and Related  
Ratio as of the Measurement Date ..... 94

Schedule of Contributions..... 95

Agent Multiple Employer Retiree Healthcare OPEB Plan:

Schedule of Changes in the Net OPEB Liability and Related  
Ratios – Retiree Healthcare OPEB Plan ..... 96

Schedule of Contributions..... 97

Notes to Schedule of Employer Contribution ..... 97

Schedules of Revenue, Expenditures, and Changes in Fund Balance - Budget and Actual:

General Fund..... 98

In-Lieu Park Land Special Revenue Fund ..... 99

Notes to Required Supplementary Information..... 100

***Other Supplementary Information***

General Fund

Combining Balance Sheet..... 104

Combining Schedule of Revenues Expenditures and Changes in Fund Balances..... 105

Non-major Governmental Funds

Combining Balance Sheet..... 110

Combining Statement of Revenues, Expenditures, and Changes  
in Fund Balances ..... 114

Schedules of Revenues, Expenditures, and Changes in Fund Balance - Budget and Actual:

Vehicle Impound Fund..... 118

Supplemental Law Enforcement Fund..... 119

Gas Tax Fund ..... 120



**CITY OF LOS ALTOS**  
**Annual Comprehensive Financial Report**  
**For the Year Ended June 30, 2021**

**FINANCIAL SECTION (Continued):**

Proposition 1B Fund .....	121
Community Development Block Grant Fund .....	122
Downtown Parking Fund .....	123
Traffic Impact Fee Fund.....	124
Estate Donation Fund.....	125
TDA Fund .....	126
PEG Fund.....	127
Vehicle Registration Fees Fund .....	128
SBI Road Maintenance Rehabilitation Fund.....	129
Traffic Congestion Relief Program Fund.....	130
Equipment Replacement Capital Projects Fund.....	131

***Internal Service Fund:***

Combining Statement of Net Position.....	134
Combining Statement of Revenues, Expenses and Changes in Fund Net Position.....	135
Combining Statement of Cash Flows .....	136

**STATISTICAL SECTION:**

Net Position by Component – Last Ten Fiscal Years.....	141
Changes in Net Position – Last Ten Fiscal Years .....	142
Fund Balances of Governmental Funds – Last Ten Fiscal Years.....	144
Changes in Fund Balances of Governmental Funds – Last Ten Fiscal Years.....	146
Tax Revenues by Source – Governmental Funds – Last Ten Fiscal Years.....	148
Assessed Value of Taxable Property – Last Ten Fiscal Years .....	149
Property Tax Dollar Breakdown .....	150
Property Tax Dollars By Recipient Group .....	151
Direct and Overlapping Tax Rates – Last Ten Fiscal Years .....	152
Principal Property Taxpayers – Current Year and Nine Years Ago.....	153
Property Tax Levies and Collections – Last Ten Fiscal Years.....	154
Ratios of Outstanding Debt by Type – Last Ten Fiscal Years .....	155
Schedule of Direct and Overlapping Bonded Debt .....	156
Legal Debt Margin – Last Ten Fiscal Years.....	157

**CITY OF LOS ALTOS**  
**Annual Comprehensive Financial Report**  
**For the Year Ended June 30, 2021**

**STATISTICAL SECTION (Continued):**

Demographic Statistics – Last Ten Fiscal Years .....	158
Principal Employers – Current Year and Ten Years Ago .....	159
Full-time Equivalent City Employees by Function/Program – Last Ten Fiscal Years .....	160
Full-time Equivalent City Employees .....	161
Operating Indicators by Function/Program – Last Ten Fiscal Years .....	162
Capital Asset Statistics by Function/Program – Last Ten Fiscal Years .....	163
Trust and Agency Debt Administration – Last Ten Fiscal Years.....	164



ONE NORTH SAN ANTONIO ROAD  
LOS ALTOS, CALIFORNIA 94022 - 3087

December 15, 2021

**Honorable Mayor and Members of  
the City Council  
City of Los Altos,  
California**

We are pleased to present the Annual Comprehensive Financial Report (ACFR) of the City of Los Altos, California (the City) for the fiscal year ended June 30, 2021. This document provides citizens, businesses, property owners, investors, and other interested parties with an overview of the City's finances. The information in this ACFR is prepared in accordance with Generally Accepted Accounting Principles (GAAP) and includes an unmodified opinion on the report by the City's independent certified public accountants. Although we rely on the standards and expertise of these external authorities, the responsibility for the accuracy and fairness of this report ultimately rests with the City. For readers interested in a more detailed review of the City's financial statements, the Management's Discussion and Analysis (MD&A) is also included in this document. The MD&A reports on the financial highlights of the City and provides additional analysis on the variances and trends reported as part of the financial statements. The MD&A also discloses significant items affecting the financial condition of the City and is designed to be read in conjunction with this Letter of Transmittal and can be found immediately following the report of the independent auditors.

**PROFILE OF THE CITY AND ITS SERVICES**

Tree-lined streets and a small village atmosphere characterize Los Altos, which is in the heart of the world-famous Silicon Valley. Just 40 miles south of San Francisco, Los Altos is a residential community with a population of approximately 31,000 served by seven small retail areas. The seven-square-mile residential city is developed with small businesses, schools, libraries, and churches. Incorporated on December 1, 1952, Los Altos is a general law city operating under the Council-Manager form of government. There are five Council members elected at large, serving four-year overlapping terms. Municipal services provided include police, street maintenance, engineering, community development, parks, recreation, and sewer. Fire protection is contracted with the Santa Clara County Central Fire Protection District.

**City Structure**

The City operates under the Council-Manager form of government, with five at-large Council Members elected to staggered four-year terms. The Mayor and Mayor Pro Term are elected by the Council from their membership, and each serves a one-year term. The City Council serves as the legislative and policy-making body of City government and is responsible for enacting City ordinances, adopting resolutions, approving the annual budget, appointing commissions and committees, and hiring the City Manager and City Attorney.

The City Manager is responsible for implementing City Council policies, ordinances, and directives; overseeing day-to-day operations; and appointing the directors of the City's departments and all personnel. As of June 30, 2021, the City had a permanent staff of 136 and augmented this staff with temporary, limited duration, and seasonal employees to address needs such as summer recreation programs. The City provides an array of services that include public safety/police services, recreation, Executive, finance, technology, human resources, public works, and community and economic development. Responsibilities in each service area include:

- **Executive** - includes The City Manager's Office, Economic Development, Emergency Preparedness, City Clerk's Office, City Attorney's Office, Risk Management, Human Resources, Information Technology, and Public relations;
- **Public Safety** - includes all Police functions, comprised of Training, Communications, Patrol, Investigations, Community Policing, Animal Control, School Service Officers, Traffic Enforcement. Fire Services are contracted to the County.
- **Finance** - includes Finance, Budget, Treasury, Business License, and Accounting.
- **Recreation and Community Services** - includes Recreation Classes, Senior Services, Facility Rentals, Sports and Camps,
- **Community Development**- includes Building Code Enforcement, Planning, Housing, and Transportation Planning.
- **Engineering Services**- includes managing the Capital investment program, sewer, and storm drain operations as well Transportation Planning.
- **Maintenance services** - includes Maintenance of Buildings, Parks, Streets, and Vehicles; Transportation Operations; Open Space Management.

The City also oversees the enterprise funds associated with Sewer and solid waste operations and several other special revenue funds such as the Park in Lieu fund, financial information for these operations is included in the ACFR. Library services are provided by The County. Fire services are contracted to the County, water utilities are provided by a separate special district, with their own governing body.

## **SERVICE EFFORTS AND MAJOR INITIATIVES**

### **Service Efforts**

In FY 2020-21, the City continued its commitment to provide a high level of service to its residents and citizens, adhered to its adopted financial plan as evidenced by the budget-to-actual reporting presented within this document. The latter half of FY 2020-21 saw the City face operational uncertainty due to the departure of the City Manager and Administrative Services Director compounded with the effects of the COVID-19 pandemic. Prudent and quick decision-making by the city council helped speed the hire of an Interim City Manager and consultants were engaged to meet the workloads in the Finance department. All major funds have performed within acceptable limits through proper stewardship and management.

## Major Initiatives

**Capital Improvements:** FY 2020-21 marked another year of capital investment into the community with further resources applied to City-wide improvements. Some of the key capital expenditures of note during FY 2020-21 include the following:

- \$20,088,533 – Hillview Community Center Redevelopment
- 1,482,295 – Annual Sewer Structural Reach Replacement
- 1,151,484- Annual Sewer System Repair Program
- 663,979 – Annual Street Resurfacing
- 551,391 – Annual Collector Street Traffic Calming
- 531,566 – El Monte Ave Sidewalk Gap closure (School route project)
- 303,508 – IT Initiatives

**Pedestrian Safety, Roads, and Walkways:** Los Altos invests a significant amount of resources on a variety of roadway, pedestrian, and bikeway initiatives and improvements. Over \$1 million was applied to street resurfacing, sidewalk repairs, and street lighting systems which enhanced safety lighting and street striping. These efforts support the City’s highway condition index while increasing overall pedestrian, bicycle, and vehicle safety.

**Civic Facilities:** In FY 2020-21, the City undertook the demolition and first stages of construction of a \$38 million state-of-the-art community center.

## FINANCIAL CONTROLS AND PROCEDURES

**Financial Policies:** On an annual basis, the Council approves financial policies designed to promote sound financial management and ensure fiscal integrity over time. This ACFR reflects the implementation of these financial guidelines and presents all fund reserves and designations to define fund balance commitments and obligations as of the financial report date.

**Internal Control Structure:** City management is responsible for establishing and maintaining fiscal internal controls designed to safeguard the assets of the government from loss, theft, or misuse, and to ensure that accounting data is accurately compiled to allow for the preparation of financial statements in conformity with generally accepted accounting principles. The internal control structure is designed to provide reasonable, but not absolute, assurance that these objectives are met. The concept of reasonable assurance recognizes that: (1) the cost of controls should not exceed the benefits likely to be derived and (2) the valuation of costs and benefits require estimates and judgments by management.

**Cash Management Policies:** It is the City’s practice to “pool” available cash from all funds for investment purposes. In accordance with the annually adopted investment policy, available cash is invested with the goal of safety, meaning the protection of principal, as the priority, ensuring adequate liquidity as the second priority, and maximizing yield as the third priority. This past year interest rates hit historical lows with the Federal Discount rate dropping to near zero. The Local Agency Investment Fund (LAIF) earnings rate averaged 0.5% and is dropping. Staff continues to act on Council direction to engage investment advisory services and continues to diversify the City’s investment portfolio as a means of mitigating the impact of interest rate swings. As always, the emphasis remains on preserving the safety of principal.

**Strengthening Key Fund Reserves:** This financial report reflects the attainment of judicious fiscal reserves noting continued funding to both capital and economic safety fund balances. As projected in the budget process, the results herein place the City in a position to maintain at least two months of budget expenditures in General Fund reserve. The City continues to prepare for the increase in the annual CalPERS payments by maintaining the CalPERS Reserve at \$5 million.

**Risk Management:** The City is insured for general liability through the Bay Cities Joint Powers Insurance Authority that covers claims in an amount up to \$10 million with a deductible or uninsured liability of up to \$100,000 per claim. The City is self-insured for Workers' Compensation and has an excess insurance policy for such claims up to the statutory limits. The City continues to maintain adequate funding levels to cover the cost of its actuarial obligations, but these rising cost areas will require continued attention in the coming years.

**GASB 75 Compliance:** This report complies with the provisions of Government Accounting Standard Board Statement #75 (GASB 75). This standard pertains to Other Post Employee Benefits (OPEB) and requires the completion of an actuarial study to account for post-employee benefit liabilities that exist. This reporting requirement is described in financial note 12 of the ACFR and the related liabilities reflected in the statements. As of June 30, 2021, the City's net OPEB obligation was valued at \$1.6 million, an amount reflected in the government-wide statements. The City has set aside \$1.5 million in reserves to address this liability funding. The City has also invested another \$1.5 million in an irrevocable trust for OPEB with CalPERS.

## EXECUTIVE FINANCIAL OVERVIEW

This executive financial overview is presented as a supplement to the more detailed and comprehensive analysis presented in the MD&A. This section highlights key financial performance indicators for our major funds.

### General Fund

The General Fund, the primary operating fund of the City, favorably exceeded expectations with an operating surplus of \$ 7.6 (includes onetime American rescue plan act, ARPA funds of \$3.9) million before transfers, for Fiscal Year 2020-21. At year end, the total General Fund balance equaled \$22.7 million with an unassigned fund balance of \$1.2 million after commitments and assignments. At the beginning of the Fiscal Year, the unassigned fund balance was \$7.8million. A primary factor reducing this balance was that the city decided to reclassify land it had purchased in the prior year from held for sale to held for park development, the land purchase was valued at \$ 2.86 million.

As planned for in the budget process, this surplus must be allocated to maintain the City's Operating Reserve at 20% and allocating major funding to capital improvements, such as street maintenance and annual facilities improvements. At year end, the City's Operating Reserve fell short of 20%, at 18.9%, and the City's CIP fund, after initial transfers, was \$1.4 million less than what is required to meet planned projects. In order to ensure the City's Operating Reserve is increased to 20%, the City will have to defer or cancel planned CIP projects. After the transfer and use of reserve activity listed below, the final General Fund balance decreased by \$12.7million. These non-operating and transfer activities are as follows:

- \$146,176 transfer in from public safety grant funds and others
- \$867,200 transfer out for general debt service payments
- \$16,781,172 transfer out for capital projects
- \$7,754 transfer out for closing out Raymundo Curb and Gutter District

The General Fund’s key revenue streams continue to grow at a steady pace. Property tax, which accounts for nearly 59% of the City’s revenues, continues to be the strongest driver with an increase of 10.4% in FY 2020-21 over the prior year.

**Table of Revenues compared to Last Year and Current Year Budget**

Revenue (in Millions)	FY 2020 Actual	FY 21 Budget	FY 2021 Actual	Actual Var %	Budget Var%
Property Tax	25.79	27.29	28.46	10.4%	4.3%
Sales Tax	3.37	2.64	3.00	-11.2%	13.4%
Transient Occupancy Tax	2.36	0.58	0.66	-71.9%	13.7%
Utility Users Tax	2.84	2.46	2.92	2.8%	18.4%
Other Taxes	1.12	1.02	1.49	32.9%	46.3%
Franchise Fees	2.29	2.35	2.21	-3.1%	-5.9%
Interest Income	1.79	0.41	0.14	-91.9%	-64.2%
Recreation Fees	0.85	0.04	0.27	-67.9%	605.0%
Community Development Fees	3.48	3.42	3.94	13.3%	15.3%
Other Revenue	1.69	1.95	1.42	-15.5%	-26.9%
Grants (ARPA + CARES)	-	-	3.98	100.0%	100.0%
<b>Total Revenue</b>	<b>45.57</b>	<b>42.16</b>	<b>48.51</b>	<b>6.4%</b>	<b>15.1%</b>

General Fund revenues increased by 6.4% overall in contrast to a 0.7% increase in the prior year. Revenues came in above the annual budget estimates with Sales Tax, UUT, and property tax being the front runners. Interest income witnessed a large decrease due to the discount rate falling to near zero. Property Tax grew with an increase of 10.4% from the prior year. Sales tax decreased by 11.2% on actuals mainly due to slower recovery of the economy during the current COVID-19 pandemic, sales tax however did exceed budgeted numbers for the year by 13.4%. Interest income is expected to remain relatively flat in the upcoming year. The City’s other taxes, such as real estate transfer tax and documentary transfer tax, grew 32.9% primarily driven by higher real estate activity. License and permit fees increased based on development activity and timing of payments within the City. Recreation programs declined 67.9% due to the cancellations during the construction of the new Community Center and a reduction in community offerings in response to the COVID-19 pandemic.

General Fund expenditures were 1.5% lower than final budget. The General Fund expenditures came in significantly below General Fund revenues by \$3.6 million after adjusting for one-time revenues related to grants American Rescue Plan Act (ARPA) & Coronavirus Aid, Relief, and Economic Security Act (CARES).

**Other Funds**

**Capital Project Funds:** Expenditures in the Capital Projects Fund were \$22.8 million driven by the construction work on the new community center. The year end fund balance stood at \$11.5 million. Based on commitments in the Capital budget for the period FY 22-26 and the commitments made for the first and second year of that period these reserves will be insufficient to fulfill commitments unless additional funding sources are identified and/or Capital projects are deferred or cancelled.

**Special Revenue, Internal and Enterprise Funds:** All other Governmental and Business Type funds results were as expected. In Lieu Parkland, special revenue funds ended the year with a combined balance of \$5.8 million while Enterprise funds ended the year with a combined net position of \$30.25 million.

**Fiduciary Funds:** The City acts as a custodian of funds held for the benefit of others including the administration of the North County Library Authority (NCLA). The long-standing Raymundo and the Blue Oak Lane Sewer special assessment district are classified in the custodial group in recognition of the limited nature of this debt which is fully collateralized by homeowner assessments without City obligation.

## ECONOMIC TRENDS

The last quarter of the Fiscal Year 2020 and the entirety of Fiscal Year 2021 were marked by the impacts of the novel coronavirus, COVID-19 pandemic. The declaration of local and state-wide emergencies and public health orders closed large parts of the economy to encourage physical distancing and protect public health. Since the initial public health orders, restrictions have been applied and lifted with regularity. This caused a severe impact on economic activity. The effects of this can be clearly seen in Los Altos financial statements, wherein Sales tax is still below pre-pandemic levels and Transient occupancy tax has taken a huge hit languishing at 21% of pre-pandemic levels.

Nationally, March 2021 saw non-farm payroll employment grow by 916,000 jobs, reflecting the continued resumption of economic activity. Job growth in March 2021 was widespread, with leisure and hospitality, public and private education, and construction sectors experiencing job gains. Despite improvements in the unemployment rate, non-farm payroll employment is still down by 8.4 million compared to pre-pandemic employment<sup>1</sup>.

As of October 2021, the national unemployment rate<sup>2</sup> was 6.0%, down from a peak of 14.8% in April 2020. In Santa Clara County, the unemployment rate was 3.7% in October 2021, compared to a pandemic peak of 12.2% in April 2020. Los Altos unemployment rate was at 3.6%.

As public health restrictions ease and City facilities and programs continue to reopen, the FY22 & FY23 budget includes increases in expenditures and additional staffing to support these changes. The economic recovery is expected to continue over the next two years. Accordingly, staff developed a budget for FY22 that served as a bridge year between the deepest moments of the pandemic and the return to normalcy. We expect it to be a year of continued recovery from the economic recession triggered by the pandemic. Likewise, the budget for FY23 will include the acknowledgment that some areas of operations are still likely to be in recovery, and not yet restored to pre-pandemic levels of operation. Additionally, the passage of the American Rescue Plan Act (ARPA), which was signed into law on March 11, 2021, provides the City with \$7.2 million in one-time stimulus funds, which allows the City to support economic recovery, provide essential City services, and fund key projects and initiatives.

The City continues to perform fairly but was unable to maintain target reserve levels without delaying or canceling capital projects. As we move forward, we remain constantly aware of the financial challenges that face all local municipalities in particular the financial challenges caused by the COVID-19 pandemic, the effects of which will continue to impact the City for multiple years to come. In addition, we continue to monitor and plan to address the significant rises in pension, healthcare, and construction costs. Given the reliance on property tax revenues and the higher revenues in Community Development and other revenue streams, we must remain ever vigilant in monitoring economic trends and long-term financial issues. Only through fiscal stewardship, proper budgeting and prudent use of our reserves, the City of Los Altos will be set to continue its commitment to taking care of its capital needs and residents for the foreseeable future.

1. [https://www.bls.gov/news.release/archives/empsit\\_04022021.pdf](https://www.bls.gov/news.release/archives/empsit_04022021.pdf)

2 <https://fred.stlouisfed.org/series/CASANT5URN>



## INDEPENDENT AUDIT

The public accounting firm of Maze and Associates performed the annual independent audit. The auditors' report on the City's financial statements is included in the financial section of this report.

## AWARDS

The Government Finance Officers Association of the United States and Canada (GFOA) awarded a Certificate of Achievement for Excellence in Financial Reporting to the City for its ACFR for the fiscal year ended June 30, 2019. In the last 14 years, the City has achieved this prestigious award. In order to be awarded a Certificate of Achievement, a government must publish an easily readable and efficiently organized ACFR. This report must satisfy both generally accepted accounting principles and applicable legal requirements, the award for 2020 has not yet been awarded but we anticipate that we will meet the requirements.

A Certificate of Achievement is valid for a period of one year only. We believe that our current ACFR continues to meet the Certificate of Achievement Program's requirements and we are submitting it to the GFOA to determine its eligibility for another certificate.

## ACKNOWLEDGEMENTS

Preparation of this report could not have been accomplished without the efficient and dedicated services of the Finance Division staff, June Du, Liz Sandstorm, and Josh Chen. Every member of the department deserves recognition and thanks for their commitment to the City and their profession. We also want to thank Maze and Associates, our independent auditors, for their professionalism in performing this year-end financial audit, as well as the members of the Financial Commission for their dedication and expertise to help shape policies and procedures. We would also like to thank the members of the City Council, Jon Maginot and Brad Klinger, former Interim City Manager, along with the Executive Team for their leadership and oversight in managing the financial operations of the City.

Respectfully submitted,



**Gabriel Engeland**  
City Manager

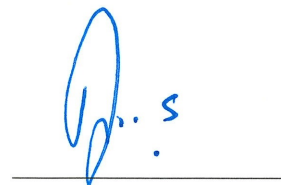

**John Furtado**  
Finance Director

# City of Los Altos

List of Principal Officials

As of June 30, 2021

---

## ELECTED OFFICIALS

Mayor .....	Neysa Fligor
Mayor Pro Tem .....	Anita Enander
City Council .....	Lynette Lee Eng
City Council .....	Sally Meadows
City Council .....	Johnathan Weinberg

## APPOINTED OFFICIALS

City Manager .....	Gabriel Engeland
City Attorney .....	Jolie Houston

## EXECUTIVE TEAM

Community Development Director .....	Jon Biggs
Deputy City Manager .....	Jon Maginot
Assistant City Manager .....	Vacant
Chief of Police .....	Andy Galea
Finance Director .....	John Furtado
Engineering Services Director .....	Jim Sandoval
Human Resources Manager .....	Irene Silipin
Recreation & Community Services .....	Donna Legge
Municipal Services Director .....	Manuel Hernandez



# City of Los Altos

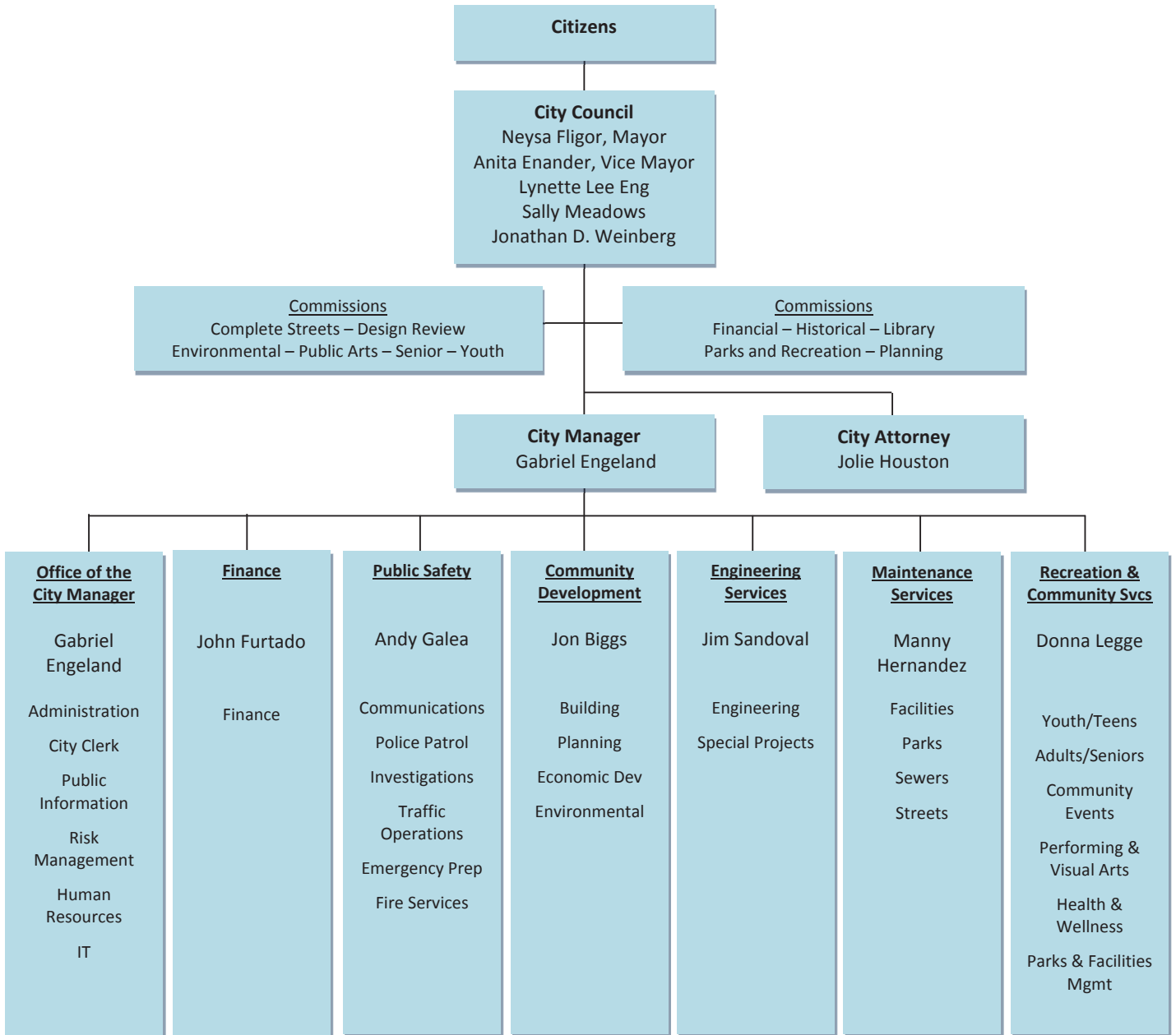

**GFOA CERTIFICATE**

## INDEPENDENT AUDITOR'S REPORT

To the Honorable Members of the City Council  
City of Los Altos, California

### *Report on the Financial Statements*

We have audited the accompanying financial statements of the governmental activities, the business-type activities, each major fund, and the aggregate remaining fund information of the City of Los Altos (City), California, as of and for the year ended June 30, 2021, and the related notes to the financial statements, which collectively comprise the City's basic financial statements as listed in the Table of Contents.

### *Management's Responsibility for the Financial Statements*

Management is responsible for the preparation and fair presentation of these financial statements in accordance with accounting principles generally accepted in the United States of America; this includes the design, implementation, and maintenance of internal control relevant to the preparation and fair presentation of the financial statements that are free from material misstatement, whether due to fraud or error.

### *Auditor's Responsibility*

Our responsibility is to express opinions on these financial statements based on our audit. We conducted our audit in accordance with auditing standards generally accepted in the United States of America and the standards applicable to financial audits contained in *Government Auditing Standards*, issued by the Comptroller General of the United States. Those standards require that we plan and perform the audit to obtain reasonable assurance about whether the financial statements are free from material misstatement.

An audit involves performing procedures to obtain audit evidence about the amounts and disclosures in the financial statements. The procedures selected depend on the auditor's judgment, including the assessment of the risks of material misstatement of the financial statements, whether due to fraud or error. In making those risk assessments, the auditor considers internal control relevant to the City's preparation and fair presentation of the financial statements in order to design audit procedures that are appropriate in the circumstances, but not for the purpose of expressing an opinion on the effectiveness of the City's internal control. Accordingly, we express no such opinion. An audit also includes evaluating the appropriateness of accounting policies used and the reasonableness of significant accounting estimates made by management, as well as evaluating the overall presentation of the financial statements.

We believe that the audit evidence we have obtained is sufficient and appropriate to provide a basis for our audit opinions.

### *Opinions*

In our opinion, the financial statements referred to above present fairly, in all material respects, the respective financial position of the governmental activities, the business-type activities, each major fund, and the aggregate remaining fund information of the City as of June 30, 2021, and the respective changes in financial position and, where applicable, cash flows thereof for the year then ended in accordance with accounting principles generally accepted in the United States of America.

### ***Change in Accounting Principles***

Management adopted the provisions of Governmental Accounting Standards Board Statement No. 84 – Fiduciary Activities, which became effective during the year ended June 30, 2021 and established the new fund type, Custodial Funds, and eliminated the fund type of Agency Funds as discussed in Note 8J to the financial statements.

Management also early adopted the provisions of Governmental Accounting Standards Board Statement No. 98 – The Annual Comprehensive Financial Report which changes the name of the Annual Comprehensive Financial Report to Annual Comprehensive Financial Report.

### ***Emphasis of a Matter***

During the fiscal year 2021, the City made some prior period adjustments, as a result, the beginning fund balances for General Fund, the Capital Projects Fund, the Community Development Block Grant special revenue fund were reduced by \$2,939,821, \$161,894 and \$4,617 respectively. The beginning fund balances for the Gas Tax, TDA and Vehicle Registration special revenue funds were increased by \$19,392, \$52,724 and \$147,017 respectively. Beginning net positions at July 1, 2021 for the Governmental Activities were reduced by \$2,887,199 correspondingly.

### ***Other Matters***

#### ***Required Supplementary Information***

Accounting principles generally accepted in the United States of America require that Management's Discussion and Analysis, and other Required Supplementary Information listed in the Table of Contents be presented to supplement the basic financial statements. Such information, although not a part of the basic financial statements, is required by the Governmental Accounting Standards Board, who considers it to be an essential part of financial reporting for placing the basic financial statements in an appropriate operational, economic or historical context. We have applied certain limited procedures to the required supplementary information in accordance with auditing standards generally accepted in the United States of America, which consisted of inquiries of management about the methods of preparing the information and comparing the information for consistency with management's responses to our inquiries, the basic financial statements, and other knowledge we obtained during our audit of the basic financial statements. We do not express an opinion or provide any assurance on the information because the limited procedures do not provide us with sufficient evidence to express an opinion or provide any assurance.

#### ***Other Information***

Our audit was conducted for the purpose of forming opinions on the financial statements that collectively comprise the City's basic financial statements. The Introductory Section, Supplemental Information, and Statistical Section listed in the Table of Contents are presented for purposes of additional analysis and are not a required part of the basic financial statements.

The Supplemental Information is responsibility of management and was derived from and relates directly to the underlying accounting and other records used to prepare the basic financial statements. Such information has been subjected to the auditing procedures applied in the audit of the basic financial statements and certain additional procedures, including comparing and reconciling such information directly to the underlying accounting and other records used to prepare the basic financial statements or to the basic financial statements themselves, and other additional procedures in accordance with auditing standards generally accepted in the United States of America. In our opinion, the Supplemental Information is fairly stated in all material respects in relation to the basic financial statements as a whole.

The Introductory and Statistical Sections have not been subjected to the auditing procedures applied in the audit of the basic financial statements and, accordingly, we do not express an opinion or provide any assurance on them.

***Other Reporting Required by Government Auditing Standards***

In accordance with *Government Auditing Standards*, we have also issued our report dated December 15, 2021, on our consideration of the City's internal control over financial reporting and on our tests of its compliance with certain provisions of laws, regulations, contracts, and grant agreements and other matters. The purpose of that report is to describe the scope of our testing of internal control over financial reporting and compliance and the results of that testing, and not to provide an opinion on the effectiveness of the City's internal control over financial reporting or on compliance. That report is an integral part of an audit performed in accordance with Government Auditing Standards in considering the City's internal control over financial reporting and compliance.

*Maze & Associates*

Pleasant Hill, California  
December 15, 2021



*This Page Left Intentionally Blank*



---

# MANAGEMENT'S DISCUSSION AND ANALYSIS

---



# City of Los Altos

## Management's Discussion and Analysis

### For the year ended June 30, 2021

---

As management of the City of Los Altos (City), we offer readers of the City's financial statements this narrative overview and analysis of the financial activities of the City for the fiscal year ended June 30, 2021, in accordance with standards established by the Governmental Accounting Standards Board. We encourage readers to consider the information presented here, in conjunction with additional information furnished in the Letter of Transmittal, which can be found in the preceding introductory section of this report, and with the City's basic financial statements and accompanying notes to those financial statements.

#### USING THIS ANNUAL REPORT

##### Overview of the Financial Statements

This discussion and analysis are intended to serve as an introduction to the City's basic financial statements, which are comprised of three components: 1) government-wide financial statements; 2) fund financial statements; and 3) notes to the financial statements. This report also contains other supplementary information in addition to the basic financial statements themselves.

##### Reporting on the City as a Whole

**Government-wide Financial Statements:** The *government-wide financial statements* are designed to provide readers with a broad overview of the City's finances in a manner similar to a private sector business.

The *statement of net position* presents information on all City assets and liabilities, with the difference between the two reported as *net position*. Over time, increases or decreases in net position may serve as a useful indicator of whether the financial position of the City is improving or deteriorating.

The *statement of activities* presents how the City's net position changed during the most recent fiscal year. All changes in net position are reported as soon as the underlying event giving rise to the change occurs, regardless of the timing of related cash flows. Thus, revenues and expenses are reported in this statement for some items that will only result in cash flows in future fiscal periods (e.g., uncollected taxes and earned but unused vacation leave).

Both the government-wide financial statements distinguish functions of the City that are principally supported by taxes and intergovernmental revenues (*governmental activities*) from other functions that are intended to recover all or a significant portion of their costs through user fees and charges (*business-type activities*). The governmental activities of the City include general government, public safety, maintenance, and public works services, planning, building, engineering, and recreation. The City's business-type activities include sewer, solid waste, and storm drain.

The government-wide financial statements can be found on pages 21 to 23 of this report.

##### Reporting on the City's Most Significant Funds

**Fund Financial Statements:** A *fund* is a grouping of related accounts that is used to maintain control over resources that have been segregated for specific activities or objectives. The City, like other state and local governments, uses fund accounting to ensure and demonstrate compliance with finance-related legal requirements. All the funds of the City can be divided into three categories: governmental funds; proprietary funds; and fiduciary funds.

**City of Los Altos**  
**Management's Discussion and Analysis, Continued**  
**For the year ended June 30, 2021**

---

**Notes to the Basic Financial Statements.** The notes provide additional information that is essential, or a full understanding of the data provided in the government-wide and fund financial statements.

In addition to the basic financial statements and accompanying notes, this report also presents certain required and other supplementary information, such as the budgetary comparison information on the City's General Fund. Each major special revenue fund as well as the schedule of changes in the City's net pension liability for the miscellaneous plan, schedule of the City's proportionate share of the safety cost-sharing plan and the schedules of the City's pension contributions to each plan. This information is intended to furnish additional detail to support the basic financial statements.

**Governmental Funds:** *Governmental funds* are used to account for essentially the same functions reported as *governmental activities* in the government-wide financial statements. However, unlike the government-wide financial statements, governmental fund financial statements focus on near-term inflows and outflows of spendable resources, as well as on balances of spendable resources available at the end of the fiscal year. Such information may be useful in evaluating a government's near-term financing requirements.

Because the focus of governmental funds is narrower than that of the government-wide financial statements, it is useful to compare the information presented for governmental funds with similar information presented for governmental activities in the government-wide financial statements. By doing so, readers may better understand the long-term impact of the government's near-term financing decisions. Both the governmental fund balance sheet and governmental fund statement of revenues, expenditures, and changes in fund balances provide a reconciliation to facilitate this comparison between governmental funds and governmental activities.

The City maintains 22 individual governmental funds. Information is presented separately in the governmental fund balance sheet and in the governmental fund statement of revenues, expenditures, and changes in fund balances for the General Fund, In-Lieu Park Land Special Revenue Fund, and Capital Project Fund, each of which are major funds. Data from the other 19 governmental funds are combined into a single, aggregated presentation. Individual fund data for each of these *non-major* governmental funds is provided in the form of *combining statements* elsewhere in the fund financial statements section of this report.

The City adopts a budget annually for the General Fund, Special Revenue Funds, (except for the Storm Drain Deposits Fund), and Equipment Replacement Capital Projects Fund that is effective July 1 for the ensuing fiscal year. A budgetary comparison statement has been provided for several key governmental funds to demonstrate compliance with this budget.

The basic governmental fund financial statements can be found on pages 26 to 29 of this report.

**Proprietary Funds:** The City maintains two types of *proprietary funds*. Services for which the City charges customers a fee are generally reported in the City's *enterprise funds*. These proprietary funds, like the government-wide statements, provide both long-term and short-term financial information. *Internal service funds* are an accounting device used to accumulate and allocate costs internally among the City's various functions. The City uses internal service funds to account for its City dental plan and unemployment insurance, as well as Workers' Compensation and Liability Insurance costs. Because these services predominantly benefit the governmental function, they have been included in the government-wide financial statements and related intra-fund charges have been eliminated accordingly.

**City of Los Altos**  
**Management’s Discussion and Analysis, Continued**  
**For the year ended June 30, 2021**

---

Proprietary fund financial statements provide the same type of information as the government-wide financial statements, only in more detail. All four internal service funds are combined into a single, aggregated presentation in the proprietary fund financial statements. Individual fund data for the internal service funds is provided in the form of combining statements elsewhere in this report. The City’s three enterprise funds (Sewer, Solid Waste and Storm Drain) are considered major funds and are presented as such in the fund financial statements. The City follows the practice of adopting annual budgets for these operations as well.

The combining statements referred to earlier in relation to non-major governmental funds, proprietary and internal service funds, are presented immediately following the notes to the financial statements. Combining and individual fund statements and schedules can be found on pages 93 to 103 of this report.

**Notes to the Basic Financial Statements:** The notes provide additional information that is essential to a full understanding of the data provided in the government-wide and fund financial statements. These can be found on pages 37 to 75 of this report.

**Other Information:** In addition to the basic financial statements and accompanying notes, this report also presents certain *required supplementary information* concerning the City’s budget-to-actual financial comparisons for the General Fund. The City has elected to present this information within the basic financial statement and financial statement sections of the report.

**The City as Trustee**

**Fiduciary Funds:** The City is the trustee, or fiduciary, for the North County Library Authority (NCLA) and two special assessment districts – Raymundo and Blue Oak Sewer Lane improvements. Fiduciary funds are used to account for resources held for the benefit of parties outside the government. Fiduciary funds are not reflected in the government-wide financial statements because the resources of those funds are not available to support the City’s own programs. The City is responsible for ensuring that the assets reported in these funds are used for their intended purposes.

In summary, the various sections of this financial report are arranged as follows:

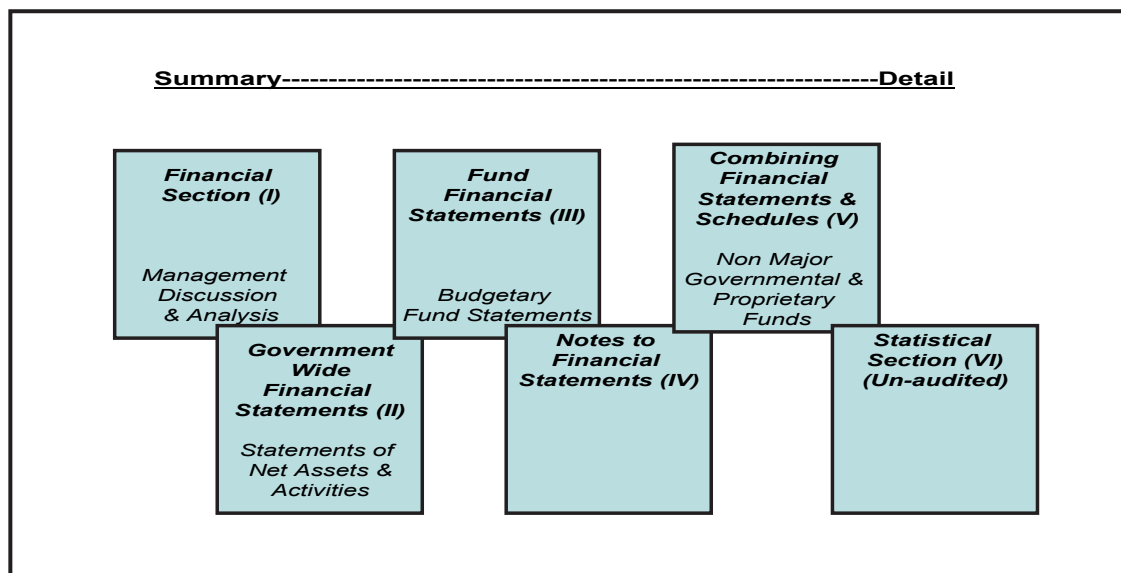

**City of Los Altos**  
**Management's Discussion and Analysis, Continued**  
**For the year ended June 30, 2021**

---

**FINANCIAL HIGHLIGHTS**

Financial highlights of the year ended June 30, 2021, include the following:

The City ended its fiscal year on a government-wide basis with total revenues of \$61.5 million, which was an increase of \$2.9 million or 5.0% compared to the prior year, and total expenses of \$50.0 million, a decrease of \$4.5 million or 8.3%. The results represent combined government and business operations, with an overall increase in net position of \$8.7 million due to stronger than anticipated revenues combined with contained expenditures City-wide. These favorable fiscal results have continued to strengthen the City's reserves. (See tables 2 and 5 for additional information).

Operational revenue gains were predominantly in property tax, utility tax and while hotel occupancy tax has not recovered to pre-pandemic levels it has exceeded the projected budget, interest income was well below last year's level due to the drop in the discount rates. Recreation revenues were significantly lower due to the closure of the community center and the reduction or elimination of many events, programs, and activities that were fee based. The Operating Grants and Contributions increased by \$4.2 million due to an inflow of stimulus money related to the Cares Act and the American Rescue Plan Act (ARPA). Sewer revenues decreased by \$0.8 million due to lower planned billing to users and solid waste revenues were stable and positioned to facilitate future operational and capital needs.

The decrease in Government-wide expenses is the result of vacant full-time staff positions as well as lower expenses caused by restrictions related to COVID-19. Resource uses continue to reflect an emphasis on public safety, infrastructure maintenance, quality of life, and community development activity.

The City made significant progress on many capital improvement initiatives, which include maintenance and street resurfacing, streetscape and intersection improvements, and pedestrian and traffic safety enhancements throughout the City. Currently, the largest project is the Los Altos Community Center, which was completed in fall 2021. The City has also made significant capital investments in the maintenance and improvement of the City-wide sewer systems.

**Government-Wide View**

- Net position (excess of assets over liabilities) equaled \$137.9 million, an increase of \$8.7 million, or 6.75%. This is mainly attributed to the increase in tax revenue with the use of portions of those increased revenues for infrastructure maintenance and improvements. The City's net position represents its total net holdings, which are not necessarily unrestricted depending upon the source of the original funding. (See tables 1 and 4 for additional information)
- Governmental activities reported an ending net position of \$107.7 million, an increase of \$6.3 million. The increase in government net position arises from positive operating results, fee collections, and cost containment.
- Business activities reported ending net position of \$30.2 million, an increase of \$2.37 million due to positive operating results in the Sewer and Solid Waste Funds and substantial capital investments.

**Fund Level View**

- The General Fund realized an operating surplus of \$7.6 million which was \$2.2 million higher than the prior year due to an increase in revenue from property tax (\$2.7M), and Operating grants related to ARPA and CARES act (\$3.9M). These gains were offset by reduced interest and rental income (2.07M), Transient occupancy tax (\$1.7M), and recreation fees (\$0.5M) which were substantially lower due to the impacts of the Covid-19 Pandemic.

**City of Los Altos**  
**Management's Discussion and Analysis, Continued**  
**For the year ended June 30, 2021**

---

- General Fund revenues, excluding transfers, increased over prior year actuals by \$2.4 or 5.2% to \$48.4 million. Current year results also exceeded budget estimates by 15.1%, primarily due to the receipt of ARPA and CARES act money and higher than anticipated property tax. Related expenditures increased by \$0.23 million to \$40.8 million, or 0.6%, the results also had expenditures lower than budget by 1.5% or \$0.6 million, because of increased normal costs and contract commitments, which were offset by salary savings from vacant positions.
- Total governmental fund balances equaled \$46.2 million at fiscal year-end, a \$4.6 million decrease from the prior year. The decrease was primarily due to expenses incurred on the Community Center project.
- General government capital spending totaled approximately \$23.3 million. The level of capital reinvestment in Los Altos reflects a sustained focus on the maintenance of streets, facilities, traffic calming efforts, and safety. The Capital Improvements Projects Fund balance increased by \$7.8 million due to the transfer of a part of the unassigned general fund balance from the prior year to the end of the year of \$6.4 million.
- The In Lieu Parkland Fund ended the year with a fund balance of \$5.8 million with revenues of \$1.6 million with expenditures and transfers out of 1.3 million spent on eligible projects.
- The Gas Tax Fund balance increased by \$0.4 million to \$2.0 million after funds were used for capital projects including surplus revenue for the year.
- Sewer operations ended the year favorably with a net position of \$24.6 million. Operating expenses decreased by \$0.26 million or 4.7% because of the planned activity to system maintenance.
- Solid waste operations ended the year favorably in net position of \$5.6 million. Operating expenses decreased by \$0.03 million or 7.5%.
- As in the prior year, the Storm Drain Fund has exhausted available resources and has a negative net position of \$23,959. These operations are now fully General Fund-subsidized and will continue to be so until the implementation of a fee-based model.
- The Workers' Compensation Fund ended the year with an unrestricted net position of \$1.6 million, a decrease of \$1.0 million due to claim activity and not providing additional funding. The General Liability Fund ended the year with an unrestricted net position of \$0.3 million, a decrease of \$0.79 million.
- Other Non-Major Governmental Funds ended the year with a total combined fund balance of \$6.2 million, an increase of \$263,417.

**GOVERNMENT-WIDE FINANCIAL ANALYSIS**

This analysis focuses on the net position and changes in net position at the City-wide level as presented in the statement of net position and statement of activities which are summarized in the tables below as of June 30, 2021.

**City of Los Altos**  
**Management's Discussion and Analysis, Continued**  
**For the year ended June 30, 2021**

---

As noted earlier, the net position represents the difference between assets, the deferred outflow of resources and liabilities, and the deferred inflow of resources of the City's governmental activities and may over time serve as a useful indicator of the City's financial position. The City's governmental activities, assets, and deferred outflows exceeded liabilities and deferred inflows by \$107.7 million on June 30, 2021. Table 1 summarizes the City's governmental activities net position.

**TABLE 1**  
**Governmental Activities Statement of Net Position (In Millions)**

	<b>2021</b>	<b>2020</b>
Cash and investments	\$ 50.8	\$ 63.3
Other assets	9.8	6.4
Capital assets	105.8	81.9
<b>Total assets</b>	<b>165.7</b>	<b>151.6</b>
<b>Deferred outflows of resources</b>	<b>9.5</b>	<b>9.3</b>
Current liabilities	10.0	12.3
Non-current liabilities	56.7	44.1
<b>Total liabilities</b>	<b>66.7</b>	<b>56.4</b>
<b>Deferred inflows of resources</b>	<b>1.5</b>	<b>3.0</b>
Net Position		
Net investment in capital assets	95.5	80.9
Restricted	24.0	15.4
Unrestricted	(11.8)	5.2
<b>Total net position</b>	<b>\$ 107.7</b>	<b>\$ 101.5</b>



**City of Los Altos**  
**Management's Discussion and Analysis, Continued**  
**For the year ended June 30, 2021**

---

**Governmental Activities**

Of the governmental activities total net position, \$95.5 million, or 88.6%, reflects its net investment in capital assets (e.g., land, infrastructure, buildings, and equipment). The City uses these capital assets to provide services to citizens; consequently, these assets are not available for future spending.

The governmental activities total Assets of \$166.5 represent a \$14.9 million or a 9.8% increase, driven by higher receipts, capital activity, and lower spending due to the pandemic.

Capital Assets (net) increased by \$24.0 million or 29.3% primarily driven by additions from capital projects activity in the current year.

The governmental activities, total liabilities of \$66.7 million represent outstanding obligations for operations, capital projects, deposits held for development projects, long-term debt, and net pension liability. A portion of the governmental activities net position represents resources that are subject to restriction on how they may be used. Total liabilities increased by \$10.3 million or 18.2% due to higher accrued payroll and higher unearned revenues and grants receivables.

The following charts summarize governmental activities programs and general City revenues available for funding all City programs and major expense program categories.

For the fiscal year ended June 30, 2021, total revenues from all sources relating to governmental activities excluding transfers were \$53.4 million, and total expenses for all City programs relating to governmental activities were \$44.2 million.

**City of Los Altos  
 Management's Discussion and Analysis, Continued  
 For the year ended June 30, 2021**

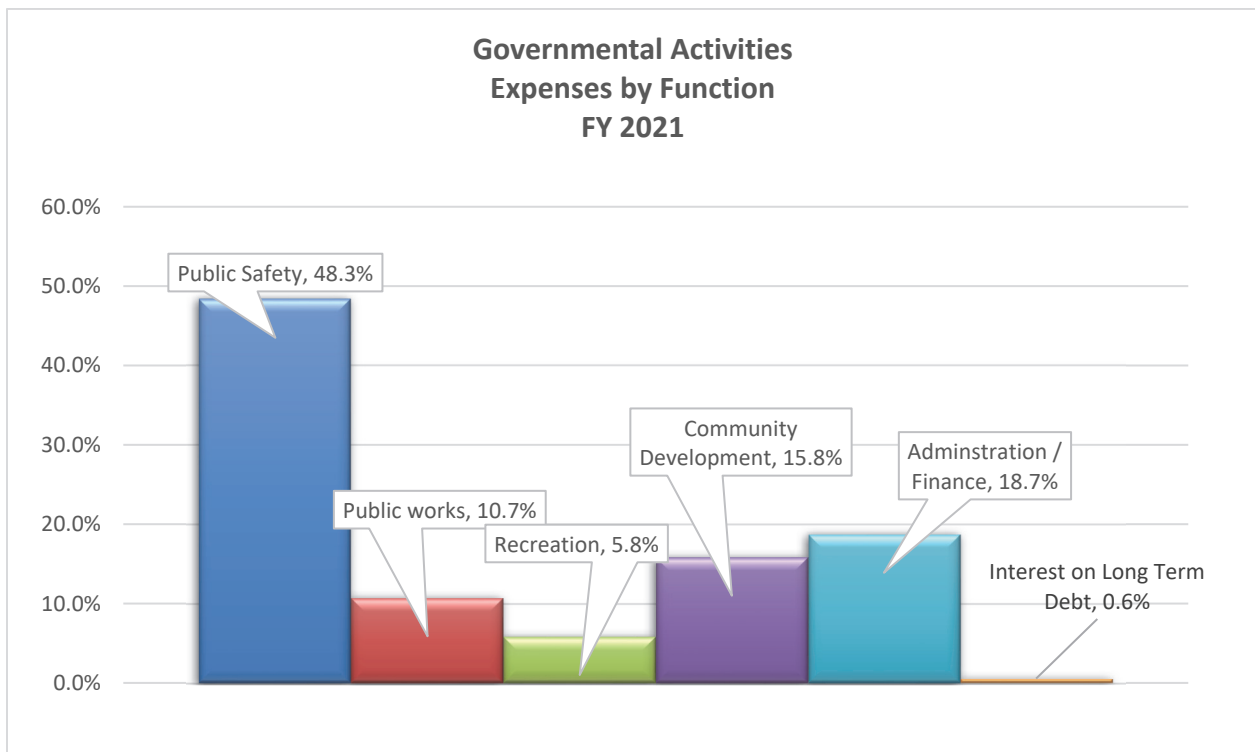
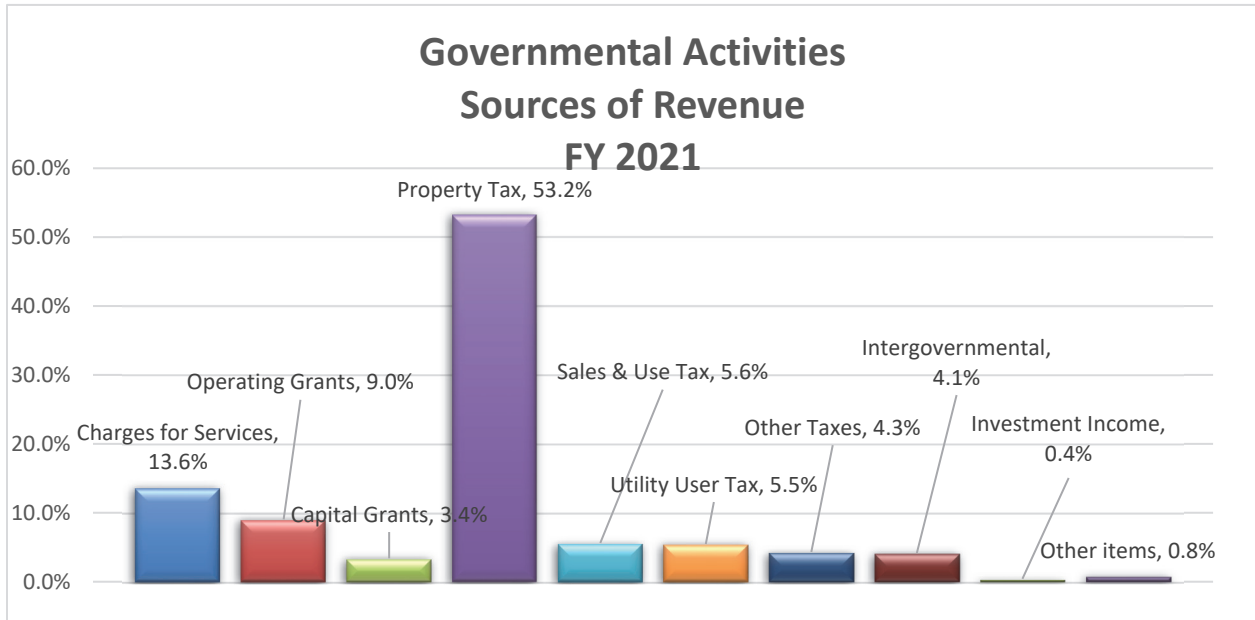

**City of Los Altos**  
**Management's Discussion and Analysis, Continued**  
**For the year ended June 30, 2021**

---

**TABLE 2**  
**Change in Net Position - Governmental Activities**  
**(In Millions)**

<b>Revenues</b>	<b>2021</b>	<b>2020</b>
Program revenues		
Charges for service	\$ 7.3	\$ 5.9
Operating contributions and grants	4.8	0.6
Capital grants	1.8	1.8
Total program revenues	<u>13.9</u>	<u>8.3</u>
General revenues		
Taxes:		
Property	28.4	25.8
Sales and use	3.0	3.4
Utility User	2.9	2.8
Other taxes	2.3	3.6
Intergovernmental	2.2	2.3
Investment income	0.2	2.6
Other	0.4	0.4
Total general revenues	<u>39.5</u>	<u>40.9</u>
Total revenues	<u>53.4</u>	<u>49.2</u>
<b>Expenses</b>		
Public Safety	21.4	21.2
Public works	4.7	7.7
Recreation	2.6	3.2
Community Development	7.0	6.6
Administration / Finance	8.3	9.8
Interest on Long Term Debt	0.2	0.0
Total expenses	<u>44.2</u>	<u>48.5</u>
Excess (deficiency) before transfers	9.1	0.7
Transfers (Net)	(2.8)	0.0
<b>Change in net position - Governmental Activities</b>	<u>6.3</u>	<u>0.7</u>
Net Position - Beginning of year	<u>101.4</u>	<u>100.7</u>
Net Position - End of year	<u>\$ 107.7</u>	<u>\$ 101.4</u>

**City of Los Altos**  
**Management's Discussion and Analysis, Continued**  
**For the year ended June 30, 2021**

---

Table 2 shows that governmental activities expenses, which totaled \$44.2 million, were lower than program revenues for governmental activities of \$53.4 million. These program revenues included \$7.3 million in charges for services, \$4.8 million in operating grants and contributions, and \$1.8 million in capital grants and contributions.

**Governmental Fund Revenues**

Charges for services include traffic safety fines, plan check fees, building inspection fees, other charges related to new construction, and fees charged for recreational activities and programs, these charges increased by \$1.4 million or 23.0% primarily due to the community development activity being robust during the year.

Operating grants and contributions include amounts contributed by developers and stimulus monies received from the federal government, these are restricted to either grant requirements, or have been designated for one-time expenses, while capital grants and contributions are required to fund capital investments. General revenues, as shown in Table 2 on the previous page, are available to pay for expenses not fully covered by program generated revenues during the year the City was granted \$4.2 million more in operating grants than the prior year due to the receipt of the ARPA and CARES act monies, while capital grants awarded were flat at \$1.8 million.

**Governmental Fund Expenditures**

**Public Safety** expenditures increased by \$0.2 million or 0.9% from the prior year primarily higher pension costs from the City's share of the Safety pension pool and higher depreciation charges, partly offset by vacant positions that decreased other personnel and benefit costs.

**Public works** expenditures decreased by \$3.0 million (-38.6%) compared to the prior year primarily due to lower depreciation charges than the past year, vacancy positions offset by salary increases, and lower operating and maintenance expenses.

**Community Development** expenditures increased \$0.4 million 6.1% from the prior fiscal year primarily attributable to larger expenses in the housing element, increase community development activity witnessed by higher revenues derived.

**Recreation expenditures** were lower by \$0.6 million (-19.6%) less than the prior year primarily due to an overall decrease in operations from the pandemic and closure of the community center.

**Administration and Finance** expenditures decreased by \$1.5 million (-15.4%) compared to the prior year primarily due to an overall decrease in operations from the pandemic and a substantial number of vacancies.

**City of Los Altos**  
**Management's Discussion and Analysis, Continued**  
**For the year ended June 30, 2021**

---

**Table 3**  
**Governmental Activities**  
**Program Revenues and Net (Expense) Revenue From Services**  
**(In Millions)**

	<u>Program Revenues</u>		<u>Net (Expense) Revenue</u>	
	<u>2021</u>	<u>2020</u>	<u>2021</u>	<u>2020</u>
Public Safety	\$ 4.3	\$ 0.5	\$ (17.0)	\$ (20.7)
Public works	2.2	2.3	(2.5)	(5.3)
Recreation	0.3	0.8	(2.3)	(2.4)
Community Development	6.1	3.5	(0.9)	(3.1)
Administration / Finance	1.0	1.2	(7.4)	(8.6)
Interest on Long Term Debt			(0.2)	(0.0)
<b>Totals</b>	<b><u>\$ 13.9</u></b>	<b><u>\$ 8.4</u></b>	<b><u>\$ (30.3)</u></b>	<b><u>\$ (40.1)</u></b>

**City of Los Altos**  
**Management's Discussion and Analysis, Continued**  
**For the year ended June 30, 2021**

---

**Business-Type Activities**

As shown in Table 4 below, the net position of the City's business-type activities was \$30.2 million on June 30, 2021. Assets totaling \$32.1 million included a total of \$17.0 million in cash and investments, \$0.4 in receivables and other assets, and \$14.7 million in capital assets. Liabilities totaled \$2.2 million include \$0.4 million in current liabilities and \$1.8 million in non-current liabilities such as compensated absences and other liabilities.

**Table 4**  
**Business - Type Activities Statement of Net Position**  
**(In Millions)**

	<b>2021</b>	<b>2020</b>
Cash and investments	\$ 17.0	\$ 16.8
Other assets	0.4	0.2
Capital assets	14.7	12.3
<b>Total assets</b>	<b>32.1</b>	<b>29.3</b>
 <b>Deferred outflows of resources</b>	 <b>0.4</b>	 <b>0.4</b>
 Current liabilities	 0.4	 0.1
Non-current liabilities	1.8	1.7
<b>Total liabilities</b>	<b>2.2</b>	<b>1.8</b>
 <b>Deferred inflows of resources</b>	 <b>0.1</b>	 <b>0.1</b>
 Net Position		
Net investment in capital assets	14.7	12.3
Restricted	0.0	0.0
Unrestricted	15.5	15.5
<b>Total net position</b>	<b>\$ 30.2</b>	<b>\$ 27.8</b>

**City of Los Altos**  
**Management's Discussion and Analysis, Continued**  
**For the year ended June 30, 2021**

Table 5 shows that Business type activities expenses, which totaled \$5.7 million, were augmented by revenues of \$8.1 million. These revenues included \$8.0 million in charges for services and \$0.1 million in interest, investment earnings, and others, thus adding \$2.4 million to the net position at the end of the year.

**Table 5**  
**Change in Net Position - Business-type Activities**  
**(In Millions)**

	<u>2021</u>	<u>2020</u>
<b>Revenues</b>		
Program revenues		
Charges for services	\$ 8.0	\$ 8.8
Total program revenues	<u>8.0</u>	<u>8.8</u>
General revenues		
Investment income and other	0.1	0.6
Total revenues	<u>8.1</u>	<u>9.4</u>
<b>Expenses</b>		
Outside Services	4.4	4.5
Employee services	0.9	1.1
Depreciation	0.4	0.4
Total expenses	<u>5.7</u>	<u>6.0</u>
Excess (deficiency) before transfers	2.4	3.4
Transfers	<u>0.0</u>	<u>0.0</u>
	<u>2.4</u>	<u>3.4</u>
<b>Change in net position - Business-type Activities</b>		
Net Position - Beginning of year	27.8	24.4
Net Position - End of year	<u>\$ 30.2</u>	<u>\$ 27.8</u>

The Joint Sewer System Authority (JSSA) formed in 1968 by a joint exercise of powers among the Cities of Palo Alto, Mountain View, and Los Altos, constructed, maintains, and operates sewage treatment facilities serving its member cities. The City of Palo Alto acts as administrator for JSSA and bills each member its share of the operating costs. Los Altos is obligated through the year 2018 under an operating agreement with the City of Palo Alto for the water treatment plant and sewer services. Payments under this agreement are based on expected usage and are adjusted annually based on actual use and site operating costs.

As projected in budgetary estimates and the prior year's financial reports, the Storm Drain fund has exhausted its reserves. Currently, the Storm Drain and Urban Runoff Pollution Control Programs (URPP) are categorized as enterprise activities but are lacking a fee that pays for these services.

**City of Los Altos**  
**Management's Discussion and Analysis, Continued**  
**For the year ended June 30, 2021**

---

**FUND FINANCIAL STATEMENTS AND FINANCIAL ANALYSIS**

These statements provide more detailed information about the City's major funds. A fund is a grouping of related accounts that is used to maintain control over resources that have been segregated for specific activities or objectives. The City, like other state and local governments, uses fund accounting to ensure and demonstrate compliance with finance-related legal requirements. All the funds of the City can be divided into three categories: governmental funds, proprietary funds, and fiduciary funds.

**Governmental funds**

Governmental funds are used to account for essentially the same functions reported as governmental activities in the government-wide financial statements. However, unlike the government-wide financial statements, governmental fund financial statements focus on near-term inflows and outflows of spendable resources, as well as on balances of spendable resources available at the end of the fiscal year. Such information may be useful in evaluating a City's or government agency's near-term financing requirements.

Because the focus of governmental funds is narrower than that of the government-wide financial statements, it is useful to compare the information presented for governmental funds with similar information presented for governmental activities in the government-wide financial statements. By doing so, readers may better understand the long-term impact of the government's near-term financing decisions. Both the governmental fund balance sheet and governmental fund statement of revenues, expenditures, and changes in fund balances provide a reconciliation to facilitate this comparison between governmental funds and governmental activities.

The City has several governmental funds, of which three are considered major funds for presentation purposes. Each major fund is presented separately in the governmental fund balance sheet and in the governmental fund statement of revenues, expenditures, and changes in fund balance. The City's three major funds are - the General Fund, the In Lieu Parkland Fund, and the Capital Investment Program Fund. Data from the other governmental funds are combined into a single, aggregated presentation.

The City Council adopts a biennial appropriated budget for its General Fund and other funds. Budgetary comparison statements have been provided in the Required Supplementary Information section for the general fund and major special revenue funds that demonstrate compliance with their budgets.

**Proprietary funds**

The City maintains two types of proprietary funds: Enterprise Funds and Internal Service Funds. Enterprise funds are used to report the same functions presented as business-type activities in the government-wide financial statements. The City uses enterprise funds to account for its Sewer, Solid Waste, and Storm Drain operations, all of which are classified as major funds in the City's Statement of Net Position. Internal service funds are used to accumulate and allocate costs internally among the City's various functions and to build up reserves for future liabilities related to the workforce. The City uses internal service funds to account for such activities as dental reimbursements, Unemployment Insurance, Workers' compensation, and liability insurance. Because these services solely benefit the governmental function, they have been included within governmental activities in the government-wide financial statements.



**City of Los Altos**  
**Management's Discussion and Analysis, Continued**  
**For the year ended June 30, 2021**

---

Proprietary fund financial statements provide the same type of information as the government-wide financial statements, only in more detail. All nine internal service funds are combined into a single, aggregated presentation in the proprietary fund financial statements. Individual fund data for the internal service funds is provided in the form of combining statements in the Supplemental Information section of this report.

**Fiduciary Funds**

The City is the agent for certain agencies and assessment districts, holding amounts collected that await payment as directed. The City's fiduciary activities are reported in the separate Statement of Fiduciary Net Position. These activities are excluded from the City's other financial statements because the City is acting as a trustee for these funds and cannot use these assets to finance its own operations. The City's fiduciary funds include The North Country Library Authority, the Raymundo Curb and Gutter special district that has fulfilled its life and obligation and will cease to report from the next year, and the Blue oak Lane Sewer special district.

**Summary Analysis of Governmental Funds**

On June 30, 2021, the City's governmental fund balances were \$46.2 million, which is an overall decrease of \$4.6 million, or -9.1%, as compared to the prior fiscal year. The following describes the specifics related to this variance:

- A decrease of \$12.7 million in the General Fund, primarily due to transferring of \$16.8 million held in the General Fund for the community center development (\$10M) and transferring another \$6.8M to the Capital projects fund, inclusive of the \$6.4 million of prior year unassigned fund balance. The remaining changes in fund balance were a combination of increased revenues in property tax, receipt of federal stimulus, and lower other revenues as explained earlier, departmental revenues increased, and when netted against operating expenditures came in below budget because of the COVID19 pandemic and higher than anticipated vacant positions.
- The In-lieu Parkland fund had higher revenues from development activity of \$1.6 million that were offset by transfers to Capital projects fund for eligible projects (\$1.3M)
- An increase of \$7.62 million in the capital projects funds was due to increased transfers from the general fund and the facilities reserve to fund capital projects such as facilities maintenance and construction of the Community center

**City of Los Altos**  
**Management's Discussion and Analysis, Continued**  
**For the year ended June 30, 2021**

**Table 6**  
**Statement of Revenues, Expenditures and Other Financing Sources/Uses**  
**Governmental Funds**  
**(In Millions)**

<b>Revenues</b>	<b>2021</b>	<b>2020</b>
Taxes:		
Property	\$ 28.5	\$ 25.8
Sales and Use	3.0	3.4
Utility Users	2.9	2.8
Other taxes	2.3	3.6
Licenses, permits and fees	4.6	4.2
Intergovernmental	4.2	1.3
Grants and Donations	4.0	1.4
Charges for services	3.2	3.7
Fines, forfeitures and penalties	0.1	0.2
Interest and Rentals	0.2	2.7
Other	0.4	0.1
	<u>53.4</u>	<u>49.2</u>
<b>Expenditures</b>		
Current:		
Public Safety	19.4	18.8
Public works	5.6	5.5
Recreation	1.8	2.3
Community Development	6.5	5.9
Administration / Finance	7.7	8.5
Capital Improvements	23.3	15.4
<i>Debt Service</i>		
Principal	0.6	0.1
Interest and Fiscal Charges	0.2	0.0
Total expenditures	<u>65.1</u>	<u>56.5</u>
<b>Excess (deficiency) before transfers</b>	<b>(11.7)</b>	<b>(7.3)</b>
<b>Other</b>		
Transfers (net)	10.0	(1.0)
Net change in fund balance	(1.7)	(8.3)
Beginning Fund Balance* Reinstated	\$ 47.9	59.1
<b>Ending Fund Balance</b>	<b>\$ 46.2</b>	<b>\$ 50.8</b>

**City of Los Altos**  
**Management's Discussion and Analysis, Continued**  
**For the year ended June 30, 2021**

---

***Detailed Analysis of Major Governmental Funds by Fund***

**General Fund**

The General Fund is the chief operating fund of the City. For the year ending June 30, 2021, the total fund balance was \$22.7 million, \$17.8 million of which is non-spendable, restricted, or has been committed or assigned to cover contingencies, claims, encumbrances, advances to other funds, and other City projects.

Revenues were \$2.4 million higher in the fiscal year ended June 30, 2021, compared to the last fiscal year, a change of 5.2%.

Expenditures decreased \$0.2 million in the fiscal year ended June 30, 2021, compared to last fiscal year, a change of -0.6%. Significant changes in revenues and expenditures that affected the General Fund balances are discussed below:

**General Fund Revenues**

**Property Taxes** overall increased by \$2.7 million (10.4%) compared to the prior year primarily attributable to continued increases in property values (assessed value) and increased residential sales activity that increased the tax roll.

**Sales and Use Taxes** overall decreased by \$0.4 million (-11.2%) compared to the prior year. This was due to the full year impacts faced by the global pandemic that started in March of 2020.

**Utility user Taxes** overall increased by \$0.1 million (2.8%) compared to the prior year. This was due to normal inflationary increases rather than an increased tax base.

**Charges for Services** decreased by \$0.7 million (-18.9%) from the prior year, mainly affected by the closing of all recreational activities during the construction of the new community center.

**Grants and donations** increased by \$3.9 million (4,424%) from the prior year, mainly due to the receipt of the American Rescue Plan Act and CARES Act stimulus monies allocated to cities.

**Other Taxes** decreased significantly by \$1.3 million (-35.9%) compared to the prior fiscal year, primarily due to lower levels of Transient Occupancy Taxes caused by lack of demand due to the pandemic.

**Interest and Rentals** decreased significantly by \$2.1 million (-91.8%) compared to the prior fiscal year, primarily due to the federal reserve bank reducing the discount rates to near zero in their attempts to stimulate the economy.

**City of Los Altos**  
**Management's Discussion and Analysis, Continued**  
**For the year ended June 30, 2021**

---

**General Fund Expenditures**

**Public Safety** expenditures increased by \$0.6 million (3.2%) from the prior year primarily due to increased personnel and benefit costs, offset by lower other expenses.

**Public works** expenditures increased by \$0.15 million (2.7%) compared to the prior year primarily due to salary increases, and other increased expenses on protection such as plexiglass screens and cleaning supplies for COVID-19 in the city facilities.

**Community development** expenditures increased \$0.8 million (15.1%) from the prior fiscal year primarily attributable to salary adjustments and an added position for sustainability, planned work on the housing element as well as increased consultant costs that resulted in higher revenues from planning activity.

**Recreation** expenditures were \$0.5 million (-23.0%) less than the prior year primarily due to an overall decrease in operations from the pandemic and closure of the community center for construction activity.

**Administration and Finance** expenditures decreased by \$0.8 million (-9.5%) compared to the prior year primarily due to an overall decrease in operations and many vacant positions.

**In-lieu Parkland**

The In-lieu Parkland Fund had revenues of \$1.6 million from in Lieu fees received during the year this was \$1.3 million higher than the prior year. Expenses included a transfer out to the capital projects fund of \$1.3 million.

**Capital Investment Program Fund**

The Capital Investment Program Fund accounts for funds used for capital improvements and significant maintenance projects. As of June 30, 2021, its fund balance was \$11.5 million, primarily due to monies transferred from the General Fund.

The Capital budget also has planned appropriations of almost \$60 million over the FY 22-26 CIP plan from various funding sources such as Gas tax, General fund, and enterprise funds.

**City of Los Altos**  
**Management's Discussion and Analysis, Continued**  
**For the year ended June 30, 2021**

---

***Summary Analysis of Proprietary Funds***

As of June 30, 2021, the Enterprise Funds had a net position balance of \$30.2 million, an increase of \$2.4 million from the prior year or 8.5%. The net position balance of the Internal Service Funds is \$2.3 million, down \$1.9 million from the previous fiscal year, due to the underfunding of workers' compensation and liability insurance due to the pandemic and using the available fund balances instead.

**Table 7**  
**Change in Fund Net Position - Proprietary Funds**  
**(In Millions)**

	<b>Total Enterprise Funds</b>		<b>Total Internal Service Funds</b>	
	<b>2021</b>	<b>2020</b>	<b>2021</b>	<b>2020</b>
Operating revenues	\$ 8.0	\$ 8.8	\$ 0.3	\$ 0.2
Operating expenses	5.7	6.0	2.1	1.8
<b>Operating income (loss)</b>	<b>2.3</b>	<b>2.9</b>	<b>(1.9)</b>	<b>(1.6)</b>
Non-operating revenues (expenses)	0.1	0.6	0.0	0.0
<b>Net income (loss) before contributions and operating transfers</b>	<b>2.4</b>	<b>3.4</b>	<b>(1.9)</b>	<b>(1.6)</b>
Transfers in (out) and Capital Contributions	0.0	0.0	0.0	1.0
<b>Change in net position</b>	<b>\$ 2.4</b>	<b>\$ 3.4</b>	<b>\$ (1.9)</b>	<b>\$ (0.6)</b>

**Sewer Fund**

This fund accounts for the administration and operation of the City's sewer system. The total net position is \$24.6 million; an increase of \$1.9 million.

**Solid Waste Fund**

This fund accounts for the administration and operation of the City's solid waste system. The total net position is \$5.6 million; an increase of \$0.5 million.

**City of Los Altos**  
**Management's Discussion and Analysis, Continued**  
**For the year ended June 30, 2021**

---

**BUDGETARY HIGHLIGHTS OF THE CITY'S GENERAL FUND**

Over the course of the year, the City Council revised the City's budget with adjustments for various revenue and expenditure changes. After taking into account these adjustments, General Fund actual revenues were higher than the final budget by \$6.3 million (15.1%), which is primarily attributable to higher property taxes and grants revenue, offset by lower sales tax, transient occupancy tax and recreation fees which were impacted by the pandemic and community center closure respectively.

General Fund actual expenditures were \$0.6 million (-1.6%) under the final budget, with significant savings in Public safety (\$0.95 million) partly offset by higher Administration and finance (\$0.35 million) due to higher legal fees and contract staffing to cover vacancies. Net unassigned fund balance for the year was \$4.9 million after accounting for contributions to the Capital projects, Debt service and others. Further details are provided in the Transmittal letter.

**CAPITAL ASSETS AND LONG-TERM DEBT**

*Capital Assets*

The City records all of its capital assets, including infrastructure in the Statement of Net Position. Infrastructure includes roads, bridges, signals, and similar assets used by the entire population. The City has recorded its capital assets at historical cost or estimated historical cost if the actual historical cost was not available. In addition, donated fixed assets have been valued at their estimated acquisition value on the date donated.

At June 30, 2021, the cost of infrastructure and other capital assets recorded on the City's financial statements is shown in Table 8 on the next page:

**City of Los Altos**  
**Management's Discussion and Analysis, Continued**  
**For the year ended June 30, 2021**

---

**Table 8**  
**Capital Assets**  
**(in Millions)**

	<u>2021</u>	<u>2020</u>
<b>Governmental activities</b>		
Land	\$ 14.5	\$ 11.6
Construction in progress	45.6	24.1
Buildings	21.6	21.6
Improvements	6.5	6.5
Machinery and equipment	7.1	6.9
Infrastructure	46.6	45.0
Less accumulated depreciation	(36.1)	(33.9)
<b>Totals</b>	<b><u>\$ 105.8</u></b>	<b><u>\$ 81.8</u></b>
<b>Business-type activities</b>		
Construction in progress	\$ 1.4	\$ 1.3
Buildings	17.9	18.0
Machinery and equipment	1.1	1.1
Infrastructure	8.1	5.3
Less accumulated depreciation	(13.8)	(13.4)
<b>Totals</b>	<b><u>\$ 14.7</u></b>	<b><u>\$ 12.3</u></b>

At June 30, 2021, the City had assets of \$105.8 million, net of depreciation, invested in a broad range of capital assets used in governmental activities and \$14.7 million, also net of depreciation, invested in Business-type activities assets, as shown in Table 8 above.

The City depreciates all its capital assets on a straight-line basis over their estimated useful lives. The purpose of depreciation is to spread the cost of a capital asset over the years of its useful life so that an allocable portion of the cost of the asset is borne by all users. Additional information on capital assets may be found in Notes 1 and 5 to the Basic Financial Statements.

**City of Los Altos**  
**Management’s Discussion and Analysis, Continued**  
**For the year ended June 30, 2021**

---

*Long Term Debt*

At June 30, 2021, the City's debt was comprised of the following:

**Table 9**  
**Outstanding Debt**  
**(In Millions)**

	<u>2021</u>	<u>2020</u>
<b>Governmental activities</b>		
2004 Certificate of Participation	\$ 0.9	\$ 1.0
Community Center Lease	9.5	0.0
Compensated Absences	1.9	2.0
Total governmental activities debt	<u>\$ 12.3</u>	<u>\$ 3.0</u>
<b>Business-type activities</b>		
Compensated Absences	\$ 0.1	\$ 0.1
Total business-type activities debt	<u>\$ 0.1</u>	<u>\$ 0.1</u>
<b>Total debt</b>	<u><b>\$ 12.4</b></u>	<u><b>\$ 3.1</b></u>

The City made all required debt service payments on the issues listed above. As related to the community center that is expected to be completed in the fiscal year 2022.

**ECONOMIC OUTLOOK AND MAJOR INITIATIVES**

The City has enjoyed several consecutive strong financial years. This has been driven by growth in property tax and sales tax and steady revenues from direct services. Economic development and the strength of the Bay Area and national economy have driven continued growth in revenues. Meanwhile, expenses have grown due to inflationary increases, negotiated wage increases, and pension cost increases.

Over the last several years Los Altos has experienced ongoing growth in major tax revenue categories and increases in revenues from fee-based services. This trend was buckled due to COVID-19 pandemic. Sales Tax, Transient Occupancy Tax, and fee-based service revenues declined during the year as a result.

The most significant financial challenges for the City are the ongoing stress on revenues due to the COVID-19 pandemic, the projected increases in pension costs, and identifying resources to replace aging capital infrastructure. Funds to replace buildings and other facilities are inadequate.



**City of Los Altos**  
**Management's Discussion and Analysis, Continued**  
**For the year ended June 30, 2021**

---

In December 2016, CalPERS reduced its expected return on investments from 7.5% to 7.0% which were effective starting fiscal year 2019. This action coupled with other assumption changes made by CalPERS is resulting in a substantial increase in pension contributions for employers.

The City Council renewed its commitment to address this challenge by creating a Pension reserve of \$5 million. The reserve is an essential tool to help the City address pension cost increases in future years.

The City Council has also identified funding capital infrastructure as a high-priority area and is working to identify current and future facility needs and potential funding options to address those needs.

**Major Capital Projects in construction for fiscal years 2021-21 and beyond include:**

- \$20,088,533 - Hillview Community Center Redevelopment
- 1,482,295 - Annual Sewer Structural Reach Replacement
- 1,151,484- Annual Sewer System Repair Program
- 663,979 - Annual Street Resurfacing
- 551,391 - Annual Collector Street Traffic Calming
- 531,566 - El Monte Ave Sidewalk Gap closure (School route project)
- 303,508 - IT Initiatives

**CONTACTING THE CITY'S FINANCIAL MANAGEMENT**

This Annual Comprehensive Financial Report is intended to provide citizens, taxpayers, investors, and creditors with a general overview of the City's finances. Questions about this report should be directed to the following address: City of Los Altos, Finance Department, 1 North San Antonio Road, Los Altos, California 94022.

A copy of this financial report can be found on the City's website at <http://www.losaltosca.gov>, by selecting "Audited Financials" in the "Quick Links" section and then selecting "Other Financial Reports."



*This Page Left Intentionally Blank*

**CITY OF LOS ALTOS**

**GOVERNMENT-WIDE FINANCIAL STATEMENTS**

**STATEMENT OF NET POSITION  
AND STATEMENT OF ACTIVITIES**



*This Page Left Intentionally Blank*

CITY OF LOS ALTOS  
STATEMENT OF NET POSITION  
JUNE 30, 2021

	Governmental Activities	Business-Type Activities	Total
<b>ASSETS</b>			
Current assets:			
Cash and investments (Note 2)	\$50,832,035	\$17,008,151	\$67,840,186
Accounts receivable	7,645,179	399,613	8,044,792
Interest receivable	104,135	36,613	140,748
Prepaid items and inventory (Note 1H)	145,196		145,196
Note receivable (Note 4)	1,704,880		1,704,880
Internal balances	7,969	(7,969)	
Total current assets	<u>60,439,394</u>	<u>17,436,408</u>	<u>77,875,802</u>
Noncurrent assets:			
Restricted cash and investments (Note 2)	172,021		172,021
Capital assets (Note 5):			
Non-depreciable	60,160,965	1,361,354	61,522,319
Depreciable, net of accumulated depreciation	<u>45,678,518</u>	<u>13,288,249</u>	<u>58,966,767</u>
Total noncurrent assets	<u>106,011,504</u>	<u>14,649,603</u>	<u>120,661,107</u>
Total Assets	<u>166,450,898</u>	<u>32,086,011</u>	<u>198,536,909</u>
<b>DEFERRED OUTFLOWS OF RESOURCES</b>			
Related to pension (Note 11)	9,208,836	346,658	9,555,494
Related to OPEB (Note 12)	<u>245,121</u>	<u>18,450</u>	<u>263,571</u>
Total deferred outflows of resources	<u>9,453,957</u>	<u>365,108</u>	<u>9,819,065</u>
<b>LIABILITIES</b>			
Current liabilities:			
Accounts payable	6,655,640	345,022	7,000,662
Interest payable	6,233		6,233
Accrued liabilities	1,104,842	38,515	1,143,357
Other payable	112,768		112,768
Compensated absences, due in one year (Note 7)	481,010	26,845	507,855
Claims and judgements, due in one year (Note 9)	1,072,302		1,072,302
Long-term debt, due in one year (Note 6)	<u>534,612</u>		<u>534,612</u>
Total current liabilities	<u>9,967,407</u>	<u>410,382</u>	<u>10,377,789</u>
Noncurrent liabilities:			
Compensated absences, due in more than one year (Note 7)	1,443,028	80,536	1,523,564
Claims and judgments, due in more than one year (Note 9)	3,148,698		3,148,698
Net pension liability (Note 11)	40,741,084	1,628,033	42,369,117
Net OPEB liability (Note 12)	1,522,251	103,208	1,625,459
Long-term debt, due in more than one year (Note 6)	<u>9,842,251</u>		<u>9,842,251</u>
Total noncurrent liabilities	<u>56,697,312</u>	<u>1,811,777</u>	<u>58,509,089</u>
Total Liabilities	<u>66,664,719</u>	<u>2,222,159</u>	<u>68,886,878</u>
<b>DEFERRED INFLOWS OF RESOURCES</b>			
Related to pension (Note 11)	1,146,611	42,158	1,188,769
Related to OPEB (Note 12)	359,169	27,034	386,203
Related to revenue	<u>677</u>		<u>677</u>
Total deferred inflows of resources	<u>1,506,457</u>	<u>69,192</u>	<u>1,575,649</u>
<b>NET POSITION (Note 8)</b>			
Net investments in capital assets	<u>95,462,620</u>	<u>14,649,603</u>	<u>110,112,223</u>
Restricted for:			
Debt service	373,551		373,551
Special revenue programs:			
Public safety	146,007		146,007
Recreation	5,780,278		5,780,278
Streets and roads	3,979,673		3,979,673
Public education	906,165		906,165
Parking	889,174		889,174
Other	74,224		74,224
Capital projects	<u>11,872,141</u>		<u>11,872,141</u>
Total Restricted Net Position	<u>24,021,213</u>		<u>24,021,213</u>
Unrestricted	<u>(11,750,154)</u>	<u>15,510,165</u>	<u>3,760,011</u>
Total Net Position	<u>\$107,733,679</u>	<u>\$30,159,768</u>	<u>\$137,893,447</u>

See accompanying notes to financial statements

CITY OF LOS ALTOS  
STATEMENT OF ACTIVITIES  
FOR THE YEAR ENDED JUNE 30, 2021

Functions/Programs	Expenses	Program Revenues		Total	
		Charges for Services	Operating Grants and Contributions		Capital Grants and Contributions
Primary government:					
Governmental Activities:					
Public safety	\$21,383,819	\$201,547	\$4,140,121		\$4,341,668
Public works	4,741,500	59,512	378,773	\$1,778,354	2,216,639
Recreation	2,584,001	271,410			271,410
Community development	7,004,132	5,792,569	305,535	31,462	6,129,566
Admin / community services	8,282,306	953,780			953,780
Interest on long-term debt	244,697				
Total Governmental Activities	<u>44,240,455</u>	<u>7,278,818</u>	<u>4,824,429</u>	<u>1,809,816</u>	<u>13,913,063</u>
Business-type Activities:					
Sewer	5,268,426	7,126,024			7,126,024
Solid waste	394,443	860,900			860,900
Storm drain	21				
Total Business-type Activities	<u>5,662,890</u>	<u>7,986,924</u>			<u>7,986,924</u>
Total primary government	<u>\$49,903,345</u>	<u>\$15,265,742</u>	<u>\$4,824,429</u>	<u>\$1,809,816</u>	<u>\$21,899,987</u>
General revenues:					
Taxes:					
Property taxes					
Sales and use taxes					
Utility users' tax					
Other taxes					
Franchise fees					
Total taxes					
Interest income					
Miscellaneous					
Total general revenues					
Change in Net Position					
Net Position-Beginning, as restated (Note 8)					
Net Position-Ending					

See accompanying notes to financial statements

Net (Expense) Revenue and  
Changes in Net Position

Governmental Activities	Business-type Activities	Total
(\$17,042,151)		(\$17,042,151)
(2,524,861)		(2,524,861)
(2,312,591)		(2,312,591)
(874,566)		(874,566)
(7,328,526)		(7,328,526)
(244,697)		(244,697)
<u>(30,327,392)</u>		<u>(30,327,392)</u>
	\$1,857,598	1,857,598
	466,457	466,457
	(21)	(21)
	<u>2,324,034</u>	<u>2,324,034</u>
<u>(30,327,392)</u>	<u>2,324,034</u>	<u>(28,003,358)</u>
28,464,193		28,464,193
2,996,325		2,996,325
2,917,252		2,917,252
2,303,893		2,303,893
2,214,947		2,214,947
38,896,610		38,896,610
173,406	47,270	220,676
428,002		428,002
<u>39,498,018</u>	<u>47,270</u>	<u>39,545,288</u>
9,170,626	2,371,304	11,541,930
<u>98,563,053</u>	<u>27,788,464</u>	<u>126,351,517</u>
<u>\$107,733,679</u>	<u>\$30,159,768</u>	<u>\$137,893,447</u>



*This Page Left Intentionally Blank*



## FUND FINANCIAL STATEMENTS

The funds described below were determined to be Major Funds by the City in fiscal 2021. Individual non-major funds may be found in the Supplemental section.

### **GENERAL FUND**

Accounts for all financial resources necessary to carry out basic governmental activities of the City that are not accounted for in other funds. The General Fund supports essential City services such as police, fire, street and parks maintenance, maintenance services, community development and recreation activities. The General Fund also includes the Real Property Proceeds Funds, which accounts for the proceeds from the sale of real property and the Community Facilities Renewal Fund, which accounts for the revenues and expenditures related to the community facilities renewal efforts.

### **IN-LIEU PARK LAND FUND**

Accounts for revenues received in lieu of park land dedications. The revenues are dedicated for purchasing or improving park or recreational facilities.

### **CAPITAL PROJECTS FUND**

Accounts for the acquisition and construction of major capital projects and plans that are financed by resources other than proprietary funds.

CITY OF LOS ALTOS  
GOVERNMENTAL FUNDS  
BALANCE SHEET  
JUNE 30, 2021

	General	In-Lieu Park Land Fund	Capital Projects Fund	Other Governmental Funds	Total Governmental Funds
<b>ASSETS</b>					
Cash and investments (Note 2)	\$18,693,565	\$5,770,870	\$14,280,786	\$5,456,537	\$44,201,758
Restricted cash and investments (Note 2)				172,021	172,021
Receivables, net of allowance for uncollectibles:					
Accounts	6,224,645		57,085	1,346,451	7,628,181
Interest	88,052	16,083			104,135
Prepays (Note 1H)	66,176				66,176
Note receivable (Note 4)	1,704,880				1,704,880
Inventory (Note 1H)	79,020				79,020
Due from other funds (Note 3)	850,985				850,985
<b>Total Assets</b>	<b>\$27,707,323</b>	<b>\$5,786,953</b>	<b>\$14,337,871</b>	<b>\$6,975,009</b>	<b>\$54,807,156</b>
<b>LIABILITIES</b>					
Accounts payable	\$3,765,318	\$6,675	\$2,855,189	\$53	\$6,627,235
Accrued liabilities	1,104,842				1,104,842
Other payable	112,768				112,768
Due to other funds (Note 3)				748,269	748,269
<b>Total Liabilities</b>	<b>4,982,928</b>	<b>6,675</b>	<b>2,855,189</b>	<b>748,322</b>	<b>8,593,114</b>
<b>DEFERRAL INFLOWS OF RESOURCES</b>					
Deferred inflows of revenues	677				677
<b>Total Deferred Inflows</b>	<b>677</b>				<b>677</b>
<b>FUND BALANCES</b>					
Fund balance (Note 8):					
Nonspendable	1,858,691				1,858,691
Restricted		\$5,780,278		6,368,794	12,149,072
Assigned	15,936,861		11,482,682	389,459	27,809,002
Unassigned	4,928,166			(531,566)	4,396,600
<b>Total Fund Balances</b>	<b>22,723,718</b>	<b>5,780,278</b>	<b>11,482,682</b>	<b>6,226,687</b>	<b>46,213,365</b>
<b>Total Liabilities, Deferred inflow of resources and Fund Balances</b>	<b>\$27,707,323</b>	<b>\$5,786,953</b>	<b>\$14,337,871</b>	<b>\$6,975,009</b>	<b>\$54,807,156</b>

See accompanying notes to financial statements

CITY OF LOS ALTOS  
 Reconciliation of the  
 GOVERNMENTAL FUNDS -- BALANCE SHEET  
 with the  
 STATEMENT OF NET POSITION  
 JUNE 30, 2021

Fund balances of governmental funds \$46,213,365

Amounts reported for Governmental Activities in the Statement of Net Position are different because:

Capital assets used in Governmental Activities are not current financial resources. Therefore, were not reported in the governmental funds balance sheet:

Land, buildings, property, equipment and infrastructure, net 105,839,483

Interest payable on long-term debt does not require current financial resources. Therefore, interest payable was not reported as a liability in the governmental funds balance sheet.

(6,233)

Deferred outflows below are not current assets of financial resources; and the deferred inflows are not due and payable in the current period and therefore are not reported in the Governmental Funds.

Deferred outflows 9,453,957

Deferred inflows (1,505,780)

Long-term liabilities are not due and payable in the current period. Therefore, they were not reported in the governmental funds balance sheet.

Long-term debt - current portion (534,612)

Long-term debt - noncurrent portion (9,842,251)

Net pension liability (40,741,084)

Net OPEB liability (1,522,251)

Compensated absences - current portion (481,010)

Compensated absences - noncurrent portion (1,443,028)

Internal service funds are used by management to charge the costs of certain activities to individual funds. The assets and liabilities of the internal service funds are included in governmental activities in the governmental-wide statement of net position.

2,303,123

NET POSITION OF GOVERNMENTAL ACTIVITIES

\$107,733,679

See accompanying notes to financial statements

CITY OF LOS ALTOS  
GOVERNMENTAL FUNDS  
STATEMENT OF REVENUES, EXPENDITURES AND CHANGES IN FUND BALANCES  
FOR THE YEAR ENDED JUNE 30, 2021

	General	In-Lieu Park Land Fund	Capital Projects Fund	Other Governmental Funds	Total Governmental Funds
<b>REVENUES</b>					
Property tax	\$28,464,193				\$28,464,193
Sales tax	2,996,325				2,996,325
Utility users	2,917,252				2,917,252
Other tax	2,306,393				2,306,393
Licenses, permits and fees	4,392,246			\$152,842	4,545,088
Intergovernmental		\$1,541,500	\$57,085	2,556,327	4,154,912
Grants and donations	3,986,394		30,312		4,016,706
Charges for services	2,958,245			262,404	3,220,649
Fines and forfeitures	131,467			6,636	138,103
Interest and rentals	184,032	19,049		30,610	233,691
Other	106,487			311,282	417,769
<b>Total Revenues</b>	<b>48,443,034</b>	<b>1,560,549</b>	<b>87,397</b>	<b>3,320,101</b>	<b>53,411,081</b>
<b>EXPENDITURES</b>					
<b>General government</b>					
Public safety	19,389,523			460	19,389,983
Public works	5,616,637				5,616,637
Recreation	1,782,214				1,782,214
Community development	6,357,369			87,612	6,444,981
Admin / community development	7,702,229				7,702,229
Capital improvements		17,564	22,845,200	480,310	23,343,074
Debt service:					
Principal				628,137	628,137
Interest and fiscal charges				239,264	239,264
<b>Total Expenditures</b>	<b>40,847,972</b>	<b>17,564</b>	<b>22,845,200</b>	<b>1,435,783</b>	<b>65,146,519</b>
<b>EXCESS (DEFICIENCY) OF REVENUES OVER EXPENDITURES</b>	<b>7,595,062</b>	<b>1,542,985</b>	<b>(22,757,803)</b>	<b>1,884,318</b>	<b>(11,735,438)</b>
<b>OTHER FINANCING SOURCES (USES)</b>					
Proceeds from Lease	100,000			9,900,000	10,000,000
Transfers in (Note 3)	146,176		30,537,813	867,400	31,551,389
Transfers (out) (Note 3)	(17,648,572)	(1,300,000)		(12,602,817)	(31,551,389)
<b>Total Other Financing Sources (Uses)</b>	<b>(17,402,396)</b>	<b>(1,300,000)</b>	<b>30,537,813</b>	<b>(1,835,417)</b>	<b>10,000,000</b>
<b>NET CHANGE IN FUND BALANCES</b>	<b>(9,807,334)</b>	<b>242,985</b>	<b>7,780,010</b>	<b>48,901</b>	<b>(1,735,438)</b>
<b>BEGINNING FUND BALANCES, AS RESTATED (NOTE 8)</b>	<b>32,531,052</b>	<b>5,537,293</b>	<b>3,702,672</b>	<b>6,177,786</b>	<b>47,948,803</b>
<b>ENDING FUND BALANCES</b>	<b>\$22,723,718</b>	<b>\$5,780,278</b>	<b>\$11,482,682</b>	<b>\$6,226,687</b>	<b>\$46,213,365</b>

See accompanying notes to financial statements

CITY OF LOS ALTOS  
 Reconciliation of the  
 NET CHANGE IN FUND BALANCES - TOTAL GOVERNMENTAL FUNDS  
 with the  
 STATEMENT OF ACTIVITIES  
 FOR THE YEAR ENDED JUNE 30, 2021

Net change in fund balances of governmental funds	(\$1,735,438)
Amounts reported for governmental activities in the Statement of Activities are different because:	
CAPITAL ASSETS TRANSACTIONS	
Governmental Funds report capital outlays as expenditures. However, in the government-wide statement of activities and changes in net position, the cost of those assets is capitalized and allocated over their estimated useful lives as depreciation expense. This is the amount of capital assets recorded in the current period.	26,347,402
Depreciation expense on capital assets is reported in the government wide statement of activities and changes in net position, but they do not require the use of current financial resources. Therefore, depreciation expense is not reported as expenditures in governmental funds.	(2,381,714)
Repayment of bond principal is an expenditure in the governmental funds, but the repayment reduces long-term liabilities in the statement of net position. Principal payment	(9,371,863)
The amounts below included in the Statement of Activities do not provide or require the use of current financial resources and therefore are not reported as revenue or expenditures in governmental funds (net change):	
Compensated absences	66,642
Interest payable	(5,433)
Net OPEB liability, and related deferred outflows and inflows of resources	(100,217)
Net pension liability, and related deferred outflows and inflows of resources	(1,789,176)
Internal Service Funds are used by management to charge the costs of certain activities such as insurance, to individual funds. The net revenue of the internal service funds is reported with governmental activities.	<u>(1,859,577)</u>
Changes in net position of governmental activities	<u><u>\$9,170,626</u></u>

See accompanying notes to financial statements



*This Page Left Intentionally Blank*

<b>MAJOR PROPRIETARY FUNDS</b>
--------------------------------

Proprietary funds account for City operations financed and operated in a manner similar to a private business enterprise. The intent of the City is that the cost of providing goods and services be financed primarily through user charges.

The City reported all of its Enterprise Funds as major funds in fiscal 2021.

**SEWER**

To account for the operation (including waste water treatment) of the City's sewer treatment activities, a self-supporting activity which provides services on a user charge basis.

**SOLID WASTE**

To account for the collection and disposal of solid waste, a self-supporting activity that provides service on a user charge basis.

**STORM DRAIN**

To account for the operation of the City's urban runoff and storm drain activities.

CITY OF LOS ALTOS  
 PROPRIETARY FUNDS  
 STATEMENT OF NET POSITION  
 JUNE 30, 2021

	Business-type Activities-Enterprise Funds			Governmental Activities- Internal Service Funds	
	Sewer	Solid Waste	Storm Drain		Totals
<b>ASSETS</b>					
Current Assets:					
Cash and investments (Note 2)	\$11,459,886	\$5,548,265		\$17,008,151	\$6,630,277
Accounts receivable	321,898	77,715		399,613	16,998
Interest receivable	24,285	12,328		36,613	
Total Current Assets	<u>11,806,069</u>	<u>5,638,308</u>		<u>17,444,377</u>	<u>6,647,275</u>
Non-Current Assets:					
Capital assets (Note 5):					
Nondepreciable	1,361,354			1,361,354	
Depreciable	25,148,928		\$1,969,221	27,118,149	
Less accumulated depreciation	(11,860,679)		(1,969,221)	(13,829,900)	
Total capital assets, net	<u>14,649,603</u>			<u>14,649,603</u>	
Total non-current Assets	<u>14,649,603</u>			<u>14,649,603</u>	
Total Assets	<u>26,455,672</u>	<u>5,638,308</u>		<u>32,093,980</u>	<u>6,647,275</u>
DEFERRAL OUTFLOWS OF RESOURCES					
Related to pension (Note 11)	346,658			346,658	
Related to OPEB (Note 12)	14,497	1,318	2,635	18,450	
Total Deferred Outflows	<u>361,155</u>	<u>1,318</u>	<u>2,635</u>	<u>365,108</u>	
LIABILITIES					
Current Liabilities:					
Accounts payable	320,781	24,220	21	345,022	28,405
Accrued liabilities	38,515			38,515	
Due to other funds (Note 3)			7,969	7,969	94,747
Compensated absences (Note 7)	26,845			26,845	
Claims and judgements (Note 9)					1,072,302
Total Current Liabilities	<u>386,141</u>	<u>24,220</u>	<u>7,990</u>	<u>418,351</u>	<u>1,195,454</u>
Long-Term Liabilities					
Compensated absences (Note 7)	80,536			80,536	
Claims and judgements (Note 9)					3,148,698
Net pension liabilities (Note 11)	1,628,033			1,628,033	
Net OPEB liabilities (Note 12)	81,093	7,373	14,742	103,208	
Total Noncurrent Liabilities	<u>1,789,662</u>	<u>7,373</u>	<u>14,742</u>	<u>1,811,777</u>	<u>3,148,698</u>
Total Liabilities	<u>2,175,803</u>	<u>31,593</u>	<u>22,732</u>	<u>2,230,128</u>	<u>4,344,152</u>
DEFERRAL INFLOWS OF RESOURCES					
Related to pension (Note 11)	42,158			42,158	
Related to OPEB (Note 12)	21,241	1,931	3,862	27,034	
Total Deferred Inflows	<u>63,399</u>	<u>1,931</u>	<u>3,862</u>	<u>69,192</u>	
NET POSITION (Note 8)					
Net investment in capital assets	14,649,603			14,649,603	
Unrestricted (deficit)	9,928,022	5,606,102	(23,959)	15,510,165	2,303,123
Total Net Position (Deficit)	<u>\$24,577,625</u>	<u>\$5,606,102</u>	<u>(\$23,959)</u>	<u>\$30,159,768</u>	<u>\$2,303,123</u>

See accompanying notes to financial statements



CITY OF LOS ALTOS  
 PROPRIETARY FUNDS  
 STATEMENT OF REVENUES, EXPENSES  
 AND CHANGES IN FUND NET POSITION  
 FOR THE YEAR ENDED JUNE 30, 2021

	Business-type Activities-Enterprise Funds			Totals	Governmental
	Sewer	Solid Waste	Storm Drain		Activities- Internal Service Funds
OPERATING REVENUES					
Charges for services	\$7,126,024	\$860,900		\$7,986,924	\$273,028
Total Operating Revenues	7,126,024	860,900		7,986,924	273,028
OPERATING EXPENSES					
Outside services	3,936,433	377,651	\$21	4,314,105	52,830
Employee services	905,989	16,792		922,781	
Repairs and maintenance					
Claims and insurance					1,918,649
Administration					161,126
Depreciation	426,004			426,004	
Total Operating Expenses	5,268,426	394,443	21	5,662,890	2,132,605
Operating Income (Loss)	1,857,598	466,457	(21)	2,324,034	(1,859,577)
NONOPERATING REVENUES					
Interest	32,649	14,621		47,270	
Total Nonoperating Revenues	32,649	14,621		47,270	
Change in Net Position	1,890,247	481,078	(21)	2,371,304	(1,859,577)
BEGINNING NET POSITION	22,687,378	5,125,024	(\$23,938)	27,788,464	4,162,700
ENDING NET POSITION (DEFICIT)	\$24,577,625	\$5,606,102	(\$23,959)	\$30,159,768	\$2,303,123

See accompanying notes to financial statements

CITY OF LOS ALTOS  
 PROPRIETARY FUNDS  
 STATEMENT OF CASH FLOWS  
 FOR THE YEAR ENDED JUNE 30, 2021

	Business-type Activities-Enterprise Funds			Governmental Activities- Internal Service Funds	
	Sewer	Solid Waste	Storm Drain		Totals
<b>CASH FLOWS FROM OPERATING ACTIVITIES</b>					
Cash received from customers	\$6,923,171	\$855,678		\$7,778,849	\$315,820
Cash payments to suppliers for goods and services	(3,656,621)	(402,818)		(4,059,439)	
Cash payment employees for services	(794,205)	(16,792)		(810,997)	
Cash payments to claimants					(59,336)
Insurance premiums, settlements and rebates					(1,710,179)
					<u>(1,710,179)</u>
Cash Flows from (used for) Operating Activities	<u>2,472,345</u>	<u>436,068</u>		<u>2,908,413</u>	<u>(1,453,695)</u>
<b>CASH FLOWS FROM CAPITAL AND RELATED FINANCING ACTIVITIES</b>					
Acquisition of capital assets	(2,787,409)			(2,787,409)	
Proceeds from disposal of capital assets					
Cash Flows (used for) Capital and Related Financing Activities	<u>(2,787,409)</u>			<u>(2,787,409)</u>	
<b>CASH FLOWS FROM INVESTING ACTIVITIES</b>					
Interest received	32,649	14,621		47,270	
Cash Flows from Investing Activities	<u>32,649</u>	<u>14,621</u>		<u>47,270</u>	
Net Cash Flows	(282,415)	450,689		168,274	(1,453,695)
Cash and investments at beginning of period	11,742,301	5,097,576		16,839,877	8,083,972
Cash and investments at end of period	<u>\$11,459,886</u>	<u>\$5,548,265</u>		<u>\$17,008,151</u>	<u>\$6,630,277</u>
<b>Reconciliation of Operating Income (Loss) to Cash Flows from Operating Activities:</b>					
Operating income (loss)	\$1,857,598	\$466,457	(\$21)	\$2,324,034	(\$1,859,577)
Adjustments to reconcile operating income to cash flows from operating activities:					
Depreciation	426,004			426,004	
Change in assets and liabilities:					
Receivables, net	(202,853)	(5,222)		(208,075)	(1,873)
Accounts payable and other accrued expenses	279,812	(25,167)	21	254,666	(107,910)
Due to other funds			(2,111)	(2,111)	44,665
Net pension liabilities and deferred inflows and outflows	64,877			64,877	
Net OPEB liabilities	11,610		2,111	13,721	
Compensated absences	35,297			35,297	
Claims and judgments					471,000
					<u>471,000</u>
Cash Flows from (used for) Operating Activities	<u>\$2,472,345</u>	<u>\$436,068</u>		<u>\$2,908,413</u>	<u>(1,453,695)</u>

See accompanying notes to financial statements

<b>FIDUCIARY FUNDS</b>
------------------------

**CUSTODIAL FUNDS**

Custodial Funds are custodial in nature and does not involve measurement of the results of operations. It is used to account for assets held in a custodial capacity for others and therefore cannot be used to support the City's programs. The City has the following custodial funds:

**NORTH COUNTY LIBRARY AUTHORITY**

This fund accounts for the operating activities and the special assessment collection pertaining to the North County Library Authority.

**RAYMUNDO CURB AND GUTTER**

This fund accounts for the accumulation of resources for payment of the debt service related to the construction and installation of curbs and gutters. The revenue is derived from the special assessment levied to property owners within that improvement district.

**BLUE OAK LANE SEWER**

This fund accounts for the accumulation of resources for payment of the debt service and installation of sanitary sewer systems on Blue Oak Lane funded via November 2009 limited obligation assessment district bonds. The revenue is derived from the special assessment levied to property owners within that improvement district.

CITY OF LOS ALTOS  
 FIDUCIARY FUNDS  
 STATEMENT OF NET POSITION  
 JUNE 30, 2021

	Custodial Funds		
	North County Library Authority	Raymundo Curb and Gutter	Blue Oak Lane Sewer
<b>ASSETS</b>			
Cash and investments (Note 2)		\$25	\$34,957
Restricted cash and investments (Note 2)			45,814
Accounts receivable	\$818,816		
Interest receivable	230	15	34
<b>Total Assets</b>	<b>819,046</b>	<b>40</b>	<b>80,805</b>
<b>LIABILITIES</b>			
Accounts payable	8,828		
Due to others			
<b>Total Liabilities</b>	<b>8,828</b>		
<b>NET POSITION</b>			
Restricted for:			
Other governments	810,218	40	80,805
<b>Total Net Position</b>	<b>\$810,218</b>	<b>\$40</b>	<b>\$80,805</b>

See accompanying notes to financial statements

CITY OF LOS ALTOS  
 FIDUCIARY FUNDS  
 STATEMENT OF ACTIVITIES  
 JUNE 30, 2021

	Custodial Funds		
	North County Library Authority	Raymundo Curb and Gutter	Blue Oak Lane Sewer
<b>ADDITIONS</b>			
Fee collections	\$59,178	\$7,853	\$49,410
Total Additions	59,178	7,853	49,410
<b>DEDUCTIONS</b>			
Distributions	4,309,565	25,643	45,178
Total Deductions	4,309,565	25,643	45,178
Net increase(decrease) in net position	(4,250,387)	(17,790)	4,232
Net Position-Beginning, as restated (Note 8)	5,060,605	17,830	76,573
Net Position-Ending	<u>\$810,218</u>	<u>\$40</u>	<u>\$80,805</u>

See accompanying notes to financial statements



*This Page Left Intentionally Blank*

**CITY OF LOS ALTOS**  
**NOTES TO BASIC FINANCIAL STATEMENTS**  
**For the Year Ended June 30, 2021**

**NOTE 1 - SUMMARY OF SIGNIFICANT ACCOUNTING POLICIES**

**A. Background**

The basic financial statements of the City of Los Altos, California (the City), have been prepared in conformity with generally accepted accounting principles (GAAP) as applied to governmental agencies. The Governmental Accounting Standards Board (GASB) is the accepted standard setting body for establishing governmental accounting and financial reporting principles. The more significant of the City's accounting policies are described below:

***Reporting Entity***

The City incorporated in 1952. The City operates under an elected Council and appointed City Manager form of government and provides the following services: public safety, recreation, community development, public works, capital improvements, and general supporting administrative services. The City has no component units.

**B. Basis of Presentation**

The accounts of the City are organized on the basis of funds, each of which is considered a separate accounting entity. The operations of each fund are accounted for within a separate set of self-balancing accounts which includes its assets, liabilities, fund equity, revenues and expenditures or expenses, as appropriate. Fund accounting segregates funds according to their intended purpose and is used to aid management in demonstrating compliance with finance-related legal and contractual provisions. The minimum number of funds is maintained consistent with such provisions and managerial requirements.

**Government-wide Statements:** The City's Government-wide Financial Statements include a Statement of Net Position and a Statement of Activities and Changes in Net Position. These statements present summaries of governmental activities and business-type activities for the City, the primary government, accompanied by a total column. Fiduciary activities of the City are not included in these statements.

These basic financial statements are presented on an "*economic resources*" measurement focus and the accrual basis of accounting. Accordingly, all of the City's assets and liabilities, including capital assets, as well as infrastructure assets and long-term liabilities, are included in the accompanying Statement of Net Position. The Statement of Activities and Changes in Net Position presents changes in the net position of the City. Under the accrual basis of accounting, revenues are recognized in the period in which they are earned while expenses are recognized in the period in which the liability for goods or services is incurred.

Certain types of transactions are reported as program revenues for the city in three categories:

- Charges for services
- Operating grants and contributions
- Capital grants and contributions

**CITY OF LOS ALTOS**  
**NOTES TO BASIC FINANCIAL STATEMENTS**  
**For the Year Ended June 30, 2021**

**NOTE 1 - SUMMARY OF SIGNIFICANT ACCOUNTING POLICIES (Continued)**

Certain eliminations have been made as prescribed by GASB Statement No. 34 in regard to interfund activities, payables, and receivables. All internal balances in the Statement of Net Position have been eliminated except those representing balances between the governmental activities and the business-type activities, which are presented as internal balances and eliminated in the total primary government column. In the Statement of Activities and Changes in Net Position internal service fund transactions have been eliminated; however, those transactions between governmental and business-type activities have not been eliminated. The following inter-fund activities have been eliminated:

- Due to, due from other funds
- Transfers in, transfers out
- Internal service fund transactions

**Fund Financial Statements:** Governmental fund financial statements include a Balance Sheet and a Statement of Revenues, Expenditures and Changes in Fund Balances for all major governmental funds and non-major funds in the aggregate. An accompanying schedule is included to reconcile and explain the differences in fund balances as presented in these statements to the net position presented in the Government-Wide financial statements.

Governmental funds are accounted for on a spending or “current financial resources” measurement focus and the modified accrual basis of accounting. Accordingly, only current assets and current liabilities are included on the balance sheets. The Statement of Revenues, Expenditures and Changes in Fund Balances present increases (revenues and other financing sources) and decreases (expenditures and other financing uses) in net current assets. Under the modified accrual basis of accounting, revenues are recognized in the accounting period in which they become both measurable and available to finance expenditures of the current period.

Revenues are recorded when received in cash, except that revenues subject to accrual (generally 60 days after year-end) are recognized when due. The City’s primary revenue sources, which have been treated as susceptible to accrual by the City, are: property tax, sales tax, hotel tax, special assessments, intergovernmental revenues, other taxes, interest revenue, rental revenue and certain charges for services. Expenditures are recorded in the accounting period in which the related fund liability is incurred and are accrued accordingly.

Deferred inflow of resources arise when potential revenues do not meet both the “measurable” and “available” criteria for recognition in the current period. Unearned revenues arise when the government receives resources before it has a legal claim to them, as when grant monies are received prior to incurring qualifying expenditures. In subsequent periods when both revenue recognition criteria are met or when the government has a legal claim to the resources, the revenue is recognized.

The reconciliation of the Fund Financial Statements to the Government-wide Financial Statements is provided to explain the differences created by the integrated approach of GASB Statement No. 34.



**CITY OF LOS ALTOS**  
**NOTES TO BASIC FINANCIAL STATEMENTS**  
**For the Year Ended June 30, 2021**

**NOTE 1 - SUMMARY OF SIGNIFICANT ACCOUNTING POLICIES (Continued)**

**Proprietary Fund Financial Statements:** Proprietary Fund financial statements include a Statement of Net Position, a Statement of Revenues, Expenses and Change in Net Position, and a Statement of Cash Flows for all proprietary funds.

A column representing the City's internal service funds, those funds that support agency wide shared service costs, is also presented in these statements. These internal service balances and activities are combined with the governmental activities in the Government-wide Financial Statements.

Proprietary Funds are accounted for using the "economic resources" measurement focus and the accrual basis of accounting. Accordingly, all assets and liabilities (whether current or noncurrent) are included on the Statement of Net Position. The Statement of Revenues, Expenses and Change in Fund Net Position presents increases (revenues) and decreases (expenses) in total net position. Under the accrual basis of accounting, revenues are recognized in the period in which they are earned while expenses are recognized in the period in which liability for goods or services is incurred.

Proprietary Funds distinguish operating revenues and expenses and non-operating items. Operating revenues and expenses generally result from providing services in connection with the fund's principal ongoing operations. The principal operating revenues of the City's enterprise and internal service funds are charges for customer services, including sewer charges, solid waste fees, and support charges. Operating expenses for enterprise funds and internal service funds include the cost of services, administrative expenses, and depreciation on capital assets. All other revenues and expenses not meeting this definition are reported as non-operating revenues and expenses.

**Fiduciary Fund Financial Statements:** The City's Fiduciary Funds are comprised of custodial funds used to account for the operating activities and for the special assessment collections pertaining to the North County Library Authority (NCLA), Raymundo and Avalon Drive Curb and Gutter Districts, and Blue Oak Lane Sewer Improvements. Custodial Funds are custodial in nature (assets equal liabilities), do not involve the measurement of results of operations, and are accounted for on the full accrual basis of accounting.

**Internal Service Funds:** Internal Service Funds account for services provided to other departments pertaining to the employee self-insurance dental program, unemployment insurance, workers' compensation insurance and liability insurance, all of which are funded on a cost reimbursement basis as budget projections and valuations develop.

**C. Major Funds**

Major funds are defined as funds that have either assets, liabilities, revenues or expenditures/expenses equal to ten percent of their fund-type total and five percent of the grand total. The General Fund is always a major fund. The City may also select other funds it believes should be presented as major funds.

The City reported the following major governmental funds in the accompanying financial statements:

**General Fund** – Accounts for all financial resources necessary to carry out basic governmental activities of the City that are not accounted for in another funds. The General Fund supports essential City services such as police, fire, street and parks maintenance, public works, and community development and recreation activities. The General Fund also includes the Real Property Proceeds Funds, which accounts for the proceeds from sale of real property and the Community Facilities Renewal Fund, which accounts for the revenues and expenditures related to the community facilities renewal efforts.

**CITY OF LOS ALTOS**  
**NOTES TO BASIC FINANCIAL STATEMENTS**  
**For the Year Ended June 30, 2021**

**NOTE 1 - SUMMARY OF SIGNIFICANT ACCOUNTING POLICIES (Continued)**

**In-Lieu Park Land Fund** – Accounts for revenues received in lieu of parkland dedications. The revenues are dedicated for purchasing or improving park or recreational facilities.

**Capital Project Fund** – Accounts for the acquisition and construction of major general government capital projects and plans that are financed by resources other than proprietary funds.

The City reported all of its enterprise funds as major funds in the accompanying financial statements:

**Sewer Fund** – Accounts for the operation (including waste water treatment) of the City’s sewer treatment activities, a self-supporting activity which provides services on a user charge basis.

**Solid Waste Fund** – Accounts for the administration and support of contracted solid waste services, a self-supporting user charge for services activity.

**Storm Drain Fund** – Accounts for operation of the City’s urban runoff and storm drain activities.

**D. *Recognition of Interest Payable***

In the Governmental Fund Financial Statements, interest expenditures on long-term debt are recognized when payment is made. In the Government-wide Financial Statements and Proprietary Fund Financial Statements interest expense is recognized as the liability is incurred.

**E. *Use of Restricted and Unrestricted Net Position***

When an expense is incurred for purposes for which both restricted and unrestricted net position are available, the City’s policy is to apply restricted net position first.

**F. *Cash, Cash Equivalents and Investments***

The City pools its available cash for investment purposes. The City considers pooled cash and investment amounts, with original maturities of three months or less, to be cash equivalents.

In accordance with GASB Statement No. 31, *Accounting and Financial Reporting for Certain Investments and for External Investment Pools*, highly liquid market investments with maturities of one year or less at time of purchase are stated at amortized cost. All other investments are stated at fair value. Market value is used as fair value for those securities for which market quotations are readily available.

The City participates in an investment pool managed by the State of California known as the Local Agency Investment Fund (LAIF) which has invested a portion of the pool funds in Structured Notes and Asset-backed Securities. LAIF’s investments are subject to credit risk with the full faith and credit of the State of California collateralizing these investments. In addition, these Structured Notes and Asset-backed Securities are subject to market risk as to change in interest rates.

The City places liquid assets in a pooled investment account with the goal of enhancing the diversity of its investment holdings. This portfolio complies with state code investment requirements and is subject to a more restrictive City adopted investment policy. Such funds are held independently in City established investment custodial accounts.

**CITY OF LOS ALTOS**  
**NOTES TO BASIC FINANCIAL STATEMENTS**  
**For the Year Ended June 30, 2021**

**NOTE 1 - SUMMARY OF SIGNIFICANT ACCOUNTING POLICIES (Continued)**

For purposes of reporting cash flows, the City considers each fund's share in the cash and investments pool to be cash and cash equivalents including cash with fiscal agents.

**G. *Fair Value Hierarchy***

Fair value is defined as the price that would be received to sell an asset or paid to transfer a liability in an orderly transaction between market participants at the measurement date. The City categorizes its fair value measurements within the fair value hierarchy established by generally accepted accounting principles. The fair value hierarchy categorizes the inputs to valuation techniques used to measure fair value into three levels based on the extent to which inputs used in measuring fair value are observable in the market.

Level 1 inputs are quoted prices (unadjusted) in active markets for identical assets or liabilities.

Level 2 inputs are inputs, other than quoted prices included within level 1, that are observable for an asset or liability, either directly or indirectly.

Level 3 inputs are unobservable inputs for an asset or liability.

If the fair value of an asset or liability is measured using inputs from more than one level of the fair value hierarchy, the measurement is considered to be based on the lowest priority level input that is significant to the entire measurement.

**H. *Inventories***

Inventory, mainly consisting of vehicle fuel and paper supplies, is stated at cost on an average cost basis and is controlled by a perpetual inventory system which is adjusted to reflect periodic physical counts. Inventories are recorded as expenditures in the General Fund and charged to departments as consumed.

**I. *Restricted Cash***

Fiscal agents acting on behalf of the City hold investment funds arising from the proceeds of long-term debt issuances. The funds may be used for specific capital outlays or for the payment of certain bonds, certificate of participation and have been invested only as permitted by specific State statutes or applicable City ordinance, resolution or bond indenture.

**J. *Compensated Absences***

**Government-wide Financial Statements:** For governmental and business-type activities, compensated absences are recorded as expenses and liabilities as the time is earned by employees.

**Fund Financial Statements:** For Governmental Funds, compensated absences are recorded as expenditures in the years paid. The General Fund is typically used to pay out compensated absences that arise in the course of any one year. Unpaid and accumulated liabilities for some compensated absences accrue to future resources. In Proprietary Funds, compensated absences are expensed to the various funds in the period they are earned, and such fund's share of the unpaid liability is recorded as a long-term liability of the fund.

**CITY OF LOS ALTOS**  
**NOTES TO BASIC FINANCIAL STATEMENTS**  
**For the Year Ended June 30, 2021**

**NOTE 1 - SUMMARY OF SIGNIFICANT ACCOUNTING POLICIES (Continued)**

**K. Property Taxes**

Santa Clara County (County) assesses all properties in the City, and it bills, collects and distributes property taxes to the City. Both secured and unsecured property taxes are levied on January 1. The County assesses properties and it bills, collects and distributes property taxes to the City. The County remits the entire amount levied and handles all delinquencies, retaining interest and penalties. Secured and unsecured property taxes are levied on July 1 for the fiscal year.

Secured property tax is due in two installments, on November 1 and February 1, and it becomes delinquent after December 10 and April 10, respectively. The City and the County adopted the “alternative method of property tax distribution” known as the Teeter Plan that authorizes the County to allocate 100% of the secured property tax based on levy instead of collection and to retain all delinquent penalties and interest. Unsecured property tax is due on July 1 and becomes delinquent after August 31. Distribution of the unsecured property taxes is based on collections. Collection of delinquent accounts is the responsibility of the County, which retains all penalties. The County also distributes both penalties and interest collected for delinquent unsecured property taxes.

**L. Capital Assets**

Capital assets are valued at historical cost or estimated historical cost if actual historical cost was not available. Donated capital assets are valued at their estimated acquisition value on the date contributed. City policy has set the capitalization threshold for reporting capital assets at \$5,000 for equipment, \$25,000 for building and facility improvements and \$100,000 for infrastructure.

Depreciation is recorded on a straight-line basis over estimated useful lives of the assets as follows:

Buildings	50 years
Improvements	30-50 years
Machinery and Equipment	3-10 years
Infrastructure	30-100 years

In accordance with GASB Statement No. 34, the City has included all infrastructures in its Statement of Net Position.

The City defines infrastructure as basic physical assets that allow the City to function. The assets include the street system. Each major infrastructure system can be divided into subsystems. For example, the street system can be subdivided into pavement, streetlights and traffic control devices (signs, signals and pavement markings). These subsystems were not delineated in the Government-wide Financial Statements. The appropriate operating department maintains information regarding the subsystems.

For all infrastructure systems, the City has elected to use the Basic Approach, as defined by GASB Statement No. 34, for infrastructure reporting. The valuation of the City’s infrastructure assets are determined based on the original cost using one of the following methods:

1. Use of historical records where available
2. Standard unit costs appropriate for the construction/acquisition date of the asset
3. Present replacement cost indexed by a reciprocal factor of the price increase from the construction/acquisition date to the current date

**CITY OF LOS ALTOS**  
**NOTES TO BASIC FINANCIAL STATEMENTS**  
**For the Year Ended June 30, 2021**

**NOTE 1 - SUMMARY OF SIGNIFICANT ACCOUNTING POLICIES (Continued)**

Accumulated depreciation, defined as the total depreciation from the date of construction/acquisition to the current date, was computed on a straight-line method. The book value was then computed by deducting the accumulated depreciation from the original cost.

**M. Long-Term Debt**

**Government-wide Financial Statements:** Long-term debt and other financial obligations are reported as liabilities in the appropriate activities.

Bond premiums and discounts are deferred and amortized over the life of the bonds using the straight-line method. Bonds payable are reported net of the applicable premium or discount.

**Fund Financial Statements:** The Governmental Fund Financial Statements do not present long-term debt, which are shown in the Reconciliation of the Governmental Funds Balance Sheet to the Government-wide Statement of Net Position.

Governmental Funds recognize bond premiums and discounts, as well as bond issuance costs, during the current period. The face amount of debt issued is reported as other financing sources. Premiums received on debt issuance are reported as other financing sources while discounts on debt issuance are reported as other financing uses. Issuance costs, whether or not withheld from the actual debt proceeds received, are reported as debt service expenditures.

Proprietary Fund Financial Statements use the same principles as those used in the Government-wide Financial Statements.

**N. Unearned Revenue**

**Government-wide Financial Statements:** In the Government-wide Financial Statements, unearned revenue is recognized for transactions for which revenue has not yet been earned.

**O. Deferred Outflows/Inflows of Resources**

In addition to assets, the statement of financial position or balance sheet reports a separate section for deferred outflows of resources. This separate financial statement element, *deferred outflows of resources*, represents a consumption of net position or fund balance that applies to a future period(s) and so will *not* be recognized as an outflow of resources (expense/expenditure) until then. In addition to liabilities, the statement of financial position or balance sheet reports a separate section for deferred inflows of resources. This separate financial statement element, *deferred inflows of resources*, represents an acquisition of net position or fund balance that applies to a future period(s) and so will *not* be recognized as an inflow of resources (revenue) until that time.

**P. Use of Estimates**

The preparation of financial statements in conformity with GAAP requires management to make estimates and assumptions. These estimates and assumptions affect the reported amounts of assets and liabilities and the disclosure of contingent assets and liabilities. In addition, estimates affect the reported amount of expenses. Actual results could differ from these estimates and assumptions.

**CITY OF LOS ALTOS**  
**NOTES TO BASIC FINANCIAL STATEMENTS**  
**For the Year Ended June 30, 2021**

**NOTE 1 - SUMMARY OF SIGNIFICANT ACCOUNTING POLICIES (Continued)**

***Q. OPEB Liabilities, OPEB Expenses and Deferred Outflows/Inflows of Resources Related to OPEB***

For purposes of measuring the net OPEB liability, deferred outflows of resources and deferred inflows of resources related to OPEB, and OPEB expense, information about the fiduciary net position of the City's OPEB Plan and additions to/deductions from the OPEB Plan's fiduciary net position have been determined on the same basis as they are reported by California Employers' Retiree Benefit Trust (CERBT). For this purpose, benefit payments are recognized when currently due and payable in accordance with the benefit terms. Investments are reported at fair value.

***R. Implementation of Governmental Accounting Standards Board (GASB) Pronouncements***

Management adopted the provisions of the following Governmental Accounting Standards Board (GASB) Statement, which became effective during the year ended June 30, 2021.

**Effect of New Governmental Accounting Standards Board (GASB) Pronouncements**

GASB Statement No. 84 – In January 2017, the GASB issued Statement No. 84, *Fiduciary Activities*. The objective of this Statement is to improve guidance regarding the identification of fiduciary activities for accounting and financial reporting purposes and how those activities should be reported. This Statement describes four fiduciary funds that should be reported, if applicable: (1) pension (and other employee benefit) trust funds, (2) investment trust funds, (3) private-purpose trust funds, and (4) custodial funds. Custodial funds generally should report fiduciary activities that are not held in a trust or equivalent arrangement that meets specific criteria. The provisions of this Statement were implemented during fiscal year 2021. As part of the implementation of this Statement, the City's former Agency Funds are not presented as Custodial Funds.

GASB Statement No. 90 – In August 2018, GASB issued Statement No. 90, *Majority Equity Interests* – an amendment of GASB Statements No. 14 and No. 61. The primary objectives of this Statement are to improve the consistency and comparability of reporting a government's majority equity interest in a legally separate organization and to improve the relevance of financial statement information for certain component units. It defines a majority equity interest and specifies that a majority equity interest in a legally separate organization should be reported as an investment if a government's holding of the equity interest meets the definition of an investment. This statement is effective for reporting periods beginning after December 15, 2019. There is no impact on the City financial statements.

**Future Governmental Accounting Standards (GASB) Pronouncements**

GASB Statement No. 87 – In June 2017, the GASB issued Statement No. 87, *Leases*. The objective of this Statement is to better meet the information needs of financial statement users by improving accounting and financial reporting for leases by governments. This Statement increases the usefulness of governments' financial statements by requiring recognition of certain lease assets and liabilities for leases that previously were classified as operating leases and recognized as inflows of resources or outflows of resources based on payment provisions of the contract. It establishes a single model for lease accounting based on the foundational principle that leases are financings of the right to use an underlying asset. Under this Statement, a lessee is required to recognize a lease liability and an intangible right-to-use lease asset, and a lessor is required to recognize a lease receivable and a deferred inflow of resources, thereby enhancing the relevance and consistency of information about governments' leasing activities. The requirements of this Statement are effective for reporting periods beginning after December 15, 2020. The City has not determined its effect on the financial statements.

**CITY OF LOS ALTOS**  
**NOTES TO BASIC FINANCIAL STATEMENTS**  
**For the Year Ended June 30, 2021**

**NOTE 1 - SUMMARY OF SIGNIFICANT ACCOUNTING POLICIES (Continued)**

GASB Statement No. 91 – In May 2019, GASB Issued Statement No. 91, Conduit Debt Obligation. The primary objectives of this Statement are to provide a single method of reporting conduit debt obligations by issuers and eliminate diversity in practice associated with (1) commitments extended by issuers, (2) arrangements associated with conduit debt obligations, and (3) related note disclosures. This Statement clarifies the existing definition of a conduit debt obligation; establishing that a conduit debt obligation is not a liability of the issuer; establishing standards for accounting and financial reporting of additional commitments and voluntary commitments extended by issuers and arrangements associated with conduit debt obligations; and improving required note disclosures. This Statement also addresses arrangements—often characterized as leases—that are associated with conduit debt obligations. This Statement is effective for reporting periods beginning after December 15, 2021. Earlier application is encouraged. The City has not yet determined its effect on the financial statements.

GASB Statement No. 92 – In January 2020, GASB Issued Statement No. 92, Omnibus 2020. The primary objectives of this Statement are to enhance comparability in accounting and financial reporting and to improve the consistency of authoritative literature by addressing practice issues that have been identified during implementation and application of certain GASB Statements. This Statement addresses a variety of topics. This Statement is effective for reporting periods beginning after June 15, 2020. Earlier application is encouraged. The City has not yet determined its effect on the financial statements.

GASB Statement No. 93 – In March 2020, GASB Issued Statement No. 93, Replacement of Interbank Offered Rates. The primary objective of this Statement to address those and other accounting and financial reporting implications that result from the replacement of an IBOR. This Statement is effective for reporting periods beginning after December 31, 2021. Earlier application is encouraged. The City has not yet determined its effect on the financial statements.

**NOTE 2 - CASH, CASH EQUIVALENTS AND INVESTMENTS**

**A. Cash Deposits**

The City’s cash and investments at June 30, 2021 are presented as follows:

Cash and investments	\$67,840,186
Restricted cash and investments	172,021
Custodial funds:	
Cash and investments	34,982
Restricted cash and investments	45,814
Total cash and investments	\$68,093,003

Cash and investments consist of the following as of June 30, 2021:

Cash on hand	\$2,170
Deposits with financial institutions*	9,717,246
Investments:	
Liquid investments	\$3,590,222
Managed investments	54,783,365
Total cash and investments	\$68,093,003

\*Workers' compensation imprest balances held by Tristar in trust for City.

**CITY OF LOS ALTOS**  
**NOTES TO BASIC FINANCIAL STATEMENTS**  
**For the Year Ended June 30, 2021**

**NOTE 2 - CASH, CASH EQUIVALENTS AND INVESTMENTS (Continued)**

**B. Authorized Investments**

Under the provisions of the City's investment policy and in accordance with Section 53601 of the California Government Code, the City is authorized to invest or deposit in the following, with the limitations as they relate to interest rate risk, credit risk, and concentration of credit risk:

Authorized Investment Type	Maximum Maturity	Maximum Percentage of Portfolio	Maximum Investment In One Issuer	Minimum Legal Rating
Local Agency Investment Fund	N/A	100%	\$75 million	N/A
Money Market Mutual Funds	N/A	20%	10%	N/A
Certificates of Deposit	3 years	50%	10%	A
Bankers' Acceptances	180 days	20%	10%	N/A
Commercial Paper	270 days	25%	5%	A-1
Repurchase Agreements	180 days	20%	10%	N/A
U.S. Treasury Bills, Notes and Bonds	5 years	100%	N/A	N/A
Supra-National Agency Notes and Bonds	5 years	20%	N/A	AA
U.S. Government-Sponsored Enterprise Agencies	5 years	100%	20%	N/A
Medium-Term Corporate Notes	5 years	30%	3%	A
Asset-backed Securities	5 years	20%	3%	AAA

**C. Interest Risk**

Interest rate risk is the market rate changes that adversely affect the fair value of an investment. Generally, the sensitivity of an investment fair value to changes in market rates is greater when the maturity of the investment is longer.

Investments held in City Treasury grouped by maturity date at June 30, 2021, are shown below:

Investment Type	One Year or Less	13 months to 24 months	25 months to 36 months	37 months to 60 months	Total
Money Market Mutual Fund	\$217,835				\$217,835
Government Sponsored Enterprise Agencies:					
Federal National Mortgage Association Notes (FNMA)	7,320	\$3,049,732	\$1,784,720		4,841,772
Federal Home Loan Mortgage Corporation (FHLMC)	304,608	2,174,440	3,796,799		6,275,847
FHMS			21,808	\$96,123	117,931
U.S. Treasury Notes		13,042,422	8,256,417	3,302,000	24,600,839
Supra-National Agency Notes and Bonds		825,969	423,779		1,249,748
Certificate of Deposit	1,031,008	2,639,884			3,670,892
Corporate Notes	939,109	2,630,999	3,290,481	1,707,110	8,567,699
Asset-Backed Securities	5,416	692,360	1,964,727	2,578,299	5,240,802
Local Agency Investment Funds (LAIF)	3,590,222				3,590,222
Total investments	<u>\$6,095,518</u>	<u>\$25,055,806</u>	<u>\$19,538,731</u>	<u>\$7,683,532</u>	58,373,587
Demand Deposits and Cash on Hand					<u>9,719,416</u>
Total cash and investments					<u>\$68,093,003</u>



**CITY OF LOS ALTOS**  
**NOTES TO BASIC FINANCIAL STATEMENTS**  
**For the Year Ended June 30, 2021**

**NOTE 2 - CASH, CASH EQUIVALENTS AND INVESTMENTS (Continued)**

**D. Fair Value Hierarchy**

The City categorizes its fair value measurements within the fair value hierarchy established by generally accepted accounting principles. The hierarchy is based on the valuation inputs used to measure fair value of the assets. Level 1 inputs are quoted prices in an active market for identical assets; Level 2 inputs are significant other observable inputs; and Level 3 inputs are significant unobservable inputs.

The following is a summary of the fair value hierarchy of the fair value of investments of the City as of June 30, 2021:

<i>Investments by Fair Value Level:</i>	<u>Level 1</u>	<u>Level 2</u>	<u>Total</u>
Government Sponsored Enterprise Agencies:			
Federal National Mortgage Association Notes (FNMA)		\$4,841,772	\$4,841,772
Federal Home Loan Mortgage Corporation (FHLMC)		6,275,847	6,275,847
FHMS		117,931	117,931
U.S. Treasury Notes	\$24,600,839		24,600,839
Supra-National Agency Notes and Bonds		1,249,748	1,249,748
Corporate Notes		8,567,699	8,567,699
Asset-backed Securities		5,240,802	5,240,802
	<u>\$24,600,839</u>	<u>\$26,293,799</u>	<u>50,894,638</u>
 <i>Investments Measured at Amortized Cost:</i>			
Certificates of Deposit			3,670,892
Money Market Mutual Fund			217,835
California Local Agency Investment Fund (LAIF)			3,590,222
Cash in banks and on hand			<u>9,719,416</u>
			<u>\$68,093,003</u>

Investments above classified in Level 1 of the fair value hierarchy are valued using a quoted price in an active market for an identical asset. Investments above classified in Level 2 of the fair value hierarchy are valued using a quoted price in a non-active market for an identical asset. These prices are obtained from various pricing sources by the custodian bank. Certificates of Deposit, Money Market Mutual Fund and LAIF are valued at amortized cost and therefore, exempt from being classified under GASB 72.

**CITY OF LOS ALTOS**  
**NOTES TO BASIC FINANCIAL STATEMENTS**  
**For the Year Ended June 30, 2021**

**NOTE 2 - CASH, CASH EQUIVALENTS AND INVESTMENTS (Continued)**

**E. Credit Risk**

Generally, credit risk is the risk that an issuer of an investment will not fulfill its obligation to the holder of the investment. This is usually measured by the assignment of a rating by a nationally recognized statistical rating organization.

At June 30, 2021, the City's deposit and investments were rated as follows:

Investment Type	Credit Quality Ratings		Market Value
	Moody's	S&P	
Securities of Government Sponsored Enterprise Agencies:			
Federal National Mortgage Association Notes (FNMA)	Aaa	AA+	\$4,841,772
Federal Home Loan Mortgage Corporate Notes (FHLMC)	Aaa	AA+	6,275,847
FHMS	Aaa	AA+	117,931
U.S. Treasury Notes	Aaa	AA+	24,600,839
Corporate Notes:			
Northern Trust Company	A2	A+	281,189
Honeywell International	A2	A	122,268
Toyota Motor Credit Corp	A1	A+	382,955
Apple Inc.	Aa1	AA+	354,388
Clorox Company	Baa1	A-	230,892
Bank of NY Mellon	A1	A	76,728
Adobe Inc. Corp Note	A2	A	204,356
JP Morgan Chase & Co. Bonds	A2	A-	641,029
Exxon Mobil Corporation	Aa2	AA-	291,236
Pepsico Inc. Corporate Notes	A1	A+	151,172
Chevron Corp	Aa2	AA-	86,275
General Dynamics	A2	A-	237,387
Amazon.com Inc.	A1	AA	784,615
Paccar Financial Corp	A1	A+	50,424
Chevron Corp	Aa2	AA-	288,386
John Deere Capital Corp	A2	A	225,472
Caterpillar Financial Service	A2	A	424,581
Bristol-Myers Squibb Co (Callable)	A2	A+	338,667
Goldman Sachs Group Inc.	A2	BBB+	477,619
IBM Corp Notes	A2	A-	134,543
Charles Schwab Corp (Callable)	A2	A	175,922
Morgan Stanley Corp (Callable)	A1	BBB+	105,126

(Continued)

**CITY OF LOS ALTOS**  
**NOTES TO BASIC FINANCIAL STATEMENTS**  
**For the Year Ended June 30, 2021**

**NOTE 2 - CASH, CASH EQUIVALENTS AND INVESTMENTS (Continued)**

Comcast Corp (Callable)	A3	A-	216,571
Morgan Stanley Corp	A1	BBB+	211,411
Citigroup Inc.	A3	BBB+	404,300
United Health Group Inc.	A3	A+	189,472
Astrazeneca Finance LLC (Callable)	A2	A	289,636
Bank of America	A2	A-	213,046
Bank of America Corp (Callable)	A2	A-	275,829
Merck & Co. Inc.	A1	A+	138,471
Burlington North Santa Fe	A3	AA-	134,365
Bank of NY Mellon (Callable)	A1	A	138,425
PNC Bank NA	A2	A	290,943
Certificates of Deposit			
Credit Suisse New York	P-1	A-1	450,821
Societe Generale NY	P-1	A-1	580,187
Sumitomo Mitsui Bank NY	A1	A	452,114
Nordea Bank ABP New York	Aa3	AA-	586,009
Skandinav Enskilda Bank	Aa2	A+	586,075
DNB Bank ASA/NY LT	Aa2	AA-	590,008
Credit Suisse New York Cert	Aa3	A+	425,678
Asset-backed Securities	NR	AAA	2,575,769
Asset-backed Securities	Aaa	AAA	1,370,270
Asset-backed Securities	Aaa	NR	1,294,763
Supra-National Agency Notes and Bonds	Aaa	AAA	1,249,748
Money Market	Aaa	AAAm	217,835
Subtotal			<u>54,783,365</u>
Not Rated:			
Cash on hand	Not Rated	Not Rated	2,170
US Bank General Checking	Not Rated	Not Rated	9,468,158
Money Market (Sweep Account)	Not Rated	Not Rated	249,088
Local Agency Investment Funds (LAIF)	Not Rated	Not Rated	<u>3,590,222</u>
Total Investments			<u><u>\$68,093,003</u></u>

**CITY OF LOS ALTOS**  
**NOTES TO BASIC FINANCIAL STATEMENTS**  
**For the Year Ended June 30, 2021**

**NOTE 2 - CASH, CASH EQUIVALENTS AND INVESTMENTS (Continued)**

**F. Custodial Credit Risk – Deposits**

This is the risk that in the event of a bank failure, the City's deposits may not be returned to it. The City does not have a policy for custodial credit risk for deposits. However, the California Government Code requires that a financial institution secure deposits made by state or local governmental units by pledging securities in an undivided collateral pool held by a depository regulated under state law (unless so waived by the governmental unit). The fair value of the pledged securities in the collateral pool must equal at least 110% of the total amount deposited by the public agencies. California law also allows financial institutions to secure public deposits by pledging first trust deed mortgage notes having a value of 150% of the secured public deposits and letters of credit issued by the Federal Home Loan Bank of San Francisco having a value of 105% of the secured deposits.

As of June 30, 2021, the City's bank balance was \$9,510,964 and the corresponding carrying book balance was \$9,414,473. Of the bank balance, \$250,000 was covered by federal depository insurance and \$9,164,473 was collateralized.

**Investments:** The custodial credit risk for investments is the risk that, in the event of the failure of the counterparty (e.g. broker-dealer) to a transaction, a government will not be able to recover the value of its investment or collateral securities that are in the possession of another party. The California Government Code and the City's investment policy do not contain legal or policy requirements that would limit the exposure to custodial credit risk for investments.

**G. Investment in State Investment Pool**

The City is a voluntary participant in LAIF that is regulated by the California Government Code under the oversight of the Treasurer of the State of California. The fair value of the City's investment in this pool as reported in the accompanying financial statements is based upon the Entity's pro-rata share of the fair value provided by LAIF for the entire LAIF portfolio (in relation to the amortized cost of that portfolio).

As of June 30, 2021, the City held \$3,590,222 in LAIF. The LAIF fair value factor of 1.00008297 was used to calculate the fair value of the investments in LAIF and average maturity of 291 days.

**CITY OF LOS ALTOS**  
**NOTES TO BASIC FINANCIAL STATEMENTS**  
**For the Year Ended June 30, 2021**

**NOTE 3 – INTERFUND TRANSACTIONS**

**A. Transfers**

Transfers between funds during the fiscal year ended June 30, 2021 were as follows:

City of Los Altos  
June 30, 2021

<u>Fund Making Transfers</u>	<u>Fund Receiving Transfers</u>	<u>Amount</u>
General Fund	Capital Projects Fund	\$16,781,172 (A)
	Non-Major Governmental Funds	867,400 (B)
In-Liew Park Land Special Revenue Fund	Capital Projects Fund	1,300,000 (A)
Non-Major Governmental Funds	General Fund	146,176 (C)
	Capital Projects Fund	<u>12,456,641 (A)</u>
		<u>\$31,551,389</u>

**Interfund transfers were principally used for the following purposes,**

- (A) To fund capital projects
- (B) To maintain minimum fund balance in Debt Service
- (C) Public safety related funds paid to the General Fund

**B. Due to/from other funds**

Current interfund balances arise in the normal course of business, to fund projects until the borrowing fund receives revenues to repay the lending fund and to assist funds with negative cash balance at the fiscal year end. The following is a summary of interfund balances as of June 30, 2021:

<u>Due From Other Funds</u>	<u>Due To Other Funds</u>	<u>Amount</u>
General Fund	Storm Drain Enterprise Fund	\$7,969
	Internal Service Fund	94,747
	Non-Major Governmental Funds	<u>748,269</u>
	Total	<u>\$850,985</u>

**NOTE 4 – NOTE RECEIVABLE**

The City entered into a loan agreement with the City Manager on November 1, 2016, to provide the City Manager a long-term loan of up to \$2,000,000 to finance the acquisition of his personal residence located within the City. The loan is secured by a deed of trust on the property. The loan is due upon sale of the property, within six to twelve months after the termination of the City Manager’s employment with the City depending on the cause of termination, or 30 years from the date of the loan agreement execution, whichever occurs first. The loan bears an interest rate at the 5 Year Treasury Rate as of September 1, 2016 amortized over a thirty-year period and recalculated to the 5 year Treasury Rate every five years of the original date of the loan. At June 30, 2021, the outstanding balance of this loan was \$1,704,880.

**CITY OF LOS ALTOS**  
**NOTES TO BASIC FINANCIAL STATEMENTS**  
**For the Year Ended June 30, 2021**

**NOTE 5 – CAPITAL ASSETS**

**A. Government-wide Financial Statements**

At June 30, 2021, the City's capital assets consisted of the following:

	Governmental Activities	Business-Type Activities	Total
<b>Nondepreciable assets:</b>			
Construction in progress	\$45,660,831	\$1,361,354	\$47,022,185
Land	14,500,134		14,500,134
Total nondepreciable assets	<u>60,160,965</u>	<u>1,361,354</u>	<u>61,522,319</u>
<b>Depreciable assets:</b>			
Buildings	21,637,868	17,959,980	39,597,848
Improvements	6,537,672		6,537,672
Machinery and equipment	7,094,884	1,066,804	8,161,688
Infrastructure	46,562,694	8,091,365	54,654,059
Total depreciable assets	81,833,118	27,118,149	108,951,267
Less accumulated depreciation	<u>(36,154,600)</u>	<u>(13,829,900)</u>	<u>(49,984,500)</u>
Total depreciable assets, net	<u>45,678,518</u>	<u>13,288,249</u>	<u>58,966,767</u>
Total capital assets	<u>\$105,839,483</u>	<u>\$14,649,603</u>	<u>\$120,489,086</u>

The following is a summary of capital assets for governmental activities for the year ended June 30, 2021:

	Balance June 30, 2020	Additions	Retirements	Transfers	Balance June 30, 2021
<b>Governmental Activities:</b>					
<b>Capital assets, not depreciated:</b>					
Land	\$11,642,285	\$2,857,849			\$14,500,134
Construction in progress	24,125,740	23,135,712		(\$1,600,621)	45,660,831
Total capital assets, not depreciated	<u>35,768,025</u>	<u>25,993,561</u>		<u>(1,600,621)</u>	<u>60,160,965</u>
Buildings	21,637,868				21,637,868
Improvements	6,537,672				6,537,672
Machinery and equipment	6,879,232	353,841	(\$138,189)		7,094,884
Infrastructure	44,962,073			1,600,621	46,562,694
Total cost of depreciable assets	<u>80,016,845</u>	<u>353,841</u>	<u>(138,189)</u>	<u>1,600,621</u>	<u>81,833,118</u>
<b>Less accumulated depreciation:</b>					
Buildings	(11,029,830)	(398,477)			(11,428,307)
Improvements	(2,592,193)	(177,675)			(2,769,868)
Machinery and equipment	(5,084,950)	(329,062)	138,189		(5,275,823)
Infrastructure	(15,204,102)	(1,476,500)			(16,680,602)
Total accumulated depreciation	<u>(33,911,075)</u>	<u>(2,381,714)</u>	<u>138,189</u>		<u>(36,154,600)</u>
Net depreciable assets	<u>46,105,770</u>	<u>(2,027,873)</u>		<u>1,600,621</u>	<u>45,678,518</u>
Governmental Activity Capital Assets, Net	<u>\$81,873,795</u>	<u>\$23,965,688</u>			<u>\$105,839,483</u>

**CITY OF LOS ALTOS**  
**NOTES TO BASIC FINANCIAL STATEMENTS**  
**For the Year Ended June 30, 2021**

**NOTE 5 – CAPITAL ASSETS (Continued)**

The governmental activities depreciation expenses for capital assets for the year ended June 30, 2021 are as follows:

Functions/Programs	Total
Public safety	\$157,432
Public works	1,546,803
Recreation	473,809
Community development	815
Admin / community services	202,855
Total depreciation expense	<u>\$2,381,714</u>

The following is a summary of capital assets for business-type activities:

	Balance June 30, 2020	Additions	Retirements	Transfers	Balance June 30, 2021
<b>Business-Type Activities:</b>					
Capital assets, not depreciated:					
Construction in progress	\$1,341,596	\$2,787,409	\$ -	(\$2,767,651)	\$1,361,354
Total capital assets, not depreciated:	<u>1,341,596</u>	<u>2,787,409</u>		<u>(2,767,651)</u>	<u>1,361,354</u>
Capital assets, being depreciated:					
Buildings	17,959,980				17,959,980
Machinery and equipment	1,066,804				1,066,804
Infrastructure	5,323,714			2,767,651	8,091,365
Total cost of depreciable assets	<u>24,350,498</u>			<u>2,767,651</u>	<u>27,118,149</u>
Less accumulated depreciation:					
Buildings	(10,457,145)	(217,810)			(10,674,955)
Machinery and equipment	(820,519)	(55,571)			(876,090)
Infrastructure	(2,126,232)	(152,623)			(2,278,855)
Total accumulated depreciation	<u>(13,403,896)</u>	<u>(426,004)</u>			<u>(13,829,900)</u>
Net depreciable assets	<u>10,946,602</u>	<u>(426,004)</u>		<u>2,767,651</u>	<u>13,288,249</u>
Business-type Activity Capital Assets, Net	<u>\$12,288,198</u>	<u>\$2,361,405</u>	<u>\$ -</u>	<u>\$ -</u>	<u>\$14,649,603</u>

Depreciation expense for business-type activities related to the Sewer Fund amounted to \$426,004 for the year ended June 30, 2021.

**B. Fund Financial Statements**

The Governmental Fund Financial Statements do not present capital assets, which are shown in the Reconciliation of the Governmental Funds Balance Sheet to the Government-wide Statement of Net Position.

The capital assets of the Enterprise Funds in the Proprietary Fund Financial Statements are the same as those shown in the business-type activities of the Government-wide Financial Statements.

**CITY OF LOS ALTOS**  
**NOTES TO BASIC FINANCIAL STATEMENTS**  
**For the Year Ended June 30, 2021**

**NOTE 6 – LONG-TERM OBLIGATIONS**

**A. Governmental Activities Long-Term Debt**

Summary of changes in governmental activities long-term debt for the year ended June 30, 2021 is as follows:

	Balance at June 30, 2020	Additions	Retirements	Balance at June 30, 2021	Due Within One Year	Due in More Than One Year
2004 Certificate of Participation	\$1,005,000		(\$125,000)	\$880,000	\$130,000	\$750,000
Direct Borrowing-Community Center Lease		\$10,000,000	(503,137)	9,496,863	404,612	9,092,251
Total	<u>\$1,005,000</u>	<u>\$10,000,000</u>	<u>(\$628,137)</u>	<u>\$10,376,863</u>	<u>\$534,612</u>	<u>\$9,842,251</u>

**2004 Refunding Certificate of Participation:** On November 1, 1996, the City issued \$2,630,000 principal amount of Certificates of Participation (ABAG 38 COPs). The purpose of the ABAG 38 COPs was to finance the partial purchase of the 5.5 acre Saint William School site for public purposes and uses. During 2004 the City issued \$2,500,000 of 2004 Refunding Certificates of Participation to advance refund \$2,390,000 of outstanding principal on the ABAG 38 Certificates of Participation, set up reserve funds, and to pay related issuance costs. The entire ABAG 38 Certificates of Participation had been paid off by June 30, 2004. This advance refunding was undertaken to reduce total future debt service payments.

The Certificates of Participation are limited obligations of the City, payable from appropriations budgeted for in the City’s annual adopted budget. The Certificate covenants contain events of default that may result in the termination of the lease, collection of rent due and other monetary charges and terminate the City's right to possession of the leased property as applied by the Trustee and specified in the terms of the agreement if any of the following conditions occur: default on debt service payments; the failure of the City to observe or perform the conditions, covenants, or agreement terms of the debt; bankruptcy filing by the City; or if any court or competent jurisdiction shall assume custody or control of the City. There were no such events occurred during the fiscal year ending June 30, 2021.

**Direct Borrowing - Community Center Lease Agreement:** On December 1, 2020, the City entered into Lease Agreements with the Public Property Financing Corporation of California, which subsequently assign the Agreement to Sterling National Bank (Assignee), under which the City leased certain facilities and the land on which the City’s Community Center is located, for which the Assignee made a one-time up-front lease payment to the City in the amount of \$10,000,000. Simultaneously, the City will lease back from the Assignee with annual lease payments over a lease term of 19 years, at a fixed interest rate of 2.290% per year. The Sublease is secured by the leased property. The Sublease is repayable in semi-annual payments beginning June 2021 through June 30, 2040. The pledge of repayment is from the General Fund.



**CITY OF LOS ALTOS**  
**NOTES TO BASIC FINANCIAL STATEMENTS**  
**For the Year Ended June 30, 2021**

**NOTE 6 – LONG-TERM OBLIGATIONS (Continued)**

At June 30, 2021, future debt service requirements were as follows:

Years ending June 30	2004 COP		Direct Borrowing Community Center Lease		Total
	Principal	Interest	Principal	Interest	
2022	\$130,000	\$37,400	\$404,612	\$217,478	\$789,490
2023	140,000	31,875	413,877	208,213	793,965
2024	140,000	25,925	423,355	198,735	788,015
2025	150,000	19,975	433,050	189,040	792,065
2026	155,000	13,600	442,967	179,123	790,690
2027-2031	165,000	7,012	2,371,719	738,730	3,282,461
2032-2036	-	-	2,656,005	454,443	3,110,448
2037-2040	-	-	2,351,278	136,101	2,487,379
Total	<u>\$880,000</u>	<u>\$135,787</u>	<u>\$9,496,863</u>	<u>\$2,321,863</u>	<u>\$12,834,513</u>

**B. Non-City Obligations**

The following bonds are not reported in the City’s financial statements as they are special obligations payable solely from and secured by specific revenue sources as described in the resolutions and official statements of the respective issues. Neither the faith and credit nor the taxing power of the City is pledged for payment of these obligations.

	Balance June 30, 2020	Retirements	Balance June 30, 2021	Due Within One Year	Due in More Than One Year
Raymundo Curb and Gutter	\$25,000	(\$25,000)			
Blue Oak Lane	500,000	(15,000)	\$485,000	\$15,000	\$470,000
Total	<u>\$525,000</u>	<u>(\$40,000)</u>	<u>\$485,000</u>	<u>\$15,000</u>	<u>\$470,000</u>

**Raymundo Special Assessment Districts:** The Raymundo Curb and Gutter Assessment District Improvement Bonds were issued on August 3, 2005 to provide financing for the street improvements in that District. The bonds are payable from a special property tax levied to those residents living within the respective District. The Bonds have been repaid and this District will cease to be reported from next year.

**Blue Oak Lane Special Assessment District:** On November 5, 2009, Limited Obligation Improvement Bonds were issued for a newly formed Blue Oak Lane Sewer Assessment District (series 2009) to finance the acquisition and construction, by the City, of sanitary sewer improvements serving properties within the subject assessment District. These bonds are issued upon and secured by individual parcel levied assessments to be included in the annual property tax billings annually. The Bonds mature in 2039, were issued in a principal amount of \$662,880 and are subject to semi-annual debt service payments administered by the City.

**CITY OF LOS ALTOS**  
**NOTES TO BASIC FINANCIAL STATEMENTS**  
**For the Year Ended June 30, 2021**

**NOTE 7 – COMPENSATED ABSENCES PAYABLE**

The City’s compensated absences at June 30, 2021, were as follows:

	Governmental Activities	Business-type Activities	Total
Balance at July 1, 2020	\$1,990,680	\$72,084	\$2,062,764
Additions	517,576	81,492	599,068
Payments	(584,218)	(46,195)	(630,413)
Balance at June 30, 2021	<u>\$1,924,038</u>	<u>\$107,381</u>	<u>\$2,031,419</u>
Current Portion	<u>\$481,010</u>	<u>\$26,845</u>	<u>\$507,855</u>
Long-Term Portion	<u>\$1,443,028</u>	<u>\$80,536</u>	<u>\$1,523,564</u>

**NOTE 8 – NET POSITION AND FUND BALANCES**

**A. Fund Balances**

In the fund financial statements, governmental funds report the following classifications: non-spendable, restricted, committed, assigned, and unassigned. The City Council, as the highest level of decision making authority for the City, can commit fund balances through the adoption of a formal action in accordance with the adoption of its annual Financial Policy. This formal action includes committing funds through budget adoption or by resolution. This policy authorizes the City Manager to assign fund balances and has set the budgetary level of control at the Fund and Capital Project level for the governing body and the department level for the City Manager and assignees.

**B. General Fund Reserve**

The City Council has established a General Fund Reserve goal level of 20% of annual operating expenditures has set funds aside accordingly through its annual budgetary actions. These funds would be **available for use in such conditions to mitigate negative economic fiscal impacts or State takeaways and can** be activated within any one budget cycle through Council action. An economic downturn would entail a projected and/or sudden drop in core revenues (major tax and service revenue loss) of equal to or greater than 5% (including the impact of inflation) and/or a change in economic parameters (such as interest rates, debt service rates, commodity prices, pension rates) that cause a material change in expenditures of 5% or more, or the occurrence of a local natural disaster or unexpected financial claim requiring the immediate use of cash balances of 5% or more, or the occurrence of a local natural disaster or unexpected financial claim requiring the immediate use of cash balances. In fiscal year 2020/2021, in line with budget approval, the City reallocated the pre-established State Budget Stabilization reserve into the aforementioned General Fund reserve. This results in the establishment of one Reserve balance to assist in periods of economic downturn or extraordinary need. The City’s reserve goal is at 17.5% during fiscal year 2020/21 based on total expenses for the year.

**CITY OF LOS ALTOS**  
**NOTES TO BASIC FINANCIAL STATEMENTS**  
**For the Year Ended June 30, 2021**

**NOTE 8 – NET POSITION AND FUND BALANCES (Continued)**

**C. Classifications**

In the Government-wide Financial Statements, net position is classified in the following categories:

*Net Investment in Capital Assets* – This amount consists of capital assets net of accumulated depreciation and reduced by outstanding debt that attributed to the acquisition, construction, or improvement of the assets.

*Restricted Net Position* – This amount is restricted by external creditors, grantors, contributors, or laws or regulations of other governments.

*Unrestricted Net Position* – This amount is all net position that do not meet the definition of “net investment in capital assets” or “restricted net position.”

As prescribed by GASB Statement No. 54, governmental funds report fund balance in classifications based primarily on the extent to which the City is bound to honor constraints on the specific purposes for which amounts in the funds can be spent. As of June 30, 2021, fund balances for government funds are made up of the following:

- *Non-spendable Fund Balance* – includes amounts that are (a) not in spendable form, or (b) legally or contractually required to be maintained intact. The “not in spendable form” criterion includes items that are not expected to be converted to cash, for example: inventories, prepaid amounts, long-term notes receivable and land.
- *Restricted Fund Balance* – includes amounts that can be spent only for the specific purposes stipulated by external resource providers, constitutionally or through enabling legislation. Restrictions may effectively be changed or lifted only with the consent of resource providers.
- *Committed Fund Balance* – Committed fund balances include amounts that can be used only for the specific purposes determined by a formal action of the City Council's highest level of decision-making authority. The City Council can, by adoption of a resolution prior to the end of the fiscal year, commit fund balance. Once adopted, the limitation imposed by the resolution remains in place until a similar action is taken (the adoption of another resolution) to remove or revise the limitation.
- *Assigned Fund Balance* – comprised of amounts intended to be used by the City for specific purposes that are neither restricted nor committed. Intent is expressed by (a) the City Council or (b) a body (for example: a budget or finance committee) or official to which the City Council has delegated the authority to assign amounts to be used for specific purposes.
- *Unassigned Fund Balance* – conveys the residual classification for the General Fund and includes all amounts not contained in the other classifications. Unassigned amounts are technically available for any purpose. General fund is the only fund that reports a positive unassigned fund balance amount. In governmental funds other than the general fund, if expenditures incurred for specific purposes exceed the amounts that are restricted, committed, or assigned to those purposes, a negative unassigned fund balance is reported in that fund.

**CITY OF LOS ALTOS**  
**NOTES TO BASIC FINANCIAL STATEMENTS**  
**For the Year Ended June 30, 2021**

**NOTE 8 – NET POSITION AND FUND BALANCES (Continued)**

**D. Policies**

*Order of Use*

The standard also requires governments to disclose the accounting policies that indicate the order in which restricted, committed, assigned and unassigned amounts are spent. The City considers restricted amounts to have been spent first when expenditures are incurred and both restricted and unrestricted fund balances are available. Additionally, the City considers committed amounts to have been spent first, assigned amounts to have been spent second, and unassigned amounts to have been spent last when an expenditure is incurred for purposes of which committed, assigned, and unassigned fund balance is available. In circumstances when an expenditure is made for a purpose for which amounts are available in multiple fund balance classifications, fund balance is generally depleted in the order of restricted, committed, assigned, and unassigned.

*Assignment and Commitment Authority*

The City Council has approved by resolution a financial policy authorizing the City Manager to assign fund balances to facilitate year-end reporting requirements. The City Council, as the highest level of decision making authority for the City, has the ability to commit fund balances through the adoption by resolution. The same action must be taken to modify or rescind the commitment.

**E. Fund Balances**

Fund balances for all the major and non-major governmental funds as of June 30, 2021 were distributed as follows:

Fund Balance Classifications	General	In Lieu Park Land	Capital Projects	Other Governmental Funds	Total
<b>Nonspendables:</b>					
Inventory and prepaids	\$145,196				\$145,196
Notes receivable	1,704,880				1,704,880
Veteran Memorial	8,615				8,615
<b>Total Nonspendable Fund Balances</b>	<b>1,858,691</b>				<b>1,858,691</b>
<b>Restricted for:</b>					
Debt service				\$373,551	373,551
Special revenue programs and projects		\$5,780,278		5,995,243	11,775,521
<b>Total Restricted Fund Balances</b>		<b>5,780,278</b>		<b>6,368,794</b>	<b>12,149,072</b>
<b>Assigned to:</b>					
Emergency and operating	7,649,169				7,649,169
OPEB	1,500,000				1,500,000
PERS reserve	5,000,000				5,000,000
Technology reserve	1,108,582				1,108,582
Capital and equipment (Note 8I):					
Capital and equipment reserve				389,459	389,459
Construction in progress reserve			\$11,482,682		11,482,682
Community center reserve	679,110				679,110
<b>Total Assigned Fund Balances</b>	<b>15,936,861</b>		<b>11,482,682</b>	<b>389,459</b>	<b>27,809,002</b>
<b>Unassigned</b>	<b>4,928,166</b>			<b>(531,566)</b>	<b>4,396,600</b>
<b>Total Unassigned Fund Balances</b>	<b>4,928,166</b>			<b>(531,566)</b>	<b>4,396,600</b>
<b>Total Fund Balances</b>	<b>\$22,723,718</b>	<b>\$5,780,278</b>	<b>\$11,482,682</b>	<b>\$6,226,687</b>	<b>\$46,213,365</b>

**CITY OF LOS ALTOS**  
**NOTES TO BASIC FINANCIAL STATEMENTS**  
**For the Year Ended June 30, 2021**

**NOTE 8 – NET POSITION AND FUND BALANCES (Continued)**

**F. Net Deficit**

The funds listed in the table below had fund balance deficits at June 30, 2021. These deficits are expected to be eliminated by future revenues.

Fund	Fund Deficit
Storm Drain Enterprise Fund	(\$23,959)
Community Development Block Grant Special Revenue Fund	(531,566)
Dental reimbursement Internal Services Fund	(94,747)

**G. OPEB Reserves**

As of June 30, 2021, \$1,500,000 in General Fund reserves have been assigned in recognition of existing Post-Retirement Health actuarial liability.

**H. Capital Projects Reserves**

As of June 30, 2021 the City had set-aside \$679,110 for the construction of a new community center that is financed by resources other than proprietary funds. This amount was from the City’s Real Property Proceeds Fund, which are presented with the General Fund in the financial statements. While these funds are not restricted by outside funding sources, the fund balance is assigned for the new community center.

	Real Property Proceeds Fund
Beginning Fund Balance as of July 1, 2020	\$10,654,976
Revenues	
Interest Income	24,133
Total Revenues	24,133
Other Financing Sources (Uses)	
Transfers out	(10,000,000)
Total Other Financing Sources (Uses)	(10,000,000)
Ending Fund Balance as of June 30, 2021	\$679,109

**I. Encumbrances**

The City utilized an encumbrance system during fiscal year 2021 to assist in controlling expenditures. Under this system, governmental funds are encumbered when purchase orders, contracts, or other commitments are signed or approved. The General fund had an encumbrance balance at June 30, 2021 of \$1,254,492, which is reflected in the fiscal year 2021 budget.

**CITY OF LOS ALTOS**  
**NOTES TO BASIC FINANCIAL STATEMENTS**  
**For the Year Ended June 30, 2021**

**NOTE 8 – NET POSITION AND FUND BALANCES (Continued)**

***J. Closure of the Agency Funds and Restatement of Fiduciary Beginning Net Position***

The City implemented the provisions of Governmental Accounting Standards Board Statement No. 84 – Fiduciary Activities during the year ended June 30, 2021. As a result, the activities of the former agency funds are now reported as custodial funds in the fiduciary funds statements. Custodial funds beginning net position at July 1, 2020, was restated and increased by \$5,155,088.

***K. Prior Period Adjustment***

During the fiscal year 2021, the City made some prior period adjustments, as a result, the beginning fund balances for General Fund, the Capital Projects Fund, the Community Development Block Grant special revenue fund were reduced by \$2,939,821, \$161,894 and \$4,617 respectively. The beginning fund balances for the Gas Tax, TDA and Vehicle Registration special revenue funds were increased by \$19,392, \$52,724 and \$147,017 respectively. Beginning net positions at July 1, 2021 for the Governmental Activities were reduced by \$2,887,199 correspondingly.

**NOTE 9 – RISK MANAGEMENT**

***A. Bay Cities Joint Powers Insurance Authority***

The City is exposed to various risks of loss related to torts; theft of damage to and destruction of assets; errors and omissions; and floods for which the City is insured through Bay Cities Joint Powers Insurance Authority (Bay Cities).

The City has joined Bay Cities for general liability, property, errors and omissions, crimes and automobile physical damage coverage in the current year. Bay Cities is a public agency created in 1986 by and among various municipalities in Northern California to provide a pooled approach to liability insurance pursuant to the California Government Code. It is governed by a Board of Directors comprised of appointed officials from the member entities. The purpose of the pool is to provide various levels of liability coverage, claims administration, and loss control support to member agencies. Annually, each member pays an actuarially determined premium based on a formula which takes into account the prior three years' loss experience, annual payroll, and population.

Bay Cities provides coverage for its Members in excess of the member's retained limit, or self-insured retention (SIR), up to \$1,000,000 per occurrence. Each Member retains the portion of every loss that falls within their SIR, ranging from \$2,500 to \$1,000,000. Bay Cities is also a member of the California Affiliated Risk Management Authorities (CARMA), a risk sharing joint powers authority. When losses exceed the \$1,000,000 per occurrence limit, CARMA provides coverage up to \$28,000,000.

The City self-insures the first \$100,000 of each liability loss. Once the City's deductible is met, Bay Cities becomes responsible for payment of all claims up to the upper limit. During the year ended June 30, 2021, the City contributed \$110,211 or current year coverage.

The City continues to carry excess insurance policy for Workers' Compensation claims through the CSAC Excess Insurance Authority JPA up to the statutory limits and does so using the services of a contracted third-party administrator. The City has a \$250,000 deductible as of June 30, 2021. During the year, the City contributed \$660,550 for current year coverage.

**CITY OF LOS ALTOS**  
**NOTES TO BASIC FINANCIAL STATEMENTS**  
**For the Year Ended June 30, 2021**

**NOTE 9 – RISK MANAGEMENT (Continued)**

As of June 30, 2021, \$51,763 of revolving funds was held in trust on behalf of the City by the workers' compensation third-party claims administrator. \$20,000 is also being held by Bay Cities in the procurement of liability and claims coverage. The City will receive these funds upon termination of services subject to final withdrawal adjustments.

The Bay Cities financial statements may be obtained from Bay Cities Joint Powers Insurance Authority, Bickmore, 1750 Creekside Oaks Drive Suite 200, Sacramento, CA 95833. CSAC Excess Insurance Authority financial statements may be obtained from CSAC Excess Insurance Authority, 75 Iron Point Circle Suite 200, Folsom, CA 95630.

**B. Liability for Uninsured Claims**

The GASB requires municipalities to record their liability for uninsured claims and to reflect the current portion of this liability as an expenditure in their financial statements. As discussed in the section above, the City has coverage for such claims, but it has retained the risk for the deductible or uninsured portion, of these claims. The current accounting standards require that this amount be separately identified and recorded as a liability. Changes in the balances of claims liabilities during the past three years were as follows:

	June 30,		
	2021	2020	2019
Unpaid claims, beginning of year	\$3,750,000	\$3,492,000	\$3,580,000
Incurred claims and changes in estimates	68,724	816,675	247,742
Claim payments	402,276	(558,675)	(335,742)
Unpaid claims, end of year	<u>\$4,221,000</u>	<u>\$3,750,000</u>	<u>\$3,492,000</u>
Current Portion	<u>\$1,072,302</u>	<u>\$930,123</u>	<u>\$827,371</u>
Long-Term Portion	<u>\$3,148,698</u>	<u>\$2,819,877</u>	<u>\$2,664,629</u>

In conformance with current accounting standards the City obtained an independent actuarial valuation of all outstanding Workers Compensation and Liability claims. The Workers Compensation report presented a valuation as of December 31, 2020 and projected values through fiscal years 2021 and 2022. The fiscal year 2020-2021 values presented above reflect the estimated present value of open claims as developed in this actuarial report. The General Liability report presented a valuation as of December 31, 2020 and projected values through fiscal years 2021 and 2022. The estimated amount of claims and judgments due within one year is \$1,072,302.

**CITY OF LOS ALTOS**  
**NOTES TO BASIC FINANCIAL STATEMENTS**  
**For the Year Ended June 30, 2021**

**NOTE 10 – SELF-FUNDED REIMBURSEMENT DENTAL AND VISION PLAN**

The City provides a self-funded reimbursement based dental and vision plans. The City’s contribution for these plans are accounted for in the Dental Reimbursement Fund. The City contributed \$75 per month for each fulltime budgeted position. The funds accumulated are used to reimburse full-time salaried employees and their dependents, as well as council members for covered dental and vision claims. There are no administrative charges for this plan. The Dental Reimbursement Fund has a negative fund balance of \$94,747 in fiscal year 2021 due to the plans operating on a calendar year basis. Contributions and reimbursements for the past five fiscal years as follows:

Fiscal year ended June 30,	Contribution Amount	Reimbursement Amount
2017	\$121,350	\$125,208
2018	127,800	177,094
2019	125,324	238,064
2020	258,874	253,377
2021	264,121	308,786
Total	<u>\$897,469</u>	<u>\$1,102,529</u>

The dental and vision plan year commences January 1st of each calendar year. An annual maximum dental and vision reimbursements of \$1,939 are provided for each employee and \$1,291 for each of their dependents. Any remaining balance in the fund for each plan year is carried forward to the following year. In subsequent years, the maximum coverage for both employees and dependents is increased annually based on the Consumer Price Index but not to exceed 3%.

**NOTE 11 – PENSION PLAN**

For purposes of measuring the net pension liability and deferred outflows/inflows of resources related to pensions, and pension expense, information about the fiduciary net position of the City’s California Public Employees’ Retirement System (CalPERS) plan (Plan) and additions to/deductions from the Plan’s fiduciary net position have been determined on the same basis as they are reported by CalPERS. For this purpose, benefit payments (including refunds of employee contributions) are recognized when due and payable in accordance with the benefit terms. Investments are reported at fair value.

**A. General Information about the Pension Plan**

**Plan Descriptions** – All qualified permanent and probationary employees are eligible to participate in the City’s Miscellaneous and Safety Tier I, Tier II and PEPRA Employee Pension Rate Plan. The City’s Miscellaneous Rate Plan is part of the public agency cost-sharing multiple-employer defined benefit pension plan (PERF C), which is administered by the California Public Employees’ Retirement System (CalPERS). PERF C consists of a miscellaneous pool and a safety pool (also referred to as “risk pools”), which are comprised of individual employer miscellaneous and safety rate plans, respectively. Individual employers may sponsor more than one miscellaneous and safety rate plan. The employer participates in one cost-sharing multiple-employer defined benefit pension plan regardless of the number of rate plans the employer sponsors. The City sponsors three miscellaneous and three safety rate plans. Benefit provisions under the Plan are established by State statute and City resolution. CalPERS issues publicly available reports that include a full description of the pension plan regarding benefit provisions, assumptions and membership information that can be found on the CalPERS website.



**CITY OF LOS ALTOS**  
**NOTES TO BASIC FINANCIAL STATEMENTS**  
**For the Year Ended June 30, 2021**

**NOTE 11 – PENSION PLAN (Continued)**

**Benefits Provided** – CalPERS provides service retirement and disability benefits, annual cost of living adjustments and death benefits to plan members, who must be public employees and beneficiaries. Benefits are based on years of credited service, equal to one year of full time employment. Members with five years of total service are eligible to retire at age 50 with statutorily reduced benefits. All members are eligible for non-duty disability benefits after 10 years of service. The death benefit is one of the following: the Basic Death Benefit, the 1957 Survivor Benefit, or the Optional Settlement 2W Death Benefit. The cost of living adjustments for each plan are applied as specified by the Public Employees’ Retirement Law.

The Plan’s provisions and benefits in effect at June 30, 2021, are summarized as follows:

	<u>Miscellaneous - Tier 1</u>
Hire date	Prior to January 1, 2012
Benefit formula	2.7% @ 55
Benefit vesting schedule	5 years service
Benefit payments	monthly for life
Retirement age	50 - 67
Monthly benefits, as a % of eligible compensation	2.000% - 2.700%
Required employee contribution rates	8.000%
Required employer contribution rates	14.194%
	 <u>Miscellaneous - Tier 2</u>
Hire date	January 1, 2012 - December 31, 2012
Benefit formula	2% @ 60
Benefit vesting schedule	5 years service
Benefit payments	monthly for life
Retirement age	50 - 67
Monthly benefits, as a % of eligible compensation	1.092% - 2.418%
Required employee contribution rates	7.000%
Required employer contribution rates	8.794%
	 <u>Miscellaneous - PEPRA</u>
Hire date	On or after January 1, 2013
Benefit formula	2% @ 62
Benefit vesting schedule	5 years service
Benefit payments	monthly for life
Retirement age	52 - 67
Monthly benefits, as a % of eligible compensation	1.000% - 2.500%
Required employee contribution rates	6.750%
Required employer contribution rates	7.732%

**CITY OF LOS ALTOS**  
**NOTES TO BASIC FINANCIAL STATEMENTS**  
**For the Year Ended June 30, 2021**

**NOTE 11 – PENSION PLAN (Continued)**

	<u>Safety - Tiers 1 and 2</u>
Hire date	Prior to January 1, 2012
Benefit formula	3% @ 50
Benefit vesting schedule	5 years service
Benefit payments	monthly for life
Retirement age	50 - 55
Monthly benefits, as a % of eligible compensation	3.000%
Required employee contribution rates	9.000%
Required employer contribution rates	23.674%
	 <u>Safety - Tier 3</u>
Hire date	January 1, 2012 - December 31, 2012
Benefit formula	3% @ 55
Benefit vesting schedule	5 years service
Benefit payments	monthly for life
Retirement age	50 - 55
Monthly benefits, as a % of eligible compensation	2.400% - 3.000%
Required employee contribution rates	9.000%
Required employer contribution rates	20.585%
	 <u>Safety - PEPRA</u>
Hire date	On or after January 1, 2013
Benefit formula	2.7% @ 57
Benefit vesting schedule	5 years service
Benefit payments	monthly for life
Retirement age	50 - 57
Monthly benefits, as a % of eligible compensation	2.000% - 2.700%
Required employee contribution rates	13.000%
Required employer contribution rates	13.044%

Beginning in fiscal year 2018, CalPERS collects employer contributions for the Plan as a percentage of payroll for the normal cost portion as noted in the rates above and as dollar amount for contributions toward the unfunded liability and side fund. The dollar amounts are billed on a monthly basis. The City's required contribution for the unfunded liability and side fund was \$2,783,677 in fiscal year 2021.

**Contributions** – Section 20814(c) of the California Public Employees' Retirement Law requires that the employer contribution rates for all public employers be determined on an annual basis by the actuary and shall be effective on the July 1 following notice of a change in the rate. Funding contributions for the Plan are determined annually on an actuarial basis as of June 30 by CalPERS. The actuarially determined rate is the estimated amount necessary to finance the costs of benefits earned by employees during the year, with an additional amount to finance any unfunded accrued liability. The City is required to contribute the difference between the actuarially determined rate and the contribution rate of employees.

**CITY OF LOS ALTOS**  
**NOTES TO BASIC FINANCIAL STATEMENTS**  
**For the Year Ended June 30, 2021**

**NOTE 11 – PENSION PLAN (Continued)**

For the year ended June 30, 2021, the contributions recognized as part of pension expense for the Plan were as follows:

	Miscellaneous	Safety	Total
Contributions - employer	\$2,588,732	\$2,201,042	\$4,789,774

**B. Pension Liabilities, Pension Expenses and Deferred Outflows/Inflows of Resources Related to Pensions**

As of June 30, 2021, the City reported a net pension liability for its proportionate share of the net pension liability of the Plan as follows:

	Proportionate Share of Net Pension Liability
Miscellaneous	\$23,257,604
Safety	19,111,513
Total Net Pension Liability	\$42,369,117

The City's net pension liability for the Plan is measured as the proportionate share of the net pension liability. The net pension liability of the Plan is measured as of June 30, 2020, and the total pension liability for the Plan used to calculate the net pension liability was determined by an actuarial valuation as of June 30, 2019 rolled forward to June 30, 2020 using standard update procedures. The City's proportion of the net pension liability was based on a projection of the City's long-term share of contributions to the pension plan relative to the projected contributions of all participating employers, actuarially determined. The City's proportionate share of the net pension liability for the Plan as of June 30, 2019 and 2020 was as follows:

	Miscellaneous	Safety
Proportion - June 30, 2019	0.54%	0.28%
Proportion - June 30, 2020	0.55%	0.29%
Change - Increase (Decrease)	0.01%	0.01%

**CITY OF LOS ALTOS**  
**NOTES TO BASIC FINANCIAL STATEMENTS**  
**For the Year Ended June 30, 2021**

**NOTE 11 – PENSION PLAN (Continued)**

For the year ended June 30, 2021, the City recognized pension expense of \$1,789,174. At June 30, 2021, the City reported deferred outflows of resources and deferred inflows of resources related to pensions from the following sources:

**Miscellaneous Plan**

	<u>Deferred Outflows of Resources</u>	<u>Deferred Inflows of Resources</u>
Pension contributions subsequent to measurement date	\$2,588,732	
Differences between actual and expected experience	1,198,533	
Changes in assumptions		(\$165,883)
Change in employer's proportion and differences between the employer's contributions and the employer's proportionate share of contributions		(369,920)
Net differences between projected and actual earnings on plan investments	690,904	
Adjustments due to differences in proportion	474,104	(66,475)
<b>Miscellaneous Total</b>	<b><u>\$4,952,273</u></b>	<b><u>(\$602,278)</u></b>

**Safety Plan**

	<u>Deferred Outflows of Resources</u>	<u>Deferred Inflows of Resources</u>
Pension contributions subsequent to measurement date	\$2,201,042	
Differences between actual and expected experience	1,482,001	
Changes in assumptions		(\$63,661)
Change in employer's proportion and differences between the employer's contributions and the employer's proportionate share of contributions		(522,830)
Net differences between projected and actual earnings on plan investments	415,374	
Adjustments due to differences in proportion	504,804	
Safety Total	<b><u>\$4,603,221</u></b>	<b><u>(\$586,491)</u></b>
<b>Grand total</b>	<b><u>\$9,555,494</u></b>	<b><u>(\$1,188,769)</u></b>

**CITY OF LOS ALTOS**  
**NOTES TO BASIC FINANCIAL STATEMENTS**  
**For the Year Ended June 30, 2021**

**NOTE 11 – PENSION PLAN (Continued)**

\$4,789,774 reported as deferred outflows of resources related to contributions subsequent to the measurement date will be recognized as a reduction of the net pension liability in the year ended June 30, 2022. Other amounts reported as deferred outflows of resources and deferred inflows of resources related to pensions will be recognized as pension expense as follows:

Year Ended June 30	<u>Miscellaneous</u>	<u>Safety</u>	<u>Total</u>
	Annual Amortization	Annual Amortization	Annual Amortization
2022	\$188,257	\$443,303	\$631,560
2023	687,186	682,144	1,369,330
2024	554,442	482,117	1,036,559
2025	331,377	208,125	539,502
	<u>\$1,761,262</u>	<u>\$1,815,689</u>	<u>\$3,576,951</u>

**Actuarial Assumptions** – For the measurement period ended June 30, 2020, the total pension liability was determined by rolling forward the June 30, 2019 total pension liability. The June 30, 2019 total pension liability is based on the following actuarial methods and assumptions:

	<u>Miscellaneous &amp; Safety</u>
Valuation Date	6/30/2019
Measurement Date	6/30/2020
Actuarial Cost Method	Entry-Age Normal Cost Method
Actuarial Assumptions:	
Discount Rate	7.15%
Inflation	2.50%
Salary Increase	(1)
Investment Rate of Return	7.15% (2)
Mortality	Derived using CalPERS' Membership Data for all funds (3)
Post Retirement Benefit Increase	Contract COLA up to 2.50% until Purchasing Power Protection Allowance Floor on Purchasing Power applies

(1) Depending on age, service and type of employment

(2) Net of pension plan investment expenses, including inflation

(3) The mortality table used was developed based on CalPERS' specific data. The table includes 15 years of mortality improvements using the Society of Actuaries Scale 90% of scale MP 2016. For more details on this table, please refer to the CalPERS December 2017 experience study report (based on CalPERS demographic data from 1997 to 2015) that can be found on the CalPERS website.

The underlying mortality assumptions and all other actuarial assumptions used in the June 30, 2019 valuation were based on the results of a December 2018 actuarial experience study for the period 1997 to 2015. Further details of the Experience Study can be found on the CalPERS website.

**CITY OF LOS ALTOS**  
**NOTES TO BASIC FINANCIAL STATEMENTS**  
**For the Year Ended June 30, 2021**

**NOTE 11 – PENSION PLAN (Continued)**

**Discount Rate** – The discount rate used to measure the total pension liability for the Plan was 7.15%. The projection of cash flows used to determine the discount rate for the Plan assumed that contributions from all plan members in the Public Employees Retirement Fund (PERF) will be made at the current member contribution rates and the contributions from employers will be made at statutorily required rates, actuarially determined. Based on those assumptions, the Plan’s fiduciary net position was projected to be available to make all projected future benefit payments of current plan members. Therefore, the long-term expected rate of return on plan investments was applied to all periods of projected benefit payments to determine the total pension liability.

The long-term expected rate of return on pension plan investments was determined using a building-block method in which expected future real rates of return (expected returns, net of pension plan investment expense and inflation) are developed for each major asset class.

In determining the long-term expected rate of return, CalPERS took into account both short-term and long-term market return expectations as well as the expected pension fund cash flows. Using historical and forecasted information for all the funds’ asset classes, expected compound (geometric) returns were calculated over the short-term (first 10 years) and the long-term (11+ years) using a building-block approach. Using the expected nominal returns for both short-term and long-term, the present value of benefits was calculated for each fund. The expected rate of return was set by calculating the rounded single equivalent expected return that arrived at the same present value of benefits for cash flows as the one calculated using both short-term and long-term returns. The expected rate of return was then set equal to the single equivalent rate calculated above and adjusted to account for assumed administrative expenses.

The table below reflects the expected real rates of return by asset class.

Asset Class (a)	New Strategic Allocation	Real Return Years 1 - 10(b)	Real Return Years 11+(c)
Global Equity	50.0%	4.80%	5.98%
Fixed Income	28.0%	1.00%	2.62%
Inflation Assets	0.0%	0.77%	1.81%
Private Equity	8.0%	6.30%	7.23%
Real Assets	13.0%	3.75%	4.93%
Liquidity	1.0%		-0.92%
Total	<u>100%</u>		

- (a) In the CalPERS Comprehensive Annual Financial Report, Fixed Income is included in Global Debt Securities; Liquidity is included in Short-term Investments; Inflation Assets are included in both Global Equity Securities and Global Debt Securities.
- (b) An expected inflation of 2.00% used for this period.
- (c) An expected inflation of 2.92% used for this period.

**CITY OF LOS ALTOS**  
**NOTES TO BASIC FINANCIAL STATEMENTS**  
**For the Year Ended June 30, 2021**

**NOTE 11 – PENSION PLAN (Continued)**

***Sensitivity of the Proportionate Share of the Net Pension Liability to Changes in the Discount Rate*** – The following presents the City’s proportionate share of the net pension liability for the Plan, calculated using the discount rate for the Plan, as well as what the City’s proportionate share of the net pension liability would be if it were calculated, as using a discount rate that is 1-percentage point lower or 1-percentage point higher than the current rate:

	Miscellaneous	Safety
1% Decrease	6.15%	6.15%
Net Pension Liability	\$33,854,725	\$27,889,889
Current Discount Rate	7.15%	7.15%
Net Pension Liability	\$23,257,604	\$19,111,513
1% Increase	8.15%	8.15%
Net Pension Liability	\$14,501,536	\$11,908,025

***Pension Plan Fiduciary Net Position*** – Detailed information about the pension plan’s fiduciary net position is available in the separately issued CalPERS financial reports.

***Reduction of CalPERS Discount Rate*** - In July 2021, CalPERS reported a preliminary 21.3% net return on investments for the 12-month period that ended June 30, 2021. Under the Funding Risk Mitigation Policy approved by the CalPERS Board of Administration in 2015, the 21.3% net return was under the original expected return of 21.7%, which will trigger a reduction in the discount rate used to calculate employer and Public Employees' Pension Reform Act (PEPRA) member contributions. The Funding Risk Mitigation Policy seeks to reduce CalPERS funding risk over time, in which CalPERS investment performance that significantly outperforms the discount rate will trigger adjustments to the discount rate, expected investment return, and strategic asset allocation targets. This is the first time it has been triggered. The discount rate, or assumed rate of return, will drop to 6.8%, from its current level of 7%.

Based on these preliminary fiscal year returns, the CalPERS has announced the funded status of the overall PERF is an estimated 82%. This estimate is based on a 7% discount rate. Under the new 6.8% discount rate, however, CalPERS indicated the funded status of the overall PERF drops to 80%. This is because existing assets are assumed to grow at a slightly slower rate annually into the future. As intended under the Funding Risk Mitigation Policy, the lower discount rate increases the likelihood that CalPERS can reach its target over the longer term. The CalPERS Board of Administration will continue to review the discount rate through its Asset Liability Management process during the rest of the calendar year. CalPERS' final fiscal year 2021 investment performance will be calculated based on audited figures and will be reflected in contribution levels for contracting cities, counties, and special districts in fiscal year 2024.

**CITY OF LOS ALTOS**  
**NOTES TO BASIC FINANCIAL STATEMENTS**  
**For the Year Ended June 30, 2021**

**NOTE 12 – OTHER POST EMPLOYMENT BENEFITS (OPEB)**

**A. General Information about the City’s Other Post Employment Benefit (OPEB) Plan**

**Plan Description** – The City’s Post Employment Benefit Plan is an agent-multiple-employer defined benefit healthcare plan administered by the California Employers’ Retiree Benefit Trust (CERBT).

**Benefits Provided** – The provisions and benefits of the City’s Other Post Employment Benefit Plan in effect at June 30, 2021, are summarized as follow:

	<b>All Bargaining Units</b>						
<b>Eligibility</b>	Retire directly from the City under CalPERS (age 50 <sup>1</sup> and 5 years of service or disability)						
<b>Benefit</b>	- 5% of active contribution times years in PEMHCA (increase each year not greater than \$100 per month) - Joined PEMHCA in 2001 - 100% of PEMHCA minimum in 2021 - Monthly amounts: <table style="margin-left: 40px; border-collapse: collapse;"> <tr> <td style="text-align: center;"><u>Year</u></td> <td style="text-align: center;"><u>Actives</u></td> <td style="text-align: center;"><u>Retirees</u></td> </tr> <tr> <td style="text-align: center;">2021</td> <td style="text-align: center;">\$ 132</td> <td style="text-align: center;">\$ 124</td> </tr> </table>	<u>Year</u>	<u>Actives</u>	<u>Retirees</u>	2021	\$ 132	\$ 124
<u>Year</u>	<u>Actives</u>	<u>Retirees</u>					
2021	\$ 132	\$ 124					
<b>Surviving Spouse Benefit</b>	Surviving spouse coverage continues based on CalPERS retirement plan election						
<b>Other</b>	- No dental, vision & life or Medicare reimbursement - Implicit rate subsidy included						

<sup>1</sup> Age 52 for Miscellaneous PEPRAs members

For the year ended June 30, 2021, the City’s contributions to the Plan were \$118,972.

**Employees Covered by Benefit Terms** – Membership in the plan consisted of the following at the measurement date of June 30, 2020:

Active employees	146
Inactive employees or beneficiaries currently receiving benefit payments	50
Inactive employees entitled to but not yet receiving benefit payments	90
Total	286



**CITY OF LOS ALTOS**  
**NOTES TO BASIC FINANCIAL STATEMENTS**  
**For the Year Ended June 30, 2021**

**NOTE 12 – OTHER POST EMPLOYMENT BENEFITS (OPEB) (Continued)**

**B. Net OPEB Liability**

**Actuarial Methods and Assumptions** – The City net OPEB liability was measured as of June 30, 2020 and the total OPEB liability used to calculate the net OPEB liability was determined by an actuarial valuation dated January 1, 2019 that was rolled forward using standard update procedures to determine the total OPEB liability as of June 30, 2020, based on the following actuarial methods and assumptions:

Actuarial Assumptions	June 30, 2020 Measurement Date
Valuation Date	January 01, 2019
Actuarial Cost Method	• Entry Age Normal, Level Percentage of Payroll
Contribution Policy	• City contributes full Actuarial Determined Contribution through CERBT #1
Discount Rate and Long Term Expected Rate of Return on Assets	• 6.75% at June 30, 2020
	• 6.75% at June 30, 2019
	• Expected City contributions projected to keep sufficient plan assets to pay all benefits from trust
General Inflation	• 2.75% annually
Mortality, Retirement, Disability, Termination	• CalPERS 1997-2015 Experience Study
Mortality Improvement	• Mortality Improvement Scale MP-18
Salary Increases	• Aggregate - 3% annually
	• Merit - CalPERS 1997-2015 Experience Study
Medical Trend	• Non-Medicare - 7.5% for 2020, decreasing to an ultimate rate of 4.0% in 2076 and later years
	• Medicare - 6.5% for 2020, decreasing to an ultimate rate of 4.0% in 2076 and later years
PEMHCA Minimum Increases	• 4.25% annually
Healthcare participation	• 60%

The long-term expected rate of return on OPEB plan investments was determined using a building-block method in which expected future real rates of return (expected returns, net of OPEB plan investment expense and inflation) are developed for each major asset class. These ranges are combined to produce the long-term expected rate of return by weighting the expected future real rates of return by the target asset allocation percentage and by adding expected inflation. The target allocation and best estimates of arithmetic real rates of return for each major asset class are summarized in the following table:

Asset Class	Target Allocation	Long-Term Expected Real Rate of Return
Global equity	59.0%	4.82%
Fixed income	25.0%	1.47%
TIPS	5.0%	1.29%
Commodities	3.0%	0.84%
REITs	8.0%	3.76%
Total	100.0%	

**Discount Rate** – The discount rate used to measure the total OPEB liability was 6.75%. The projection of cash flows used to determine the discount rate assumed that City contributions will be made at rates equal to the actuarially determined contribution rates. Based on those assumptions, the OPEB plan’s fiduciary net position was projected to be available to make all projected OPEB payments for current active and inactive employees and beneficiaries. Therefore, the long-term expected rate of return on OPEB plan investments was applied to all periods of projected benefit payments to determine the total OPEB liability.

**CITY OF LOS ALTOS**  
**NOTES TO BASIC FINANCIAL STATEMENTS**  
**For the Year Ended June 30, 2021**

**NOTE 12 – OTHER POST EMPLOYMENT BENEFITS (OPEB) (Continued)**

**C. Changes in Net OPEB Liability**

The changes in the net OPEB liability follows:

	<b>Total OPEB Liability (a)</b>	<b>Plan Fiduciary Net Position (b)</b>	<b>Net OPEB Liability/(Asset) (a) - (b)</b>
Balance at June 30, 2019 Measurement Date	\$3,297,885	\$1,915,574	\$1,382,311
Changes Recognized for the Measurement Period:			
Service Cost	195,973		195,973
Interest on the total OPEB liability	231,856		231,856
Changes in benefit terms			0
Differences between expected and actual experience			0
Changes of assumptions			0
Contributions from the employer		118,972	(118,972)
Net investment income		67,723	(67,723)
Benefit payments	(117,894)	(117,894)	0
Administrative expenses		(2,014)	2,014
Net changes	309,935	66,787	243,148
Balance at June 30, 2020 Measurement Date	\$3,607,820	\$1,982,361	\$1,625,459

The City paid \$117,894 for retiree healthcare plan benefits, including \$75,894 in premium payments for retirees, \$42,000 for implied subsidies, and \$1,078 for administrative costs. The plan does not issue separate financial statements.

**D. Sensitivity of the Net OPEB Liability to Changes in the Discount Rate and Healthcare Cost Trend Rates**

The following presents the net OPEB liability of the City, as well as what the City's net OPEB liability would be if it were calculated using a discount rate that is 1-percentage-point lower (5.75%) or 1-percentage-point higher (7.75%) than the current discount rate:

Net OPEB Liability/(Asset)		
Discount Rate -1%	Current Discount Rate	Discount Rate +1%
(5.75%)	(6.75%)	(7.75%)
\$2,118,198	\$1,625,459	\$1,218,011

**CITY OF LOS ALTOS**  
**NOTES TO BASIC FINANCIAL STATEMENTS**  
**For the Year Ended June 30, 2021**

**NOTE 12 – OTHER POST EMPLOYMENT BENEFITS (OPEB) (Continued)**

The following table presents the net OPEB liability of the City, as well as what the City's net OPEB liability would be if it were calculated using healthcare cost trend rates that are 1-percentage-point or 1-percentage-point higher than the current healthcare cost trend rates.

The healthcare cost trend are as follows:

- Non-Medicare: 7.5% for 2021, decreasing to an ultimate rate of 4.0% in 2076 and later years.
- Medicare: 6.5% for 2021, decreasing to an ultimate rate of 4.0% in 2076 and later years.

Net OPEB Liability/(Asset)		
1% Decrease	Current Healthcare Cost Trend Rates	1% Increase
\$1,115,107	\$1,625,459	\$2,262,568

**E. OPEB Expense and Deferred Outflows/Inflows of Resources Related to OPEB**

For the year ended June 30, 2021, the City recognized OPEB expense of \$100,217. At June 30, 2021, the City reported deferred outflows and inflows of resources related to OPEB from the following sources:

	Deferred Outflows of Resources	Deferred Inflows of Resources
Employer contributions made subsequent to the measurement date	\$132,024	
Net differences between projected and actual earnings on plan investments	36,755	
Differences between expected and actual experience		(\$386,203)
Changes in assumptions	94,792	
Total	\$263,571	(\$386,203)

\$132,024 reported as deferred outflows of resources related to contributions subsequent to the measurement date will be recognized as a reduction of the OPEB liability in the year ended June 30, 2021. Other amounts reported as deferred outflows of resources and deferred inflows of resources related to OPEB will be recognized as part of OPEB expense as follows:

Year Ended June 30	Annual Amortization
2022	(\$51,556)
2023	(42,556)
2024	(37,557)
2025	(39,728)
2026	(52,038)
Thereafter	(31,221)
Total	(\$254,656)

**CITY OF LOS ALTOS**  
**NOTES TO BASIC FINANCIAL STATEMENTS**  
**For the Year Ended June 30, 2021**

**NOTE 13 – CONTINGENCIES**

The City is presently involved in certain matters of litigation that have arisen in the normal course of conducting City business. City management believes, based upon consultation with the City Attorney, that these cases in the aggregate, although they could potentially result in a material adverse financial impact on the City, a reasonable estimate of the outcome and impacts could not be made at the financial statement issuance date.

The City participates in several Federal and State grant programs. These programs are subject to the audits by the City's independent accountants in accordance with the provisions of the Federal Single Audit Act as amended and applicable State requirements. In addition, these programs are subject to further examination by the grantors and the amount, if any, of expenditures which may be disallowed by the granting agencies cannot be determined at this time. The City expects such amounts, if any, to be immaterial.

**NOTE 14 – OTHER INFORMATION**

**A. *Joint Powers Agreements***

The City participates in joint ventures through Joint Powers Authorities (JPAs) established under the Joint Exercise of Powers Act of the State of California. As separate legal entities, these JPAs exercise full powers and authorities within the scope of the related Joint Powers Agreement, including the preparation of annual budgets, accountability for all funds, the power to make and execute contracts and the right to sue and be sued. Obligations and liabilities of the JPAs are not those of the City.

Each JPA is governed by a board consisting of representatives from each member agency. Each board controls the operations of its respective JPA, including selection of management and approval of operating budgets, independent of any influence of member agencies beyond their representation of the board.

**City of Palo Alto Regional Water Quality Control Plant:** The City has an agreement with the City of Palo Alto to purchase treatment capacity at the Palo Alto Regional Water Quality Control Plant. It was formed in 1968 by a joint exercise of powers among the cities of Palo Alto, Mountain View, and Los Altos, constructed, maintains and operates sewage treatment facilities serving its member cities. The agreement provides that the City will purchase capacity for 50 years. The City of Palo Alto acts as administrator and bills each member its share of the operating costs. The audited financial statements can be obtained by contacting the City of Palo Alto at P.O. Box 10250, Palo Alto, CA 94303.

**North County Library Authority (NCLA):** The NCLA, formed in 1985 by a joint exercise of powers agreement between the City and the Town of Los Altos Hills, provides library services for member residents. The NCLA was created to provide financing for capital improvements and additional services by the public libraries serving the area. Although the City owns the libraries and their sites, the County of Santa Clara (County) is responsible for all library operations. However, since 1985, the NCLA has levied a voter approved special parcel tax to compensate for service reductions due to cutbacks by the County. The special tax has been collected by the County, transferred to the City, on behalf of NCLA, and then transferred back to the County for the specifically requested services provided by the libraries within the NCLA's service area. The City performs administrative and accounting services for NCLA. In 1991, the NCLA issued Special Tax Bonds in the amount of \$3,645,000. The Special Tax Bonds were repaid off as of June 30, 2012. In 2010, NCLA successfully passed an updated twenty year parcel tax extending the assessment term to 2030. No new debt was issued in association with this election. The audited financial statements can be obtained by contacting the NCLA at One North San Antonio Road, Los Altos, CA 94022.

**CITY OF LOS ALTOS**  
**NOTES TO BASIC FINANCIAL STATEMENTS**  
**For the Year Ended June 30, 2021**

**NOTE 14 – OTHER INFORMATION (Continued)**

**Community Health Awareness Council (CHAC):** CHAC was organized as a joint powers agency between the City of Los Altos, City of Mountain View, Town of Los Altos Hills, Los Altos School District, Mountain View Whisman School District, and Mountain View-Los Altos High School District. CHAC provides prevention and intervention services concentrating on positive alternatives to health abuse and self-destructive behaviors within the communities served. The audited financial statements can be obtained by contacting CHAC at P.O. Box 335, Mountain View, California, 94042.

**Silicon Valley Clean Energy Authority:** The Silicon Valley Clean Energy Authority (SVCEA) was established in 2016 by 12 agencies in Santa Clara County including the City of Los Altos. The purpose of SVCEA is to enable the member agencies to pool the electricity demand within their jurisdictions to directly procure or generate electrical power supplies on behalf of the residents and businesses in their communities, thus allowing those agencies to provide a clean energy option for residents at a competitive price with traditional energy sources. As part of the implementation of SVCEA, the City of Los Altos paid \$100,000 for its portion of the start-up costs. These funds are to be reimbursed to the City once the Authority has achieved financial sustainability.

**NOTE 15 – OTHER COMMITMENTS**

A summary of remaining authorized CIP project balances at June 30, 2021 for all City funds by service area are as follows:

Construction in progress:	
Streets and Roadways	\$12,375,929
Pedestrian Safety	786,506
Infrastructure and Facilities	2,112,509
Parks	1,180,352
Sewer	6,729,484
Technology	936,709
Community Development	817,139
Storm Drain	962,492
Public Art	60,000
Total	\$25,961,120



*This Page Left Intentionally Blank*

**REQUIRED SUPPLEMENTARY INFORMATION**



*This Page Left Intentionally Blank*



**CITY OF LOS ALTOS**  
**Notes to Required Supplementary Information**  
**For the Year Ended June 30, 2021**

**COST-SHARING EMPLOYER DEFINED PENSION PLAN:**

**SCHEDULE OF PROPORTIONATE SHARE OF THE NET PENSION LIABILITY AND RELATED RATIO**

This schedule reports the proportion (percentage) of the collective net pension liability, the proportionate share (amount) of the collective net pension liability, the employer's covered employee payroll, the proportionate share (amount of the collective net pension liability as a percentage of the employer's covered employee payroll and the pension plan's fiduciary net position as a percentage of the total pension liability.

**SCHEDULE OF CONTRIBUTIONS**

This schedule reports the cost sharing employer's contributions to the plan which are actuarially determined, the employer's actual contributions, the difference between the actual and actuarially determined contributions, and a ratio of the actual contributions divided by covered employee payroll.

**CITY OF LOS ALTOS**  
**Notes to Required Supplementary Information**  
**For the Year Ended June 30, 2021**

Schedule of Proportionate Share of the  
Net Pension Liability and Related Ratio as of the Measurement Date

Cost-Sharing Multiple-Employer Defined Pension Plan  
Last 10 Years\*

Measurement Date	Miscellaneous Pool						
	6/30/2014	6/30/2015	6/30/2016	6/30/2017	6/30/2018	6/30/2019	6/30/2020
Plan's proportion of the Net Pension Liability (Asset)	0.42907%	0.50595%	0.20298%	0.51409%	0.52958%	0.54011%	0.55138%
Plan's proportion share of the Net Pension Liability (Asset)	\$10,604,408	\$13,880,661	\$17,564,072	\$20,265,838	\$19,958,437	\$21,628,592	\$23,257,604
Plan's Covered Payroll	7,736,180	7,806,721	8,434,058	8,337,461	9,734,936	9,569,932	10,185,806
Plan's Proportionate Share of the Net Pension Liability/(Asset) as a Percentage of its Covered Payroll	137.08%	177.80%	208.25%	243.07%	205.02%	226.01%	228.33%
Plan's Fiduciary Net Position as a Percentage of the Total Pension Liability	83.03%	78.28%	73.20%	75.39%	77.69%	77.73%	77.71%

Measurement Date	Safety Pool						
	6/30/2014	6/30/2015	6/30/2016	6/30/2017	6/30/2018	6/30/2019	6/30/2020
Plan's proportion of the Net Pension Liability (Asset)	0.24026%	0.25820%	0.16023%	0.26642%	0.27582%	0.28041%	0.28686%
Plan's proportion share of the Net Pension Liability (Asset)	\$9,011,972	\$10,639,010	\$13,864,825	\$15,919,233	\$16,183,695	\$17,504,397	\$19,111,513
Plan's Covered Payroll	3,607,754	3,645,893	3,885,679	3,686,478	4,233,297	4,320,366	4,135,400
Plan's Proportionate Share of the Net Pension Liability/(Asset) as a Percentage of its Covered Payroll	249.79%	291.81%	356.82%	431.83%	382.30%	405.16%	462.14%
Plan's Proportionate Share of the Fiduciary Net Position as a Percentage of the Plan's Total Pension Liability	81.46%	78.52%	73.96%	71.74%	73.39%	73.37%	73.12%

\* Fiscal year 2015 was the 1st year of implementation.

**CITY OF LOS ALTOS**  
**Notes to Required Supplementary Information**  
**For the Year Ended June 30, 2021**

**Cost-Sharing Multiple-Employer Defined Pension Plan**  
**As of fiscal year ending June 30, 2021**  
**Last 10 Years\***  
**SCHEDULE OF CONTRIBUTIONS**

	Miscellaneous Pool						
	Fiscal Year 2015	Fiscal Year 2016	Fiscal Year 2017	Fiscal Year 2018	Fiscal Year 2019	Fiscal Year 2020	Fiscal Year 2021
Actuarially determined contribution	\$1,081,811	\$1,456,475	\$1,544,680	\$1,769,644	\$1,974,752	\$2,356,569	\$2,588,732
Contributions in relation to the actuarially determined contributions	(1,081,811)	(1,456,475)	(1,544,680)	(1,769,644)	(1,974,752)	(2,356,569)	(2,588,732)
Contribution deficiency (excess)	\$0	\$0	\$0	\$0	\$0	\$0	\$0
Covered payroll	\$7,806,721	\$8,434,058	\$8,337,461	\$9,734,936	\$9,569,932	\$10,185,806	\$10,715,749
Contributions as a percentage of covered payroll	13.86%	17.27%	18.53%	18.18%	20.63%	23.14%	24.16%
<b>Notes to Schedule</b>							
Valuation date:	6/30/2013	6/30/2014	6/30/2015	6/30/2016	6/30/2017	6/30/2018	6/30/2019

	Safety Pool						
	Fiscal Year 2015	Fiscal Year 2016	Fiscal Year 2017	Fiscal Year 2018	Fiscal Year 2019	Fiscal Year 2020	Fiscal Year 2021
Actuarially determined contribution	\$924,466	\$1,134,277	\$1,205,365	\$1,390,429	\$1,605,370	\$1,962,129	\$2,201,042
Contributions in relation to the actuarially determined contributions	(1,076,741)	(1,134,277)	(1,205,365)	(1,390,429)	(1,605,370)	(1,962,129)	(2,201,042)
Contribution deficiency (excess)	(\$152,275)	\$0	\$0	\$0	\$0	\$0	\$0
Covered payroll	\$3,645,893	\$3,885,679	\$3,686,478	\$4,233,297	\$4,320,366	\$4,135,400	\$4,760,661
Contributions as a percentage of covered payroll	29.53%	29.19%	32.70%	32.85%	37.16%	47.45%	46.23%
<b>Notes to Schedule</b>							
Valuation date:	6/30/2013	6/30/2014	6/30/2015	6/30/2016	6/30/2017	6/30/2018	6/30/2019

Methods and assumptions used to determine contribution rates:

Actuarial cost method	Entry age
Amortization method	Level percentage of payroll
Remaining amortization period	15 years
Asset valuation method	5-year smoothed market
Inflation	2.50%
Salary increases	(1)
Investment rate of return	7.15% (2)
Mortality	Derived using CalPERS Membership Data
Post Retirement Benefit Increase	Contract COLA up to 2.75% until Purchasing Power Protection Allowance Floor on Purchasing Power applies, 2.75% thereafter

(1) Depending on age, service and type of employment

(2) Net of pension plan investment expenses, including inflation

\* Fiscal year 2015 was the 1st year of implementation.

**CITY OF LOS ALTOS**  
**Notes to Required Supplementary Information**  
**For the Year Ended June 30, 2021**

**SCHEDULE OF CHANGES IN THE NET OPEB LIABILITY AND RELATED RATIOS**  
Retiree Healthcare OPEB Plan - Agent Multiple Employer  
Last 10 fiscal years\*

Measurement Date	6/30/17	6/30/18	6/30/19	6/30/20
<b>Total OPEB Liability</b>				
Service Cost	\$154,000	\$158,000	\$162,743	\$195,973
Interest	207,000	223,000	238,629	231,856
Actual vs. expected experience			(524,133)	
Assumption changes			128,646	
Benefit payments	(134,000)	(142,000)	(161,000)	(117,894)
<b>Net change in total OPEB liability</b>	<u>227,000</u>	<u>239,000</u>	<u>(155,115)</u>	<u>309,935</u>
<b>Total OPEB liability - beginning</b>	<u>2,987,000</u>	<u>3,214,000</u>	<u>3,453,000</u>	<u>3,297,885</u>
<b>Total OPEB liability - ending (a)</b>	<u>\$3,214,000</u>	<u>\$3,453,000</u>	<u>\$3,297,885</u>	<u>\$3,607,820</u>
<b>Plan fiduciary net position</b>				
Contributions - employer	\$135,000	\$143,000	\$162,000	\$118,972
Net investment income	160,000	134,000	110,961	67,723
Administrative expense	(2,000)	(4,000)	(1,387)	(2,014)
Benefit payments	(134,000)	(142,000)	(161,000)	(117,894)
<b>Net change in plan fiduciary net position</b>	<u>159,000</u>	<u>131,000</u>	<u>110,574</u>	<u>66,787</u>
<b>Plan fiduciary net position - beginning</b>	<u>1,515,000</u>	<u>1,674,000</u>	<u>1,805,000</u>	<u>1,915,574</u>
<b>Plan fiduciary net position - ending (b)</b>	<u>\$1,674,000</u>	<u>\$1,805,000</u>	<u>\$1,915,574</u>	<u>\$1,982,361</u>
Net OPEB liability - ending (a)-(b)	<u>\$1,540,000</u>	<u>\$1,648,000</u>	<u>\$1,382,311</u>	<u>\$1,625,459</u>
Plan fiduciary net position as a percentage of the total OPEB liability	52.1%	52.3%	58.1%	54.9%
Covered-employee payroll	<u>\$12,546,000</u>	<u>\$14,000,000</u>	<u>\$15,000,000</u>	<u>\$15,000,000</u>
Net OPEB liability as a percentage of covered-employee payroll	<u>12.27%</u>	<u>11.77%</u>	<u>9.22%</u>	<u>10.84%</u>

\* Fiscal year 2018 was the first year of implementation.

**CITY OF LOS ALTOS**  
**Notes to Required Supplementary Information**  
**For the Year Ended June 30, 2021**

**SCHEDULE OF CONTRIBUTIONS**

Retiree Healthcare OPEB Plan - Agent Multiple Employer  
Last 10 fiscal years\*

Fiscal Year Ended June 30,	2018	2019	2020	2021
Actuarially determined contribution	\$304,000	\$313,000	\$333,000	\$343,000
Contributions in relation to the actuarially determined contribution	143,000	314,000	118,972	132,024
Contribution deficiency (excess)	\$161,000	(\$1,000)	\$214,028	\$210,976
Covered-employee payroll	\$14,000,000	\$15,000,000	\$15,000,000	\$15,366,121
Contributions as a percentage of covered-employee payroll	1.02%	2.10%	0.80%	0.90%

\* Fiscal year 2018 was the first year of implementation.

**NOTES TO SCHEDULE OF EMPLOYER CONTRIBUTION**  
**Retiree Healthcare OPEB Plan - Agent Multiple Employer**  
**Methods and Assumptions for Actuarially Determined Contribution**

Valuation Date	• 1/1/2019
Actuarial Cost Method	• Entry Age Normal, Level Percentage of Payroll
Amortization Method	• Level percent of pay
Amortization Period	• 12.9-year average fixed period for 2020/21
Asset Valuation Method	• Investment gains and losses spread over 5-year rolling period
Discount Rate	• 6.75%
General Inflation	• 2.75%
Medical Trend	• Non-Medicare - 7.5% for 2020, decreasing to an ultimate rate of 4.0% in 2076 • Medicare - 6.5% for 2020, decreasing to an ultimate rate of 4.0% in 2076
Mortality, Retirement, Disability, Termination	• CalPERS 1997-2015 Experience Study
Mortality Improvement	• Mortality Improvement Scale MP-18
PEMHCA Minimum Increases	• 4.25% annually
Healthcare participation	• 60%

CITY OF LOS ALTOS  
GENERAL FUND  
SCHEDULE OF REVENUES AND EXPENDITURES  
AND CHANGES IN FUND BALANCE  
BUDGET AND ACTUAL  
FOR THE YEAR ENDED JUNE 30, 2021

	<u>Budgeted Amounts</u>		<u>Actual Amounts</u>	<u>Variance with Final Budget Positive (Negative)</u>
	<u>Original</u>	<u>Final</u>		
<b>Revenues:</b>				
Property tax	\$25,639,810	\$27,287,029	\$28,464,193	\$1,177,164
Sales tax	3,301,400	2,641,120	2,996,325	355,205
Utility users	2,781,000	2,464,430	2,917,252	452,822
Other tax	4,600,950	1,792,137	2,306,393	514,256
Licenses, permits and fees	8,633,080	4,136,377	4,392,246	255,869
Grants and donations		499,876	3,986,394	3,486,518
Charges for services		2,629,700	2,958,245	328,545
Fines and forfeitures		178,050	131,467	(46,583)
Interest and rentals	386,900	405,045	184,032	(221,013)
Other		123,506	106,487	(17,019)
	<u>45,343,140</u>	<u>42,157,270</u>	<u>48,443,034</u>	<u>6,285,764</u>
<b>Expenditures:</b>				
<b>General government:</b>				
Public Safety	19,615,686	20,343,895	19,389,523	954,372
Public Works	2,964,442	5,775,779	5,616,637	159,142
Recreation	2,666,978	1,800,249	1,782,214	18,035
Community development	3,840,000	6,226,997	6,357,369	(130,372)
Admin/community services	6,547,399	7,350,916	7,702,229	(351,313)
	<u>35,634,505</u>	<u>41,497,836</u>	<u>40,847,972</u>	<u>649,864</u>
Excess of revenues over expenditures	<u>9,708,635</u>	<u>659,434</u>	<u>7,595,062</u>	<u>6,935,628</u>
<b>Other financing sources (uses):</b>				
Proceeds from Lease			100,000	100,000
Transfers in			146,176	146,176
Transfers out			(17,648,572)	(17,648,572)
			<u>(17,402,396)</u>	<u>(17,402,396)</u>
Net change in fund balance	<u>\$9,708,635</u>	<u>\$659,434</u>	<u>(9,807,334)</u>	<u>(\$10,466,768)</u>
Fund balance at beginning of year, as restated			<u>32,531,052</u>	
Fund balance at end of year			<u>\$22,723,718</u>	

CITY OF LOS ALTOS  
 IN-LIEU PARK LAND SPECIAL REVENUE FUND  
 SCHEDULE OF REVENUES, EXPENDITURES  
 AND CHANGES IN FUND BALANCE  
 BUDGET AND ACTUAL  
 FOR THE YEAR ENDED JUNE 30, 2021

	<u>Budgeted Amounts</u>		<u>Actual Amounts</u>	Variance with
	<u>Original</u>	<u>Final</u>		Final Budget Positive (Negative)
REVENUES:				
Interest and rentals			\$19,049	\$19,049
Intergovernmental	\$500,000	\$500,000	1,541,500	1,041,500
Total Revenues	<u>500,000</u>	<u>500,000</u>	<u>1,560,549</u>	<u>1,060,549</u>
Expenditures:				
Capital improvement	17,400		17,564	(17,564)
EXCESS OF REVENUES OVER EXPENDITURES	<u>482,600</u>	<u>500,000</u>	<u>1,542,985</u>	<u>1,078,113</u>
NET CHANGE IN FUND BALANCE	<u>\$482,600</u>	<u>\$500,000</u>	242,985	<u>(\$221,887)</u>
Beginning fund balance			<u>5,537,293</u>	
Ending fund balance			<u>\$5,780,278</u>	

**CITY OF LOS ALTOS**  
**Notes to Required Supplementary Information**  
**For the Year Ended June 30, 2021**

**1. Budget and Budgetary Accounting**

The City adopts a budget annually for General Fund, Special Revenue Funds, **(except for the Storm Drain Deposits Fund)**, and Equipment Replacement Capital Projects Fund that is effective July 1 for the ensuing fiscal year. From the effective date of the budget, which is adopted and controlled at the fund level, the amounts stated therein as proposed expenditures become appropriations to the various City departments. The City Council may amend the budget during the fiscal year. The City Manager is authorized to transfer budgeted amount between departments and line items within any fund to achieve a balanced budget; however, any revisions which alter the total expenditures of any fund must be approved by the City Council. Transfers between funds must be approved by the City Council. All appropriations lapse at year-end unless otherwise authorized by the City Council and the City Manager, except for capital improvement projects and open purchase order commitments for which appropriations endure until the project or obligation is completed.

Budgets are adopted on a basis consistent with generally accepted accounting principles except for capital projects funds, which are adopted on a project length basis, which means budgets are used until the project's completion for the entire project amount.



**OTHER SUPPLEMENTARY INFORMATION**



## **GENERAL FUND**

General Fund – Accounts for all financial resources necessary to carry out basic governmental activities of the City that are not accounted for in other funds. The General Fund supports essential City services such as police, fire, street and parks maintenance, maintenance services, community development and recreation activities. The General Fund also includes the Real Property Proceeds Funds, which accounts for the proceeds from the sale of real property and the Community Facilities Renewal Fund, which accounts for the revenues and expenditures related to the community facilities renewal efforts.

CITY OF LOS ALTOS  
GENERAL FUND  
COMBINING BALANCE SHEET  
JUNE 30, 2021

	General	Community Facilities Renewal Fund	Real Property Proceeds	Total General Fund
<b>ASSETS</b>				
Cash and investments	\$18,038,690		\$654,875	\$18,693,565
Receivables, net of allowance for uncollectibles:				
Accounts	6,224,645			6,224,645
Interest	63,817		24,235	88,052
Prepays	66,176			66,176
Notes receivable	1,704,880			1,704,880
Inventory	79,020			79,020
Due to other funds	850,985			850,985
	<u>\$27,028,213</u>	<u>                    </u>	<u>\$679,110</u>	<u>\$27,707,323</u>
<b>LIABILITIES</b>				
Accounts payable	\$3,765,318			\$3,765,318
Accrued liabilities	1,104,842			1,104,842
Other payable	112,768			112,768
	<u>4,982,928</u>	<u>                    </u>	<u>                    </u>	<u>4,982,928</u>
<b>DEFERRAL INFLOWS OF RESOURCES</b>				
Deferred inflows or revenues	677			677
	<u>677</u>	<u>                    </u>	<u>                    </u>	<u>677</u>
<b>FUND BALANCES</b>				
Fund balance:				
Nonspendable	1,858,691			1,858,691
Assigned	15,118,297		\$679,110	15,797,407
Unassigned	5,067,620			5,067,620
	<u>22,044,608</u>	<u>                    </u>	<u>679,110</u>	<u>22,723,718</u>
Total Fund Balances	<u>22,044,608</u>	<u>                    </u>	<u>679,110</u>	<u>22,723,718</u>
Total Liabilities and Fund Balances	<u>\$27,028,213</u>	<u>                    </u>	<u>\$679,110</u>	<u>\$27,707,323</u>

CITY OF LOS ALTOS  
GENERAL FUND  
COMBINING SCHEDULE OF REVENUES, EXPENDITURES AND CHANGES IN FUND BALANCES  
FOR THE YEAR ENDED JUNE 30, 2021

	General	Community Facilities Renewal	Real Property Proceeds	Intra-Fund Transaction Elimination	Total General Fund
<b>REVENUES</b>					
Property tax	\$28,464,193				\$28,464,193
Sales tax	2,996,325				2,996,325
Utility users	2,917,252				2,917,252
Other tax	2,306,393				2,306,393
Licenses, permits and fees	4,392,246				4,392,246
Grants and donations	3,986,394				3,986,394
Charges for services	2,958,245				2,958,245
Fines and forfeitures	131,467				131,467
Interest and rentals	159,899		\$24,133		184,032
Other	106,487				106,487
<b>Total Revenues</b>	<b>48,418,901</b>		<b>24,133</b>		<b>48,443,034</b>
<b>EXPENDITURES</b>					
General government					
Public safety	19,389,523				19,389,523
Public works	5,616,637				5,616,637
Recreation	1,782,214				1,782,214
Community development	6,357,369				6,357,369
Admin / community development	7,702,229				7,702,229
<b>Total Expenditures</b>	<b>40,847,972</b>				<b>40,847,972</b>
<b>EXCESS (DEFICIENCY) OF REVENUES OVER EXPENDITURES</b>	<b>7,570,929</b>		<b>24,133</b>		<b>7,595,062</b>
<b>OTHER FINANCING SOURCES (USES)</b>					
Proceeds from Lease	100,000				100,000
Transfers in	146,176				146,176
Transfers (out)	(7,648,572)		(10,000,000)		(17,648,572)
<b>Total Other Financing Sources (Uses)</b>	<b>(7,402,396)</b>		<b>(10,000,000)</b>		<b>(17,402,396)</b>
<b>NET CHANGE IN FUND BALANCES</b>	<b>168,533</b>		<b>(9,975,867)</b>		<b>(9,807,334)</b>
<b>BEGINNING FUND BALANCES, as Restated</b>	<b>21,876,075</b>		<b>10,654,977</b>		<b>32,531,052</b>
<b>ENDING FUND BALANCES</b>	<b>\$22,044,608</b>		<b>\$679,110</b>		<b>\$22,723,718</b>



*This Page Left Intentionally Blank*

<b>NON-MAJOR GOVERNMENTAL FUNDS</b>
-------------------------------------

**SPECIAL REVENUE FUNDS****VEHICLE IMPOUND FUND**

To account for revenues collected from arrest and towing fees that are dedicated for public safety purposes.

**SUPPLEMENTAL LAW ENFORCEMENT FUND**

To account for revenues from the Citizen's Option for Public Safety Program in support of additional front-line law enforcement services.

**GAS TAX FUNDS**

To account for the revenues received from the State gas taxes under the provision of the Streets and Highways Codes. These revenues are restricted to uses related to construction and improvements, an maintenance and repair of local streets.

**PROPOSITION 1B FUND**

To account for the allocated bond fund amount from the State under the Proposition 1B provisions.

**STORM DRAIN DEPOSITS FUND**

To account for fees collected from new subdivision development. All funds are restricted to construction and improvement of the storm drain system.

**COMMUNITY DEVELOPMENT BLOCK GRANT FUND**

To account for grant funds received from the federal government specifically for the housing rehabilitation loan programs, the human services programs through local nonprofit agencies, and the accessibility improvements in compliance with the American with Disabilities Act.

**DOWNTOWN PARKING FUND**

To account for revenues received from the lease of the public parking plazas and in-lieu program fees. The revenues are dedicated for the construction and improvement of downtown parking facilities.

**TRAFFIC IMPACT FEE FUND**

To account for revenues received from development. The revenues are dedicated for transportation improvements within the City.

**ESTATE DONATION FUND**

To account for donations received that are dedicated for purposes specified by the donors.

**TDA FUND**

To account for State Transportation Development Act, Article 3 funds for bike route and pedestrian facilities improvements.

<b>NON-MAJOR GOVERNMENTAL FUNDS (Continued)</b>
---

**SPECIAL REVENUE FUNDS (Continued)****PEG FUND**

To account for fees collected by local Cable Television franchise. All funds are restricted for public education and government access programming.

**VEHICLE REGISTRATION FEES FUND**

To account for fees collected by the Department of Motor Vehicles from registrations in Santa Clara County. All funds are restricted to street projects.

**SB 1 ROAD MAINTENANCE REHABILITATION FUND**

To account for revenues received from the State Streets and Highways Codes. These revenues are restricted to address deferred maintenance on the State Highway System and the local street and road system.

**TRAFFIC CONGESTION RELIEF PROGRAM FUND**

To account for revenues received from the State. These revenues must be used only for maintenance or reconstruction costs on public streets or roads.

**CAPITAL PROJECTS FUND****EQUIPMENT REPLACEMENT FUND**

To account for the revenues and expenditures related to the replacement of certain City equipment and vehicles.

**DEBT SERVICE FUND****GENERAL DEBT SERVICE**

To account for the accumulation of revenues for periodic payment of principal and interest on Certificates of Participation and related authorized costs.





*This Page Left Intentionally Blank*

CITY OF LOS ALTOS  
NON-MAJOR GOVERNMENTAL FUNDS  
COMBINING BALANCE SHEET  
JUNE 30, 2021

	SPECIAL REVENUE FUNDS			
	Vehicle Impound	Supplemental Law Enforcement	Gas Tax	Proposition 1B
<b>ASSETS</b>				
Cash and investments		\$146,007	\$2,016,248	\$44,441
Restricted cash and investments				
Receivables, net of allowance for uncollectibles:				
Accounts			4,220	101
Total Assets		\$146,007	\$2,020,468	\$44,542
<b>LIABILITIES</b>				
Accounts payable				
Due to other funds				
Total Liabilities				
<b>FUND BALANCES</b>				
Restricted:				
Debt service				
Special revenue programs and projects		\$146,007	\$2,020,468	\$44,542
Assigned				
Unassigned				
Total Fund Balances		146,007	2,020,468	44,542
Total Liabilities and Fund Balances		\$146,007	\$2,020,468	\$44,542

SPECIAL REVENUE FUNDS

Storm Drain Deposits	Community Development Block Grant	Downtown Parking	Traffic Impact Fee	Estate Donation	TDA
\$56,086		\$884,191	\$20,114	\$18,097	
		5,036	1,528	41	\$52,724
<u>\$56,086</u>		<u>\$889,227</u>	<u>\$21,642</u>	<u>\$18,138</u>	<u>\$52,724</u>
		\$53			
	\$531,566				\$52,724
	531,566	53			52,724
\$56,086		889,174	\$21,642	\$18,138	
	(531,566)				
56,086	(531,566)	889,174	21,642	18,138	
<u>\$56,086</u>		<u>\$889,227</u>	<u>\$21,642</u>	<u>\$18,138</u>	<u>\$52,724</u>

(Continued)

CITY OF LOS ALTOS  
NON-MAJOR GOVERNMENTAL FUNDS  
COMBINING BALANCE SHEET  
JUNE 30, 2021

	SPECIAL REVENUE FUNDS			
	PEG	Vehicle Registration Fees	SB1 Road Maintenance Rehabilitation	Traffic Congestion Relief Program
<b>ASSETS</b>				
Cash and investments	\$709,973	\$529,401	\$168,733	\$106,129
Restricted cash and investments				
Receivables, net of allowance for uncollectibles:				
Accounts	30,064		104,307	
Total Assets	\$740,037	\$529,401	\$273,040	\$106,129
<b>LIABILITIES</b>				
Accounts payable				
Due to other funds				
Total Liabilities				
<b>FUND BALANCES</b>				
Restricted:				
Debt service				
Special revenue programs and projects	\$740,037	\$529,401	\$273,040	\$106,129
Assigned				
Unassigned				
Total Fund Balances	740,037	529,401	273,040	106,129
Total Liabilities and Fund Balances	\$740,037	\$529,401	\$273,040	\$106,129

<u>SPECIAL REVENUE FUNDS</u>		<u>CAPITAL PROJECTS FUND</u>	<u>DEBT SERVICE FUNDS</u>		
<u>Measure B</u>	<u>Public Art</u>	<u>Equipment Replacement</u>	<u>General</u>	<u>Los Alto Community Center Lease</u>	<u>Total Non-major Governmental Funds</u>
	\$166,128	\$389,459	\$201,530 172,021		\$5,456,537 172,021
<u>\$1,148,430</u>					<u>1,346,451</u>
<u>\$1,148,430</u>	<u>\$166,128</u>	<u>\$389,459</u>	<u>\$373,551</u>		<u>\$6,975,009</u>
					\$53
<u>\$163,979</u>					<u>748,269</u>
<u>163,979</u>					<u>748,322</u>
			\$373,551		373,551
984,451	\$166,128	\$389,459			5,995,243
					389,459
					(531,566)
<u>984,451</u>	<u>166,128</u>	<u>389,459</u>	<u>373,551</u>		<u>6,226,687</u>
<u>\$1,148,430</u>	<u>\$166,128</u>	<u>\$389,459</u>	<u>\$373,551</u>		<u>\$6,975,009</u>

CITY OF LOS ALTOS  
NON-MAJOR GOVERNMENTAL FUNDS  
COMBINING STATEMENT OF REVENUES, EXPENDITURES  
AND CHANGES IN FUND BALANCES  
FOR THE YEAR ENDED JUNE 30, 2021

	SPECIAL REVENUE FUNDS			
	Vehicle Impound	Supplemental Law Enforcement	Gas Tax	Proposition 1B
REVENUES				
Charges for services				
Licenses, permits and fees				
Intergovernmental		\$156,726	\$678,775	
Fines and forfeitures	\$6,636			
Interest and rentals			2,621	\$114
Other				
Total Revenues	6,636	156,726	681,396	114
EXPENDITURES				
Current:				
Public safety	460			
Community development				
Capital improvements			280,592	
Debt service:				
Principal				
Interest and fiscal charges				
Total Expenditures	460		280,592	
EXCESS (DEFICIENCY) OF REVENUES OVER EXPENDITURES	6,176	156,726	400,804	114
OTHER FINANCING SOURCES (USES)				
Proceeds from Lease				
Transfers in				
Transfers (out)	(6,176)	(100,000)		
Total Other Financing Sources (Uses)	(6,176)	(100,000)		
NET CHANGE IN FUND BALANCES		56,726	400,804	114
BEGINNING FUND BALANCES, AS RESTATED		89,281	1,619,664	44,428
ENDING FUND BALANCES		\$146,007	\$2,020,468	\$44,542

SPECIAL REVENUE FUNDS

Storm Drain Deposits	Community Development Block Grant	Downtown Parking	Traffic Impact Fee	Estate Donation	TDA
		\$13,506	\$139,336		
	303,933	13,390 6,199	2,193	\$47 1,150	
	303,933	33,095	141,529	1,197	
		13,587			
		13,587			
	303,933	19,508	141,529	1,197	
	(835,499)	(40,000)	(651,391)		
	(835,499)	(40,000)	(651,391)		
	(531,566)	(20,492)	(509,862)	1,197	
\$56,086	-	909,666	531,504	16,941	
\$56,086	(\$531,566)	\$889,174	\$21,642	\$18,138	

(Continued)

CITY OF LOS ALTOS  
NON-MAJOR GOVERNMENTAL FUNDS  
COMBINING STATEMENT OF REVENUES, EXPENDITURES  
AND CHANGES IN FUND BALANCES  
FOR THE YEAR ENDED JUNE 30, 2021

	SPECIAL REVENUE FUNDS			
	PEG	Vehicle Registration Fees	SBI Road Maintenance Rehabilitation	Traffic Congestion Relief Program
REVENUES				
Charges for services	\$96,276			
Licenses, permits and fees				
Intergovernmental			\$572,396	
Fines and forfeitures				
Interest and rentals	2,872			
Other				
Total Revenues	<u>99,148</u>		<u>572,396</u>	
EXPENDITURES				
Current:				
Public safety				
Community development				
Capital improvements				
Debt service:				
Principal				
Interest and fiscal charges				
Total Expenditures				
EXCESS (DEFICIENCY) OF REVENUES OVER EXPENDITURES	<u>99,148</u>		<u>572,396</u>	
OTHER FINANCING SOURCES (USES)				
Proceeds from Lease				
Transfers in				
Transfers (out)	<u>(405,772)</u>		<u>(500,000)</u>	
Total Other Financing Sources (Uses)	<u>(405,772)</u>		<u>(500,000)</u>	
NET CHANGE IN FUND BALANCES	(306,624)		72,396	
BEGINNING FUND BALANCES, AS RESTATED	<u>1,046,661</u>	<u>529,401</u>	<u>200,644</u>	<u>106,129</u>
ENDING FUND BALANCES	<u><u>\$740,037</u></u>	<u><u>\$529,401</u></u>	<u><u>\$273,040</u></u>	<u><u>\$106,129</u></u>



SPECIAL REVENUE FUNDS		CAPITAL PROJECTS FUND	DEBT SERVICE FUNDS		
Measure B	Public Art	Equipment Replacement	General	Los Alto Community Center Lease	Total Non-major Governmental Funds
	\$166,128				\$262,404
\$1,148,430					152,842
					2,556,327
					6,636
			\$9,373		30,610
					311,282
<u>1,148,430</u>	<u>166,128</u>		<u>9,373</u>		<u>3,320,101</u>
					460
		\$74,025			87,612
		199,718			480,310
			125,000	\$503,137	628,137
			42,401	196,863	239,264
		<u>273,743</u>	<u>167,401</u>	<u>700,000</u>	<u>1,435,783</u>
<u>1,148,430</u>	<u>166,128</u>	<u>(273,743)</u>	<u>(158,028)</u>	<u>(700,000)</u>	<u>1,884,318</u>
				9,900,000	9,900,000
			167,400	700,000	867,400
<u>(163,979)</u>				<u>(9,900,000)</u>	<u>(12,602,817)</u>
<u>(163,979)</u>			<u>167,400</u>	<u>700,000</u>	<u>(1,835,417)</u>
984,451	166,128	(273,743)	9,372		48,901
		663,202	364,179		6,177,786
<u>\$984,451</u>	<u>\$166,128</u>	<u>\$389,459</u>	<u>\$373,551</u>		<u>\$6,226,687</u>

CITY OF LOS ALTOS  
VEHICLE IMPOUND FUND  
SCHEDULE OF REVENUES, EXPENDITURES  
AND CHANGES IN FUND BALANCE  
BUDGET AND ACTUAL  
FOR THE YEAR ENDED JUNE 30, 2021

	<u>Final Budget</u>	<u>Actual Amounts</u>	<u>Variance with Final Budget Positive (Negative)</u>
REVENUES:			
Fines and forfeitures	<u>\$20,000</u>	<u>\$6,636</u>	<u>(\$13,364)</u>
Total Revenues	<u>20,000</u>	<u>6,636</u>	<u>(13,364)</u>
EXPENDITURES			
Current:			
Public safety	<u></u>	<u>460</u>	<u>(460)</u>
Total Expenses	<u></u>	<u>460</u>	<u>(460)</u>
EXCESS OF REVENUES OVER EXPENDITURES	<u>20,000</u>	<u>6,176</u>	<u>(12,904)</u>
OTHER FINANCING SOURCES (USES)			
Transfers (out)	<u></u>	<u>(6,176)</u>	<u>(6,176)</u>
Total other financing sources (uses)	<u></u>	<u>(6,176)</u>	<u>(6,176)</u>
NET CHANGE IN FUND BALANCE	<u><u>\$20,000</u></u>		<u><u>(\$19,080)</u></u>
Beginning fund balance		<u></u>	
Ending fund balance		<u><u></u></u>	

CITY OF LOS ALTOS  
 SUPPLEMENTAL LAW ENFORCEMENT FUND  
 SCHEDULE OF REVENUES, EXPENDITURES  
 AND CHANGES IN FUND BALANCE  
 BUDGET AND ACTUAL  
 FOR THE YEAR ENDED JUNE 30, 2021

	Final Budget	Actual Amounts	Variance with Final Budget Positive (Negative)
REVENUES:			
Intergovernmental	\$100,000	\$156,726	\$56,726
Total Revenues	100,000	156,726	56,726
EXCESS OF REVENUES OVER EXPENDITURES	100,000	156,726	56,726
OTHER FINANCING SOURCES (USES)			
Transfers (out)		(100,000)	(\$100,000)
Total other financing sources (uses)		(100,000)	(100,000)
NET CHANGE IN FUND BALANCE	\$100,000	56,726	(\$43,274)
Beginning fund balance		89,281	
Ending fund balance		\$146,007	

CITY OF LOS ALTOS  
GAS TAX FUND  
SCHEDULE OF REVENUES, EXPENDITURES  
AND CHANGES IN FUND BALANCE  
BUDGET AND ACTUAL  
FOR THE YEAR ENDED JUNE 30, 2021

	Final Budget	Actual Amounts	Variance with Final Budget Positive (Negative)
REVENUES:			
Intergovernmental	\$680,000	\$678,775	(\$1,225)
Interest and rentals		2,621	2,621
Total Revenues	<u>680,000</u>	<u>681,396</u>	<u>1,396</u>
EXPENDITURES			
Capital improvements		280,592	(280,592)
Total Expenses		<u>280,592</u>	<u>(280,592)</u>
EXCESS OF REVENUES OVER EXPENDITURES	<u>680,000</u>	<u>400,804</u>	<u>(279,196)</u>
NET CHANGE IN FUND BALANCE	<u><u>\$680,000</u></u>	<u>400,804</u>	<u><u>(\$279,196)</u></u>
Beginning fund balance, as restated		<u>1,619,664</u>	
Ending fund balance		<u><u>\$2,020,468</u></u>	

CITY OF LOS ALTOS  
 PROPOSITION 1B FUND  
 SCHEDULE OF REVENUES, EXPENDITURES  
 AND CHANGES IN FUND BALANCE  
 BUDGET AND ACTUAL  
 FOR THE YEAR ENDED JUNE 30, 2021

	Final Budget	Actual Amounts	Variance with Final Budget Positive (Negative)
REVENUES:			
Interest and rentals		\$114	\$114
Total Revenues		114	114
EXCESS OF REVENUES OVER EXPENDITURES		114	114
NET CHANGE IN FUND BALANCE		114	\$114
Beginning fund balance		44,428	
Ending fund balance		\$44,542	

CITY OF LOS ALTOS  
COMMUNITY DEVELOPMENT BLOCK GRANT FUND  
SCHEDULE OF REVENUES, EXPENDITURES  
AND CHANGES IN FUND BALANCE  
BUDGET AND ACTUAL  
FOR THE YEAR ENDED JUNE 30, 2021

	Final Budget	Actual Amounts	Variance with Final Budget Positive (Negative)
REVENUES:			
Grants and donations		\$303,933	\$303,933
Total Revenues		303,933	303,933
EXCESS OF REVENUES OVER EXPENDITURES		303,933	303,933
OTHER FINANCING SOURCES (USES)			
Transfers (out)		(835,499)	(835,499)
Total other financing sources (uses)		(835,499)	(835,499)
NET CHANGE IN FUND BALANCE		(531,566)	(\$531,566)
Beginning fund balance, as restated			
Ending fund balance		(\$531,566)	

CITY OF LOS ALTOS  
DOWNTOWN PARKING FUND  
SCHEDULE OF REVENUES, EXPENDITURES  
AND CHANGES IN FUND BALANCE  
BUDGET AND ACTUAL  
FOR THE YEAR ENDED JUNE 30, 2021

	<u>Final Budget</u>	<u>Actual Amounts</u>	<u>Variance with Final Budget Positive (Negative)</u>
REVENUES:			
Licenses, permits and fees	\$40,000	\$13,506	(\$26,494)
Interest and rentals		13,390	13,390
Other		6,199	6,199
	<u>40,000</u>	<u>33,095</u>	<u>(6,905)</u>
Total Revenues			
EXPENDITURES			
Current:			
Community development		13,587	(13,587)
		<u>13,587</u>	<u>(13,587)</u>
Total Expenses			
EXCESS OF REVENUES OVER EXPENDITURES	<u>40,000</u>	<u>19,508</u>	<u>(20,492)</u>
OTHER FINANCING SOURCES (USES)			
Transfers (out)		(40,000)	(40,000)
		<u>(40,000)</u>	<u>(40,000)</u>
Total other financing sources (uses)			
NET CHANGE IN FUND BALANCE	<u>\$40,000</u>	<u>(20,492)</u>	<u>(\$60,492)</u>
Beginning fund balance		<u>909,666</u>	
Ending fund balance		<u>\$889,174</u>	

CITY OF LOS ALTOS  
TRAFFIC IMPACT FEE FUND  
SCHEDULE OF REVENUES, EXPENDITURES  
AND CHANGES IN FUND BALANCE  
BUDGET AND ACTUAL  
FOR THE YEAR ENDED JUNE 30, 2021

	Final Budget	Actual Amounts	Variance with Final Budget Positive (Negative)
REVENUES:			
Licenses, permits and fees	\$260,000	\$139,336	(\$120,664)
Interest and rentals		1,360	1,360
Total Revenues	<u>260,000</u>	<u>140,696</u>	<u>(119,304)</u>
EXPENDITURES			
Capital improvements		(833)	833
Total Expenses		<u>(833)</u>	<u>833</u>
EXCESS OF REVENUES OVER EXPENDITURES	<u>260,000</u>	<u>141,529</u>	<u>(118,471)</u>
OTHER FINANCING SOURCES (USES)			
Transfers (out)		(651,391)	(651,391)
Total other financing sources (uses)		<u>(651,391)</u>	<u>(651,391)</u>
NET CHANGE IN FUND BALANCE	<u><u>\$260,000</u></u>	<u>(509,862)</u>	<u><u>(\$769,862)</u></u>
Beginning fund balance		<u>531,504</u>	
Ending fund balance		<u><u>\$21,642</u></u>	



CITY OF LOS ALTOS  
 ESTATE DONATION FUND  
 SCHEDULE OF REVENUES, EXPENDITURES  
 AND CHANGES IN FUND BALANCE  
 BUDGET AND ACTUAL  
 FOR THE YEAR ENDED JUNE 30, 2021

	Final Budget	Actual Amounts	Variance with Final Budget Positive (Negative)
REVENUES:			
Interest		\$47	\$47
Total Revenues		1,197	1,197
EXCESS OF REVENUES OVER EXPENDITURES		1,197	1,197
NET CHANGE IN FUND BALANCE		1,197	\$1,197
Beginning fund balance		16,941	
Ending fund balance		\$18,138	

CITY OF LOS ALTOS  
TDA FUND  
SCHEDULE OF REVENUES, EXPENDITURES  
AND CHANGES IN FUND BALANCE  
BUDGET AND ACTUAL  
FOR THE YEAR ENDED JUNE 30, 2021

	Final Budget	Actual Amounts	Variance with Final Budget Positive (Negative)
REVENUES:			
Grants and donations			
Total expenditures			
EXCESS (DEFICIENCY) OF REVENUES OVER EXPENDITURES			
OTHER FINANCING SOURCES (USES)			
Transfers (out)			
Total other financing sources (uses)			
NET CHANGE IN FUND BALANCE			
Beginning fund balance, as restated			
Ending fund balance			

CITY OF LOS ALTOS  
 PEG FUND  
 SCHEDULE OF REVENUES, EXPENDITURES  
 AND CHANGES IN FUND BALANCE  
 BUDGET AND ACTUAL  
 FOR THE YEAR ENDED JUNE 30, 2021

	Final Budget	Actual Amounts	Variance with Final Budget Positive (Negative)
REVENUES:			
Interest income		\$2,872	\$2,872
Charges for services	\$100,000	96,276	(3,724)
Total revenues	100,000	99,148	(852)
EXCESS (DEFICIENCY) OF REVENUES OVER EXPENDITURES	(100,000)	99,148	(852)
OTHER FINANCING SOURCES (USES)			
Transfers (out)		(405,772)	(405,772)
Total other financing sources (uses)		(405,772)	(405,772)
NET CHANGE IN FUND BALANCE	(\$100,000)	(306,624)	(\$852)
Beginning fund balance		1,046,661	
Ending fund balance		\$740,037	

CITY OF LOS ALTOS  
VEHICLE REGISTRATION FEES FUND  
SCHEDULE OF REVENUES, EXPENDITURES  
AND CHANGES IN FUND BALANCE  
BUDGET AND ACTUAL  
FOR THE YEAR ENDED JUNE 30, 2021

	<u>Final Budget</u>	<u>Actual Amounts</u>	<u>Variance with Final Budget Positive (Negative)</u>
REVENUES:			
Grants and donations	<u>\$408,553</u>	<u>                    </u>	<u>(\$408,553)</u>
Total revenues	<u>408,553</u>	<u>                    </u>	<u>(408,553)</u>
EXCESS (DEFICIENCY) OF REVENUES OVER EXPENDITURES	<u>408,553</u>	<u>                    </u>	<u>(408,553)</u>
NET CHANGE IN FUND BALANCE	<u><u>\$408,553</u></u>	<u>                    </u>	<u><u>(\$408,553)</u></u>
Beginning fund balance, as restated		<u>\$529,401</u>	
Ending fund balance		<u><u>\$529,401</u></u>	

CITY OF LOS ALTOS  
 SB1 ROAD MAINTENANCE REHABILITATION FUND  
 SCHEDULE OF REVENUES, EXPENDITURES  
 AND CHANGES IN FUND BALANCE  
 BUDGET AND ACTUAL  
 FOR THE YEAR ENDED JUNE 30, 2021

	<u>Final Budget</u>	<u>Actual Amounts</u>	<u>Variance with Final Budget Positive (Negative)</u>
REVENUES:			
Intergovernmental		\$572,396	\$572,396
Total revenues		<u>572,396</u>	<u>572,396</u>
OTHER FINANCING SOURCES (USES)			
Transfers (out)		(500,000)	(500,000)
Total other financing sources (uses)		<u>(500,000)</u>	<u>(500,000)</u>
EXCESS (DEFICIENCY) OF REVENUES OVER EXPENDITURES		<u>72,396</u>	<u>72,396</u>
NET CHANGE IN FUND BALANCE		<u>72,396</u>	<u>\$72,396</u>
Beginning fund balance		<u>200,644</u>	
Ending fund balance		<u>\$273,040</u>	

CITY OF LOS ALTOS  
 TRAFFIC CONGESTION RELIEF PROGRAM FUND  
 SCHEDULE OF REVENUES, EXPENDITURES  
 AND CHANGES IN FUND BALANCE  
 BUDGET AND ACTUAL  
 FOR THE YEAR ENDED JUNE 30, 2021

	Final Budget	Actual Amounts	Variance with Final Budget Positive (Negative)
REVENUES:			
Intergovernmental			
Total revenues			
EXCESS (DEFICIENCY) OF REVENUES OVER EXPENDITURES			
NET CHANGE IN FUND BALANCE			
Beginning fund balance		\$106,129	
Ending fund balance		\$106,129	

CITY OF LOS ALTOS  
EQUIPMENT REPLACEMENT CAPITAL PROJECTS FUND  
SCHEDULE OF REVENUES, EXPENDITURES  
AND CHANGES IN FUND BALANCE  
BUDGET AND ACTUAL  
FOR THE YEAR ENDED JUNE 30, 2021

	<u>Final Budget</u>	<u>Actual Amounts</u>	<u>Variance with Final Budget Positive (Negative)</u>
EXPENDITURES			
Community development	\$210,000	\$74,025	\$135,975
Capital improvements	<u>207,000</u>	<u>199,718</u>	<u>7,282</u>
Total expenditures	<u>417,000</u>	<u>273,743</u>	<u>143,257</u>
EXCESS (DEFICIENCY) OF REVENUES OVER EXPENDITURES	<u>(417,000)</u>	<u>(273,743)</u>	<u>143,257</u>
NET CHANGE IN FUND BALANCE	<u><u>(\$417,000)</u></u>	<u>(273,743)</u>	<u><u>\$143,257</u></u>
Beginning fund balance		<u>663,202</u>	
Ending fund balance		<u><u>\$389,459</u></u>	



*This Page Left Intentionally Blank*



## **INTERNAL SERVICE FUNDS**

Internal Service Funds are used to account for the financing of goods and services provided by one City department or agency to other departments or agencies of the City, or to other government units on a cost-reimbursement basis (including depreciation).

### **DENTAL REIMBURSEMENT**

To account for costs of the City's self-insurance dental program. Funds are provided primarily from charges to departments.

### **UNEMPLOYMENT INSURANCE**

To account for the unemployment insurance premiums and claims made against the City. Funds are provided primarily from charges to departments.

### **WORKERS' COMPENSATION INSURANCE**

To account for the premium costs and self-insured claim losses made against the City for workers compensation. Funds are provided primarily from charges to departments.

### **LIABILITY INSURANCE**

To account for the premium costs and self-insured claim losses made against the City for property-related and general liability. Funds are provided primarily from charges to departments.

CITY OF LOS ALTOS  
INTERNAL SERVICE FUNDS  
COMBINING STATEMENT OF NET POSITION  
JUNE 30, 2021

	<u>Dental Reimbursement</u>	<u>Unemployment Insurance</u>	<u>Workers' Compensation Insurance</u>	<u>Liability Insurance</u>	<u>Total</u>
<b>ASSETS</b>					
Current Assets:					
Cash and investments		\$546,698	\$5,332,328	\$751,251	\$6,630,277
Accounts receivable			1,265	15,733	16,998
					<u>16,998</u>
Total Assets		<u>546,698</u>	<u>5,333,593</u>	<u>766,984</u>	<u>6,647,275</u>
<b>LIABILITIES</b>					
Current Liabilities:					
Accounts payable			4,285	24,120	28,405
Claims and judgements			771,281	301,021	1,072,302
Due to other funds	\$94,747				94,747
					<u>94,747</u>
Noncurrent Liabilities:					
Claims and judgements			2,989,719	158,979	3,148,698
					<u>3,148,698</u>
Total Liabilities	<u>94,747</u>		<u>3,765,285</u>	<u>484,120</u>	<u>4,344,152</u>
<b>NET POSITION</b>					
Unrestricted	<u>(94,747)</u>	<u>546,698</u>	<u>1,568,308</u>	<u>282,864</u>	<u>2,303,123</u>
Total Net Position	<u><u>(\$94,747)</u></u>	<u><u>\$546,698</u></u>	<u><u>\$1,568,308</u></u>	<u><u>\$282,864</u></u>	<u><u>\$2,303,123</u></u>

CITY OF LOS ALTOS  
INTERNAL SERVICE FUNDS  
COMBINING STATEMENT OF REVENUES, EXPENSES  
AND CHANGES IN FUND NET POSITION  
FOR THE YEAR ENDED JUNE 30, 2021

	Dental Reimbursement	Unemployment Insurance	Workers' Compensation Insurance	Liability Insurance	Total
<b>OPERATING REVENUES</b>					
Charges for services	\$264,121			\$8,907	\$273,028
Total Operating Revenues	264,121			8,907	273,028
<b>OPERATING EXPENSES</b>					
Outside services				52,830	52,830
Claims and insurance	308,786	\$7,594	\$857,037	745,232	1,918,649
Administration			161,126		161,126
Total Operating Expenses	308,786	7,594	1,018,163	798,062	2,132,605
Operating Income (Loss)	(44,665)	(7,594)	(1,018,163)	(789,155)	(1,859,577)
<b>OTHER FINANCING SOURCES (USES)</b>					
Transfers in					
Total Other Financing Sources (Uses)					
Change in Net Position	(44,665)	(7,594)	(1,018,163)	(789,155)	(1,859,577)
BEGINNING NET POSITION	(50,082)	554,292	2,586,471	1,072,019	4,162,700
ENDING NET POSITION	(\$94,747)	\$546,698	\$1,568,308	\$282,864	\$2,303,123

CITY OF LOS ALTOS  
INTERNAL SERVICE FUNDS  
COMBINING STATEMENT OF CASH FLOWS  
FOR THE YEAR ENDED JUNE 30, 2021

	Dental Reimbursement	Unemployment Insurance	Workers' Compensation Insurance	Liability Insurance	Total
<b>CASH FLOWS FROM OPERATING ACTIVITIES</b>					
Cash received from other funds	\$308,786		\$4,703	\$2,331	\$315,820
Cash payments to vendors	(308,786)	(\$7,594)	243,874	13,170	(59,336)
Insurance premiums, settlements, and rebates			(951,977)	(758,202)	(1,710,179)
Cash Flows from Operating Activities		(7,594)	(703,400)	(742,701)	(1,453,695)
Cash and investments at beginning of period		554,292	6,035,728	1,493,952	8,083,972
Cash and investments at end of period		\$546,698	\$5,332,328	\$751,251	\$6,630,277
<b>Reconciliation of operating income (loss) to net cash flows from operating activities:</b>					
Operating income (loss)	(\$44,665)	(\$7,594)	(\$1,018,163)	(\$789,155)	(\$1,859,577)
<b>Adjustments to reconcile operating income to net cash flows from operating activities:</b>					
<b>Change in assets and liabilities:</b>					
Accounts receivable			4,703	(6,576)	(1,873)
Accounts payable			(94,940)	(12,970)	(107,910)
Due to other funds	44,665				44,665
Claims and judgments payable			405,000	66,000	471,000
Cash Flows from Operating Activities		(7,594)	(703,400)	(742,701)	(1,453,695)

## **STATISTICAL SECTION**



*This Page Left Intentionally Blank*

## STATISTICAL SECTION

This part of the City's Annual Comprehensive Financial Report presents detailed information as a context for understanding what the information in the financial statements, note disclosures, and required supplementary information says about the City's overall financial health. In contrast to the financial section, the statistical section information is not subject to independent audit.

### ***Financial Trends***

These schedules contain trend information to help the reader understand how the City's financial performance and well-being have changed over time:

1. Net Position by Component
2. Changes in Net Position
3. Fund Balances of Governmental Funds
4. Changes in Fund Balances of Governmental Funds

### ***Revenue Capacity***

These schedules contain information to help the reader assess the City's most significant local revenue source, the property tax:

1. Tax Revenues by Source, Governmental Funds
2. Assessed Value of Taxable Property
3. Property Tax Dollar by Break Down
4. Property Tax Dollars by Recipient Group
5. Direct and Overlapping Tax Rates
6. Principal Property Taxpayers
7. Property Tax Levies and Collections

### ***Debt Capacity***

These schedules present information to help the reader assess the affordability of the City's current levels of outstanding debt and the City's ability to issue additional debt in the future:

1. Ratios of Outstanding Debt by Type
2. Schedule of Direct and Overlapping Bonded Debt
3. Legal Debt Margin

### ***Demographic and Economic Information***

These schedules offer demographic and economic indicators to help the reader understand the environment within which the City's financial activities take place:

1. Demographic Statistics
2. Principal Employers

### ***Operating Information***

These schedules contain service and infrastructure data to help the reader understand how the information in the City's financial report relates to the services the City provides and the activities it performs:

1. Full-Time Equivalent City Employees by Function/Program
2. Operating Indicators by Function/Program
3. Capital Asset Statistics by Function/Program
4. Trust and Agency Debt Administration

### ***Sources***

Unless otherwise noted, the information in these schedules is derived from the Annual Comprehensive Financial Reports for the relevant year.





**City of Los Altos  
Net Position by Component  
Last Ten Fiscal Years**

*(accrual basis of accounting; amounts expressed in thousands)*

	FISCAL YEAR									
	2011-12	2012-13 (a)	2013-14	2014-15	2015-16	2016-17	2017-18	2018-19	2019-20	2020-21
<b>Governmental activities</b>										
Net investment in capital assets	\$ 48,511	\$ 50,102	\$ 50,164	\$ 49,079	\$ 53,409	\$ 54,725	\$ 61,525	\$ 67,611	\$ 80,869	\$ 95,463
Restricted	3,926	7,406	17,629	17,815	14,447	11,498	10,620	11,381	15,365	24,021
Unrestricted	34,634	29,883	27,624	10,746	15,583	24,047	20,429	21,733	5,216	(11,750)
<b>Total governmental activities net position</b>	<b>\$ 87,071</b>	<b>\$ 87,391</b>	<b>\$ 95,417</b>	<b>\$ 77,640</b>	<b>\$ 83,439</b>	<b>\$ 90,270</b>	<b>\$ 92,574</b>	<b>\$ 100,725</b>	<b>\$ 101,450</b>	<b>\$ 107,734</b>
<b>Business-type activities</b>										
Net investment in capital assets	\$ 5,952	\$ 6,773	\$ 8,718	\$ 8,662	\$ 8,726	\$ 8,403	\$ 9,450	\$ 11,239	\$ 12,288	\$ 14,650
Unrestricted	7,539	7,843	8,087	8,472	11,259	11,907	12,644	13,135	15,500	15,510
<b>Total business-type activities net position</b>	<b>\$ 13,491</b>	<b>\$ 14,616</b>	<b>\$ 16,805</b>	<b>\$ 17,134</b>	<b>\$ 19,985</b>	<b>\$ 20,310</b>	<b>\$ 22,094</b>	<b>\$ 24,374</b>	<b>\$ 27,788</b>	<b>\$ 30,160</b>
<b>Primary government</b>										
Net investment in capital assets	\$ 54,463	\$ 56,875	\$ 58,882	\$ 57,741	\$ 62,135	\$ 63,128	\$ 70,975	\$ 78,850	\$ 93,157	\$ 110,113
Restricted	3,926	7,406	17,629	17,815	14,447	11,498	10,620	11,381	15,365	24,021
Unrestricted	42,173	37,726	35,711	19,218	26,842	35,954	33,073	34,868	20,716	3,760
<b>Total primary government net position</b>	<b>\$ 100,562</b>	<b>\$ 102,007</b>	<b>\$ 112,222</b>	<b>\$ 94,774</b>	<b>\$ 103,424</b>	<b>\$ 110,580</b>	<b>\$ 114,668</b>	<b>\$ 125,099</b>	<b>\$ 129,238</b>	<b>\$ 137,894</b>

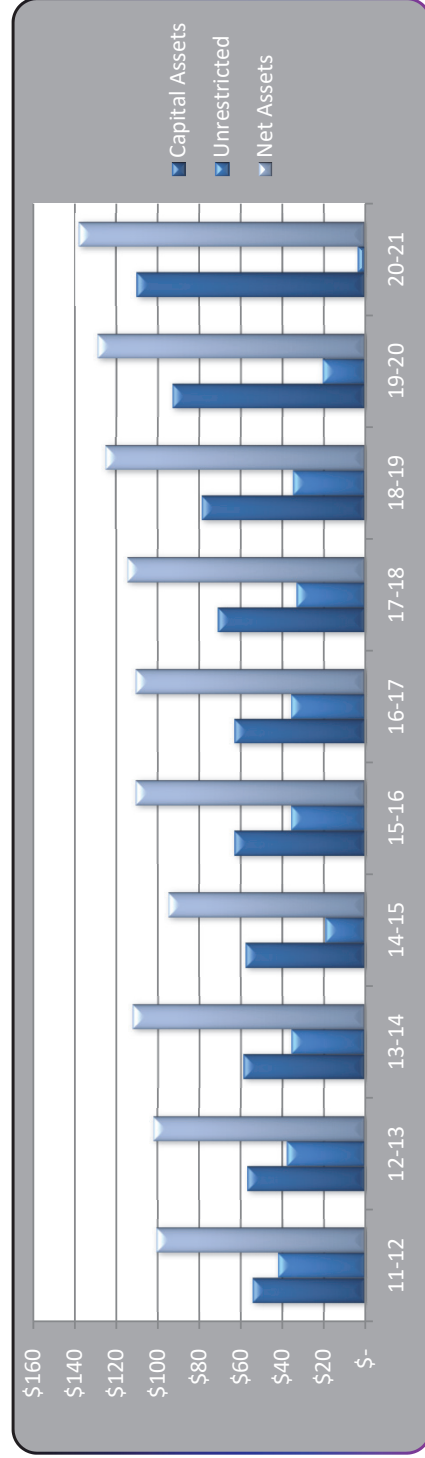

Source:  
City of Los Altos Finance Department

Note:

(a) The City implemented the provisions of GASB Statement 63 in fiscal year 2013, which replaced the term "Net Assets" with the term "Net Position"

City of Los Altos  
Changes in Net Position  
Last Ten Fiscal Years  
*(accrual basis of accounting; amounts expressed in thousands)*

	FISCAL YEAR										
	2010-11	2011-12	2012-13	2013-14	2014-15	2015-16	2016-17	2017-18	2018-19	2019-20	2020-21
<b>Expenses</b>											
Governmental activities:											
Public safety	\$ 14,101	\$ 14,797	\$ 15,144	\$ 14,884	\$ 15,636	\$ 15,791	\$ 15,224	\$ 19,928	\$ 18,945	\$ 21,217	\$ 21,384
Public works	5,451	5,157	5,557	6,453	7,058	5,816	7,832	6,217	6,534	7,659	4,741
Recreation	2,503	2,193	2,108	2,656	2,976	2,744	2,613	3,402	3,061	3,235	2,584
Community development	4,052	3,583	4,514	4,038	4,590	5,758	4,243	6,440	5,547	6,596	7,004
Admin/Community services	3,837	4,034	5,675	3,804	4,002	4,882	4,411	5,687	5,905	9,806	8,282
Interest on long-term activities	86	69	95	71	68	63	51	64	51	40	245
Total governmental activities expenses	30,030	29,833	33,093	31,906	34,330	35,054	34,374	41,738	40,043	48,553	44,240
Business-type activities:											
Sewer	4,520	4,386	4,529	4,574	4,789	4,607	6,754	4,970	5,273	5,527	5,268
Solid waste	717	341	355	366	347	376	438	461	465	426	394
Storm drain	200	213	232	165	215	-	1	1	-	-	-
Total Business-type activities expenses	5,437	4,940	5,116	5,105	5,351	4,983	7,193	5,432	5,738	5,953	5,662
<b>Total primary government expenses</b>	<b>\$ 35,467</b>	<b>\$ 34,773</b>	<b>\$ 38,209</b>	<b>\$ 37,011</b>	<b>\$ 39,681</b>	<b>\$ 40,037</b>	<b>\$ 41,567</b>	<b>\$ 47,170</b>	<b>\$ 45,781</b>	<b>\$ 54,506</b>	<b>\$ 49,902</b>
<b>Program Revenues</b>											
Governmental activities:											
Charges for services:											
Public safety	\$ 348	\$ 394	\$ 344	\$ 417	\$ 898	\$ 462	\$ 363	\$ 330	\$ 488	\$ 324	\$ 202
Public works	191	32	34	60	33	55	42	51	51	48	59
Recreation	1,763	1,808	1,865	1,952	2,167	2,123	2,070	2,021	1,963	847	271
Community development	2,650	3,260	7,431	5,196	3,625	3,412	3,112	4,589	4,027	3,498	5,793
Admin/Community services	1,061	875	947	942	954	1,033	1,082	950	753	1,200	954
Operating grants and contributions:											
Public safety	100	112	109	116	109	437	392	409	401	188	4,140
Public works	682	829	699	909	504	336	262	298	286	420	379
Recreation	-	-	-	-	-	2	5	5	5	-	-
Community development	168	21	59	36	343	8	148	170	-	-	306
Admin/Community services	64	36	58	6	-	-	-	-	-	-	-
Capital grants and contributions:											
Public safety	-	-	-	-	-	-	-	-	-	-	-
Public works	711	897	492	747	498	1,522	807	641	806	1,856	1,778
Recreation	-	-	-	-	-	-	-	-	-	-	-
Community development	-	3,400	80	3	30	7	-	62	-	-	31
Admin/Community services	78	76	-	83	-	-	-	-	-	-	-
Total governmental activities program revenues	7,816	11,740	12,118	10,467	9,161	9,397	8,283	9,526	8,780	8,381	13,913

City of Los Altos  
Changes in Net Position  
Last Ten Fiscal Years  
*(accrual basis of accounting; amounts expressed in thousands)*

	FISCAL YEAR										
	2010-11	2011-12	2012-13	2013-14	2014-15	2015-16	2016-17	2017-18	2018-19	2019-20	2020-21
<b>Business-type activities:</b>											
Charges for services:											
Sewer	\$ 4,813	\$ 4,503	\$ 5,121	\$ 6,347	\$ 6,328	\$ 6,986	\$ 6,703	\$ 6,369	\$ 6,467	\$ 7,942	\$ 7,126
Solid waste	992	821	879	754	786	752	774	812	841	847	861
Storm drain	-	-	-	12	2	-	-	-	-	-	-
Total business-type activities program revenues	5,805	5,324	6,000	7,113	7,116	7,738	7,477	7,181	7,308	8,789	7,987
<b>Total primary government program revenues</b>	<b>\$ 13,621</b>	<b>\$ 17,064</b>	<b>\$ 18,118</b>	<b>\$ 17,580</b>	<b>\$ 16,277</b>	<b>\$ 17,135</b>	<b>\$ 15,760</b>	<b>\$ 16,707</b>	<b>\$ 16,088</b>	<b>\$ 17,170</b>	<b>\$ 21,900</b>
Net (expense)/revenue:											
Governmental activities	\$ (22,214)	\$ (18,093)	\$ (20,975)	\$ (21,439)	\$ (25,170)	\$ (25,657)	\$ (26,091)	\$ (32,212)	\$ (31,263)	\$ (40,172)	\$ (30,327)
Business-type activities	368	384	884	2,008	1,766	2,755	284	1,749	1,570	2,836	2,325
<b>Total primary government net (expense)/revenue</b>	<b>\$ (21,846)</b>	<b>\$ (17,709)</b>	<b>\$ (20,091)</b>	<b>\$ (19,431)</b>	<b>\$ (23,404)</b>	<b>\$ (22,902)</b>	<b>\$ (25,807)</b>	<b>\$ (30,463)</b>	<b>\$ (29,693)</b>	<b>\$ (37,336)</b>	<b>\$ (28,002)</b>
<b>General Revenues and Other Changes in Net Position</b>											
Governmental activities:											
Taxes:											
Property taxes	\$ 12,794	\$ 13,302	\$ 14,130	\$ 15,586	\$ 17,480	\$ 18,776	\$ 19,863	\$ 21,429	\$ 23,792	\$ 25,787	\$ 28,464
Sales taxes	2,588	2,746	2,926	2,809	2,943	3,196	3,278	3,244	3,461	3,373	2,996
Utility users taxes	2,543	2,548	2,600	2,600	2,523	2,672	2,680	2,732	2,744	2,839	2,917
Other taxes	2,910	2,868	3,301	3,542	3,732	3,909	4,330	4,535	4,514	3,598	2,304
Franchise fees	1,814	1,731	1,770	1,905	1,808	2,029	2,083	2,207	2,222	2,287	2,215
Sale of Capital Assets-net	-	(545)	(8)	2,846	-	-	-	-	-	-	-
Interest income	275	115	174	99	200	438	233	320	2,226	2,595	173
Miscellaneous	388	131	382	212	1,124	435	454	452	456	418	428
Transfers	(65)	(247)	(232)	(152)	(196)	-	-	-	-	-	-
<b>Total governmental activities</b>	<b>\$ 23,247</b>	<b>\$ 22,649</b>	<b>\$ 25,043</b>	<b>\$ 29,447</b>	<b>\$ 29,614</b>	<b>\$ 31,455</b>	<b>\$ 32,921</b>	<b>\$ 34,919</b>	<b>\$ 39,415</b>	<b>\$ 40,897</b>	<b>\$ 39,497</b>
Business-type activities:											
Interest income	71	37	10	-	-	-	-	-	-	579	47
Miscellaneous	-	-	-	28	40	96	40	70	477	-	-
Transfers	65	247	232	152	196	-	-	-	-	-	-
Total business-type activities	136	284	242	180	236	96	40	70	477	579	47
<b>Total primary government</b>	<b>\$ 23,383</b>	<b>\$ 22,933</b>	<b>\$ 25,285</b>	<b>\$ 29,627</b>	<b>\$ 29,850</b>	<b>\$ 31,551</b>	<b>\$ 32,961</b>	<b>\$ 34,989</b>	<b>\$ 39,892</b>	<b>\$ 41,476</b>	<b>\$ 39,544</b>
<b>Change in Net Position</b>											
Governmental activities	\$ 1,033	\$ 4,556	\$ 4,068	\$ 8,008	\$ 4,444	\$ 5,798	\$ 6,830	\$ 2,707	\$ 8,152	\$ 725	\$ 9,170
Business-type activities	504	668	1,126	2,188	2,002	2,851	324	1,819	2,047	3,415	2,372
<b>Total primary government</b>	<b>\$ 1,537</b>	<b>\$ 5,224</b>	<b>\$ 5,194</b>	<b>\$ 10,196</b>	<b>\$ 6,446</b>	<b>\$ 8,649</b>	<b>\$ 7,154</b>	<b>\$ 4,526</b>	<b>\$ 10,199</b>	<b>\$ 4,140</b>	<b>\$ 11,542</b>

Source:  
City of Los Altos Finance Department

City of Los Altos  
Fund Balances - Governmental Funds  
Last Ten Fiscal Years

(modified accrual basis of accounting; amounts expressed in thousands)  
(Pre GASB 54 Presentation - For Years Before 2011-12)

	FISCAL YEAR									
	2011-12	2012-13	2013-14	2014-15	2015-16	2016-17	2017-18	2018-19	2019-20	2020-21
<b>General fund</b>										
Non-Spendable	\$ 46	\$ 49	\$ 35	\$ 445	\$ 524	\$ 38	\$ 1,932	\$ 1,882	\$ 1,836	\$ 1,859
Restricted	-	-	-	-	-	-	-	-	-	-
Committed	1,025	-	-	-	-	-	-	-	-	-
Assigned	4,700	6,025	27,161	29,565	29,064	37,630	38,040	39,020	25,773	15,937
Unassigned/Unrestricted	1,714	2,428	1,433	4,789	8,535	6,148	5,422	6,841	7,861	4,928
<b>Total general fund</b>	<b>\$ 7,485</b>	<b>\$ 8,502</b>	<b>\$ 28,629</b>	<b>\$ 34,799</b>	<b>\$ 38,123</b>	<b>\$ 43,816</b>	<b>\$ 45,394</b>	<b>\$ 47,743</b>	<b>\$ 35,470</b>	<b>\$ 22,724</b>
<b>All other governmental funds</b>										
Non-Spendable	\$ -	\$ -	\$ -	\$ -	\$ -	\$ -	\$ -	\$ -	\$ -	\$ -
Restricted	7,406	7,406	10,008	10,614	9,969	9,645	10,107	9,939	10,890	12,149
Committed	4,611	3,630	-	-	-	-	-	-	-	-
Assigned	19,514	19,460	7,621	7,201	4,477	1,993	1,335	1,495	4,529	11,872
Unreserved/Unrestricted	-	-	-	-	-	(140)	(823)	(53)	(53)	(532)
<b>Total all other governmental funds</b>	<b>\$ 31,531</b>	<b>\$ 30,496</b>	<b>\$ 17,629</b>	<b>\$ 17,815</b>	<b>\$ 14,446</b>	<b>\$ 11,498</b>	<b>\$ 10,619</b>	<b>\$ 11,381</b>	<b>\$ 15,366</b>	<b>\$ 23,489</b>
<b>Total all governmental funds</b>	<b>\$ 39,016</b>	<b>\$ 38,998</b>	<b>\$ 46,258</b>	<b>\$ 52,614</b>	<b>\$ 52,569</b>	<b>\$ 55,314</b>	<b>\$ 56,013</b>	<b>\$ 59,124</b>	<b>\$ 50,836</b>	<b>\$ 46,213</b>

Source:  
City of Los Altos Finance Department

City of Los Altos  
Fund Balances - Governmental Funds  
Last Ten Fiscal Years  
(modified accrual basis of accounting; amounts expressed in thousands)  
(GASB 54 Presentation - 2020-21)

	General Fund	In Lieu Park Land	Capital Projects	Other Govt Funds	Total
Inventory & Prepaids	\$ (145,196)	-	\$ -	-	\$ (145,196)
Notes Receivable	(1,704,880)	-	-	-	(1,704,880)
Veteran Memorial	(8,615)	-	-	-	(8,615)
<b>Non-Spendable</b>	<b>(1,858,691)</b>	-	-	-	<b>(1,858,691)</b>
Debt Service				(373,551)	(373,551)
Special Revenue Programs and Projects		(5,780,278)	-	(5,995,243)	(11,775,521)
<b>Restricted</b>	-	<b>(5,780,278)</b>	-	<b>(6,368,794)</b>	<b>(12,149,072)</b>
Continuing CIPS	-	-	-	-	-
<b>Committed</b>	-	-	-	-	-
General Fund Reserve	(7,649,169)	-	-	-	(7,649,169)
OPEB	(1,500,000)	-	-	-	(1,500,000)
PERS Reserve	(5,000,000)	-	-	-	(5,000,000)
Technology	(1,108,582)	-	-	-	(1,108,582)
Capital and Equipment	-	-	-	(389,459)	(389,459)
CIP Reserve	-	-	(11,482,682)	-	(11,482,682)
Capital Project Reserve - Community Center	(679,110)	-	-	-	(679,110)
<b>Assigned</b>	<b>(15,936,861)</b>	-	<b>(11,482,682)</b>	<b>(389,459)</b>	<b>(27,809,002)</b>
APRA Reserve	(3,598,964)	-	-	-	(3,598,964)
Unrealized Gain/(Loss)	(118,905)	-	-	-	(118,905)
<b>Unassigned</b>	<b>(1,210,297)</b>	-	-	-	<b>(1,210,297)</b>
<b>Total Unassigned Fund Balance</b>	<b>(4,928,166)</b>	-	-	<b>531,566</b>	<b>(4,396,600)</b>
<b>Total Fund Equity</b>	<b>\$ (22,723,718)</b>	<b>\$ (5,780,278)</b>	<b>\$ (11,482,682)</b>	<b>\$ (6,226,687)</b>	<b>\$ (46,213,365)</b>

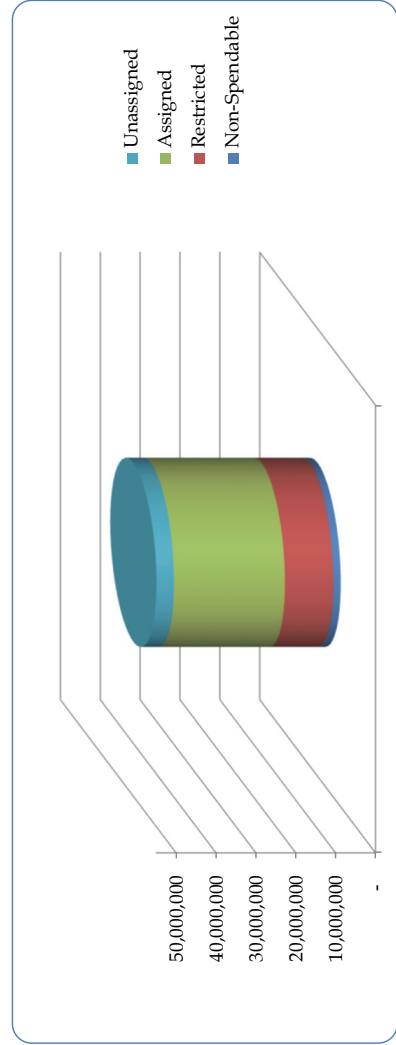

Source:  
City of Los Altos Finance Department

City of Los Altos  
Changes in Fund Balances - Governmental Funds  
Last Ten Fiscal Years  
(modified accrual basis of accounting, amounts expressed in thousands)

	Fiscal Year										
	2010-11	2011-12	2012-13	2013-14	2014-15	2015-16	2016-17	2017-18	2018-19	2019-20	2020-21
<b>Revenues</b>											
Taxes	\$ 17,714	\$ 18,250	\$ 19,444	\$ 21,950	\$ 26,690	\$ 28,565	\$ 30,151	\$ 31,939	\$ 34,511	\$ 35,597	\$ 36,684
License, permits and park-in-lieu	3,187	3,204	3,312	4,531	3,925	3,784	3,786	4,195	4,207	4,209	4,545
Intergovernmental	3,988	4,333	4,513	4,861	1,027	973	742	2,087	1,557	1,358	4,155
Grants and donations	929	4,242	650	788	873	1,863	1,214	928	396	1,368	4,017
Charges for services	4,020	3,780	4,480	4,572	4,698	4,659	4,577	4,620	4,850	3,751	3,221
Fines and forfeitures	148	231	171	214	161	264	213	178	191	195	138
Interest and rentals	333	169	135	159	291	558	230	360	2,269	2,681	233
Other	521	973	4,616	2,989	1,306	187	291	137	214	119	418
<b>Total revenues</b>	<b>30,840</b>	<b>35,182</b>	<b>37,320</b>	<b>40,064</b>	<b>38,971</b>	<b>40,853</b>	<b>41,204</b>	<b>44,444</b>	<b>48,195</b>	<b>49,278</b>	<b>53,411</b>
<b>Expenditures</b>											
General government											
Public Safety											
Police	8,616	9,588	9,178	8,891	9,167	9,976	9,968	10,744	11,107	11,465	11,673
Fire Services	5,259	5,375	5,513	5,714	5,961	6,219	6,473	6,722	7,011	7,331	7,717
Public works	4,793	4,826	4,831	4,353	4,307	4,859	5,299	5,784	5,535	5,469	5,617
Recreation	2,062	2,429	2,102	2,186	2,389	2,423	2,343	2,509	2,469	2,313	1,782
Community development	3,973	3,726	4,553	3,885	4,221	6,087	4,653	5,747	5,361	5,896	6,445
Administration/Community services	3,845	3,624	3,655	3,552	3,770	4,852	4,567	4,773	5,673	8,515	7,702
Capital improvements	4,475	3,212	2,916	3,492	2,435	6,313	4,992	7,299	7,756	15,428	23,343
Debt service											
Principal	85	90	95	95	100	105	105	110	120	120	628
Interest and fiscal charges	80	77	75	72	69	64	60	56	52	47	239
<b>Total expenditures</b>	<b>33,188</b>	<b>32,947</b>	<b>32,918</b>	<b>32,240</b>	<b>32,419</b>	<b>40,898</b>	<b>38,460</b>	<b>43,744</b>	<b>45,084</b>	<b>56,584</b>	<b>65,146</b>
<b>Excess (deficiency) of revenues over (under) expenditures</b>	<b>(2,348)</b>	<b>2,235</b>	<b>4,402</b>	<b>7,824</b>	<b>6,552</b>	<b>(45)</b>	<b>2,744</b>	<b>700</b>	<b>3,111</b>	<b>(7,306)</b>	<b>(11,735)</b>
<b>Other financing sources (uses)</b>											
Debt issuance	-	-	-	-	-	-	-	-	-	-	10,000
Payment to refunded bonded escrow agent	-	-	-	-	-	-	-	-	-	-	-
Transfers in	3,509	1,887	2,443	2,119	3,632	1,752	760	5,714	8,243	17,747	31,551
Transfers out	(3,574)	(2,134)	(2,925)	(2,685)	(3,828)	(1,752)	(760)	(5,714)	(8,243)	(18,729)	(31,551)
<b>Total Other financing sources (uses)</b>	<b>(65)</b>	<b>(247)</b>	<b>(482)</b>	<b>(566)</b>	<b>(196)</b>	<b>-</b>	<b>-</b>	<b>-</b>	<b>-</b>	<b>(982)</b>	<b>10,000</b>

City of Los Altos  
 Changes in Fund Balances - Governmental Funds  
 Last Ten Fiscal Years  
 (modified accrual basis of accounting, amounts expressed in thousands)

	Fiscal Year										
	2010-11	2011-12	2012-13	2013-14	2014-15	2015-16	2016-17	2017-18	2018-19	2019-20	2020-21
<b>Special items</b>											
CalPERS Side Fund Pay Down	-	(850)	(950)	-	-	-	-	-	-	-	-
Sale of capital assets-net	300	100	492	-	-	-	-	-	-	-	-
<b>Total special items</b>	300	(750)	(458)	-	-	-	-	-	-	-	-
<b>Net change in fund balances</b>	\$ (2,113)	\$ 1,238	\$ 3,463	\$ 7,258	\$ 6,356	\$ (45)	\$ 2,744	\$ 700	\$ 3,111	\$ (8,288)	\$ (1,735)
<b>Debt service as a percentage of non-capital expenditures</b>	0.6%	0.6%	0.6%	0.6%	0.6%	0.5%	0.5%	0.5%	0.5%	0.4%	2.1%

Source:  
 City of Los Altos Finance Department

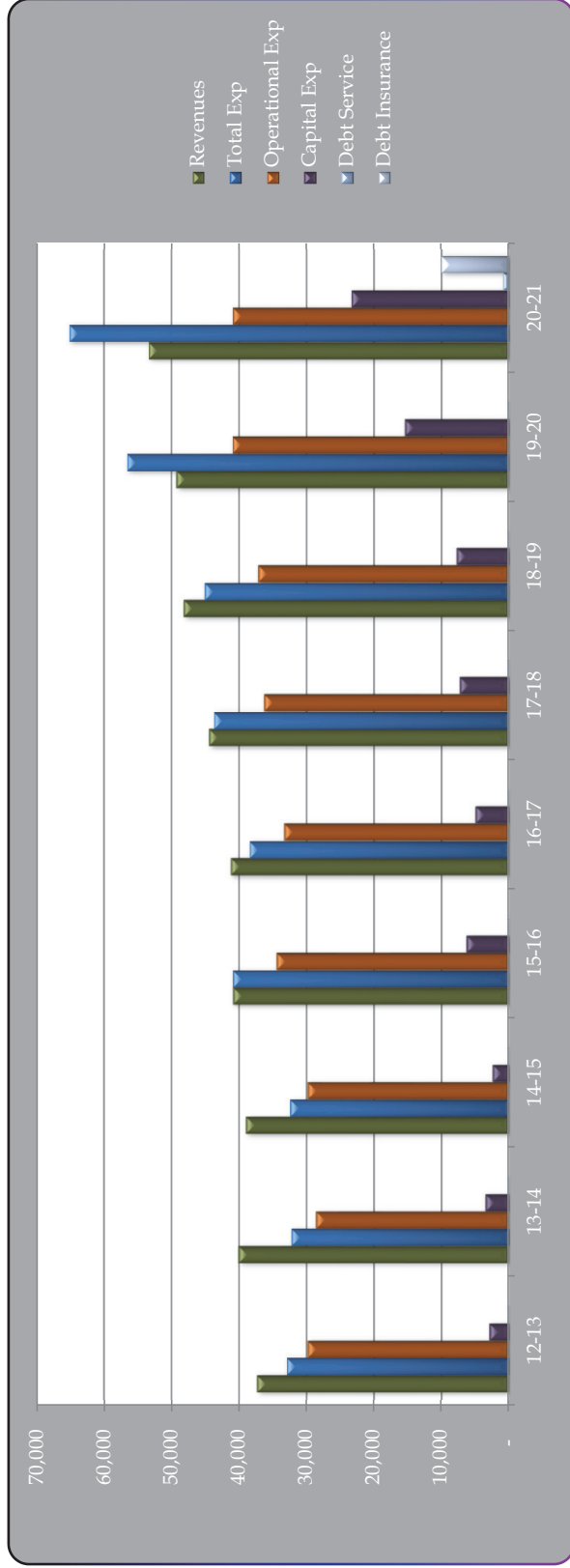

City of Los Altos  
 Tax Revenues by Source - Governmental Funds  
 Last Ten Fiscal Years

Fiscal Year	Property	Sales Tax	Business Licenses	Utility Users	Transient Occupancy	Real Estate Transfer Tax	Motor Vehicle License Tax	Building Development	Special Assessments	Total
2011-12	13,301,950	2,746,374	442,824	2,547,777	1,782,018	468,006	-	175,499	-	21,464,448
2012-13	14,130,040	2,926,441	519,828	2,600,054	1,946,484	587,422	15,102	247,992	-	22,973,363
2013-14	15,586,329	2,809,489	475,298	2,600,034	2,168,556	583,581	12,639	314,271	-	24,550,197
2014-15	17,479,882	2,942,764	453,201	2,522,536	2,450,488	616,500	12,281	212,187	-	26,689,839
2015-16	18,775,472	3,195,628	520,687	2,672,236	2,608,368	617,355	12,119	162,981	-	28,564,846
2016-17	19,863,197	3,278,430	539,989	2,679,961	2,985,201	668,242	14,046	122,071	-	30,151,137
2017-18	21,428,501	3,243,554	547,065	2,732,325	3,072,982	732,409	16,530	165,900	-	31,939,265
2018-19	23,791,531	3,461,298	540,262	2,743,570	3,166,067	679,424	15,054	113,589	-	34,510,795
2019-20	25,786,599	3,373,391	517,818	2,838,664	2,359,762	579,948	24,686	115,994	-	35,596,861
2020-21	28,464,193	2,996,325	537,089	2,917,252	662,132	931,856	22,646	150,170	-	36,681,663

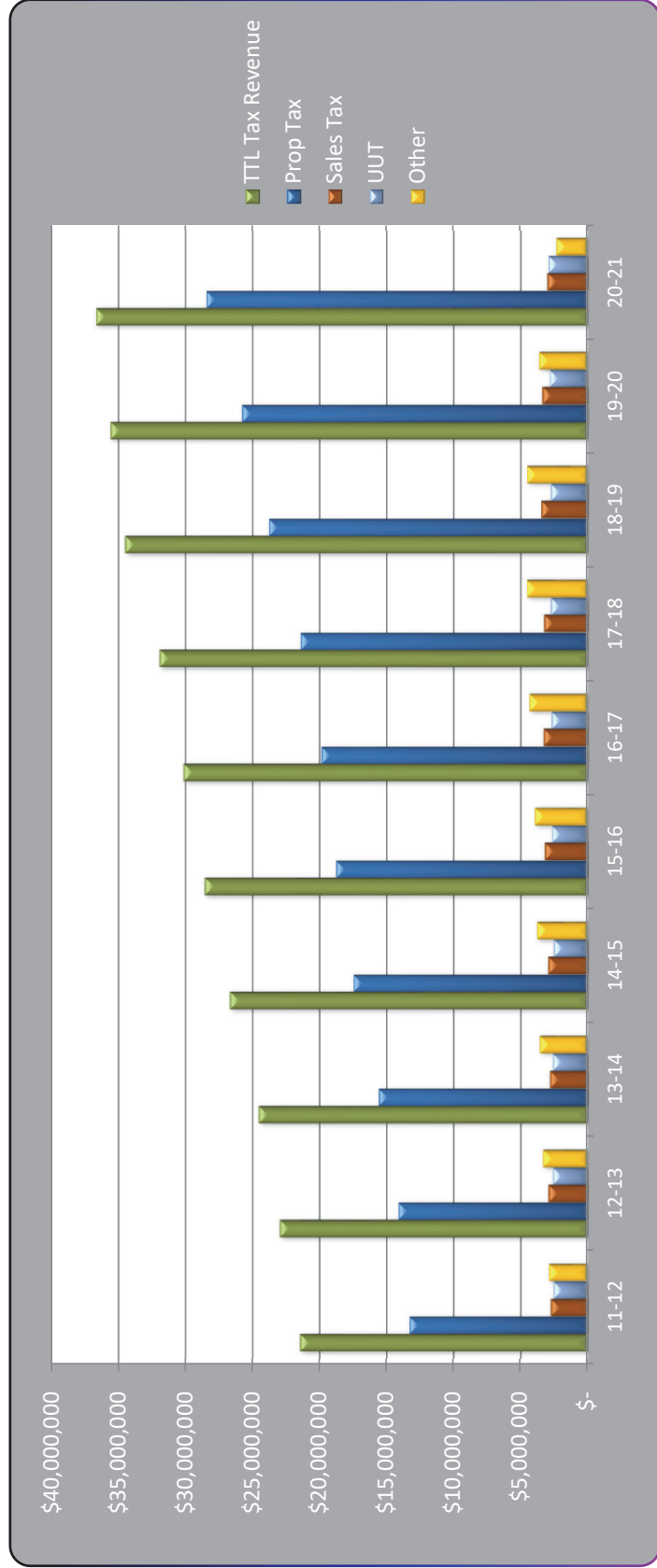

Source:  
 City of Los Altos Finance Department



**City of Los Altos**  
**Assessed Value of Taxable Property**  
**Last Ten Fiscal Years**

Fiscal Year	City of Los Altos					Total	
	Residential Property	Commercial Property	Other	Net Unsecured	Total Taxable Assessed Value (1)	Direct Tax Rate (2)	% Change
2011-12	8,952,576,593	622,766,264	33,390,275	89,645,375	9,698,378,507	1%	3.59%
2012-13	9,431,853,173	642,590,939	45,608,509	82,124,561	10,202,177,182	1%	5.19%
2013-14	10,318,249,580	676,252,209	67,682,916	97,506,301	11,159,691,006	1%	9.39%
2014-15	11,017,386,476	685,084,415	83,121,563	109,149,891	11,894,742,345	1%	6.59%
2015-16	11,848,840,720	750,708,212	106,506,870	125,355,972	12,831,411,774	1%	7.87%
2016-17	12,754,487,484	771,705,270	106,158,405	80,739,845	13,713,091,004	1%	6.87%
2017-18	13,600,334,963	880,225,920	90,338,436	83,250,683	14,654,150,002	1%	6.86%
2018-19	14,551,466,831	936,831,320	119,120,564	112,813,483	15,720,232,198	1%	7.27%
2019-20	15,563,770,279	1,003,212,732	110,061,604	131,971,942	16,809,016,557	1%	6.93%
<b>2020-21</b>	<b>16,685,985,691</b>	<b>1,045,789,993</b>	<b>116,124,083</b>	<b>127,343,780</b>	<b>17,975,243,547</b>	<b>1%</b>	<b>6.94%</b>

Source:

HdL Coren & Cone

(1) The California State Constitution requires property to be assessed at one hundred percent of the most recent purchase price, plus an increment of no more than two percent annually, plus any property improvements of substantial value to the property. These values are considered to be full market values for the City of Los Altos.

(2) California cities do not set their own direct tax rate. The California State Constitution establishes the rate at 1% and the County of Santa Clara is responsible for allocating a portion of that amount to all the taxing entities within each of the City's tax rate areas. The City has 15 tax rate areas and receives of approximately 12% of that 1% rate.

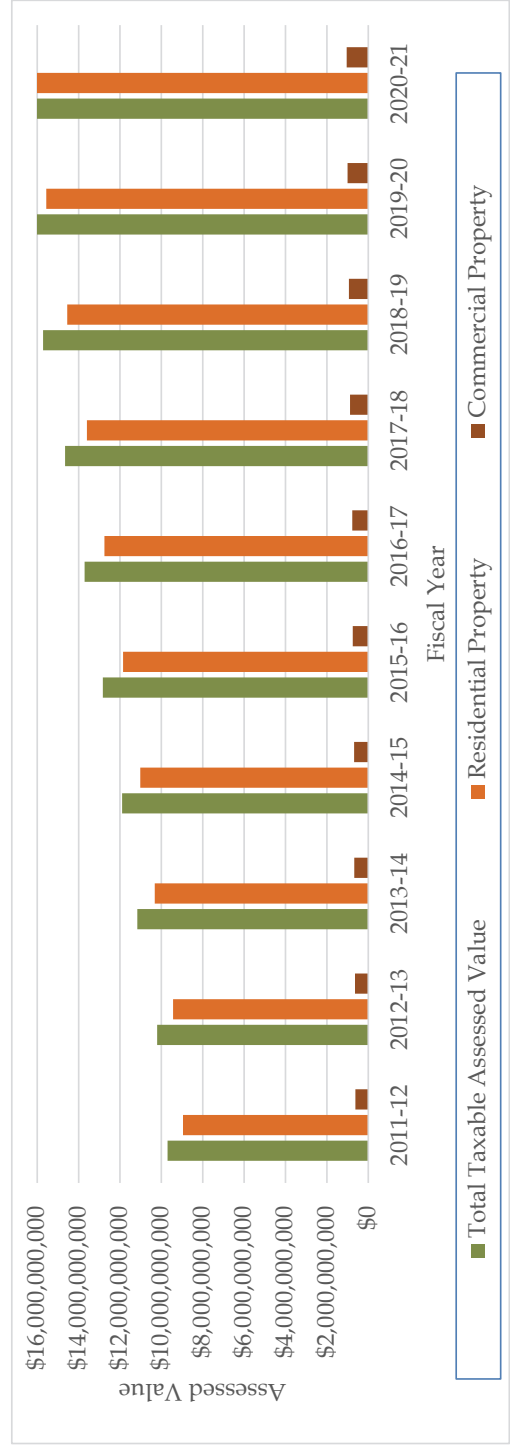

**City of Los Altos  
Property Tax Dollar Breakdown  
June 30, 2021**

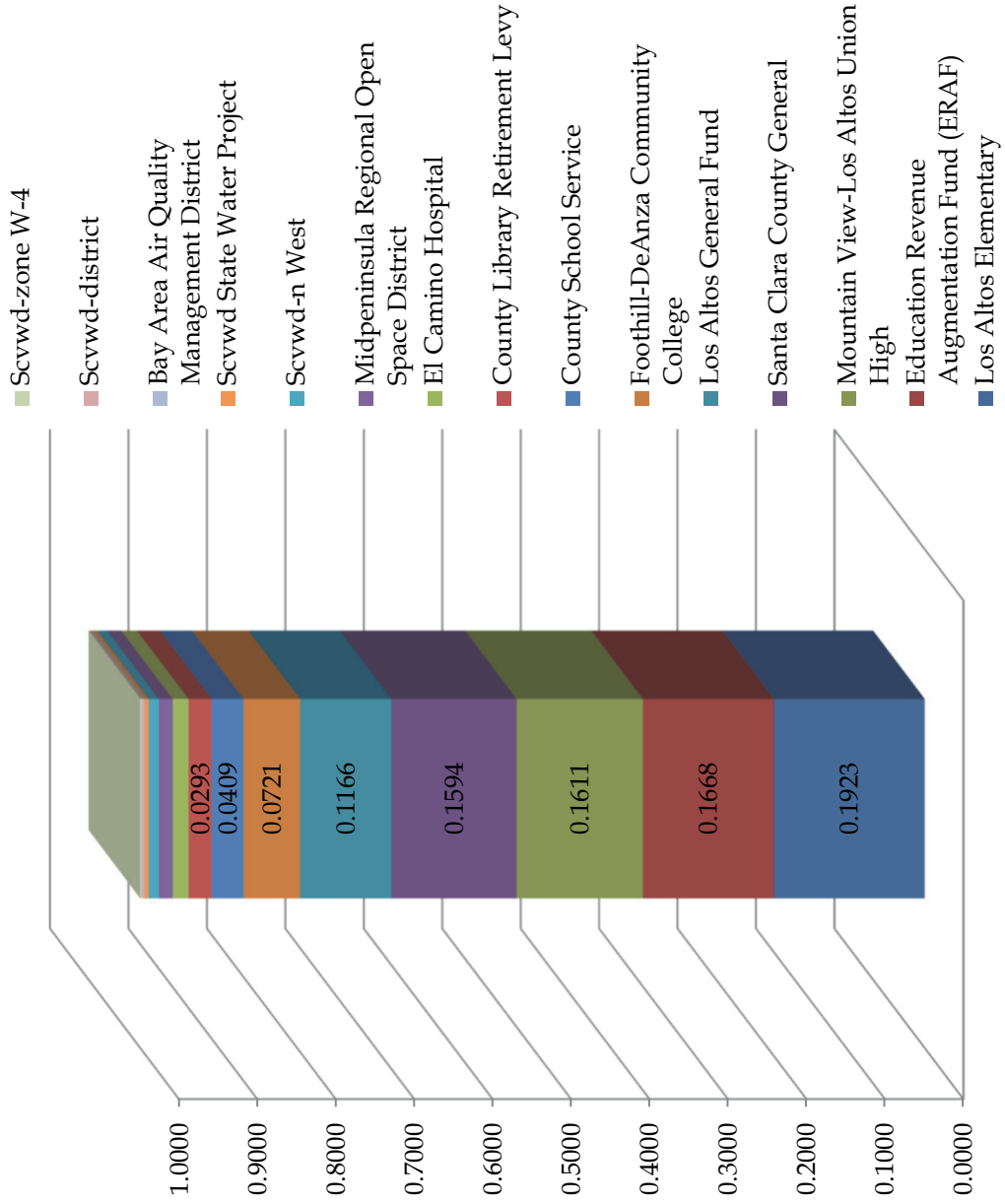

Source:  
HdL Coren & Cone

**City of Los Altos  
Property Tax Dollars By Recipient Group  
June 30, 2021**

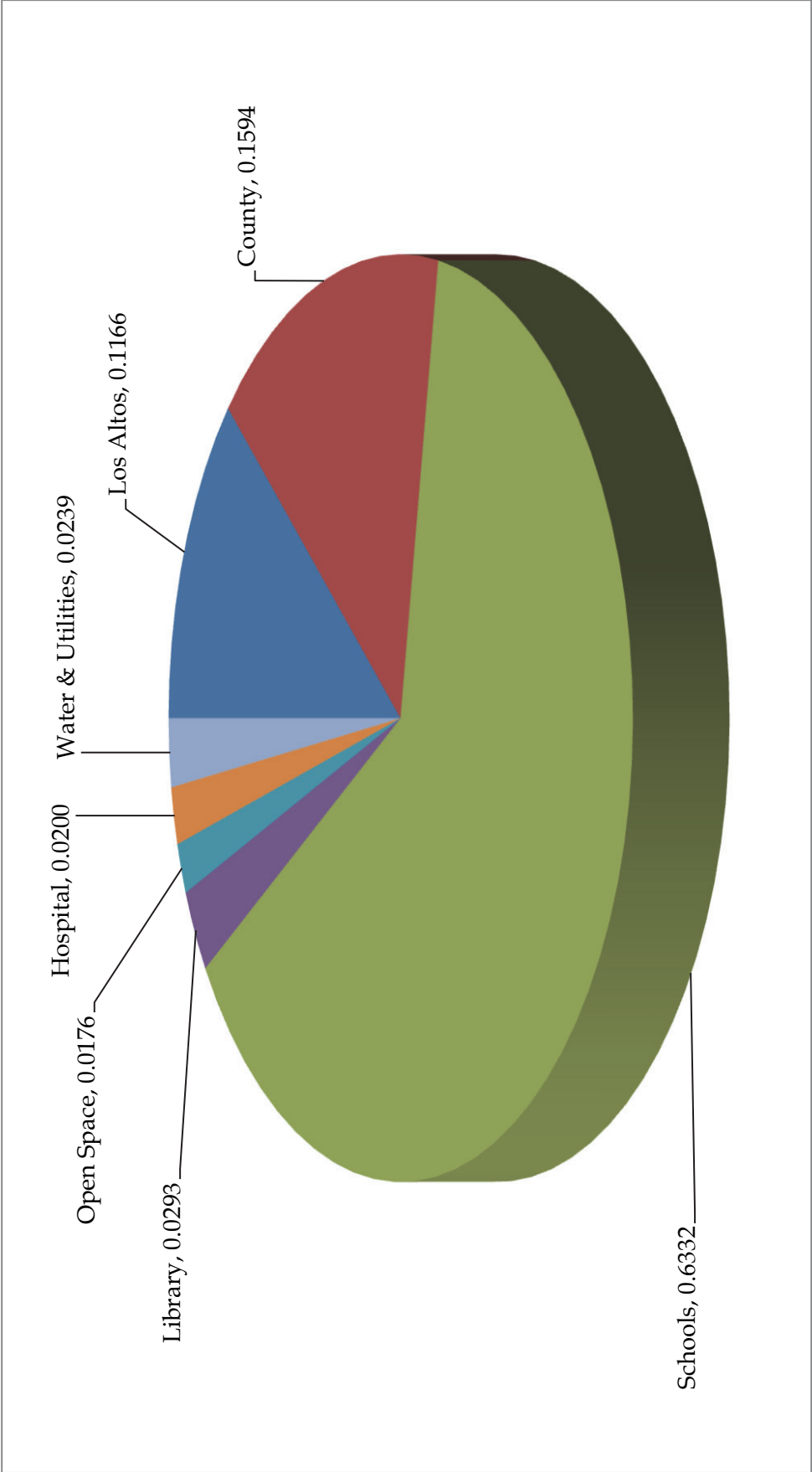

Source:  
HdL Coren & Cone

City of Los Altos  
 Direct and Overlapping Tax Rates  
 Last Ten Fiscal Years  
 (rate per \$100 of taxable value)

Fiscal Year	Overlapping Rates (1)																			Total
	Basic County-Wide	Santa Clara Retirement	County Library Retirement	Los Altos Elementary School	Mountain View Elementary School	Cupertino Elementary School	Whisman School Bond	Foothill-De Anza College	Mountain View High School	Fremont Union High School	Santa Clara Valley Water District	Mid Peninsula Open Space	County Housing Bond	County Hospital Bonds	El Camino Hospital					
2011-12	1.0000	0.0388	0.0024	0.0595	0.0303	0.0290	-	0.0297	0.0147	0.0415	0.0064	-	-	0.0047	0.0129	1.2699				
2012-13	1.0000	0.0388	0.0024	0.0579	0.0302	0.0598	0.0300	0.0287	0.0139	0.0390	0.0069	-	-	0.0051	0.0129	1.3256				
2013-14	1.0000	0.0388	0.0024	0.0534	0.0276	0.0525	0.0254	0.0290	0.0121	0.0405	0.0070	-	-	0.0035	0.0129	1.3051				
2014-15	1.0000	0.0388	0.0024	0.0524	-	0.0540	-	0.0276	0.0133	0.0396	0.0065	-	-	0.0091	0.0129	1.2566				
2015-16	1.0000	0.0388	0.0024	0.0485	-	0.0519	-	0.0240	0.0119	0.0525	0.0057	0.0008	-	0.0088	0.0129	1.2582				
2016-17	1.0000	0.0388	0.0024	0.0479	-	0.0509	-	0.0234	0.0112	0.0403	0.0086	0.0006	-	0.0086	0.0129	1.2456				
2017-18	1.0000	0.0388	0.0024	0.0463	-	0.0496	-	0.0220	0.0107	0.0464	0.0062	0.0009	0.0127	0.0082	0.0100	1.2542				
2018-19	1.0000	0.0388	0.0024	0.0449	-	0.0397	-	0.0217	0.0409	0.0430	0.0042	0.0018	0.0105	0.0072	0.0100	1.2651				
2019-20	1.0000	0.0388	0.0024	0.0418	-	0.0415	-	0.0208	0.0365	0.0479	0.0041	0.0016	0.0100	0.0069	0.0100	1.2623				
2020-21	1.0000	0.0388	0.0024	0.0713	-	0.0403	-	0.0364	0.0400	0.0478	0.0037	0.0015	-	0.0069	0.0100	1.2991				

Source:

HdL Coren & Cone

(1) Overlapping rates are those of local and county governments that apply to property owners within the City of Los Altos; however, not all of these overlapping rates apply to all Los Altos property owners.

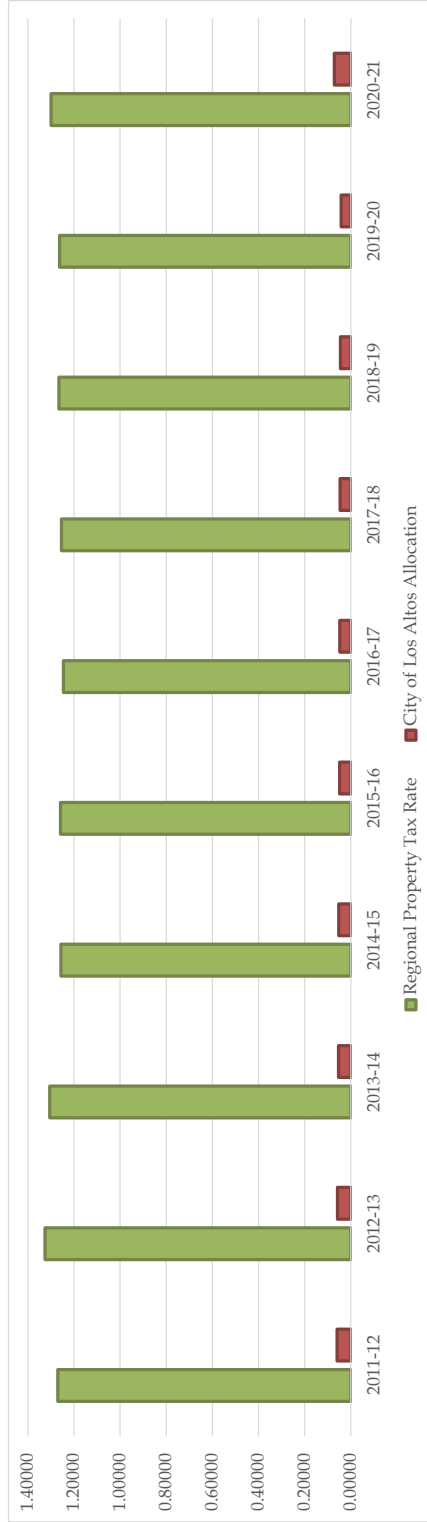

City of Los Altos  
Principal Property Taxpayers  
Current Year and Nine Years Ago

Taxpayer	2020-21				2011-12			
	Total Assessed Value	Rank	% of City's Est. Total Property Tax Revenue	Total Assessed Value	Rank	% of City's Est. Total Property Tax Revenue		
RLJ R Los Altos LP	\$ 69,225,673	1	0.39%	\$ 26,444,234	3			
Los Altos Gardens II LP	57,719,605	2	0.32%					
Imperial Hornet Developers LLC	56,100,000	3	0.31%					
St Paul Fire and Marine Insurance Co	54,047,269	4	0.30%					
5150 ECR Group LLC	49,939,200	5	0.28%					
Sutter Bay Medical Foundation	41,690,103	6	0.23%					
Richard T Spieker Trustee	39,390,525	7	0.22%					
Springwood Apartments	33,170,540	8	0.18%	\$ 27,002,877	2	0.28%		
Safeway Inc	29,278,088	9	0.16%					
199 First Street Owner LLC	24,000,000	10	0.13%					
KRC Los Altos LP			0.00%	20,720,000	6	0.21%		
Behringer Harvard El Camino Real LP	-		-	40,522,807	1	0.42%		
Compass Grand Los Altos	-		-	21,411,487	5	0.22%		
David & Lucile Packard Foundation	-		-			0.00%		
4 Seasons Associations LLC	-		-	19,061,754	7	0.20%		
Palo Alto Medical Foundation	-		-	21,751,597	4	0.22%		
Los Altos Hotel Associates LLC	-		-	16,990,461	8	0.18%		
Village Court Partners	-		-	16,256,756	9	0.17%		
Whole Foods Market California Inc	-		-	13,770,278	10	0.14%		
<b>Top Ten Total</b>	<b>\$ 454,561,003</b>		<b>2.53%</b>	<b>\$ 223,932,251</b>		<b>2.04%</b>		
<b>City Total</b>	<b>\$ 17,975,243,547</b>			<b>\$ 9,698,378,507</b>				

Source:  
HdL Coren & Cone

**City of Los Altos  
Property Tax Levies and Collections  
Last Ten Fiscal Years**

Fiscal Year	Santa Clara County							
	Total Tax Levy	Current Tax Collections		Levy Collected	Levy Collected of the Total Levy	Current Collections of the Levy	Delinquent Tax Collections	
		\$	\$					
2010-11	\$ 3,654,128,401	\$ 288,311,420	\$ 268,113,225	7.34%	92.99%	7.01%		
2011-12	3,703,148,623	293,002,052	273,640,116	7.39%	93.39%	6.61%		
2012-13	3,877,675,089	301,164,764	292,131,302	7.53%	97.00%	3.00%		
2013-14	4,165,019,181	349,740,765	316,325,898	7.59%	90.45%	2.59%		
2014-15	4,463,179,149	344,291,093	339,731,930	7.61%	98.68%	0.98%		
2015-16	4,944,651,360	330,545,207	326,823,894	6.61%	98.87%	1.13%		
2016-17	5,278,067,434	359,152,852	346,454,876	6.56%	96.46%	1.89%		
2017-18	5,719,021,680	355,579,401	345,863,202	6.05%	97.27%	1.86%		
2018-19	6,070,435,575	402,557,998	394,623,618	6.50%	98.03%	1.46%		
2019-20	6,512,388,164	385,721,931	378,492,815	5.81%	98.13%	1.74%		
<b>2020-21</b>	<b>6,920,087,868</b>	<b>422,454,897</b>	<b>413,409,481</b>	<b>5.97%</b>	<b>97.86%</b>	<b>1.80%</b>		

Source:

County of Santa Clara

**Note:**

The actual tax levy data for the City of Los Altos is not available because the Santa Clara County uses a factor known as the AB8 factors to apportion the 1% portion of the tax levies/collections to each of the jurisdictions within the county. The City's AB8 factors range from 0.0029 to 0.0033 for the past 10 years. Additionally, the City and the County adopted the "alternative method of property tax distributions" that authorizes the County to allocate 100% of the secured property tax based on levy instead of collection, and to retain all delinquent penalties and interest.

**City of Los Altos**  
**Ratios of Outstanding Debt by Type**  
**Last Ten Fiscal Years**

Fiscal Year	Governmental Activities						Per Capita Personal Income (2)
	General Obligation Bond	Certificates of Participation (1)	Capital Lease	Total	Population (2)	Per Capita	
2010-11	\$ -	\$ 1,945,000	\$ -	\$ 1,945,000	28,863	\$ 67	\$ 73,414
2011-12	\$ -	\$ 1,855,000	\$ -	\$ 1,855,000	29,460	\$ 63	\$ 72,608
2012-13	\$ -	\$ 1,760,000	\$ -	\$ 1,760,000	29,792	\$ 59	\$ 74,570
2013-14	\$ -	\$ 1,665,000	\$ -	\$ 1,665,000	29,969	\$ 56	\$ 79,102
2014-15	\$ -	\$ 1,565,000	\$ -	\$ 1,565,000	29,884	\$ 52	\$ 83,041
2015-16	\$ -	\$ 1,460,000	\$ -	\$ 1,460,000	31,353	\$ 47	\$ 80,407
2016-17	\$ -	\$ 1,355,000	\$ -	\$ 1,355,000	31,402	\$ 43	\$ 86,558
2017-18	\$ -	\$ 1,245,000	\$ -	\$ 1,245,000	31,361	\$ 40	\$ 93,010
2018-19	\$ -	\$ 1,125,000	\$ -	\$ 1,125,000	31,190	\$ 36	\$ 96,333
2019-20	\$ -	\$ 1,005,000	\$ -	\$ 1,005,000	30,876	\$ 33	\$ 104,649
<b>2020-21</b>	<b>\$ -</b>	<b>\$ 880,000</b>	<b>\$ 9,496,863.00</b>	<b>\$ 10,376,863</b>	<b>30,510</b>	<b>\$ 340</b>	<b>\$ 115,433</b>

Sources:

(1) City of Los Altos Finance Department

(2) HdL Coren & Cone

Note: Special Assessment Debt is no longer presented as they involve limited obligation bonds that are secured by ad valorem assessments and carry no city obligation.

**City of Los Altos**  
**Schedule of Direct and Overlapping Bonded Debt**  
**June 30, 2021**

**2020-21 Assessed Valuation:** \$17,975,243,547

	<b>Total Debt</b>	<b>%</b>	<b>City's Share of</b>
	<b>6/30/2020</b>	<b>Applicable (1)</b>	<b>Debt 6/30/20</b>
<b>OVERLAPPING TAX AND ASSESSMENT DEBT:</b>			
Santa Clara County	\$ 812,685,000	3.263%	\$26,517,912
Foothill-De Anza Community College District	707,932,142	9.305%	65,873,086
Fremont Union High School District	617,160,088	3.934%	24,279,078
Mountain View-Los Altos Union High School District	207,011,101	24.138%	49,968,340
Cupertino Union School District	284,223,303	7.180%	20,407,233
Los Altos School District	164,070,000	52.711%	86,482,938
El Camino Hospital District	116,290,000	16.687%	19,405,312
Midpeninsula Regional Park District	86,400,000	5.341%	4,614,624
Santa Clara Valley Water District Benefit Assessment District	57,010,000	3.263%	1,860,236
City of Los Altos 1915 Act Bonds	485,000	100.000%	485,000
<b>TOTAL OVERLAPPING TAX AND ASSESSMENT DEBT</b>			<b>\$299,893,759</b>
<b>DIRECT AND OVERLAPPING GENERAL FUND DEBT:</b>			
Santa Clara County General Fund Obligations	\$ 914,957,860	3.263%	29,855,075
Santa Clara County Pension Obligation Bonds	341,399,194	3.263%	11,139,856
Santa Clara County Board of Education Certificates of Participation	2,670,000	3.263%	87,122
Foothill-De Anza Community College District Certificates of Participation	22,085,000	9.305%	2,055,009
Mountain View-Los Altos Union High School District General Fund Obligations	2,489,970	24.138%	601,029
Los Altos School District General Fund Obligations	1,954,070	52.711%	1,030,010
<b>City of Los Altos General Fund Obligations</b>	<b>10,377,499</b>	<b>100.000%</b>	<b>10,377,499</b>
Midpeninsula Regional Park District General Fund Obligations	106,000,600	5.341%	5,661,492
Santa Clara County Vector Control District Certificates of Participation	1,765,000	3.263%	57,592
<b>TOTAL GROSS DIRECT AND OVERLAPPING GENERAL FUND DEBT</b>			<b>\$ 60,864,684</b>
Less: Santa Clara County supported obligations			824,798
<b>TOTAL NET DIRECT AND OVERLAPPING GENERAL FUND DEBT</b>			<b>\$ 60,039,886</b>
<b>TOTAL DIRECT DEBT</b>			<b>\$ 10,377,499</b>
<b>TOTAL GROSS OVERLAPPING DEBT</b>			<b>\$ 350,380,944</b>
<b>TOTAL NET OVERLAPPING DEBT</b>			<b>\$ 349,556,146</b>
<b>GROSS COMBINED TOTAL DEBT</b>			<b>\$ 360,758,443 (2)</b>
<b>NET COMBINED TOTAL DEBT</b>			<b>\$ 359,933,645</b>

Source:

California Municipal Statistics, Inc.

(1) The percentage of overlapping debt applicable to the city is estimated using taxable assessed property value. Applicable percentages were estimated by determining the portion of the overlapping district's assessed value that is within the boundaries of the city divided by the district's total taxable assessed value.

(2) Excludes tax and revenue anticipation notes, enterprise revenue, mortgage revenue and non-bonded capital lease obligations.



City of Los Altos  
 Legal Debt Margin  
 Last Ten Fiscal Years

Fiscal Year	Assessed Valuation (1)	Debt Limit 15% of Assessed Valuation	Debt Applicable to Limit	Legal Debt Margin
2011-12	10,202,177,182	1,530,326,577	-	1,530,326,577
2012-13	10,202,177,182	1,530,326,577	-	1,530,326,577
2013-14	11,159,691,006	1,673,953,651	-	1,673,953,651
2014-15	11,894,742,345	1,784,211,352	-	1,784,211,352
2015-16	12,831,411,774	1,924,711,766	-	1,924,711,766
2016-17	13,713,091,004	2,056,963,651	-	2,056,963,651
2017-18	14,654,150,002	2,198,122,500	-	2,198,122,500
2018-19	15,720,232,198	2,358,034,830	-	2,358,034,830
2019-20	16,809,016,557	2,521,352,484	-	2,358,034,830
2020-21	17,975,243,547	2,696,286,532	-	2,696,286,532

Source:  
 (1) HdL Coren & Cone

City of Los Altos  
Demographic Statistics  
Last Ten Fiscal Years

Fiscal Year	City Population <sup>(1)</sup>	Percentage Change	School Enrollment <sup>(2)</sup>	Percentage Change	Unemployment Rate <sup>(1)</sup>	Per Capita Personal Income <sup>(1)</sup>	Median Age <sup>(1)</sup>	% with High School Degree <sup>(1)</sup>	% with Bachelor's Degree <sup>(1)</sup>
2011-12	29,460	2.07%	8,138	1.28%	4.9%	\$ 72,608	45.4	98.50%	78.20%
2012-13	29,792	1.13%	8,198	0.74%	3.2%	\$ 74,570	45.8	98.70%	76.70%
2013-14	29,969	0.59%	8,303	1.28%	2.6%	\$ 79,102	46.1	98.70%	77.40%
2014-15	29,884	-0.28%	8,284	-0.23%	3.4%	\$ 83,041	46.2	98.80%	78.70%
2015-16	31,353	4.92%	8,666	4.61%	2.7%	\$ 80,407	46.2	98.70%	79.00%
2016-17	31,402	0.16%	8,606	-0.69%	2.4%	\$ 86,558	45.7	98.70%	80.00%
2017-18	31,361	-0.13%	8,685	0.92%	1.6%	\$ 93,010	45.7	98.60%	80.90%
2018-19	31,190	-0.55%	8,610	-0.86%	2.4%	\$ 96,333	45.9	98.60%	82.30%
2019-20	30,876	-1.01%	8,513	-1.13%	2.3%	\$ 104,649	45.8	98.40%	82.60%
2020-21	30,510	-1.19%	7,693	-9.63%	4.2%	\$ 115,433	46.1	98.40%	84.20%

Sources:

(1) HdL Coren & Cone

(2) State of California Department of Education

**City of Los Altos  
Principal Employers  
Current Year and Ten Years Ago**

Employer	2020-21			2009-10 (Latest Available)		
	Employees (1)	Rank	% of Total City Employment	Employees (4)	Rank	% of Total City Employment
Los Altos School District	442 *	(2)	3.31%	568 *	(2)	4.54%
Toyota Research Institute	400		3.00%			
Whole Food Market	242		1.81%	198	2	1.58%
Los Altos High School	210	(3)	1.57%	217	(3)	1.74%
Los Altos Sub-Acute & Rehab	196		1.47%	-	-	-
City of Los Altos	131		0.98%	130	7	1.04%
The David and Lucile Packard Foundation	131		0.98%	100	10	0.80%
Alain Pinel Realtors	129		0.97%	150	5	1.20%
Adobe Animal Hospital	118		0.88%	125	8	1.00%
Palo Alto Medical Foundation	110		0.82%	-	-	-
Coldwell Banker	-		-	190	3	1.52%
Covenant Care Sub Acute Rehab	-		-	163	4	1.30%
Pilgrim Haven Skilled Nursing	-		-	120	9	0.96%
Top Ten Total	2,109		15.81%	1,961		15.69%
Total Employees in City	13,341			12,500	(1)	

Sources:

- (1) City Finance Department
- (2) Los Altos School District FY21-22 Annual Budget
- (3) California State Department of Education

\* - For fiscal years 2009-10, this number includes 119 substitute teachers.

**City of Los Altos  
Full-time Equivalent City Employees by Function/Program  
Last Ten Fiscal Years**

Function/Program	FISCAL YEAR									
	2011-12	2012-13	2013-14	2014-15	2015-16	2016-17	2017-18	2018-19	2019-20	2020-21
<i>Public Safety</i>										
Police Operations	32.00	32.00	32.00	32.00	31.00	31.00	31.00	31.00	30.00	30.00
Police Traffic Safety	5.00	5.00	4.00	4.00	4.00	4.00	4.00	4.00	4.00	4.00
Communications	11.00	11.00	11.00	11.00	11.00	11.00	11.00	11.00	13.00	13.00
<i>Maintenance Services</i>										
Maintenance Services	29.50	29.50	29.50	29.50	29.50	29.50	29.50	28.00	27.00	27.00
<i>Recreation</i>										
Recreation	7.00	7.00	7.00	7.00	8.00	8.00	8.00	8.00	8.00	8.00
<i>Community Development</i>										
Planning & Building	13.00	13.00	14.00	14.00	14.00	15.00	15.00	14.00	15.00	15.00
Engineering	9.00	9.00	9.00	9.00	9.00	10.00	10.00	12.25	13.25	13.25
Economic Development	1.00	1.00	1.00	1.00	1.00	1.00	1.00	1.00	1.00	1.00
<i>Administration</i>										
City Management	4.75	4.75	5.00	5.00	5.00	5.00	5.00	6.00	6.00	6.00
Administration & Finance	10.00	10.00	10.00	10.00	12.00	12.00	12.00	11.00	11.00	11.00
<i>Sewer</i>										
Sewer	6.25	6.25	6.25	6.25	6.25	6.25	6.25	7.50	7.50	7.50
<i>Solid Waste</i>										
Solid Waste	0.25	0.25	0.25	0.25	0.25	0.25	0.25	0.25	0.25	0.25
<i>Storm Drain</i>										
Storm Drain	1.00	1.00	1.00	1.00	-	-	-	-	-	-
<b>Total</b>	<u>129.75</u>	<u>129.75</u>	<u>130.00</u>	<u>130.00</u>	<u>131.00</u>	<u>133.00</u>	<u>133.00</u>	<u>134.00</u>	<u>136.00</u>	<u>136.00</u>

Source:

City of Los Altos Finance Department

Note: In FY09-10 Staffing assignments were recategorized in the revision of the budget process to align with functional areas.

**City of Los Altos  
 Full-time Equivalent City Employees  
 Last Ten Fiscal Years**

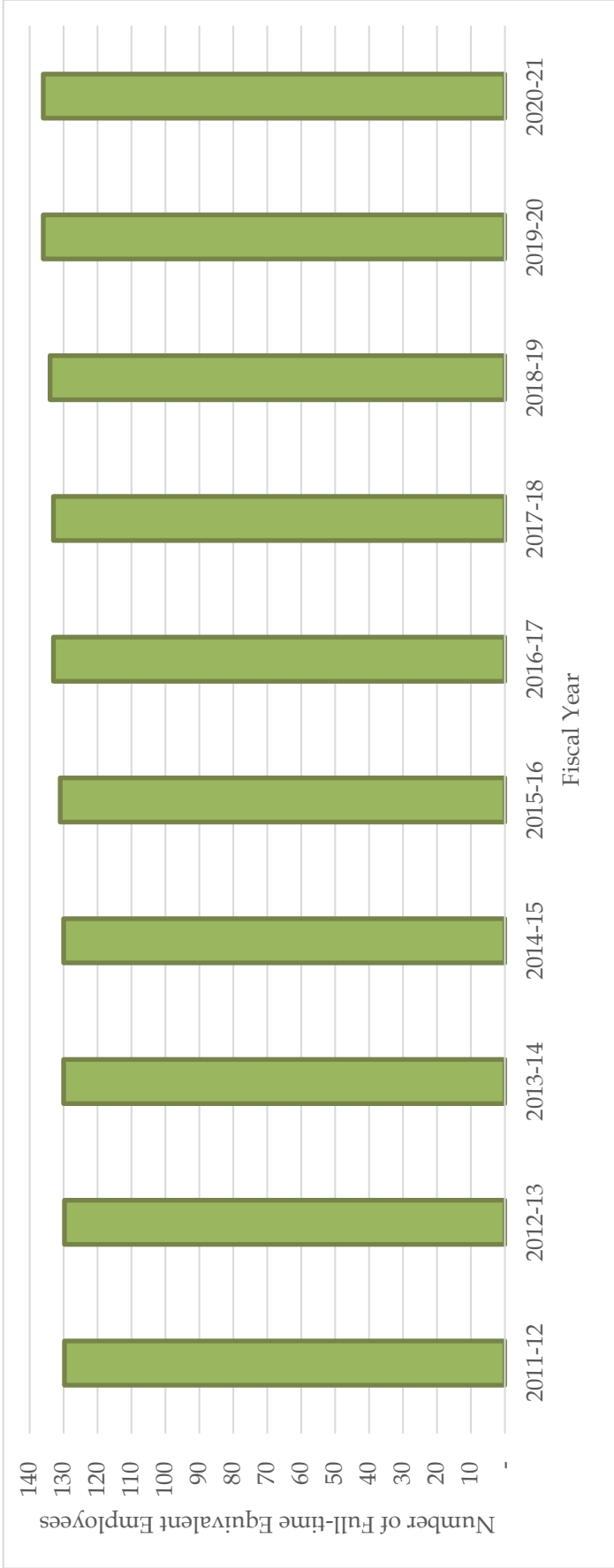

Source:  
 City of Los Altos

City of Los Altos  
 Operating Indicators by Function/Program  
 Last Ten Fiscal Years

Function/Program	FISCAL YEAR									
	2011-12	2012-13	2013-14	2014-15	2015-16	2016-17	2017-18	2018-19	2019-20	2020-21
<b>Police:</b>										
Arrests	301	308	283	312	222	210	211	717	893	347
Moving citations issued	1,385	1,285	1,069	1,555	1,757	982	1,203	2,517	1474	1053
Parking citations issued	1,938	1,947	2,559	2,266	3,138	2,431	1,879	1,338	1573	543
Municipal code violations issued	25	56	161	109	103	25	115	116	54	54
<b>Public Works:</b>										
Crack sealing in lineal feet	66,290	98,136	2,112	113,784	101,040	110,000	174,040	-	120,000	45,536
Street sign installed and replaced	1,361	511	949	596	457	100	320	1,025	1200	411
<b>Recreation:</b>										
Classes/programs	1,821	2,675	2,738	2,713	2,107	2,349	2,724	1,803	1559	1298
Facility rentals	3,106	2,702	3,501	5,648	5,378	5,927	4,141	4,044	2246	1269
Field/gymnasium permits	3,658	3,388	2,945	4,509	2,795	3,433	3,556	3,109	2383	1935
<b>Planning:</b>										
Plan applications submitted	404	510	716	757	800	675	686	988	493	935
<b>Building:</b>										
Permits issued	1,690	1,817	1,757	1,751	1,927	1,769	1,795	1,939	1,695	2,036
Plan checks submitted	560	636	649	582	599	619	569	619	883	991
Inspections	7,108	6,631	7,682	7,227	7,517	6,445	6,479	7,967	7,920	8,862
<b>Sewer:</b>										
Cleaning and flushing in lineal feet	852,453	777,285	667,415	683,552	759,456	585,273	713,795	585,095	601,543	768,557
<b>Storm Drain:</b>										
Catch basin/storm drain cleaned (measured in storm inlets cleaned)	1,583	1,202	1,898	1,350	1,350	1,350	1,350	1,350	2,000	1,350

Sources:  
 City of Los Altos Quarterly Reports.  
 Data for all fiscal years was provided by the corresponding departments.

City of Los Altos  
 Capital Asset Statistics by Function/Program  
 Last Ten Fiscal Years

Function/Program	FISCAL YEAR									
	2011-12	2012-13	2013-14	2014-15	2015-16	2016-17	2017-18	2018-19	2019-20	2020-21
<b>Public Safety:</b>										
Police Station	1	1	1	1	1	1	1	1	1	1
Fire Stations	2	2	2	2	2	2	2	2	2	2
<b>Recreation:</b>										
Number of Parks	10	10	10	10	10	10	10	10	10	10
Park Acreage	38	38	38	38	38	38	38	38	38	38
Number of Libraries	2	2	2	2	2	2	2	2	2	2
Number of History Museums	1	1	1	1	1	1	1	1	1	1
<b>Maintenance Services:</b>										
Miles of Streets	127	127	127	127	127	127	127	127	127	127
Number of Traffic Signals	13	13	13	13	13	13	16	16	16	16
<b>Sewer:</b>										
Miles of Sewer Mains	141	141	141	141	141	141	141	141	141	141
<b>Storm Drain:</b>										
Miles of Storm Drain Mains	58	58	58	58	58	58	58	58	58	58

Source:  
 City of Los Altos

City of Los Altos  
Trust and Agency Debt Administration  
Last Ten Fiscal Years

Non-City Obligation Debt  
Special Assessment Debt Service

Fiscal Year	Avalon Dr. Curb & Gutter		Raymundo Curb & Gutter		Blue Oak Lane Sewer		Total Special Assessment Debt Service			
	Special	Principal	Special	Principal	Special	Principal	Special	Principal	Interest	Coverage
2011-12	27,091	8,000	2,204	16,000	9,068	12,880	34,490	36,880	45,762	1.24
2012-13	27,091	8,000	1,740	17,000	8,300	10,000	31,900	35,000	41,940	1.27
2013-14	10,044	8,000	1,276	18,000	7,487	10,000	31,629	36,000	40,392	1.10
2014-15	-	18,620	783	19,000	6,626	15,000	31,241	52,620	38,650	0.85
2015-16	-	-	-	20,000	5,719	15,000	30,741	35,000	36,460	1.09
2016-17	-	-	-	21,000	4,766	15,000	30,197	36,000	34,963	1.10
2017-18	-	-	-	21,000	3,790	15,000	29,610	36,000	33,400	1.10
2018-19	-	-	-	22,000	2,790	15,000	28,971	37,000	31,761	1.12
2019-20	-	-	-	23,999	1,721	15,000	28,341	38,999	30,062	1.09
2020-21	-	-	-	25,000	581	15,000	27,648	40,000	28,229	1.09

Source:

City of Los Altos Finance Department

Note : This chart presents Limited Obligation Debt that the City Administers on a trust and Agency Basis. This debt does not represent City Obligations.