

**Men's Locker Room**

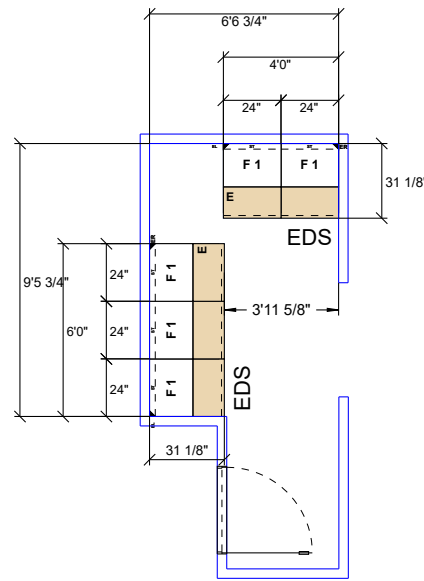

**Women's Locker Room**

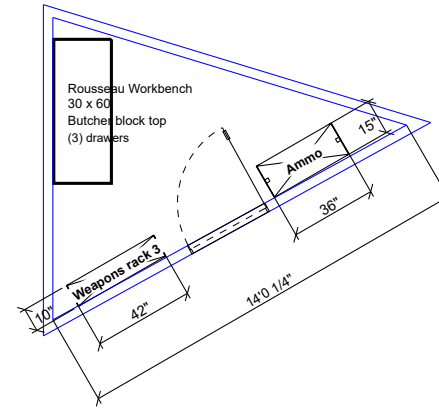

**Gun Repair & Ammo Room**

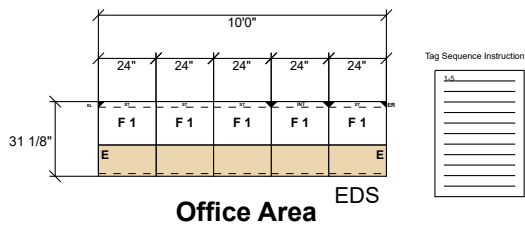

**Office Area**

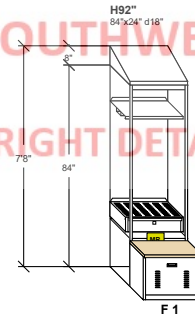

F1

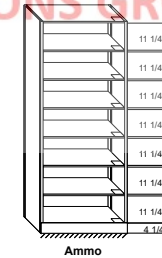

Ammo

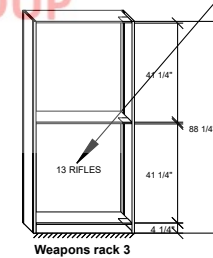

Weapons rack 3

COPYRIGHT © 2024 SOUTHWEST SOLUTIONS GROUP  
SEE COPYRIGHT DETAILS BELOW

Customer's Approval:

Date:

**SOUTHWEST SOLUTIONS GROUP**  
business efficiency systems

Texas - Oklahoma - Kansas - Arkansas - Missouri  
Tennessee - Mississippi - Louisiana  
Washington - Montana - Idaho - Alaska

Toll Free: 1-800-803-1083

www.southwestsolutions.com

Drawing:  
Number: 113836-1A

Printed Date:  
11/05/2024

Scale:  
1:80

Salesperson:

Revision:

Drawn By:  
DW/VA

Sheet:  
1 of 4

WINGER, DOUG

Lake Forest Park PD  
Personal Duty Lockers  
Lake Forest Park, WA

Copyright © 2024 Southwest Solutions Group. This material is proprietary and confidential, and the disclosure reproduction by photography, film, blueprint or otherwise or incorporation into any information retrieval system without first receiving written approval from Southwest Solutions Group is expressly prohibited by law.



## Men's Locker Room

Customer's Approval:

Date:

  
**SOUTHWEST SOLUTIONS GROUP**  
*business efficiency systems*  
 Texas - Oklahoma - Kansas - Arkansas - Missouri  
 Tennessee - Mississippi - Louisiana  
 Washington - Montana - Idaho - Alaska  
 Toll Free: 1-800-803-1083  
[www.southwestsolutions.com](http://www.southwestsolutions.com)

Drawing Number:	113836-1A	Revision:	
Printed Date:	11/05/2024	Drawn By:	DW/VA
Scale:	1:33	Sheet:	2 of 4
Salesperson:	WINGER, DOUG		

Lake Forest Park PD  
 Personal Duty Lockers  
 Lake Forest Park, WA

Copyright © 2024 Southwest Solutions Group. This material is proprietary and confidential, and the disclosure reproduction by photography, film, blueprint or otherwise or incorporation into any information retrieval system without first receiving written approval from Southwest Solutions Group is expressly prohibited by law.

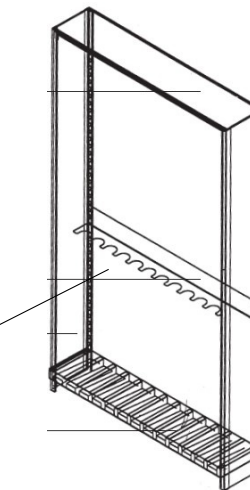
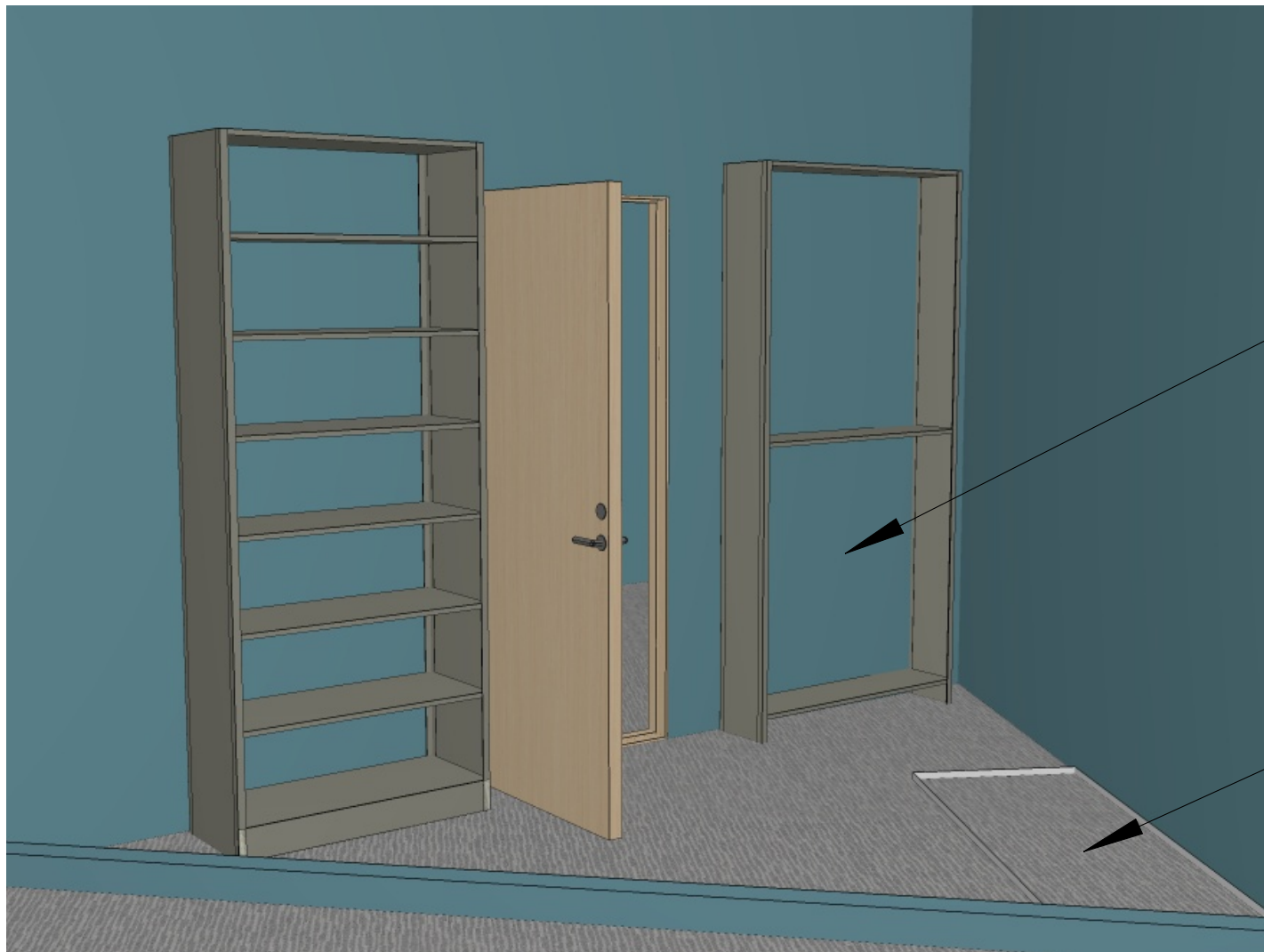

Rousseau Workbench  
30 x 60  
Butcher block top  
(3) drawers

## Gun Repair & Ammo Room

Customer's Approval:

Date:

  
**SOUTHWEST SOLUTIONS GROUP**  
*business efficiency systems*  
 Texas - Oklahoma - Kansas - Arkansas - Missouri  
 Tennessee - Mississippi - Louisiana  
 Washington - Montana - Idaho - Alaska  
 Toll Free: 1-800-803-1083  
 www.southwestsolutions.com

Drawing Number:	113836-1A	Revision:	
Printed Date:	11/05/2024	Drawn By:	DW/VA
Scale:	1:33	Sheet:	3 of 4
Salesperson:	WINGER, DOUG		

Lake Forest Park PD  
 Personal Duty Lockers  
 Lake Forest Park, WA

Copyright © 2024 Southwest Solutions Group. This material is proprietary and confidential, and the disclosure reproduction by photography, film, blueprint or otherwise or incorporation into any information retrieval system without first receiving written approval from Southwest Solutions Group is expressly prohibited by law.



## Women's Locker Room

Customer's Approval:

Date:

  
**SOUTHWEST SOLUTIONS GROUP**  
*business efficiency systems*  
 Texas - Oklahoma - Kansas - Arkansas - Missouri  
 Tennessee - Mississippi - Louisiana  
 Washington - Montana - Idaho - Alaska  
 Toll Free: 1-800-803-1083  
[www.southwestsolutions.com](http://www.southwestsolutions.com)

Drawing Number:	113836-1A	Revision:	
Printed Date:	11/05/2024	Drawn By:	DW/VA
Scale:	1:33	Sheet:	4 of 4
Salesperson:	WINGER, DOUG		

Lake Forest Park PD  
 Personal Duty Lockers  
 Lake Forest Park, WA

Copyright © 2024 Southwest Solutions Group. This material is proprietary and confidential, and the disclosure reproduction by photography, film, blueprint or otherwise or incorporation into any information retrieval system without first receiving written approval from Southwest Solutions Group is expressly prohibited by law.