

**TOWN OF LANSING ZONING BOARD OF APPEALS
VARIANCE REQUEST**

Application Fee \$: _____

Application Date 9/2/21
*update to previously submitted

Property for which Variance is being requested

Tax Parcel No. 24-4-2 Street Address 281 Bill George Rd, Lansing, MI

Applicants Name and Address

Amy Newman
Eric Clay

Phone 607-592-6874
Cell 917-589-6169
Email amyxnewman@gmail.com

Zoning District (Check One)

R1 _____
R2 _____
R3 _____
B1 _____
B2 _____

(If Applicant different from owner, notarized written permission of owner must be attached hereto).

Owners Name and Address

Amy Newman
Eric Clay

Phone 607-592-6874
Cell 917-589-6169
Email amyxnewman@gmail.com

L1
RA _____
IR _____

Application for (check applicable item)

- A. Interpretation of Zoning Ordinance or Map
 B. Area Variance
 C. Use Variance
 D. Appeal of decision of Code Enforcement Officer

Request relates to provisions of (check applicable item)

- A. Town of Lansing Land use Ordinance, Section 504
 B. Town of Lansing Subdivision Regulations, Section _____
 C. Other (Identitiy) _____

Purpose of Request (attach additional information if necessary)

requesting variance to front yard setback and
and minimum lot area

Justification for Request (attach additional information if necessary)

existing shed is deteriorating and becoming a hazard
to safety and the environment; ~~we~~ seeking to move
and replace structure to reduce one of three
current zoning violations and to provide a more
secure structure

For Context: 281 Bill George Rd. Lakefront

290 Bill George Rd.
(Drew Minson)

Grandfathered house
on the lake

281 Bill George Rd.
(Eric Clay and Amy Newman)

Current shed

295 Bill George Rd.
(The Zirings)

Room similar to, but larger than, what
we propose to build



This proposal continues our improvements at the lakefront

Dilapidated Upper Deck

The current shed is shown here with an upper, 16' X 16' deck, which we removed because it was rotted and dangerous—and too close to our neighbor to the north.

Current Shed Setback Violations

The current shed violates two setback requirements:

- Less than 10 feet from our neighbor to the north
- Within 30 feet of the Cayuga Lake shoreline



The current shed is irreparable and not secure

This is the current interior of the shed: rotted out and in danger of washing away.



Anything left in the shed, like this chair, will be covered with mouse debris. We lost 4 or 5 life jackets and two beach towels because mice chewed through them.



Our goal is to have a secure, dry place to store water items and to sit with a book or laptop.

We have revised our original building plan

Responding to neighbor concerns and feedback from the Town Planning Board on June 29, we have changed the location and reduced the size of the original plan (previously south of the stairs and 10' X 12').

New Plan

10' X 10' near the current shed location (north of the stairs). The current shed is 9' 10" X 8' 2" including eaves (measured per the NYS building code Section 202).

The new location is away from the embankment, which was a concern of our original plan.

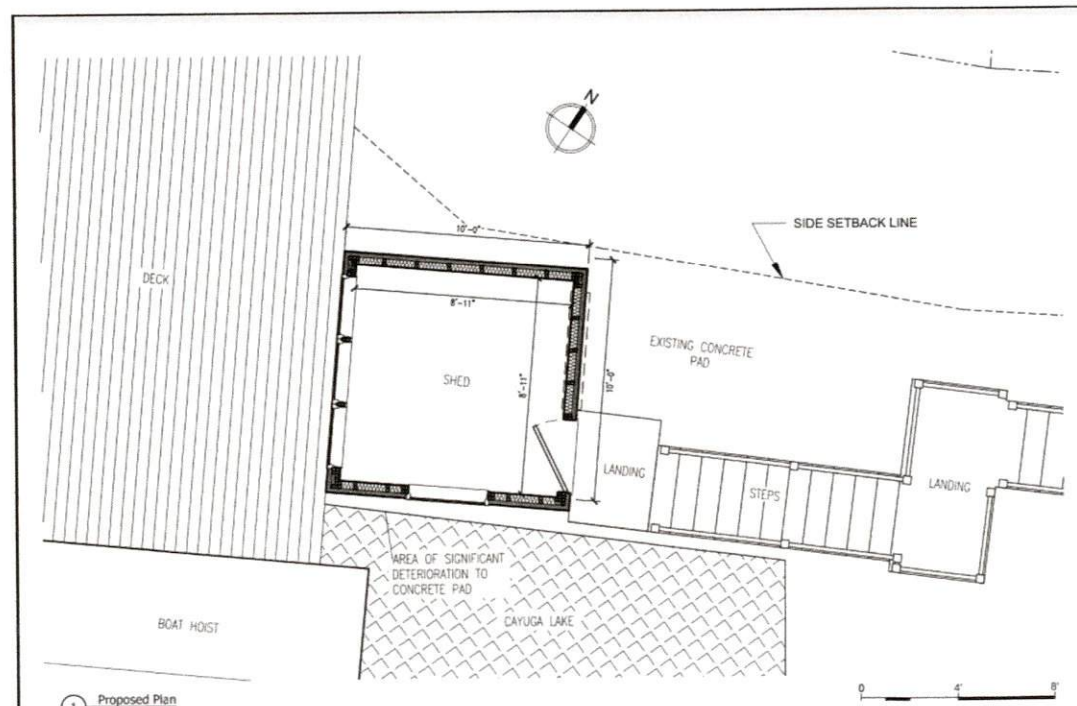

Our new proposal fixes one of two current setback violations and will be functional, dry, and secure

Requires One Setback Variance—30' from the Lake

This structure will no longer violate the setback variance (10 feet) from 290 Bill George, will be away from the embankment, and will be easier to access and use.

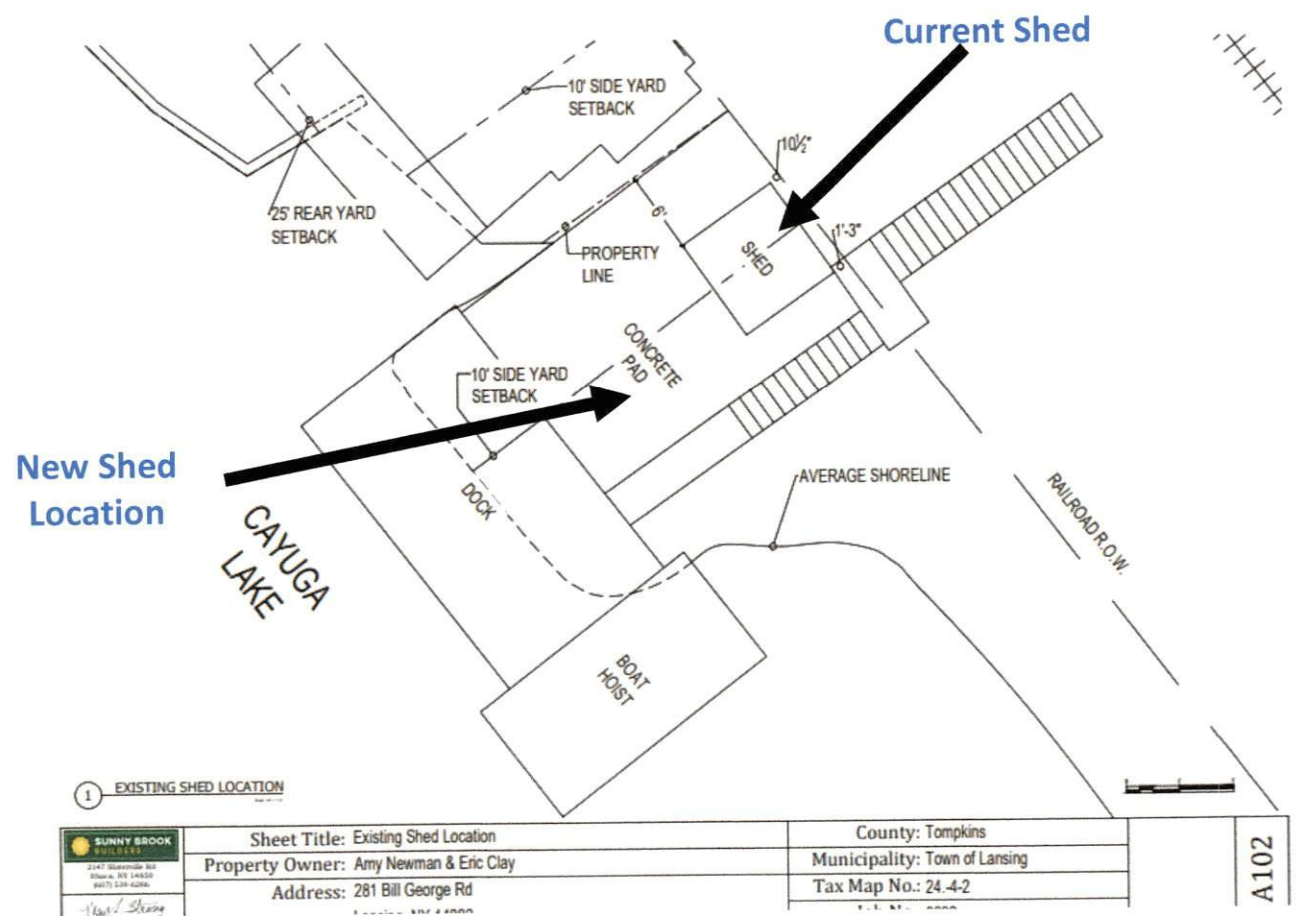

The new plan is similar space for our own use—
not living space.

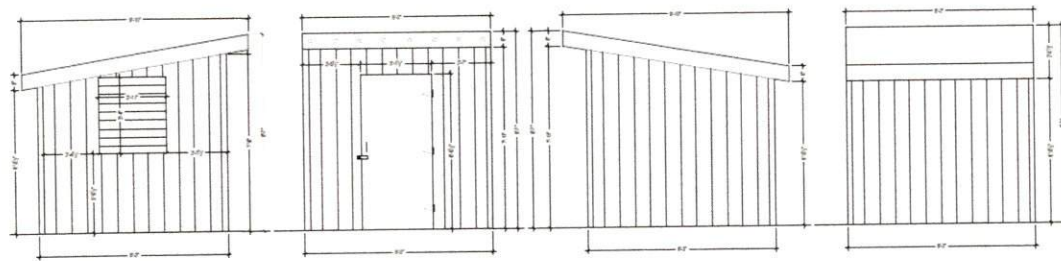

Current Structure

9' 10" X 8' 2" mouse-infested
flooding hazard.

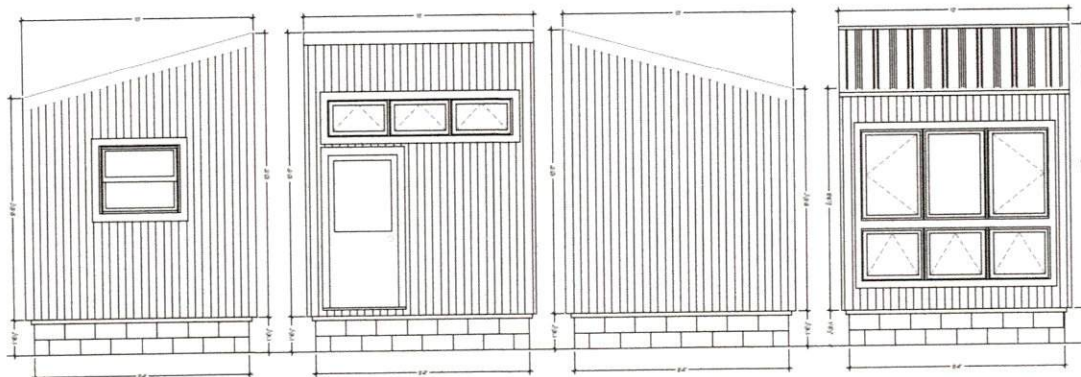

New Structure

10' X 10' square-foot room on blocks with
windows and waterproof walls—but no
water source or fixtures (no sink, toilet, or
shower). We are planning to have electricity,
as we have in the current shed and as is
required for exterior safety. We will not
create living space and welcome the Board
to visit regularly and inspect the property.

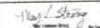
 2147 Riverdale Rd. Ithaca, NY 14850 607.255.4226  Paul Stone Licensed Architect	Sheet Title: Diagrams - Existing vs. Proposed Structure	County: Tompkins	A601
	Property Owner: Amy Newman & Eric Clay	Municipality: Town of Lansing	
	Address: 261 Bill George Rd Lansing, NY 14882	Tax Map No.: 24-4-2	
		Job No.: 3282	

We have addressed other concerns

The situation is complicated, and we understand that it's unusual for residents in our position—with access but unclear ownership rights—to come before the Town Boards.

We have completed the following, as requested:

- Submitted our attorney's opinion that we are within our rights to rebuild (letter dated July 14, 2021, sent to C.J. Randall).
- Submitted an application for a railroad crossing permit.
- Because the project falls within the Special Flood Hazard Area (SFHA), we are building to Flood-Resistant Construction standards by using Flood Damage-Resistant Materials and raising the structure 2' above the Base Flood Elevation.



BINGHAMTON
BAINBRIDGE
CORTLAND
HANCOCK
ITHACA
MONTROSE
OWEGO
WALTON

www.cglawoffices.com
798 Cascadilla Street, Suite A
Ithaca, NY 14850

Mailing Address:
P.O. Box 6599
Ithaca, NY 14851
(607) 379-6709
1 (877) COUGHLIN
Fax: (607) 216-9688
Email: Dgalbraith@cglawoffices.com

July 14, 2021

VIA ELECTRONIC MAIL - crandall@lansingtown.com

C.J. Randall, LEED AP ND
Director of Planning, Town of Lansing
29 Auburn Road
Lansing, NY 14882-9093

**Re: 281 Bill George Road
Our File:**

Dear Ms. Randall:

Our clients, Amy Newman and Eric Clay have asked me to respond to your email of July 2, 2021 concerning the site plan application for the reconstruction of their shed.

The shed in question is depicted upon a survey map dated August 29, 2005 which was prepared at the behest of the prior owners of 281 Bill George Road, a copy of which is attached hereto. Although you reference a 20 year period of use and occupation in your email the period of time for acquisition of title by adverse possession is actually 10 years (Real Property Actions & Proceedings Law §501 [2]; Civil Practice Law and Rules §212 [a]).

Although our clients believe that the shed has existed in its present location for much longer than 20 years the attached survey demonstrates 16 years of open use and occupancy.

The deed under which our clients hold title to their property contains a right of reverter covering land upon which the shed exists in case of abandonment by the railroad. Our clients have therefore been operating under the good faith belief that they have a continuing right to use the structures on the property to the West of the railroad tracks.

I am therefore of the opinion that Ms. Newman and Mr. Clay have a meritorious claim of adverse possession to the area occupied by the shed which they seek to reconstruct.

Very truly yours,

COUGHLIN & GERHART, LLP

A handwritten signature in blue ink, appearing to be 'DAG', written over the firm name.

By: Dirk A. Galbraith
Of Counsel

DAG/cjn
Enclosures

cc: Eric Clay - wericclay@aol.com
Amy Newman - amyxnewman@gmail.com

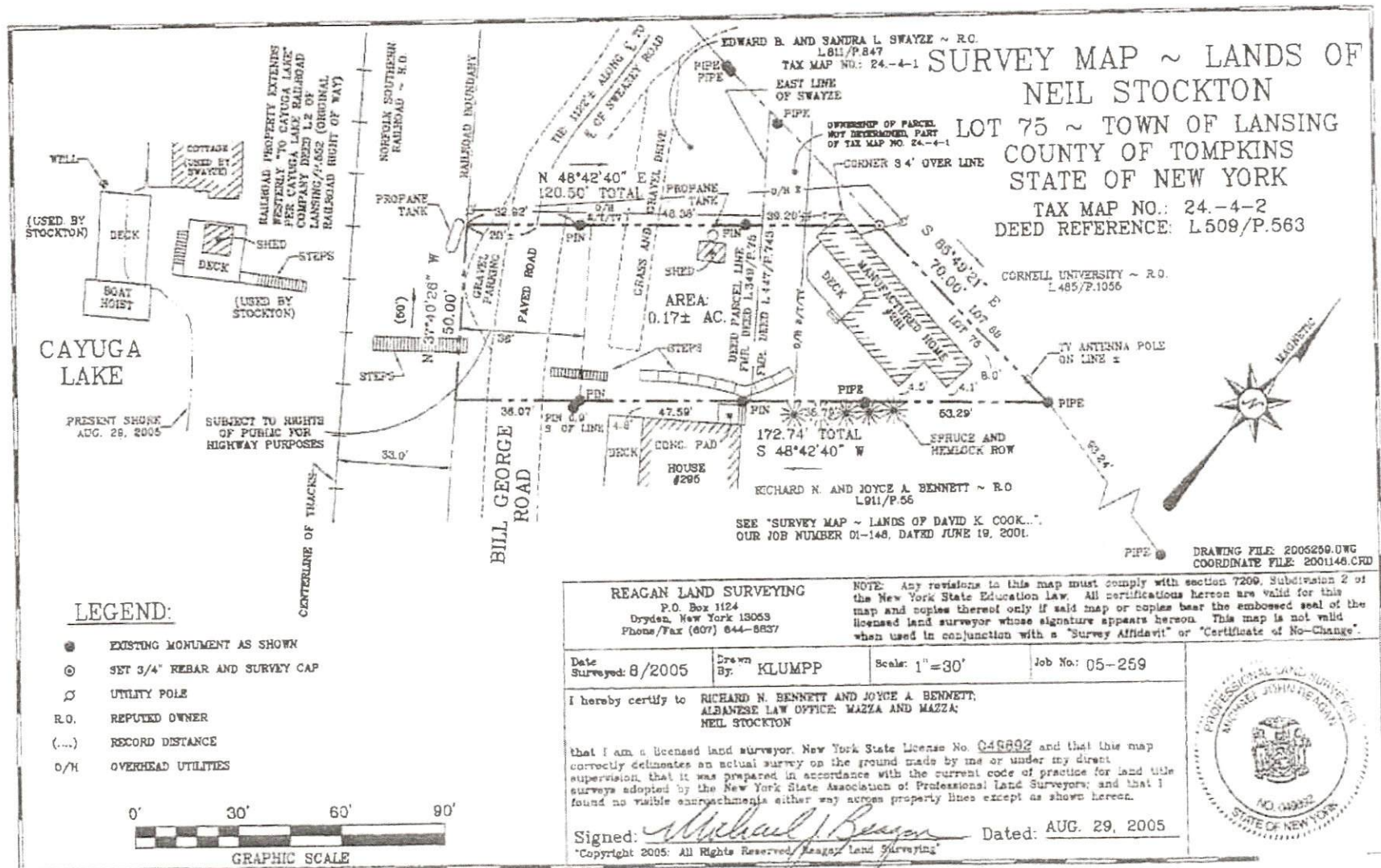

REAGAN LAND SURVEYING

P.O. Box 1124
 Dryden, New York 13063
 Phone/Fax (607) 844-8837

NOTE: Any revisions to this map must comply with section 7209, Subdivision 2 of the New York State Education Law. All certifications hereon are valid for this map and copies thereof only if said map or copies bear the embossed seal of the licensed land surveyor whose signature appears hereon. This map is not valid when used in conjunction with a "Survey Affidavit" or "Certificate of No-Change".

Date Surveyed: 8/2005 Drawn By: KLUMPP Scale: 1"=30' Job No.: 05-259

I hereby certify to RICHARD N. BENNETT AND JOYCE A. BENNETT,
 ALBANESE LAW OFFICE MAZZA AND MAZZA,
 NEIL STOCKTON

that I am a licensed land surveyor, New York State License No. 046892 and that this map correctly delineates an actual survey on the ground made by me or under my direct supervision, that it was prepared in accordance with the current code of practice for land title surveys adopted by the New York State Association of Professional Land Surveyors; and that I found no visible encroachments either way across property lines except as shown hereon.

Signed: *Michael J. Reagan* Dated: AUG. 29, 2005

"Copyright 2005: All Rights Reserved, Reagan Land Surveying"



09/05/2013 03:08:14 PM

2013-12072

WARRANTY DEED WITH LIEN COVENANT

THIS INDENTURE, made the 5 day of September, Two Thousand Thirteen,

Between RICHARD N. BENNETT, of 47-2 Hickory Street, Old Lyme, Connecticut 06371, and JOYCE A. BENNETT, of 295 Bill George Road, Lansing, New York 14882, parties of the first part, and

AMY NEWMAN of 1125 Trumansburg Road, Ithaca, New York 14850, party of the second part

WITNESSETH, that the parties of the first part, in consideration of One Dollar (\$1.00), lawful money of the United States, and other good and valuable consideration, paid by the party Of the second part, do hereby grant and release unto the party Of the second part, her heirs, distributees and assigns forever,

ALL OF THAT TRACT OR PARCEL OF LAND, situate in the Town of Lansing, County of Tompkins and State of New York, being more particularly bounded and described as follows:

COMMENCING at a point in the easterly boundary of the Norfolk and Southern Railroad right of way which point is located 20 feet more or less on a course having bearings south 48° 42' 40" west from a point in the centerline of Bill George Road 1,122 feet more or less from the intersection of said centerline and the centerline of Swayze Road; thence north 48° 42' 40" east a distance of 120.50 feet to a $\frac{1}{4}$ inch rebar, passing through iron pins set at 32.92 feet and 81.3 feet; thence south 85° 49' 21" east a distance of 70.00 feet to an iron pipe; thence south 48° 42' 40" west a distance of 172.74 feet to a point in the easterly boundary of the Norfolk and Southern Railroad right of way, passing through a pipe set at 53.29 feet and iron pins set at 89.08 feet and 136.67 feet; thence north 37° 40' 26" west a distance of 50.00 feet along the easterly boundary of said right of way to the point or place of beginning.

RESERVING, however, a strip of land from the above described premises 36 feet wide extending easterly from said railroad's east boundary line for right of way purpose as it now exists, the whole width of the premises hereby conveyed.

As part of the consideration herefor, the strip of land between the high water mark of Cayuga Lake and the westerly boundary line of the premises hereby conveyed, including right of way reserve, in case of abandonment to revert to the party of the second part, her heirs, and assigns forever, insofar as the parties of the first have any interest.

RESERVING unto the grantor herein, Joyce A. Bennett, her heirs, successors, assigns, agents and invitees, a pedestrian easement, including but not limited to the right to transport equipment, 10 feet

2013-12072

09/05/2013 03:08:14 PM

in width and 87 feet more or less in length along the southerly boundary of the lands conveyed herein, as described upon the survey map referred to hereinbelow for the benefit of the premises of the grantor known as 295 Bill George Road as described in a deed recorded in the Office of the Tompkins County Clerk as Instrument No. 557083-001.

The above described premises are depicted upon a survey map entitled "RESURVEY MAP - LANDS OF RICHARD N. & JOYCE A. BENNETT," prepared by Michael J. Reagan, L.S., dated August 8, 2013, a copy of which is annexed hereto and intended to be recorded herewith.

BEING the same premises conveyed to the grantors herein by Neil Stockton by deed dated December 2, 2005 and recorded in the Office of the Tompkins County Clerk as Instrument No. 478568-001.

TOGETHER with the appurtenances and all the estate and rights of the parties of the first part in and to said premises,

TO HAVE AND TO HOLD the premises granted unto the party of the second part, her heirs, distributees and assigns forever.

AND said parties of the first part covenant as follows:

FIRST, That the party of the second part shall quietly enjoy the said premises;

SECOND, That said parties of the first part will forever WARRANT the title to said premises.

THIRD, That, in Compliance with Sec. 13 of the Lien Law, the grantors will receive the consideration for this conveyance and will hold the right to receive such consideration as a trust fund to be applied first for the purpose of paying the cost of the improvement and will apply the same first to the payment of the cost of the improvement before using any part of the total of the same for any other purpose.

IN WITNESS WHEREOF, the parties of the first part have hereunto set their hands and seals the day and year above written.

IN PRESENCE OF



RICHARD N. BENNETT (L.S.)



JOYCE A. BENNETT (L.S.)

2013-12072

09/05/2013 03:08:14 PM

STATE OF CONNECTICUT
COUNTY OF

: ss.:

On the 28th day of August in the year 2013, before me, the undersigned, personally appeared RICHARD N. BENNETT, personally known to me or proved to me on the basis of satisfactory evidence to be the individual whose name is subscribed to the within instrument and acknowledged to me that he executed the same in his capacity, and that by his signature on the instrument, the individual, or the person upon behalf of which the individual acted, executed the instrument.

my commission expires:
May 31, 2016

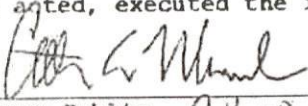
Notary Public

Catherine A. Marchal

STATE OF NEW YORK
COUNTY OF TOMPKINS : ss.:

On the 5 day of September in the year 2013, before me, the undersigned, personally appeared JOYCE A. BENNETT, personally known to me or proved to me on the basis of satisfactory evidence to be the individual whose name is subscribed to the within instrument and acknowledged to me that she executed the same in her capacity, and that by her signature on the instrument, the individual, or the person upon behalf of which the individual acted, executed the instrument.

Notary Public

DIRK A. GALBRAITH
Notary Public, State of New York
No. 55-6444320
Qualified in Tompkins County
Commission Expires May 31, 20 14

NORFOLK SOUTHERN PRIVATE ROAD CROSSING APPLICATION FORM

APPLICANT INFORMATION: Application fee of \$500 is enclosed along with this form (Mail in completed application to: Norfolk Southern Real Estate Department, 1200 Peachtree Street, NE, 12th Floor, Atlanta, GA 30309)

Legal Name of Applicant (party to agreement) AMY NEWMAN + ERIC CLAY Tax ID Not a Corporation

Mailing Street 281 Bill George Rd.
Address

Billing Street Same
Address

Street _____

Street _____

City Lansing

City _____

State NY Zip 14882

State _____ Zip _____

Name of Contact Eric clay

Billing Contact Same

Title co-party

Title _____

Phone # (607) 592-6874 Fax # ()

Phone # () Fax # ()

E-Mail Address wericclay@aol.com

E-Mail Address _____

Applicant is a (Provide state of formation for Corporation and Partnerships, and name of owner for Sole Proprietorship)

- | | |
|--------------------------------------------------------------------|----------------------------------------------------------|
| <input type="checkbox"/> Corporation - State _____ | <input type="checkbox"/> Non-Profit _____ |
| <input type="checkbox"/> Limited Partnership - State _____ | <input checked="" type="checkbox"/> Individual _____ |
| <input type="checkbox"/> Limited Liability Company - State _____ | <input type="checkbox"/> Other (specify) _____ |
| <input type="checkbox"/> Sole Proprietorship / Owner - State _____ | <input type="checkbox"/> Government Entity - State _____ |

CROSSING INFORMATION:

Location of Crossing:

Nearest Town Lansing

County Tompkins

State NY

Railroad Milepost Reference 318 mile ft

North South East West

Nearest Street 281 Bill George Rd.

Lat/Long (if known) _____

Crossing:

to be constructed already exists
DOT No. _____

If already existing:

Are other parties presently using the crossing?

Yes No

If yes, specify: _____

Are there any agreements covering the crossing?

Yes No Do not know

If yes, identify and attach copies: _____

Do improvements have to be made at the crossing?

Yes No

If yes, explain: _____

Crossing to be:

Temporary Permanent

If temporary, when is it to expire? _____

For what purpose is the crossing to be used? Accessing the use of the lake front
from our home.

Type of Crossing:

Commercial Residential Farm

PRIVATE ROAD CROSSING APPLICATION FORM FOR

Legal Name of Applicant (Tenant): Amy Newman / Eric Lay Date: 8/24/2021Crossing to be used by: Pedestrians Vehicles Both

If crossing is to be used by vehicles:

List type of vehicles: _____

What is the expected volume of vehicular traffic? _____ vehicles per Day MonthWhat will be the width of the roadway at the crossing? N/A ft.Will the crossing be open to the public? Yes NoWill the crossing involve an: Overpass Yes NoUnderpass Yes NoParallel Roadway Yes No

List any additional provisions or conditions not mentioned above:

Two sets of ^{wooden} stairs cross the railroad right of way. One set descends from Bill George Rd. from a standard distance from the tracks. Another set descends from a standard distance from the tracks to a platform at the edge of the right of way, and then onto the waterfront.

I/We understand that submission of this application does not authorize use of the private road crossing and that all road crossing agreements are contingent upon Transportation approvals. Fees, charges and other requirements will be forwarded to Applicant after the application has been reviewed and approved by Norfolk Southern.

Signed: Amy Newman / Eric Lay Date: 8/24/2021**For Railroad use only:**

Milepost: _____

Division: _____

DOT/AAR #: _____

Date Received: _____

Date Forwarded: _____

281 Bill George Rd, LANSTING, NY

THE
DRAWN
RED BOXES
SURROUND
STAIRS
CROSSING
THE NS
RIGHT OF
WAY

WE STEP
OVER
THE
TRACKS
AT
POINT
OF
GREEN
MARK

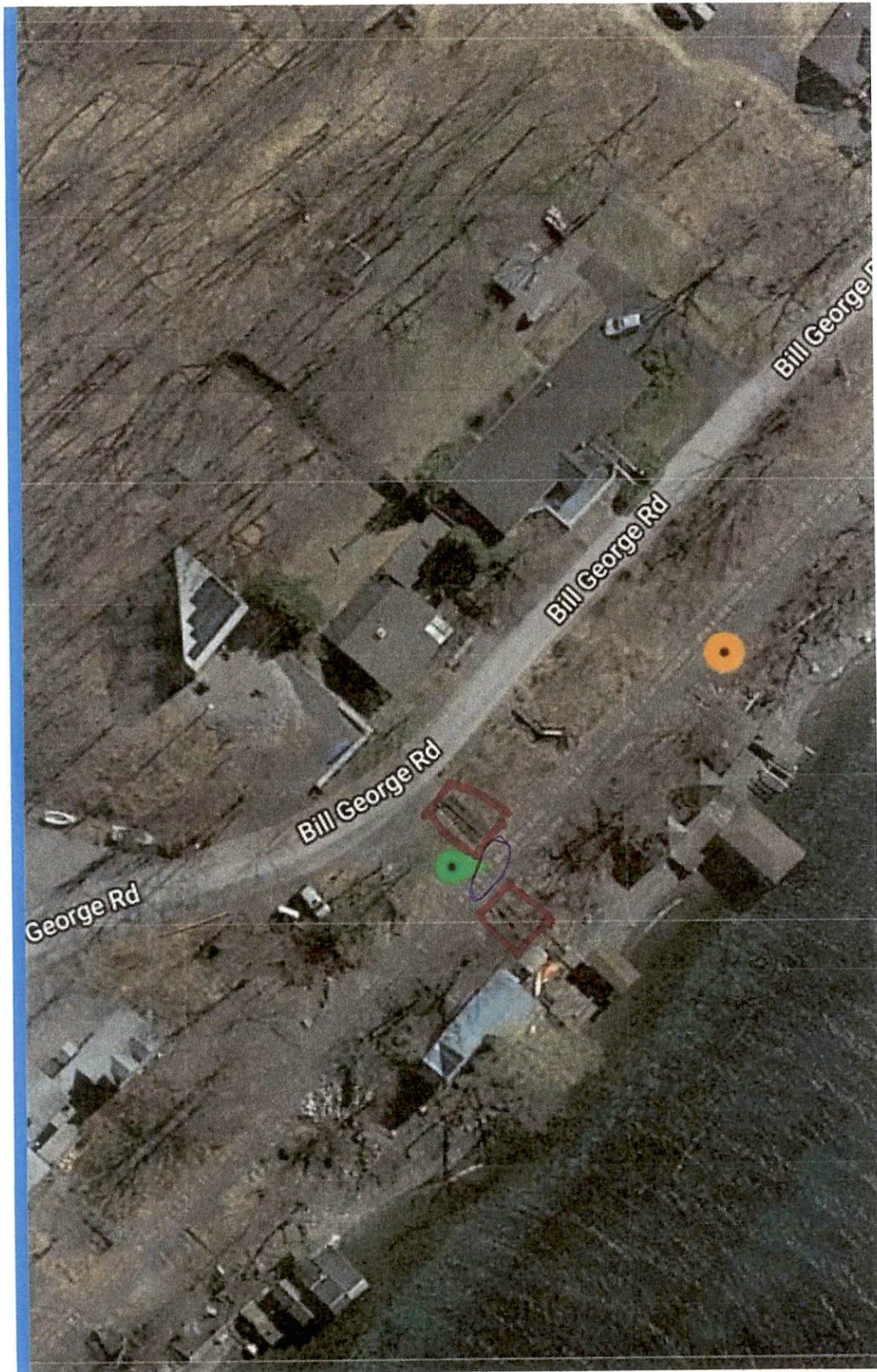

AMY NEWMAN
281 BILL GEORGE RD.
LANSING, NY 14882

50-7039/2213

1043

DATE 8/23/21

PAY TO
THE ORDER OF

Norfolk Southern Corporation \$ 500.00

Five hundred

00
00
DOLLARS



Security Features
Included
Details on Back



Elmira
Savings Bank
The People's Bank
602 W. State St.
Ithaca, NY 14850

MAXIMIZER

MEMO

Crossing application

Amy Newman

MP

⑆221370399⑆ 52 06010117⑈ 01043

SPECIALTY GRAY

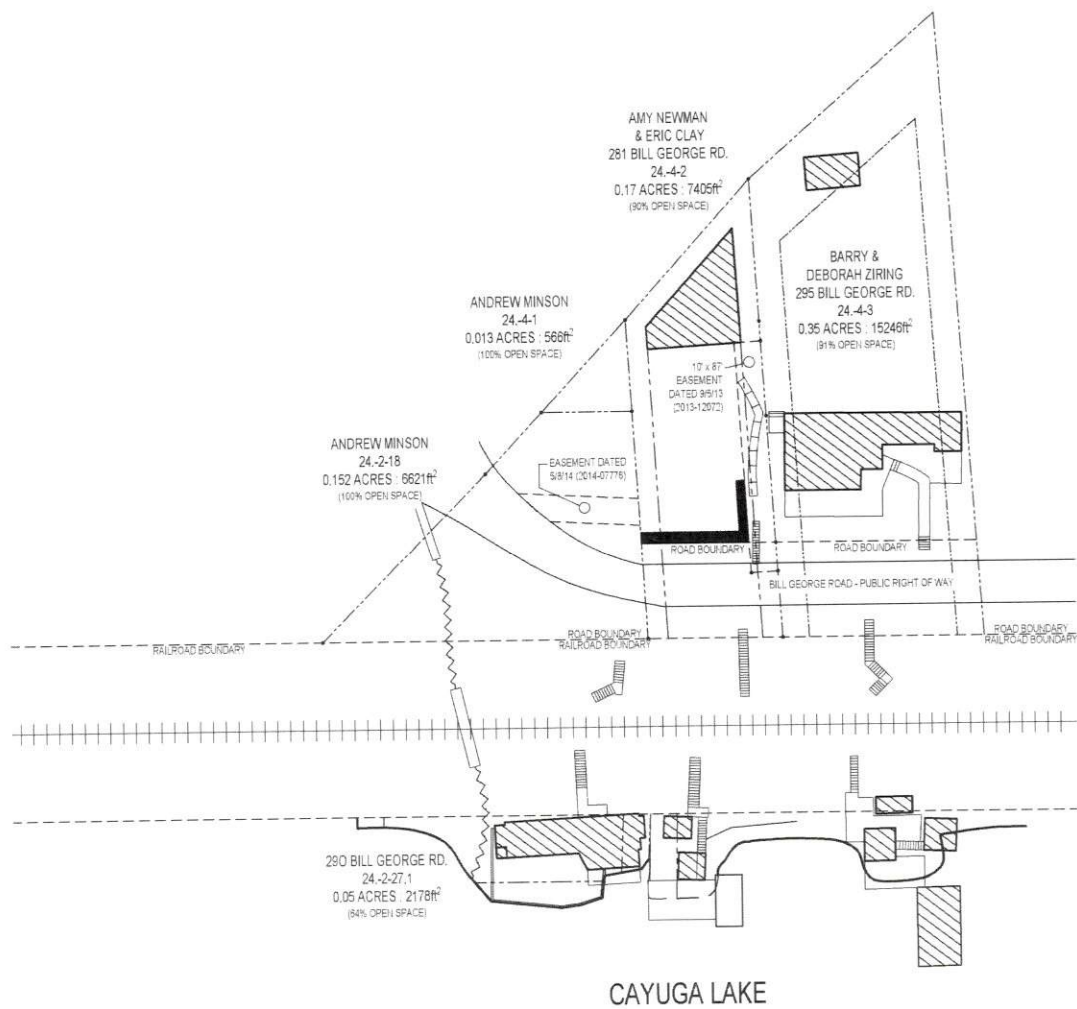

1

PLAN OF IMMEDIATE NEIGHBORHOOD

Scale: 1/32" = 10'



2147 Slaterville Rd
Ithaca, NY 14850
(607) 539-6286

May Strong
May Strong
Ithaca, NY
P&L 1/11/17

Sheet Title: LAKEFRONT NEIGHBORS OF 281 BILL GEORGE

Property Owner: Amy Newman & Eric Clay

Address: 281 Bill George Rd
Lansing, NY 14882

County: Tompkins

Municipality: Town of Lansing

Tax Map No.: 24.-4-2

Job No.: 3282

A101

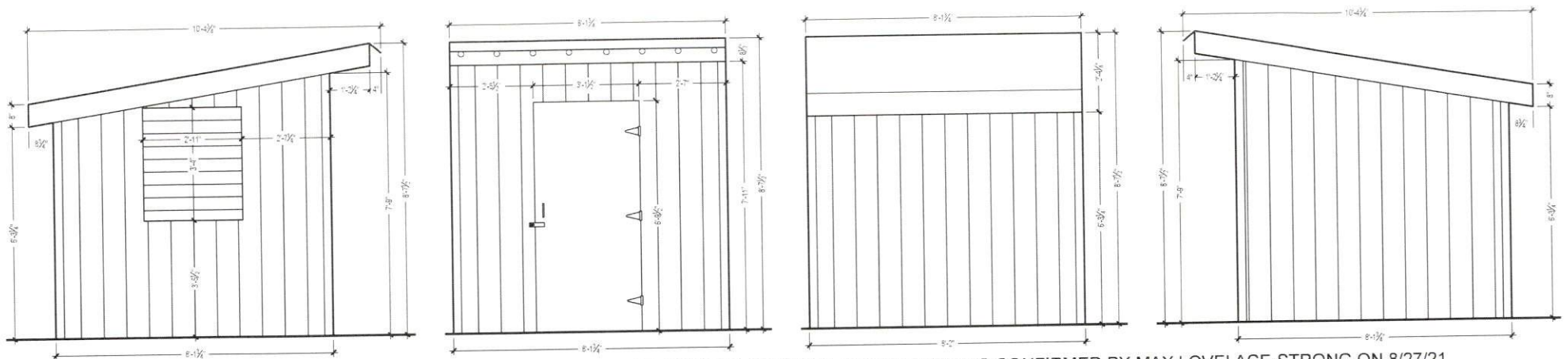

*ORIGINAL MEASUREMENTS OF EXISTING SHED TAKEN BY DEAN SHEA ON 9/8/20; MEASUREMENTS CONFIRMED BY MAY LOVELACE-STRONG ON 8/27/21

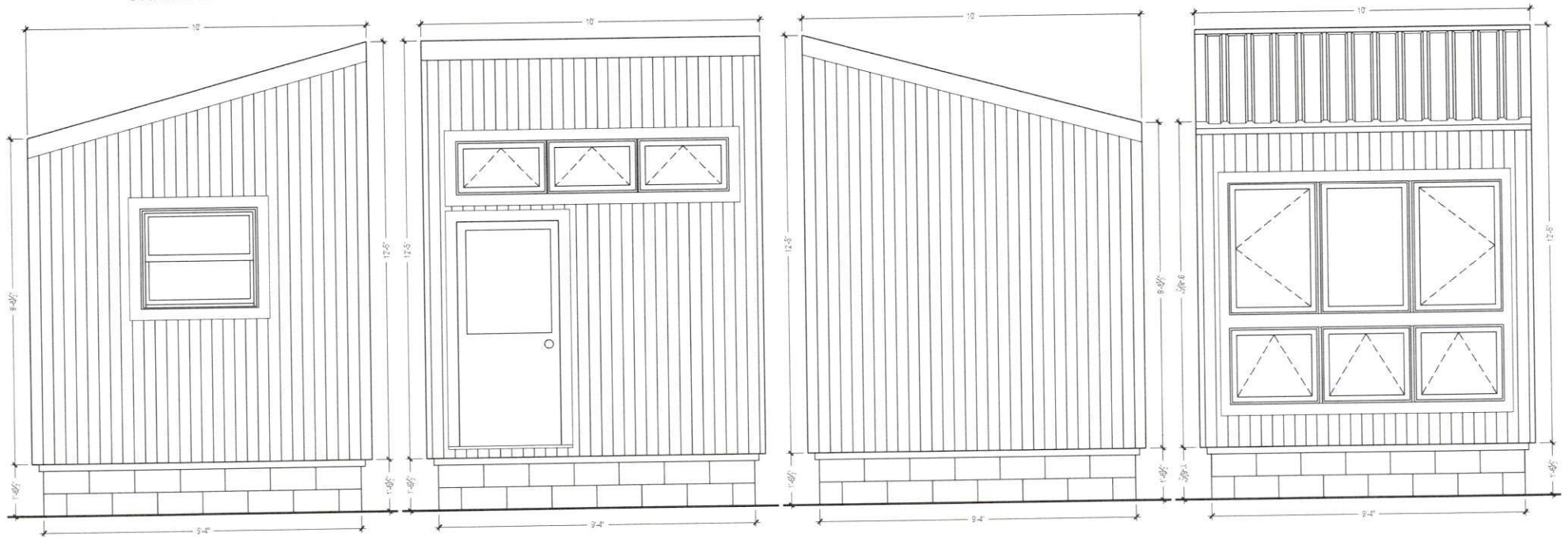

1

EXISTING AND PROPOSED SHED DIMENSIONS

Scale: 1/2" = 1'-0"



2117 Slaterville Rd
Ithaca, NY 14850
(607) 539-6286

May Lovelace Strong
May Lovelace Strong
Architectural Services
www.mls.com

Sheet Title: Diagrams - Existing vs. Proposed Structure
Property Owner: Amy Newman & Eric Clay
Address: 281 Bill George Rd
Lansing, NY 14882

County: Tompkins
Municipality: Town of Lansing
Tax Map No.: 24.-4-2
Job No.: 3282

A601



Upper Portion of Lakefront Access Stairs of 281 Bill George Rd.



Looking down upper stairway to RR Crossing, Lower Access Stairs, and Lake View of 281 Bill George Rd.



Looking down lower portion of Beachfront Access stairs for 281 Bill George Rd.



290 Bill George Rd in relation to shoreline area of 281 Bill George Rd. - Main House of 281 Bill George Rd. shown above.



View of Lakeshore Structure at 295 Bill George Rd from boardwalk of 281 Bill George Rd. on Friday, Aug 27th, 2021.

(August 27, 2021; Lake Level = 384.49ft per NOAA)



View along lakeshore property line between 281 and 290 Bill George Rd. - North edge of concrete pad shown deteriorating.

(August 27, 2021; Lake Level = 384.49ft per NOAA)



Deteriorating southern edge of concrete pad. Timber edging can be seen along righthand edge of rubble and remaining edge is visible past stair edge.

(August 27, 2021; Lake Level = 384.49ft per NOAA; Boardwalk surface = 385.5ft)

Researched Responses to the Neighbors' Concerns:

1: Minimum Lot Area for L1 (w/ Lake Frontage) = 20,000ft² per Dwelling Unit

Due to the historic nature and geographic conditions of the lots located along Bill George Rd., non-compliance in this regard is common. Noted in the chart below 10 of the 18 properties along Bill George Rd listed in the assessment rolls as containing dwelling units are non-compliant as compared to only 8 properties that are compliant. The most extreme example of this issue would be the property located at 290 Bill George Road.

Lot Size by Dwelling Unit

#	Tax Map #	Acreage	Dwelling Units	Sqft/DU
3	24.-1-1	3.62	1	157,687
10	24.-2-2	0.38	1	16,553
180	24.-2-6	0.31	1	13,504
184	24.-2-7.2	0.77	1	33,541
208	24.-2-10	0.35	1	15,246
222	24.-2-11	0.32	1	13,939
236	24.-2-13	0.50	1	21,780
242	24.-2-14	0.32	1	13,939
258	24.-2-15.2	0.49	1	21,344
270	24.-2-16	0.29	1	12,632
278	24.-2-17	0.18	1	7,841
290	24.-2-27.1	0.11	1	4,792
281	24.-4-2	0.22	1	9,583
295	24.-4-3	0.40	1	17,424
303	24.-4-4	0.72	1	31,363
321	24.-5-1.1	1.14	2	24,829
347	24.-5-1.2	12.57	1	547,549
367	24.-5-3	6.03	1	262,667

#N/A: 6
Compliant: 8
Non-Compliant: 10

2: Minimum Road Frontage for L1 (w/ Lake Frontage) = 75ft

The subject property offers only 50ft of road frontage. This issue of non-compliance is a historic condition of the property originating with its creation by deed from Charles W. Sweazey & wf. to Christine R. Inman, recorded on 8/5/39 in Liber 251 Page 311. It is not, however, the most extreme example as quite a number of properties located along the shoreline, such as the property at 290 Bill George Rd, provide no (0ft) road frontage.

3a: Required Side Yard Setback = 10ft and Rear Yard Setback = 25ft – Main House

The main house, constructed in 2013, is situated with a 7.5ft side yard setback on either side and a 7.5ft rear yard setback. When the applicants first purchased the property in 2013 there existed a Manufactured Home that was situated only 8ft from, and roughly parallel to, the rear lot line. This existing home came within 4.5ft and 4.1ft of the shared property line with 295 Bill George Rd, at its closest points, and passed into tax map parcel 24.-4-1 by 3.4ft.

A request for variance on the Side and Rear Yard Setbacks was filed in 2013 and was granted by the Zoning Board at their meeting held November 19, 2013. The Findings of the Board indicated that this action would not create an undesirable change in the neighborhood as it would, in fact, eliminate an existing encroachment and would be “in keeping with structures in the neighborhood”.

Lynn Day, the Zoning Office for the Town of Lansing at the time of that action, indicated that the applicants could build within the existing footprint, if they so chose, but that they were instead attempting to change the foot print in order to stay within their property bounds.

The current main structure is in compliance with the granted 7.5ft side and rear yard setback variance. The unusual footprint of the structure demonstrates the applicants’ diligence to comply with the requests of the Board.

This variance was challenged by a letter dated September 11, 2015 which was discussed at the June 19, 2018 Zoning Board of Appeals meeting. It was concluded that the property was in compliance with the variance granted and that the house did not contribute to the parking issues in the general area.

3b: Required Side Yard Setback = 10ft – Proposed Structure

There currently exists on the lakefront area in question a 9’-10” x 8’-2”¹ wooden storage shed which is located a little over 5’ south of the southern property line of 290 Bill George Rd. If a side yard setback is applied to the section of shoreline in question, approximately half of this existing shed would be located within that side yard setback. Both the original and the modified proposed plans seek to eliminate this issue of non-compliance.

~~3b~~^{3c}: Required Front Yard Setback = 30ft from the Mean High Water Line – Proposed Structure

As the lakefront portion of all properties located along Bill George extend out to the shoreline no more than 35ft from the western boundary of the Norfolk Southern (per Town of Lansing Tax Map #24), this issue of non-compliance applies to all properties that have placed any structures along the shoreline. The most extreme examples of this issue of non-compliance occur at:

- 290 Bill George Road - A 948ft² two-bedroom home has been constructed along the western boundary of the railroad right-of-way extending approximately 26ft out upon a shoreline property that has been artificially stabilized to a lot depth of approximately 35ft. Multiple footers for this building were observed to be located below the water line on August 27, 2021², as well as a balcony and a newly constructed boardwalk that extends over the water.
- 295 Bill George Road – An elaborate complex of wooden stairs, decks, and structures (including a shed, gazebo, and 12’x12’ cabin³) have been constructed upon the steep slope. Despite the fact that a portion of this decking and what appears to be the entirety of the shed encroach into the railroad right of way by approximately 6-7ft, the multiple footers were observed to be below the water line on August 27, 2021².

The newly proposed structure is intended to be located at the front (lake side) edge of the existing concrete pad which has a top surface located 385’-6” at its lowest (undamaged) point. As the existing dock obstructs access to the shoreline west of this edge, we are not aware to what distance the shoreline extends beyond this point (within the limits of the coverage of the dock). By securing this structure to the existing concrete pad at this location we are able to maintain the use of the existing stairway with minimum disruption and with no disruption to the soil along the embankment.

¹ As measured from the roof projections per the NYS Building Code definition of Area, Building]

² Water level on 8/27/21 was 384.49ft per NOAA. Base Flood Elevation equals 385ft per the obtained Flood Elevation Certificate dated 4/12/21.

³ The 12’x12’ enclosed structure located on the lakeshore at 295 Bill George was labeled as an equipment shed on the plans supplied to the building department in 2004 and as a storage room on the certificate of occupancy granted in 2005, however the assessment rolls and the survey completed in 2016 indicate that this is being used as a cabin/bungalow.

4: Intended Use

New York Building Code §202 defines the following...

Accessory Structure - *"A structure that is accessory to and incidental to that of the dwelling(s) "*

Dwelling Unit – *"A single unit providing complete independent living facilities for one or more persons, including permanent provisions for living, sleeping, eating, cooking, sanitation."*

The proposed structure provides no source of heat, potable water, nor restroom facilities. As we are not requesting approval for construction of a "Dwelling Unit" but instead for an "Accessory Structure", as defined by the New York State Building Code, it is not anticipated that we would be receive approval for anything other than an Accessory Structure; therefore approval of this project does not enable such use.

Insulation, air-sealing, and energy efficient windows and doors are vital to providing a stabilized environment for storage of waterfront recreation items such as life preservers which can be damaged by excessive heat and moisture. These measures also serve to deter rodents and other small creatures that might be inclined to seek entry through small openings leading to further equipment damage.

The property owners have been fully honest with the boards about their intention to sit in the structure at times to view the lake.

5: Size of Existing Structure

Specifics regarding the dimensions of the existing structure as well as the intended replacement structure are provided on the included diagram sheet (A601).

6: Lot Size

The size of lot 24.-4-2 (281 Bill George Rd – subject property) is listed as containing ± 0.17 acres. The Tompkins County Assessment department lists this property as containing 0.22 acres. Upon contacting the Assessment Dept. we were informed that they are being Assessed, and taxed, for 0.05 acres of lakeshore. These figures were consolidated by the Assessment Dept. in 2000 and ownership was assumed. The numbers therefore indicate the size of the deeded property (± 0.17 acres) and the size of the assessed property (0.22 acres).



Property Description Report For: 290 Bill George Rd,
Municipality of Lansing

No Photo Available

Status:	Active
Roll Section:	Taxable
Swis:	503289
Tax Map ID #:	24.-2-27.1
Property Class:	210 - 1 Family Res
Site:	RES 1
In Ag. District:	No
Site Property Class:	210 - 1 Family Res
Zoning Code:	L1 - I1
Neighborhood Code:	32040
School District:	Lansing
Total Assessment:	2021 - \$220,000 2020 - \$220,000
Total Acreage/Size:	0.11
Land Assessment:	2021 - \$109,500 2020 - \$109,500
Full Market Value:	2021 - \$220,000 2020 - \$220,000
Equalization Rate:	----
Deed Book:	2018
Grid East:	816722
Property Desc:	
Deed Page:	11691
Grid North:	935631

Area

Living Area:	948 sq. ft.	First Story Area:	777 sq. ft.
Second Story Area:	104 sq. ft.	Half Story Area:	67 sq. ft.
Additional Story Area:	0 sq. ft.	3/4 Story Area:	0 sq. ft.
Finished Basement:	0 sq. ft.	Number of Stories:	1.5
Finished Rec Room	0 sq. ft.	Finished Area Over Garage	0 sq. ft.

Structure

Building Style:	Contemporary	Bathrooms (Full - Half):	1 - 0
Bedrooms:	2	Kitchens:	1
Fireplaces:	0	Basement Type:	Partial
Porch Type:	Porch-open/deck	Porch Area:	132.00
Basement Garage Cap:	0	Attached Garage Cap:	0.00 sq. ft.
Overall Condition:	Normal	Overall Grade:	Economy
Year Built:	1998		

Utilities

Sewer Type:	Private	Water Supply:	Private
Utilities:	Electric	Heat Type:	Hot wtr/stm
Fuel Type:	Propane/LPG	Central Air:	No

Improvements

Structure	Size	Grade	Condition	Year
Porch-open/deck	132.00 sq ft	Average	Normal	1998
Porch-open/deck	392.00 sq ft	Average	Normal	1985
Canpy-roof	280.00 sq ft	Average	Normal	1965

Land Types

Type	Size
Primary	114 × 42

Taxes

Year	Description	Amount
-------------	--------------------	---------------

*** Taxes reflect exemptions, but may not include recent changes in assessment.**



Property Description Report For: 281 Bill George Rd,
Municipality of Lansing

No Photo Available

Total Acreage/Size:	0.22	Status:	Active
Land Assessment:	2021 - \$93,800	Roll Section:	Taxable
	2020 - \$93,800	Swis:	503289
Full Market Value:	2021 - \$475,000	Tax Map ID #:	24.-4-2
	2020 - \$475,000	Property Class:	210 - 1 Family Res
Equalization Rate:	----	Site:	RES 1
Deed Book:	2015	In Ag. District:	No
Grid East:	816790	Site Property Class:	210 - 1 Family Res
		Zoning Code:	L1 - I1
		Neighborhood Code:	32040
		School District:	Lansing
		Total Assessment:	2021 - \$475,000
			2020 - \$475,000
		Property Desc:	
		Deed Page:	12781
		Grid North:	935569

Area

Living Area:	1,837 sq. ft.	First Story Area:	735 sq. ft.
Second Story Area:	735 sq. ft.	Half Story Area:	367 sq. ft.
Additional Story Area:	0 sq. ft.	3/4 Story Area:	0 sq. ft.
Finished Basement:	0 sq. ft.	Number of Stories:	2.5
Finished Rec Room	0 sq. ft.	Finished Area Over Garage	0 sq. ft.

Structure

Building Style:	Contemporary	Bathrooms (Full - Half):	2 - 1
Bedrooms:	2	Kitchens:	1
Fireplaces:	0	Basement Type:	Slab/pier
Porch Type:	0	Porch Area:	0.00
Basement Garage Cap:	0	Attached Garage Cap:	0.00 sq. ft.
Overall Condition:	Good	Overall Grade:	Good
Year Built:	2015		

Utilities

Sewer Type:	Private	Water Supply:	Private
Utilities:	Electric	Heat Type:	Hot air
Fuel Type:	Geothermal heat	Central Air:	Yes

Improvements

Structure	Size	Grade	Condition	Year
Stake dock	14 x 28	Average	Normal	1987
Sol Panels,Elec	8.50 sq ft	Good	Good	2014
Boat shelter	10 x 24	Average	Normal	1987

Land Types

Type	Size
Primary	50 x 192

Taxes

Year	Description	Amount
------	-------------	--------

*** Taxes reflect exemptions, but may not include recent changes in assessment.**



Property Description Report For: 295 Bill George Rd,
Municipality of Lansing

No Photo Available

Total Acreage/Size:	0.40	Status:	Active
Land Assessment:	2021 - \$125,300	Roll Section:	Taxable
	2020 - \$125,300	Swis:	503289
Full Market Value:	2021 - \$380,000	Tax Map ID #:	24.-4-3
	2020 - \$380,000	Property Class:	210 - 1 Family Res
Equalization Rate:	----	Site:	RES 1
Deed Book:	2016	In Ag. District:	Yes
Grid East:	816949	Site Property Class:	210 - 1 Family Res
		Zoning Code:	L1 - I1
		Neighborhood Code:	32040
		School District:	Lansing
		Total Assessment:	2021 - \$380,000
			2020 - \$380,000
		Property Desc:	
		Deed Page:	6234
		Grid North:	935655

Area

Living Area:	1,363 sq. ft.	First Story Area:	1,363 sq. ft.
Second Story Area:	0 sq. ft.	Half Story Area:	0 sq. ft.
Additional Story Area:	0 sq. ft.	3/4 Story Area:	0 sq. ft.
Finished Basement:	0 sq. ft.	Number of Stories:	1
Finished Rec Room	0 sq. ft.	Finished Area Over Garage	0 sq. ft.

Structure

Building Style:	Ranch	Bathrooms (Full - Half):	1 - 0
Bedrooms:	2	Kitchens:	1
Fireplaces:	2	Basement Type:	Crawl
Porch Type:	Porch-open/deck	Porch Area:	460.00
Basement Garage Cap:	0	Attached Garage Cap:	0.00 sq. ft.
Overall Condition:	Good	Overall Grade:	Average
Year Built:	1950		

Utilities

Sewer Type:	Private	Water Supply:	Private
Utilities:	Electric	Heat Type:	Hot wtr/stm
Fuel Type:	Propane/LPG	Central Air:	No

Improvements

Structure	Size	Grade	Condition	Year
Porch-open/deck	460.00 sq ft	Average	Good	1990
Porch-open/deck	10 x 26	Average	Good	2001
Shed-machine	14 x 14	Average	Good	2004
Porch-coverd	90.00 sq ft	Average	Good	2004
Stake dock	0 x 0	Average	Good	2004
Boat shelter	18 x 24	Average	Good	2004
Cabin/bungl	12 x 12	Economy	Normal	2004

Land Types

Type	Size
Primary	77 x 221

Taxes

Year	Description	Amount
------	-------------	--------

*** Taxes reflect exemptions, but may not include recent changes in assessment.**



Property Description Report For: 303 Bill George Rd,
Municipality of Lansing

*no survey map found

No Photo Available

Status:	Active
Roll Section:	Taxable
Swis:	503289
Tax Map ID #:	24.-4-4
Property Class:	210 - 1 Family Res
Site:	RES 1
In Ag. District:	Yes
Site Property Class:	210 - 1 Family Res
Zoning Code:	L1 - I1
Neighborhood Code:	32040
School District:	Lansing
Total Assessment:	2021 - \$420,000 2020 - \$420,000
Total Acreage/Size:	0.72
Land Assessment:	2021 - \$204,800 2020 - \$204,800
Full Market Value:	2021 - \$420,000 2020 - \$420,000
Equalization Rate:	----
Deed Book:	598
Grid East:	817056
Property Desc:	
Deed Page:	1007
Grid North:	935618

Area

Living Area:	1,835 sq. ft.	First Story Area:	1,835 sq. ft.
Second Story Area:	0 sq. ft.	Half Story Area:	0 sq. ft.
Additional Story Area:	0 sq. ft.	3/4 Story Area:	0 sq. ft.
Finished Basement:	0 sq. ft.	Number of Stories:	1
Finished Rec Room:	0 sq. ft.	Finished Area Over Garage:	0 sq. ft.

Structure

Building Style:	Ranch	Bathrooms (Full - Half):	2 - 0
Bedrooms:	2	Kitchens:	1
Fireplaces:	0	Basement Type:	Crawl
Porch Type:	Porch-open/deck	Porch Area:	336.00
Basement Garage Cap:	0	Attached Garage Cap:	576.00 sq. ft.
Overall Condition:	Normal	Overall Grade:	Average
Year Built:	1948		

Utilities

Sewer Type:	Private	Water Supply:	Private
Utilities:	Electric	Heat Type:	Electric
Fuel Type:	Electric	Central Air:	No

Improvements

Structure	Size	Grade	Condition	Year
Porch-open/deck	336.00 sq ft	Average	Normal	1980
Porch-open/deck	80.00 sq ft	Average	Good	1988
Porch-coverd	324.00 sq ft	Average	Good	1989
Gar-1.0 att	576.00 sq ft	Average	Good	1995
Stake dock	0 x 0	Average	Normal	1990

Land Types

Type	Size
Primary	145 x 216

Taxes

Year	Description	Amount
-------------	--------------------	---------------

*** Taxes reflect exemptions, but may not include recent changes in assessment.**



Property Description Report For: 347 Bill George Rd,
Municipality of Lansing

No Photo Available

Total Acreage/Size:	12.57	Status:	Active
Land Assessment:	2021 - \$285,000 2020 - \$285,000	Roll Section:	Taxable
Full Market Value:	2021 - \$490,000 2020 - \$490,000	Swis:	503289
Equalization Rate:	----	Tax Map ID #:	24.-5-1.2
Deed Book:	46202	Property Class:	280 - Res Multiple
Grid East:	817636	Site:	RES 1
		In Ag. District:	Yes
		Site Property Class:	210 - 1 Family Res
		Zoning Code:	L1 - I1
		Neighborhood Code:	32040
		School District:	Lansing
		Total Assessment:	2021 - \$490,000 2020 - \$490,000
		Property Desc:	
		Deed Page:	1001
		Grid North:	935903

Area

Living Area:	1,490 sq. ft.	First Story Area:	1,490 sq. ft.
Second Story Area:	0 sq. ft.	Half Story Area:	0 sq. ft.
Additional Story Area:	0 sq. ft.	3/4 Story Area:	0 sq. ft.
Finished Basement:	0 sq. ft.	Number of Stories:	1
Finished Rec Room	0 sq. ft.	Finished Area Over Garage	0 sq. ft.

Structure

Building Style:	Ranch	Bathrooms (Full - Half):	1 - 0
Bedrooms:	4	Kitchens:	1
Fireplaces:	1	Basement Type:	Full
Porch Type:	0	Porch Area:	0.00
Basement Garage Cap:	1	Attached Garage Cap:	0.00 sq. ft.
Overall Condition:	Normal	Overall Grade:	Economy
Year Built:	1965		

Utilities

Sewer Type:	Private	Water Supply:	Private
Utilities:	Electric	Heat Type:	Hot air
Fuel Type:	Oil	Central Air:	No

Improvements

Structure	Size	Grade	Condition	Year
Shed-machine	24 x 16	Average	Normal	1996
Stake dock	18 x 28	Economy	Normal	2000

Land Types

Type	Size
Primary	250 x 150
Residual	11.21 acres

Taxes

Year	Description	Amount
-------------	--------------------	---------------

*** Taxes reflect exemptions, but may not include recent changes in assessment.**



Property Description Report For: 321 Bill George Rd,
Municipality of Lansing

+ see map for 347

No Photo Available

Status:	Active
Roll Section:	Taxable
Swis:	503289
Tax Map ID #:	24.-5-1.1
Property Class:	220 - 2 Family Res
Site:	RES 1
In Ag. District:	Yes
Site Property Class:	220 - 2 Family Res
Zoning Code:	L1 - I1
Neighborhood Code:	32040
School District:	Lansing
Total Assessment:	2021 - \$500,000 2020 - \$500,000
Total Acreage/Size:	1.14
Land Assessment:	2021 - \$217,800 2020 - \$217,800
Full Market Value:	2021 - \$500,000 2020 - \$500,000
Equalization Rate:	----
Deed Book:	2016
Grid East:	817093
Property Desc:	
Deed Page:	13012
Grid North:	935290

Area

Living Area:	2,424 sq. ft.	First Story Area:	720 sq. ft.
Second Story Area:	1,344 sq. ft.	Half Story Area:	0 sq. ft.
Additional Story Area:	360 sq. ft.	3/4 Story Area:	0 sq. ft.
Finished Basement:	0 sq. ft.	Number of Stories:	2
Finished Rec Room:	0 sq. ft.	Finished Area Over Garage:	0 sq. ft.

Structure

Building Style:	Contemporary	Bathrooms (Full - Half):	3 - 0
Bedrooms:	4	Kitchens:	2
Fireplaces:	0	Basement Type:	Partial
Porch Type:	Porch-open/deck	Porch Area:	72.00
Basement Garage Cap:	0	Attached Garage Cap:	432.00 sq. ft.
Overall Condition:	Good	Overall Grade:	Average
Year Built:	1988		

Utilities

Sewer Type:	Private	Water Supply:	Private
Utilities:	Electric	Heat Type:	Hot wtr/stm
Fuel Type:	Propane/LPG	Central Air:	No

Improvements

Structure	Size	Grade	Condition	Year
Gar-1.0 att	432.00 sq ft	Average	Normal	1988
Porch-open/deck	72.00 sq ft	Average	Normal	1988
Porch-open/deck	400.00 sq ft	Average	Normal	1989
Porch-up opn	80.00 sq ft	Average	Normal	1990
Stake dock	0 x 0	Average	Normal	2000
Boat shelter	0 x 0	Average	Normal	2015

Land Types

Type	Size
Primary	185 x 150
Residual	0.50 acres

Taxes

Year	Description	Amount
-------------	--------------------	---------------

*** Taxes reflect exemptions, but may not include recent changes in assessment.**



Property Description Report For: 367 Bill George Rd,
Municipality of Lansing

No Photo Available

Status:	Active
Roll Section:	Taxable
Swis:	503289
Tax Map ID #:	24.-5-3
Property Class:	210 - 1 Family Res
Site:	RES 1
In Ag. District:	Yes
Site Property Class:	210 - 1 Family Res
Zoning Code:	L1 - I1
Neighborhood Code:	32040
School District:	Lansing
Total Assessment:	2021 - \$410,000 2020 - \$410,000
Total Acreage/Size:	6.03
Land Assessment:	2021 - \$257,400 2020 - \$257,400
Full Market Value:	2021 - \$410,000 2020 - \$410,000
Equalization Rate:	----
Deed Book:	2013
Grid East:	817808
Property Desc:	
Deed Page:	12139
Grid North:	935488

Area

Living Area:	1,408 sq. ft.	First Story Area:	1,408 sq. ft.
Second Story Area:	0 sq. ft.	Half Story Area:	0 sq. ft.
Additional Story Area:	0 sq. ft.	3/4 Story Area:	0 sq. ft.
Finished Basement:	0 sq. ft.	Number of Stories:	1
Finished Rec Room	555 sq. ft.	Finished Area Over Garage	0 sq. ft.

Structure

Building Style:	Ranch	Bathrooms (Full - Half):	2 - 0
Bedrooms:	3	Kitchens:	1
Fireplaces:	0	Basement Type:	Full
Porch Type:	Porch-covered	Porch Area:	49.00
Basement Garage Cap:	0	Attached Garage Cap:	0.00 sq. ft.
Overall Condition:	Normal	Overall Grade:	Average
Year Built:	1961		

Utilities

Sewer Type:	Private	Water Supply:	Private
Utilities:	Electric	Heat Type:	Hot wtr/stm
Fuel Type:	Oil	Central Air:	No

Improvements

Structure	Size	Grade	Condition	Year
Porch-coverd	49.00 sq ft	Average	Normal	1961
Porch-enclsd	66.00 sq ft	Average	Normal	1961

Land Types

Type	Size
Primary	225 x 150
Residual	5.26 acres

Taxes

Year	Description	Amount
-------------	--------------------	---------------

*** Taxes reflect exemptions, but may not include recent changes in assessment.**

Survey Maps and Assessment Reports for properties along Bill George Rd from #290 and southward

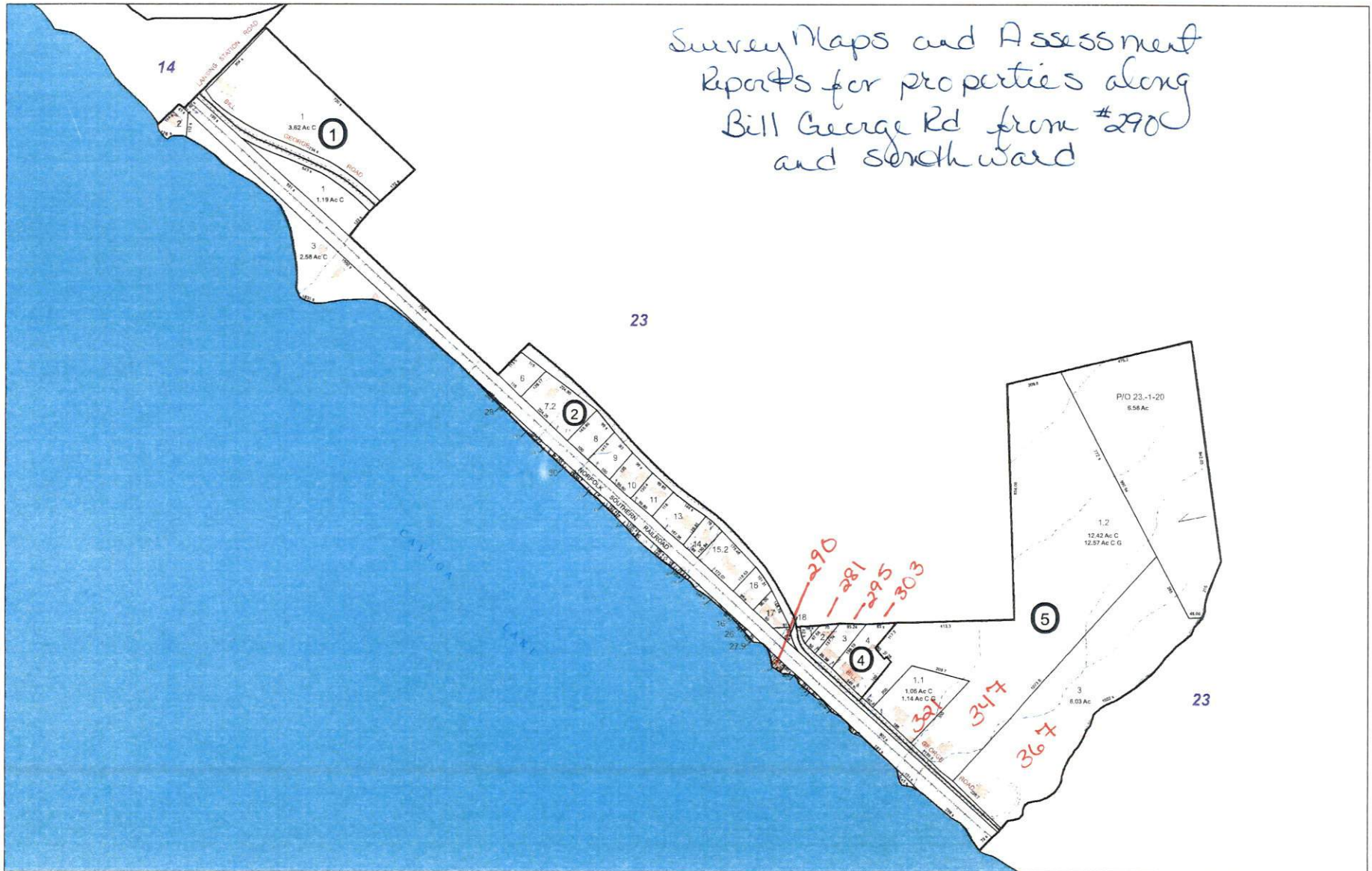

FOR TAX PURPOSES ONLY
NOT TO BE USED FOR CONVEYANCE

This map represents a compilation of geographic and aerial information from 1991 and earlier, a digital planimetry from 1991 and aerial photography from 1991 and earlier. It does not represent a large number of parcels and is not intended to be used as a substitute for a deed or other legal document. The map is not intended to be used as a substitute for a deed or other legal document. For complete legal descriptions of parcels, please refer to the appropriate deed or other legal document.

NOTICE OF DISCLAIMER

This map represents a compilation of geographic and aerial information from 1991 and earlier, a digital planimetry from 1991 and aerial photography from 1991 and earlier. It does not represent a large number of parcels and is not intended to be used as a substitute for a deed or other legal document. The map is not intended to be used as a substitute for a deed or other legal document. For complete legal descriptions of parcels, please refer to the appropriate deed or other legal document.

SPECIAL DISTRICT INFORMATION

Lansing Central School District
Lansing Fire District #1

Building Footprint (1991-2020)
Curb/Pavement Line
Railroad
Hydrography
Special Districts
Municipality
Military Tract/Watkins & Flint Lot Number

LEGEND

Parcel Connector
Property Line
Former Property Line
Curtain Year Changes
Block Limit
External Tax Map
Block Number

43.1 Parcel Lot Number
1.12 Previous Lot Number
A.1 Subdivision Lot Number
9.6 Ac Deed Survey Acreage
2.11 Ac C Computed Acreage
18.90 Ac G Grouped (Total) Acreage
106 Scaled (Calculated) Acreage
1064 Deed Dimension

TOWN OF LANSING
TOMPKINS COUNTY, N.Y.

North
0 25 50 75 100 Feet



MAP: 24
SCALE: 1" = 150'
MAP REVISED: 1-18-17, 5-17-18
MAP PRINTED: 1-18-17, 5-17-18

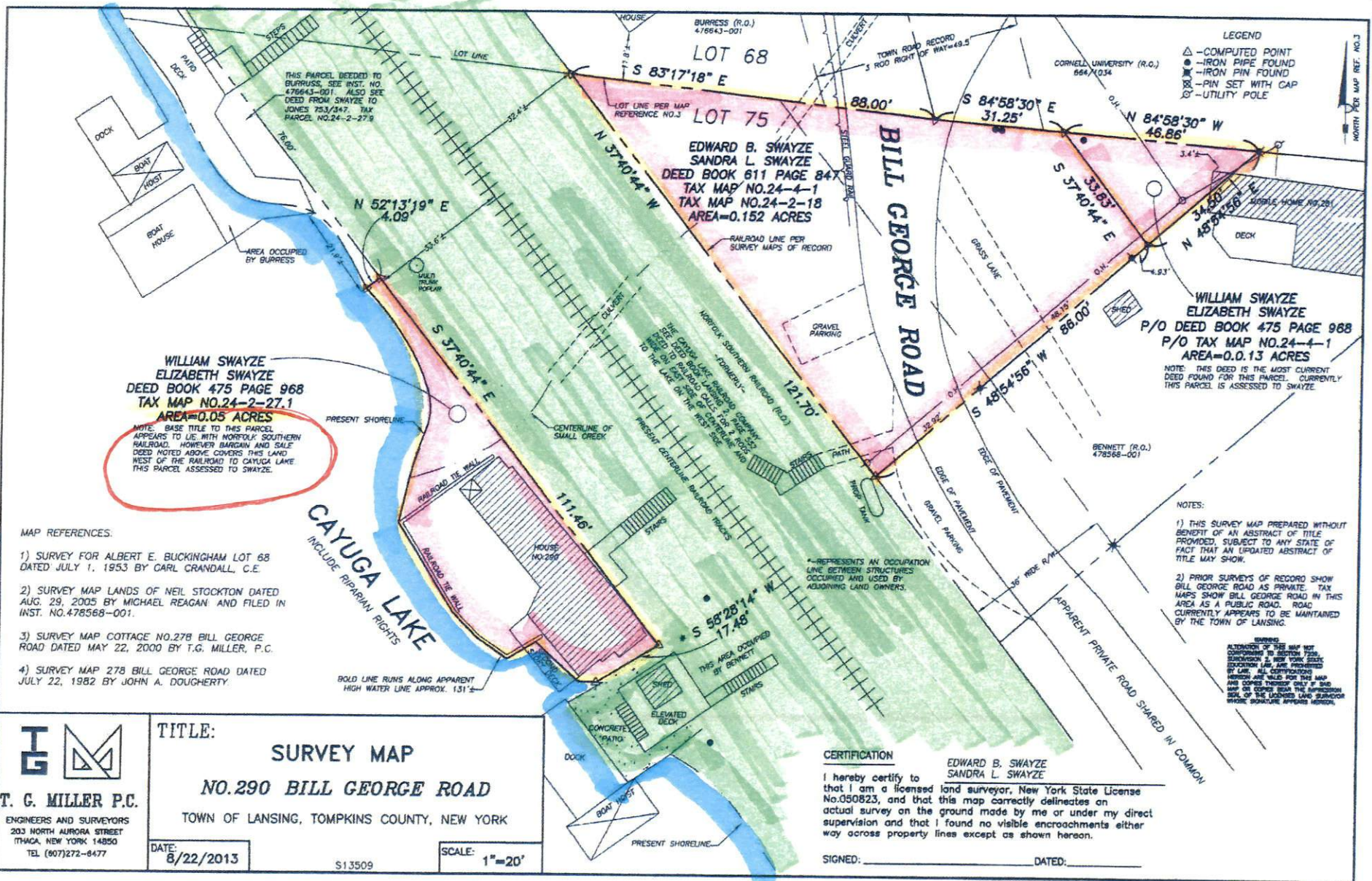

RESURVEY MAP
 ~ LANDS OF ~
 AMY NEWMAN
 MILITARY LOT 75
 TOWN OF LANSING - COUNTY OF TOMPKINS
 STATE OF NEW YORK
 TAX MAP NO. 24-4-0
 REFERENCE DEED INSTRUMENT NO. 2015-12072

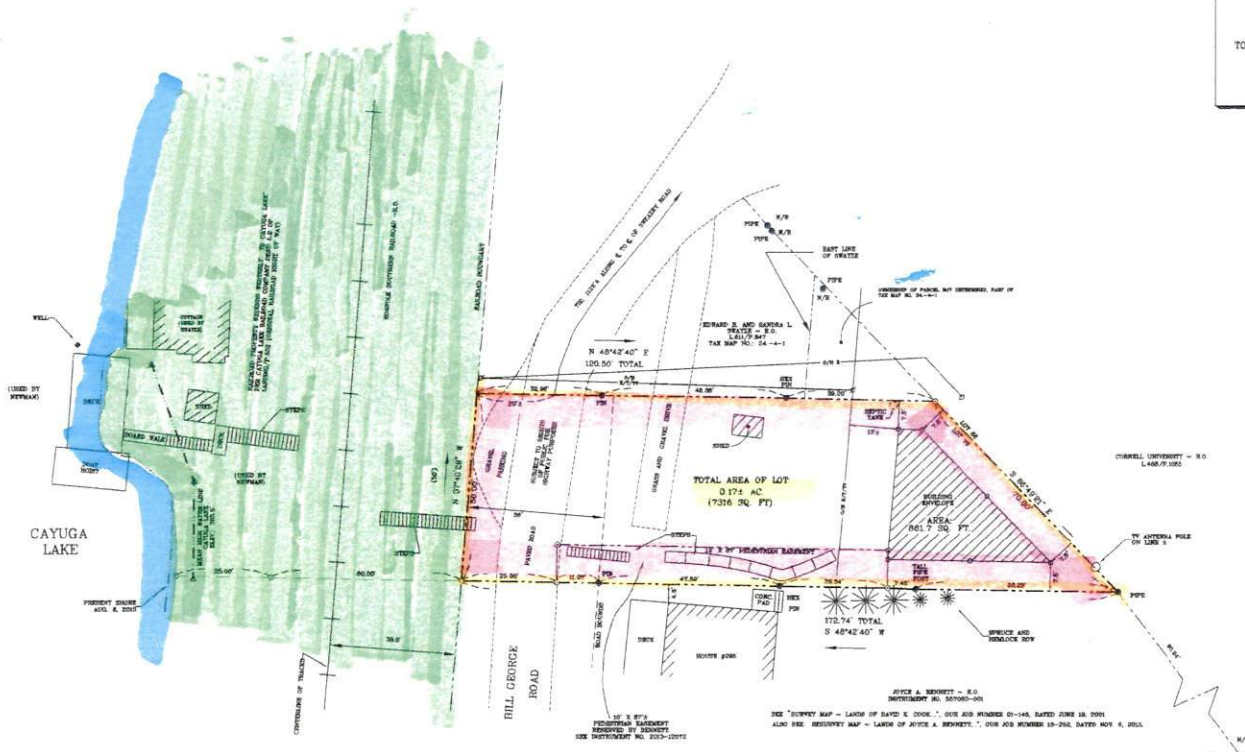

LEGEND:

- EXISTING BORN MONUMENT AS SHOWN
- SET 8/4" BEARING AND SURVEY CAP
- UTILITY POLE
- A.O. RECOVERED CORNER
- (---) RECOVERED DISTANCE
- (---) RECOVERED DISTANCE
- U/W OVERHEAD UTILITY
- U/C UNDERGROUND UTILITY
- PROPERTY CORNER OF PARCELS
- FENCE
- N/W MONUMENT NOT RECOVERED UNDER CURRENT DATE
- SET BUB & TACK ON BUILDING SET BACK LINE PAR. 1. 2014
- △ SET LATH AT FINISH ELEVATION 665.0' (MEAN HIGH WATER ELEVATION OF CAYUGA LAKE)



SEE OUR ORIGINAL VERSION OF THIS MAP DATED 8/29/2005, RESURVEYED AUG. 8, 2015.

REAGAN LAND SURVEYING		DATE	
P.O. Box 120		12/2015	
Pawling, NY 13027		12/2015	
Phone/Fax (518) 544-0207		12/2015	
www.reaganland.com		12/2015	
I hereby certify to: AMY NEWMAN		Scale: 1"=15'	Job No: 13-290

I, the undersigned, being a Licensed Land Surveyor, New York State License No. 046662, and that the map correctly delineates an actual survey on the ground made by me or those under direct supervision, that it was prepared in accordance with the current code of practice for land surveying adopted by the New York State Association of Professional Land Surveyors, and that I find no other inaccuracies other than those specifically noted as above.

Signed: _____ Dated: DEC. 31, 2015
 Copyright 2015. All Rights Reserved, Reagan Land Surveying

RESURVEY MAP ~ LANDS OF
 JOYCE A. BENNETT
 LOT 75
 TOWN OF LANSING ~ COUNTY OF TOMPKINS
 STATE OF NEW YORK
 TAX MAP NO.: 24-4-3
 REFERENCE DEED: INSTRUMENT NO. 557083-001

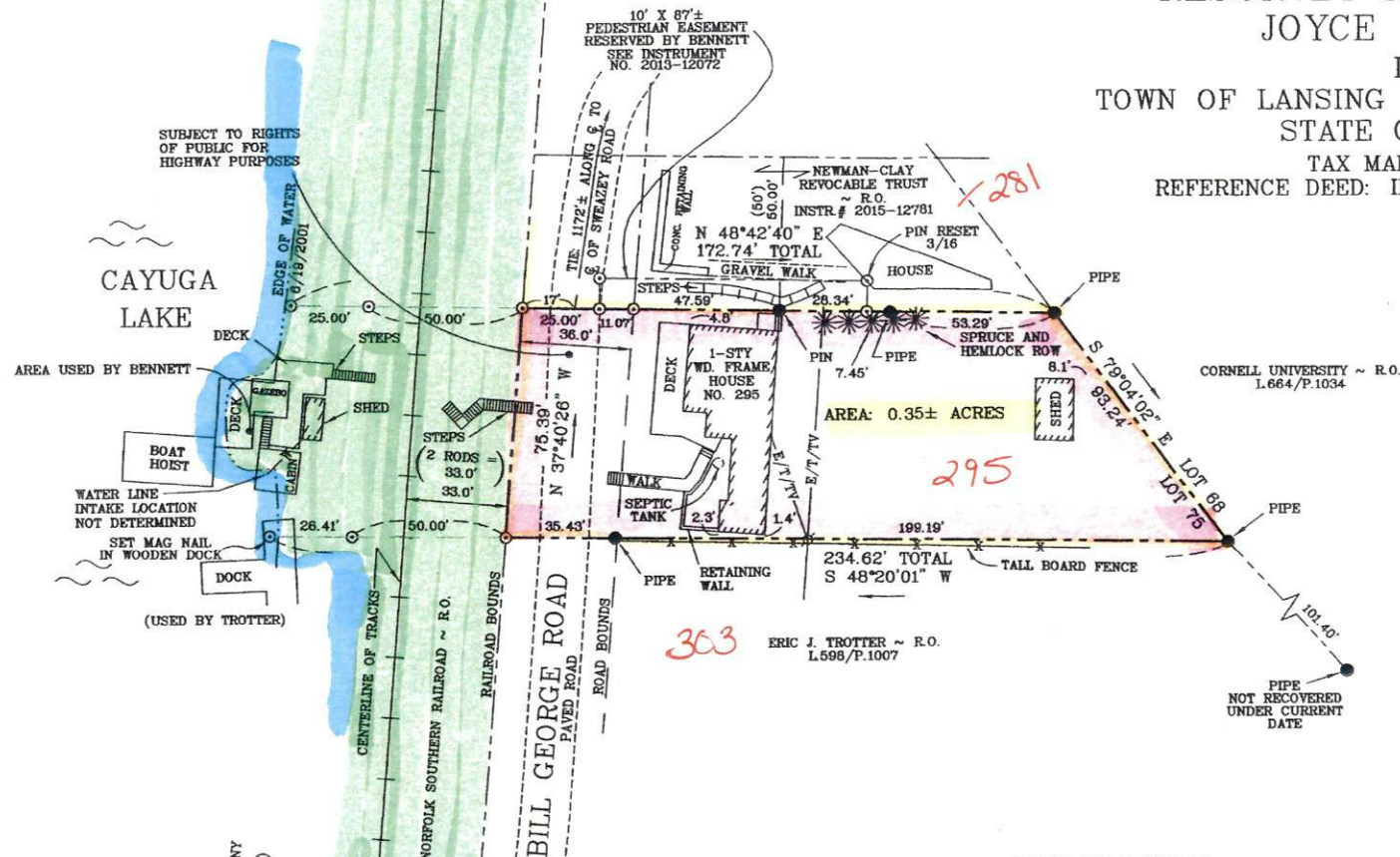

LEGEND:

- EXISTING MONUMENT AS SHOWN
- SET 3/4" REBAR AND SURVEY CAP EXCEPT AS NOTED
- ⊙ UTILITY POLE
- R.O. REPUTED OWNER
- (....) RECORD DISTANCE

DRAWING FILE: 2001146.DWG

REAGAN LAND SURVEYING
 P.O. Box 1124
 Dryden, New York 13053
 Phone/Fax (607) 844-8837

NOTE: Any revisions to this map must comply with section 7209, Subdivision 2 of the New York State Education Law. All certifications hereon are valid for this map and copies thereof only if said map or copies bear the embossed seal of the licensed land surveyor whose signature appears hereon. This map is not valid when used in conjunction with a "Survey Affidavit" or "Certificate of No-Change".

Date Surveyed: 3/2016	Drawn By: A. PUZO	Scale: 1"=40'	Job No.: 16-061
-----------------------	-------------------	---------------	-----------------

I hereby certify to: JOYCE A. BENNETT; CFCU Community Credit Union, its Principals, Successors and/or Assigns, Stewart Title Insurance Company, and Barry Ziring, Deborah J. Ziring, and Sharon M. Sulimowicz, Esq.; MILLER MAYER, LLP that I am a licensed land surveyor, New York State License No. 049892 and that this map correctly delineates an actual survey on the ground made by me or under my direct supervision, that it was prepared in accordance with the current code of practice for land title surveys adopted by the New York State Association of Professional Land Surveyors; and that I found no visible encroachments either way across property lines except as shown hereon.

Signed: *Michael John Reagan* Dated: MARCH 29, 2016
 Copyright 2016: All Rights Reserved, Reagan Land Surveying



NOTE SEE OUR ORIGINAL SURVEY MAP OF THIS LOT DATED JUNE 19, 2001. LAST RESURVEYED NOV. 6, 2013.

PER CAYUGA LAKE RAILROAD COMPANY DEED L.2 OF LANSING/P.552 (ORIGINAL RAILROAD RIGHT OF WAY) RAILROAD PROPERTY EXTENDS WESTERLY TO CAYUGA LAKE

2016-06237

