

CPQ quote: QUO0000009219 Rev: 1

Date & revision: 2023-09-28 rev.0

General exterior with custom paint .....	page 2
Top exterior with custom paint .....	page 3
Curbside exterior .....	page 4
Streetside exterior .....	page 5
Front & rear exterior .....	page 6
Curbside interior wall .....	page 7
Streetside interior wall .....	page 8
Front interior wall .....	page 9
Rear interior wall .....	page 10
Floor view .....	page 11
Ceiling view .....	page 12
Front console .....	page 13
Rear consoles .....	page 14
Floor console details .....	page 15

## DISCLAIMERS

Demers makes every effort to maintain the accuracy and quality of the information provided in these drawings. However, Demers cannot guarantee and assumes no legal liability or responsibility for the accuracy or completeness of the information provided. The information contained in these drawings is for general guidance only. You should always develop your quote and send to Demers for engineering validation to the feasibility of the custom options according to the specific configuration required by the customer.

Should there be any discrepancies between the CPQ configurator, the CPQ quote or sale sheet and these drawings; the CPQ configurator, the CPQ quote or sale sheet will take precedence. These drawings are subject to change by engineering during the construction process of the vehicle. Dimensional data for information only. The copyright of all content in these drawings is owned by Demers and/or the various manufacturers of our equipment. These drawings in part or whole cannot be changed, reproduced, stored in or transmitted onto any website or social media without the prior written consent from Demers.

# MXP170E - Ford F450



# General exterior with custom paint

Date: 2023-09-28 rev.0  
Scale: 1:45  
Draftman: BL

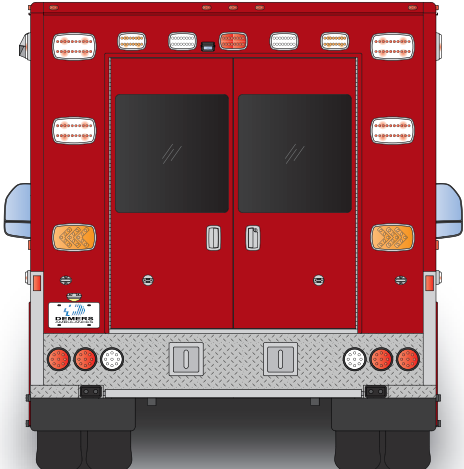

# Top exterior with custom paint

Date: 2023-09-28 rev.0  
Scale: 1:32  
Draftman: BL

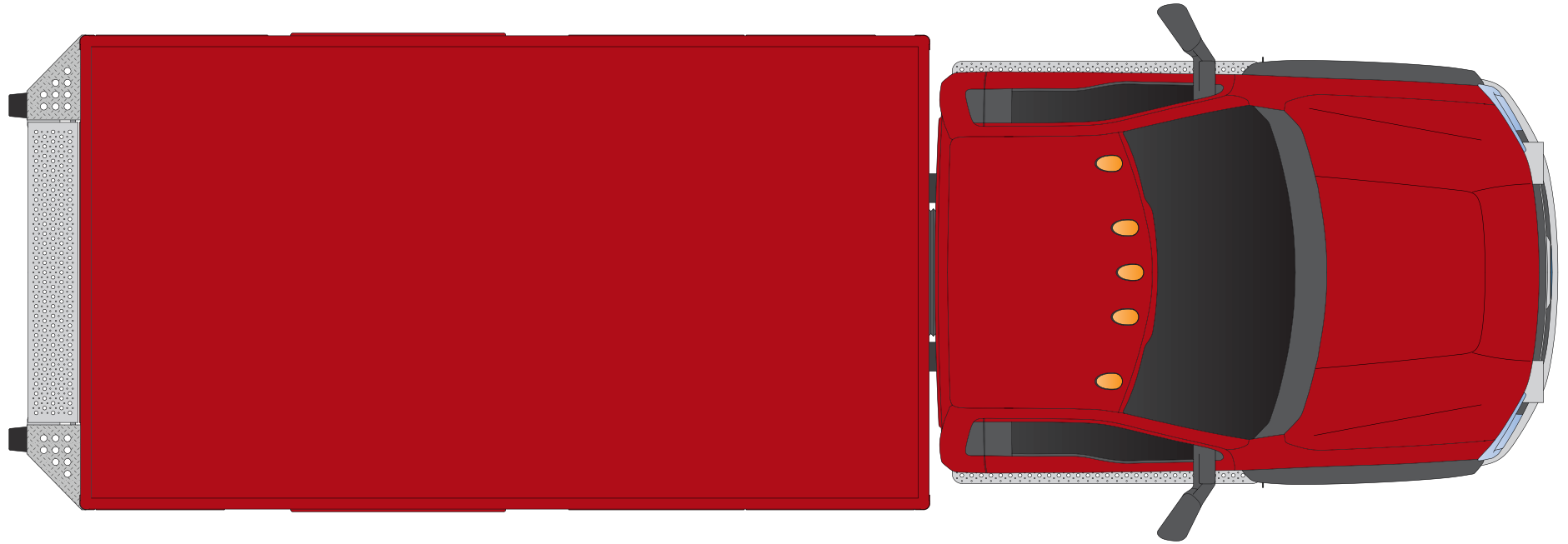

# Curbside exterior

Date: 2023-09-28 rev.0  
 Scale: 1:32  
 Draftman: BL

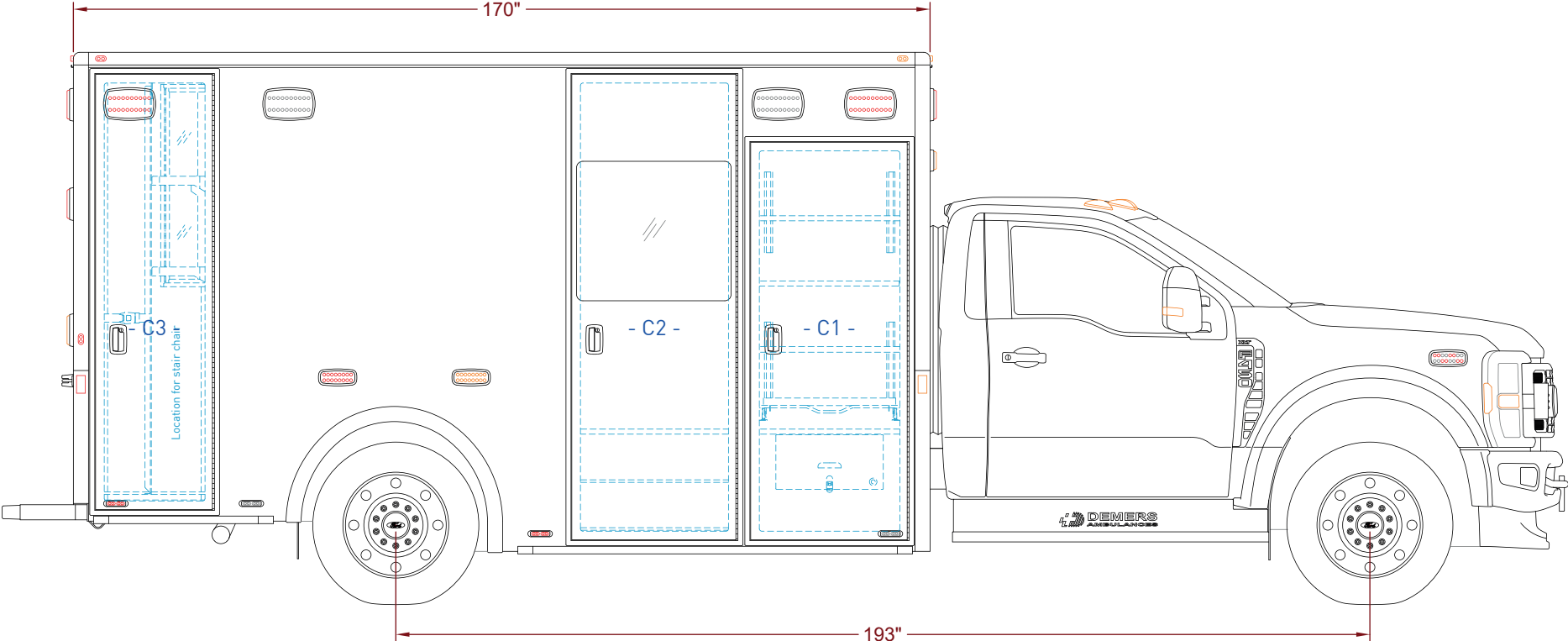

Compartment	Opening L x H	Interior dimensions L x H x D
C1	27.75" x 55.75"	30.25" x 57.25" x 32.00"
C2	29.25" x 88.75"	-
C3	20.00" x 82.75"	20.75" x 84.25" x 18.50"

# Streetside exterior

Date: 2023-09-28 rev.0  
 Scale: 1:32  
 Draftman: BL

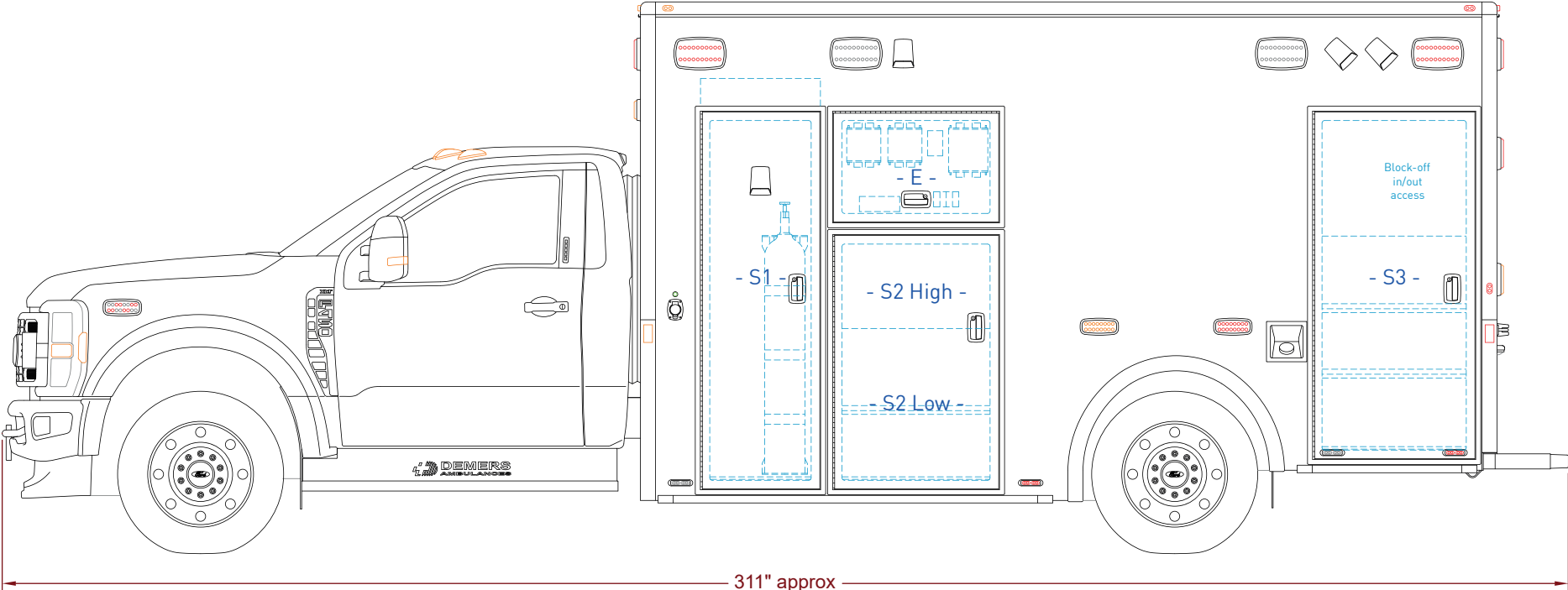

Compartment	Opening L x H	Interior dimensions L x H x D
S1	20.25" x 71.50"	23.75" x 79.50" x 18.00"
S2	29.25" x 47.00"	High: 32.25" x 17.25" x 8.00" Low: 32.25" x 30.00" x 13.50"
S3	28.50" x 65.50"	33.25" x 42.00" x 17.50"
E	29.25" x 18.50"	-

# Front & rear exterior

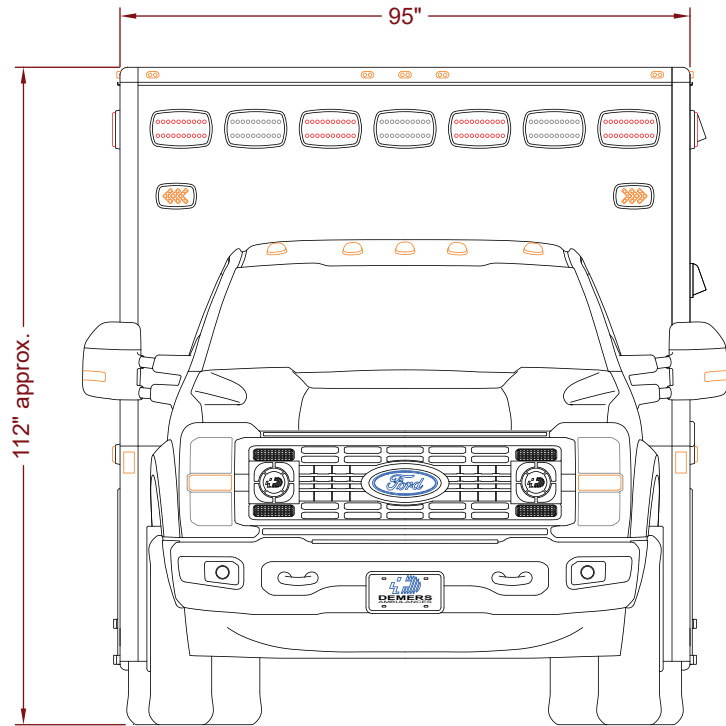

**Note**

The total height of the vehicle can be different according to chassis and suspensions

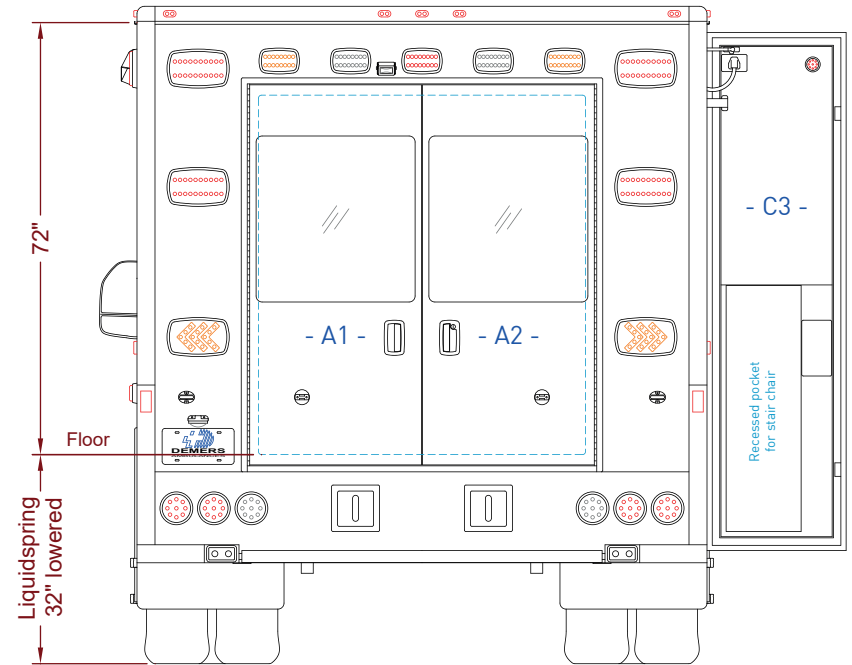

**Note**

The rear loading height of the vehicle can be different according to chassis and suspensions

Compartment	Opening L x H	Interior dimensions L x H x D
A1 & A2	54.50" x 59.75"	-

# Curbside interior wall

Date: 2023-09-28 rev.0  
 Scale: 1:20  
 Draftman: BL

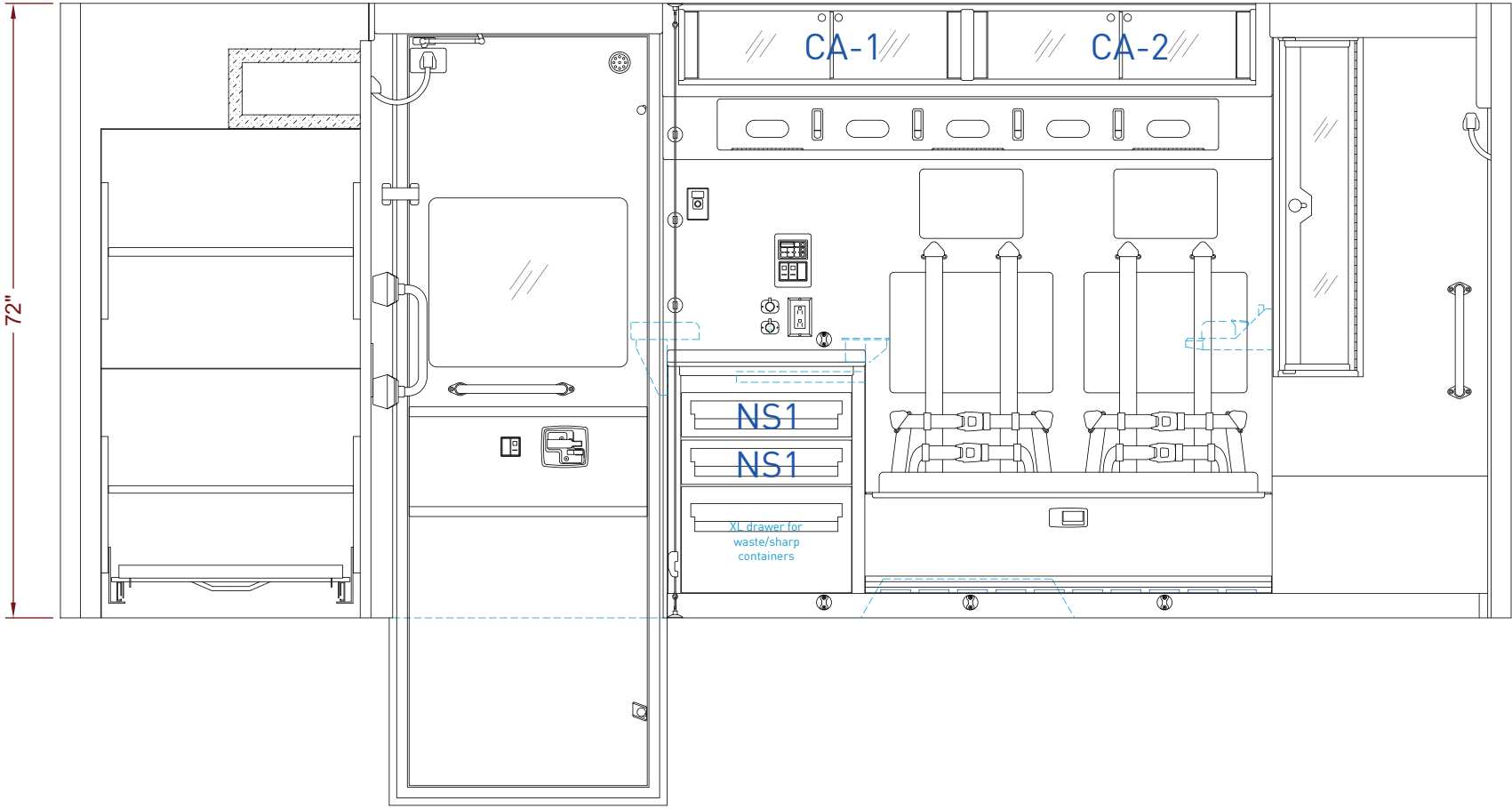

Compartment	Opening L x H	Interior dimensions L x H x D
Storage cabinet -CA-	32.25" x 8.00"	33.50" x 9.50" x 9.25"
Storage drawer -NS1-	-	17.00" x 4.00" x 18.00"

# Streetside interior wall

Date: 2023-09-28 rev.0  
 Scale: 1:20  
 Draftman: BL

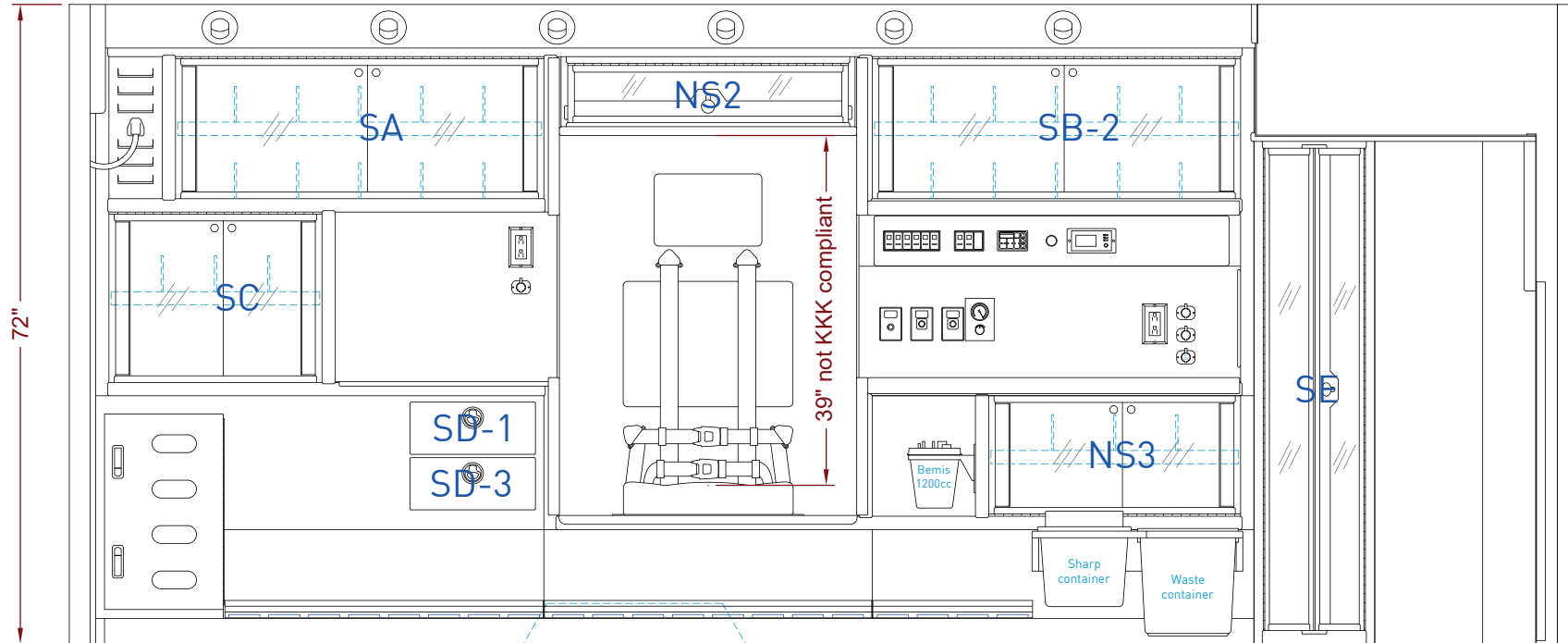

Compartment	Opening L x H	Interior dimensions L x H x D	Compartment	Opening L x H	Interior dimensions L x H x D
Storage cabinet -SA-	41.50" x 16.00"	42.50" x 16.75" x 16.00"	Storage drawer -SD-	-	12.00" x 4.50" x 12.50"
Storage cabinet -NS2-	31.50" x 6.75"	32.00" x 8.00" x 6.00"	Storage cabinet -NS3-	28.25" x 13.50"	29.25" x 14.75" x 11.00"
Storage cabinet -SB-	41.50" x 16.00"	41.75" x 16.25" x 11.00"	Storage cabinet -SE-	16.50" x 54.25"	*25.50" x 57.25" x *15.75"
Storage cabinet -SC-	24.00" x 19.25"	25.00" x 20.25" x 16.00"			

\*The provided dimension is the maximum possible due to the angular configuration of the cabinet.



# Front interior wall

Date: 2023-09-28 rev.0  
 Scale: 1:20  
 Draftman: BL

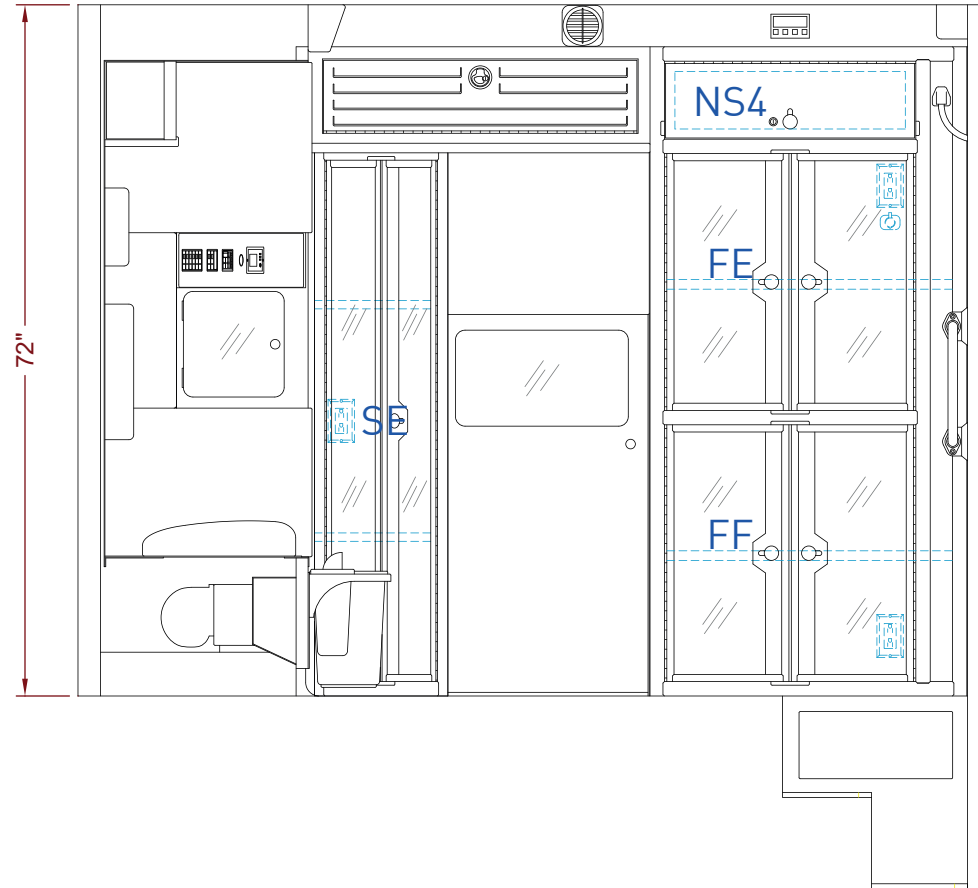

Compartment	Opening L x H	Interior dimensions L x H x D
Heated comp. -NS4-	26.00" x 8.00"	24.00" x 6.00" x 13.75"
High ALS comp. -FE-	26.00" x 26.75"	32.00" x 28.00" x 30.25"
Low ALS comp. -FF-	26.00" x 26.75"	32.00" x 29.25" x 30.25"

# Rear interior wall

Date: 2023-09-28 rev.0  
Scale: 1:20  
Draftman: BL

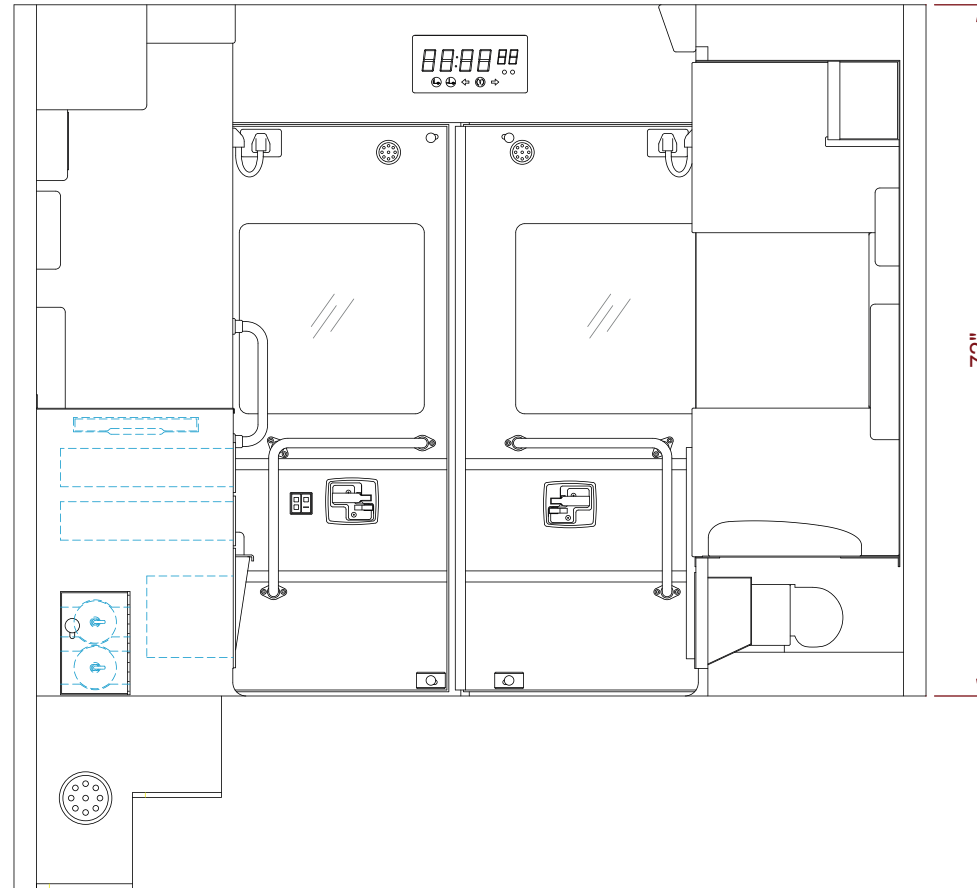

# Floor view

Date: 2023-09-28 rev.0  
Scale: 1:32  
Draftman: BL

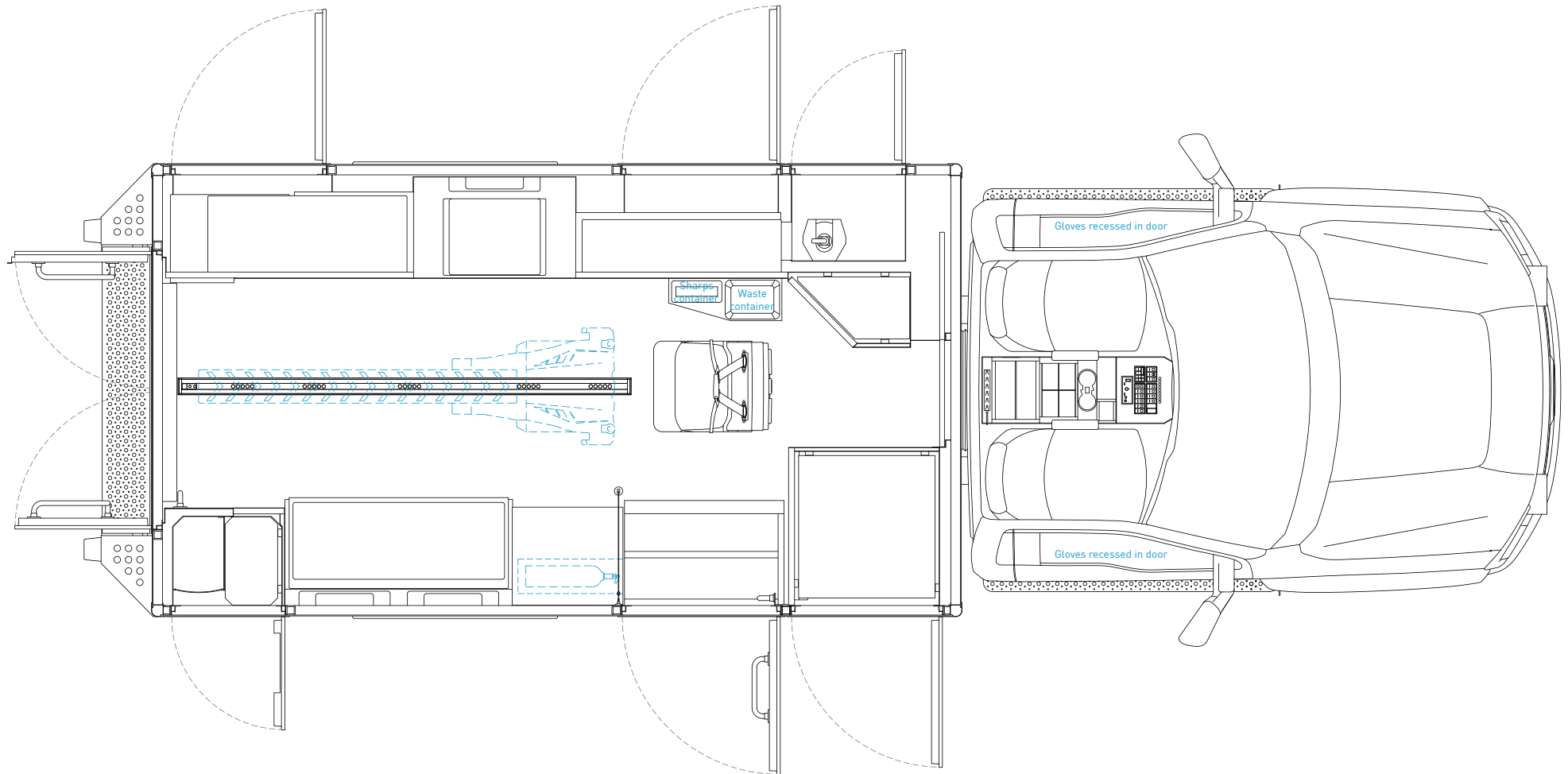

# Ceiling view

Date: 2023-09-28 rev.0  
Scale: 1:32  
Draftman: BL

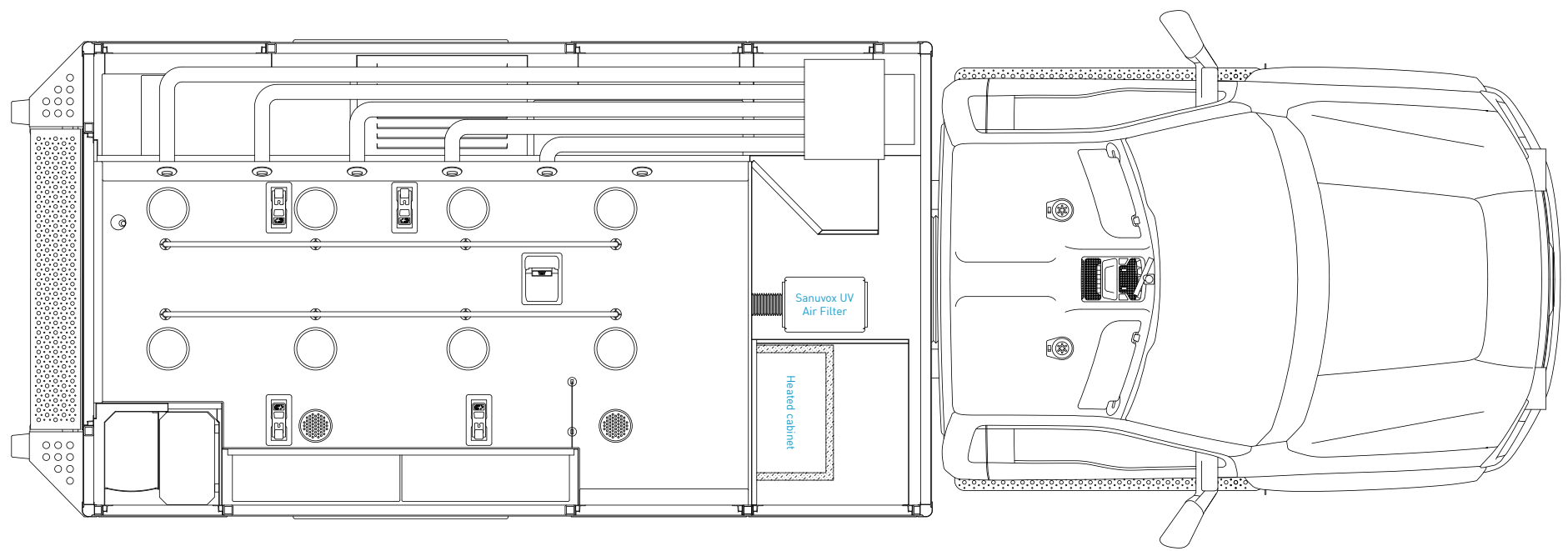

# Front console

Date: 2023-09-28 rev.0  
Scale: 1:3  
Draftman: BL

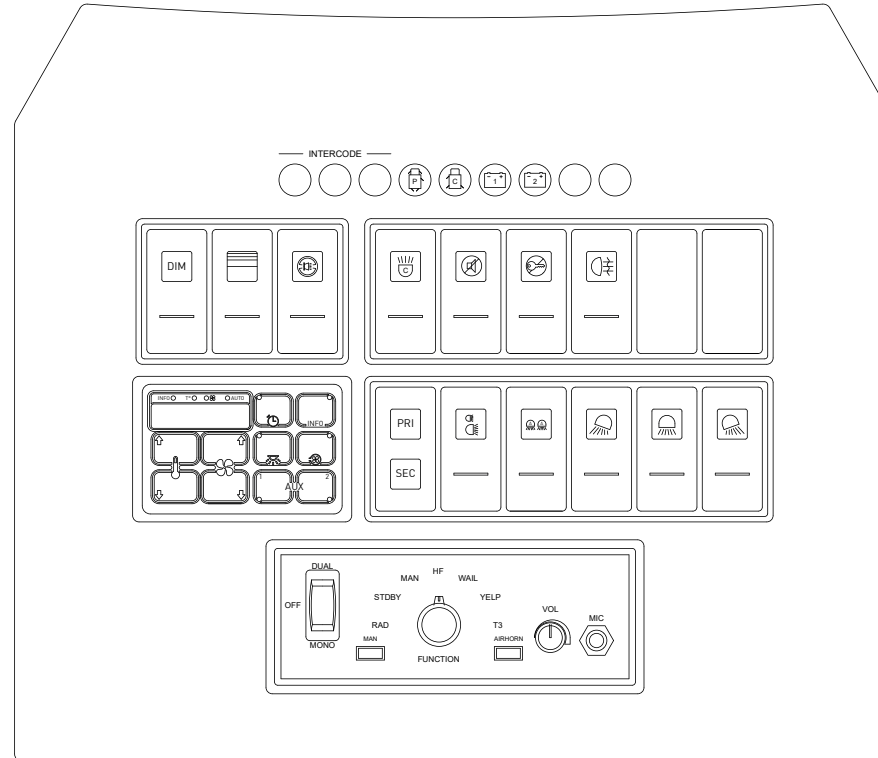

## Streetside console

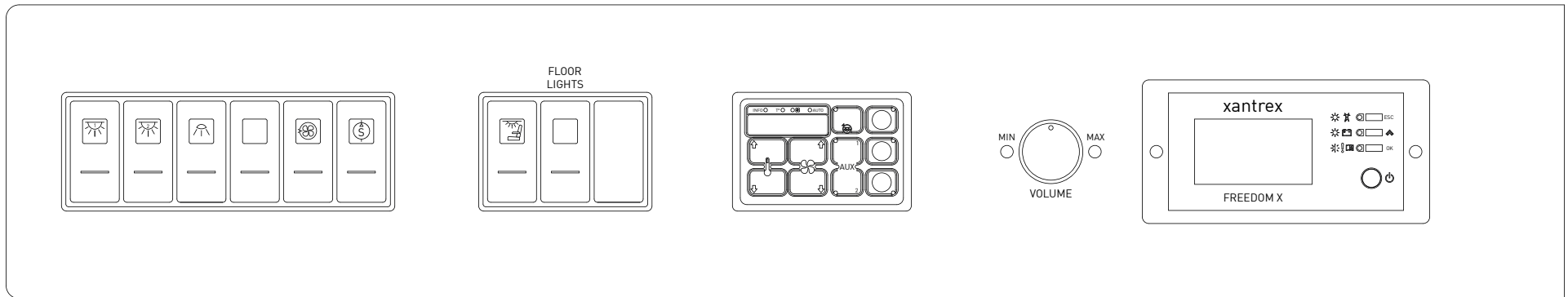

## Curbside console

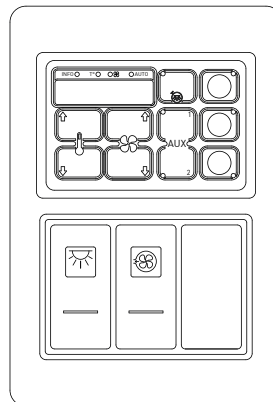

# Floor console details

Date: 2023-09-28 rev.0  
Scale: 1:7  
Draftman: BL

Top view

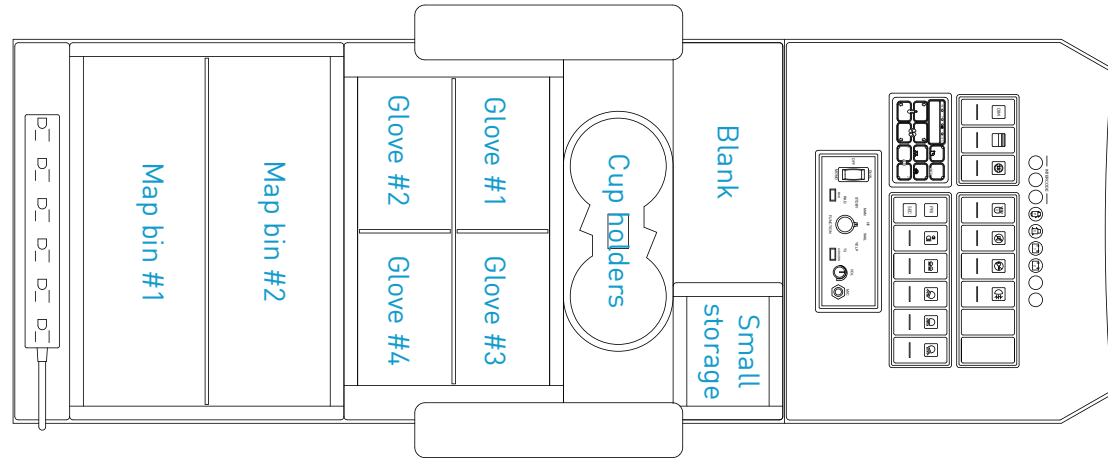

Side view

