

THIS DESIGN CONCEPT AND DRAWING HAVE BEEN PREPARED EXCLUSIVELY FOR INTERNAL USE OF WORKSPACE INTERIORS AND THE CUSTOMER NAMED. THE DRAWING AND ANY DOCUMENTS RELATED TO IT REMAIN THE EXCLUSIVE PROPERTY OF WORKSPACE INTERIORS. NO PART OF THIS DRAWING OR PROPOSAL MAY BE REPRODUCED OR DISTRIBUTED WITHOUT THE WRITTEN CONSENT OF WORKSPACE INTERIORS. THESE DRAWINGS ARE NOT ARCHITECTURAL PLANS. THEY DO NOT CONTAIN DETAILS NECESSARY FOR CONSTRUCTION. SHOULD YOU REQUIRE A COMPLETE SET OF ARCHITECTURAL PLANS, WORKSPACE INTERIORS WILL WORK WITH THE ARCHITECT TO DEVELOP THEM.

workspace interiors
design solutions
www.workspaceinteriors.com

TRICITIES, TN
200 e main street
suite 300
kingsport tn 37660
p. 423.352.2600
f. 423.352.2601

KNOXVILLE, TN
2820 middlebrook pike
suite 104
knoxville tn 37921
p. 865.223.5404
f. 865.223.5405

Finance Department - Level 1

City of Kingsport

415 Broad Street
Kingsport, TN

DRAWN BY	PROJ MGR
LW	RS
ORIGINAL	10.26.23
LAST	11.07.23
SCAL	1/16 " = 1'-0"

FF-1

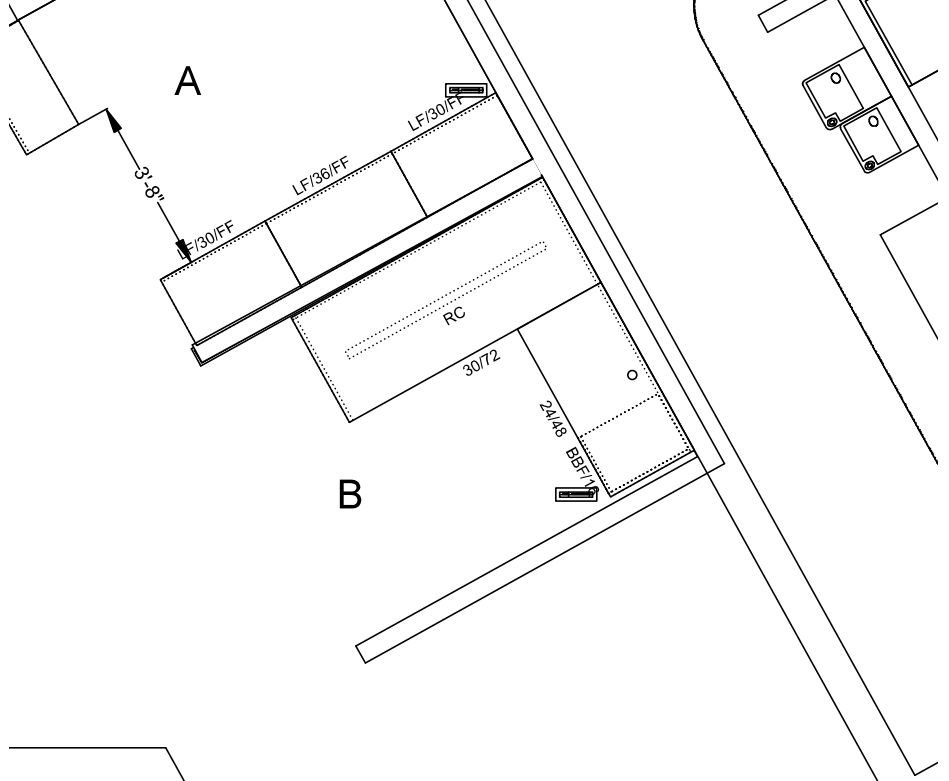
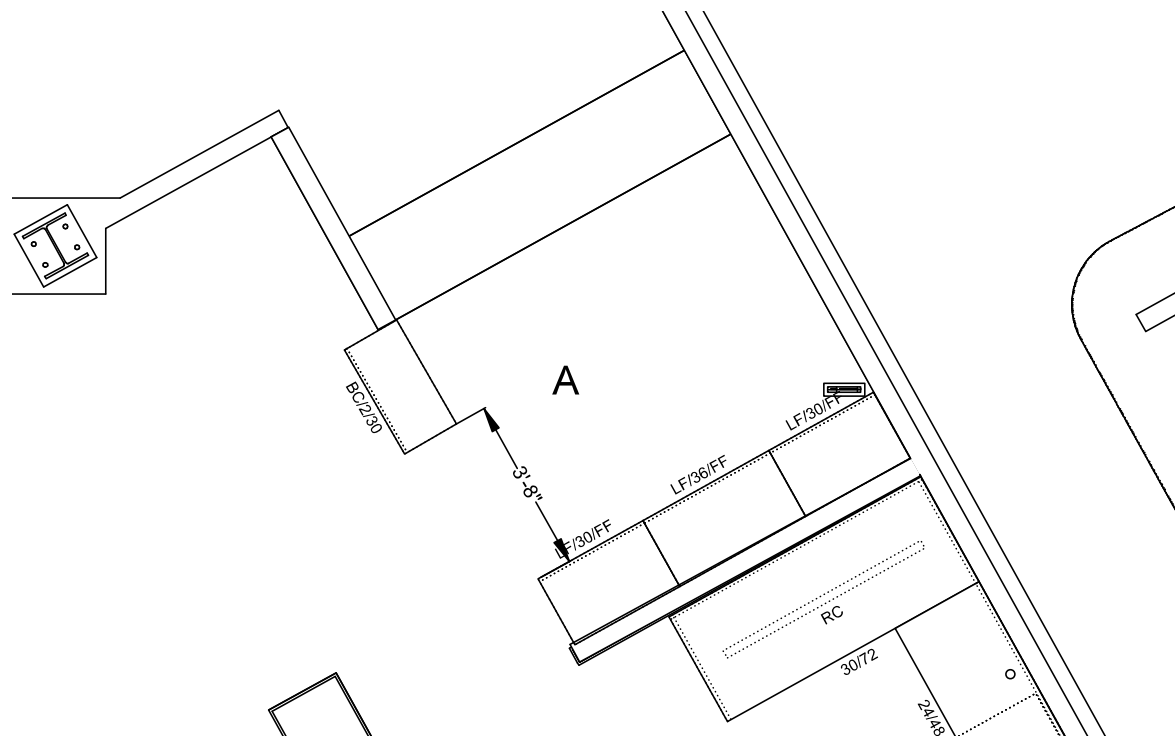

Area A



Area B

THIS DESIGN CONCEPT AND DRAWING HAVE BEEN PREPARED EXCLUSIVELY FOR INTERNAL USE OF WORKSPACE INTERIORS AND THE CUSTOMER NAMED. THE DRAWING AND ANY DOCUMENTS RELATED TO IT REMAIN THE EXCLUSIVE PROPERTY OF WORKSPACE INTERIORS. NO PART OF THIS DRAWING OR PROPOSAL MAY BE REPRODUCED AND OR DISTRIBUTED WITHOUT THE WRITTEN CONSENT OF WORKSPACE INTERIORS. THESE DRAWINGS ARE NOT ARCHITECTURAL PLANS. THEY DO NOT CONTAIN DETAILS NECESSARY FOR CONSTRUCTION. SHOULD YOU REQUIRE A COMPLETE SET OF ARCHITECTURAL PLANS, WORKSPACE INTERIORS WILL WORK WITH THE ARCHITECT TO DEVELOP THEM.

Finance Department - Level 1 - Areas A and B

City of Kingsport

415 Broad Street
Kingsport, TN

DRAWN BY	PROJ MGR
LW	RS
ORIGINAL	10.26.23
LAST	11.07.23
SCAL	1/4"=1'-0"

FF-2

workspace interiors
design solutions
www.workspaceinteriors.com

TRI-CITIES, TN
200 e main street
suite 300
kingsport tn 37660
p. 423.392.2600
f. 423.392.2601

KNOXVILLE, TN
2820 middlebrook pike
suite 104
knoxville tn 37921
p. 865.223.5404
f. 865.223.5405

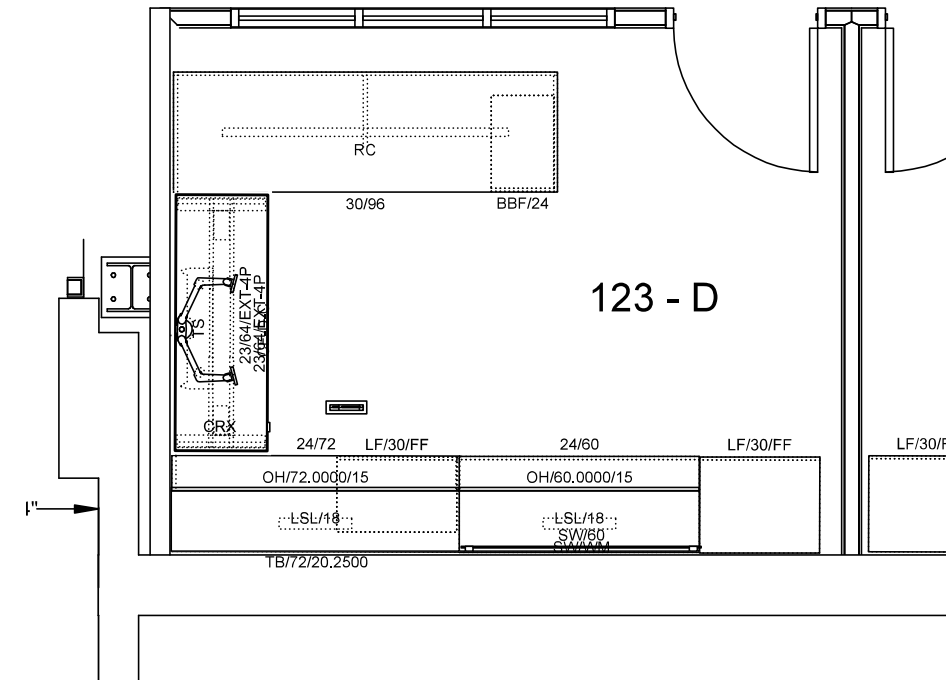
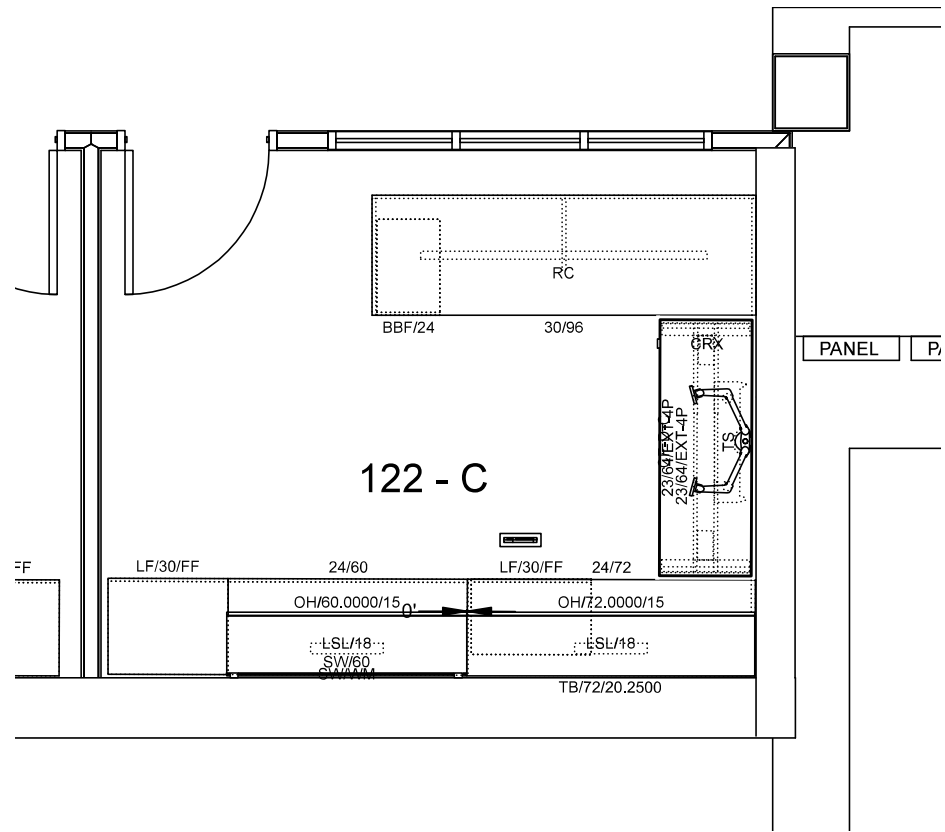

Area C - Office 122



Area D - Office 123

THIS DESIGN CONCEPT AND DRAWING HAVE BEEN PREPARED EXCLUSIVELY FOR INTERNAL USE OF WORKSPACE INTERIORS AND THE CUSTOMER NAMED. THE DRAWING AND ANY DOCUMENTS RELATED TO IT REMAIN THE EXCLUSIVE PROPERTY OF WORKSPACE INTERIORS. NO PART OF THIS DRAWING OR PROPOSAL MAY BE REPRODUCED AND OR DISTRIBUTED WITHOUT THE WRITTEN CONSENT OF WORKSPACE INTERIORS. THESE DRAWINGS ARE NOT ARCHITECTURAL PLANS. THEY DO NOT CONTAIN DETAILS NECESSARY FOR CONSTRUCTION. SHOULD YOU REQUIRE A COMPLETE SET OF ARCHITECTURAL PLANS, WORKSPACE INTERIORS WILL WORK WITH THE ARCHITECT TO DEVELOP THEM.

Finance Department - Level 1 - Areas C and D

City of Kingsport

415 Broad Street
Kingsport, TN

workspace interiors
design solutions
www.workspaceinteriors.com

TRI-CITIES, TN
200 e main street
suite 300
kingsport tn 37660
p. 423.352.2600
f. 423.352.2601
KNOXVILLE, TN
2820 middlebrook pike
suite 104
knoxville tn 37921
p. 865.223.5404
f. 865.223.5405

DRAWN BY	PROJ MGR
LW	RS
ORIGINAL	10.26.23
LAST	11.07.23
SCAL	1/4"=1'-0"

FF-3

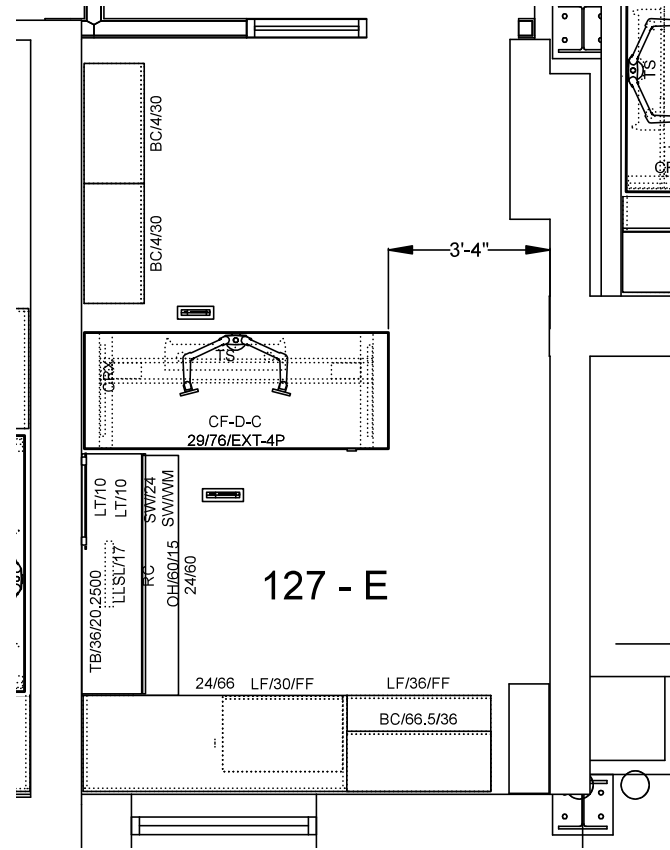

Area E - Office 127

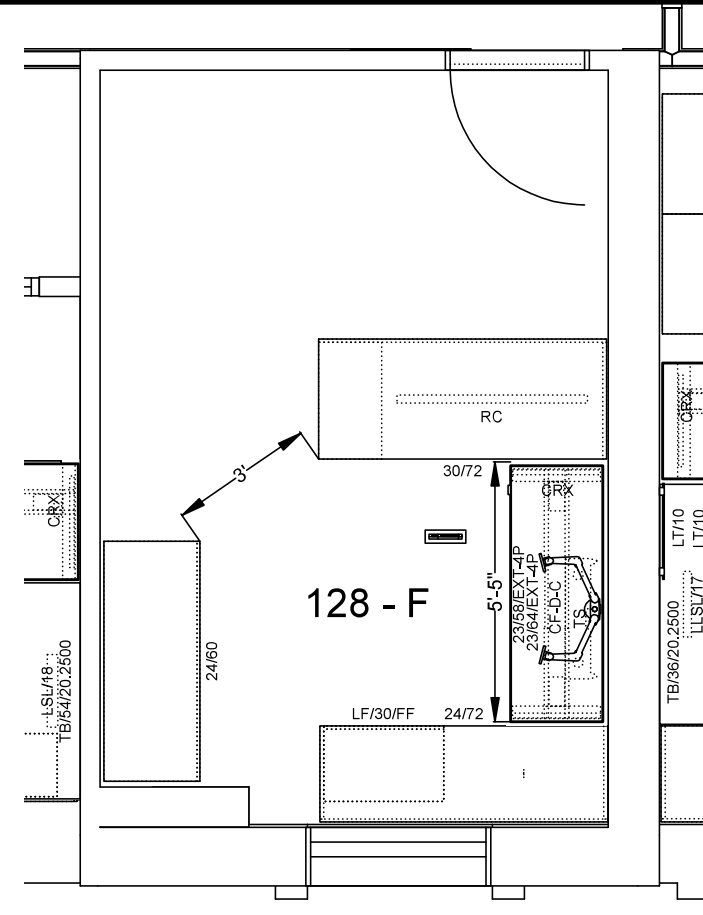

Area F - Office 128

THIS DESIGN CONCEPT AND DRAWING HAVE BEEN PREPARED EXCLUSIVELY FOR INTERNAL USE OF WORKSPACE INTERIORS AND THE CUSTOMER NAMED. THE DRAWING AND ANY DOCUMENTS RELATED TO IT REMAIN THE EXCLUSIVE PROPERTY OF WORKSPACE INTERIORS. NO PART OF THIS DRAWING OR PROPOSAL MAY BE REPRODUCED AND OR DISTRIBUTED WITHOUT THE WRITTEN CONSENT OF WORKSPACE INTERIORS. THESE DRAWINGS ARE NOT ARCHITECTURAL PLANS. THEY DO NOT CONTAIN DETAILS NECESSARY FOR CONSTRUCTION. SHOULD YOU REQUIRE A COMPLETE SET OF ARCHITECTURAL PLANS, WORKSPACE INTERIORS WILL WORK WITH THE ARCHITECT TO DEVELOP THEM.

Finance Department - Level 1 - Areas E and F

City of Kingsport

415 Broad Street
Kingsport, TN

workspace interiors
design solutions
www.workspaceinteriors.com

TRI-CITIES, TN
200 e main street
suite 300
kingsport tn 37660
p. 423.352.2600
f. 423.352.2601

KNOXVILLE, TN
2820 middlebrook pike
suite 104
knoxville tn 37921
p. 865.223.5404
f. 865.223.5405

DRAWN BY	PROJ MGR
LW	RS
ORIGINAL	10.26.23
LAST	11.07.23
SCAL	1/4"=1'-0"

FF-4

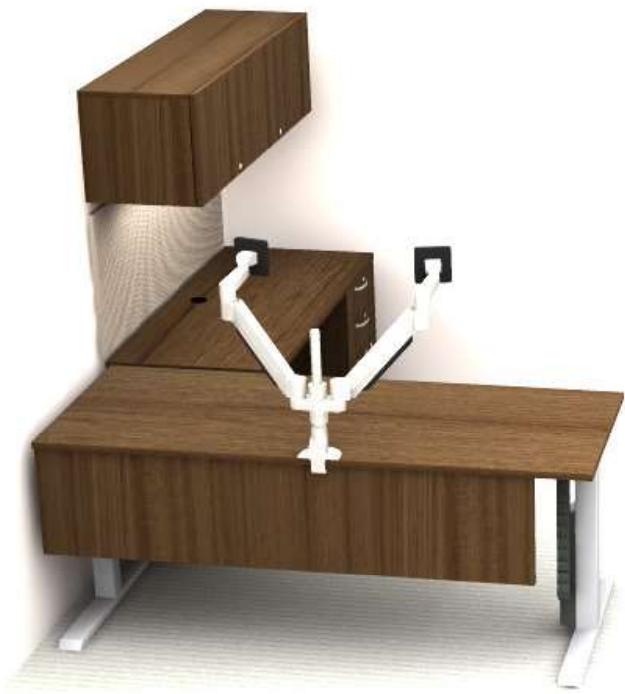

Area G - Office 130

Area H - Office 132

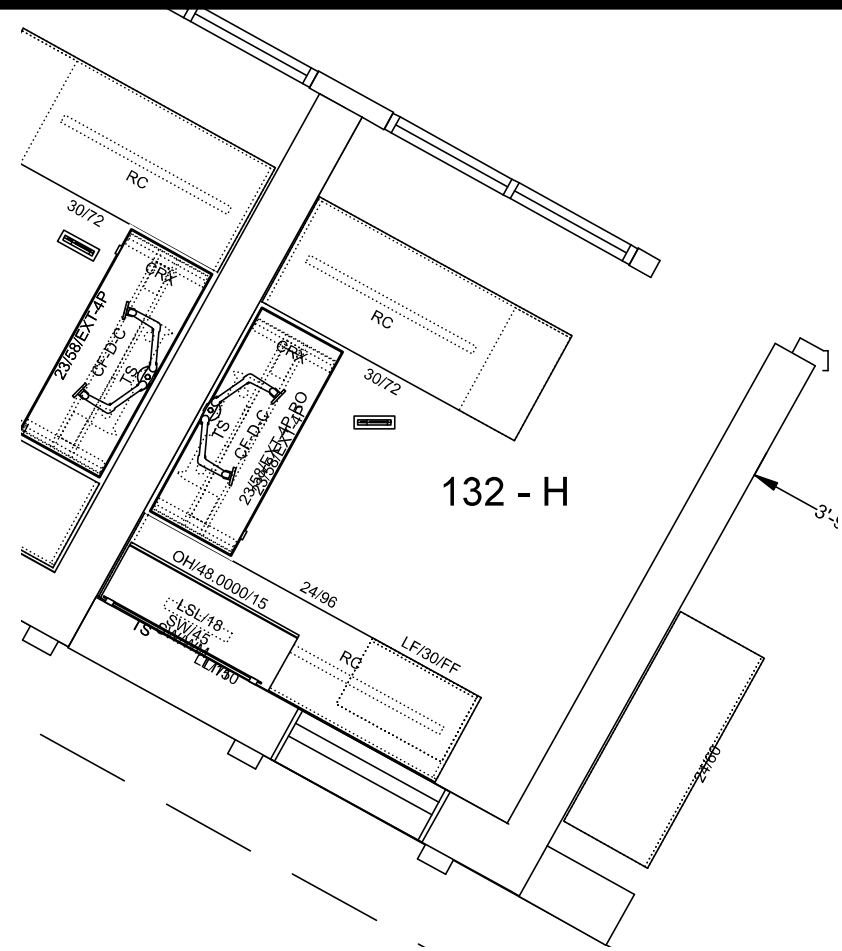
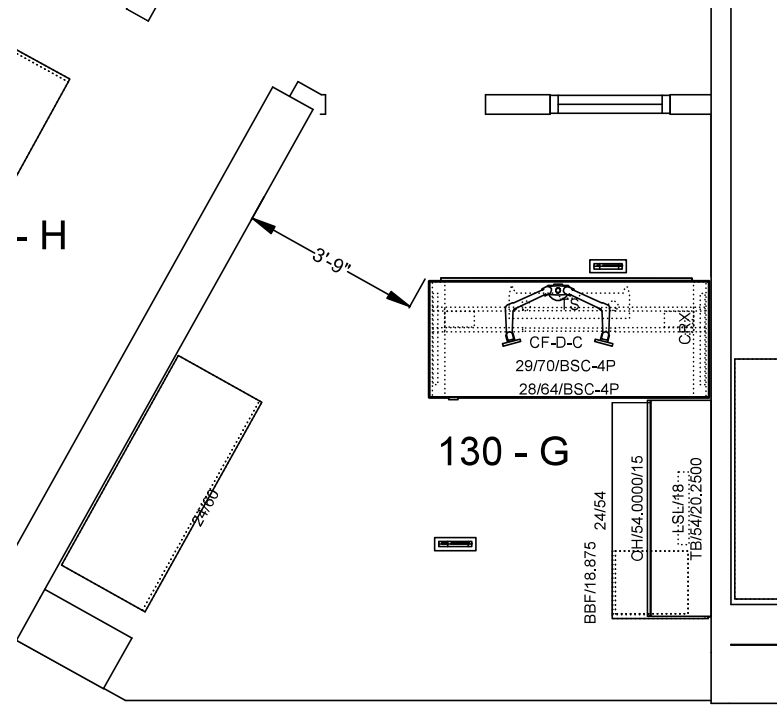

THIS DESIGN CONCEPT AND DRAWING HAVE BEEN PREPARED EXCLUSIVELY FOR INTERNAL USE OF WORKSPACE INTERIORS AND THE CUSTOMER NAMED. THE DRAWING AND ANY DOCUMENTS RELATED TO IT REMAIN THE EXCLUSIVE PROPERTY OF WORKSPACE INTERIORS. NO PART OF THIS DRAWING OR PROPOSAL MAY BE REPRODUCED AND OR DISTRIBUTED WITHOUT THE WRITTEN CONSENT OF WORKSPACE INTERIORS. THESE DRAWINGS ARE NOT ARCHITECTURAL PLANS. THEY DO NOT CONTAIN DETAILS NECESSARY FOR CONSTRUCTION. SHOULD YOU REQUIRE A COMPLETE SET OF ARCHITECTURAL PLANS, WORKSPACE INTERIORS WILL WORK WITH THE ARCHITECT TO DEVELOP THEM.

Finance Department - Level 1 - Areas G and H

City of Kingsport

415 Broad Street
Kingsport, TN



DRAWN BY	PROJ MGR
LW	RS
ORIGINAL	10.26.23
LAST	11.07.23
SCAL	1/4"=1'-0"

FF-5

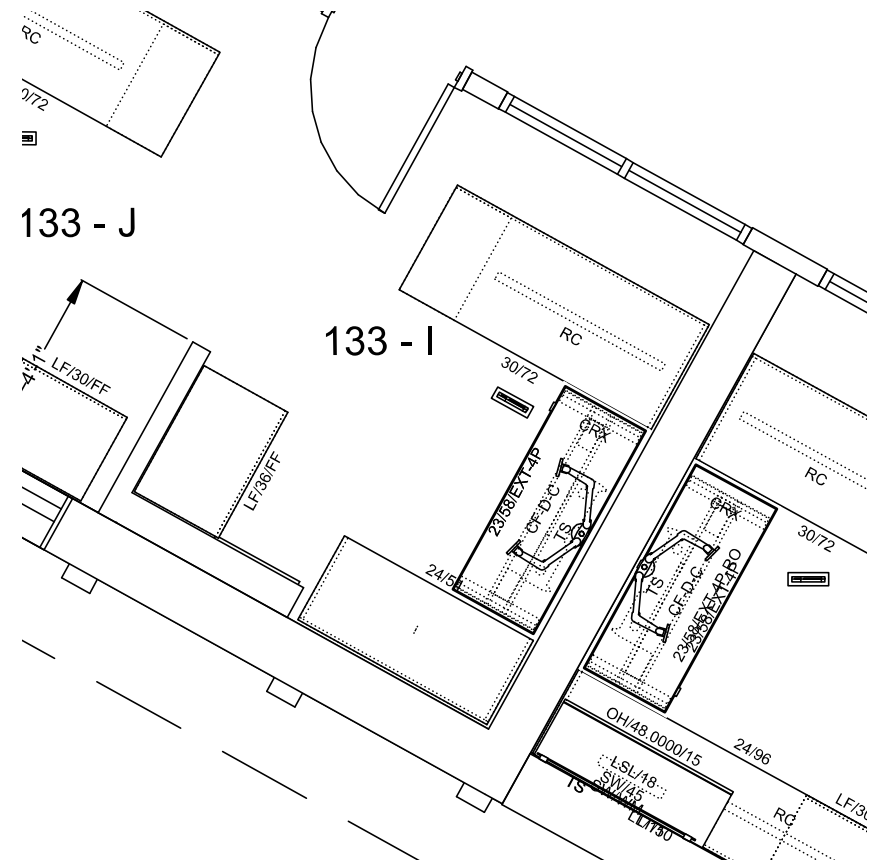

133 - J

133 - I



Area I - Office 133

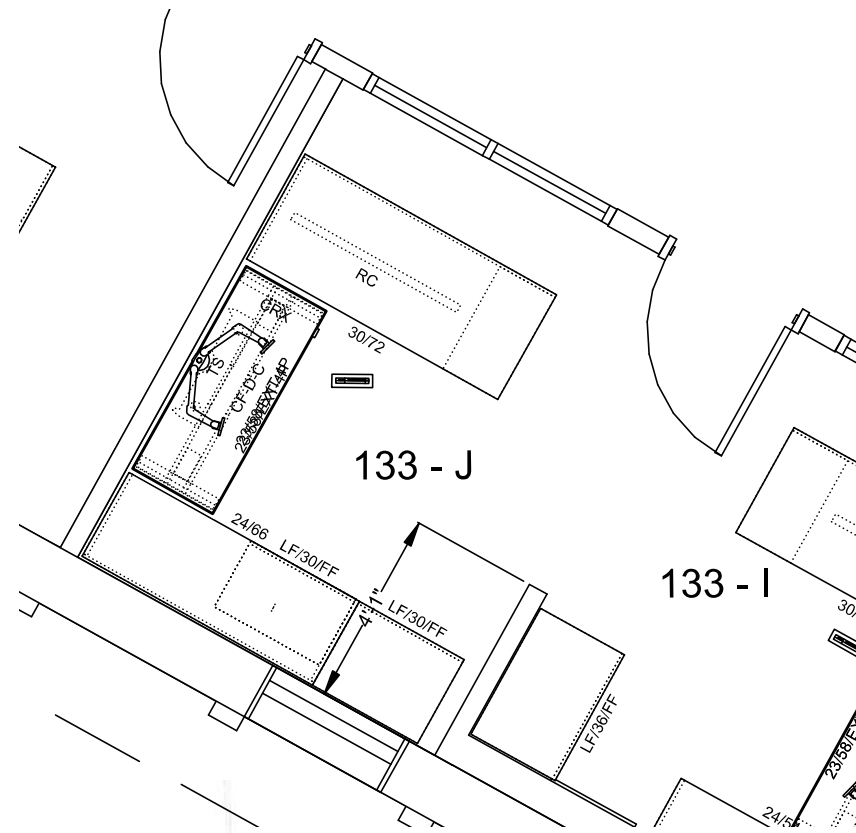

133 - J

133 - I



Area J - Office 133

THIS DESIGN CONCEPT AND DRAWING HAVE BEEN PREPARED EXCLUSIVELY FOR INTERNAL USE OF WORKSPACE INTERIORS AND THE CUSTOMER NAMED. THE DRAWING AND ANY DOCUMENTS RELATED TO IT REMAIN THE EXCLUSIVE PROPERTY OF WORKSPACE INTERIORS. NO PART OF THIS DRAWING OR PROPOSAL MAY BE REPRODUCED AND OR DISTRIBUTED WITHOUT THE WRITTEN CONSENT OF WORKSPACE INTERIORS. THESE DRAWINGS ARE NOT ARCHITECTURAL PLANS. THEY DO NOT CONTAIN DETAILS NECESSARY FOR CONSTRUCTION. SHOULD YOU REQUIRE A COMPLETE SET OF ARCHITECTURAL PLANS, WORKSPACE INTERIORS WILL WORK WITH THE ARCHITECT TO DEVELOP THEM.

Finance Department - Level 1 - Areas I and J

City of Kingsport

415 Broad Street
Kingsport, TN

workspace interiors
design solutions
www.workspaceinteriors.com

TRI-CITIES, TN
200 e main street
suite 300
kingsport tn 37660
p. 423.352.2600
f. 423.352.2601

KNOXVILLE, TN
2820 middlebrook pike
suite 104
knoxville tn 37921
p. 865.223.5404
f. 865.223.5405

DRAWN BY	PROJ MGR
LW	RS
ORIGINAL	10.26.23
LAST	11.07.23
SCAL	1/4"=1'-0"

FF-6

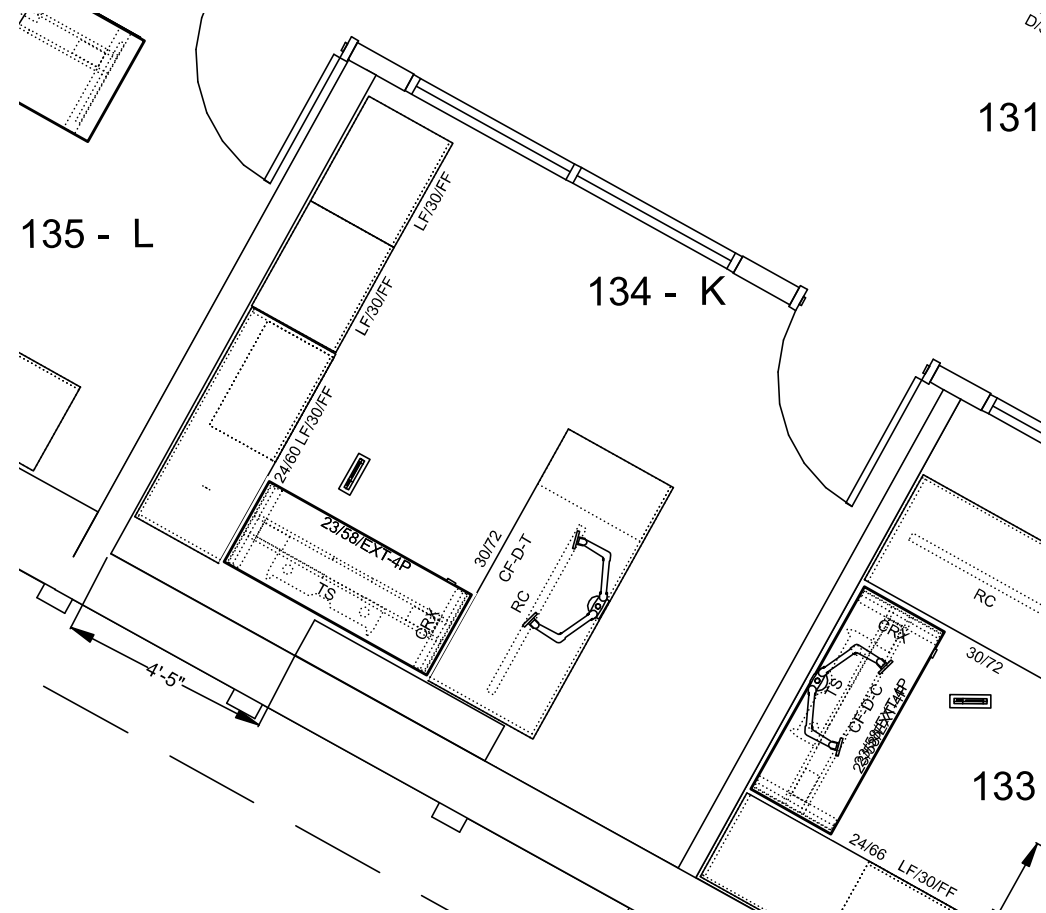

Area K - Office 134

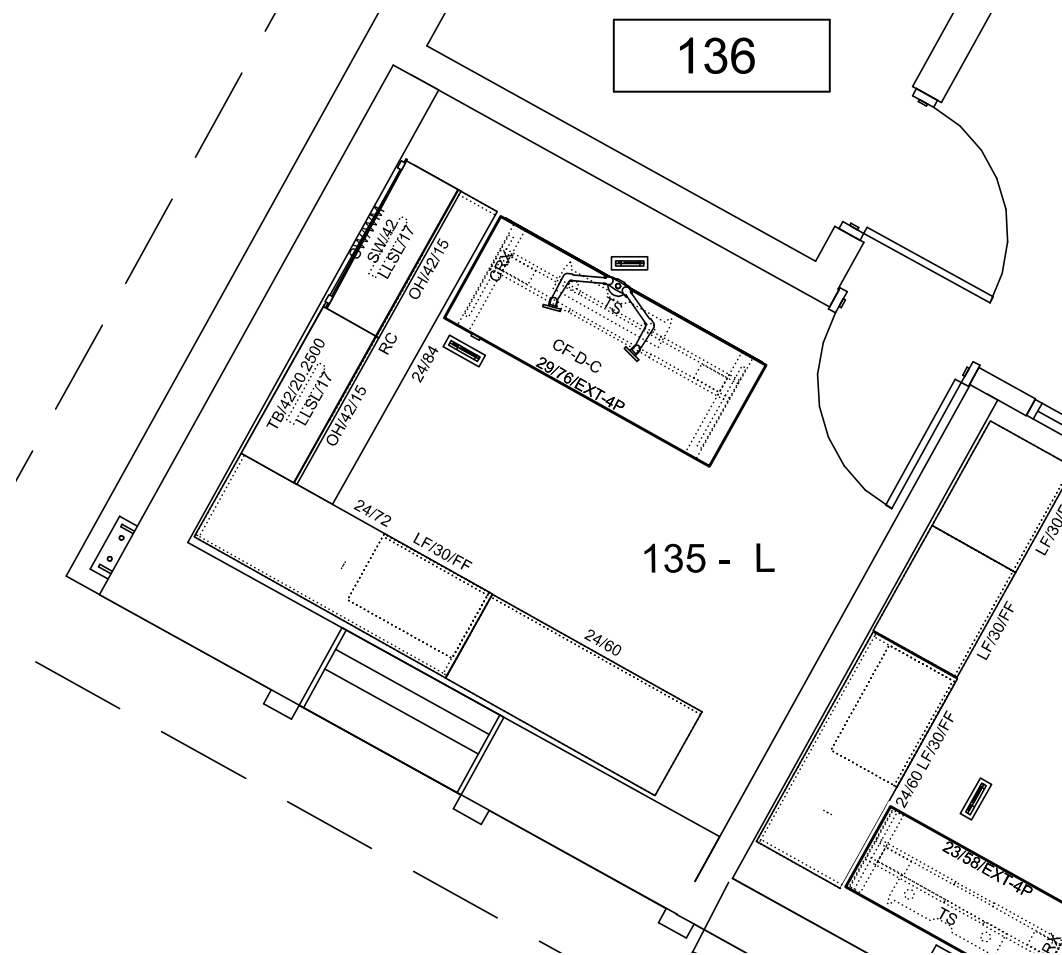

Area L - Office 135

THIS DESIGN CONCEPT AND DRAWING HAVE BEEN PREPARED EXCLUSIVELY FOR INTERNAL USE OF WORKSPACE INTERIORS AND THE CUSTOMER NAMED. THE DRAWING AND ANY DOCUMENTS RELATED TO IT REMAIN THE EXCLUSIVE PROPERTY OF WORKSPACE INTERIORS. NO PART OF THIS DRAWING OR PROPOSAL MAY BE REPRODUCED AND OR DISTRIBUTED WITHOUT THE WRITTEN CONSENT OF WORKSPACE INTERIORS. THESE DRAWINGS ARE NOT ARCHITECTURAL PLANS. THEY DO NOT CONTAIN DETAILS NECESSARY FOR CONSTRUCTION. SHOULD YOU REQUIRE A COMPLETE SET OF ARCHITECTURAL PLANS, WORKSPACE INTERIORS WILL WORK WITH THE ARCHITECT TO DEVELOP THEM.

Finance Department - Level 1 - Areas K and L

City of Kingsport

415 Broad Street
Kingsport, TN

workspace interiors
design solutions
www.workspaceinteriors.com

TRI-CITIES, TN
200 e main street
suite 300
kingsport tn 37660
p. 423.352.2600
f. 423.352.2601

KNOXVILLE, TN
2820 middlebrook pike
suite 104
knoxville tn 37921
p. 865.223.5404
f. 865.223.5405

DRAWN BY	PROJ MGR
LW	RS
ORIGINAL	10.26.23
LAST	11.07.23
SCAL	1/4"=1'-0"

FF-7



Area M1 - Corridor 131

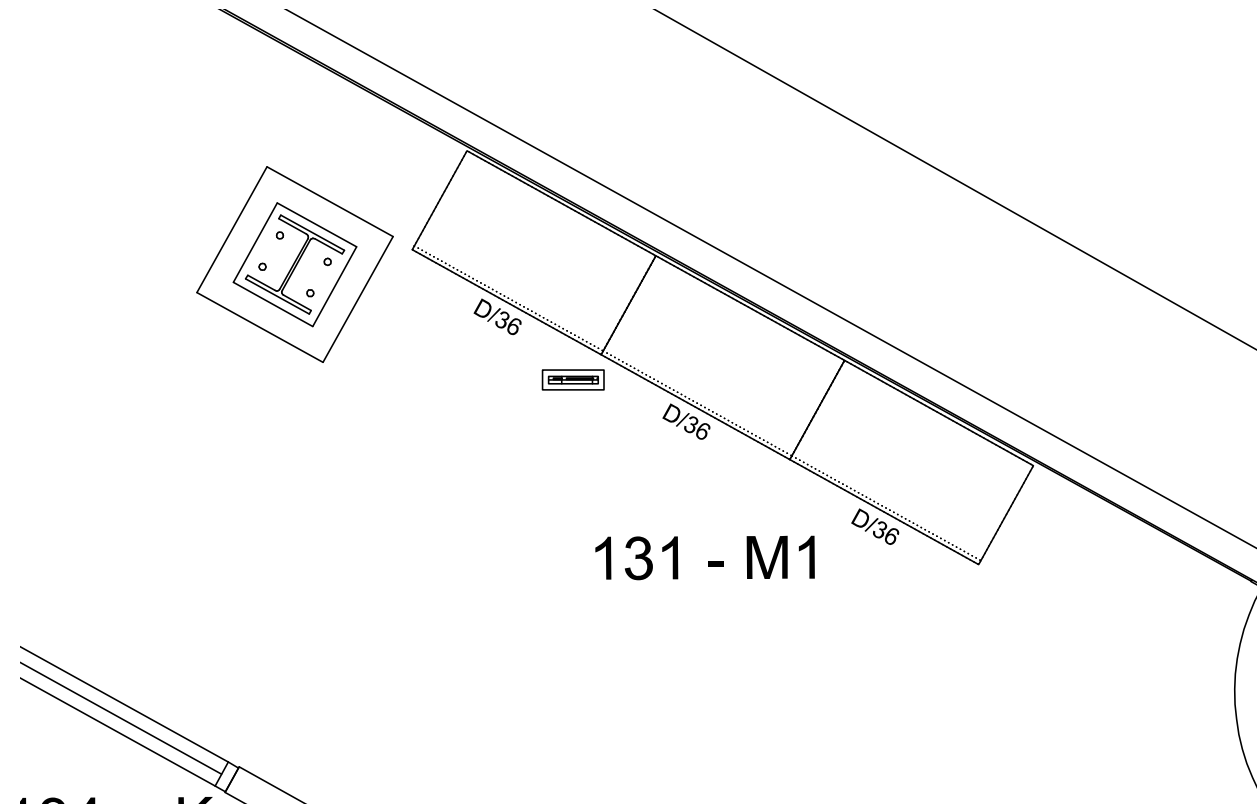

131 - M1



Area M2 - Corridor 131

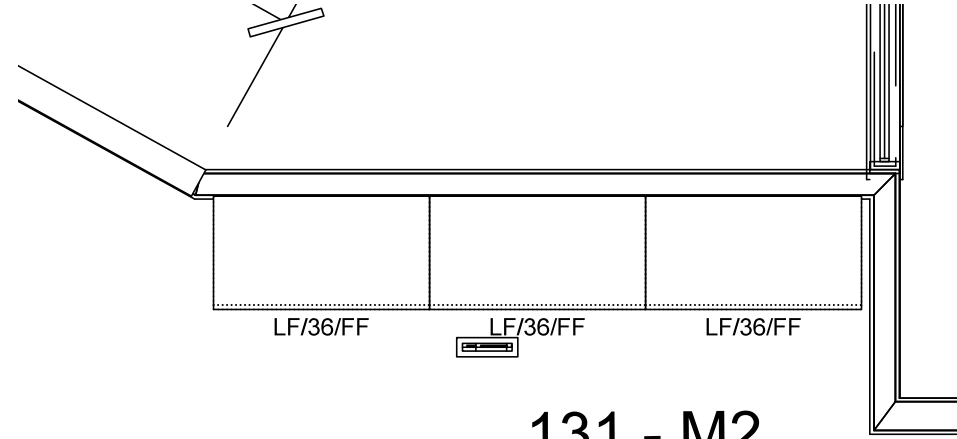

131 - M2

THIS DESIGN CONCEPT AND DRAWING HAVE BEEN PREPARED EXCLUSIVELY FOR INTERNAL USE OF WORKSPACE INTERIORS AND THE CUSTOMER NAMED. THE DRAWING AND ANY DOCUMENTS RELATED TO IT REMAIN THE EXCLUSIVE PROPERTY OF WORKSPACE INTERIORS. NO PART OF THIS DRAWING OR PROPOSAL MAY BE REPRODUCED AND OR DISTRIBUTED WITHOUT THE WRITTEN CONSENT OF WORKSPACE INTERIORS. THESE DRAWINGS ARE NOT ARCHITECTURAL PLANS. THEY DO NOT CONTAIN DETAILS NECESSARY FOR CONSTRUCTION. SHOULD YOU REQUIRE A COMPLETE SET OF ARCHITECTURAL PLANS, WORKSPACE INTERIORS WILL WORK WITH THE ARCHITECT TO DEVELOP THEM.

Finance Department - Level 1 - Areas M1 and M2

City of Kingsport

415 Broad Street

Kingsport, TN

DRAWN BY	PROJ MGR
LW	RS
ORIGINAL	10.26.23
LAST	11.07.23
SCAL	3/8"=1'-0"

FF-8

workspace interiors
design solutions
www.workspaceinteriors.com

TRI-CITIES, TN
200 e main street
suite 300
kingsport tn 37660
p. 423.352.2600
f. 423.352.2601

KNOXVILLE, TN
2820 middlebrook pike
suite 104
knoxville tn 37921
p. 865.223.5404
f. 865.223.5405