



City of Ketchum

April 4, 2022

Mayor Bradshaw and City Councilors
City of Ketchum
Ketchum, Idaho

Mayor Bradshaw and City Councilors:

Recommendation To Approve the Subdivision Final Plat for 151 Topaz St, Adopt the Findings of Fact, and Approve Security Agreement #22761 for Right-of-Way and Utility Improvements

Recommendation and Summary

Staff recommends the Ketchum City Council approve the Subdivision Final Plat for 151 Topaz St, adopt the findings of fact, conclusions of law, and decision, and approve Security Agreement #22761 for right-of-way and utility improvements. The application was submitted by Sean Flynn, of Galena Engineering on behalf of the property owner, Sallie Castle. The request is a subdivision final plat application to subdivide one lot into two lots in the Gem Street Subdivision.

Recommended Motion: "I move to approve the 151 Topaz subdivision final plat application, as conditioned, adopt the findings of fact, conclusion of law, and decision, as it conforms to all applicable subdivision regulations for a final plat, and approve Security Agreement #22761, for signature by the Mayor."

The reasons for the recommendation are as follows:

- The request meets all applicable standards for Final Plats contained in Ketchum Municipal Code (KMC) Subdivision (Title 16) regulations.
- The subdivision preliminary plat application for this project was review and approved by the Planning and Zoning Commission on October 26, 2021 and the Ketchum City Council on November 18, 2021.
- The proposed final plat meets all the requirements of the preliminary plat approval, including conformance with all conditions of approval of the preliminary plat.
- Due to winter weather conditions, right-of-way and utility improvements cannot be completed at this time, therefore a security agreement is required.
- All city departments have reviewed the proposal and have no issue with the proposed subdivision or security agreement.

Introduction and History

The Applicant is proposing to subdivide Lot 2 of the Gem Street Subdivision, located at 151 Topaz Street (the "subject property") into two lots (the "project"). The subject property is zoned Limited Residential (LR) and has an existing single family dwelling unit and detached garage. The project proposes to retain the existing single family dwelling unit and garage and create a new 9,000 square foot lot on the eastern portion of the existing lot. The subdivision preliminary plat for the project was reviewed and approved by the Planning and Zoning Commission on October 26, 2021, and the City Council on November 18, 2021. The staff report and attachments for November 18, 2021, meeting on the preliminary plat can be found as Attachment E.

The City of Ketchum received the application for the Subdivision Final Plat for the project on December 16, 2021. The application was deemed complete on February 1, 2022, after one review for completeness. Following receipt of the complete application, staff routed the application materials to all city departments for review. Department comments were provided to the applicant on February 24, 2022.

Analysis

All subdivision final plats must meet the requirements of Ketchum Municipal Code (KMC) Section 16.04.030.G - *Final Plat Procedures*. The subdivision regulations require that all final plats are in substantial conformance with the approved preliminary plat and conditions of approval. The regulations also require that all contents of a final plat as outlined in KMC Section 16.04.030.K are included. A full review of all final plat requirements is included as Attachment C to this report. Staff have conducted a thorough review of the requirements and believe the final plat to be in substantial conformance with the preliminary plat, except for condition #5, and includes all required elements of a final plat.

Condition #5 of the preliminary plat approval requires that all right-of-way improvements be completed prior to final plat approval. Due to current weather, the owner is not able to construct the right-of-way improvements at this time. KMC Section 16.04.040.C - Performance Bond, allows the City Council to approve a Security Agreement stipulating the timing of required improvements in situations like this. The regulation requires the Owner to provide a performance bond to the City in the amount of 150% of the construction cost estimate. Staff have drafted a Security Agreement included as Attachment D. The agreement outlines the required improvements, timing for completion, process for acceptance, and release of the performance bond. If the work is not completed by the date of the agreement, the city may elect to use the funds and complete the work according to the agreement. The Owner has a designated contractor for the work and a bid for the work showing completion of the project no later than August 15, 2022. Staff believe this is an acceptable timeframe for the work provided it will be completed prior to winter 2022, when the improvements are most critical.

Staff recommends approval of the Subdivision Final Plat application with the following recommended Conditions of Approval:

1. Prior to recording of the Final Plat, the Security Agreement must be fully executed by all parties, and the performance bond must be received by the City of Ketchum.
2. Failure to record the Final Plat within one year of Council's approval of the Final Plat shall cause the Final Plat to be null and void.

Sustainability

The proposed final plat does not limit the ability of the city to reach the goals of the Ketchum Sustainability Action Plan – 2020.

Financial Impact

There is no financial requirement from the city for this action.

Attachments

- A. Application Materials - Application and Supporting Documents
- B. Application Materials – Final Plat Plan Set
- C. Draft Findings of Fact, Conclusions of Law, and Decision
- D. Security Agreement 22761 and Exhibits
- E. Staff Report and Attachments – November 18, 2021 City Council Meeting

Attachment A:
Application Materials –
Application and Supporting
Documents



**City of Ketchum
Planning & Building**

OFFICIAL USE ONLY	
Application Number:	P21-102
Date:	12/16/21
By:	SD
Fee Paid:	750
Approved Date:	
By:	S. Flynn

Final Plat

Subdivision Application

Submit completed application and payment to the Planning and Building Department, PO Box 2315, Ketchum, ID 83340 or hand deliver to Ketchum City Hall, 480 East Ave. N., Ketchum. If you have questions, please contact the Planning and Building Department at (208) 726-7801. To view the Development Standards, visit the City website at: www.ketchumidaho.org and click on Municipal Code.

APPLICANT INFORMATION			
Name of Proposed Subdivision: Replat of Lot 2, Gem Street Subdivision			
Owner of Record: Sallie Castle			
Address of Owner: PO Box 2422, Ketchum, ID 83340			
Representative of Owner: Sean Flynn / Galena Engineering			
Legal Description: Lot 2, Block 1, Gem Street Subdivision			
Street Address: 151 Topaz Street			
SUBDIVISION INFORMATION			
Number of Lots/Parcels: 2			
Total Land Area: 33,093 Sq. Ft.			
Current Zoning District: LR			
Proposed Zoning District: LR			
Overlay District: None			
TYPE OF SUBDIVISION			
Condominium <input type="checkbox"/>	Land <input checked="" type="checkbox"/>	PUD <input type="checkbox"/>	Townhouse <input type="checkbox"/>
Adjacent land in same ownership in acres or square feet:			
Easements to be dedicated on the final plat:			
Public Utility and Snow Storage Easements, Turnaround Access Easement on Lot 2			
Briefly describe the improvements to be installed prior to final plat approval:			
Water and Sewer Services to Lot 2, Widening of Emerald Street			
ADDITIONAL INFORMATION			
All lighting must be in compliance with the City of Ketchum's Dark Sky Ordinance			
One (1) copy of Articles of Incorporation and By-Laws of Homeowners Associations and/or Condominium Declarations			
One (1) copy of current title report and owner's recorded deed to the subject property			
One (1) copy of the preliminary plat			
All files should be submitted in an electronic format.			

Applicant agrees in the event of a dispute concerning the interpretation or enforcement of the Subdivision Application in which the City of Ketchum is the prevailing party to pay reasonable attorney's fees and costs, including fees and costs of appeal for the City of Ketchum. Applicant agrees to observe all City ordinances, laws and conditions imposed. Applicant agrees to defend, hold harmless and indemnify the City of Ketchum, city officials, agents and employees from and for any and all losses, claims, actions, judgments for damages, or injury to persons or property, and losses and expenses caused or incurred by Applicant, its servants, agents, employees, guests and business invitees and not caused by or arising out of the tortious conduct of city or its officials, agents or employees. Applicant certifies that s/he has read and examined this application and that all information contained herein is true and correct.

Sean Flynn Sean Flynn / Galena Engineering 12/8/2021
Applicant Signature Date

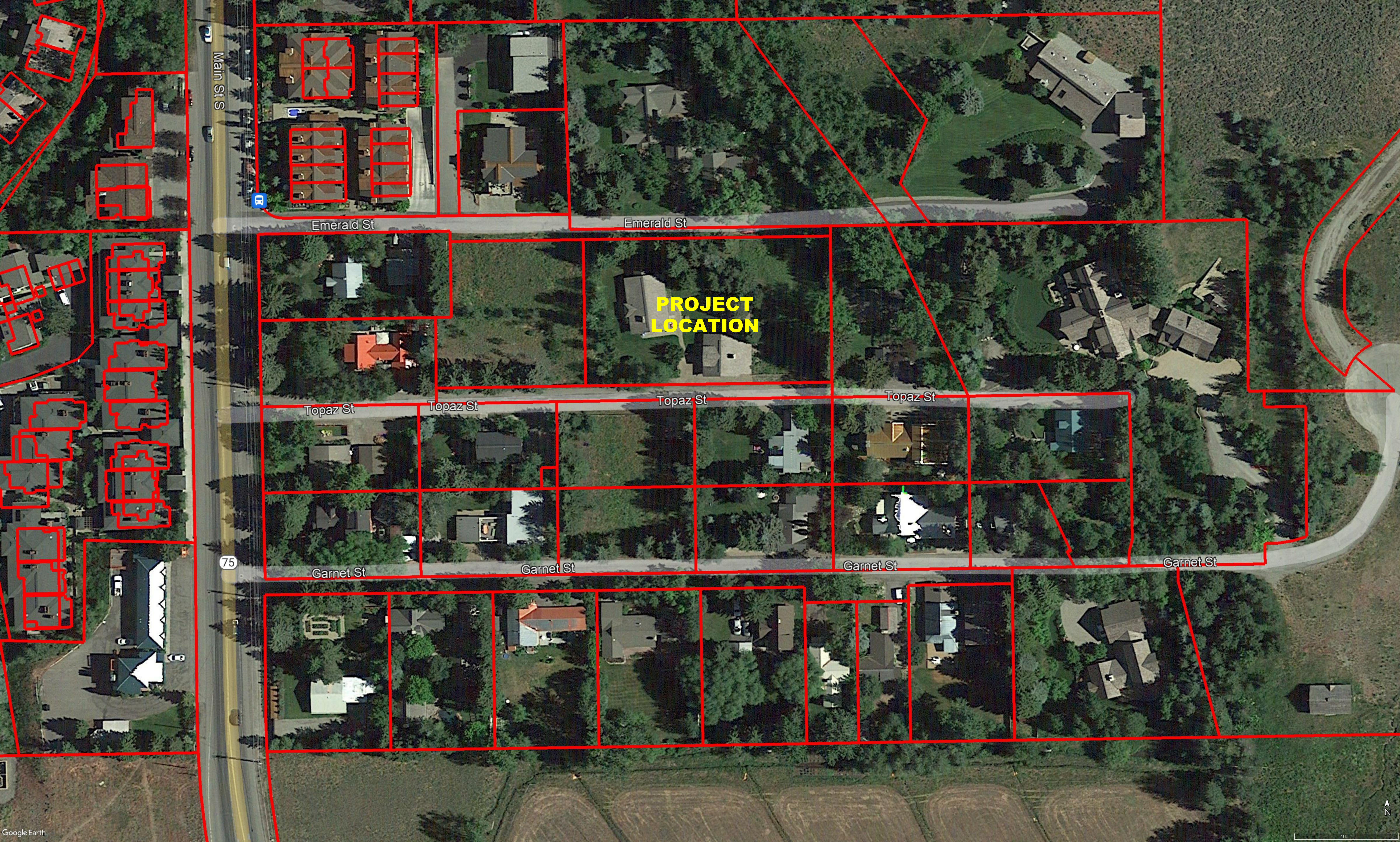

Main St S

Emerald St

Emerald St

**PROJECT
LOCATION**

Topaz St

Topaz St

Topaz St

Topaz St

75

Garnet St

Garnet St

Garnet St

Garnet St

Instrument # 676200

HAILEY, BLAINE, IDAHO
11-25-2020 1:20:05 PM No. of Pages: 2
Recorded for: BLAINE COUNTY TITLE
JOLYNN DRAGE Fee: \$15.00
Ex-Officio Recorder Deputy: JB
Electronically Recorded by Simplifile



WARRANTY DEED

FOR VALUE RECEIVED

Fritz Xavier Haemmerle, a married man dealing with his sole and separate property, fifty percent (50%) interest and Reli Louise Haemmerle . an unmarried woman, fifty percent (50%) interest

GRANTOR(S), hereby grants, bargains, sells, conveys and warrants unto

Sallie Castle, an unmarried woman

GRANTEE(S) whose current address is: P.O. Box 2422, Ketchum, ID 83340

the following described premises, to-wit:

Lot 2, Block 1 of GEM STREET SUBDIVISION, as shown on the official plat thereof, recorded as Instrument No. 675967, records of Blaine County, Idaho.

TO HAVE AND TO HOLD the said premises, with their appurtenances unto the said Grantee, its heirs and assigns forever. And the said Grantor does hereby covenant to and with the said Grantee, that Grantor is the owner in fee simple of said premises; that they are free from all encumbrances except those to which this conveyance is expressly made subject to and those made, suffered or done by the Grantee; and subject to all existing patent reservations; restrictions in railroad deeds of record; easements and rights of way established and of record; protective covenants of record; zoning ordinances and applicable building codes, use restrictions, ordinances, laws and regulations of any governmental unit; general taxes and assessments, including irrigation and utility assessments (if any) for the current year, which are not due and payable; and that Grantor will warrant and defend the same from all lawful claims whatsoever. Whenever the context so requires, the singular number includes the plural.

Dated this 25 day of November, 2020.

Fritz Xavier Haemmerle

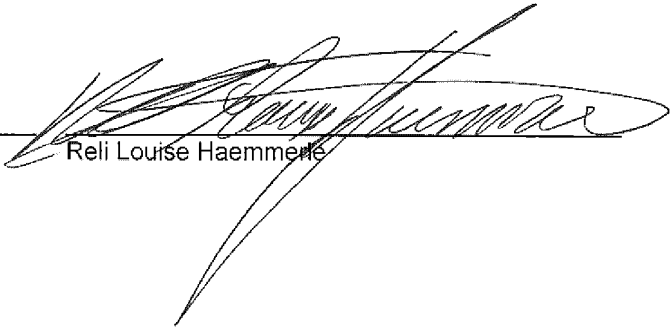
Reli Louise Haemmerle

State of Idaho
County of Blaine

This record was acknowledged before me on 25 day of November, 2020, by Fritz Xavier Haemmerle and Reli Louise Haemmerle.

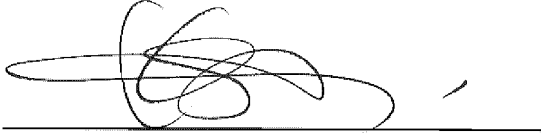

Notary Public Kathy Seal
My Commission Expires: 7.26.2023

(STAMP)





ALTA OWNER'S POLICY OF TITLE INSURANCE

ISSUED BY
STEWART TITLE GUARANTY COMPANY

Any notice of claim and any other notice or statement in writing required to be given to the Company under this Policy must be given to the Company at the address shown in Section 18 of the Conditions.

COVERED RISKS

SUBJECT TO THE EXCLUSIONS FROM COVERAGE, THE EXCEPTIONS FROM COVERAGE CONTAINED IN SCHEDULE B AND THE CONDITIONS, STEWART TITLE GUARANTY COMPANY, a Texas corporation, (the "Company") insures, as of Date of Policy and, to the extent stated in Covered Risks 9 and 10, after Date of Policy, against loss or damage, not exceeding the Amount of Insurance, sustained or incurred by the Insured by reason of:

- 1. Title being vested other than as stated in Schedule A.
2. Any defect in or lien or encumbrance on the Title. This Covered Risk includes but is not limited to insurance against loss from
(a) A defect in the Title caused by
(i) forgery, fraud, undue influence, duress, incompetency, incapacity, or impersonation;
(ii) failure of any person or Entity to have authorized a transfer or conveyance;
(iii) a document affecting Title not properly created, executed, witnessed, sealed, acknowledged, notarized, or delivered;
(iv) failure to perform those acts necessary to create a document by electronic means authorized by law;
(v) a document executed under a falsified, expired, or otherwise invalid power of attorney;
(vi) a document not properly filed, recorded, or indexed in the Public Records including failure to perform those acts by electronic means authorized by law; or
(vii) a defective judicial or administrative proceeding.
(b) The lien of real estate taxes or assessments imposed on the Title by a governmental authority due or payable, but unpaid.
(c) Any encroachment, encumbrance, violation, variation, or adverse circumstance affecting the Title that would be disclosed by an accurate and complete land survey of the Land. The term "encroachment" includes encroachments of existing improvements located on the Land onto adjoining land, and encroachments onto the Land of existing improvements located on adjoining land.
3. Unmarketable Title.
4. No right of access to and from the Land.
5. The violation or enforcement of any law, ordinance, permit, or governmental regulation (including those relating to building and zoning) restricting, regulating, prohibiting, or relating to
(a) the occupancy, use, or enjoyment of the Land;
(b) the character, dimensions, or location of any improvement erected on the Land;
(c) the subdivision of land; or
(d) environmental protection
if a notice, describing any part of the Land, is recorded in the Public Records setting forth the violation or intention to enforce, but only to the extent of the violation or enforcement referred to in that notice.
6. An enforcement action based on the exercise of a governmental police power not covered by Covered Risk 5 if a notice of the enforcement action, describing any part of the Land, is recorded in the Public Records, but only to the extent of the enforcement referred to in that notice.
7. The exercise of the rights of eminent domain if a notice of the exercise, describing any part of the Land, is recorded in the Public Records.
8. Any taking by a governmental body that has occurred and is binding on the rights of a purchaser for value without Knowledge.

Countersigned by:

[Signature]
Authorized Countersignature

Blaine County Title, Inc.
360 Sun Valley Road
P.O. Box 3176
Ketchum, ID 83340
(208) 726-0700
Agent ID: 120037



[Signature]
Frederick H. Eppinger
President and CEO

[Signature]
Denise Carraux
Secretary

For coverage information or assistance resolving a complaint, call (800) 729-1902 or visit www.stewart.com. To make a claim, furnish written notice in accordance with Section 3 of the Conditions.



COVERED RISKS (Continued)

9. Title being vested other than as stated in Schedule A or being defective
- (a) as a result of the avoidance in whole or in part, or from a court order providing an alternative remedy, of a transfer of all or any part of the title to or any interest in the Land occurring prior to the transaction vesting Title as shown in Schedule A because that prior transfer constituted a fraudulent or preferential transfer under federal bankruptcy, state insolvency, or similar creditors' rights laws; or
 - (b) because the instrument of transfer vesting Title as shown in Schedule A constitutes a preferential transfer under federal bankruptcy, state insolvency, or similar creditors' rights laws by reason of the failure of its recording in the Public Records
- (i) to be timely; or
 - (ii) to impart notice of its existence to a purchaser for value or to a judgment or lien creditor.
10. Any defect in or lien or encumbrance on the Title or other matter included in Covered Risks 1 through 9 that has been created or attached or has been filed or recorded in the Public Records subsequent to Date of Policy and prior to the recording of the deed or other instrument of transfer in the Public Records that vests Title as shown in Schedule A.
- The Company will also pay the costs, attorneys' fees, and expenses incurred in defense of any matter insured against by this Policy, but only to the extent provided in the Conditions.

EXCLUSIONS FROM COVERAGE

The following matters are expressly excluded from the coverage of this policy, and the Company will not pay loss or damage, costs, attorneys' fees, or expenses that arise by reason of:

1. (a) Any law, ordinance, permit, or governmental regulation (including those relating to building and zoning) restricting, regulating, prohibiting, or relating to
 - (i) the occupancy, use, or enjoyment of the Land;
 - (ii) the character, dimensions, or location of any improvement erected on the Land;
 - (iii) the subdivision of land; or
 - (iv) environmental protection;or the effect of any violation of these laws, ordinances, or governmental regulations. This Exclusion 1(a) does not modify or limit the coverage provided under Covered Risk 5.
- (b) Any governmental police power. This Exclusion 1(b) does not modify or limit the coverage provided under Covered Risk 6.
2. Rights of eminent domain. This Exclusion does not modify or limit the coverage provided under Covered Risk 7 or 8.
3. Defects, liens, encumbrances, adverse claims, or other matters
 - (a) created, suffered, assumed, or agreed to by the Insured Claimant;

- (b) not Known to the Company, not recorded in the Public Records at Date of Policy, but Known to the Insured Claimant and not disclosed in writing to the Company by the Insured Claimant prior to the date the Insured Claimant became an Insured under this policy;
 - (c) resulting in no loss or damage to the Insured Claimant;
 - (d) attaching or created subsequent to Date of Policy (however, this does not modify or limit the coverage provided under Covered Risk 9 and 10); or
 - (e) resulting in loss or damage that would not have been sustained if the Insured Claimant had paid value for the Title.
4. Any claim, by reason of the operation of federal bankruptcy, state insolvency, or similar creditors' rights laws, that the transaction vesting the Title as shown in Schedule A, is
 - (a) a fraudulent conveyance or fraudulent transfer; or
 - (b) a preferential transfer for any reason not stated in Covered Risk 9 of this policy.
 5. Any lien on the Title for real estate taxes or assessments imposed by governmental authority and created or attaching between Date of Policy and the date of recording of the deed or other instrument of transfer in the Public Records that vests Title as shown in Schedule A.

CONDITIONS

1. DEFINITION OF TERMS

The following terms when used in this policy mean:

- (a) "Amount of Insurance": The amount stated in Schedule A, as may be increased or decreased by endorsement to this policy, increased by Section 8(b), or decreased by Sections 10 and 11 of these Conditions.
- (b) "Date of Policy": The date designated as "Date of Policy" in Schedule A.
- (c) "Entity": A corporation, partnership, trust, limited liability company, or other similar legal entity.
- (d) "Insured": The Insured named in Schedule A.
 - (i) the term "Insured" also includes
 - (A) successors to the Title of the Insured by operation of law as distinguished from purchase, including heirs, devisees, survivors, personal representatives, or next of kin;
 - (B) successors to an Insured by dissolution, merger, consolidation, distribution, or reorganization;
 - (C) successors to an Insured by its conversion to another kind of Entity;
 - (D) a grantee of an Insured under a deed delivered without payment of actual valuable consideration conveying the Title
 - (1) if the stock, shares, memberships, or other equity interests of the grantee are wholly-owned by the named Insured.
 - (2) if the grantee wholly owns the named Insured.
 - (3) if the grantee is wholly-owned by an affiliated Entity of the named Insured, provided the affiliated Entity and the named Insured are both wholly-owned by the same person or Entity, or
 - (4) if the grantee is a trustee or beneficiary of a trust created by a written instrument established by the

Insured named in Schedule A for estate planning purposes.

- (ii) with regard to (A), (B), (C), and (D) reserving, however, all rights and defenses as to any successor that the Company would have had against any predecessor Insured.
- (e) "Insured Claimant": An Insured claiming loss or damage.
- (f) "Knowledge" or "Known": Actual knowledge, not constructive knowledge or notice that may be imputed to an Insured by reason of the Public Records or any other records that impart constructive notice of matters affecting the Title.
- (g) "Land": The land described in Schedule A, and affixed improvements that by law constitute real property. The term "Land" does not include any property beyond the lines of the area described in Schedule A, nor any right, title, interest, estate, or easement in abutting streets, roads, avenues, alleys, lanes, ways, or waterways, but this does not modify or limit the extent that a right of access to and from the Land is insured by this policy.
- (h) "Mortgage": Mortgage, deed of trust, trust deed, or other security instrument, including one evidenced by electronic means authorized by law.
- (i) "Public Records": Records established under state statutes at Date of Policy for the purpose of imparting constructive notice of matters relating to real property to purchasers for value and without Knowledge. With respect to Covered Risk 5(d), "Public Records" shall also include environmental protection liens filed in the records of the clerk of the United States District Court for the district where the Land is located.
- (j) "Title": The estate or interest described in Schedule A.
- (k) "Unmarketable Title": Title affected by an alleged or apparent matter that would permit a prospective purchaser or lessee of the Title or lender on the Title to be released from the obligation to purchase, lease, or lend if there is a contractual condition requiring the delivery of marketable title.

CONDITIONS (Continued)

2. CONTINUATION OF INSURANCE

The coverage of this policy shall continue in force as of Date of Policy in favor of an Insured, but only so long as the Insured retains an estate or interest in the Land, or holds an obligation secured by a purchase money Mortgage given by a purchaser from the Insured, or only so long as the Insured shall have liability by reason of warranties in any transfer or conveyance of the Title. This policy shall not continue in force in favor of any purchaser from the Insured of either (i) an estate or interest in the Land, or (ii) an obligation secured by a purchase money Mortgage given to the Insured.

3. NOTICE OF CLAIM TO BE GIVEN BY INSURED CLAIMANT

The Insured shall notify the Company promptly in writing (i) in case of any litigation as set forth in Section 5(a) of these Conditions, (ii) in case Knowledge shall come to an Insured hereunder of any claim of title or interest that is adverse to the Title, as insured, and that might cause loss or damage for which the Company may be liable by virtue of this policy, or (iii) if the Title, as insured, is rejected as Unmarketable Title. If the Company is prejudiced by the failure of the Insured Claimant to provide prompt notice, the Company's liability to the Insured Claimant under the policy shall be reduced to the extent of the prejudice.

4. PROOF OF LOSS

In the event the Company is unable to determine the amount of loss or damage, the Company may, at its option, require as a condition of payment that the Insured Claimant furnish a signed proof of loss. The proof of loss must describe the defect, lien, encumbrance, or other matter insured against by this policy that constitutes the basis of loss or damage and shall state, to the extent possible, the basis of calculating the amount of the loss or damage.

5. DEFENSE AND PROSECUTION OF ACTIONS

- (a) Upon written request by the Insured, and subject to the options contained in Section 7 of these Conditions, the Company, at its own cost and without unreasonable delay, shall provide for the defense of an Insured in litigation in which any third party asserts a claim covered by this policy adverse to the Insured. This obligation is limited to only those stated causes of action alleging matters insured against by this policy. The Company shall have the right to select counsel of its choice (subject to the right of the Insured to object for reasonable cause) to represent the Insured as to those stated causes of action. It shall not be liable for and will not pay the fees of any other counsel. The Company will not pay any fees, costs, or expenses incurred by the Insured in the defense of those causes of action that allege matters not insured against by this policy.
- (b) The Company shall have the right, in addition to the options contained in Section 7 of these Conditions, at its own cost, to institute and prosecute any action or proceeding or to do any other act that in its opinion may be necessary or desirable to establish the Title, as insured, or to prevent or reduce loss or damage to the Insured. The Company may take any appropriate action under the terms of this policy, whether or not it shall be liable to the Insured. The exercise of these rights shall not be an admission of liability or waiver of any provision of this policy. If the Company exercises its rights under this subsection, it must do so diligently.
- (c) Whenever the Company brings an action or asserts a defense as required or permitted by this policy, the Company may pursue the litigation to a final determination by a court of competent jurisdiction, and it expressly reserves the right, in its sole discretion, to appeal any adverse judgment or order.

6. DUTY OF INSURED CLAIMANT TO COOPERATE

- (a) In all cases where this policy permits or requires the Company to prosecute or provide for the defense of any action or proceeding and any appeals, the Insured shall secure to the Company the right to so prosecute or provide defense in the action or proceeding, including the right to use, at its option, the name of the Insured for this purpose. Whenever requested by the Company, the Insured, at the Company's expense, shall give the

Company all reasonable aid (i) in securing evidence, obtaining witnesses, prosecuting or defending the action or proceeding, or effecting settlement, and (ii) in any other lawful act that in the opinion of the Company may be necessary or desirable to establish the Title or any other matter as insured. If the Company is prejudiced by the failure of the Insured to furnish the required cooperation, the Company's obligations to the Insured under the policy shall terminate, including any liability or obligation to defend, prosecute, or continue any litigation, with regard to the matter or matters requiring such cooperation.

- (b) The Company may reasonably require the Insured Claimant to submit to examination under oath by any authorized representative of the Company and to produce for examination, inspection, and copying, at such reasonable times and places as may be designated by the authorized representative of the Company, all records, in whatever medium maintained, including books, ledgers, checks, memoranda, correspondence, reports, e-mails, disks, tapes, and videos whether bearing a date before or after Date of Policy, that reasonably pertain to the loss or damage. Further, if requested by any authorized representative of the Company, the Insured Claimant shall grant its permission, in writing, for any authorized representative of the Company to examine, inspect, and copy all of these records in the custody or control of a third party that reasonably pertain to the loss or damage. All information designated as confidential by the Insured Claimant provided to the Company pursuant to this Section shall not be disclosed to others unless, in the reasonable judgment of the Company, it is necessary in the administration of the claim. Failure of the Insured Claimant to submit for examination under oath, produce any reasonably requested information, or grant permission to secure reasonably necessary information from third parties as required in this subsection, unless prohibited by law or governmental regulation, shall terminate any liability of the Company under this policy as to that claim.

7. OPTIONS TO PAY OR OTHERWISE SETTLE CLAIMS; TERMINATION OF LIABILITY

In case of a claim under this policy, the Company shall have the following additional options:

- (a) To Pay or Tender Payment of the Amount of Insurance. To pay or tender payment of the Amount of Insurance under this policy together with any costs, attorneys' fees, and expenses incurred by the Insured Claimant that were authorized by the Company up to the time of payment or tender of payment and that the Company is obligated to pay. Upon the exercise by the Company of this option, all liability and obligations of the Company to the Insured under this policy, other than to make the payment required in this subsection, shall terminate, including any liability or obligation to defend, prosecute, or continue any litigation.
- (b) To Pay or Otherwise Settle With Parties Other Than the Insured or With the Insured Claimant.
 - (i) to pay or otherwise settle with other parties for or in the name of an Insured Claimant any claim insured against under this policy. In addition, the Company will pay any costs, attorneys' fees, and expenses incurred by the Insured Claimant that were authorized by the Company up to the time of payment and that the Company is obligated to pay; or
 - (ii) to pay or otherwise settle with the Insured Claimant the loss or damage provided for under this policy, together with any costs, attorneys' fees, and expenses incurred by the Insured Claimant that were authorized by the Company up to the time of payment and that the Company is obligated to pay.

Upon the exercise by the Company of either of the options provided for in subsections (b)(i) or (ii), the Company's obligations to the Insured under this policy for the claimed loss or damage, other than the payments required to be made, shall terminate, including any liability or obligation to defend, prosecute, or continue any litigation.

CONDITIONS (Continued)

8. DETERMINATION AND EXTENT OF LIABILITY

This policy is a contract of indemnity against actual monetary loss or damage sustained or incurred by the Insured Claimant who has suffered loss or damage by reason of matters insured against by this policy.

- (a) The extent of liability of the Company for loss or damage under this policy shall not exceed the lesser of
 - (i) the Amount of Insurance; or
 - (ii) the difference between the value of the Title as insured and the value of the Title subject to the risk insured against by this policy.
- (b) If the Company pursues its rights under Section 5 of these Conditions and is unsuccessful in establishing the Title, as insured,
 - (i) the Amount of Insurance shall be increased by 10%, and
 - (ii) the Insured Claimant shall have the right to have the loss or damage determined either as of the date the claim was made by the Insured Claimant or as of the date it is settled and paid.
- (c) In addition to the extent of liability under (a) and (b), the Company will also pay those costs, attorneys' fees, and expenses incurred in accordance with Sections 5 and 7 of these Conditions.

9. LIMITATION OF LIABILITY

- (a) If the Company establishes the Title, or removes the alleged defect, lien, or encumbrance, or cures the lack of a right of access to or from the Land, or cures the claim of Unmarketable Title, all as insured, in a reasonably diligent manner by any method, including litigation and the completion of any appeals, it shall have fully performed its obligations with respect to that matter and shall not be liable for any loss or damage caused to the Insured.
- (b) In the event of any litigation, including litigation by the Company or with the Company's consent, the Company shall have no liability for loss or damage until there has been a final determination by a court of competent jurisdiction, and disposition of all appeals, adverse to the Title, as insured.
- (c) The Company shall not be liable for loss or damage to the Insured for liability voluntarily assumed by the Insured in settling any claim or suit without the prior written consent of the Company.

10. REDUCTION OF INSURANCE; REDUCTION OR TERMINATION OF LIABILITY

All payments under this policy, except payments made for costs, attorneys' fees, and expenses, shall reduce the Amount of Insurance by the amount of the payment.

11. LIABILITY NONCUMULATIVE

The Amount of Insurance shall be reduced by any amount the Company pays under any policy insuring a Mortgage to which exception is taken in Schedule B or to which the Insured has agreed, assumed, or taken subject, or which is executed by an Insured after Date of Policy and which is a charge or lien on the Title, and the amount so paid shall be deemed a payment to the Insured under this policy.

12. PAYMENT OF LOSS

When litigation and the extent of loss or damage have been definitely fixed in accordance with these Conditions, the payment shall be made within 30 days.

13. RIGHTS OF RECOVERY UPON PAYMENT OR SETTLEMENT

- (a) Whenever the Company shall have settled and paid a claim under this policy, it shall be subrogated and entitled to the rights of the Insured Claimant in the Title and all other rights and remedies in respect to the claim that the Insured Claimant has against any person or property, to the extent of the amount of any loss, costs, attorneys' fees, and expenses paid by the Company. If requested by the Company, the Insured Claimant shall execute documents to evidence the transfer to the Company of these rights and remedies. The Insured Claimant shall permit the Company to sue, compromise, or settle in the name of the Insured Claimant and to use the name of the Insured Claimant in any transaction or litigation involving these rights and remedies.

If a payment on account of a claim does not fully cover the loss of the Insured Claimant, the Company shall defer the exercise of its right to recover until after the Insured Claimant shall have recovered its loss.

- (b) The Company's right of subrogation includes the rights of the Insured to indemnities, guaranties, other policies of insurance, or bonds, notwithstanding any terms or conditions contained in those instruments that address subrogation rights.

14. ARBITRATION

Either the Company or the Insured may demand that the claim or controversy shall be submitted to arbitration pursuant to the Title Insurance Arbitration Rules of the American Land Title Association ("Rules"). Except as provided in the Rules, there shall be no joinder or consolidation with claims or controversies of other persons. Arbitrable matters may include, but are not limited to, any controversy or claim between the Company and the Insured arising out of or relating to this policy, any service in connection with its issuance or the breach of a policy provision, or to any other controversy or claim arising out of the transaction giving rise to this policy. All arbitrable matters when the Amount of Insurance is \$2,000,000 or less shall be arbitrated at the option of either the Company or the Insured. All arbitrable matters when the Amount of Insurance is in excess of \$2,000,000 shall be arbitrated only when agreed to by both the Company and the Insured. Arbitration pursuant to this policy and under the Rules shall be binding upon the parties. Judgment upon the award rendered by the Arbitrator(s) may be entered in any court of competent jurisdiction.

15. LIABILITY LIMITED TO THIS POLICY; POLICY ENTIRE CONTRACT

- (a) This policy together with all endorsements, if any, attached to it by the Company is the entire policy and contract between the Insured and the Company. In interpreting any provision of this policy, this policy shall be construed as a whole.
- (b) Any claim of loss or damage that arises out of the status of the Title or by any action asserting such claim shall be restricted to this policy.
- (c) Any amendment of or endorsement to this policy must be in writing and authenticated by an authorized person, or expressly incorporated by Schedule A of this policy.
- (d) Each endorsement to this policy issued at any time is made a part of this policy and is subject to all of its terms and provisions. Except as the endorsement expressly states, it does not (i) modify any of the terms and provisions of the policy, (ii) modify any prior endorsement, (iii) extend the Date of Policy, or (iv) increase the Amount of Insurance.

16. SEVERABILITY

In the event any provision of this policy, in whole or in part, is held invalid or unenforceable under applicable law, the policy shall be deemed not to include that provision or such part held to be invalid, but all other provisions shall remain in full force and effect.

17. CHOICE OF LAW; FORUM

- (a) Choice of Law: The Insured acknowledges the Company has underwritten the risks covered by this policy and determined the premium charged therefor in reliance upon the law affecting interests in real property and applicable to the interpretation, rights, remedies, or enforcement of policies of title insurance of the jurisdiction where the Land is located.

Therefore, the court or an arbitrator shall apply the law of the jurisdiction where the Land is located to determine the validity of claims against the Title that are adverse to the Insured and to interpret and enforce the terms of this policy. In neither case shall the court or arbitrator apply its conflicts of law principles to determine the applicable law.

- (b) Choice of Forum: Any litigation or other proceeding brought by the Insured against the Company must be filed only in a state or federal court within the United States of America or its territories having appropriate jurisdiction.

18. NOTICES, WHERE SENT

Any notice of claim and any other notice or statement in writing required to be given to the Company under this policy must be given to the Company at Claims Department at P.O. Box 2029, Houston, TX 77252-2029.

**ALTA OWNER'S POLICY OF TITLE INSURANCE
SCHEDULE A**

ISSUED BY
STEWART TITLE GUARANTY COMPANY

**Name and Address of
Title Insurance Company:**

Stewart Title Guaranty Company
P.O. Box 2029, Houston, TX 77252

File No.: 2022464

Policy No.: O-0000-340873208

Address Reference: 151 Topaz St., Ketchum, ID 83340
(For Company Reference Purposes Only)

Amount of Insurance: \$1,475,000.00

Premium: \$3,730.00

Date of Policy: November 25, 2020 at 1:20pm

1. Name of Insured:

Sallie Castle

2. The estate or interest in the Land that is insured by this policy is:

Fee Simple

3. Title is vested in:

Sallie Castle

4. The Land referred to in this policy is described as follows:

Lot 2, Block 1 of GEM STREET SUBDIVISION, as shown on the official plat thereof, recorded as Instrument No. 675967, records of Blaine County, Idaho.



SCHEDULE B

File No.: 2022464

Policy No.: O-0000-340873208

EXCEPTIONS FROM COVERAGE

This policy does not insure against loss or damage (and the Company will not pay costs, attorneys' fees or expenses) that arise by reason of:

1. Taxes or assessments which are not shown as existing liens by the records of any taxing authority that levies taxes or assessments on real property or by the public records. Proceedings by a public agency which may result in taxes or assessments, or notices of such proceedings, whether or not shown by the records of such agency or by public record.
2. Any facts, rights, interests, or claims which are not shown by the public records, but which could be ascertained by an inspection of the Land or by making inquiry of persons in possession thereof.
3. Easements, liens, or encumbrances, or claims thereof, which are not shown by the public records.
4. Discrepancies, conflicts in boundary lines, shortages in area, encroachments, or any other facts which a correct survey would disclose, and which are not shown by the public records.
5. (1) Unpatented mining claims; (2) reservations or exceptions in patents or in Acts authorizing the issuance thereof; (3) water rights, claims, or title to water.
6. Any lien or right to a lien for services, labor, or material heretofore or hereafter furnished, imposed by law and not shown by the public records.
7. Minerals of whatsoever kind, subsurface and surface substances, including but not limited to coal, lignite, oil, gas, uranium, clay, rock, sand and gravel in, on, under and that may be produced from the Land, together with all rights, privileges, and immunities relating thereto, whether or not appearing in the Public Records or listed in Schedule B. Stewart makes no representation as to the present ownership of any such interests. There may be leases, grants, exceptions or reservations of interest that are not listed.
8. General taxes for the year 2021 and subsequent years, which are a lien due not yet payable.
9. Water and sewer charges of the City of Ketchum.
10. Ketchum rubbish charges billed by Clear Creek Disposal.
11. Facts evidenced by that certain Survey, recorded June 8, 2018, as [Instrument No. 652396](#), records of Blaine County, Idaho.
12. Indemnity Agreement, including the terms and provisions thereof, by and between Fritz X. Haemmerle and Reli L. Haemmerle and the City of Ketchum, recorded November 20, 2020 as [Instrument No. 675966](#), records of Blaine County, Idaho.
13. Notes, Easements and Restrictions, as shown on the plat of Gem Street Subdivision, recorded November 20, 2020 as [Instrument No. 675967](#), records of Blaine County, Idaho.



SCHEDULE B



**Attachment B:
Application Materials – Final
Plat Plan Set**

A PLAT SHOWING REPLAT OF LOT 2 GEM STREET SUBDIVISION

WHEREIN LOT 2, BLOCK 1, GEM STREET SUBDIVISION IS SUBDIVIDED AS SHOWN HEREON
LOCATED WITHIN SECTION 18, T.4N., R.18E., B.M., CITY OF KETCHUM, BLAINE COUNTY, IDAHO

MARCH 2022



SCALE: 1" = 20'

LEGEND

- Property Boundary
- Adjoiner's Lot Line
- Easement, Type & Width as Shown
- Fence Line
- GIS Tie Line
- Found Aluminum Cap
- Found 1/2" Rebar
- Found 5/8" Rebar
- Set 5/8" Rebar, P.L.S. 16670

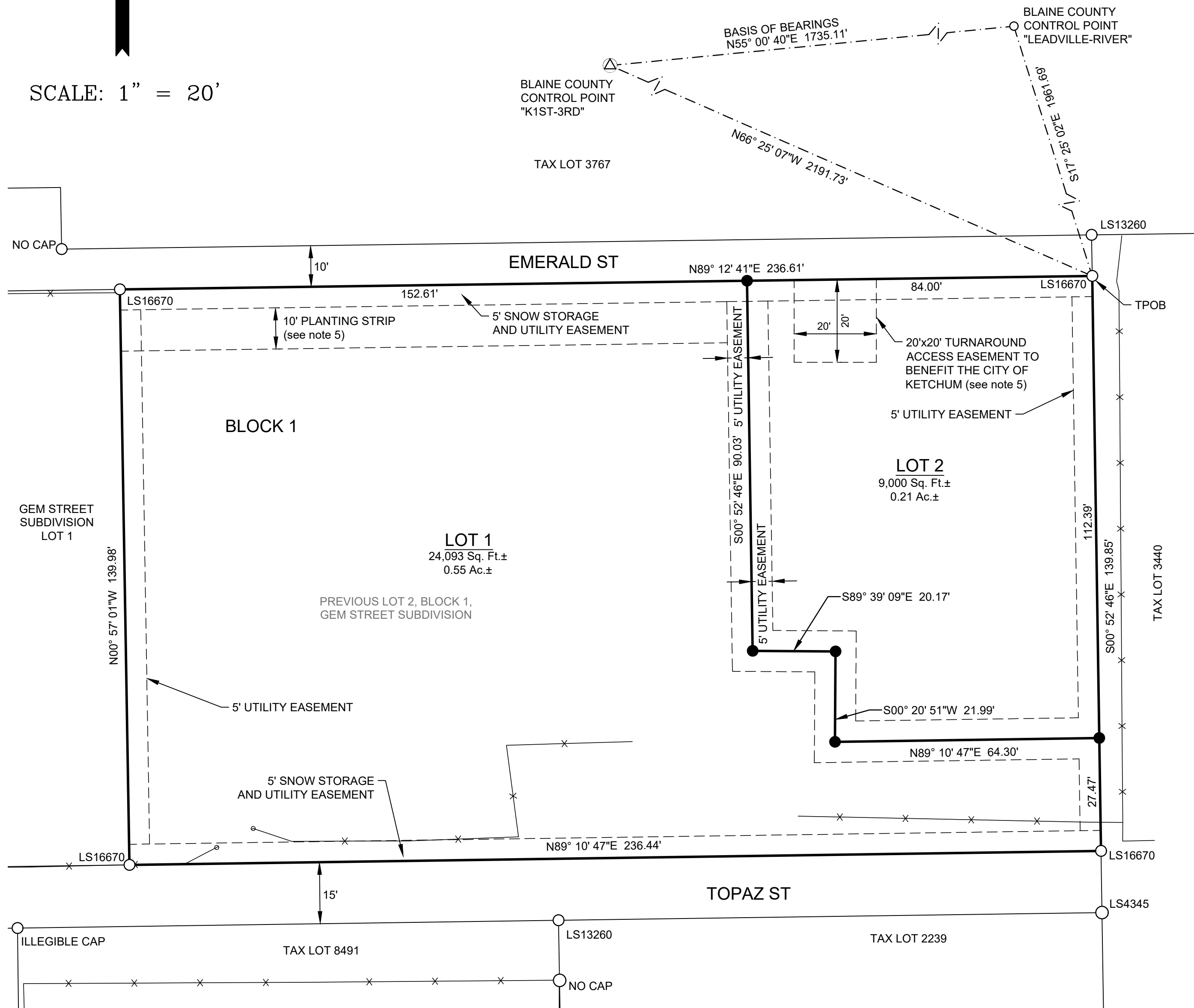

SURVEY NARRATIVE & NOTES

1. The purpose of this survey is to subdivide Lot 2, Block 1, Gem Street Subdivision into Lots 1 & 2, Block 1, Replat of Lot 2 Gem Street Subdivision as shown hereon. The boundary shown is based on found monuments, and the plat of Gem Street Subdivision, Instrument Number 675966, records of Blaine County, Idaho. All found monuments have been accepted. Additional Documents used in the course of this survey include; Warranty Deeds, Instrument Numbers 132181, 132252, 229345, & 285434, all records of Blaine County, Idaho.
2. A Title Commitment has been issued by Stewart Title Guaranty Company, File Number 2022464, with a Date of Guarantee of November 25, 2020. Certain information contained in said title policy may not appear on this map or may affect items shown hereon. It is the responsibility of the owner or agent to review said title policy. All plottable encumbrances and easements listed in the title report are shown hereon. Review of specific documents is required, if further information is desired.
3. A 5' Utility Easement exists adjacent to all exterior lot lines and centered along all interior lot lines. All utilities to be installed underground.
4. Parking of cars and other vehicles is prohibited along Emerald and Topaz Street within the City Right of Way, or within any asphalted areas of the Streets.
5. As shown hereon, within Lot 2 there exists a 20 x 20 Turnaround Access Easement to benefit the City of Ketchum. This is to be used as a turnaround for Snow Plows and Emergency Access Vehicles. Parking is not permitted within this easement. Construction of driveway curb cuts for Lot 2 shall be restricted to the turnaround access easement location shown hereon.
6. A 10' planting strip on Lot 1, as shown hereon, shall be devoted exclusively to landscaping. No vehicular access from Lot 1 onto Emerald Street is permitted.
7. A 5' snow storage easement, as shown hereon, is reserved for use by the City of Ketchum for the placement of snow removed from public rights-of-way.

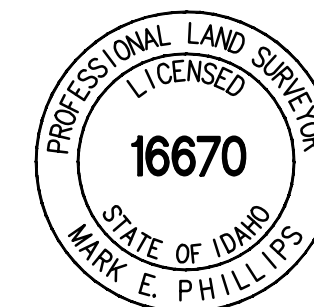

MARK E. PHILLIPS, P.L.S. 16670

REPLAT OF LOT 2 GEM STREET SUBDIVISION

GALENA ENGINEERING, INC.
HAILEY, IDAHO

SHEET 1 OF 2
Job No. 8074

HEALTH CERTIFICATE: Sanitary restrictions as required by Idaho Code Title 50, Ch. 13, have been satisfied. Sanitary restrictions may be reimposed in accordance with Idaho Code Title 50, Ch. 13, Sec. 50-1326, by issuance of a Certificate of Disapproval.

Date _____ South Central Public Health District

CERTIFICATE OF OWNERSHIP

This is to certify that the undersigned is the owner in fee simple of the following described parcel of land:

A parcel of land located within Section 18, T.4N., R.18E., B.M., City of Ketchum, Blaine County, Idaho, more particularly described as follows:

LOT 2, BLOCK 1, GEM STREET SUBDIVISION

The easements indicated hereon are not dedicated to the public, but the right to use said easements is hereby reserved for the public utilities and for any other uses indicated hereon and no permanent structures are to be erected within the lines of said easements.

I do hereby certify that all lots in this plat will be eligible to receive water service from an existing water distribution system and that the existing water distribution system has agreed in writing to serve all of units shown within this plat.

It is the intent of the owner to hereby include said land in this plat.

Sallie Castle

ACKNOWLEDGMENT

STATE OF _____ }
COUNTY OF _____ } ss

On this ____ day of _____ 2022, before me, a Notary Public in and for said State, personally appeared Sallie Castle, known or identified to me to be the person whose name is subscribed to the foregoing instrument, and acknowledged to me that he executed the same.

IN WITNESS WHEREOF, I have hereunto set my hand and affixed my official seal the day and year in this certificate first above written.

Notary Public in and for said State
Residing in _____
My Commission Expires _____

PROJECT ENGINEER'S CERTIFICATE

I, the undersigned, project engineer for a Replat of Lot 2 Gem Street Subdivision, certify that the subdivision is in accordance with the City of Ketchum Subdivision standards.

Sean M Flynn, PE 12497, Galena Engineering, INC

SURVEYOR'S CERTIFICATE

I, Mark E. Phillips, a duly Licensed Professional Land Surveyor in the State of Idaho, do hereby certify that this plat is a true and accurate map of the land and points surveyed under my direct supervision and that it is in accordance with the Idaho State Code relating to Plats, Surveys, and Condominiums and the Corner Perpetuation and Filing Act, 55-1601 through 55-1612.

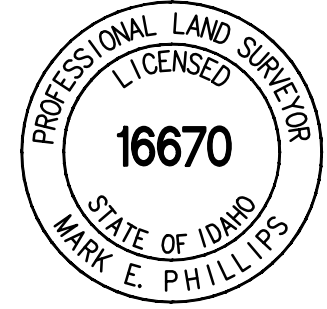

MARK E. PHILLIPS, P.L.S. 16670

BLAINE COUNTY SURVEYOR'S APPROVAL

I, Sam Young County Surveyor for Blaine County, Idaho, do hereby certify that I have checked the foregoing Plat and computations for making the same and have determined that they comply with the laws of the State of Idaho relating to Plats and Surveys.

Sam Young, P.L.S. 11577
Blaine County Surveyor

KETCHUM CITY COUNCIL CERTIFICATE

I, the undersigned, City Clerk, in and for the City of Ketchum, Blaine County, Idaho, do hereby certify that at a regular meeting of the City Council held on the ____ day of _____, 2022, this plat was duly accepted and approved.

Tara Fenwick, City Clerk, City of Ketchum

KETCHUM CITY ENGINEER CERTIFICATE

I, the undersigned, City Engineer in and for the City of Ketchum, Blaine County, Idaho, do hereby approve this plat on this ____ day of _____, 2022, and certify that it is in accordance with the City of Ketchum subdivision ordinance.

Sherri Newland, City Engineer, City of Ketchum

KETCHUM CITY PLANNER CERTIFICATE

I, the undersigned, Planner in and for the City of Ketchum, Blaine County, Idaho, do hereby approve this plat on this ____ day of _____, 2022, and certify that it is in accordance with the City of Ketchum subdivision ordinance.

Morgan Landers, City of Ketchum

BLAINE COUNTY TREASURER'S APPROVAL

I, the undersigned County Treasurer in and for Blaine County, State of Idaho per the requirements of Idaho Code 50-1308, do hereby certify that any and all current and/or delinquent county property taxes for the property included in this subdivision have been paid in full. This certification is valid for the next thirty (30) days only.

Blaine County Treasurer

Date

BLAINE COUNTY RECORDER'S CERTIFICATE

REPLAT OF LOT 2 GEM
STREET SUBDIVISION

GALENA ENGINEERING, INC.
HAILEY, IDAHO

SHEET 2 OF 2
Job No. 8074

Attachment C:
**Draft – Findings of Fact,
Conclusions of Law, and
Decision**



City of Ketchum
Planning & Building

IN RE:)	
)	
151 Topaz Street)	KETCHUM CITY COUNCIL
Subdivision – Final Plat)	FINDINGS OF FACT, CONCLUSIONS OF LAW, AND
Date: April 4, 2022)	DECISION
)	
File Number: 21-102)	

PROJECT: 151 Topaz Street Subdivision

APPLICATION TYPE: Subdivision – Final Plat

FILE NUMBER: P21-102

ASSOCIATED APPLICATIONS: Subdivision Preliminary Plat (P21-034)

REPRESENTATIVE: Sean Flynn, Galena Engineering (Engineer)

OWNER: Sallie Castle

LOCATION: 151 Topaz (Lot 2, Block 1 – Gem Street Subdivision)

ZONING: Limited Residential (LR)

OVERLAY: None

RECORD OF PROCEEDINGS

The City of Ketchum received the application for the Subdivision Final Plat for the project on December 16, 2021. The application was deemed complete on February 1, 2022, after one review for completeness. Following receipt of the complete application, staff routed the application materials to all city departments for review. Department comments were provided to the applicant on February 24, 2022.

BACKGROUND

The Applicant is proposing to subdivide Lot 2 of the Gem Street Subdivision, located at 151 Topaz Street (the “subject property”) into two lots (the “project”). The subject property is zoned Limited Residential (LR) and has an existing single family dwelling unit and detached garage. The project proposes to retain the existing single family dwelling unit and garage and create a new 9,000 square foot lot on the eastern portion of the existing lot. The subdivision preliminary plat for the project was reviewed and approved by the Planning and Zoning Commission on October 26, 2021 and the City Council on November 18, 2021.

FINDINGS OF FACT

The Council, having reviewed the entire project record, provided notice, conducted the required public hearing, and considered the recommendation from the Planning and Zoning Commission, does hereby make and set forth these Findings of Fact, Conclusions of Law, and Decision as follows:

FINDINGS REGARDING CONFORMANCE WITH THE PRELIMINARY PLAN

The subdivision preliminary plat was approved by the Ketchum City Council on November 18, 2021 with six conditions of approval. Below is an overview of the conditions and how the project is in conformance with each:

Condition #1: Prior to construction of required improvements, construction plans for proposed improvements to Emerald Street shall be reviewed and approved by the City Engineer.

- The applicant submitted construction plans and an estimate for the cost of construction with the application materials received for the application deemed complete on February 1, 2022.

Condition #2: The Final Plat application shall include a plat note restricting construction of driveway curb cuts on the new lot to the turnaround access easement location as shown on the preliminary plat.

- As shown on Sheet 1 of the Final Plat, plat note #5 indicates the permitted location of the driveway.

Condition #3: All fences located within snow storage easements must either be relocated or removed entirely and verified by a member of the City of Ketchum Planning staff, prior to approval of the Final Plat.

- As of the date of these findings, all fences have been removed.

Condition #4 - The Final Plat application shall not include Plat note 3 provided that all fences have been adequately removed or relocated.

- The referenced plat note has been removed per the condition.

Condition #5 - All right-of-way improvements shall be completed and accepted by the City of Ketchum City Engineer prior to approval of the Final Plat.

- Due to current weather, the owner is not able to construct the right-of-way improvements at this time. KMC Section 16.04.040.C - Performance Bond, allows the City Council to approve a Security Agreement stipulating the timing of required improvements in situations like this. The regulation requires the Owner to provide a performance bond to the City in the amount of 150% of the construction cost estimate. A Security Agreement was approved by City Council on April 4, 2022. The agreement outlines the required improvements, timing for completion, process for acceptance, and release of the performance bond. If the work is not completed by the date of the agreement, the city may elect to use the funds and complete the work according to the agreement. The Owner has a designated contractor for the work and a bid for the work showing completion of the project no later than August 15, 2022. This is an acceptable timeframe for the work provided it will be completed prior to winter 2022, when the improvements are most critical.

Condition #6 - Failure to record a Final Plat within two (2) years of Council's approval of a Preliminary Plat shall cause the Preliminary Plat to be null and void.

- The Final Plat was approved on April 4, 2022, approximately four months following preliminary plat approval. As outlined in condition of approval 2 for the final plat, the final plat must be recorded within one year of Council approval, April 4, 2023. Based on this timeframe, the final plat would be recorded within two year's of Council's approval of the preliminary plat.

FINDINGS REGARDING PRELIMINARY PLAT SUBDIVISION REQUIREMENTS

Preliminary Plat Requirements				
Compliant			City Code	City Standards
Yes	No	N/A		
<input checked="" type="checkbox"/>	<input type="checkbox"/>	<input type="checkbox"/>	16.04.030.K.1	Point of beginning of subdivision description tied to at least two governmental survey corners, or in lieu of government survey corners, to monuments recognized by the City Engineer.
			<i>Findings</i>	The City Engineer verified that the final plat includes this element, as shown on Sheet 1 of the Final Plat.
<input checked="" type="checkbox"/>	<input type="checkbox"/>	<input type="checkbox"/>	16.04.030.K.2	Location and description of monuments.
			<i>Findings</i>	The City Engineer verified that the final plat includes this element, as shown on Sheet 1 of the Final Plat.
<input checked="" type="checkbox"/>	<input type="checkbox"/>	<input type="checkbox"/>	16.04.030.K.3	Tract boundary lines, property lines, lot lines, street right-of-way lines and centerlines, other rights-of-way and easement lines, building envelopes as required on the preliminary plat, lot area of each lot, boundaries of floodplain and floodway and avalanche district, all with bearings, accurate dimensions in feet and decimals, in degrees and minutes and radii, arcs, central angles, tangents and chord lengths of all curves to the above accuracy.
			<i>Findings</i>	As shown on Sheet 1, all elements of the preliminary plat are included on the final plat. Conditions of approval required the removal of certain plat notes as outlined above, and those have been removed. Required additional plat notes have been added. The final plat also shows all required easements for snow storage, turnaround access, planting strip, and utilities.
<input checked="" type="checkbox"/>	<input type="checkbox"/>	<input type="checkbox"/>	16.04.030.K.4	Names and locations of all adjoining subdivisions.
			<i>Findings</i>	As shown on Sheet 1, the property is adjacent to the Gem Street Subdivision, and multiple tax lots.
<input checked="" type="checkbox"/>	<input type="checkbox"/>	<input type="checkbox"/>	16.04.030.K.5	Name and right-of-way width of each street and other public rights-of-way.
			<i>Findings</i>	As shown on Sheet 1, rights-of-way and widths are shown for Emerald and Topaz Streets.
<input checked="" type="checkbox"/>	<input type="checkbox"/>	<input type="checkbox"/>	16.04.030.K.6	Location, dimension and purpose of all easements, public or private.
			<i>Findings</i>	As shown on Sheet 1, all easements are outlined and dimensioned. The plat notes on sheet 1 outline the purpose of all the easements.
<input checked="" type="checkbox"/>	<input type="checkbox"/>	<input type="checkbox"/>	16.04.030.K.7	The blocks numbered consecutively throughout each block.
			<i>Findings</i>	As shown on Sheet 1, there is only one block for the subdivision which is identified in the legal description.
<input type="checkbox"/>	<input type="checkbox"/>	<input checked="" type="checkbox"/>	16.04.030.K.8	The outline of any property, other than a street, alley or easement, which is offered for dedication to public use, fully dimensioned by distances and

				bearings with the area marked "Dedicated to the City of Ketchum for Public Use", together with any other descriptive language with regard to the precise nature of the use of the land so dedicated.
			<i>Findings</i>	N/A - No other dedications are proposed other than the snow storage easement and turnaround easement.
<input checked="" type="checkbox"/>	<input type="checkbox"/>	<input type="checkbox"/>	16.04.030.K.9	The title, which shall include the name of the subdivision, the name of the City, if appropriate, county and state, and the location and description of the subdivision referenced to section, township, range.
			<i>Findings</i>	As shown on Sheet 1, the title of the final plat includes all required information.
<input checked="" type="checkbox"/>	<input type="checkbox"/>	<input type="checkbox"/>	16.04.030.K.10	Scale, north arrow and date.
			<i>Findings</i>	The scale, north arrow, and date are included on Sheet 1 of the final plat.
<input checked="" type="checkbox"/>	<input type="checkbox"/>	<input type="checkbox"/>	16.04.030.K.11	Location, width, and names of all existing or dedicated streets and other public ways within or adjacent to the proposed subdivision.
			<i>Findings</i>	The final plat designates Emerald Street and Topaz Street, which are the only existing streets. No additional streets are being created or dedicated.
<input type="checkbox"/>	<input type="checkbox"/>	<input checked="" type="checkbox"/>	16.04.030.K.12	A plat note provision referencing the County Recorder's instrument number where the condominium declaration(s) and/or articles of incorporation of homeowners' association governing the subdivision are recorded.
			<i>Findings</i>	N/A – this final plat does not include the creation of a condominium or any common area requiring declarations or articles of incorporation.
<input checked="" type="checkbox"/>	<input type="checkbox"/>	<input type="checkbox"/>	16.04.030.K.13	Certificate by registered engineer or surveyor preparing the map certifying to the accuracy of surveying plat.
			<i>Findings</i>	Sheet 2 of the final plat includes a Surveyor Certificate and a Project Engineer Certificate.
<input checked="" type="checkbox"/>	<input type="checkbox"/>	<input type="checkbox"/>	16.04.030.K.14	A current title report of all property contained within the plat shall be provided to the City and used, in part, as the basis for the dedication of easements and encumbrances on the property.
			<i>Findings</i>	The title report, dated November 25, 2020, was used in the preparation of the final plat and is referenced in plat note 2 on Sheet 1 of the final plat.
<input checked="" type="checkbox"/>	<input type="checkbox"/>	<input type="checkbox"/>	16.04.030.K.15	Certification of owner(s) of record and all holders of security interest(s) of record with regard to such property.
			<i>Findings</i>	Sheet 2 of the final plat includes the current owner of record information.
<input checked="" type="checkbox"/>	<input type="checkbox"/>	<input type="checkbox"/>	16.04.030.K.16	Certification and signature of engineer (surveyor) verifying that the subdivision and design standards meet all City requirements.
			<i>Findings</i>	Sheet 2 includes a Project Engineer Certificate.
<input checked="" type="checkbox"/>	<input type="checkbox"/>	<input type="checkbox"/>	16.04.030.K.17	Certification and signature of the City Engineer verifying that the subdivision and design standards meet all City requirements.
			<i>Findings</i>	Sheet 2 includes a City Engineer Certificate.
<input checked="" type="checkbox"/>	<input type="checkbox"/>	<input type="checkbox"/>	16.04.030.K.18	Certification and signature of the City Clerk of the City of Ketchum verifying that the subdivision has been approved by the council.
			<i>Findings</i>	Sheet 2 includes a City Clerk Certificate.
<input checked="" type="checkbox"/>	<input type="checkbox"/>	<input type="checkbox"/>	16.04.030.K.19	Notation of any additional restrictions imposed by the council on the development of such subdivision to provide for the public health, safety and welfare.
			<i>Findings</i>	The plat notes shown on Sheet 1 cover all requirements of the preliminary plat, any restrictive plat notes from the previous subdivision. Sheet 1 also includes the Health Certificate.

<input checked="" type="checkbox"/>	<input type="checkbox"/>	<input type="checkbox"/>	16.04.040.B	Improvement Plans: Prior to approval of final plat by the commission, the subdivider shall file two (2) copies with the city engineer, and the city engineer shall approve construction plans for all improvements required in the proposed subdivision. Such plans shall be prepared by a civil engineer licensed in the state.
			<i>Findings</i>	As part of the application materials, the applicant submitted design drawings for the public improvements required. The plans were prepared by a civil engineer licensed in the state. The plans were reviewed and approved by the City Engineer.
<input checked="" type="checkbox"/>	<input type="checkbox"/>	<input type="checkbox"/>	16.04.040.C	Prior to final plat approval, the subdivider shall have previously constructed all required improvements and secured a certificate of completion from the city engineer. However, in cases where the required improvements cannot be constructed due to weather conditions or other factors beyond the control of the subdivider, the city council may accept, in lieu of any or all of the required improvements, a performance bond filed with the city clerk to ensure actual construction of the required improvements as submitted and approved. Such performance bond shall be issued in an amount not less than one hundred fifty percent (150%) of the estimated costs of improvements as determined by the city engineer. In the event the improvements are not constructed within the time allowed by the city council (which shall be one year or less, depending upon the individual circumstances), the council may order the improvements installed at the expense of the subdivider and the surety. In the event the cost of installing the required improvements exceeds the amount of the bond, the subdivider shall be liable to the city for additional costs. The amount that the cost of installing the required improvements exceeds the amount of the performance bond shall automatically become a lien upon any and all property within the subdivision owned by the owner and/or subdivider.
			<i>Findings</i>	As outlined above, Security Agreement #22761 was approved by City Council on April 4, 2022 outlining the amount of the performance bond, timing of improvements, and penalties for non-completion per the provisions of this section.
<input checked="" type="checkbox"/>	<input type="checkbox"/>	<input type="checkbox"/>	16.04.040.D	As Built Drawing: Prior to acceptance by the city council of any improvements installed by the subdivider, two (2) sets of as built plans and specifications, certified by the subdivider's engineer, shall be filed with the city engineer. Within ten (10) days after completion of improvements and submission of as built drawings, the city engineer shall certify the completion of the improvements and the acceptance of the improvements, and shall submit a copy of such certification to the administrator and the subdivider. If a performance bond has been filed, the administrator shall forward a copy of the certification to the city clerk. Thereafter, the city clerk shall release the performance bond upon application by the subdivider.
			<i>Findings</i>	Security Agreement #22761 outlines the requirement for as-built drawings per the provisions of this section.
<input checked="" type="checkbox"/>	<input type="checkbox"/>	<input type="checkbox"/>	16.04.040.E	Monumentation: Following completion of construction of the required improvements and prior to certification of completion by the city engineer, certain land survey monuments shall be reset or verified by the subdivider's engineer or surveyor to still be in place. These monuments shall have the size,

			<p>shape, and type of material as shown on the subdivision plat. The monuments shall be located as follows:</p> <ol style="list-style-type: none"> 1. All angle points in the exterior boundary of the plat. 2. All street intersections, points within and adjacent to the final plat. 3. All street corner lines ending at boundary line of final plat. 4. All angle points and points of curves on all streets. 5. The point of beginning of the subdivision plat description.
		<i>Findings</i>	

CONCLUSIONS OF LAW

1. The City of Ketchum is a municipal corporation established in accordance with Article XII of the Constitution of the State of Idaho and Title 50 Idaho Code and is required and has exercised its authority pursuant to the Local Land Use Planning Act codified at Chapter 65 of Title 67 Idaho Code and pursuant to Chapters 3, 9 and 13 of Title 50 Idaho Code to enact the ordinances and regulations, which ordinances are codified in the Ketchum Municipal Code (“KMC”) and are identified in the Findings of Fact and which are herein restated as Conclusions of Law by this reference and which City Ordinances govern the applicant’s Townhouse Preliminary Plat application for the development and use of the project site.
2. The Council has authority to review and recommend approval of the applicant’s Subdivision Preliminary Plat Application pursuant to Chapter 16.04 of Ketchum Code Title 16.
3. The City of Ketchum Planning Department provided notice for the review of this application in accordance with Ketchum Municipal Code §16.04.030.
4. The Subdivision Preliminary Plat application is governed under Chapter 16.04 of Ketchum Municipal Code.
5. The 151 Topaz St Subdivision Preliminary Plat application meets all applicable standards specified in Title 16 of Ketchum Municipal Code.

DECISION

THEREFORE, the City Council **approves** this Final Plat Application File No. P21-102 this Monday, April 4, 2022, subject to the following conditions of approval.

CONDITIONS OF APPROVAL

1. Prior to recording of the Final Plat, the Security Agreement must be fully executed by all parties, and the performance bond must be received by the City of Ketchum.
2. Failure to record the Final Plat within one year of Council’s approval of the Final Plat shall cause the Final Plat to be null and void.

Findings of Fact **adopted** this 4th day of April 2022.

Neil Bradshaw, Mayor
City of Ketchum

**Attachment D:
Security Agreement 22761 and
Exhibits**

**SECURITY AGREEMENT FOR PUBLIC
INFRASTRUCTURE
AGREEMENT #22761**

Parties:

City of Ketchum	"City"	P.O. Box 2315, 151 5 TH Ave W, Ketchum, Idaho 83340
Sallie Castle	"Owner"	P.O. Box 2422 Ketchum, ID 83340

This Security Agreement ("Agreement") is entered into as of the ___ day of _____ 2022, by and between the City of Ketchum, an Idaho municipal corporation ("City") and Sallie Castle ("Owner").

RECITALS

- A. The Owner is the owner of real property located at 151 Topaz Street, Ketchum, ID 83340, Parcel Number RPK06150010020 (the "subject property").
- B. On November 18, 2021, a Subdivision Preliminary Plat was approved for the subject property (File No. 21-034), which subdivides the existing single lot into two separate lots.
- C. Pursuant to Preliminary Plat (File No. P21-034) approvals, the Owner is responsible for widening the asphalt on Emerald Street to a consistent 20 feet wide from the western property boundary to the eastern edge of the Turnaround Access Easement on the newly created lot. The Owner is also responsible for extension of water and sewer utilities to the newly created lot. The scope of work, design, and construction details for the asphalt widening and utility extension is shown on Exhibit A (the "Work").
- D. The Owner indicated to the City that required improvements cannot be constructed due to weather and requests approval of the final plat prior to completion of required improvements per the provisions of Ketchum Municipal Code (KMC) 16.04.040.C.- *Performance Bond*.
- E. Pursuant to KMC 16.04.040.C, City has requested certain financial assurance of Owner's performance of obligations relative to the asphalt widening and utility extensions.
- F. City received a cost estimate for the Work from a qualified construction and engineering professional as outlined in Exhibit B.

THEREFORE, in consideration of the mutual agreement herein contained and subject to the terms and conditions stated, it is hereby understood and agreed upon by the Parties as follows:

1. **Performance Bond.** Prior to recording of the Final Plat, the Owner shall supply either a personal check or cashier's check in the amount of 150% of the amount indicated in Exhibit B, which is \$44,935.5.
2. **Completion.** The deadline for completion of the Work shall be not later than August 15, 2022. In the event the improvements are not constructed within the time allowed by this Agreement, the City may proceed with installation of the improvements. Such improvements shall be installed at the expense of the Owner. Owner shall be notified in writing of intent to draw funds from the performance bond. In the event the cost of installing the required improvements exceeds the amount of the bond, the Owner shall be liable to the City for additional costs. The amount that the cost of installing the required improvements exceeds the amount of the performance bond shall automatically become a lien upon any and all property owned by the Owner.
3. **Inspection.** The Owner, in completing the Work, shall make such available for City inspection, confirmation of compliance with City standards, and acceptance, by the City Engineer, prior to the City's return of the performance bond.
4. **As Built Drawings.** Following acceptance of the Work by the City Engineer, Owner shall provide two (2) sets of as built plans and specifications, certified by the Owner's engineer, to the City.
5. **Return of Guarantee.** Following acceptance of the Work by the City Engineer and receipt of as-built plans and specifications, City shall return the full amount of the performance guarantee to the Owner within 30 working days.
6. **Warranties and Guarantees.** Owner warrants and guarantees to City that all Work will be in accordance with the approvals and contracts associated with the Project and will not be defective. City and its officers, directors, members, partners, employees, agents, consultants, and subcontractors shall be entitled to rely on Owner's warranty and guarantee.
7. **Correction Period.** If within eighteen (18) months after the date of acceptance, any portion of the Work is found to be defective, or if the repair of any damages to the Property, adjacent areas that Owner has arranged to use through construction easements or otherwise, and other adjacent areas used by Owner as permitted by Laws and Regulations, is found to be defective, then Owner shall promptly and without cost to City, correct such defective Work.
8. **Amendments.** This Agreement may not be amended, modified, altered or changed in any respect whatsoever, except by further agreement in writing executed by the parties in the manner the Agreement was approved.
9. **Binding Effect.** This Agreement shall be binding upon the heirs, estates, personal representatives, successors, and assigns of the parties.

- 10. **Attorney Fees and Costs.** If any action at law or in equity is necessary to enforce or interpret the terms of this Agreement, the prevailing party shall be entitled to reasonable attorney's fees, costs and necessary disbursements in addition to any other relief to which such party may be entitled.

- 11. **Notices.** Any notice under this Agreement shall be in writing and shall be treated as duly delivered if the same is personally delivered or deposited in the United States mail, certified, return receipt requested, postage prepaid, and properly addressed to the contacts as specified at the beginning of this Agreement.

- 12. **Partial Invalidity.** Whenever possible, each provision of this Agreement shall be interpreted in such a way as to be effective and valid under applicable law. If a provision of this Agreement is prohibited by or invalid under applicable law, it shall be ineffective only to the extent of such prohibition or invalidity, without invalidating the remainder of such provision or the remaining provisions of this Agreement.

DATED THIS ____ DAY OF _____ 2022.

Owner

City of Ketchum

Sallie Castle

Neil Bradshaw, Mayor

Attest:

Tara Fenwick, City Clerk

Exhibit A:
Right-of-Way Improvements
Design and Construction
Specifications

GENERAL CONSTRUCTIONS NOTES

- ALL CONSTRUCTION SHALL BE IN CONFORMANCE WITH THE MOST CURRENT EDITION OF THE "IDAHO STANDARDS FOR PUBLIC WORKS CONSTRUCTION" (ISPMC) AND CITY OF KETCHUM STANDARDS. THE CONTRACTOR SHALL BE RESPONSIBLE FOR OBTAINING AND KEEPING A COPY OF THE ISPMC AND CITY OF KETCHUM STANDARDS ON SITE DURING CONSTRUCTION.
- THE LOCATION OF EXISTING UNDERGROUND UTILITIES ARE SHOWN ON THE PLANS IN AN APPROXIMATE WAY. THE CONTRACTOR SHALL BE RESPONSIBLE FOR LOCATING EXISTING UTILITIES PRIOR TO COMMENCING AND DURING THE CONSTRUCTION. THE CONTRACTOR AGREES TO BE FULLY RESPONSIBLE FOR ANY AND ALL DAMAGES WHICH RESULT FROM HIS FAILURE TO ACCURATELY LOCATE AND PRESERVE ANY AND ALL UNDERGROUND UTILITIES. CONTRACTOR SHALL CALL DIGLINE (1-800-342-1585) TO LOCATE ALL EXISTING UNDERGROUND UTILITIES A MINIMUM OF 48 HOURS IN ADVANCE OF EXCAVATION.
- CONTRACTOR SHALL COORDINATE RELOCATIONS OF DRY UTILITY FACILITIES (POWER, CABLE, PHONE, TV) WITH THE APPROPRIATE UTILITY FRANCHISE.
- THE CONTRACTOR SHALL CLEAN UP THE SITE AFTER CONSTRUCTION SO THAT IT IS IN A CONDITION EQUAL TO OR BETTER THAN THAT WHICH EXISTED PRIOR TO CONSTRUCTION.
- THE CONTRACTOR SHALL OBTAIN ALL NECESSARY PERMITS PRIOR TO CONSTRUCTION (THIS MAY INCLUDE ENCROACHMENT PERMITS AND NATIONAL POLLUTANT DISCHARGE ELIMINATION SYSTEM (NPDES) CONSTRUCTION GENERAL PERMIT (CGP) PERMIT COVERAGE).
- ALL CLEARING & GRUBBING SHALL CONFORM TO ISPMC SECTION 201.
- ALL EXCAVATION & EMBANKMENT SHALL CONFORM TO ISPMC SECTION 202. SUBGRADE SHALL BE EXCAVATED AND SHAPED TO LINE, GRADE, AND CROSS-SECTION PLANS. THE SUBGRADE SHALL BE COMPACTED TO 95% OF MAXIMUM DENSITY AS DETERMINED BY ASTM D-698. THE CONTRACTOR SHALL WATER OR AERATE SUBGRADE AS NECESSARY TO OBTAIN OPTIMUM MOISTURE CONTENT. IN-LIEU OF DENSITY MEASUREMENTS, THE SUBGRADE MAY BE PROOF-ROLLED TO THE APPROVAL OF THE ENGINEER.
 - **PROOF-ROLLING:** AFTER EXCAVATION TO THE SUBGRADE ELEVATION AND PRIOR TO PLACING COURSE GRAVEL, THE CONTRACTOR SHALL PROOF ROLL THE SUBGRADE WITH A 5-TON SMOOTH DRUM ROLLER, LOADED WATER TRUCK, OR LOADED DUMP TRUCK, AS ACCEPTED BY THE ENGINEER. THE CONTRACTOR SHALL IMMEDIATELY NOTIFY THE ENGINEER OF UNSUITABLE SUBGRADE MATERIAL AREAS, AND/OR AREAS NOT CAPABLE OF COMPACTION ACCORDING TO THESE SPECIFICATIONS. UNSUITABLE OR DAMAGED SUBGRADE IS WHEN THE SOIL MOVES, PUMPS AND/OR DISPLACES UNDER ANY TYPE OF PRESSURE INCLUDING FOOT TRAFFIC LOADS.
 - IF, IN THE OPINION OF THE ENGINEER, THE CONTRACTOR'S OPERATIONS RESULT IN DAMAGE TO, OR PROTECTION OF, THE SUBGRADE, THE CONTRACTOR SHALL, AT HIS OWN EXPENSE, REPAIR THE DAMAGED SUBGRADE BY OVER-EXCAVATION OF UNSUITABLE MATERIAL TO FIRM SUBSOIL, LINE EXCAVATION WITH GEOTEXTILE FABRIC, AND BACKFILL WITH PIT RUN GRAVEL.
- ALL 2" MINUS GRAVEL SHALL CONFORM TO ISPMC 802, TYPE II (ITD STANDARD 703.04, 2"), SHALL BE PLACED IN CONFORMANCE WITH ISPMC SECTION 801 AND COMPACTED PER SECTION 202. MINIMUM COMPACTION OF PLACED MATERIAL SHALL BE 90% OF MAXIMUM LABORATORY DENSITY AS DETERMINED BY AASHTO T-99.
- ALL 3/4" MINUS CRUSHED GRAVEL SHALL CONFORM TO ISPMC 802, TYPE I (ITD STANDARD 703.04, 3/4" B), SHALL BE PLACED IN CONFORMANCE WITH ISPMC SECTION 802 AND COMPACTED PER SECTION 202. MINIMUM COMPACTION OF PLACED MATERIAL SHALL BE 95% OF MAXIMUM LABORATORY DENSITY AS DETERMINED BY AASHTO T-99 OR ITD T-91.
- ALL ASPHALTIC CONCRETE PAVEMENT WORK SHALL CONFORM TO ISPMC SECTION(S) 805, 810, AND 811 FOR CLASS II PAVEMENT. ASPHALT AGGREGATE SHALL BE 1/2" (13MM) NOMINAL SIZE CONFORMING TO TABLE 803B IN ISPMC SECTION 803. ASPHALT BINDER SHALL BE PG 58-28 CONFORMING TO TABLE A-1 IN ISPMC SECTION 805.
- ASPHALT SAWCUTS SHALL BE AS INDICATED ON THE DRAWINGS, OR 24" INCHES FROM EDGE OF EXISTING ASPHALT, IF NOT INDICATED OTHERWISE SO AS TO PROVIDE A CLEAN PAVEMENT EDGE FOR MATCHING. NO WHEEL CUTTING SHALL BE ALLOWED. PRIOR TO REPLACING ASPHALT, THE UNDERLYING SURFACE INCLUDING VERTICAL SAWCUT JOINTS SHALL BE CLEANED OF ALL DEBRIS AND A TACK COAT SHALL BE APPLIED TO ALL CURBS, SAWCUTS, OR OVERLAY SURFACES.
- TRAFFIC CONTROL SHALL BE PER THE TRAFFIC CONTROL PLAN. CONTRACTOR WILL NEED TO MAINTAIN ACCESS TO ALL PRIVATE PROPERTIES, UNLESS OTHERWISE COORDINATE WITH THE PROPERTY OWNER THROUGH THE CITY ENGINEER.
- ALL CONCRETE WORK SHALL CONFORM TO ISPMC SECTIONS 701, 703, AND 705. ALL CONCRETE SHALL BE 3,000 PSI MINIMUM, 28 DAY, AS DEFINED IN ISPMC SECTION 703, TABLE 1, IMMEDIATELY AFTER PLACEMENT PROTECT CONCRETE BY APPLYING MEMBRANE-FORMING CURING COMPOUND, TYPE 2, CLASS A PER ASTM C 309-94. APPLY CURING COMPOUND PER MANUFACTURER'S INSTRUCTIONS AND SPECIFICATIONS.
- ALL TRENCHING SHALL CONFORM TO ISPMC STANDARD DRAWING SD-301. TRENCHES SHALL BE BACKFILLED AND COMPACTED TO A MINIMUM OF 95% OF MAXIMUM DENSITY AS DETERMINED BY AASHTO T-99.
- PER IDAHO CODE § 55-1613, THE CONTRACTOR SHALL RETAIN AND PROTECT ALL MONUMENTS, ACCESSORIES TO CORNERS, BENCHMARKS AND POINTS SET IN CONTROL SURVEYS. ALL MONUMENTS, ACCESSORIES TO CORNERS, BENCHMARKS AND POINTS SET IN CONTROL SURVEYS THAT ARE LOST OR DISTURBED BY CONSTRUCTION SHALL BE REESTABLISHED AND RE-MONUMENTED, AT THE EXPENSE OF THE AGENCY OR PERSON CAUSING THEIR LOSS OR DISTURBANCE AT THEIR ORIGINAL LOCATION OR BY SETTING OF A WITNESS CORNER OR REFERENCE POINT OR A REPLACEMENT BENCHMARK OR CONTROL POINT, BY OR UNDER THE DIRECTION OF A PROFESSIONAL LAND SURVEYOR.
- CONSTRUCTION OF WATER MAINS AND ALL OTHER RELATED APPURTENANCES SHALL BE IN ACCORDANCE WITH THE IDAHO STANDARDS FOR PUBLIC WORKS CONSTRUCTION (ISPMC), IDAPA 58.01.08, IDAHO RULES FOR PUBLIC DRINKING WATER SYSTEMS AND THE CITY OF KETCHUM UTILITIES DEPARTMENT STANDARDS.
- CONTRACTOR SHALL PRESSURE TEST, DISINFECT, AND CONDUCT BIOLOGICAL TESTING IN ACCORDANCE WITH THE IDAHO STANDARDS FOR PUBLIC WORKS CONSTRUCTION (ISPMC), AMERICAN WATER WORKS ASSOCIATION (AWWA) STANDARDS, AND THE PRESSURE TESTING, DISINFECTION, AND MICROBIOLOGICAL TESTING PROCEDURES.
- CONSTRUCTION OF WATER SERVICES AND ALL OTHER RELATED APPURTENANCES SHALL BE IN ACCORDANCE WITH THE IDAHO STANDARDS FOR PUBLIC WORKS CONSTRUCTION (ISPMC), IDAPA 58.01.08, IDAHO RULES FOR PUBLIC DRINKING WATER SYSTEMS AND THE CITY OF KETCHUM UTILITIES DEPARTMENT STANDARDS.
- CONTRACTOR SHALL PRESSURE TEST, DISINFECT, AND CONDUCT BIOLOGICAL TESTING IN ACCORDANCE WITH THE IDAHO STANDARDS FOR PUBLIC WORKS CONSTRUCTION (ISPMC), AMERICAN WATER WORKS ASSOCIATION (AWWA) STANDARDS, AND THE PRESSURE TESTING, DISINFECTION, AND MICROBIOLOGICAL TESTING PROCEDURES.
- ALL WATER SUPPLY FIXTURES, FITTINGS, PIPING, AND ALL RELATED APPURTENANCES SHALL BE ANS/NSF STD. 61 COMPLIANT.
- ALL WATER SUPPLY FIXTURES, FITTINGS, PIPING, AND ALL RELATED APPURTENANCES SHALL COMPLY WITH THE LOW LEAD ACT REQUIRING ALL MATERIALS TO HAVE A LEAD CONTENT EQUAL TO OR LESS THAN 0.25%.
- THE CONTRACTOR SHALL USE ANS/NSF STANDARD 60 CHEMICALS AND COMPOUNDS DURING INSTALLATION & DISINFECTION OF POTABLE WATER LINES.
- CONTRACTOR SHALL COORDINATE LOCATIONS OF DRY UTILITY FACILITIES (POWER, CABLE, PHONE, TV) NOT SHOWN ON THE DRAWING WITH IDAHO POWER AND/OR UTILITY FRANCHISE.
- THE CONTRACTOR SHALL BE RESPONSIBLE FOR HIRING A MATERIALS TESTING COMPANY DURING CONSTRUCTION TO VERIFY ALL COMPACTION AND MATERIAL PLAN AND SPECIFICATION REQUIREMENTS ARE MET. QUALITY CONTROL DOCUMENTATION OF TESTING FOR WORK IN RIGHT-OF-WAY MEETING CITY OF KETCHUM CODE SECTION 12.04.040 (CONCRETE, AGGREGATE BASE COMPACTION, ASPHALT COMPACTION) WILL BE NECESSARY FOR CERTIFICATE OF OCCUPANCY.
- BOUNDARY INFORMATION SHOWN HEREON ARE PER A SURVEY CONDUCTED BY GALENA ENGINEERING 12/02/2019. CONTOUR DATA IS PER BLAINE COUNTY LIDAR DATED 2015.

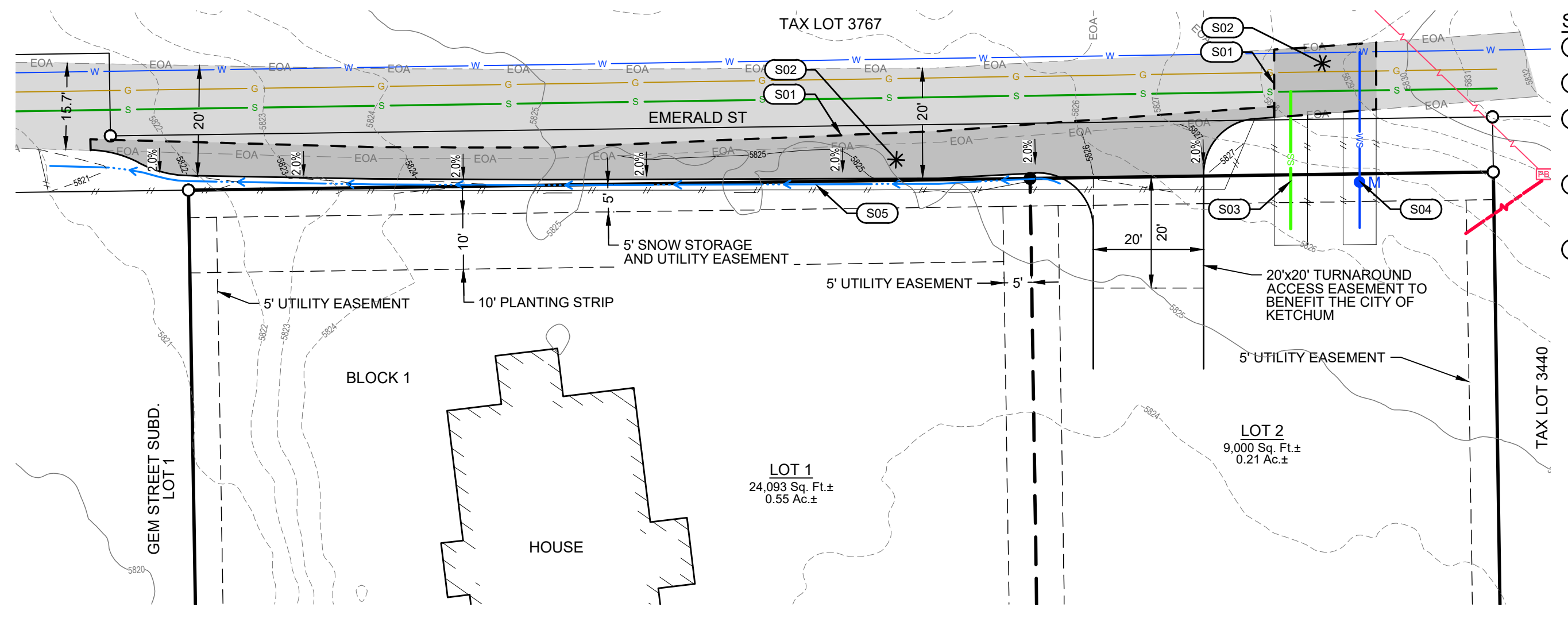

- SITE IMPROVEMENT KEY NOTES**
- S01 SAWCUT ASPHALT TO PROVIDE FOR A CLEAN VERTICAL EDGE.
 - S02 CONSTRUCT ASPHALT ROADWAY / ASPHALT REPAIR. SEE DETAIL 1, THIS SHEET.
 - S03 INSTALL 4" PVC SEWER SERVICE. SEE DETAIL 2, THIS SHEET FOR SEWER SERVICE CONNECTION AND DETAIL 4, THIS SHEET FOR TRENCHING.
 - S04 INSTALL 1" WATER SERVICE WITH METER. SEE DETAIL 3, THIS SHEET FOR WATER SERVICE CONNECTION AND DETAIL 4, THIS SHEET FOR TRENCHING.
 - S05 CONSTRUCT DRAINAGE SWALE TO KEEP DRAINAGE WITHIN SNOW STORAGE EASEMENT

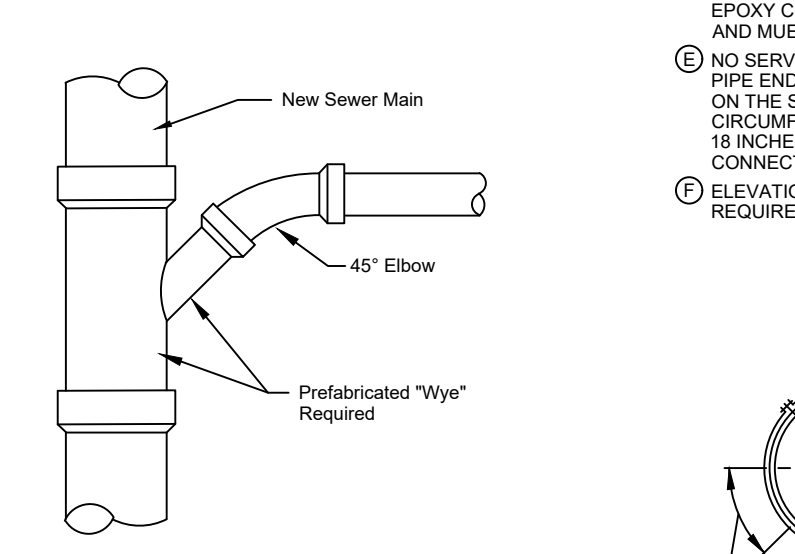
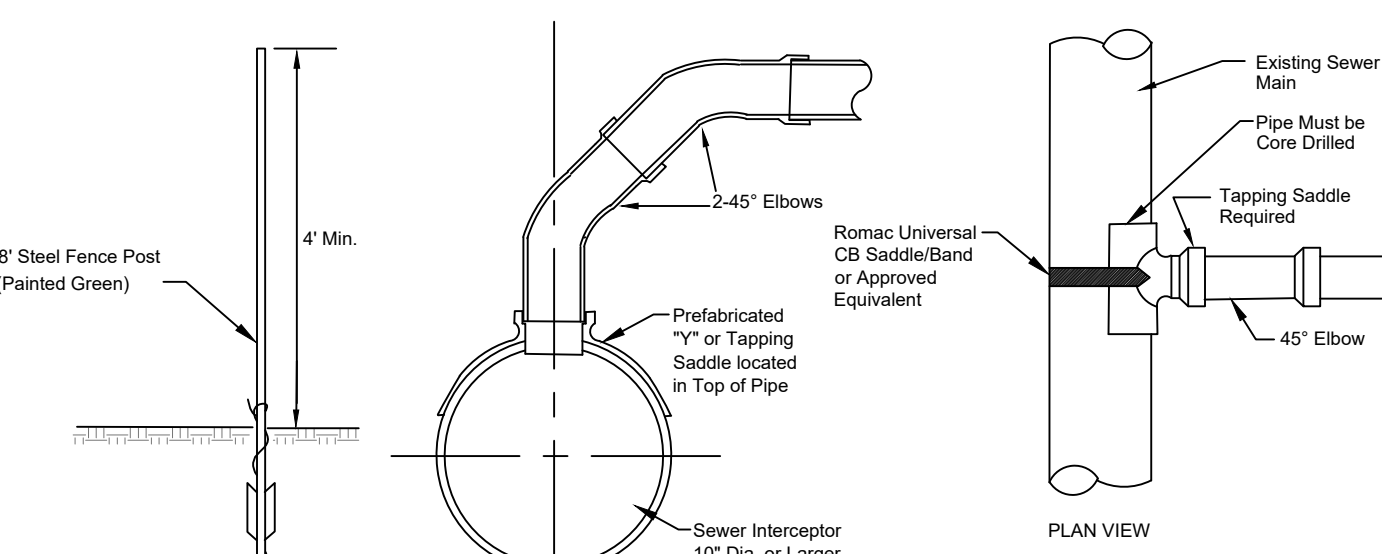
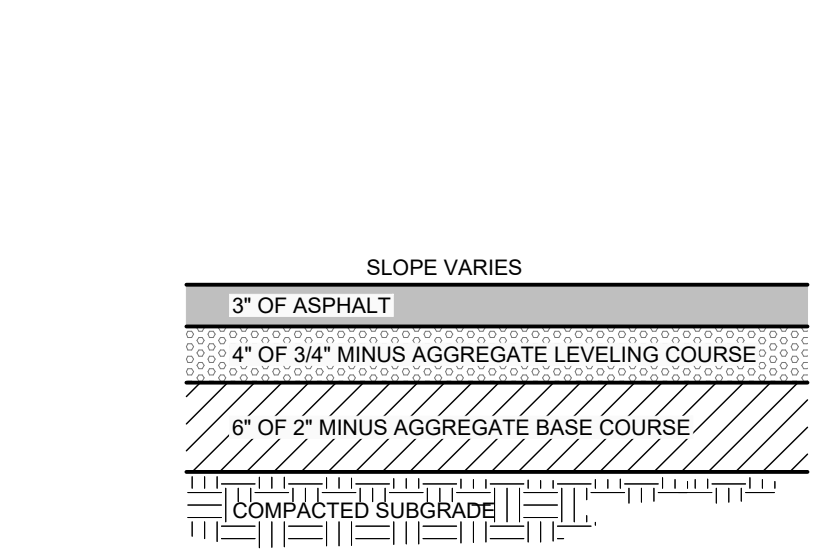
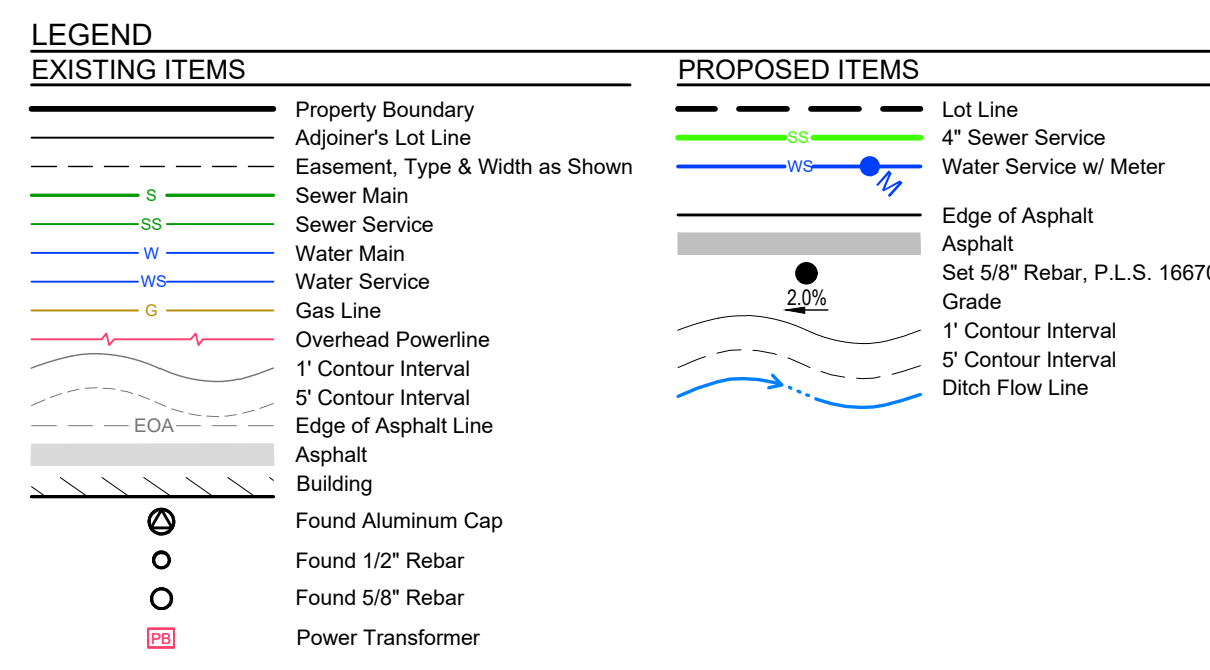

- NOTES:**
- ALL PRODUCTS AS LISTED OR APPROVED SUBSTITUTIONS.
 - NO GALVANIZED PIPE OR YELLOW BRASS FITTINGS TO BE USED.
 - SERVICE PIPE: ULTRA HIGH MOLECULAR WEIGHT POLYETHYLENE PIPE SIZE 8, CLASS 200 IN IRON PIPE SIZE (DRISCO PIPE 8600 ULTRA LINE) 1".
 - SADDLE COUPLINGS: USED FOR CONNECTION OF ALL SERVICE LINES TO PVC MAIN. SERVICE SADDLES: EPOXY COATED STEEL WITH STAINLESS STEEL BAND AND MUELLER THREADS, TYPE IPS.
 - NO SERVICE CONNECTIONS WITHIN 18 INCHES OF THE PIPE ENDS. STAGGER MULTIPLE CONNECTIONS MADE ON THE SAME JOINT OF PIPE ALONG THE CIRCUMFERENCE AND SEPARATED BY A MINIMUM OF 18 INCHES OR 2.5X PIPE Ø. MAXIMUM TWO (2) SERVICE CONNECTIONS PER STICK OF PIPE.
 - ELEVATION SET OF METER LID PER LOCAL REQUIREMENTS.

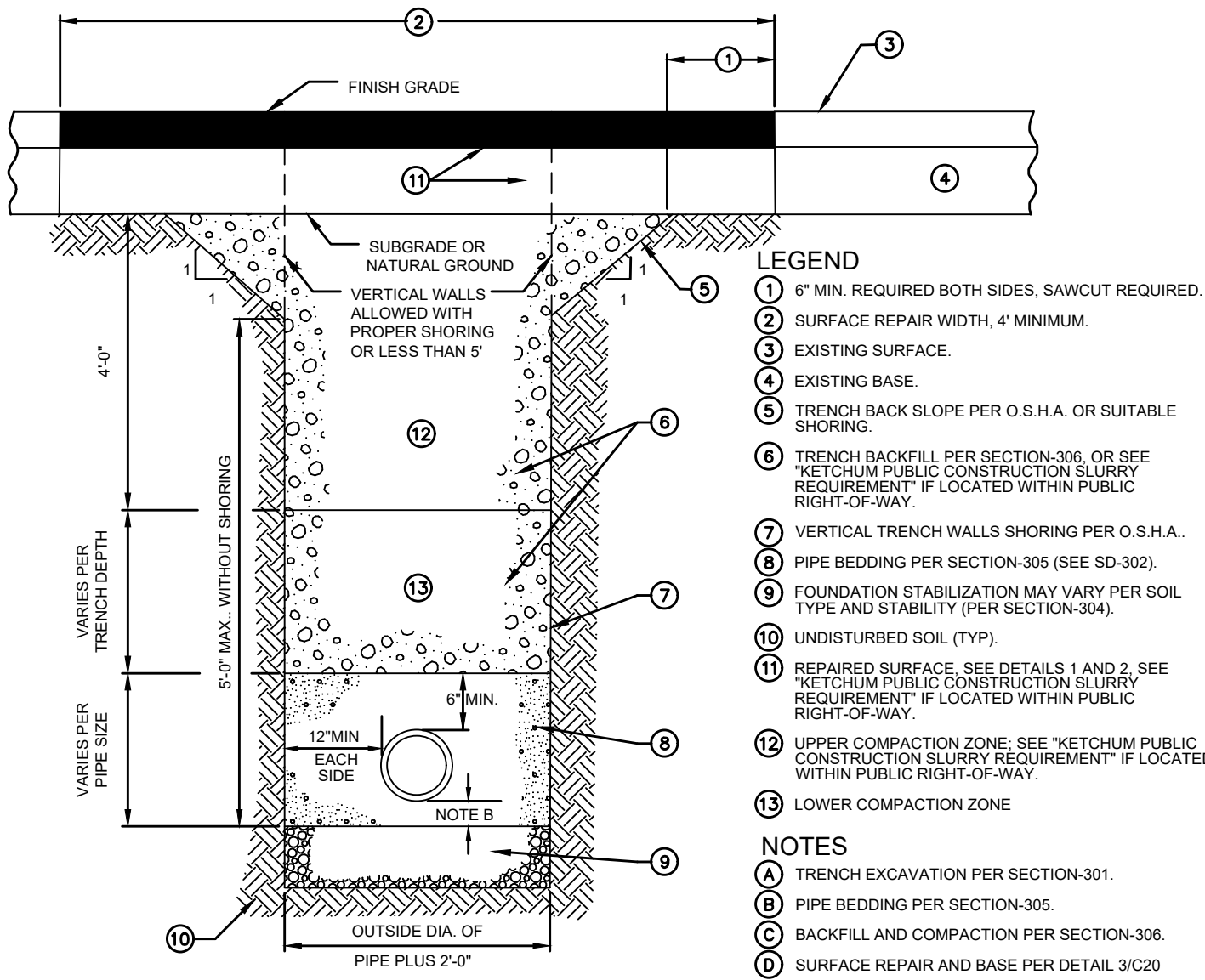
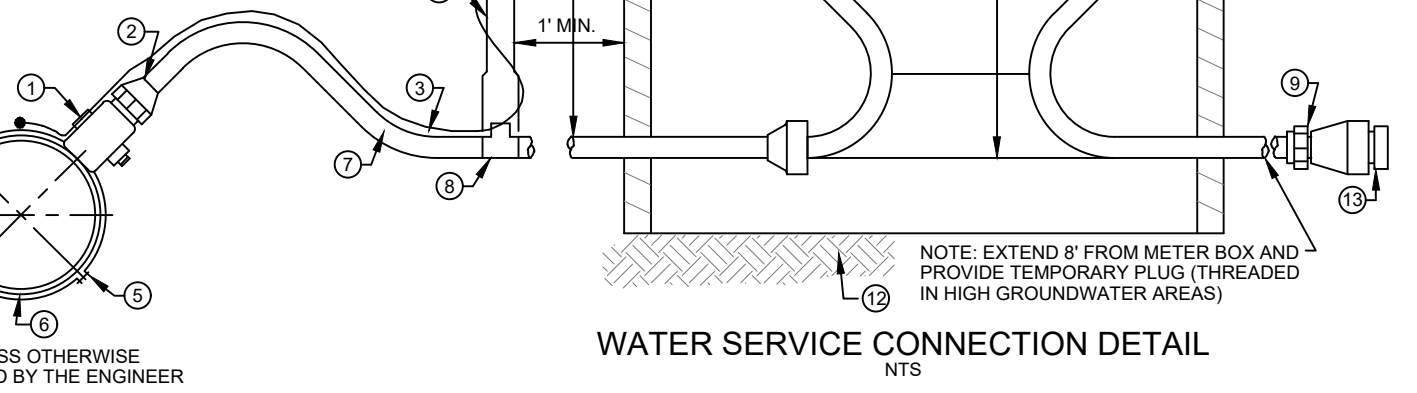

- NOTES:**
- SUBBASE CAN BE 2" TYPE I OR 3/4" TYPE I CRUSHED AGGREGATE BASE COURSE.
 - MATERIALS SHALL CONFORM WITH CURRENT ISPMC STANDARDS, DIVISION 800 AGGREGATES AND ASPHALT.
 - PAVEMENT SECTION MAY BE MODIFIED IF A PROJECT SPECIFIC GEOTECHNICAL REPORT, STAMPED BY A LICENSED ENGINEER, IS PROVIDED.

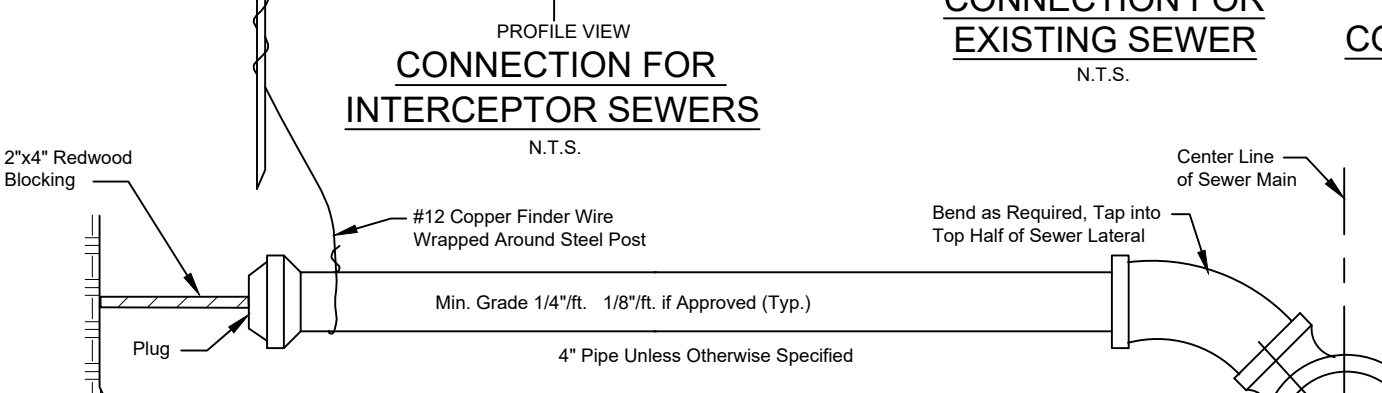

- NOTES**
- Sewer taps shall not enter at manholes.
 - An approved tapping saddle shall be required for all new taps to existing sewer laterals. Saddle to be approved by The City Engineer.
 - An owner constructing a new public sewer system in a subdivision or development shall construct a sewer tap and service for each potential user and extend it into the property.
 - When Sewer and Water lines or services cross refer to the current edition of ISPMC Standard Drawing 407, IDAPA 58.01.08.542.07.a and IDAPA 58.01.08.542.07.b which address the requirements for separation distances between potable water lines (including mains and service lines) with non-potable lines.

REPLAT OF LOT 2 GEM ST. SUBD. (151 TOPAZ ST)
SITE IMPROVEMENT PLAN
 LOCATED WITHIN SECTION 18, T.4N., R.18E., B.M., CITY OF KETCHUM, BLAINE COUNTY, IDAHO
 PREPARED FOR SALLIE CASTLE
 PROJECT INFORMATION
 P:\shelton\for\shelton\Construction\0274 Eng.dwg 01/27/22 4:21:06 PM



CT DESIGNED BY _____
 CT DRAWN BY _____
 SMF CHECKED BY _____

GALENA ENGINEERING, INC.
 Civil Engineers & Land Surveyors
 317 N. River Street
 Hailey, Idaho 83433
 (208) 768-1705
 email: galena@galena-engineering.com

NO.	DATE	BY	REVISIONS

PURPOSE: ISSUE FOR DESIGN REVIEW

C1.0

Exhibit B:
Right-of-Way Improvements
Construction Cost Estimate



Lunceford Excavation
alabama626@gmail.com

P.O. Box 739
Ketchum, Idaho
83340
United States

Prepared For
Sallie Castle
PO Box 2422
Ketchum, Idaho
83340

Estimate Date
03/07/2022

Estimate Number
12057

Reference
Emerald Street

Description	Rate	Qty	Line Total
Emerald Street	\$0.00	1	\$0.00
Core Out-Prep for Asphalt-New Drainage Swale	\$10,820.00	1	\$10,820.00
New Asphalt	\$9,187.00	1	\$9,187.00
New 1" Water Service and Vault	\$5,600.00	1	\$5,600.00
New 4" Sewer Service	\$4,350.00	1	\$4,350.00
Work to be completed by August 15th 2022	\$0.00	1	\$0.00
	Subtotal		29,957.00
	Tax		0.00
	Estimate Total (USD)		\$29,957.00

Terms

NOTE: This proposal may be withdrawn by us if not accepted within 30 days. All material is guaranteed to be as specified. All work to be completed in a substantial workman like manner according to specifications submitted per standard practices. Any alteration or deviation from above specifications involving extra costs will be expected only upon written orders, and will become an extra charge over and above the estimate. All agreements contingent upon strikes, accidents, or delays beyond our control. Owner to carry fire, flood, and other necessary insurance. Our workers are fully covered by Workman's Compensation Insurance.

Any asbestos or other unforeseen conditions will be billed on a Time and Materials basis

All abnormal soil conditions, such as rock, caliche, water in excavation and any other unforeseen soil conditions will be billed on an agreed upon amount between client and Lunceford Excavation

ACCEPTANCE OF PROPOSAL: The above prices, specifications and conditions are satisfactory and are hereby accepted. You are authorized to do the work as specified. Payments will be made as outlined above.

X _____ (Client)

X _____ (Lunceford Excavation)

**Attachment E:
Staff Report and Attachments –
November 18, 2021 City
Council Meeting**



City of Ketchum

November 18, 2021

Mayor Bradshaw and City Councilors
City of Ketchum
Ketchum, Idaho

Mayor Bradshaw and City Councilors:

Recommendation To Approve the 151 Topaz Street Subdivision Preliminary Plat

Recommendation and Summary

Staff recommends the Ketchum City Council approve the Preliminary Plat and adopt the Findings of Fact, Conclusion on Law, and Decision for a subdivision submitted by Sean Flynn, PE, of Galena Engineering on behalf of the property owner, Sallie Castle. The request is a subdivision of Lot 2, Block 1 of the Gem Street Subdivision into two separate lots at 151 Topaz in the Limited Residential (LR) zone district.

Recommended Motion: "I move to approve the 151 Topaz Street subdivision preliminary plat application, as conditioned, and adopt the findings of fact, conclusions of law, and decision, as it conforms to all applicable subdivision regulations for a preliminary plat."

The reasons for the recommendation are as follows:

- The request meets all applicable standards for Preliminary Plats contained in Ketchum Municipal Code's Subdivision (Title 16) regulations.
- The Ketchum Planning and Zoning Commission reviewed the application and unanimously voted to recommend approval, as conditioned, on October 26, 2021.
- All city departments have reviewed the proposal and have no issue with the proposed subdivision.

Introduction and History

The Applicant is proposing to subdivide Lot 2 of the Gem Street Subdivision, located at 151 Topaz Street (the "subject property") into two lots (the "project"). The subject property is zoned Limited Residential (LR) and has an existing single family dwelling unit and detached garage. The project proposes to retain the existing single family dwelling unit and garage and create a new 9,000 square foot lot on the eastern portion of the existing lot. See Attachment B for the preliminary plat illustrating the location of the existing dwelling unit and proposed lot lines for the new lot.

The City of Ketchum received the application for Subdivision Preliminary Plat on April 5, 2021. The application was deemed complete on June 9, 2021, after one review for completeness. Following receipt of the complete application, staff routed the application materials to all city departments for review. Department comments were provided to the applicant on June 25, 2021. All department comments have been addressed satisfactorily.

Analysis

During Department Review, staff reviewed the preliminary plat application for conformance with KMC 16.04.030 – *Procedures for subdivision approval* and KMC 16.04.040 – *Development and Design*. Title 16 of the

KMC outline, subdivisions of land and required improvements shall be in conformance with the city's comprehensive plan and that lots created through the subdivision process meet the dimensional standards for the applicable zone district as outlined in Title 17.

As outlined in the proposed Findings of Fact (Attachment C), staff and the Planning and Zoning Commission believe the application conforms to the 2014 Ketchum Comprehensive Plan as it forwards the goals and policies in Chapter 3: *Housing*, Chapter 4: *Community Design and Neighborhoods*, and Chapter 9: *Public Safety and Utilities* that relate to the proposed application. Additionally, the application conforms to the "Low Density Residential" designation of the property on the Future Land Use Map (FLUM) within the plan.

As outlined in Attachment C, the proposed application meets all dimensional standards in the LR zone district including lot area, minimum lot width, and building setback lines.

Please see Attachment C for the review of all subdivision requirements and standards. Where "N/A" is checked, the standard is not applicable for one of the following reasons:

- The standard applies to the creation of new subdivisions or new infrastructure. The application does not propose any new streets, water or sewer extensions of main lines, or master drainage infrastructure.
- The standard applies to action that shall be taken at the final plat stage of the process and this application is for a preliminary plat.
- Per provisions of the standard, the City Engineer has determined that the standard does not apply.

Emerald Street is classified as a residential street, requiring a minimum right-of-way of 60 feet. Emerald Street, unlike some streets in the Gem Street Neighborhood, has partial designated right-of-way. However, the right-of-way is minimal. West of the property, the right-of-way is 25 feet but narrows to only 10 feet adjacent to the subject property, turning into a private driveway at the eastern property boundary. The subdivision regulations require that all streets meet the minimum standards as outlined in Chapter 12.04, however, this pertains to the creation of new subdivisions and the construction of new streets. The original Gem Street Subdivision, approved in November 2020, dedicated the 10 feet of right-of-way adjacent to the subject property. Additional right-of-way dedication to achieve a consistent 25 feet must come from the adjacent property to the north if or when it develops in the future. The goal for this application is to meet or exceed the minimum width and improvements required for efficient maintenance (primarily snow removal) and emergency service access.

The following items are required to achieve this:

- 5-foot Snow storage and utility easement along Emerald Street
- Designation of driveway curb cut location onto Emerald Street from the new lot, see recommended condition of approval #1
- Widening of pavement within the right of way to a consistent 20 feet from the western property boundary to the eastern side of the designated driveway access point of the new lot to meet minimum fire access requirements
- 20x20 access easement on the new lot for the city to facilitate maneuvering of snowplows or other equipment

Plat note #3 of the original Gem Street Subdivision noted that existing fences within the snow storage easement were allowed to remain until their respective lots are developed. This subdivision application is considered a "development", therefore, the fences along Emerald Street on the subject property must be removed prior to approval of the final plat. Staff recommends condition of approval #2 to address this item.

Staff recommends approval of the subdivision Preliminary Plat application with the following recommended Conditions of Approval:

1. Prior to construction of required improvements, construction plans for proposed improvements to Emerald Street shall be reviewed and approved by the City Engineer.

2. The Final Plat application shall include a plat note restricting construction of driveway curb cuts on the new lot to the turnaround access easement location as shown on the preliminary plat.
3. All fences located within snow storage easements must either be relocated or removed entirely and verified by a member of the City of Ketchum Planning staff, prior to approval of the Final Plat.
4. The Final Plat application shall not include Plat note 3 provided that all fences have been adequately removed or relocated.
5. All right-of-way improvements shall be completed and accepted by the City of Ketchum City Engineer prior to approval of the Final Plat.
6. Failure to record a Final Plat within two (2) years of Council's approval of a Preliminary Plat shall cause the Preliminary Plat to be null and void.

Sustainability

The proposed preliminary plat does not limit the ability of the city to reach the goals of the Ketchum Sustainability Action Plan – 2020.

Financial Impact

There is no financial requirement from the city for this action.

Attachments

- A. Application and supplemental materials
- B. Preliminary Plat Plan Set
- C. Draft City Council Findings of Fact, Conclusions of Law, and Decision

Attachment A:
Application and Supplemental
Materials



City of Ketchum
Planning & Building

**CERTIFIED
COMPLETE**

6-2-21
mf

OFFICIAL USE ONLY	
Application Number:	P21-034
Date Received:	6-5-21
By:	mf
Fee Paid:	2600.00
Approved Date:	
By:	

Preliminary Plat

Subdivision Application

Submit completed application and payment to the Planning and Building Department, PO Box 2315, Ketchum, ID 83340 or hand deliver to Ketchum City Hall, 480 East Ave. N., Ketchum. If you have questions, please contact the Planning and Building Department at (208) 726-7801. To view the Development Standards, visit the City website at: www.ketchumidaho.org and click on Municipal Code.

APPLICANT INFORMATION			
Name of Proposed Subdivision:		Byoux Subdivision	
Owner of Record:		Sallie Castle	
Address of Owner: PO Box 2422, Ketchum, ID 83340			
Representative of Owner: Sean Flynn / Galena Engineering			
Legal Description: Lot 2, Block 1, Gem Street Subdivision			
Street Address: 151 Topaz Street			
SUBDIVISION INFORMATION			
Number of Lots/Parcels: 2			
Total Land Area: 33,093 Sq. Ft.			
Current Zoning District: LR			
Proposed Zoning District: LR			
Overlay District: None			
TYPE OF SUBDIVISION			
Condominium <input type="checkbox"/>	Land <input checked="" type="checkbox"/>	PUD <input type="checkbox"/>	Townhouse <input type="checkbox"/>
Adjacent land in same ownership in acres or square feet:			
Easements to be dedicated on the final plat:			
Public Utility Easements			
Briefly describe the improvements to be installed prior to final plat approval:			
Water and Sewer Services to Lot 2			
ADDITIONAL INFORMATION			
All lighting must be in compliance with the City of Ketchum's Dark Sky Ordinance			
One (1) copy of Articles of Incorporation and By-Laws of Homeowners Associations and/or Condominium Declarations			
One (1) copy of current title report and owner's recorded deed to the subject property			
One (1) copy of the preliminary plat			
All files should be submitted in an electronic format.			

Applicant agrees in the event of a dispute concerning the interpretation or enforcement of the Subdivision Application in which the City of Ketchum is the prevailing party to pay reasonable attorney's fees and costs, including fees and costs of appeal for the City of Ketchum. Applicant agrees to observe all City ordinances, laws and conditions imposed. Applicant agrees to defend, hold harmless and indemnify the City of Ketchum, city officials, agents and employees from and for any and all losses, claims, actions, judgments for damages, or injury to persons or property, and losses and expenses caused or incurred by Applicant, its servants, agents, employees, guests and business invitees and not caused by or arising out of the tortious conduct of city or its officials, agents or employees. Applicant certifies that s/he has read and examined this application and that all information contained herein is true and correct.

Sean Flynn

Sean Flynn / Galena Engineering

04/02/2021

Applicant Signature

Date

GALENA ENGINEERING, INC.

CIVIL ENGINEERING & LAND SURVEYING

TRANSMITTAL LETTER

DATE: April 2, 2021

TO: Abby Riven, Planner
City of Ketchum
480 East Avenue North
Ketchum, ID 83340

SUBJECT: Castle Subdivision Preliminary Plat Application

TRANSMITTED: X Herewith

Separate Cover

By Carrier

REMARKS:

Abby,

Attached please find:

- Application
- Application fee of \$2600 (\$1300 per lot)
- 1 copy of the preliminary plat (with and without aerial)
- Title Report and Deed

This application is to subdivide Lot 2 of Gem Street Subdivision, into 2 lots. Please feel free to contact me if you have any questions or comments, or if you need any additional information. I appreciate your assistance.

Sincerely,

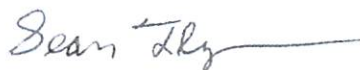

Sean Flynn, PE
GALENA ENGINEERING, INC.



ALTA OWNER'S POLICY OF TITLE INSURANCE

ISSUED BY
STEWART TITLE GUARANTY COMPANY

Any notice of claim and any other notice or statement in writing required to be given to the Company under this Policy must be given to the Company at the address shown in Section 18 of the Conditions.

COVERED RISKS

SUBJECT TO THE EXCLUSIONS FROM COVERAGE, THE EXCEPTIONS FROM COVERAGE CONTAINED IN SCHEDULE B AND THE CONDITIONS, STEWART TITLE GUARANTY COMPANY, a Texas corporation, (the "Company") insures, as of Date of Policy and, to the extent stated in Covered Risks 9 and 10, after Date of Policy, against loss or damage, not exceeding the Amount of Insurance, sustained or incurred by the Insured by reason of:

- 1. Title being vested other than as stated in Schedule A.
2. Any defect in or lien or encumbrance on the Title. This Covered Risk includes but is not limited to insurance against loss from
(a) A defect in the Title caused by
(i) forgery, fraud, undue influence, duress, incompetency, incapacity, or impersonation;
(ii) failure of any person or Entity to have authorized a transfer or conveyance;
(iii) a document affecting Title not properly created, executed, witnessed, sealed, acknowledged, notarized, or delivered;
(iv) failure to perform those acts necessary to create a document by electronic means authorized by law;
(v) a document executed under a falsified, expired, or otherwise invalid power of attorney;
(vi) a document not properly filed, recorded, or indexed in the Public Records including failure to perform those acts by electronic means authorized by law; or
(vii) a defective judicial or administrative proceeding.
(b) The lien of real estate taxes or assessments imposed on the Title by a governmental authority due or payable, but unpaid.
(c) Any encroachment, encumbrance, violation, variation, or adverse circumstance affecting the Title that would be disclosed by an accurate and complete land survey of the Land. The term "encroachment" includes encroachments of existing improvements located on the Land onto adjoining land, and encroachments onto the Land of existing improvements located on adjoining land.
3. Unmarketable Title.
4. No right of access to and from the Land.
5. The violation or enforcement of any law, ordinance, permit, or governmental regulation (including those relating to building and zoning) restricting, regulating, prohibiting, or relating to
(a) the occupancy, use, or enjoyment of the Land;
(b) the character, dimensions, or location of any improvement erected on the Land;
(c) the subdivision of land; or
(d) environmental protection
if a notice, describing any part of the Land, is recorded in the Public Records setting forth the violation or intention to enforce, but only to the extent of the violation or enforcement referred to in that notice.
6. An enforcement action based on the exercise of a governmental police power not covered by Covered Risk 5 if a notice of the enforcement action, describing any part of the Land, is recorded in the Public Records, but only to the extent of the enforcement referred to in that notice.
7. The exercise of the rights of eminent domain if a notice of the exercise, describing any part of the Land, is recorded in the Public Records.
8. Any taking by a governmental body that has occurred and is binding on the rights of a purchaser for value without Knowledge.

Countersigned by:

[Signature]
Authorized Countersignature

Blaine County Title, Inc.
360 Sun Valley Road
P.O. Box 3176
Ketchum, ID 83340
(208) 726-0700
Agent ID: 120037



[Signature]
Frederick H. Eppinger
President and CEO

[Signature]
Denise Carraux
Secretary

For coverage information or assistance resolving a complaint, call (800) 729-1902 or visit www.stewart.com. To make a claim, furnish written notice in accordance with Section 3 of the Conditions.

Copyright 2006-2009 American Land Title Association. All rights reserved.

The use of this Form is restricted to ALTA licensees and ALTA members in good standing as of the date of use. All other uses are prohibited. Reprinted under license from the American Land Title Association.

File No. 2022464

ALTA Owner's Policy 06-17-06

Page 1 of 4 of Policy Serial No.: O-0000-340873208



COVERED RISKS (Continued)

9. Title being vested other than as stated in Schedule A or being defective
 - (a) as a result of the avoidance in whole or in part, or from a court order providing an alternative remedy, of a transfer of all or any part of the title to or any interest in the Land occurring prior to the transaction vesting Title as shown in Schedule A because that prior transfer constituted a fraudulent or preferential transfer under federal bankruptcy, state insolvency, or similar creditors' rights laws; or
 - (b) because the instrument of transfer vesting Title as shown in Schedule A constitutes a preferential transfer under federal bankruptcy, state insolvency, or similar creditors' rights laws by reason of the failure of its recording in the Public Records
 - (i) to be timely; or
 - (ii) to impart notice of its existence to a purchaser for value or to a judgment or lien creditor.
10. Any defect in or lien or encumbrance on the Title or other matter included in Covered Risks 1 through 9 that has been created or attached or has been filed or recorded in the Public Records subsequent to Date of Policy and prior to the recording of the deed or other instrument of transfer in the Public Records that vests Title as shown in Schedule A.

The Company will also pay the costs, attorneys' fees, and expenses incurred in defense of any matter insured against by this Policy, but only to the extent provided in the Conditions.

EXCLUSIONS FROM COVERAGE

The following matters are expressly excluded from the coverage of this policy, and the Company will not pay loss or damage, costs, attorneys' fees, or expenses that arise by reason of:

1. (a) Any law, ordinance, permit, or governmental regulation (including those relating to building and zoning) restricting, regulating, prohibiting, or relating to
 - (i) the occupancy, use, or enjoyment of the Land;
 - (ii) the character, dimensions, or location of any improvement erected on the Land;
 - (iii) the subdivision of land; or
 - (iv) environmental protection;or the effect of any violation of these laws, ordinances, or governmental regulations. This Exclusion 1(a) does not modify or limit the coverage provided under Covered Risk 5.
- (b) Any governmental police power. This Exclusion 1(b) does not modify or limit the coverage provided under Covered Risk 6.
2. Rights of eminent domain. This Exclusion does not modify or limit the coverage provided under Covered Risk 7 or 8.
3. Defects, liens, encumbrances, adverse claims, or other matters
 - (a) created, suffered, assumed, or agreed to by the Insured Claimant;

- (b) not Known to the Company, not recorded in the Public Records at Date of Policy, but Known to the Insured Claimant and not disclosed in writing to the Company by the Insured Claimant prior to the date the Insured Claimant became an Insured under this policy;
- (c) resulting in no loss or damage to the Insured Claimant;
- (d) attaching or created subsequent to Date of Policy (however, this does not modify or limit the coverage provided under Covered Risk 9 and 10); or
- (e) resulting in loss or damage that would not have been sustained if the Insured Claimant had paid value for the Title.
4. Any claim, by reason of the operation of federal bankruptcy, state insolvency, or similar creditors' rights laws, that the transaction vesting the Title as shown in Schedule A, is
 - (a) a fraudulent conveyance or fraudulent transfer; or
 - (b) a preferential transfer for any reason not stated in Covered Risk 9 of this policy.
5. Any lien on the Title for real estate taxes or assessments imposed by governmental authority and created or attaching between Date of Policy and the date of recording of the deed or other instrument of transfer in the Public Records that vests Title as shown in Schedule A.

CONDITIONS

1. DEFINITION OF TERMS

The following terms when used in this policy mean:

- (a) "Amount of Insurance": The amount stated in Schedule A, as may be increased or decreased by endorsement to this policy, increased by Section 8(b), or decreased by Sections 10 and 11 of these Conditions.
- (b) "Date of Policy": The date designated as "Date of Policy" in Schedule A.
- (c) "Entity": A corporation, partnership, trust, limited liability company, or other similar legal entity.
- (d) "Insured": The Insured named in Schedule A.
 - (i) the term "Insured" also includes
 - (A) successors to the Title of the Insured by operation of law as distinguished from purchase, including heirs, devisees, survivors, personal representatives, or next of kin;
 - (B) successors to an Insured by dissolution, merger, consolidation, distribution, or reorganization;
 - (C) successors to an Insured by its conversion to another kind of Entity;
 - (D) a grantee of an Insured under a deed delivered without payment of actual valuable consideration conveying the Title
 - (1) if the stock, shares, memberships, or other equity interests of the grantee are wholly-owned by the named Insured.
 - (2) if the grantee wholly owns the named Insured.
 - (3) if the grantee is wholly-owned by an affiliated Entity of the named Insured, provided the affiliated Entity and the named Insured are both wholly-owned by the same person or Entity, or
 - (4) if the grantee is a trustee or beneficiary of a trust created by a written instrument established by the

Insured named in Schedule A for estate planning purposes.

- (ii) with regard to (A), (B), (C), and (D) reserving, however, all rights and defenses as to any successor that the Company would have had against any predecessor Insured.
- (e) "Insured Claimant": An Insured claiming loss or damage.
- (f) "Knowledge" or "Known": Actual knowledge, not constructive knowledge or notice that may be imputed to an Insured by reason of the Public Records or any other records that impart constructive notice of matters affecting the Title.
- (g) "Land": The land described in Schedule A, and affixed improvements that by law constitute real property. The term "Land" does not include any property beyond the lines of the area described in Schedule A, nor any right, title, interest, estate, or easement in abutting streets, roads, avenues, alleys, lanes, ways, or waterways, but this does not modify or limit the extent that a right of access to and from the Land is insured by this policy.
- (h) "Mortgage": Mortgage, deed of trust, trust deed, or other security instrument, including one evidenced by electronic means authorized by law.
- (i) "Public Records": Records established under state statutes at Date of Policy for the purpose of imparting constructive notice of matters relating to real property to purchasers for value and without Knowledge. With respect to Covered Risk 5(d), "Public Records" shall also include environmental protection liens filed in the records of the clerk of the United States District Court for the district where the Land is located.
- (j) "Title": The estate or interest described in Schedule A.
- (k) "Unmarketable Title": Title affected by an alleged or apparent matter that would permit a prospective purchaser or lessee of the Title or lender on the Title to be released from the obligation to purchase, lease, or lend if there is a contractual condition requiring the delivery of marketable title.

CONDITIONS (Continued)

2. CONTINUATION OF INSURANCE

The coverage of this policy shall continue in force as of Date of Policy in favor of an Insured, but only so long as the Insured retains an estate or interest in the Land, or holds an obligation secured by a purchase money Mortgage given by a purchaser from the Insured, or only so long as the Insured shall have liability by reason of warranties in any transfer or conveyance of the Title. This policy shall not continue in force in favor of any purchaser from the Insured of either (i) an estate or interest in the Land, or (ii) an obligation secured by a purchase money Mortgage given to the Insured.

3. NOTICE OF CLAIM TO BE GIVEN BY INSURED CLAIMANT

The Insured shall notify the Company promptly in writing (i) in case of any litigation as set forth in Section 5(a) of these Conditions, (ii) in case Knowledge shall come to an Insured hereunder of any claim of title or interest that is adverse to the Title, as insured, and that might cause loss or damage for which the Company may be liable by virtue of this policy, or (iii) if the Title, as insured, is rejected as Unmarketable Title. If the Company is prejudiced by the failure of the Insured Claimant to provide prompt notice, the Company's liability to the Insured Claimant under the policy shall be reduced to the extent of the prejudice.

4. PROOF OF LOSS

In the event the Company is unable to determine the amount of loss or damage, the Company may, at its option, require as a condition of payment that the Insured Claimant furnish a signed proof of loss. The proof of loss must describe the defect, lien, encumbrance, or other matter insured against by this policy that constitutes the basis of loss or damage and shall state, to the extent possible, the basis of calculating the amount of the loss or damage.

5. DEFENSE AND PROSECUTION OF ACTIONS

- (a) Upon written request by the Insured, and subject to the options contained in Section 7 of these Conditions, the Company, at its own cost and without unreasonable delay, shall provide for the defense of an Insured in litigation in which any third party asserts a claim covered by this policy adverse to the Insured. This obligation is limited to only those stated causes of action alleging matters insured against by this policy. The Company shall have the right to select counsel of its choice (subject to the right of the Insured to object for reasonable cause) to represent the Insured as to those stated causes of action. It shall not be liable for and will not pay the fees of any other counsel. The Company will not pay any fees, costs, or expenses incurred by the Insured in the defense of those causes of action that allege matters not insured against by this policy.
- (b) The Company shall have the right, in addition to the options contained in Section 7 of these Conditions, at its own cost, to institute and prosecute any action or proceeding or to do any other act that in its opinion may be necessary or desirable to establish the Title, as insured, or to prevent or reduce loss or damage to the Insured. The Company may take any appropriate action under the terms of this policy, whether or not it shall be liable to the Insured. The exercise of these rights shall not be an admission of liability or waiver of any provision of this policy. If the Company exercises its rights under this subsection, it must do so diligently.
- (c) Whenever the Company brings an action or asserts a defense as required or permitted by this policy, the Company may pursue the litigation to a final determination by a court of competent jurisdiction, and it expressly reserves the right, in its sole discretion, to appeal any adverse judgment or order.

6. DUTY OF INSURED CLAIMANT TO COOPERATE

- (a) In all cases where this policy permits or requires the Company to prosecute or provide for the defense of any action or proceeding and any appeals, the Insured shall secure to the Company the right to so prosecute or provide defense in the action or proceeding, including the right to use, at its option, the name of the Insured for this purpose. Whenever requested by the Company, the Insured, at the Company's expense, shall give the

Company all reasonable aid (i) in securing evidence, obtaining witnesses, prosecuting or defending the action or proceeding, or effecting settlement, and (ii) in any other lawful act that in the opinion of the Company may be necessary or desirable to establish the Title or any other matter as insured. If the Company is prejudiced by the failure of the Insured to furnish the required cooperation, the Company's obligations to the Insured under the policy shall terminate, including any liability or obligation to defend, prosecute, or continue any litigation, with regard to the matter or matters requiring such cooperation.

- (b) The Company may reasonably require the Insured Claimant to submit to examination under oath by any authorized representative of the Company and to produce for examination, inspection, and copying, at such reasonable times and places as may be designated by the authorized representative of the Company, all records, in whatever medium maintained, including books, ledgers, checks, memoranda, correspondence, reports, e-mails, disks, tapes, and videos whether bearing a date before or after Date of Policy, that reasonably pertain to the loss or damage. Further, if requested by any authorized representative of the Company, the Insured Claimant shall grant its permission, in writing, for any authorized representative of the Company to examine, inspect, and copy all of these records in the custody or control of a third party that reasonably pertain to the loss or damage. All information designated as confidential by the Insured Claimant provided to the Company pursuant to this Section shall not be disclosed to others unless, in the reasonable judgment of the Company, it is necessary in the administration of the claim. Failure of the Insured Claimant to submit for examination under oath, produce any reasonably requested information, or grant permission to secure reasonably necessary information from third parties as required in this subsection, unless prohibited by law or governmental regulation, shall terminate any liability of the Company under this policy as to that claim.

7. OPTIONS TO PAY OR OTHERWISE SETTLE CLAIMS; TERMINATION OF LIABILITY

In case of a claim under this policy, the Company shall have the following additional options:

- (a) To Pay or Tender Payment of the Amount of Insurance. To pay or tender payment of the Amount of Insurance under this policy together with any costs, attorneys' fees, and expenses incurred by the Insured Claimant that were authorized by the Company up to the time of payment or tender of payment and that the Company is obligated to pay. Upon the exercise by the Company of this option, all liability and obligations of the Company to the Insured under this policy, other than to make the payment required in this subsection, shall terminate, including any liability or obligation to defend, prosecute, or continue any litigation.
- (b) To Pay or Otherwise Settle With Parties Other Than the Insured or With the Insured Claimant.
 - (i) to pay or otherwise settle with other parties for or in the name of an Insured Claimant any claim insured against under this policy. In addition, the Company will pay any costs, attorneys' fees, and expenses incurred by the Insured Claimant that were authorized by the Company up to the time of payment and that the Company is obligated to pay; or
 - (ii) to pay or otherwise settle with the Insured Claimant the loss or damage provided for under this policy, together with any costs, attorneys' fees, and expenses incurred by the Insured Claimant that were authorized by the Company up to the time of payment and that the Company is obligated to pay.

Upon the exercise by the Company of either of the options provided for in subsections (b)(i) or (ii), the Company's obligations to the Insured under this policy for the claimed loss or damage, other than the payments required to be made, shall terminate, including any liability or obligation to defend, prosecute, or continue any litigation.

CONDITIONS (Continued)

8. DETERMINATION AND EXTENT OF LIABILITY

This policy is a contract of indemnity against actual monetary loss or damage sustained or incurred by the Insured Claimant who has suffered loss or damage by reason of matters insured against by this policy.

- (a) The extent of liability of the Company for loss or damage under this policy shall not exceed the lesser of
 - (i) the Amount of Insurance; or
 - (ii) the difference between the value of the Title as insured and the value of the Title subject to the risk insured against by this policy.
- (b) If the Company pursues its rights under Section 5 of these Conditions and is unsuccessful in establishing the Title, as insured,
 - (i) the Amount of Insurance shall be increased by 10%, and
 - (ii) the Insured Claimant shall have the right to have the loss or damage determined either as of the date the claim was made by the Insured Claimant or as of the date it is settled and paid.
- (c) In addition to the extent of liability under (a) and (b), the Company will also pay those costs, attorneys' fees, and expenses incurred in accordance with Sections 5 and 7 of these Conditions.

9. LIMITATION OF LIABILITY

- (a) If the Company establishes the Title, or removes the alleged defect, lien, or encumbrance, or cures the lack of a right of access to or from the Land, or cures the claim of Unmarketable Title, all as insured, in a reasonably diligent manner by any method, including litigation and the completion of any appeals, it shall have fully performed its obligations with respect to that matter and shall not be liable for any loss or damage caused to the Insured.
- (b) In the event of any litigation, including litigation by the Company or with the Company's consent, the Company shall have no liability for loss or damage until there has been a final determination by a court of competent jurisdiction, and disposition of all appeals, adverse to the Title, as insured.
- (c) The Company shall not be liable for loss or damage to the Insured for liability voluntarily assumed by the Insured in settling any claim or suit without the prior written consent of the Company.

10. REDUCTION OF INSURANCE; REDUCTION OR TERMINATION OF LIABILITY

All payments under this policy, except payments made for costs, attorneys' fees, and expenses, shall reduce the Amount of Insurance by the amount of the payment.

11. LIABILITY NONCUMULATIVE

The Amount of Insurance shall be reduced by any amount the Company pays under any policy insuring a Mortgage to which exception is taken in Schedule B or to which the Insured has agreed, assumed, or taken subject, or which is executed by an Insured after Date of Policy and which is a charge or lien on the Title, and the amount so paid shall be deemed a payment to the Insured under this policy.

12. PAYMENT OF LOSS

When litigation and the extent of loss or damage have been definitely fixed in accordance with these Conditions, the payment shall be made within 30 days.

13. RIGHTS OF RECOVERY UPON PAYMENT OR SETTLEMENT

- (a) Whenever the Company shall have settled and paid a claim under this policy, it shall be subrogated and entitled to the rights of the Insured Claimant in the Title and all other rights and remedies in respect to the claim that the Insured Claimant has against any person or property, to the extent of the amount of any loss, costs, attorneys' fees, and expenses paid by the Company. If requested by the Company, the Insured Claimant shall execute documents to evidence the transfer to the Company of these rights and remedies. The Insured Claimant shall permit the Company to sue, compromise, or settle in the name of the Insured Claimant and to use the name of the Insured Claimant in any transaction or litigation involving these rights and remedies.

If a payment on account of a claim does not fully cover the loss of the Insured Claimant, the Company shall defer the exercise of its right to recover until after the Insured Claimant shall have recovered its loss.

- (b) The Company's right of subrogation includes the rights of the Insured to indemnities, guaranties, other policies of insurance, or bonds, notwithstanding any terms or conditions contained in those instruments that address subrogation rights.

14. ARBITRATION

Either the Company or the Insured may demand that the claim or controversy shall be submitted to arbitration pursuant to the Title Insurance Arbitration Rules of the American Land Title Association ("Rules"). Except as provided in the Rules, there shall be no joinder or consolidation with claims or controversies of other persons. Arbitrable matters may include, but are not limited to, any controversy or claim between the Company and the Insured arising out of or relating to this policy, any service in connection with its issuance or the breach of a policy provision, or to any other controversy or claim arising out of the transaction giving rise to this policy. All arbitrable matters when the Amount of Insurance is \$2,000,000 or less shall be arbitrated at the option of either the Company or the Insured. All arbitrable matters when the Amount of Insurance is in excess of \$2,000,000 shall be arbitrated only when agreed to by both the Company and the Insured. Arbitration pursuant to this policy and under the Rules shall be binding upon the parties. Judgment upon the award rendered by the Arbitrator(s) may be entered in any court of competent jurisdiction.

15. LIABILITY LIMITED TO THIS POLICY; POLICY ENTIRE CONTRACT

- (a) This policy together with all endorsements, if any, attached to it by the Company is the entire policy and contract between the Insured and the Company. In interpreting any provision of this policy, this policy shall be construed as a whole.
- (b) Any claim of loss or damage that arises out of the status of the Title or by any action asserting such claim shall be restricted to this policy.
- (c) Any amendment of or endorsement to this policy must be in writing and authenticated by an authorized person, or expressly incorporated by Schedule A of this policy.
- (d) Each endorsement to this policy issued at any time is made a part of this policy and is subject to all of its terms and provisions. Except as the endorsement expressly states, it does not (i) modify any of the terms and provisions of the policy, (ii) modify any prior endorsement, (iii) extend the Date of Policy, or (iv) increase the Amount of Insurance.

16. SEVERABILITY

In the event any provision of this policy, in whole or in part, is held invalid or unenforceable under applicable law, the policy shall be deemed not to include that provision or such part held to be invalid, but all other provisions shall remain in full force and effect.

17. CHOICE OF LAW; FORUM

- (a) Choice of Law: The Insured acknowledges the Company has underwritten the risks covered by this policy and determined the premium charged therefor in reliance upon the law affecting interests in real property and applicable to the interpretation, rights, remedies, or enforcement of policies of title insurance of the jurisdiction where the Land is located.

Therefore, the court or an arbitrator shall apply the law of the jurisdiction where the Land is located to determine the validity of claims against the Title that are adverse to the Insured and to interpret and enforce the terms of this policy. In neither case shall the court or arbitrator apply its conflicts of law principles to determine the applicable law.

- (b) Choice of Forum: Any litigation or other proceeding brought by the Insured against the Company must be filed only in a state or federal court within the United States of America or its territories having appropriate jurisdiction.

18. NOTICES, WHERE SENT

Any notice of claim and any other notice or statement in writing required to be given to the Company under this policy must be given to the Company at Claims Department at P.O. Box 2029, Houston, TX 77252-2029.

**ALTA OWNER'S POLICY OF TITLE INSURANCE
SCHEDULE A**

ISSUED BY
STEWART TITLE GUARANTY COMPANY

**Name and Address of
Title Insurance Company:**

Stewart Title Guaranty Company
P.O. Box 2029, Houston, TX 77252

File No.: 2022464

Policy No.: O-0000-340873208

Address Reference: 151 Topaz St., Ketchum, ID 83340
(For Company Reference Purposes Only)

Amount of Insurance: \$1,475,000.00

Premium: \$3,730.00

Date of Policy: November 25, 2020 at 1:20pm

1. Name of Insured:

Sallie Castle

2. The estate or interest in the Land that is insured by this policy is:

Fee Simple

3. Title is vested in:

Sallie Castle

4. The Land referred to in this policy is described as follows:

Lot 2, Block 1 of GEM STREET SUBDIVISION, as shown on the official plat thereof, recorded as Instrument No. 675967, records of Blaine County, Idaho.



SCHEDULE B

File No.: 2022464

Policy No.: O-0000-340873208

EXCEPTIONS FROM COVERAGE

This policy does not insure against loss or damage (and the Company will not pay costs, attorneys' fees or expenses) that arise by reason of:

1. Taxes or assessments which are not shown as existing liens by the records of any taxing authority that levies taxes or assessments on real property or by the public records. Proceedings by a public agency which may result in taxes or assessments, or notices of such proceedings, whether or not shown by the records of such agency or by public record.
2. Any facts, rights, interests, or claims which are not shown by the public records, but which could be ascertained by an inspection of the Land or by making inquiry of persons in possession thereof.
3. Easements, liens, or encumbrances, or claims thereof, which are not shown by the public records.
4. Discrepancies, conflicts in boundary lines, shortages in area, encroachments, or any other facts which a correct survey would disclose, and which are not shown by the public records.
5. (1) Unpatented mining claims; (2) reservations or exceptions in patents or in Acts authorizing the issuance thereof; (3) water rights, claims, or title to water.
6. Any lien or right to a lien for services, labor, or material heretofore or hereafter furnished, imposed by law and not shown by the public records.
7. Minerals of whatsoever kind, subsurface and surface substances, including but not limited to coal, lignite, oil, gas, uranium, clay, rock, sand and gravel in, on, under and that may be produced from the Land, together with all rights, privileges, and immunities relating thereto, whether or not appearing in the Public Records or listed in Schedule B. Stewart makes no representation as to the present ownership of any such interests. There may be leases, grants, exceptions or reservations of interest that are not listed.
8. General taxes for the year 2021 and subsequent years, which are a lien due not yet payable.
9. Water and sewer charges of the City of Ketchum.
10. Ketchum rubbish charges billed by Clear Creek Disposal.
11. Facts evidenced by that certain Survey, recorded June 8, 2018, as [Instrument No. 652396](#), records of Blaine County, Idaho.
12. Indemnity Agreement, including the terms and provisions thereof, by and between Fritz X. Haemmerle and Reli L. Haemmerle and the City of Ketchum, recorded November 20, 2020 as [Instrument No. 675966](#), records of Blaine County, Idaho.
13. Notes, Easements and Restrictions, as shown on the plat of Gem Street Subdivision, recorded November 20, 2020 as [Instrument No. 675967](#), records of Blaine County, Idaho.



SCHEDULE B



CZ

INDEMNITY AGREEMENT

Effective this 12th day of November 2020, Fritz X. Haemmerle and Reli L. Haemmerle (collectively "Owners") and the City of Ketchum ("City"), hereby enter into this Indemnity Agreement ("Agreement") as follows:

RECITALS:

WHEREAS the City approved a lot line shift Application filed by the Owners;

WHEREAS, as part of the approval, the City estashed certain right of ways and snow storage easements for the Lots. The Lots are described as follows:

Lots 1 and 2, Gem Street Subdivisions, according to the Official Plat of record, records of Blaine County, State of Idaho.

WHEREAS, the City allowed the Owners to keep their fences in place as a condition of approval of the Application, provided the Owners indemnify and hold the City harmless for damages caused to the fences by the City, so long as the existing fences are located in the right of way or snow storage easements; now therefore

The Parties AGREE AS FOLLOWS:

1. Incorporation of Recitals. The Recitals are incorporated into and made a part of this Agreement.
2. Indemnification. So long as the existing fences are located within the right of way or snow storage easements, as set out in the Gem Street Subdivision Plat, the Owners, on behalf of their agents affiliates, attorneys, successors, and assigns, do fully, finally and forever release and discharge the City against all loses and expenses arising from the City's maintenance of its street, right of ways or easements. If the fences are relocated out of the right of ways or snow storage easement, this indemnification is null and void.
3. Governing Law, Jurisdiction and Venue. This Settlement Agreement and Mutual Release shall be governed by the laws of the State of Idaho. Jurisdiction and venue shall be in Blaine County, State of Idaho.
4. Entire Agreement. This Agreement, together with the accompanying exhibit, constitutes the entire, completely integrated agreement among the parties and supersedes all prior memoranda, agreements, correspondence, conversations, and negotiations.
5. Binding Effect. This Agreement and the Exhibits attached hereto shall be binding upon and shall inure to the benefit of the parties hereto, their heirs, administrators, successors and permitted assigns.

Date: This 12 day of November, 2020.

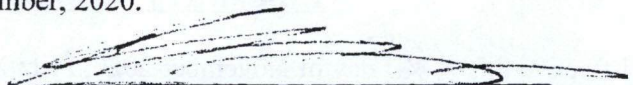

Owner, Reli L. Haemmerle

STATE OF IDAHO)

)ss.

COUNTY OF BLAINE.)

On this 12 day of Nov. 2020, before me, the subscriber, a Notary Public in and for said State and County, personally appeared Reli L. Haemmerle, known or identified to me to be the person whose name is subscribed to the within instrument, and in due form of law acknowledged that executed the same as his voluntary act.

IN TESTIMONY WHEREOF, I have hereunto set my hand and affixed my seal in said State and County on the day and year last above written.



(Signature of Notary)

My Commission Expires: 8/18/21

6. Counterparts and Fax Signatures. This Settlement Agreement and Mutual Release may be executed in one or more counterparts, each of which shall be deemed an original, but all of which together shall constitute one and the same instrument. All parties may sign this Settlement Agreement and Mutual Release with fax signatures.

7. Attorney Fees and Costs. In the event of a dispute arises between the parties regarding the interpretation or enforcement of this Agreement, the prevailing party shall be entitled to recover from the other party his reasonable attorney's fees and costs incurred therein whether or not a lawsuit is ever filed and on any appeals.

For OWNERS:

Date: This 12th day of November, 2020.

Owner, Fritz X. Haemmerle

STATE OF IDAHO)
)ss.
COUNTY OF BLAINE.)

On this 12th day of November 2020, before me, the subscriber, a Notary Public in and for said State and County, personally appeared Fritz X. Haemmerle, known or identified to me to be the person whose name is subscribed to the within instrument, and in due form of law acknowledged that executed the same as his voluntary act.

IN TESTIMONY WHEREOF, I have hereunto set my hand and affixed my seal in said State and County on the day and year last above written.

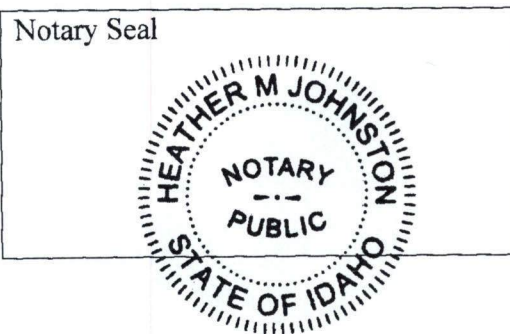

(Signature of Notary)

My Commission Expires: 9-14-2020

Electronically recorded – Do not
remove the county stamped first
page as it is now incorporated as
part of the original document.



WARRANTY DEED

FOR VALUE RECEIVED

Fritz Xavier Haemmerle, a married man dealing with his sole and separate property, fifty percent (50%) interest and Reli Louise Haemmerle, an unmarried woman, fifty percent (50%) interest

GRANTOR(S), hereby grants, bargains, sells, conveys and warrants unto

Sallie Castle, an unmarried woman

GRANTEE(S) whose current address is: P.O. Box 2422, Ketchum, ID 83340

the following described premises, to-wit:

Lot 2, Block 1 of GEM STREET SUBDIVISION, as shown on the official plat thereof, recorded as Instrument No. 675967, records of Blaine County, Idaho.

TO HAVE AND TO HOLD the said premises, with their appurtenances unto the said Grantee, its heirs and assigns forever. And the said Grantor does hereby covenant to and with the said Grantee, that Grantor is the owner in fee simple of said premises; that they are free from all encumbrances except those to which this conveyance is expressly made subject to and those made, suffered or done by the Grantee; and subject to all existing patent reservations; restrictions in railroad deeds of record; easements and rights of way established and of record; protective covenants of record; zoning ordinances and applicable building codes, use restrictions, ordinances, laws and regulations of any governmental unit; general taxes and assessments, including irrigation and utility assessments (if any) for the current year, which are not due and payable; and that Grantor will warrant and defend the same from all lawful claims whatsoever. Whenever the context so requires, the singular number includes the plural.

Dated this 25 day of November, 2020.

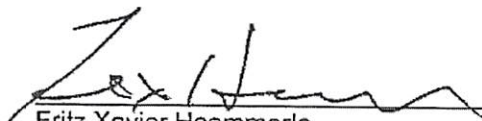
Fritz Xavier Haemmerle

Reli Louise Haemmerle

State of Idaho
County of Blaine

This record was acknowledged before me on 25 day of November, 2020, by Fritz Xavier Haemmerle and Reli Louise Haemmerle.

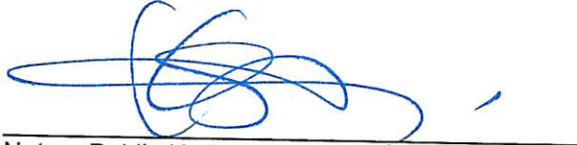

Notary Public Kathy Seal
My Commission Expires: 7.26.2023

(STAMP)



Attachment B:
Preliminary Plat Plan Set

A PLAT SHOWING REPLAT OF LOT 2 GEM STREET SUBDIVISION

WHEREIN LOT 2, BLOCK 1, GEM STREET SUBDIVISION IS SUBDIVIDED AS SHOWN HEREON
LOCATED WITHIN SECTION 18, T.4N., R.18E., B.M., CITY OF KETCHUM, BLAINE COUNTY, IDAHO

AUGUST 2021



SCALE: 1" = 20'

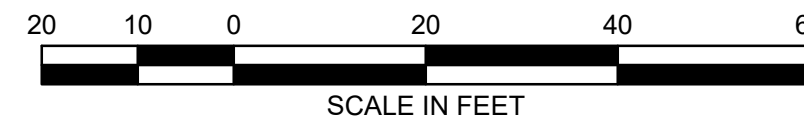

LEGEND

	Property Boundary
	Proposed Lot Line
	Adjoiner's Lot Line
	Easement, Type & Width as Shown
	Fence Line
	GIS Tie Line
	Existing Sewer Main
	Existing Sewer Service
	Proposed 4" Sewer Service
	Existing Water Main
	Existing Water Service
	Proposed 3/4" Water Service
	Existing Gas Line
	Existing Overhead Powerline
	Proposed Underground Power Service
	1' Contour Interval
	5' Contour Interval
	Existing Edge of Asphalt Line
	Proposed Edge of Asphalt Line
	Proposed Asphalt
	Existing Building
	Found Aluminum Cap
	Found 1/2" Rebar
	Found 5/8" Rebar
	Set 5/8" Rebar, P.L.S. 16670
	Approximate Existing Drainage Direction and Grade
	Existing Power Transformer

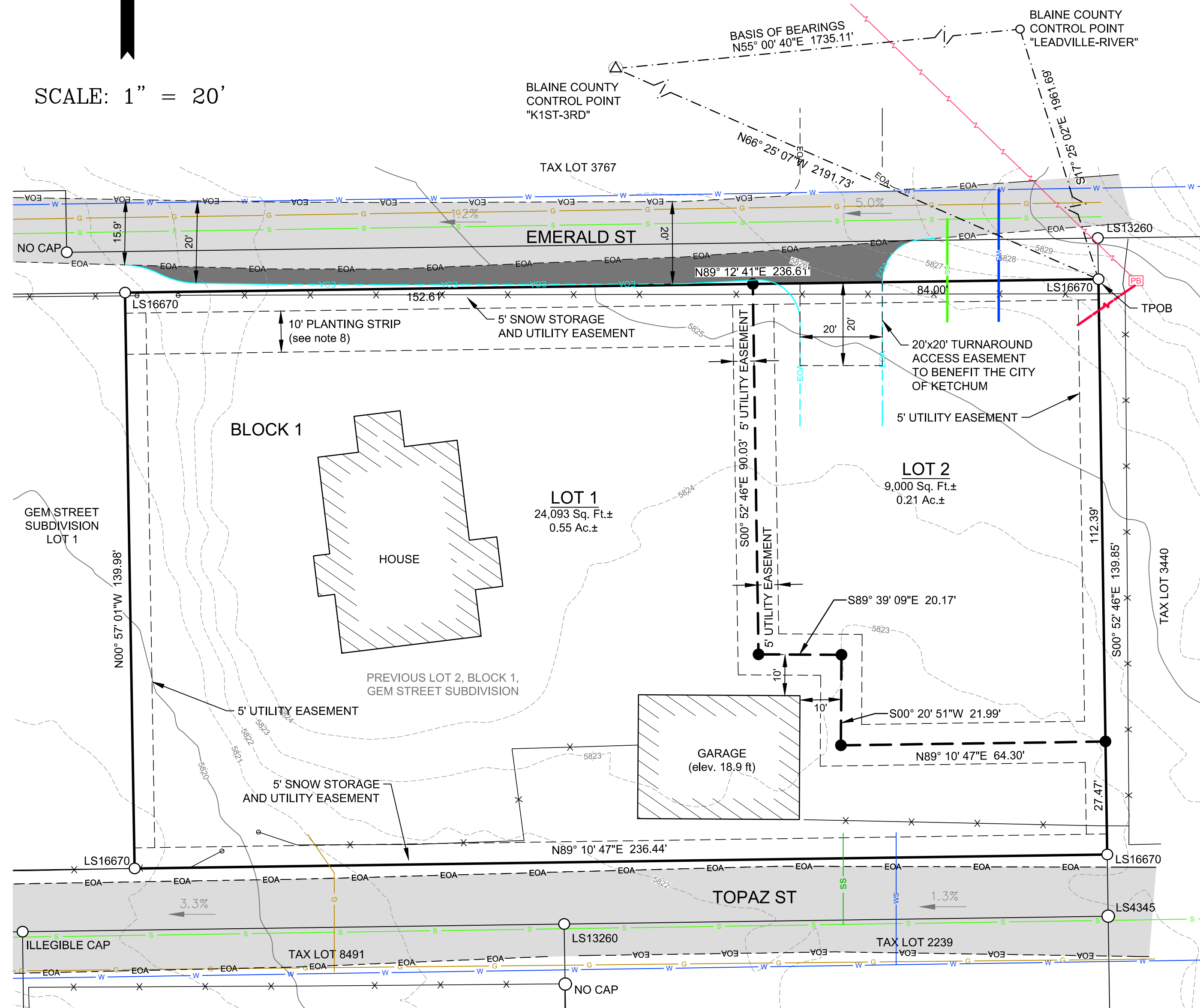

SURVEY NARRATIVE & NOTES

- The purpose of this survey is to subdivide Lot 2, Block 1, Gem Street Subdivision into Lots 1 & 2, Block 1, Replat of Lot 2 Gem Street Subdivision as shown hereon. The boundary shown is based on found monuments, and the plat of Gem Street Subdivision, Instrument Number 675966, records of Blaine County, Idaho. All found monuments have been accepted. Additional Documents used in the course of this survey include; Warranty Deeds, Instrument Numbers 132181, 132252, 229345, & 285434, all records of Blaine County, Idaho.
- A Title Commitment has been issued by Stewart Title Guaranty Company, File Number 2022464, with a Date of Guarantee of November 25, 2020. Certain information contained in said title policy may not appear on this map or may affect items shown hereon. It is the responsibility of the owner or agent to review said title policy. All plottable encumbrances and easements listed in the title report are shown hereon. Review of specific documents is required, if further information is desired.
- As shown hereon, there are existing fences within the proposed snow storage easements. Said fences will be allowed to remain until their respective lots are developed. At that time, the fences will be required to be removed from the snow storage easements, and these easements will be required to be kept clear of obstructions. An indemnification agreement is recorded under Instrument Number 675966, records of Blaine County Idaho, to indemnify the City of Ketchum from any damage to the fences prior to their removal.
- The current zoning is Limited Residential. Refer to the City of Ketchum Zoning Ordinance for more information about this zone.
- The owner and subdivider is Sallie Castle, PO Box 2422, Ketchum, ID 83343. The representative is Sean Flynn, Galena Engineering, Inc., 317 N River St., Hailey, ID 83333.
- A 5' Utility Easement exists adjacent to all exterior lot lines and centered along all interior lot lines. All utilities to be installed underground.
- Parking of cars and other vehicles is prohibited along Emerald and Topaz Street within the City Right of Way, or within any asphalted areas of the Streets.
- A 10' planting strip on Lot 1, as shown hereon, shall be devoted exclusively to landscaping. No vehicular access from Lot 1 onto Emerald Street is permitted.
- A 5' snow storage easement, as shown hereon, is reserved for use by the City of Ketchum for the placement of snow removed from public rights-of-way.

HEALTH CERTIFICATE: Sanitary restrictions as required by Idaho Code Title 50, Ch. 13, have been satisfied. Sanitary restrictions may be reimposed in accordance with Idaho Code Title 50, Ch. 13, Sec. 50-1326, by issuance of a Certificate of Disapproval.

Date _____ South Central Public Health District



REPLAT OF LOT 2 GEM STREET SUBDIVISION
GALENA ENGINEERING, INC.
HAILEY, IDAHO
SHEET 1 OF 2
Job No. 8074

CERTIFICATE OF OWNERSHIP

This is to certify that the undersigned is the owner in fee simple of the following described parcel of land:

A parcel of land located within Section 18, T.4N., R.18E., B.M., City of Ketchum, Blaine County, Idaho, more particularly described as follows:

Lot 2, Gem Street Subdivision

The easements indicated hereon are not dedicated to the public, but the right to use said easements is hereby reserved for the public utilities and for any other uses indicated hereon and no permanent structures are to be erected within the lines of said easements.

I do hereby certify that all lots in this plat will be eligible to receive water service from an existing water distribution system and that the existing water distribution system has agreed in writing to serve all of units shown within this plat.

It is the intent of the owner to hereby include said land in this plat.

Sallie Castle

ACKNOWLEDGMENT

STATE OF _____ }
COUNTY OF _____ } ss

On this ____ day of _____, 20____, before me, a Notary Public in and for said State, personally appeared Sallie Castle, known or identified to me to be the person whose name is subscribed to the foregoing instrument, and acknowledged to me that he executed the same.

IN WITNESS WHEREOF, I have hereunto set my hand and affixed my official seal the day and year in this certificate first above written.

Notary Public in and for said State
Residing in _____
My Commission Expires _____

SURVEYOR'S CERTIFICATE

I, Mark E. Phillips, a duly Licensed Professional Land Surveyor in the State of Idaho, do hereby certify that this plat is a true and accurate map of the land and points surveyed under my direct supervision and that it is in accordance with the Idaho State Code relating to Plats, Surveys, and the Corner Perpetuation and Filing Act, 55-1601 through 55-1612.

Mark E. Phillips, P.L.S. 16670

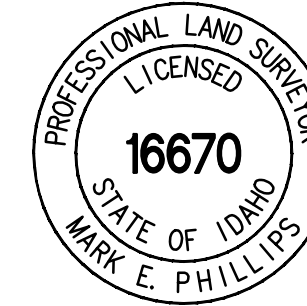

BLAINE COUNTY SURVEYOR'S APPROVAL

I, Sam Young County Surveyor for Blaine County, Idaho, do hereby certify that I have checked the foregoing Plat and computations for making the same and have determined that they comply with the laws of the State of Idaho relating to Plats and Surveys

Sam Young, P.L.S. 11577
Blaine County Surveyor

Date

KETCHUM CITY ENGINEER'S APPROVAL

The foregoing plat was approved by _____, City Engineer for the City of Ketchum on this _____ day of _____, 2021.

City Engineer

KETCHUM CITY COUNCIL'S APPROVAL

I, _____, Planner in and for the City of Ketchum, do hereby certify that the foregoing plat was duly accepted and approved according to the Ketchum Subdivision-Ordinance.

By: _____

Date

Certified by City Clerk

By: _____

Date

BLAINE COUNTY TREASURER'S APPROVAL

I, the undersigned County Treasurer in and for Blaine County, State of Idaho per the requirements of Idaho Code 50-1308, do hereby certify that any and all current and/or delinquent county property taxes for the property included in this subdivision have been paid in full. This certification is valid for the next thirty (30) days only.

Blaine County Treasurer

Date

BLAINE COUNTY RECORDER'S CERTIFICATE

Attachment C:
**Draft City Council Findings of
Fact, Conclusions of Law, and
Decision**



City of Ketchum
Planning & Building

IN RE:)	
)	
151 Topaz Street)	KETCHUM CITY COUNCIL
Subdivision – Preliminary Plat)	FINDINGS OF FACT, CONCLUSIONS OF LAW, AND
Date: November 18, 2021)	DECISION
)	
File Number: 21-034)	

PROJECT: 151 Topaz Street Subdivision

APPLICATION TYPE: Subdivision – Preliminary Plat

FILE NUMBER: P21-034

ASSOCIATED APPLICATIONS: None

REPRESENTATIVE: Sean Flynn, Galena Engineering (Engineer)

OWNER: Sallie Castle

LOCATION: 151 Topaz (Lot 2, Block 1 – Gem Street Subdivision)

ZONING: Limited Residential (LR)

OVERLAY: None

RECORD OF PROCEEDINGS

The City of Ketchum received the application for Subdivision Preliminary Plat on April 5, 2021. The application was deemed complete on June 9, 2021, after one review for completeness. Following receipt of the complete application, staff routed the application materials to all city departments for review. Department comments were provided to the applicant on June 25, 2021.

A public hearing notice for the project was mailed to all owners of property within 300 feet of the project site and all political subdivisions on October 6, 2021. The public hearing notice was published in the Idaho Mountain Express and the city’s website on October 6, 2021. A notice was posted on the project site on October 19, 2021.

The Planning & Zoning Commission (the “Commission”) considered the Subdivision Preliminary Plat application (Application File No. P21-034) during the regular meeting on October 26, 2021. After considering Staff’s analysis, the applicant’s presentation, and public comment, the Commission voted

to recommended approval of the Subdivision Preliminary Plat application to the City Council with a vote of 4 to 1.

BACKGROUND

The Applicant is proposing to subdivide Lot 2 of the Gem Street Subdivision, located at 151 Topaz Street (the “subject property”) into two lots (the “project”). The subject property is zoned Limited Residential (LR) and has an existing single family dwelling unit and detached garage. The project proposes to retain the existing single family dwelling unit and garage and create a new 9,000 square foot lot on the eastern portion of the existing lot. See Attachment B for the preliminary plat illustrating the location of the existing dwelling unit and proposed lot lines for the new lot.

FINDINGS OF FACT

The Council, having reviewed the entire project record, provided notice, conducted the required public hearing, and considered the recommendation from the Planning and Zoning Commission, does hereby make and set forth these Findings of Fact, Conclusions of Law, and Decision as follows:

FINDINGS REGARDING CONFORMANCE WITH THE COMPREHENSIVE PLAN

The City of Ketchum adopted the 2014 Comprehensive Plan (the “plan”) on February 18, 2014. The plan outlines the community vision and core values for the city. Using those, the plan outlines goals and policy objectives to reach key goals for the community related to the economy, housing, neighborhoods, parks and recreation, open space, public safety, and others. The plan also includes a Future Land Use Map (FLUM) that identifies possible future land uses for properties to achieve desirable land use patterns for the city.

Specifically, the plan includes goals and policies in Chapter 3: Housing, Chapter 4: Community Design and Neighborhoods, and Chapter 9: Public Safety and Utilities that relate to the proposed application.

- Housing Goal H-1: Ketchum will increase its supply of homes, including rental and special-needs housing for low, moderate, and median-income households.
 - Although the city cannot require the future owner or development of the proposed lot be targeted for a certain type of household or income category, the addition of a lot provides an opportunity to construct one additional dwelling unit and one additional accessory dwelling unit than exists today. Policy H-1.3 of this goal discusses the desire to integrate affordable housing into neighborhoods. Additionally, Policy H-1.5 states that “the community will continue to support and encourage construction of accessory dwelling units within residential areas to provide affordable housing.” The approval of the proposed application assists in achieving these goals.
- Community Design and Neighborhoods Goal CD-1: Our community will preserve its small-town character and the distinct image of neighborhoods and districts.
 - Policy CD-1.3 discusses infill and redevelopment projects. The policy emphasizes the importance of contextually appropriate projects. Specifically, projects should consider natural and manmade features adjoining a development site, not a certain style. In contrast to that, the plan also states that each neighborhood or district should include a mix of design elements that will reinforce its unique design (Policy CD-1.1). The subject property is located within the Gem Street Neighborhood, one of the oldest and least modified neighborhoods in the community. Many of the lots are large with smaller footprint log cabin or A-frame residential dwelling units. Some properties include a detached garage in addition to the primary dwelling unit. The subject property is one of

the larger lots in the Gem Street Neighborhood, equivalent to almost four of the properties found to the south and west. As the application is a request to create one lot, not multiple lots, the perceived impact of the subdivision may be less.

- Subdivision of property often results in the construction of new homes, sometimes reflective of current architectural trends or styles that may contradict the unique design of the neighborhood as it sits today. Although the lot sizes may be like the surrounding neighborhood, design of the future structure may differ. Design review is not required for single family dwelling units.
- Public Safety and Utilities Goal PDU-3: Provide safety related capital improvements in conjunction with new development.
 - Policy PSU-3.2 outlines that infill development and redevelopment should be encouraged where excess utility capacity is available. Policy PSU-1.1 discusses that the city will continue to provide high-quality police and emergency services. The Gem Streets are a neighborhood where providing street maintenance and emergency services is very challenging. Most areas do not have dedicated public right-of-way and where right-of-way exists, it is substandard in width and level of improvements. Public improvements required for redevelopment of property is one of the few ways the city can offer greater levels of service to the neighborhood through right-of-way dedications and physical improvements to streets and drainage.
- Future Land Use Map (FLUM)
 - The FLUM designates the subject property as “Low Density Residential”. Primary uses for this land use designation include “Single-family and duplex residences and accessory units.” The plan also states that “the average density of a residential area in this category is not to exceed about five units per acre.” A density of five units per acre equates to approximately one primary dwelling unit per 8,700 square feet of land. The new lot is 9,000 square feet, which is the minimum lot size in the LR zone district. Accessory dwelling units are not counted in density calculations as they are considered accessory and optional.

Although the subdivision of the property may result in new development with a different design than exists today, the request to subdivide the property is in conformance with the FLUM and forwards many policies aimed at housing and public safety.

FINDINGS REGARDING PRELIMINARY PLAT SUBDIVISION REQUIREMENTS

Preliminary Plat Requirements				
Compliant				
Yes	No	N/A	City Code	City Standards
<input checked="" type="checkbox"/>	<input type="checkbox"/>	<input type="checkbox"/>	16.04.030.C.1	The subdivider shall file with the administrator copies of the completed subdivision application form and preliminary plat data as required by this chapter.
			<i>Findings</i>	The City of Ketchum Planning and Building Department received the subdivision application and all applicable application materials on April 5, 2021.
<input checked="" type="checkbox"/>	<input type="checkbox"/>	<input type="checkbox"/>	16.04.030.I	Contents Of Preliminary Plat: The preliminary plat, together with all application forms, title insurance report, deeds, maps, and other documents reasonably required, shall constitute a complete subdivision application.
			<i>Findings</i>	The subdivision application was deemed complete on June 25, 2021.

<input checked="" type="checkbox"/>	<input type="checkbox"/>	<input type="checkbox"/>	16.04.030.I .1	The preliminary plat shall be drawn to a scale of not less than one inch equals one hundred feet (1" = 100') and shall show the following: The scale, north point and date.
			<i>Findings</i>	This standard is met as shown on Sheet 1 of the preliminary plat.
<input checked="" type="checkbox"/>	<input type="checkbox"/>	<input type="checkbox"/>	16.04.030.I .2	The name of the proposed subdivision, which shall not be the same or confused with the name of any other subdivision in Blaine County, Idaho.
			<i>Findings</i>	As shown on Sheet 1 of the preliminary plat, the application is a replat of Lot 2 of the existing Gem Street Subdivision. As this is a subdivision of an existing lot, the subdivision name remains the same.
<input checked="" type="checkbox"/>	<input type="checkbox"/>	<input type="checkbox"/>	16.04.030.I .3	The name and address of the owner of record, the subdivider, and the engineer, surveyor, or other person preparing the plat.
			<i>Findings</i>	As shown on Sheets 1 and 2, the owner and subdivider is Sallie Castle. The plat was prepared by Mark Phillips of Galena Engineering.
<input checked="" type="checkbox"/>	<input type="checkbox"/>	<input type="checkbox"/>	16.04.030.I .4	Legal description of the area platted.
			<i>Findings</i>	The legal description of the area platted is shown in the Certificate of Ownership on Sheet 2 of the preliminary plat.
<input checked="" type="checkbox"/>	<input type="checkbox"/>	<input type="checkbox"/>	16.04.030.I .5	The names and the intersecting boundary lines of adjoining subdivisions and parcels of property.
			<i>Findings</i>	Sheet 1 of the preliminary plat indicates the boundary lines of the adjoining tax lots to the east, north, and south, as well as the lot within the Warm Springs Subdivision to the west.
<input checked="" type="checkbox"/>	<input type="checkbox"/>	<input type="checkbox"/>	16.04.030.I .6	A contour map of the subdivision with contour lines and a maximum interval of five feet (5') to show the configuration of the land based upon the United States geodetic survey data, or other data approved by the city engineer.
			<i>Findings</i>	Sheet 1 of the preliminary plat shows the contour lines for the subject property.
<input checked="" type="checkbox"/>	<input type="checkbox"/>	<input type="checkbox"/>	16.04.030.I 7	The scaled location of existing buildings, water bodies and courses and location of the adjoining or immediately adjacent dedicated streets, roadways and easements, public and private.
			<i>Findings</i>	Sheet 1 of the preliminary plat shows the location of the existing dwelling unit and detached garage on Lot 1 and all adjacent streets. Sheet 1 also indicates the snow storage and utility easement, and turnaround access easement on the northern property boundary, and utility easements along all property lines.
<input checked="" type="checkbox"/>	<input type="checkbox"/>	<input type="checkbox"/>	16.04.030.I .8	Boundary description and the area of the tract.
			<i>Findings</i>	Sheet 1 provides the boundary description of the area and includes square footage and acreage of both lots.
<input checked="" type="checkbox"/>	<input type="checkbox"/>	<input type="checkbox"/>	16.04.030.I .9	Existing zoning of the tract.
			<i>Findings</i>	Plat note #4 on Sheet 1 of the preliminary plat lists the existing zoning of the subject property.
<input checked="" type="checkbox"/>	<input type="checkbox"/>	<input type="checkbox"/>	16.04.030.I .10	The proposed location of street rights of way, lots, and lot lines, easements, including all approximate dimensions, and including all proposed lot and block numbering and proposed street names.
			<i>Findings</i>	No new streets or blocks are proposed for the project; however, Sheet 1 of the preliminary plat includes names and dimensions of all existing right-of-way for Emerald Street to the north and Topaz Street to the south. Sheet 1 of the preliminary plat shows the locations and lot lines for the proposed lots.
<input type="checkbox"/>	<input type="checkbox"/>	<input checked="" type="checkbox"/>	16.04.030.I .11	The location, approximate size and proposed use of all land intended to be dedicated for public use or for common use of all future property owners within the proposed subdivision.

			<i>Findings</i>	This standard is not applicable as there is no requirement or proposal for land dedicated for public or common use.
<input checked="" type="checkbox"/>	<input type="checkbox"/>	<input type="checkbox"/>	16.04.030.I .12	The location, size and type of sanitary and storm sewers, water mains, culverts and other surface or subsurface structures existing within or immediately adjacent to the proposed sanitary or storm sewers, water mains, and storage facilities, street improvements, street lighting, curbs, and gutters and all proposed utilities.
			<i>Findings</i>	As shown on Sheet 1, the existing dwelling unit is currently served by city water and sewer. The new lot will have separate services for water and sewer from the main lines in Emerald Street as shown on Sheet 1 of the preliminary plat.
<input type="checkbox"/>	<input type="checkbox"/>	<input checked="" type="checkbox"/>	16.04.030.I .13	The direction of drainage, flow and approximate grade of all streets.
			<i>Findings</i>	This standard does not apply as no new streets are proposed.
<input type="checkbox"/>	<input type="checkbox"/>	<input checked="" type="checkbox"/>	16.04.030.I .14	The location of all drainage canals and structures, the proposed method of disposing of runoff water, and the location and size of all drainage easements, whether they are located within or outside of the proposed plat.
			<i>Findings</i>	This standard does not apply as no new drainage canals or structures are proposed.
<input type="checkbox"/>	<input type="checkbox"/>	<input checked="" type="checkbox"/>	16.04.030.I .15	All percolation tests and/or exploratory pit excavations required by state health authorities.
			<i>Findings</i>	This standard does not apply as no addition tests are required.
<input type="checkbox"/>	<input type="checkbox"/>	<input checked="" type="checkbox"/>	16.04.030.I .16	A copy of the provisions of the articles of incorporation and bylaws of homeowners' association and/or condominium declarations to be filed with the final plat of the subdivision.
			<i>Findings</i>	This standard does not apply as this preliminary plat application is not for a townhouse or condominium subdivision and no commonly owned land or facilities are proposed.
<input checked="" type="checkbox"/>	<input type="checkbox"/>	<input type="checkbox"/>	16.04.030.I .17	Vicinity map drawn to approximate scale showing the location of the proposed subdivision in reference to existing and/or proposed arterials and collector streets.
			<i>Findings</i>	Sheet 1 of the preliminary plat shows the surrounding streets. There are no collector streets within this are of the Gem Street Neighborhood as the streets are dead ends. Highway 75 is the closest arterial, located just west of the subject property.
<input type="checkbox"/>	<input type="checkbox"/>	<input checked="" type="checkbox"/>	16.04.030.I .18	The boundaries of the floodplain, floodway and avalanche zoning district shall also be clearly delineated and marked on the preliminary plat.
			<i>Findings</i>	The subject property is not within a floodplain, floodway, or avalanche zone district.
<input type="checkbox"/>	<input type="checkbox"/>	<input checked="" type="checkbox"/>	16.04.030.I .19	Building envelopes shall be shown on each lot, all or part of which is within a floodway, floodplain, or avalanche zone; or any lot that is adjacent to the Big Wood River, Trail Creek, or Warm Springs Creek; or any lot, a portion of which has a slope of twenty five percent (25%) or greater; or upon any lot which will be created adjacent to the intersection of two (2) or more streets.
			<i>Findings</i>	A building envelope is not required as the subject property is not within the floodway, floodplain, or avalanche zone. The subject property is not adjacent to the Big Wood River, Trail Creek or Warm Springs. The subject property does not contain slopes greater than 25% and is not adjacent to an intersection.
<input checked="" type="checkbox"/>	<input type="checkbox"/>	<input type="checkbox"/>	16.04.030.I .20	Lot area of each lot.

			<i>Findings</i>	As shown on Sheet 1 of the preliminary plat, the area of Lot 1 is 24,093 square feet and the area of Lot 2 is 9,000 square feet.
<input checked="" type="checkbox"/>	<input type="checkbox"/>	<input type="checkbox"/>	16.04.030.I .21	Existing mature trees and established shrub masses.
			<i>Findings</i>	As verified by a site visit with city staff, the subject property includes multiple mature trees, primarily on Lot 1. Lot 2 contains some shrubs in the northeast corner where the property slopes uphill toward the right-of-way of Emerald Street. None of the trees on Lot 1 are within the snow storage easement. A 10-foot-wide planting strip is noted for Lot 1 as the existing lot is a nonconforming double frontage lot. Per plat note #8, the planting strip along Lot 1 shall be devoted exclusively to landscaping. No vehicular access from Lot 1 onto Emerald Street is permitted.
<input checked="" type="checkbox"/>	<input type="checkbox"/>	<input type="checkbox"/>	16.04.030.I .22	A current title report shall be provided at the time that the preliminary plat is filed with the administrator, together with a copy of the owner's recorded deed to such property.
			<i>Findings</i>	The applicant provided a title commitment issued by Stewart Title dated November 25, 2020 and a warranty deed recorded on November 25, 2020 with the Blaine County Clerk and Recorder.
<input checked="" type="checkbox"/>	<input type="checkbox"/>	<input type="checkbox"/>	16.04.030.I .23	Three (3) copies of the preliminary plat shall be filed with the administrator.
			<i>Findings</i>	The City of Ketchum received hard and digital copies of the preliminary plat at the time of application.
<input checked="" type="checkbox"/>	<input type="checkbox"/>	<input type="checkbox"/>	16.04.040.A	Required Improvements: The improvements set forth in this section shall be shown on the preliminary plat and installed prior to approval of the final plat. Construction design plans shall be submitted and approved by the city engineer. All such improvements shall be in accordance with the comprehensive plan and constructed in compliance with construction standard specifications adopted by the city. Existing natural features which enhance the attractiveness of the subdivision and community, such as mature trees, watercourses, rock outcroppings, established shrub masses and historic areas, shall be preserved through design of the subdivision.
			<i>Findings</i>	As shown on Sheet 1 of the preliminary plat, all proposed improvements to the public right-of-way are shown. As outlined in condition of approval #4, all right-of-way improvements are required prior to approval of the Final Plat. The subject property does not include any watercourses, rock outcroppings, significant shrub masses or historic areas. At this time, a development proposal has not been submitted for the future use of the property. All future development plans must comply with all applicable provisions of Title 17, including KMC 17.124.170 – Minimum standards for one-family dwellings.
<input type="checkbox"/>	<input type="checkbox"/>	<input checked="" type="checkbox"/>	16.04.040.B	Improvement Plans: Prior to approval of final plat by the commission, the subdivider shall file two (2) copies with the city engineer, and the city engineer shall approve construction plans for all improvements required in the proposed subdivision. Such plans shall be prepared by a civil engineer licensed in the state.
			<i>Findings</i>	This standard does not apply as this is a preliminary plat application, not a final plat application. Compliance with this standard will be required for Final Plat application.
<input checked="" type="checkbox"/>	<input type="checkbox"/>	<input type="checkbox"/>	16.04.040.C	Prior to final plat approval, the subdivider shall have previously constructed all required improvements and secured a certificate of completion from the city engineer. However, in cases where the required improvements cannot be constructed due to weather conditions or other factors beyond the control of the subdivider, the city council may accept, in lieu of any or all of the required

				<p>improvements, a performance bond filed with the city clerk to ensure actual construction of the required improvements as submitted and approved. Such performance bond shall be issued in an amount not less than one hundred fifty percent (150%) of the estimated costs of improvements as determined by the city engineer. In the event the improvements are not constructed within the time allowed by the city council (which shall be one year or less, depending upon the individual circumstances), the council may order the improvements installed at the expense of the subdivider and the surety. In the event the cost of installing the required improvements exceeds the amount of the bond, the subdivider shall be liable to the city for additional costs. The amount that the cost of installing the required improvements exceeds the amount of the performance bond shall automatically become a lien upon any and all property within the subdivision owned by the owner and/or subdivider.</p>
			<i>Findings</i>	As noted in condition of approval #4, all required improvements must be complete prior to approval of the Final Plat.
<input type="checkbox"/>	<input type="checkbox"/>	<input checked="" type="checkbox"/>	16.04.040.D	<p>As Built Drawing: Prior to acceptance by the city council of any improvements installed by the subdivider, two (2) sets of as built plans and specifications, certified by the subdivider's engineer, shall be filed with the city engineer. Within ten (10) days after completion of improvements and submission of as built drawings, the city engineer shall certify the completion of the improvements and the acceptance of the improvements, and shall submit a copy of such certification to the administrator and the subdivider. If a performance bond has been filed, the administrator shall forward a copy of the certification to the city clerk. Thereafter, the city clerk shall release the performance bond upon application by the subdivider.</p>
			<i>Findings</i>	This standard does not apply as this is a preliminary plat application, not a final plat application. Compliance with this standard will be required for Final Plat application.
<input type="checkbox"/>	<input type="checkbox"/>	<input checked="" type="checkbox"/>	16.04.040.E	<p>Monumentation: Following completion of construction of the required improvements and prior to certification of completion by the city engineer, certain land survey monuments shall be reset or verified by the subdivider's engineer or surveyor to still be in place. These monuments shall have the size, shape, and type of material as shown on the subdivision plat. The monuments shall be located as follows:</p> <ol style="list-style-type: none"> 1. All angle points in the exterior boundary of the plat. 2. All street intersections, points within and adjacent to the final plat. 3. All street corner lines ending at boundary line of final plat. 4. All angle points and points of curves on all streets. 5. The point of beginning of the subdivision plat description.
			<i>Findings</i>	This standard does not apply as this is a preliminary plat application, not a final plat application. Compliance with this standard will be required for Final Plat application.
<input checked="" type="checkbox"/>	<input type="checkbox"/>	<input type="checkbox"/>	16.04.040.F	<p>Lot Requirements:</p> <ol style="list-style-type: none"> 1. Lot size, width, depth, shape and orientation and minimum building setback lines shall be in compliance with the zoning district in which the property is located and compatible with the location of the subdivision and the type of development, and preserve solar access to adjacent properties and buildings. 2. Whenever a proposed subdivision contains lot(s), in whole or in part, within the floodplain, or which contains land with a slope in excess of twenty five percent (25%), based upon natural contours, or creates corner lots at the intersection of two (2) or more streets, building envelopes shall be shown for the lot(s) so

			<p>affected on the preliminary and final plats. The building envelopes shall be located in a manner designed to promote harmonious development of structures, minimize congestion of structures, and provide open space and solar access for each lot and structure. Also, building envelopes shall be located to promote access to the lots and maintenance of public utilities, to minimize cut and fill for roads and building foundations, and minimize adverse impact upon environment, watercourses and topographical features. Structures may only be built on buildable lots. Lots shall only be created that meet the definition of "lot, buildable" in section 16.04.020 of this chapter. Building envelopes shall be established outside of hillsides of twenty five percent (25%) and greater and outside of the floodway. A waiver to this standard may only be considered for the following:</p> <ul style="list-style-type: none"> a. For lot line shifts of parcels that are entirely within slopes of twenty five percent (25%) or greater to create a reasonable building envelope, and mountain overlay design review standards and all other city requirements are met. b. For small, isolated pockets of twenty five percent (25%) or greater that are found to be in compliance with the purposes and standards of the mountain overlay district and this section. <p>3. Corner lots shall have a property line curve or corner of a minimum radius of twenty five feet (25') unless a longer radius is required to serve an existing or future use.</p> <p>4. Side lot lines shall be within twenty degrees (20°) to a right angle or radial line to the street line.</p> <p>5. Double frontage lots shall not be created. A planting strip shall be provided along the boundary line of lots adjacent to arterial streets or incompatible zoning districts.</p> <p>6. Every lot in a subdivision shall have a minimum of twenty feet (20') of frontage on a dedicated public street or legal access via an easement of twenty feet (20') or greater in width. Easement shall be recorded in the office of the Blaine County recorder prior to or in conjunction with recordation of the final plat.</p>
		<p><i>Findings</i></p>	<ul style="list-style-type: none"> 1. The proposed townhouse subdivision meets all dimensional standards as outlined in the LR zone district. The minimum lot size is 9,000 square feet. Lot 1 and Lot 2 are 24,093 square feet and 9,000 square feet. Future development of Lot 2 must comply with setback requirements in the LR zone district. The existing structures on Lot 1 meet setback requirements for the LR zone district. The required minimum lot width in the LR zone district is "80 feet average". The average is taken by measuring the width of the lot in 10-foot increments and taking the average of all measurements. Using this methodology, the average lot width for Lot 1 is greater than 152.6 feet and 80 feet for Lot 2. 2. Building envelopes are not required as the subject property is not within the floodplain/floodway, avalanche zone, does not contain slopes greater than 25%, nor is it located adjacent to an intersection of two streets 3. The subject property is not a corner lot. 4. The newly created Lot 2 is within 20 degrees to a right angle to the street lot line along Emerald Street. 5. The subject property is not a double frontage lot. Lot 1 is an existing double frontage lot that was previously approved as part of the original Gem Street Subdivision in November 2020. A 10-foot planting strip has been added to Lot 1, restricting vehicular access from Emerald Street.

				<p>6. Both lots have a minimum of 20 feet of frontage on Emerald Street or Topaz Street. Lot 1 has 236.44 feet of frontage on Topaz Street and Lot 2 has 84 feet of frontage on Emerald Street.</p>
<input type="checkbox"/>	<input type="checkbox"/>	<input checked="" type="checkbox"/>	16.04.040.G	<p>G. Block Requirements: The length, width and shape of blocks within a proposed subdivision shall conform to the following requirements:</p> <ol style="list-style-type: none"> 1. No block shall be longer than one thousand two hundred feet (1,200'), nor less than four hundred feet (400') between the street intersections, and shall have sufficient depth to provide for two (2) tiers of lots. 2. Blocks shall be laid out in such a manner as to comply with the lot requirements. 3. The layout of blocks shall take into consideration the natural topography of the land to promote access within the subdivision and minimize cuts and fills for roads and minimize adverse impact on environment, watercourses and topographical features. 4. Corner lots shall contain a building envelope outside of a seventy five foot (75') radius from the intersection of the streets.
			<i>Findings</i>	This standard does not apply as no new blocks are being created.
<input checked="" type="checkbox"/>	<input type="checkbox"/>	<input type="checkbox"/>	16.04.040.H	<p>Street Improvement Requirements:</p> <ol style="list-style-type: none"> 1. The arrangement, character, extent, width, grade and location of all streets put in the proposed subdivision shall conform to the comprehensive plan and shall be considered in their relation to existing and planned streets, topography, public convenience and safety, and the proposed uses of the land; 2. All streets shall be constructed to meet or exceed the criteria and standards set forth in chapter 12.04 of this code, and all other applicable ordinances, resolutions or regulations of the city or any other governmental entity having jurisdiction, now existing or adopted, amended or codified; 3. Where a subdivision abuts or contains an existing or proposed arterial street, railroad or limited access highway right of way, the council may require a frontage street, planting strip, or similar design features; 4. Streets may be required to provide access to adjoining lands and provide proper traffic circulation through existing or future neighborhoods; 5. Street grades shall not be less than three-tenths percent (0.3%) and not more than seven percent (7%) so as to provide safe movement of traffic and emergency vehicles in all weather and to provide for adequate drainage and snow plowing; 6. In general, partial dedications shall not be permitted, however, the council may accept a partial street dedication when such a street forms a boundary of the proposed subdivision and is deemed necessary for the orderly development of the neighborhood, and provided the council finds it practical to require the dedication of the remainder of the right of way when the adjoining property is subdivided. When a partial street exists adjoining the proposed subdivision, the remainder of the right of way shall be dedicated; 7. Dead end streets may be permitted only when such street terminates at the boundary of a subdivision and is necessary for the development of the subdivision or the future development of the adjacent property. When such a dead end street serves more than two (2) lots, a temporary turnaround easement shall be provided, which easement shall revert to the adjacent lots when the street is extended; 8. A cul-de-sac, court or similar type street shall be permitted only when necessary to the development of the subdivision, and provided, that no such street shall have a maximum length greater than four hundred feet (400') from

			<p>entrance to center of turnaround, and all cul-de-sacs shall have a minimum turnaround radius of sixty feet (60') at the property line and not less than forty five feet (45') at the curb line;</p> <p>9. Streets shall be planned to intersect as nearly as possible at right angles, but in no event at less than seventy degrees (70°);</p> <p>10. Where any street deflects an angle of ten degrees (10°) or more, a connecting curve shall be required having a minimum centerline radius of three hundred feet (300') for arterial and collector streets, and one hundred twenty five feet (125') for minor streets;</p> <p>11. Streets with centerline offsets of less than one hundred twenty five feet (125') shall be prohibited;</p> <p>12. A tangent of at least one hundred feet (100') long shall be introduced between reverse curves on arterial and collector streets;</p> <p>13. Proposed streets which are a continuation of an existing street shall be given the same names as the existing street. All new street names shall not duplicate or be confused with the names of existing streets within Blaine County, Idaho. The subdivider shall obtain approval of all street names within the proposed subdivision from the commission before submitting same to council for preliminary plat approval;</p> <p>14. Street alignment design shall follow natural terrain contours to result in safe streets, usable lots, and minimum cuts and fills;</p> <p>15. Street patterns of residential areas shall be designed to create areas free of through traffic, but readily accessible to adjacent collector and arterial streets;</p> <p>16. Reserve planting strips controlling access to public streets shall be permitted under conditions specified and shown on the final plat, and all landscaping and irrigation systems shall be installed as required improvements by the subdivider;</p> <p>17. In general, the centerline of a street shall coincide with the centerline of the street right of way, and all crosswalk markings shall be installed by the subdivider as a required improvement;</p> <p>18. Street lighting may be required by the commission or council where appropriate and shall be installed by the subdivider as a requirement improvement;</p> <p>19. Private streets may be allowed upon recommendation by the commission and approval by the council. Private streets shall be constructed to meet the design standards specified in subsection H2 of this section;</p> <p>20. Street signs shall be installed by the subdivider as a required improvement of a type and design approved by the administrator and shall be consistent with the type and design of existing street signs elsewhere in the city;</p> <p>21. Whenever a proposed subdivision requires construction of a new bridge, or will create substantial additional traffic which will require construction of a new bridge or improvement of an existing bridge, such construction or improvement shall be a required improvement by the subdivider. Such construction or improvement shall be in accordance with adopted standard specifications;</p> <p>22. Sidewalks, curbs and gutters may be a required improvement installed by the subdivider; and</p> <p>23. Gates are prohibited on private roads and parking access/entranceways, private driveways accessing more than one single-family dwelling unit and one accessory dwelling unit, and public rights of way unless approved by the city council.</p>
			<p>Emerald Street is classified as a residential street, requiring a minimum right-of-way of 60 feet. Emerald Street, unlike some streets in the Gem Street</p>

				<p>Neighborhood, has a designated right-of-way. However, the right-of-way is minimal. West of the property, the right-of-way is 25 feet but narrows to only 10 feet adjacent to the subject property, turning into a private driveway at the eastern property boundary. The subdivision regulations require that all streets meet the minimum standards as outlined in Chapter 12.04, however, this pertains to the creation of new subdivisions and the construction of new streets. The original Gem Street Subdivision, approved in November 2020, dedicated the 10 feet of right-of-way adjacent to the subject property. Additional right-of-way dedication to achieve a consistent 25 feet must come from the adjacent property to the north if or when it develops in the future. The goal for this application is to meet or exceed the minimum width and improvements required for efficient maintenance (primarily snow removal) and emergency service access. The following items are required to achieve this:</p> <ul style="list-style-type: none"> • 5-foot Snow storage and utility easement along Emerald Street • Designation of driveway curb cut location onto Emerald Street from the new lot, see recommended condition of approval #1 • Widening of pavement within the right of way to a consistent 20 feet from the western property boundary to the eastern side of the designated driveway access point of the new lot to meet minimum fire access requirements • 20x20 access easement on the new lot for the city to facilitate maneuvering of snowplows or other equipment
<input type="checkbox"/>	<input type="checkbox"/>	<input checked="" type="checkbox"/>	16.04.040.I	<p>Alley Improvement Requirements: Alleys shall be provided in business, commercial and light industrial zoning districts. The width of an alley shall be not less than twenty feet (20'). Alley intersections and sharp changes in alignment shall be avoided, but where necessary, corners shall be provided to permit safe vehicular movement. Dead end alleys shall be prohibited. Improvement of alleys shall be done by the subdivider as required improvement and in conformance with design standards specified in subsection H2 of this section.</p>
			<i>Findings</i>	This standard does not apply as the subject property is not within a business, commercial, or light-industrial zone district.
<input checked="" type="checkbox"/>	<input type="checkbox"/>	<input type="checkbox"/>	16.04.040.J	<p>Required Easements: Easements, as set forth in this subsection, shall be required for location of utilities and other public services, to provide adequate pedestrian circulation and access to public waterways and lands.</p> <ol style="list-style-type: none"> 1. A public utility easement at least ten feet (10') in width shall be required within the street right of way boundaries of all private streets. A public utility easement at least five feet (5') in width shall be required within property boundaries adjacent to Warm Springs Road and within any other property boundary as determined by the city engineer to be necessary for the provision of adequate public utilities. 2. Where a subdivision contains or borders on a watercourse, drainageway, channel or stream, an easement shall be required of sufficient width to contain such watercourse and provide access for private maintenance and/or reconstruction of such watercourse. 3. All subdivisions which border the Big Wood River, Trail Creek and Warm Springs Creek shall dedicate a ten foot (10') fish and nature study easement along the riverbank. Furthermore, the council shall require, in appropriate areas, an easement providing access through the subdivision to the bank as a sportsman's access. These easement requirements are minimum standards, and in appropriate cases where a subdivision abuts a portion of the river adjacent to an existing pedestrian easement, the council may require an extension of that

				<p>easement along the portion of the riverbank which runs through the proposed subdivision.</p> <p>4. All subdivisions which border on the Big Wood River, Trail Creek and Warm Springs Creek shall dedicate a twenty five foot (25') scenic easement upon which no permanent structure shall be built in order to protect the natural vegetation and wildlife along the riverbank and to protect structures from damage or loss due to riverbank erosion.</p> <p>5. No ditch, pipe or structure for irrigation water or irrigation wastewater shall be constructed, rerouted or changed in the course of planning for or constructing required improvements within a proposed subdivision unless same has first been approved in writing by the ditch company or property owner holding the water rights. A written copy of such approval shall be filed as part of required improvement construction plans.</p> <p>6. Nonvehicular transportation system easements including pedestrian walkways, bike paths, equestrian paths, and similar easements shall be dedicated by the subdivider to provide an adequate nonvehicular transportation system throughout the city.</p>
			<i>Findings</i>	<p>As shown on Sheet 1 of the preliminary plat, Lot 1 and Lot 2 include a 5-foot snow storage and utility easement. Lot 2 includes a 20x20 foot turnaround access easement for maneuvering of snowplows during the winter months. Both lots include 5-foot utility easements along all property boundaries.</p> <p>Standards 2-6 do not apply to the project as the property is not adjacent to any of the listed waterways, not adjacent to Warm Springs, does not contain any irrigation infrastructure, and does not include pedestrian or equestrian pathways.</p>
<input type="checkbox"/>	<input type="checkbox"/>	<input checked="" type="checkbox"/>	16.04.040.K	<p>Sanitary Sewage Disposal Improvements: Central sanitary sewer systems shall be installed in all subdivisions and connected to the Ketchum sewage treatment system as a required improvement by the subdivider. Construction plans and specifications for central sanitary sewer extension shall be prepared by the subdivider and approved by the city engineer, council and Idaho health department prior to final plat approval. In the event that the sanitary sewage system of a subdivision cannot connect to the existing public sewage system, alternative provisions for sewage disposal in accordance with the requirements of the Idaho department of health and the council may be constructed on a temporary basis until such time as connection to the public sewage system is possible. In considering such alternative provisions, the council may require an increase in the minimum lot size and may impose any other reasonable requirements which it deems necessary to protect public health, safety and welfare.</p>
			<i>Findings</i>	<p>This standard does not apply as this application does not create a new subdivision. Lot 1 is connected to the City of Ketchum sewer system main located in Topaz Street. Lot 2 will be connected to the City of Ketchum sewer system main located in Emerald Street.</p>
<input type="checkbox"/>	<input type="checkbox"/>	<input checked="" type="checkbox"/>	16.04.040.L	<p>Water System Improvements: A central domestic water distribution system shall be installed in all subdivisions by the subdivider as a required improvement. The subdivider shall also be required to locate and install an adequate number of fire hydrants within the proposed subdivision according to specifications and requirements of the city under the supervision of the Ketchum fire department and other regulatory agencies having jurisdiction. Furthermore, the central water system shall have sufficient flow for domestic use and adequate fire flow. All such water systems installed shall be looped extensions, and no dead end systems shall</p>

			<p>be permitted. All water systems shall be connected to the municipal water system and shall meet the standards of the following agencies: Idaho department of public health, Idaho survey and rating bureau, district sanitarian, Idaho state public utilities commission, Idaho department of reclamation, and all requirements of the city.</p>
			<p><i>Findings</i></p> <p>This standard does not apply as this application does not create a new subdivision. Lot 1 is connected to the City of Ketchum water system main located in Topaz Street. Lot 2 will be connected to the City of Ketchum water system main located in Emerald Street.</p>
<input checked="" type="checkbox"/>	<input type="checkbox"/>	<input type="checkbox"/>	<p>16.04.040.M</p> <p>Planting Strip Improvements: Planting strips shall be required improvements. When a predominantly residential subdivision is proposed for land adjoining incompatible uses or features such as highways, railroads, commercial or light industrial districts or off-street parking areas, the subdivider shall provide planting strips to screen the view of such incompatible features. The subdivider shall submit a landscaping plan for such planting strip with the preliminary plat application, and the landscaping shall be a required improvement.</p>
			<p><i>Findings</i></p> <p>As outlined in plat note #8, a 10-foot planting strip applies to Lot 1. The purpose of the planting strip is to limited vehicular access onto Emerald Street with the addition of a driveway for Lot 2.</p>
<input type="checkbox"/>	<input type="checkbox"/>	<input checked="" type="checkbox"/>	<p>16.04.040.N</p> <p>Cuts, Fills, And Grading Improvements: Proposed subdivisions shall be carefully planned to be compatible with natural topography, soil conditions, geology and hydrology of the site, as well as to minimize cuts, fills, alterations of topography, streams, drainage channels, and disruption of soils and vegetation. The design criteria shall include the following:</p> <ol style="list-style-type: none"> 1. A preliminary soil report prepared by a qualified engineer may be required by the commission and/or council as part of the preliminary plat application. 2. Preliminary grading plan prepared by a civil engineer shall be submitted as part of all preliminary plat applications. Such plan shall contain the following information: <ol style="list-style-type: none"> a. Proposed contours at a maximum of five foot (5') contour intervals. b. Cut and fill banks in pad elevations. c. Drainage patterns. d. Areas where trees and/or natural vegetation will be preserved. e. Location of all street and utility improvements including driveways to building envelopes. f. Any other information which may reasonably be required by the administrator, commission or council to adequately review the affect of the proposed improvements. 3. Grading shall be designed to blend with natural landforms and to minimize the necessity of padding or terracing of building sites, excavation for foundations, and minimize the necessity of cuts and fills for streets and driveways. 4. Areas within a subdivision which are not well suited for development because of existing soil conditions, steepness of slope, geology or hydrology shall be allocated for open space for the benefit of future property owners within the subdivision. 5. Where existing soils and vegetation are disrupted by subdivision development, provision shall be made by the subdivider for revegetation of disturbed areas with perennial vegetation sufficient to stabilize the soil upon completion of the construction. Until such times as such revegetation has been installed and established, the subdivider shall maintain and protect all disturbed surfaces from erosion.

				<p>6. Where cuts, fills, or other excavations are necessary, the following development standards shall apply:</p> <p>a. Fill areas shall be prepared by removing all organic material detrimental to proper compaction for soil stability.</p> <p>b. Fills shall be compacted to at least ninety five percent (95%) of maximum density as determined by AASHO T99 (American Association of State Highway Officials) and ASTM D698 (American standard testing methods).</p> <p>c. Cut slopes shall be no steeper than two horizontal to one vertical (2:1). Subsurface drainage shall be provided as necessary for stability.</p> <p>d. Fill slopes shall be no steeper than three horizontal to one vertical (3:1). Neither cut nor fill slopes shall be located on natural slopes of three to one (3:1) or steeper, or where fill slope toes out within twelve feet (12') horizontally of the top and existing or planned cut slope.</p> <p>e. Toes of cut and fill slopes shall be set back from property boundaries a distance of three feet (3'), plus one-fifth (1/5) of the height of the cut or the fill, but may not exceed a horizontal distance of ten feet (10'); tops and toes of cut and fill slopes shall be set back from structures at a distance of at least six feet (6'), plus one-fifth (1/5) of the height of the cut or the fill. Additional setback distances shall be provided as necessary to accommodate drainage features and drainage structures.</p>
			<i>Findings</i>	This standard does not apply as this application is the subdivision of an existing lot. On-site grading for development on Lot 2 must meet all requirements of Title 17 – Zoning Regulations and Title 15 – Buildings and Construction.
<input type="checkbox"/>	<input type="checkbox"/>	<input checked="" type="checkbox"/>	16.04.040.O	<p>Drainage Improvements: The subdivider shall submit with the preliminary plat application such maps, profiles, and other data prepared by an engineer to indicate the proper drainage of the surface water to natural drainage courses or storm drains, existing or proposed. The location and width of the natural drainage courses shall be shown as an easement common to all owners within the subdivision and the city on the preliminary and final plat. All natural drainage courses shall be left undisturbed or be improved in a manner that will increase the operating efficiency of the channel without overloading its capacity. An adequate storm and surface drainage system shall be a required improvement in all subdivisions and shall be installed by the subdivider. Culverts shall be required where all water or drainage courses intersect with streets, driveways or improved public easements and shall extend across and under the entire improved width including shoulders.</p>
			<i>Findings</i>	The subject property is mostly flat, with existing drainage operating adequately to manage surface water on site. Drainage of stormwater from the right-of-way and proposed improvements have been verified by the City Engineer. Prior to start of construction of right-of-way improvements, construction drawings shall be reviewed and approved by the City Engineer as outlined in condition of approval #1.
<input checked="" type="checkbox"/>	<input type="checkbox"/>	<input type="checkbox"/>	16.04.040.P	<p>Utilities: In addition to the terms mentioned in this section, all utilities including, but not limited to, electricity, natural gas, telephone and cable services shall be installed underground as a required improvement by the subdivider. Adequate provision for expansion of such services within the subdivision or to adjacent lands including installation of conduit pipe across and underneath streets shall be installed by the subdivider prior to construction of street improvements.</p>
			<i>Findings</i>	All existing utilities are underground for the existing residential dwelling unit and detached garage. As show on Sheet 1 of the preliminary plat, new utilities will be

				installed underground. Utility locations will be reviewed and verified at the time of building permit application.
<input type="checkbox"/>	<input type="checkbox"/>	<input checked="" type="checkbox"/>	16.04.040.Q	Off Site Improvements: Where the offsite impact of a proposed subdivision is found by the commission or council to create substantial additional traffic, improvements to alleviate that impact may be required of the subdivider prior to final plat approval, including, but not limited to, bridges, intersections, roads, traffic control devices, water mains and facilities, and sewer mains and facilities.
			<i>Findings</i>	The proposed subdivision does not create substantial additional traffic, therefore, no improvements are required.

CONCLUSIONS OF LAW

1. The City of Ketchum is a municipal corporation established in accordance with Article XII of the Constitution of the State of Idaho and Title 50 Idaho Code and is required and has exercised its authority pursuant to the Local Land Use Planning Act codified at Chapter 65 of Title 67 Idaho Code and pursuant to Chapters 3, 9 and 13 of Title 50 Idaho Code to enact the ordinances and regulations, which ordinances are codified in the Ketchum Municipal Code (“KMC”) and are identified in the Findings of Fact and which are herein restated as Conclusions of Law by this reference and which City Ordinances govern the applicant’s Townhouse Preliminary Plat application for the development and use of the project site.
2. The Council has authority to review and recommend approval of the applicant’s Subdivision Preliminary Plat Application pursuant to Chapter 16.04 of Ketchum Code Title 16.
3. The City of Ketchum Planning Department provided notice for the review of this application in accordance with Ketchum Municipal Code §16.04.030.
4. The Subdivision Preliminary Plat application is governed under Chapter 16.04 of Ketchum Municipal Code.
5. The 151 Topaz St Subdivision Preliminary Plat application meets all applicable standards specified in Title 16 of Ketchum Municipal Code.

DECISION

THEREFORE, the City Council **approves** this Preliminary Plat Application File No. P21-034 this Thursday, November 18, 2021, subject to the following conditions of approval.

CONDITIONS OF APPROVAL

1. Prior to construction of required improvements, construction plans for proposed improvements to Emerald Street shall be reviewed and approved by the City Engineer.
2. The Final Plat application shall include a plat note restricting construction of driveway curb cuts on the new lot to the turnaround access easement location as shown on the preliminary plat.
3. All fences located within snow storage easements must either be relocated or removed entirely and verified by a member of the City of Ketchum Planning staff, prior to approval of the Final Plat.
4. The Final Plat application shall not include Plat note 3 provided that all fences have been adequately removed or relocated.

5. All right-of-way improvements shall be completed and accepted by the City of Ketchum City Engineer prior to approval of the Final Plat.
6. Failure to record a Final Plat within two (2) years of Council's approval of a Preliminary Plat shall cause the Preliminary Plat to be null and void.

Findings of Fact **adopted** this 18th day of November 2021.

Neil Bradshaw, Mayor
City of Ketchum