



PLANNING COMMISSION STAFF REPORT

REZONE: AME2024 0001

HEARING DATE: JUNE 25, 2024

(907) 586-0715

CDD_Admin@juneau.gov

www.juneau.org/community-development

155 Heritage Way • Juneau, AK 99801

DATE: June 14, 2024
TO: Mandy Cole, Chair, Planning Commission
BY: Ilsa Lund, Planner I *Ilsa Lund*
THROUGH: Jill Lawhorne, Director, AICP

PROPOSAL: Applicants request a rezone for 1.96 acres from D1(T)D3 to D3.

STAFF RECOMMENDATION: Staff recommends the Planning Commission forward a recommendation of DENIAL to the Assembly.

KEY CONSIDERATIONS FOR REVIEW:

- Transition zones are intended for higher density development after public water and sewer have been provided in accordance with CBJ 49.70.700(a).
- The lots are connected to public water, but not public sewer.
- Installation of public sewer requires approximately 850 ft. of sewer line to reach the lots.
- There is no plan to extend urban services to this area at this time.
- CBJ 49.35.210(b)(3) prohibits direct access onto an arterial from a parcel of land with less than 500 feet of frontage, less than 350 feet in depth, or less than 36,000 in square feet (sq. ft.).

The Commission shall hear and decide the case per CBJ 49.75.120 - Restrictions on rezoning. *Rezoning requests covering less than two acres shall not be considered unless the rezoning constitutes an expansion of an existing zone. Rezoning requests which are substantially the same as a rezoning request rejected within the previous 12 months shall not be considered. A rezoning shall only be approved upon a finding that the proposed zoning district and the uses allowed therein are in substantial conformance with the land use maps of the comprehensive plan.*

ALTERNATIVE ACTIONS:

1. **Amend:** recommend an amended rezone boundary; recommend an alternative zoning district; or recommend conditions.
2. **Deny:** recommend denial of the requested rezone. Planning Commission must make its own findings.
3. **Continue:** continue the hearing to a later date if determined that additional information or analysis is needed to make a decision, or if additional testimony is warranted.

ASSEMBLY ACTION REQUIRED:

Assembly action is required for this rezone.

STANDARD OF REVIEW:

- Quasi-legislative decision
- Requires five (5) affirmative votes for approval
- Code Provisions:
 - CBJ 49.10.170(d)
 - CBJ 49.35.210(b)(3)
 - CBJ 49.70.700
 - CBJ 49.70.720
 - CBJ 49.75.120
 - CBJ 49.80

GENERAL INFORMATION		
Property Owner	Gabriel Christian Dunham; Melissa Sue Edell	David V Klein; Lori A Klein
Applicant	Gabriel & Melissa Dunham	Dave & Lori Klein
Property Address	12400 Glacier Highway	12410 Glacier Highway
Legal Description	USS 687 HAFFNER TRACT	USS 687 FR
Parcel Number	4B2301080010	4B2301080020
Zoning	D1 (T) D3	
Land Use Designation	Rural Low Density Residential	
Lot Size	43,386 sq. ft./ .996 acres	42,253 sq. ft./ .97 acres
Water/Sewer	public water / on-site septic	
Access	Glacier Hwy	
Existing Land Use	Single-family Residential	
Associated Applications	N/A	N/A

SITE FEATURES AND ZONING



SURROUNDING ZONING AND LAND USES	
North D1(T)D3	Vacant
South D3	Glacier Highway ROW
East D10(T)D15	Vacant
West D1(T)D3	American Legion

SITE FEATURES	
Anadromous	No
Flood Zone	No
Hazard	None mapped
Hillside	No
Wetlands	No
Parking District	No
Historic District	No
Overlay Districts	Mining & Exploration Surface Activities Exclusion District, Urban/ Rural Mining District, Recreational Vehicle Park Area

CURRENT ZONING MAP



LAND USE DESIGNATION MAP



BACKGROUND INFORMATION

Project Description – The applicants have requested to rezone two (2) lots totaling 1.96 acres from D1(T)D3 to D3 (Attachment A).

Background – City and Borough of Juneau (CBJ) Land Use Code (Title 49) states that rezoning requests covering less than two (2) acres shall not be considered unless the rezoning constitutes an expansion of an existing zone (CBJ 49.75.120). The two (2) lots combined do not meet the size threshold for rezoning; however, the lots are directly adjacent to a D3 zoning district on the southeast lot lines across Glacier Highway.

Being in a transitional zoning district, the lots would automatically be upgraded to the higher density classification at the time public water and / or public sewer are provided in accordance with CBJ 49.70.700(a). This was part of the 1987 Title 49 overhaul adopted through Ordinance 87-49 (Attachment B). Both lots have public water with privately maintained septic systems. The CBJ sewer line terminates at 12275 Glacier Highway and requires approximately 850 ft of sewer line—crossing an anadromous stream— and a pump station to be installed. At this time, CBJ Engineering & Public Works (E&PW), has indicated that there is no intent to extend the sewer line past the current terminus (Attachment C).

Both lots are directly adjacent to a large tract of land (~113 acres) owned by Duran Construction Company, LLC. In order to develop the land, the developer will need to install public sewer. E&PW commented that CBJ has committed to provide a trestle for conveying the sewer (wastewater) line across an anadromous stream (Waydelich Creek), but would have no other involvement in the utility extension (Attachment C). At this time, no applications have been submitted to initiate this development and therefore this application would not qualify for a zoning upgrade per CBJ 49.70.720(1)(A).

Permit and Lot

History - The below table summarizes relevant history for the lots and proposed development.

Item	Summary
Building permits	1990- Project # 5330.01- New ¾” residential waterline connected to City water (12400).
	2000- ULT2000-00051- New ¾” residential waterline connected to City water (12410).
Land use cases	1974- SUB-W74-385- HAFFNER TRACT was created through platting waiver. (Attachment D)
	1999- VAR99-00035-Approved Variance to reduce 15 ft. required side yard setback to 13.8 ft. to maintain use of existing foundation for modular home replacement (12400).
Plat Notes	N/A
Case Law	N/A
Nonconforming certifications	N/A

Zoning History – The below table summarizes zoning history for the lots.

Year	Zoning	Summary
1969	R12	Zoned R12 with no previous zoning.
1987	D1(T)D3	Rezoned D1(T)D3 from R12 with comprehensive rezoning ordinance. CBJ 49.70.700(a) states that the increase in density will take place at the time public services are provided. The Assembly adopted the rezone of these lots from D1 (T) D3 upon installation of sewer, which has not yet been provided.

ZONING ANALYSIS

CBJ 29.25.200 Zoning Districts Defined -

Current Zoning – D1	Zoning Upgrade – D3
<p><i>The D-1, residential district, is intended to accommodate primarily single-family and duplex residential development in areas outside the urban service boundary at a density of one dwelling unit per acre. Certain D-1 zoned lands, however, may exist within the urban service boundary in transition areas if public sewer or water are absent but planned for. The D-1 classification will be changed to a higher density upon provision of services.</i></p>	<p><i>The D-3, residential district, is intended to accommodate primarily single-family and duplex residential development at a density of three dwelling units per acre. D-3 zoned lands are primarily located outside the urban service boundary where public utilities are not provided. The density reflects the existing pattern of development of properties in the district. There is a limited amount of D-3 zoned lands located within the urban service boundary. These are lands for which a lower density is deemed appropriate or, in the case of transition zones, where the zoning will be changed to a higher density when sewer and water are provided.</i></p>

CBJ 49.25.300 Table of Permissible Uses Comparison – Below is a sample of uses and respective permitting for D1 and D3 zoning districts. Please refer to the Table of Permissible Uses (49.25.300) for a complete list.

No.	Use Description	Current Zoning	Proposed Zoning
1.110	Single-family detached, one (1) dwelling per lot	Department (Dept.)	Dept.
1.120	Single-family detached, two (2) dwellings per lot	Dept.	Dept.
1.130	Single-family detached, accessory apartment	Dept./ Conditional Use Permit (CUP)	Dept./ CUP
1.140	Single-family detached, two dwellings per lot, accessory apartment	Dept./ CUP	Dept./ CUP
1.200	Duplex	Dept.	Dept.
1.300	Multifamily dwellings	Not permissible	Not permissible
3.050	Offices of not more than 1,000 square feet	CUP	CUP

10.210	All storage within completely enclosed structures	CUP	Not permissible
10.220	General storage inside or outside enclosed structures	CUP	Not permissible
18.100 ^{AA}	Towers and antennas 35 feet or less	Dept.	Dept.
18.200 ^{AA}	Towers and antennas 35 to 50 feet	Cup	CUP
18.300 ^{AA}	Towers and antennas more than 50 feet in height	CUP	CUP

CBJ 49.25.400 Dimensional Standards –

Standard		Current Zoning	Proposed Zoning
Lot	Size	36,000 sq. ft.	12,000 sq. ft.
	Width	150 ft.	100 ft.
Setbacks	Front	25 ft.	25 ft.
	Rear	25 ft.	25 ft.
	Side	15 ft.	10 ft. ^{1,2}
	Street Side	17 ft.	17 ft.
Lot Coverage		10%	35%
Height	Permissible	35 ft.	35 ft.
	Accessory	25 ft.	25 ft.

1. USS 687 FR would still be required to have a 15 ft. side yard setback on the western lot line because it would be adjacent to a D1(T)D3 zoning district in accordance with CBJ 49.25.400 Note No. 3.
2. The HAFFNER TRACT would become conforming for the east lot line side yard setback.

CBJ 49.25.500 Density –

	Current Zoning (1 DU/Acre)	Proposed Zoning (3 DU/Acre)
Maximum Number of Dwelling Units	D1 allows for one (1) primary dwelling unit and one (1) accessory apartment per acre.	D3 allows for three (3) dwelling units per acre. With a minimum lot size of 12,000 sq. ft*.

Potential for Subdivision – Because the minimum lot size for D1 is 36,000 sq. ft. these lots do not meet the minimum standards to subdivide. Subdivision would become a possibility under the 12,000 sq. ft. minimum lot size requirement for D3; however, in 2015, access code was amended to prohibit a parcel of land on an arterial with less than 500 feet of frontage on a street, less than 350 feet in depth, or less than 36,000 in sq ft from having direct access onto the arterial (Attachment E). *Since both of these lots have direct access onto an arterial roadway (Glacier Highway), subdivision is not permissible. (CBJ 49.35.250)

TRAFFIC AND TRANSPORTATION

A rezone of this size is not anticipated to significantly impact or increase traffic.

Level of Service	General Operating Conditions
A	Free flow, with low volumes and high speeds.
B	Reasonably free flow, but speeds beginning to be restricted by traffic conditions.
C	Stable flow, but most drivers are restricted in the freedom to select their own speeds.
D	Approaching unstable flow; drivers have little freedom to select their own speeds.
E	Unstable flow; may be short stoppages.
F	Forced or breakdown flow; unacceptable congestion; stop-and-go.

Table 1: Level of Service General Definitions

Source: Adapted from the AASHTO Green Book and Flexibility in Highway Design

Access	Roadway Classification	Current Level of Service
Glacier Highway	Major Arterial	B

Non-motorized transportation – There are no sidewalks along this stretch of Glacier Highway. Currently there are wide asphalt shoulders directly in front of the properties that serve as de facto bicycle lanes. At this time, the Alaska Department of Transportation (DOT) [Southcoast Region Projects webpage](#) does not include any improvements to this section of Glacier Highway.

Proximity to Public Transportation – The nearest bus route runs through the Auke Bay roundabout seven tenths (0.7) of a mile east of the properties. The nearest bus stop is .87 of a mile away.

COMMUNITY SERVICES

The table below summarizes community services that may be affected by the proposed rezone.

Service	Summary
Water/Sewer	Sewer line must be installed.
Fire Service	No significant impact.
Schools	No significant impact.
Recreation	No significant impact.

ENVIRONMENTAL, CONSERVATION, HISTORIC, AND ARCHEOLOGICAL RESOURCES

The table below summarizes Conservation, Historic, and Archeological Resources which may be affected by the proposed rezone.

Resource	Summary
Conservation	No significant impact.
Wetlands	No significant impact.
Anadromous	Waydelich Creek is an anadromous stream which will need to be crossed in order to provide public sewer to the properties.
Historic	No significant impact.
Archeological	No significant impact.

CONFORMITY WITH ADOPTED PLANS

2013 COMPREHENSIVE PLAN VISION: *The City and Borough of Juneau is a vibrant State Capital that values the diversity and quality of its natural and built environments, creates a safe and satisfying quality of life for its diverse population, provides quality education and employment for its workers, encourages resident participation in community decisions and provides an environment to foster state-wide leadership.*

2013 COMPREHENSIVE PLAN - The proposed text amendment does not comply with the 2013 Comprehensive Plan.

Chapter	Page No.	Item	Summary
3	15	Transition Area definition	Transition Area: These lands are located within the Urban Service Area and are not yet provided public sewer service. When provided with sewer service, and when roadway and intersections serving these lands have adequate capacities to accommodate new development (such that post-development, the road and intersection Levels of Service would not be worse than LOS D), transition areas should be rezoned for the designated higher density residential development. Transition areas are designated as the intended higher density on the Comprehensive Plan land use maps, but rezoning these areas to match the land use designation must wait until public sewer service is extended to them. (emphasis added)
7	92	Policy 7.11	The proposed text amendment is in conflict with Policy 7.11 with development of wastewater utilities having to cross Waydelich Creek, an anadromous stream. <i>Policy 7.11. TO PRESERVE AND PROTECT A DIVERSITY OF FISH AND WILDLIFE HABITAT THROUGHOUT THE CBJ.</i>
11	155	Land Use Designation	Map 11.6- The two parcels and surrounding area are designated Rural Low Density Residential. Changing the zoning to D3 would not affect this designation.
11	177	Subarea	Subarea 3- This section states that higher density development will be

2013 COMPREHENSIVE PLAN - The proposed text amendment does not comply with the 2013 Comprehensive Plan.	
Guidelines	considered once public sewer is available.

2015 AUKE BAY AREA PLAN - The proposed text amendment does not comply with the 2015 Auke Bay Area Plan			
Chapter	Page No.	Item	Summary
2	20	Goal 1	The proposed text amendment is not in compliance with Chapter 2, Goal 1 because allowing public utilities development across an anadromous stream could affect critical salmon habitat.

AGENCY REVIEW

CDD conducted an agency review comment period between April 30, 2024, and June 3, 2024. Agency review comments can be found in Attachments B and F.

Agency	Summary
AK DOT	DOT permitting would likely be the least cumbersome aspect of the public utilities extension.
CBJ Engineering	CBJ does not plan to extend the utilities past the current terminus.

PUBLIC COMMENTS

CDD conducted a public comment period between May 28, 2024, and June 6, 2024. Public notice was mailed to property owners within 500 feet of the proposed rezone. A public notice sign was also posted on-site two weeks prior to the scheduled hearing. Written public comments submitted at time of writing this staff report can be found in Attachment G.

Name	Summary
Warren and Joyce Van Sickle	Not opposed to the proposal. (phone/ verbal)
Linda Bleggen	Opposed- Requesting denial.
Karol Kriens	Opposed to possible density increase for safety/traffic reasons on Glacier Highway. (phone/verbal)
Karol Kriens	Opposed- More infrastructure needed.
Craig Dahl	Not opposed to the proposal. (phone/ verbal)

ZONE CHANGE OPTIONS AND ALTERNATIVES

As stated in CBJ 49.75.130(a), the Commission may recommend approval, approval with modifications or denial of a rezone request. The Commission may recommend approval to the Assembly for different zoning districts than what is requested by the applicant or recommended by staff. Additionally, the Commission can recommend modifications to the boundaries of the area to be rezoned. This means that if the Commission wishes to do so, the zoning district boundary line may be moved from its current location, as long as it is found

to be in substantial conformance with the Comprehensive Plan and Title 49 – Land Use Code. Zoning district boundary lines are intended to follow property lines, centerlines of streets, alleys, streams (CBJ 49.25.110(f)).

Staffs analysis does not include an alternative zoning district as to the applicant’s request. Staff reviewed the applicant’s proposed zoning.

FINDINGS

In accordance with CBJ 49.75 the Director makes the following findings on the proposed rezone:

1. *Was the rezone application filed timely in accordance with CBJ 49.75.110?*

Analysis: No additional analysis required.

Finding: **Yes.** The rezone application was filed on January 30, 2024.

2. *Was adequate public notice provided in accordance with CBJ 49.75.110?*

Analysis: CDD staff mailed written notice to property owners within 500 feet of the proposed rezone; and a public notice sign was posted on the site two weeks prior to the scheduled hearing (Attachment H).

Finding: **Yes.** Adequate public notice was provided in accordance with CBJ 49.75.110.

3. *Is this request for an area covering more than two acres or an expansion of an existing zoning district as required by CBJ 49.75.120?*

Analysis: The rezone request is for 1.96 acres. The nearest D3 zoning district is across Glacier Highway, due South.

Finding: **Yes.** The proposed rezone is an extension of an existing zoning district.

4. *Has no similar request been made within the previous 12 months as required by CBJ 49.75.120?*

Analysis: No additional analysis required.

Finding: **Yes.** No similar rezone request has been filed within the previous 12 months.

5. *Is the proposed zoning district and the uses allowed therein found to be in substantial conformance with the land use maps of the comprehensive plan and policies of the comprehensive plan, in accordance with CBJ 49.75.120?*

Analysis: Changing the zoning from D1(T)D3 to D3 would not substantially change the land use and would conform to the Rural Low Density Residential designation. However, the comprehensive plan clearly explains that transition zones will be automatically upgraded once public utilities are in place, providing capacity for higher density.

Finding: No. The proposed rezone is not in substantial conformance with the land use maps and policies of the comprehensive plan.

6. *Is the proposed zoning district and the uses allowed therein found to be in substantial conformance with Title 49 – Land Use Code, in accordance with CBJ 49.75.120?*

Analysis: CBJ 49.35.210(b)(3) prohibits subdivision of lots on an arterial from being less than 36,000 sq. ft. Additionally, CBJ 49.70.700(a) states that the increase in density will take place at the time public services are provided. The Assembly adopted the rezone of these lots from D1 (T) D3 upon installation of sewer, which has not yet been provided.

Finding: No. The proposed rezone is not in substantial conformance with Title 49 – Land Use Code.

RECOMMENDATION

Staff recommends the Planning Commission adopt the Director's analysis and findings and forward a recommendation of DENIAL to the Assembly for the requested rezone application of 1.96 acres from D1(T)D3 to D3 near Auke Bay.

STAFF REPORT ATTACHMENTS

Item	Description
Attachment A	Application Packet
Attachment B	Excerpts regarding transitional zoning districts from 1987 Ordinance 87-49
Attachment C	Map of Rezone Area & Documents from CBJ E&PW
Attachment D	Plat 74-38W
Attachment E	Excerpt from Ordinance 2015-03(c)(am)(2)
Attachment F	Agency Comments (DOT)
Attachment G	Public Comments
Attachment H	Abutters Notice and Public Notice Sign Photo
Attachment I	2013 Waydelich Sewer Extension Feasibility Study



DEVELOPMENT PERMIT APPLICATION

NOTE: Development Permit Application forms must accompany all other Community Development Department land use applications. This form and all documents associated with it are public record once submitted.

To be completed by Applicant	PROPERTY LOCATION									
	Physical Address 12400 Glacier Hwy									
	Legal Description(s) (Subdivision, Survey, Block, Tract, Lot) USS 687 HAFFNER TRACT									
	Parcel Number(s) 4B2301080010									
	<input type="checkbox"/> This property is located in the downtown historic district <input type="checkbox"/> This property is located in a mapped hazard area, if so, which _____									
	LANDOWNER/ LESSEE									
	Property Owner	Gabriel C Dunham, Melissa SE Dunham	Contact Person Gabe Dunham							
	Mailing Address	12400 Glacier Hwy	Phone Number(s) 9078304487							
	E-mail Address	gabedunham@gmail.com								
	LANDOWNER/ LESSEE CONSENT									
Required for Planning Permits, not needed on Building/ Engineering Permits. Consent is required of all landowners/ lessees. If submitted with the application, alternative written approval may be sufficient. Written approval must include the property location, landowner/ lessee's printed name, signature, and the applicant's name.										
I am (we are) the owner(s) or lessee(s) of the property subject to this application and I (we) consent as follows: A. This application for a land use or activity review for development on my (our) property is made with my complete understanding and permission. B. I (we) grant permission for the City and Borough of Juneau officials/employees to inspect my property as needed for purposes of this application.										
<table style="width:100%; border:none;"> <tr> <td style="width:50%; text-align:center;"><u>Gabe Dunham</u> Landowner/Lessee (Printed Name)</td> <td style="width:50%; text-align:center;"><u>Landowner</u> Title (e.g.: Landowner, Lessee)</td> </tr> <tr> <td style="text-align:center;">x <u></u> Landowner/Lessee (Signature)</td> <td style="text-align:center;"><u>7/31/23</u> Date</td> </tr> <tr> <td style="text-align:center;"><u>Melissa Dunham</u> Landowner/Lessee (Printed Name)</td> <td style="text-align:center;"><u>Landowner</u> Title (e.g.: Landowner, Lessee)</td> </tr> <tr> <td style="text-align:center;">x <u></u> Landowner/Lessee (Signature)</td> <td style="text-align:center;"><u>7/31/23</u> Date</td> </tr> </table>			<u>Gabe Dunham</u> Landowner/Lessee (Printed Name)	<u>Landowner</u> Title (e.g.: Landowner, Lessee)	x <u></u> Landowner/Lessee (Signature)	<u>7/31/23</u> Date	<u>Melissa Dunham</u> Landowner/Lessee (Printed Name)	<u>Landowner</u> Title (e.g.: Landowner, Lessee)	x <u></u> Landowner/Lessee (Signature)	<u>7/31/23</u> Date
<u>Gabe Dunham</u> Landowner/Lessee (Printed Name)	<u>Landowner</u> Title (e.g.: Landowner, Lessee)									
x <u></u> Landowner/Lessee (Signature)	<u>7/31/23</u> Date									
<u>Melissa Dunham</u> Landowner/Lessee (Printed Name)	<u>Landowner</u> Title (e.g.: Landowner, Lessee)									
x <u></u> Landowner/Lessee (Signature)	<u>7/31/23</u> Date									
NOTICE: The City and Borough of Juneau staff may need access to the subject property during regular business hours. We will make every effort to contact you in advance, but may need to access the property in your absence and in accordance with the consent above. Also, members of the Planning Commission may visit the property before a scheduled public hearing date.										
APPLICANT										
If same as LANDOWNER, write "SAME"										
Applicant (Printed Name)	SAME									
Mailing Address										
E-mail Address										
X <u></u> Applicant's Signature		<u>7/31/23</u> Date of Application								

DEPARTMENT USE ONLY BELOW THIS LINE

INCOMPLETE APPLICATIONS WILL NOT BE ACCEPTED

For assistance filling out this form, contact the Permit Center at 586-0770.

Intake Initials JPM	
Case Number AME24-001	Date Received 1/30/24



DEVELOPMENT PERMIT APPLICATION

NOTE: Development Permit Application forms must accompany all other Community Development Department land use applications. This form and all documents associated with it are public record once submitted.

To be completed by Applicant	PROPERTY LOCATION																		
	Physical Address 12410 Glacier Hwy																		
	Legal Description(s) (Subdivision, Survey, Block, Tract, Lot) USS 687 FR																		
	Parcel Number(s) 4B2301080020																		
	<input type="checkbox"/> This property is located in the downtown historic district <input type="checkbox"/> This property is located in a mapped hazard area, if so, which _____																		
	LANDOWNER/ LESSEE																		
	Property Owner DAVID V KLEIN & LORI A KLEIN	Contact Person Dave Klein																	
	Mailing Address PO BOX 211551, AUKE BAY AK 99821	Phone Number(s) 9075008461																	
	E-mail Address dave@alaskafamily.net																		
	LANDOWNER/ LESSEE CONSENT																		
Required for Planning Permits, not needed on Building/ Engineering Permits. Consent is required of all landowners/ lessees. If submitted with the application, alternative written approval may be sufficient. Written approval must include the property location, landowner/ lessee's printed name, signature, and the applicant's name.																			
I am (we are) the owner(s) or lessee(s) of the property subject to this application and I (we) consent as follows: A. This application for a land use or activity review for development on my (our) property is made with my complete understanding and permission. B. I (we) grant permission for the City and Borough of Juneau officials/employees to inspect my property as needed for purposes of this application.																			
<table style="width:100%; border:none;"> <tr> <td style="width:50%; text-align:center;">Dave Klein</td> <td style="width:50%; text-align:center;">Landowner</td> </tr> <tr> <td style="border-top: 1px solid black; text-align:center;">Landowner/Lessee (Printed Name)</td> <td style="border-top: 1px solid black; text-align:center;">Title (e.g.: Landowner, Lessee)</td> </tr> <tr> <td style="border-top: 1px solid black; text-align:center;"></td> <td style="border-top: 1px solid black; text-align:center;">7/31/23</td> </tr> <tr> <td style="border-top: 1px solid black; text-align:center;">Landowner/Lessee (Signature)</td> <td style="border-top: 1px solid black; text-align:center;">Date</td> </tr> <tr> <td colspan="2"> </td> </tr> <tr> <td style="text-align:center;">Lori Klein</td> <td style="text-align:center;">Landowner</td> </tr> <tr> <td style="border-top: 1px solid black; text-align:center;">Landowner/Lessee (Printed Name)</td> <td style="border-top: 1px solid black; text-align:center;">Title (e.g.: Landowner, Lessee)</td> </tr> <tr> <td style="border-top: 1px solid black; text-align:center;"></td> <td style="border-top: 1px solid black; text-align:center;">7/31/23</td> </tr> <tr> <td style="border-top: 1px solid black; text-align:center;">Landowner/Lessee (Signature)</td> <td style="border-top: 1px solid black; text-align:center;">Date</td> </tr> </table>		Dave Klein	Landowner	Landowner/Lessee (Printed Name)	Title (e.g.: Landowner, Lessee)		7/31/23	Landowner/Lessee (Signature)	Date			Lori Klein	Landowner	Landowner/Lessee (Printed Name)	Title (e.g.: Landowner, Lessee)		7/31/23	Landowner/Lessee (Signature)	Date
Dave Klein	Landowner																		
Landowner/Lessee (Printed Name)	Title (e.g.: Landowner, Lessee)																		
	7/31/23																		
Landowner/Lessee (Signature)	Date																		
Lori Klein	Landowner																		
Landowner/Lessee (Printed Name)	Title (e.g.: Landowner, Lessee)																		
	7/31/23																		
Landowner/Lessee (Signature)	Date																		
NOTICE: The City and Borough of Juneau staff may need access to the subject property during regular business hours. We will make every effort to contact you in advance, but may need to access the property in your absence and in accordance with the consent above. Also, members of the Planning Commission may visit the property before a scheduled public hearing date.																			
APPLICANT If same as LANDOWNER, write "SAME"																			
Applicant (Printed Name) SAME	Contact Person																		
Mailing Address	Phone Number(s)																		
E-mail Address																			
	7/31/23																		
Applicant's Signature	Date of Application																		

-----DEPARTMENT USE ONLY BELOW THIS LINE-----

INCOMPLETE APPLICATIONS WILL NOT BE ACCEPTED

For assistance filling out this form, contact the Permit Center at 586-0770.

Case Number AME 24-001	Intake Initials JAM,
Date Received 1/30/24	



ZONE CHANGE APPLICATION

See reverse side for more information regarding the permitting process and the materials required for a complete application.

NOTE: Must be accompanied by a DEVELOPMENT PERMIT APPLICATION form.

To be completed by Applicant

PROJECT SUMMARY
 This zone change application submitted for properties located at 12400 and 12410 Glacier Highway to change both properties from the existing D1 zoning designation to D3 zoning designation

IS THIS AN EXPANSION OF AN EXISTING ZONE? Yes No

Total Land Area of Proposed Change 1.96 acres Comprehensive Plan Land Use Designation Rural Low Density Residential

Current Zone(s) D1 Comprehensive Plan Map Letter F

New Zone Requested D3

TYPE OF ZONE CHANGE REQUESTED Regular Transition

Has this or a similar zone change been requested in the previous 12 months? Yes Case # _____ No

UTILITIES AVAILABLE WATER: Public On Site SEWER: Public On Site

ALL REQUIRED MATERIALS ATTACHED

- Complete application
- Pre-Application Conference notes
- Narrative including:
 - Purpose of the requested zone change
 - Any potential impacts to public infrastructure (streets, water, & sewer)
 - How the requested zone change comply with the maps and policies of the Comprehensive Plan
- Site Plan and/or map of proposed zone change (details on reverse side)

-----DEPARTMENT USE ONLY BELOW THIS LINE-----

ZONE CHANGE FEES	Fees	Check No.	Receipt	Date
Application Fees	\$ <u>600.00</u>			
Admin. of Guarantee	\$ _____			
Adjustment	\$ _____			
Pub. Not. Sign Fee	\$ <u>50.00</u>			
Pub. Not. Sign Deposit	\$ <u>100.00</u>			
Total Fee	\$ <u>750.00</u>			

This form and all documents associated with it are public record once submitted.

INCOMPLETE APPLICATIONS WILL NOT BE ACCEPTED

For assistance filling out this form, contact the Permit Center at 586-0770.

Case Number	Date Received
<u>AME24-001</u>	<u>1/30/24</u>

Zone Change Application Information

Zone changes are outlined in CBJ 49.75 article I

Pre-Application Conference: A pre-application conference is encouraged prior to submitting an application. The applicant shall meet with City & Borough of Juneau (CBJ) staff to discuss the Zone Change process and analysis. To schedule a pre-application conference, please contact the Permit Center at 586-0770 or via email at Permits@juneau.org.

Application: An application for a Zone Change will not be accepted by the CBJ until it is determined to be complete. **Zone Change may only be applied for during January and July.** The items needed for a complete application are:

1. **Forms:** Completed Zone Change Application and Development Permit Application.
2. **Fees:** The fee for Zone Change Application is \$600.00. No work can be approved with a Zone Change. All fees are subject to change.
3. **Project Narrative:** A detailed narrative describing the purpose for the requested zone change.
4. **Plans:** A site plan showing the following information:
 - A. The boundaries of the existing and proposed zone change and proposed buffers;
 - B. The location of existing structures (i.e. buildings, fences, signs, parking areas, etc.); and
 - C. The location of existing physical features of the site (i.e. drainage, topography, eagle trees, hazard areas, salmon streams, wetlands, etc.).
5. A traffic study may be required for zone changes.

Document Format: All materials submitted as part of an application shall be submitted in either of the following formats:

1. Electronic copies in the following formats: .doc, .txt, .xls, .bmp, .pdf, .jpg, .gif, .xlm, .rtf (other formats may be preapproved by the Community Development Department).
2. Paper copies 11" X 17" or smaller (larger paper size may be preapproved by the Community Development Department).

Application Review & Hearing Procedure: Once the application is determined to be complete, the Community Development Department will initiate the review and scheduling of the application. This process includes:

Review: The Community Development Department will evaluate the application for consistency with all applicable City & Borough of Juneau codes and adopted plans. Depending on unique characteristics of the Zone Change request, the application may be required to be reviewed by other municipal boards and committees. During this review period, the Community Development Department will coordinate the review of this application by other agencies, as necessary. **Review comments may require the applicant to provide additional information, clarification, or submit modifications/alterations for the proposed Zone Change.**

Hearing: Once an application has been reviewed by all applicable parties the Community Development Department will schedule the zone change for the next appropriate Planning Commission meeting. All Zone Change Applications will be reviewed by the Planning Commission who will send a recommendation to the Assembly. Following a recommendation of approval by the Planning Commission, the Community Development Department will coordinate the zone change review by the Assembly. In order for zone changes to become effective, they must be adopted by ordinance by the CBJ Assembly.

Public Notice Responsibilities: All Zone Change requests must be given the following public notice as outlined in CBJ 49.15.230:

Community Development Department: Will give notice of the pending Planning Commission meeting and its agenda in the local newspaper a minimum of 10-days prior to the meeting. Furthermore, the department will mail notices to all property owners within 500-feet of the project site.

The Applicant will post a sign on the site at least 14 days prior to the meeting. The sign shall be visible from a public right-of-way or where determined appropriate by CDD. Signs may be produced by the Community Development Department for a preparation fee of \$50, and a \$100 deposit that will be refunded in full if the sign is returned within seven days of the scheduled hearing date. If the sign is returned between eight and 14 days of the scheduled hearing \$50 may be refunded. The Applicant may make and erect their own sign. Please contact the Community Development Department for more information.

INCOMPLETE APPLICATIONS WILL NOT BE ACCEPTED

12400/12410 Zone Change Application Narrative

The purpose of the zone change application submitted for properties located at 12400 and 12410 Glacier Highway is to change both properties from the existing D1 zoning designation to D3 zoning designation. Together these properties meet the 2-acre minimum size for rezoning. Further, neighboring properties range in zoning designations from D1 to D10, with adjacent properties holding D3 designations with similar lot sizes and provision of public services. The requested zone change will improve flexibility of use of the affected properties and allow the owners to more efficiently utilize the space through the higher density designation.

Impacts of this zone change to public infrastructure will be limited to any future permitted use stemming from the increased density of the properties; including additional water service and driveways to access glacier highway, per allowable D3 zoning density of up to 3 dwellings per acre. Sewer service is not offered in this location, and will be limited to on-site treatment, per AK DEC regulations for on-site treatment systems.

The requested zone change complies with several policies of the Comprehensive Plan, and is consistent with the land use category provided for the subarea.

1. POLICY 10.2. TO ALLOW FLEXIBILITY AND A WIDE RANGE OF CREATIVE SOLUTIONS IN RESIDENTIAL AND MIXED USE LAND DEVELOPMENT WITHIN THE URBAN SERVICE AREA.
2. POLICY 10.3. TO FACILITATE RESIDENTIAL DEVELOPMENTS OF VARIOUS TYPES AND DENSITIES THAT ARE APPROPRIATELY LOCATED IN RELATION TO SITE CONDITIONS, SURROUNDING LAND USES, AND CAPACITY OF PUBLIC FACILITIES AND TRANSPORTATION SYSTEMS.

12400 and 12410 are located in the Urban Service area and are designated Rural Low Density Residential, indicated in the land use maps in chapter 11 of the Comprehensive Plan for subarea 3: Auke Bay, Mendenhall Peninsula, West Mendenhall Valley.

The Comprehensive Plan provides the following description of the RLDR land use category: *Rural residential land at densities of one to three dwelling units per acre, based on existing platting and capability of the land to accommodate on-site septic systems and wells or whether the land is served by municipal water and sewer service.* Rezoning 12400 and 12410 from D1 to D3 would allow an increase in density from 1 to 3 dwellings per acre, consistent with the RLDR land use category.

In summary, rezoning the properties located at 12400 and 12410 Glacier highway from D1 to D3 designation provides flexibility for the property owners to appropriately increase the number of dwellings on their lots, aligns with several policies and the applicable land use category found in the Comprehensive Plan, and would be consistent with neighboring properties in the same subarea.

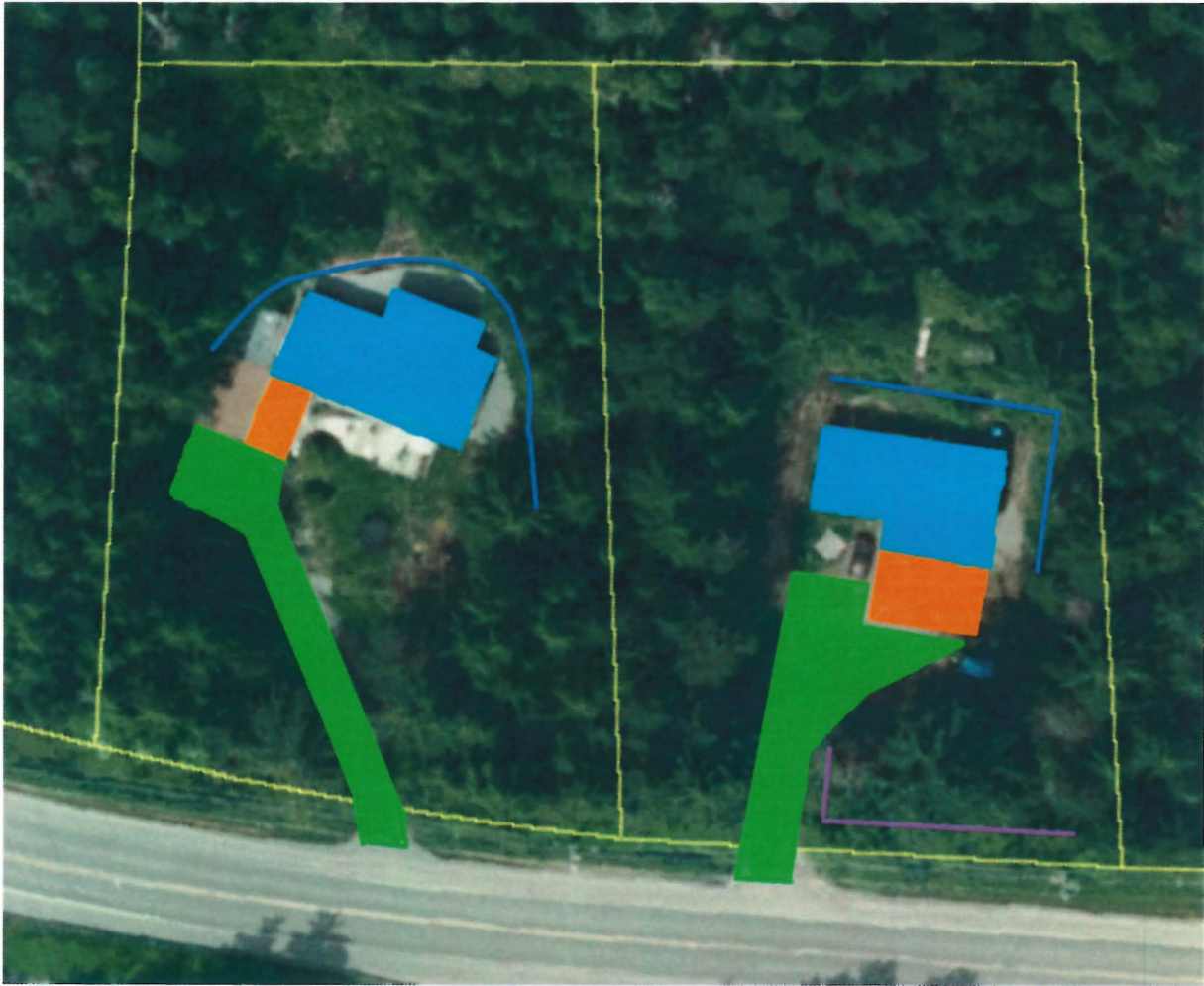

Property lines		Parking		Fence	
Dwelling		Driveway		Drainage	

Attachment A - Application Packet



(907) 586-0715
 CDD_Admin@juneau.org
 www.juneau.org/community-development
 155 S. Seward Street • Juneau, AK 99801

Glacier Hwy Rezone

Case Number: PAC2023 0029
 Applicant: Dunham/Edell/Klein
 Property Owner: Gabriel Dunham & Melissa Edell; David & Lori Klein
 Property Address: 12400 & 12410 Glacier Highway, Juneau, AK. 99801
 Parcel Code Number: 4B2301080010; 4B2301080020
 Site Size: 43,386sqft/1.00ac ; 42,253sqft/.97ac
 Zoning: D1(T)D3
 Existing Land Use: Residential

Conference Date: June 20, 2023

Report Issued: June 28, 2023

DISCLAIMER: Pre-application conferences are conducted for the purpose of providing applicants with a preliminary review of a project and timeline. Pre-application conferences are not based on a complete application and are not a guarantee of final project approval.

List of Attendees

Note: Copies of the Pre-Application Conference Report will be emailed, instead of mailed, to participants who have provided their email address below.

Name	Title	Email address
Gabe Dunham	Applicant	GabeDunham@gmail.com
Dave Klein	Applicant	Dave@Alaskafamily.net
David Peterson	Planning	David.Peterson@juneau.gov
Sydney Hawkins	Permit Tech	Sydney.Hawkins@juneau.gov

Revised 5/07/2021

i:\documents\cases\2023\pac\pac23-029 glacier hwy rezone\pac23-029 final.doc

Conference Summary

Questions/issues/agreements identified at the conference that weren't identified in the attached reports. The following is a list of issues, comments and proposed actions, and requested technical submittal items that were discussed at the pre-application conference.

The Applicant is interested in the increased density allowed under D3. Note that it is based on lot size. The rezone works in their favor if they are interested in subdividing, building a duplex, or building two single-family homes on their lot. See "Subdivision" below.



Property lines	Parking	Fence
Dwelling	Driveway	Drainage

Project Overview

The applicant is seeking a zone change for properties located at 12400 and 12410 Glacier Highway. Both properties are located in a D1 transition to D3 zone. Adjacent properties to the Southeast across Glacier Highway are zoned D3.

- Together these properties are less than the 2-acre minimum size for rezoning at (42,253sf + 43,386sf = 85,639sf/1.96 acres). (1,481sf short)
- 49.70.720(2)(a) – The Commission shall base its decision to grant the upgrade on the determination of the feasibility of providing public water, sewer, and other required improvements. Sewer has not been extended to the property.

The process would be:

- Apply for the rezone in January.
- Work with Community Development on organizing a public meeting. Community Development would present on the regulatory details, and the Applicant would be able to present based on the vision for the area.
- Modify the proposal as warranted by public comments.
- Present the proposal to the Planning Commission. They will forward to the Assembly, and:
 - Recommend approval, OR
 - Recommend approval with conditions, OR
 - Recommend denial, OR
 - If they need more information, they will “continue.”
- The Assembly will most likely consider the rezone:
 - At a subcommittee, probably Lands, Housing and Economic Development.
 - At a Committee of the Whole (work group), then
 - At a regular Assembly Meeting, where the rezone will be voted on.

Planning Division

1. **Zoning** – A rezone must conform to the 2013 Comprehensive Plan land use maps. On Map F (Submitted with this application) this area is Rural Low Density Residential (RLDR). The Comprehensive Plan defines RLDR as: *Rural residential land at densities of one to three dwelling units per acre, based on existing platting and capability of the land to accommodate on-site septic systems and wells or whether the land is served by municipal water and sewer service.*

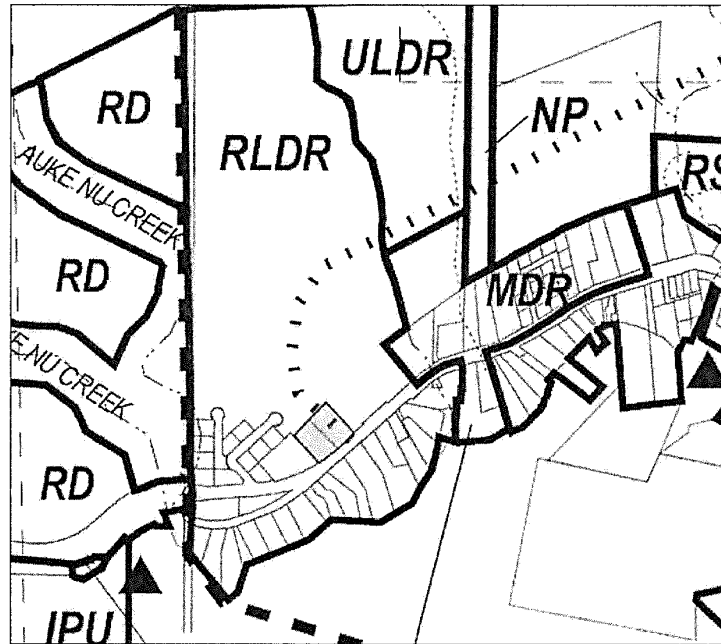

CBJ 49.25.210 outlines the densities of D1 and D3:

The D-1, residential district, is intended to accommodate primarily single-family and duplex residential development in areas outside the urban service boundary at a density of one dwelling unit per acre. Certain D-1 zoned lands, however, may exist within the urban service boundary in transition areas if public sewer or water are absent but planned for. The D-1 classification will be changed to a higher density upon provision of services.

The D-3, residential district, is intended to accommodate primarily single-family and duplex residential development at a density of three dwelling units per acre. D-3 zoned lands are primarily located outside the urban service boundary where public utilities are not provided. The density reflects the existing pattern of development of properties in the district. There is a limited amount of D-3 zoned lands located within the urban service boundary. These are lands for which a lower density is deemed appropriate or, in the case of transition zones, where the zoning will be changed to a higher density when sewer and water are provided.

12410 Glacier Highway is zoned D1(T)D3, intended to be upzoned with the provision of utilities. The VFW property to the west is also D1(T)D3.

12400 Glacier Highway is zoned D1.

The lots are connected to the public water utility, but not the wastewater utility. Subsequent development would require the Alaska Department of Environmental Conservation to approve sanitary services.

2. **Table of Permissible Uses** – The differences between D1 and D3 permissible uses are:

Table of Permissible Uses Paragraph	Allowed in:	
	D1	D3
1.930 Common walls allowed under special density considerations for D3	N	Y
4.100: Heavy Manufacturing and rock crushers are allowed, state or muni projects	Y	N
12.200: Kennels	Y	N
12.300: Zoos, aquariums, wild animal parks	Y	N
12.400: Horse stables and dog team yards	Y	N
14.245/19.240: Marijuana cultivation under 500 sf	Y	N
14.800: Spring water bottling	Y	N
15.610: Transit Center	N	Y
19.100: Open air markets	Y	N
21.100: Resort, lodge	Y	N
21.200: Campgrounds	Y	N
21.300: Visitor facilities related to features of the site	Y	N

3. **Subdivision** –

Feature	D1	D3
Lot size	36,000 sf	12,000 sf
Bungalow	18,000 sf	6,000 sf
Duplex	54,000 sf	18,000 sf
Two detached SFH on lot	72,000 sf	24,000 sf
Lot width	150	100

Glacier Highway is classified as an Arterial under ORD 2013-9. All lots subdivided off of an arterial are required to meet D1 minimum lot size at this time. The Planning Commission is currently considering eliminating this provision and allowing subdivision lot size in accordance with underlying zoning. The issue is scheduled before the Planning Commission on July 25, 2023 (may change). You can find Planning Commission agendas and materials here: <https://juneau-ak.municodemeetings.com/>

4. **Setbacks** – D3 zoning reduces the side yard setback required.

Feature	D1 (feet)	D3 (feet)
Front yard setback	25	25
Rear yard setback	25	25
Side yard setback	15	10

Pre-Application Conference Final Report

Street side yard setback	17	17
--------------------------	----	----

5. **Height –**

Feature	D1 (feet)	D3 (feet)
Permissible	35	35
Accessory	25	25
Bungalow	25	25

- 6. **Access –** Glacier Highway is classified as an Arterial under ORD 2013-9. All lots subdivided off of an arterial are required to meet D1 minimum lot size at this time (see #3 above).
- 7. **Parking & Circulation–** Two off-street parking spaces required per single-family dwelling, one off-street parking space per accessory apartment.
- 8. **Lot Coverage –** Lot coverage can be thought of as anything with a roof.

Feature	D1 %	D3 %
Lot Coverage -permissible uses	10	35
Lot coverage – conditional uses	20	35

- 9. **Vegetative Coverage –** Vegetative cover for D1 and D3 is 20%.
- 10. **Lighting –** Not applicable to this application.
- 11. **Noise –** Not applicable to this application.
- 12. **Flood –** Property does not reside in an recorded flood area. Per Panel 02110C1218E eff. 9/18/2020
- 13. **Hazard/Mass Wasting/Avalanche/Hillside Endorsement –** No hazards in CBJ record.
- 14. **Wetlands –** N/A
- 15. **Habitat –** Check with the U.S. Fish and Wildlife on the presence of eagle nests in the area. The presence of eagle nests may impact construction scheduling. No anadromous waterbodies are on the subject parcel, or within 50 feet.
- 16. **Plat or Covenant Restrictions –** N/A
- 17. **Traffic –** N/A
- 18. **Nonconforming situations –** N/A

Building Division

- 19. **Building –** N/A
- 20. **Outstanding Permits –**
 - a. 4B2301080010
 - i. BLD20180386 – “Direct replacement of composite shingles”
 - ii. BLD20220570 – “Construction of 14’ by 40’ Porch.”

b. 4B2301080020

i. BLD20200121 – “Install heat pump”

General Engineering/Public Works

21. **Engineering** – N/A

22. **Drainage** – N/A

23. **Utilities** – The subject lots are currently served by the municipal water system. Sewer is not available at the subject properties but may be extended at the owner’s expense. This would entail having the sewer main collection line extended approximately 750 feet and would require installation of a pump station. Provisions must be made to route the sewer line under the bridge at Waydelich Creek.

The sewer line is on the water side of the DOT highway, so a DOT ROW permit would be required to trench across the highway to reach the properties. It may be possible to coordinate efforts with the neighbors west of 12275 Glacier Hwy (the last property with sewer) to defray the total cost of the extension.

Fire Marshal

24. **Fire Items/Access** – N/A

Other Applicable Agency Review

25. N/A

List of required applications

Based upon the information submitted for pre-application review, the following list of applications must be submitted in order for the project to receive a thorough and speedy review.

1. Development Permit Application – have each affected owner fill out and sign one of these.
2. Zone Change Application

Additional Submittal Requirements

Submittal of additional information, given the specifics of the development proposal and site, are listed below. These items will be required in order for the application to be determined Counter Complete.

1. A copy of this pre-application conference report.

Exceptions to Submittal Requirements

Submittal requirements that staff has determined **not** to be applicable or **not** required, given the specifics of the development proposal, are listed below. These items will **not** be required in order for the application to be reviewed.

1. N/A

Fee Estimates

The preliminary plan review fees listed below can be found in the CBJ code section 49.85.

Based upon the project plan submitted for pre-application review, staff has attempted to provide an accurate estimate for the permits and permit fees which will be triggered by your proposal.

1. Zone change: \$600

Pre-Application Conference Final Report

2. Public Notice Sign: \$150, with \$100 refundable if the sign is brought back by the Monday following the Planning Commission meeting.

For informational handouts with submittal requirements for development applications, please visit our website at www.juneau.org/community-development.

Submit your Completed Application

You may submit your application(s) online via email to permits@juneau.gov

OR in person with payment made to:

City & Borough of Juneau, Permit Center
230 South Franklin Street
Fourth Floor Marine View Center
Juneau, AK 99801

Phone: (907) 586-0715

Web: www.juneau.org/community-development

Attachments:

Title 49 References:

1. 49.25.300 – Table of Permissible Uses
2. 49.25.400 – Minimum Dimensional Standards
3. 49.70.700 – Transition Zones
4. 49.75.110 – Rezoning

Applications:

AME – Zone Change Application

DPA – Development Permit Application

49.25.300 Determining uses.

- (a) (1) *Listed uses.* There is adopted the table of permissible uses, table 49.25.300. The uses permitted in a zoning area shall be determined through the table of permissible uses by locating the intersection of a horizontal, or use axis and a vertical, or zone axis. The conditions and procedures applicable to the use in the zone thus located shall be as indicated thereat by the digits "1," "2," or "3" as more fully set out in this section and by letters of the alphabet as more fully set out by footnotes in the table. The absence of a digit at the intersection of use and zone axes means that the identified use is not permitted in the identified zone.
- (2) *Unlisted uses.* The permissibility of a use not listed shall be determined pursuant to section 49.20.320.
- (3) *Uses listed more than once.* Where a use might be classified under more than one category, the more specific shall control. If equally specific, the more restrictive shall control.
- (4) *Accessory uses.* Uses constituting an incidental or insubstantial part of a permissible use and commonly associated with the permissible use may be allowed as an accessory use.
- (5) *Nonconforming uses.* Nonconforming uses, including nonconforming residential densities, are subject to chapter 49.30.
- (b) (1) When used in conjunction with a particular use in the table of permissible uses, the number "1" indicates that the use requires department approval pursuant to chapter 49.15, article III, in conjunction with the issuance of a building permit. The use is allowed in the district, but limited conditions may be attached to the approval.
- (2) The number "2" indicates the use requires an allowable use permit from the planning commission. Such uses are allowed in the district, but specified conditions may be attached to the allowable use permit by the commission. The permit procedure is outlined in chapter 49.15, article I.
- (3) The number "3" indicates the use requires a conditional use permit from the commission. The use may or may not be allowed at a particular location, depending on a determination of its compatibility with surrounding or proposed land uses. The planning commission may attach any condition to ensure the compatibility of the proposed use. The conditional use permit procedure is outlined in chapter 49.15, article I.
- (c) A combination of digits such as "1, 3" or "2, 3" indicates that the approval procedure for the identified use in the identified zone will vary depending on whether the project is a major or minor development.
- (1) If the project is a minor development the first number of the combination shall indicate the applicable procedure.
- (2) If the project is a major development the second number shall indicate the applicable procedure.
- (3) Minor development means development which is classified by zoning district as follows:
- (A) *Rural reserve district:* A residential development containing two or fewer dwelling units, two or fewer bedrooms leased on a daily or weekly basis, or a nonresidential building totaling less than 10,000 square feet or using less than one acre of land in total.
- (B) *Single-family residential districts:* A residential development containing two or fewer dwelling units, two or fewer bedrooms leased on a daily or weekly basis, or a nonresidential building totaling less than 5,000 square feet or using less than 10,000 square feet of land in total.
- (C) *Multifamily residential districts:* A residential development containing eight or fewer dwelling units, eight or fewer bedrooms leased on a daily or weekly basis, or a nonresidential building totaling less than 5,000 square feet or using less than 10,000 square feet of land in total.

-
- (D) *Commercial and mixed use districts*: A residential development containing 12 or fewer dwelling units, 12 or fewer bedrooms leased on a daily or weekly basis, or a nonresidential building totaling less than 10,000 square feet or using less than one-half acre of land in total.
- (E) *Industrial districts*: Non-residential buildings totaling 15,000 square feet or using less than one acre of land in total.
- (4) Major development means all development activity that is not a minor development.
- (5) Exceptions. Exceptions to the use of minor and major development classifications as a method of determining the applicable approval procedure shall be as noted in the table of permissible uses.

(Serial No. 87-49, § 2, 1987; Serial No. 89-01, § 2, 1989; Serial No. 89-14, § 2, 1989; Serial No. 89-16, § 2, 1989; Serial No. 89-20, § 2, 1989; Serial No. 89-28, § 2, 1989; Serial No. 89-29, § 2, 1989; Serial No. 89-30, § 2, 1989; Serial No. 89-31, § 2, 1989; Serial No. 90-21, § 2, 1990; Serial No. 90-52, § 3, 1990; Serial No. 90-54, §§ 2, 3, 1991; Serial No. 91-01, § 3, 1991; Serial No. 91-36, § 2, 1991; Serial No. 92-09, § 3, 1992; Serial No. 93-05, § 2, 1993; Serial No. 93-46, §§ 2—4(Exh. A) and (Exh. B), 1993; Serial No. 94-07, §§ 2, 3(Exh. A) and (Exh. B), 1994; Serial No. 94-40, § 2(Exh. A), 1994; Serial No. 95-09, §§ 2, 3(Exh. A) and (Exh. B), 1995; Serial No. 97-10, § 2(Exh. A), 1997; Serial No. 97-19, § 2(Exh. A), 1997; Serial No. 97-47, §§ 2, 3(Exh. A), 1997; Serial No. 98-09, § 4(Exh. A), 1998; Serial No. 98-39, §§ 2—4(Exh. A), 1998; Serial No. 98-40, § 2(Exh. A), 1999; Serial No. 99-22, § 7, 1999; Serial No. 2000-46, § 2(Exh. A), 11-20-2000; Serial No. 2001-12, § 2(Exh. A), 4-02-2001; Serial No. 2010-22, §§ 2, 3(Exh. A), 7-19-2010; Serial No. 2015-07(b)(am), § 2, 2-23-2015, eff. 3-26-2015 ; Serial No. 2015-03(c)(am), § 18, 8-31-2015 ; Serial No. 2019-37, § 2, 3-16-2020, eff. 4-16-2020)

TABLE OF PERMISSIBLE USES - CBJ 49.25.300

	Use Description	Zones																
		RR	D-1	D-3	D-5	D-10 SF	D-10	D-15	D-18	LC	GC	MU	MU2	MU3	NC	WC	WI	I
1.000	Residential																	
	1.100 Single-family dwellings																	
	1.110 Single-family detached, one dwelling per lot	1	1	1	1	1	1	1	1	1	1	1	1			1	1A	1A
	1.120 Single-family detached, two dwellings per lot	1	1	1														
	1.130 Single-family detached, accessory apartment ^x	1, 3	1, 3	1, 3	1, 3	1, 3	1, 3	1, 3	1, 3	1, 3	1, 3	1, 3	1, 3			1, 3		
	1.140 Single-family detached, two dwellings per lot, accessory apartments ^x	1, 3	1, 3	1, 3														
1.200	Duplex	1	1	1	1		1	1	1	1	1	1	1			1		
1.300	Multifamily dwellings						1, 3	1, 3	1, 3	1, 3	1, 3	1, 3	1, 3	1, 3	1, 3			
1.500	Child and Day care homes																	
	1.510 Child; 12 or fewer children under the age of 12	1	1	1	1	1	1	1	1	1	1	1	1	1	1			
	1.520 Reserved																	
	1.530 Adult; 12 or fewer people, 12 years and older	1	1	1	1	1	1	1	1	1	1	1	1	1	1			
	1.540 Reserved																	
	1.550 Child care residence, 6 to 9 children under 18 years of age		3	3	3	3	3	3	3	3	3	3	3	3	3			
1.600	Miscellaneous, rooms for rent situations																	
	1.610 Rooming, boarding houses, bed and breakfasts, single room occupancies with shared facilities, transitional housing, and temporary residences.	3	3	3	3	3	1, 3	1, 3	1, 3	1, 3	1, 3	1	1	1, 3	1, 3	3 ^N		

Created: 2022-10-12 14:40:39 [EST]

(Supp. No. 145)

		Owner or manager must live on site.																
	1.620	Hotels, motels	3							1, 3	1, 3	1, 3	1, 3	1, 3	1, 3	3 ^N	3 ^N	
	1.630	Single room occupancies with private facilities					1, 3	1, 3	1, 3	1, 3	1, 3	1, 3	1, 3	1, 3	1, 3			
1.700	Home occupations		1	1	1	1	1	1	1	1	1	1	1	1	1	1	1	1
1.800	Mobile homes																	
	1.810	Residential mobile homes on individual lots ^E	3	3	3													
	1.815	Caretakers mobile homes on individual lots ^E	3	3	3	3	3	3	3	3	3	3	3			3	3	3
	1.820	Mobile home parks ^E				3	3	3	3	3	3							
	1.830	Mobile home subdivision ^E				3	3	3	3	3	3							
	1.840	Recreational vehicle parks ^F	3 ^F	3 ^F	3 ^F													
1.900	Common wall development																	
	1.910	Two dwelling units				1	1	1	1	1								
	1.911	Accessory apartments ^X	1, 3	1, 3	1, 3	1, 3	1, 3	1, 3	1, 3	1, 3	1, 3	1, 3	1, 3	1, 3	1, 3	1, 3	1, 3	
	1.920	Three or more dwelling units				1, 3	1, 3	1, 3	1, 3	1, 3	1, 3	1, 3	1, 3	1, 3	1, 3			
	1.930	Two dwelling unit structures allowed under special density considerations, subsections 49.25.510(h)			3	3	3	3	3	3	3		3					
2.000	Sales and Rental Goods, Merchandise or Equipment^G																	
2.100	With less than 5,000 square feet and less than 20 percent of the gross floor area of outside merchandising of goods																	
	2.110	Reserved																
	2.120	Miscellaneous								1	1	1	1	1	1	3 ^N	3 ^N	3
	2.130	Marine merchandise and equipment	3 ^T							1, 3	1, 3	1, 3	1, 3	1	1	1, 3	3 ^N	3
2.200	Storage and display of goods with greater or equal to 5,000 square feet									1, 3	1, 3	1, 3	1, 3			3 ^N	3 ^N	3

Created: 2022-10-12 14:40:39 [EST]

(Supp. No. 145)

	and/or 20 percent of the gross floor area of outside merchandising of goods																		
2.300	Marijuana retail store	3								3	3	3	3	3	3	3	3	3	
3.000	Professional Office, Clerical, Research, Real Estate, Other Office Services⁶																		
3.050	Offices of not more than 1,000 square feet		3	3	3	3	3	3	3	3	1	1	1	1	1	1	1 ^N		
3.100	Offices greater than 1,000 but not more than 2,500 square feet						3	3	3	1	1	1	1	1	1	1	3 ^N		
3.200	Reserved																		
3.300	Research, laboratory uses	3 ^T								1, 3	1, 3	1, 3	1, 3	1, 3		1 ^N , 3 ^N	1 ^N , 3 ^N	1, 3	
3.400	Offices greater than 2,500 square feet									1, 3	1, 3	1, 3	1, 3	1, 3	1, 3	1 ^N , 3 ^N		3 ^S	
3.500	Marijuana testing facility	3								3	3	3	3					3	
4.000	Manufacturing, Processing, Creating, Repairing, Renovating, Painting, Cleaning, Assembling of Goods⁶																		
4.050	Light manufacturing	3 ^T						3	3	1, 3	1, 3	1, 3	1, 3	1, 3	1, 3	1 ^N , 3 ^N	1 ^N , 3 ^N	1, 3	
4.070	Medium manufacturing	3 ^T									3	3	3			3 ^N	1 ^N , 3 ^N	1, 3	
4.100	Heavy manufacturing	3 ^T	3 ^Q														3 ^N	3	
4.150	Rock crusher	3 ^T	1 ^Q	1 ^Q													3 ^N	3	
4.200	Storage of explosives and ammunition	3															3 ^N	3	
4.210	Seafood processing	3 ^T														3	1, 3	1, 3	
4.220	Marijuana product manufacturing facility	3 ^{AC}									3	3						3	
5.000	Educational, Cultural, Religious, Philanthropic, Social, Fraternal Uses																		
5.100	Schools																		
	5.110	Elementary and secondary schools including associated grounds and other facilities		3	3	3	3	3	3	3	3	3	3	3	3	3			
	5.120	Trade, vocational schools, commercial schools	3 ^T								3	3	3	3	3		3 ^N	3 ^N	3
	5.130	Colleges, universities	3 ^T	3	3	3	3	3	3	3	3	3	3	3	3	3	3 ^N	3 ^N	3
5.200	Churches, synagogues, temples	3 ^T	3	3	3	3	3	3	3	3	1, 3	1, 3	1, 3	3	3	1 ^N , 3 ^N	3 ^N	1, 3	

Created: 2022-10-12 14:40:39 [EST]

(Supp. No. 145)

5.300	Libraries, museums, art galleries	3 ^T	3	3	3	3	3	3	3	3	1, 3	1, 3	1, 3	1, 3	1, 3	1, 3	3 ^N		
5.400	Social, fraternal clubs, lodges, union halls, yacht clubs	3 ^T									1, 3	1, 3	1, 3	1, 3	1, 3	1, 3	1 ^N , 3 ^N	3 ^N	1, 3
6.000	Recreation, Amusement, Entertainment																		
6.100	Indoor activity conducted entirely within building or substantial structure																		
	6.110 Bowling alleys, billiard, pool halls										1, 3	1, 3	1, 3	1, 3	1, 3	1, 3			3
	6.120 Tennis, racquetball, squash courts, skating rinks, exercise facilities, swimming pools, archery ranges				3	3	3	3	3		1, 3	1, 3	1, 3	1, 3	1, 3	1, 3			3
	6.130 Theaters seating for 200 or fewer	3 ^T						3	3	1	1	1	1	1, 3	1, 3		3 ^N		3
	6.135 Theaters seating from 201 to 1,000									3	1	1	1	1, 3	1, 3		3 ^N		3
	6.140 Coliseums, stadiums, and other facilities in the 6.100 classification seating more than 1,000 people										3	3	3				3 ^N		
	6.150 Indoor shooting range	1, 3									3								3
6.200	Outdoor activity conducted outside enclosed buildings or structures																		
	6.210 Recreational facilities such as golf, country clubs, swimming, tennis courts not constructed pursuant to a permit authorizing the construction of a school	3	3	3	3	3	3	3	3	3	1, 3			1, 3	1, 3		3 ^N		3
	6.220 Miniature golf courses, skateboard parks, water slides, batting cages	3	3	3	3	3	3	3	3	3	1, 3	3	3	1, 3	1, 3		3 ^N		3
	6.240 Automobile, motorcycle racing tracks; off-highway vehicle parks	3									3								3
	6.250 Reserved																		

Created: 2022-10-12 14:40:39 [EST]

(Supp. No. 145)

	6.260	Open space	1	1	1	1	1	1	1	1	1	1	1	1	1	1	1	1	
	6.262	Parks with improved facilities, not approved in conjunction with a major subdivision																	
	6.264	Capacity for up to 20 people ^W	1 ^T	1	1	1	1	1	1	1	1	1	1	1	1	1	3 ^N		
	6.266	Capacity for more than 20 people ^W	3 ^T	3	3	3	3	3	3	3	3	3	3	3	3	3 ^N	3 ^N		
	6.270	Aerial conveyances and appurtenant facilities	3	3	3	3	3	3	3	3	3	3	3	3	3	3 ^N	3 ^N	3	
	6.280	Shooting ranges	3															3	
7.000	Institutional Day or Residential Care, Health Care Facilities, Correctional Facilities																		
7.100	Hospital										3	3	3	3					
7.150	Health care clinics, other medical treatment facilities providing out-patient care							3	3	1, 3	1, 3	1, 3	1, 3	1, 3	1, 3				
7.200	Assisted living			3	3	3	3	3	3	3	1, 3	1, 3	1, 3	1, 3	1, 3				
7.300	Day care centers						3	3	3	1, 3	1, 3	1, 3	1, 3	1, 3	1, 3				
7.310	Child care centers		3	3	3	3	3	3	3	1, 3	1, 3	1, 3	1, 3	1, 3	1, 3				
7.500	Correctional facilities		3	3	3	3	3	3	3	3	3	3	3						
7.600	Sobering centers									3	3	3	3						
8.000	Restaurants, Bars, Nightclubs																		
	8.050	Small restaurants, less than 1,000 ft ² without drive through service	3 ^T					3	3	3	1	1	1	1	1	1	1 ^N		3
8.100	Restaurants, bars without drive through service		3 ^T								1, 3	1	1, 3	1, 3	1, 3	1, 3	1 ^N , 3 ^N	3 ^N	3
8.200	Restaurants, coffee stands with drive through service									1, 3	1		3				1 ^N , 3 ^N	3 ^N	3
8.300	Seasonal open air food service without drive through		3							1, 3	1	1, 3	1, 3	1, 3	1, 3	1, 3	1 ^N , 3 ^N	3 ^N	
9.000	Boat or Motor Vehicle, Sales and Service Operations																		

Created: 2022-10-12 14:40:39 [EST]

(Supp. No. 145)

	9.050	Motor vehicle, mobile home sale or rental									1, 3	1, 3	3	3					1, 3	
9.100		Motor vehicle repair and maintenance, including body work										3							1	
9.200		Automotive fuel station	3 ^T								3	1							1	
9.300		Car wash									3	1							1	
9.400		Boat sales or rental	3 ^T								3	1					1	1	1	
9.450		Boat repairs and maintenance	3 ^T									3					1	1	1	
9.500		Marine fuel, water sanitation	3 ^T														1, 3	1, 3	1, 3	
9.600		Marine commercial facilities including fisheries support, commercial freight, passenger traffic	3														3	3		
10.000	Storage, Parking, Moorage																			
10.100		Automobile parking garages or parking lots not related to a principal use on the lot									3	1	1, 3	1, 3	1, 3	1, 3			1	
10.200		Storage and handling of goods not related to sale or use of those goods on the same lot on which they are stored																		
	10.210	All storage within completely enclosed structures	1, 3	3							3	1	1 ^U , 3 ^U	1 ^U , 3 ^U				1 ^N , 3 ^N	1 ^N	1
	10.220	General storage inside or outside enclosed structures	1, 3	3								1, 3						1 ^N , 3 ^N	1 ^N	1
	10.230	Snow storage basin																		
	10.232	Neighborhood, less than ½ acre	3	3	3 ^Z	3 ^Z	3 ^Z	3 ^Z	3 ^Z	3 ^Z	3 ^Z	1			3 ^Z	3 ^Z	3 ^Z	1	1	
	10.235	Regional, ½ to 1 acre	3	3	3 ^Z						3 ^Z	3						3 ^Z	1	1
	10.237	Area wide, over 1 acre	3	3 ^Z	3 ^Z							3 ^Z							3	3
10.300		Parking of vehicles or storage of equipment outside enclosed structures where they are owned and used by the user of the lot and parking and storage is more than a minor and incidental use of the lot	1, 3	3								1, 3						1 ^N , 3 ^N	1 ^N , 3 ^N	1

Created: 2022-10-12 14:40:39 [EST]

(Supp. No. 145)

10.400	Temporary contractor's storage connected with construction project off-site for a specified period of time	1, 3	3	3	3	3	3	3	3	3	3	3	3	3	3	3	1N	1	
10.500	Moorage																		
	10.510 Public, commercial	3	3	3						3	3	3	3	1, 3	1, 3	1, 3	1, 3	1, 3	
	10.520 Private	1, 3	1, 3	1, 3	1, 3	1, 3	1, 3	1, 3	1, 3	1, 3	1, 3	1, 3	1, 3	1, 3	1, 3	1, 3	1, 3	1, 3	
10.600	Floating structures supporting seasonal, commercial recreation	3	3	3										3	3	3	3		
11.000	Materials Salvage Yards, Waste Management																		
11.100	Recycling operations																		
	11.110 Enclosed collection structures ^o of less than 80 square feet total and less than six feet in height	1 ^P	1 ^P	1 ^P	1 ^P	1 ^P	1 ^P	1 ^P	1 ^P	1	1	1 ^P	1 ^P	1 ^P	1 ^P	1	1	1	
	11.120 Enclosed structures for recyclable materials collection	1 ^P , 3	1 ^P , 3	1 ^P , 3	1 ^P , 3	1 ^P , 3	1 ^P , 3	1 ^P , 3	1 ^P , 3	1 ^P , 3 ^P	1 ^P , 3 ^P	3	3	3 ^P	3 ^P	1	1	1 ^P	
	11.130 Sorting, storage, preparation for shipment occurring outside an enclosed structure																1 ^N	1	
11.200	Reclamation landfill not associated with a specific use	1, 3	1, 3	1, 3	1, 3	1, 3	1, 3	1, 3	1, 3	1, 3	1, 3	1, 3	1, 3				3 ^N	3 ^N	1, 3
11.300	Sanitary landfill	3																	3
12.000	Services and Enterprises Related to Animals																		
12.100	Veterinary clinic	3	3	3						3	1, 3	3	3	3	3	1 ^N , 3 ^N	1 ^N , 3 ^N	1	
12.200	Kennel	3	3							3	3							1, 3	
12.250	Day animal services, grooming, walking, day care	3	3	3	3	3				3	3	3	3	1, 3	1, 3			1, 3	
12.300	Zoos, aquaria, or wild animal rehabilitation facilities with a visitor component	3	3							3	3		3				3 ^N	3	
12.310	Wild animal rehabilitation facilities without a visitor component	3	3	3	3					3	3						3 ^N	3	

Created: 2022-10-12 14:40:39 [EST]

(Supp. No. 145)

12.400	Horseback riding stables, dog team yards	3	3							3	3							3	
13.000	Emergency Services																		
13.100	Fire, police, ambulance	3	3	3	3	3	3	3	3	3	3	3	3	3	3	3 ^N	3 ^N	1, 3	
14.000	Aquaculture, Agriculture, Silviculture, Mining, Quarrying Operations, Spring Water Bottling																		
14.100	Aquaculture	3	3	3						3	3	3	3	1, 3	1, 3	1	1	1	3
14.150	Weirs, channels, and other fisheries enhancement	1, 3	1, 3	1, 3	1, 3	1, 3	1, 3	1, 3	1, 3	1, 3	1, 3	1, 3	1, 3			1	1	1	
14.200	Commercial agricultural operations																		
	14.210	Excluding farm animals	1, 3	1, 3	3	3	3	3	3	3	3	3		3	3			1, 3	
	14.220	Including farm animals ^M	1, 3	3														1, 3	
	14.230	Stabling of farm animals ^M	3	3	3	3					3	3						1, 3	
	14.240	Marijuana cultivation (500 square feet or more under cultivation)	3							3	3							3	
	14.245	Marijuana cultivation (fewer than 500 square feet under cultivation)	3	3 ^{AB}						3	3							3	
14.250	Personal use agriculture																		
	14.253	Hens, 6 maximum	1	1	1	1	1	1	3	3	1	1	3	3	1	1	1	1	1
14.300	Silviculture and timber harvesting ^I	3	3															3	
14.400	Mining operations	2, 3 ^K	3	3													3 ^N	3 ^N	2
14.500	Sand and gravel operations ^I	3	3	3						3	3						3 ^N	3 ^N	3
14.800	Spring water bottling	3	3			3	3	3	3	3	3				3			1, 3	
15.000	Miscellaneous Public and Semipublic Facilities																		
15.100	Post office	3	3	3	3	3	3	3	1, 3	1, 3	1, 3	1, 3	1, 3	1, 3	1, 3	3 ^N	3 ^N	1, 3	
15.200	Airport	3																1, 3	

Created: 2022-10-12 14:40:39 [EST]

(Supp. No. 145)

15.400	Military reserve, National Guard centers	3	3	3						3	3					3 ^N	3 ^N	3
15.500	Heliports, helipads	3									3					3 ^N	3 ^N	3
15.600	Transit facilities																	
	15.610 Transit center			3	3	3	3	3	3	1, 3	1, 3	1, 3	1, 3	1, 3	1, 3	3		1, 3
	15.620 Transit station		1	1	1	1	1	1	1	1	1	1	1	1	1	1	1	1
	15.630 Park and ride not associated with transit station	3	3	3	3	3	3	3	3	1	1	3	3		3			1
15.700	Public works facility	3	3	3	3					3	3							1, 3
16.000	Dry Cleaner, Laundromat																	
16.100	Drop off and pickup only, no onsite laundry or dry cleaning process									1, 3	1, 3	1, 3	1, 3	1, 3	1, 3	1 ^N , 3 ^N	1 ^N , 3 ^N	1, 3
16.200	Full service onsite laundry and/or dry cleaning									3	1, 3	3	3	1, 3	1, 3	3 ^N	1 ^N , 3 ^N	1, 3
17.000	Utility Facilities																	
17.100	Minor	1	1	1	1	1	1	1	1	1	1	1	1	1	1	1	1	1
17.150	Intermediate	3	3	3	3	3	3	3	3	3	1, 3	3	3	3	3	1, 3	1	1
17.200	Major	3	3	3	3	3	3	3	3	3	3			3	3	3	3	3
17.300	Driveways and private roads																	
18.000	Towers and Related Structures																	
18.100 ^{AA}	Towers and antennas 35 feet or less	1	1	1	1	1	1	1	1	1	1	1	1	1	1	1	1	1
18.200 ^{AA}	Towers and antennas 35 to 50 feet	1	3	3	3	3	3	3	3	1	1	1	1	3	3	1	1	1
18.300 ^{AA}	Towers and antennas more than 50 feet in height	3	3	3	3	3	3	3	3	3	3	3	3			3	3	1
18.400	Amateur (ham) radio towers and antennas more than 35 feet in height ^A	1	1	1	1	1	1	1	1	1	1	1	1	1	1	1	1	1
18.500	Wireless Communication Facilities																	
19.000	Open Air Markets, Nurseries, Greenhouses																	
19.100	Open air markets (farm, craft, flea, and produce)	1, 3	1, 3							1, 3	1	1, 3	1, 3	1, 3	1, 3	1 ^N , 3 ^N	1 ^N , 3 ^N	1, 3
19.200	Nurseries, commercial greenhouses																	
	19.210 Retail sales	3	3	3	3	3	3	3	3	1, 3	1	1 ^V	1 ^V	1, 3	1, 3			1

Created: 2022-10-12 14:40:39 [EST]

(Supp. No. 145)

	19.220	Nonretail sales	1, 3	1, 3	1, 3	1, 3	1, 3	1, 3	1, 3	1, 3	1, 3	1	1 ^V	1 ^V					1
	19.230	Marijuana cultivation (500 square feet or more under cultivation)	3									3	3						3
	19.240	Marijuana cultivation (fewer than 500 square feet under cultivation)	3	3 ^{AB}								3	3						3
20.000	Cemetery, Crematorium, Mortuary																		
20.100	Cemetery	1, 3	3	3	3	3	3	3	3	3	3	3							
20.200	Crematorium	3																	1, 3
20.300	Funeral home	3	3	3	3	3	3					1, 3	1	3	3	1, 3	1, 3		
21.000	Visitor-Oriented, Recreational Facilities																		
21.100	Resort, lodge	3	3																
21.200	Campgrounds	1, 3	3																
21.300	Visitor, cultural facilities related to features of the site	3	3									3	3	3	3	3	3	3 ^N	
22.000	Temporary Structures Associated With Onsite Construction																		
22.100	Temporary structures used in connection with construction	1	1	1	1	1	1	1	1	1	1	1	1	1	1	1	1	1	1

Key:

1. Department approval requires the department of community development approval only.
- 1, 3. Department approval required if minor development, conditional use permit required if major development.
2. Allowable use permit requires planning commission approval.
3. Conditional use permit requires planning commission approval.
- 2, 3. Allowable use permit required if minor development, conditional use permit required if major development.

Notes:

- A. A single-family residence is allowed as an owner or caretaker residence that is accessory to an existing permitted use in the industrial zone.
- B. Reserved.

Created: 2022-10-12 14:40:39 [EST]

(Supp. No. 145)

-
- C. Reserved.
 - D. Reserved.
 - E. See special use regulations for mobile homes, chapter 49.65, article III.
 - F. See special use regulations for recreational vehicles, chapter 49.65, article IV. This use allowed by service area designation not zoning district.
 - G. All uses subject to additional performance standards, chapter 49.65, article VIII.
 - H. Reserved.
 - I. Reserved.
 - J. Applies to over 2 acres of harvest area.
 - K. See special use regulations, chapter 49.65, article I. Mining operations are a conditional use in the urban mining district and an allowable use in the rural mining district.
 - L. See special use regulations, chapter 49.65.200, article II.
 - M. Only applicable to the commercial or private stabling of more than three farm animals, or where the running or stabling area is closer than 100 feet to the nearest residence other than the owner for any number of farm animals.
 - N. Use must be water-dependent, water-related, or water-oriented.
 - O. Standards for collection structures: containers must be well maintained and allow no spillage of contents; a specific person or group must be responsible for maintenance of the structure and that person or group shall have a contact telephone number posted on the collection structure; collection structure must be situated so as to not affect traffic or parking; directional signs shall be limited to six square feet and identification signs shall be limited to 24 square feet; such signs will not be included in total sign area allowed for a complex; and the structure shall not exceed a height of six feet. Identification is to be in the following format: greater prominence, the City and Borough recycling logo and the recyclable material identification; lesser prominence, the sponsor name and the contact phone number.
 - P. Preexisting allowable or conditional use permit: If recycling activity is determined by the director to be an accessory use to a use previously permitted under either an allowable or a conditional use permit, the activity may be approved by the department. Other conditions may be required before recycling activity is permitted.
 - Q. Must be in conjunction with an approved state or municipal public road construction project, and must be discontinued at the completion of the project. Road construction by private parties for subdivision development is excluded except as provided in this title. Rock crushed on-site must be used on-site. Crushing shall be limited to 8:00 a.m.—5:00 p.m. unless the director authorizes otherwise.
 - R. Towers shall: be for amateur use only; meet the setback requirements of the zoning district; be unlit except as required by the Federal Aviation Administration. Towers shall be installed in conformance with a valid building permit, application for which shall include a copy of the applicant's amateur station license.
 - S. Limited to lots directly fronting on Glacier Highway West of Industrial Boulevard.
 - T. Must be associated with a unique site specific feature in order to function. Example: Glacier research station - Juneau Icefield location.
 - U. No storage permitted on the first floor of a building.
 - V. Primarily intended for rooftop locations in urban areas.
 - W. The capacity of a park shall be determined by the Director of the Community Development Department or designee in consultation with the Director of the Parks and Recreation Department.
 - X. Special requirements apply to accessory apartment applications. See CBJ § 49.25.510(k).

Created: 2022-10-12 14:40:39 [EST]

(Supp. No. 145)

-
- Z. Snow storage may be permitted for a maximum of five years. After five years a new application must be filed.
 - AA. Does not apply to wireless communication facilities.
 - AB. Use is prohibited in the urban service area but allowed outside the urban service area. An owner or manager must live on site.
 - AC. Use is prohibited within 1,000 feet of recognized neighborhood association established in accordance with CBJ chapter 11.35.

(Serial No. 2002-14, § 2, 4-1-5-2002; Serial No. 2002-29, § 2, 11-4-2002; Serial No. 2003-27am, § 5, 6-16-2003; Serial No. 2003-41, § 2, 9-22-2003; Serial No. 2003-41, § 2, 9-8-2003; Serial No. 2004-09, § 2, 4-12-2004; Serial No. 2006-07, § 2, 4-3-2006; Serial No. 2007-39, § 8, 6-25-2007; Serial No. 2009-22(b), § 2, 10-12-2009; Serial No. 2010-22, § 3(Exh. A), 7-19-2010; 2014-32(e)am, §§ 6—8, 9-29-2014, eff. 10-29-2014 ; Serial No. 2015-07(b)(am), §§ 2—4, 2-23-2015, eff. 3-26-2015 ; Serial No. 2015-34(am), § 2, 7-20-2015, eff. 8-20-2015 ; Serial No. 2015-03(c)(am), § 19, 8-31-2015 ; Serial No. 2015-32, §§ 2, 3, 8-10-2015 ; Serial No. 2015-38(b)(am), § 6, 5-2-2016, eff. 6-2-2016 ; Serial No. 2015-39(am), §§ 2—7, 11-9-2015 ; Ord. No. 2018-31, § 2, 6-4-2018, eff. 7-5-2018 ; Serial No. 2021-35(am), § 3(Exh. A), 2-7-2022, eff. 3-10-2022)

Created: 2022-10-12 14:40:39 [EST]

(Supp. No. 145)

49.25.400 Minimum dimensional standards.

There is adopted the table of minimum dimensional standards, table 49.25.400. Minimum dimensional standards for all zoning districts shall be according to the table of minimum dimensional standards, subject to the limitations of the following sections and as otherwise specifically noted in the special area or use sections, chapters 49.65 and 49.70.

(Serial No. 87-49, § 2, 1987; Serial No. 89-32, § 2, 1989; Serial No. 98-09, § 5(Exh. B), 1998; Serial No. 98-20, § 2(Exh. A), 1998; Serial No. 2004-13, § 2, 9-27-2004; Serial No. 2006-13, § 2, 5-15-2006; Serial No. 2007-13, § 2, 4-2-2007; Serial No. 2012-24, § 3, 5-14-2012, eff. 6-14-2012 ; Serial No. 2021-28 , § 4, 8-23-2021, eff. 9-22-2021)

TABLE 49.25.400

TABLE OF DIMENSIONAL STANDARDS

Zoning Regulations	RR	D-1	D-3	D-5	D-10 SF	D-10	D-15	D-18	MU	MU2	MU3	NC	LC	GC	WC	WI	I
Minimum Lot Size ¹																	
Permissible Uses	36,000	36,000	12,000	7,000	3,600 ¹⁰	6,000	5,000	5,000	4,000	4,000	3,000	3,000	2,000	2,000	2,000	2,000	2,000
Bungalow ⁹		18,000	6,000	3,500	2,500	3,000	3,000	2,500									
Duplex	54,000	54,000	18,000	10,500													
Common Wall Dwelling				7,000	3,600 ¹⁰	5,000	3,500	2,500		2,500							
Single-family detached, two dwellings per lot	72,000	72,000	24,000														
Minimum lot width	150'	150'	100'	70'	40'	50'	50'	50'	50'	50'	40'	40'	20'	20'	20'	20'	20'
Bungalow ⁹		75'	50'	35'	25'	25'	25'	25'									
Common wall dwelling				60'	40'	40'	30'	20'		20'							
Maximum lot coverage																	
Permissible uses	10%	10%	35%	50%	50%	50%	50%	50%	None	80%	75%	None	None	None	None	None	None
Conditional uses	20%	20%	35%	50%	50%	50%	50%	50%	None	80%			None	None	None	None	None

Created: 2022-10-12 14:40:39 [EST]

(Supp. No. 145)

Maximum height permissible uses	45'	35'	35'	35'	35'	35'	35'	35'	None	45' ⁴	35'	35'	45'	55'	35' ⁴	45' ⁴	None
Accessory	45'	25'	25'	25'	25'	25'	25'	25'	None	35'	25'	25'	35'	45'	35' ⁴	45' ⁴	None
Bungalow ⁹		25'	25'	25'	25'	25'	25'	25'									
Minimum front yard setback ³	25'	25'	25'	20'	20' ¹⁰	20'	20'	20'	0'	5'5,8	0'	0'	25'	10'	10'	10'	10'
Maximum front yard setback											20'	15'					
Minimum street side yard setback	17'	17'	17'	13'	10'	13'	13'	13'	0'	5'	0'	0'	17'	10'	10'	10'	10'
Maximum street side yard setback											15'	10'					
Minimum rear yard setback ³	25' ²	25'	25'	20'	10'	20'	15'	10'	0'	5'	5'	0' ¹¹	10'	10'	10'	10'	10'
Minimum side yard setback ³	15' ²	15'	10'	5'	3'	5'	5'	5'	0'	5'	0'	0' ¹¹	10'	10'	10'	10'	0'
Common wall dwelling				10' ⁶	3'	5' ⁷	5' ⁷	5' ⁷		5' ⁷							

Notes:

1. Minimum lot size is existing lot or area shown on chart in square feet.
2. Sixty feet between nonresidential and designated or actual residential site; 80 feet between industrial, extractive and other uses.
3. Where one district abuts another the greater of the two setbacks is required for both uses on the common property line.
4. (Height Bonus) Reserved.

Created: 2022-10-12 14:40:39 [EST]

(Supp. No. 145)

-
5. (Pedestrian Amenities Bonus) Reserved.
 6. Zero-foot setback for the portion of the dwelling with a common wall, five-foot setback or five-foot wide easement for the portion of the dwelling at the common lot line without a common wall, and ten-foot setback for the remaining side yards of the lot.
 7. Zero-foot setback for the portion of the dwelling with a common wall, five-foot setback or five-foot wide easement for the portion of the dwelling at the common lot line without a common wall, and five-foot setback for the remaining side yards of the lot.
 8. On corner lots, buildings shall be set back 15 feet from a street intersection. The area in which buildings shall be prohibited shall be determined by extending the edge of the traveled ways to a point of intersection, then measuring back 15 feet, then connecting the points.
 9. Special restrictions apply to construction on bungalow lots. See special use provisions 49.65.600.
 10. For lots adjacent to an alley, the following reductions to the dimensional standards apply:
 - (a) Minimal lot area includes 50% of adjacent alley (see graphic).
 - (b) Reserved.
 - (c) Minimum front yard setback of ten feet.
 11. Additional setbacks apply when lot abuts a multi-family or single-family residential zoning district.
- (Serial No. 2008-04, § 2, 2-25-2008, eff. 3-27-2008; Serial No. 2012-24, § 3, 5-14-2012, eff. 6-14-2012 ; Serial No. 2021-28 , § 4, 8-23-2021, eff. 9-22-2021; Serial No. 2021-35(am), § 4(Exh. B), 2-7-2022, eff. 3-10-2022)

Created: 2022-10-12 14:40:39 [EST]

(Supp. No. 145)

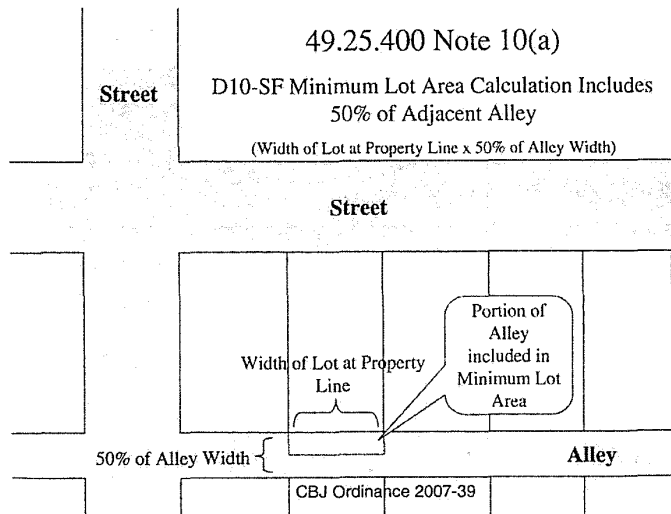
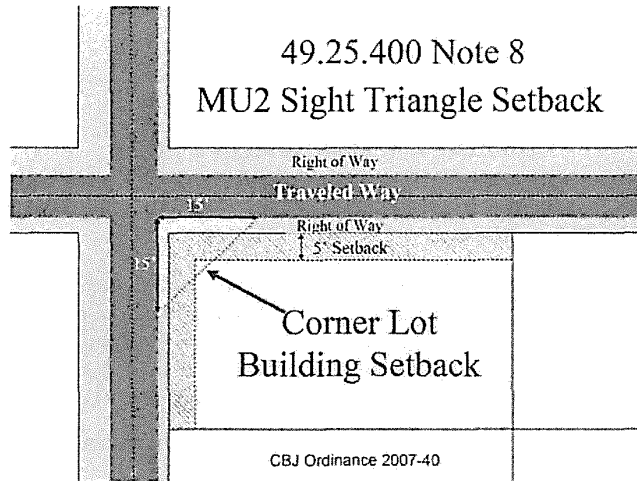

(Serial No. 2007-39, § 9, 6-25-2007; Serial No. 2007-40, § 2, 6-25-2007)

ARTICLE VII. TRANSITION ZONES

49.70.700 Transition zones, generally.

- (a) *Purpose.* A transition zone is an overlay zone district for certain lands located in the urban service boundary that are set aside for higher density development after public water and sewer have been provided. Transition zones shall be identified as such by the designator "T" on the official zoning maps adopted pursuant to section 49.25.110. The overlay district specifies the current lower density zoning classification as well as the proposed increase. The increase in density will take place at the time public services are provided.
- (b) *Applicability.* All properties in transition zones shall comply with the provisions of this article.

(Serial No. 87-49, § 2, 1987)

49.70.710 Subdivisions in transition zones shadow platting.

- (a) *Contents of application.* When a plat is submitted under chapter 49.15, article IV for a subdivision of five or more lots in a transition zone, the application shall include a shadow plat of the property. The shadow plat shall be a sketch plat overlay of the actual lot layout proposed. This overlay shall reflect as nearly as possible the future resubdivision of the parcels into smaller lots, based upon the density and lot size allowed after public sewer and water are provided.
- (b) *Decision.* The director for minor subdivisions and the commission for major subdivisions shall review and approve the application based on how well the proposed lot layout will lend itself to future resubdivision as well as other requirements of this title.

(Serial No. 87-49, § 2, 1987; Serial No. 2015-03(c)(am), § 56, 8-31-2015)

49.70.720 Zoning upgrade.

For lands located within a transition zone, the zoning will be upgraded to the higher density classification at the time public water, sewer or other required improvements are provided according to the following procedures:

- (1) *Procedure.* A zoning upgrade in a transition zone may be initiated by either of two different procedures:
- A. The applicant for a major development permit in a transition zone may make a concurrent request for a zoning upgrade. The plans accompanying the development permit application shall be based upon the density requested. A request for a zoning upgrade shall include preliminary plans and a determination by a certified engineer that such improvements are feasible.
 - B. The planning commission may initiate a zoning upgrade if the public sewer, water, or other required improvements already exist or will be provided by the City and Borough.
- (2) *Hearing and decision.*
- A. *Hearing.* The commission shall consider the upgrade at a hearing upon notice provided in accordance with section 49.15.230. The commission shall base its decision to grant the upgrade

on the determination of the feasibility of providing public water, sewer, and other required improvements. The staff report to the commission shall include a review of the plans and a feasibility report by the City and Borough engineer. The feasibility of providing public services shall consider the ability of the existing sewer and water system to handle the increased demand created by the proposed development.

B. *Decision.*

- (a) The commission may grant a zoning upgrade only to the classification indicated by the prefix (T) on the official zoning maps. A change to any other classification shall be considered pursuant to section 49.75.130.
- (b) The commission shall determine the boundary of the area to be upgraded.
- (c) If the public water, sewer or other required improvements are not constructed or bonded, the commission may grant only conditional approval to the zoning upgrade request. The effective date of the zoning upgrade will be the date of final acceptance or bonding of the improvements.

(Serial No. 87-49, § 2, 1987; Serial No. 93-45, § 2, 1993)

***Chapter 49.75 REZONINGS, SPECIAL STANDARDS, REGULATIONS AND TEXT
AMENDMENTS***

ARTICLE I. REZONINGS

49.75.110 Initiation.

A rezoning may be initiated by the director, the commission, or the assembly at any time during the year. A developer or property owner may initiate a request for rezoning in January or July only. Adequate public notice shall be provided by the director to inform the public that a rezoning has been initiated.

(Serial No. 87-49, § 2, 1987)

49.75.120 Restrictions on rezonings.

Rezoning requests covering less than two acres shall not be considered unless the rezoning constitutes an expansion of an existing zone. Rezoning requests which are substantially the same as a rezoning request rejected within the previous 12 months shall not be considered. A rezoning shall only be approved upon a finding that the proposed zoning district and the uses allowed therein are in substantial conformance with the land use maps of the comprehensive plan.

(Serial No. 87-49, § 2, 1987; Serial No. 2012-31(b), § 2, 8-27-2012)

49.75.130 Procedure.

A rezoning shall follow the procedure for a major development permit except for the following:

- (a) The commission shall make a recommendation to the assembly to approve, approve with modifications, or deny a rezoning request. The commission shall prepare written findings in support of its recommendation. The commission's notice of recommendation shall be posted on the department's website within ten days of the public hearing on the proposed rezoning. If the commission recommends approval of the rezoning request or approval with modifications, the director shall forward the commission's written recommendation to the assembly with an ordinance to amend the official zoning map in accordance with the recommendation. If the commission recommends denial, the amendment shall be deemed disapproved unless the applicant files a notice of protest in accordance with CBJ 49.75.130(b).
- (b) Protests.
 - (1) An applicant may protest the commission's recommendation to deny the rezoning by filing a written statement with the municipal clerk within 20 days of the commission's written notice of recommendation for denial, requesting that an ordinance amending the zoning map as set out in the application be submitted for action by the assembly. The director shall, within 30 days of the filing of the protest with the municipal clerk, prepare a draft ordinance to be appended to the notice of recommendation for consideration by the assembly.

-
- (2) Any person may protest the commission's recommendation to approve a rezoning request or approve a rezoning request with modification by filing a written protest with the municipal clerk within 20 days of the commission's written notice of recommendation.
 - (3) In the case of a timely filed protest and after introduction of the proposed ordinance at a regularly scheduled assembly meeting, the assembly shall hold a public hearing on the proposed rezoning. At the close of the hearing, the assembly shall approve the zoning map amendment as recommended by the commission, approve the zoning map amendment with modifications, or deny the zoning map amendment.
 - (c) All rezonings shall be adopted by ordinance, and any conditions thereon shall be contained in the ordinance. Upon adoption of any such ordinance, the director shall cause the official zoning map to be amended in accordance with the adopted ordinance.

(Serial No. 87-49, § 2, 1987; Serial No. 2012-11, § 2, 4-2-2012 ; Serial No. 2014-14(c)am , § 2, 4-6-2015, eff. 5-7-2015; Serial No. 2015-03(c)(am), § 57, 8-31-2015)

ARTICLE II. SPECIAL STANDARDS

49.75.210 Bonus standards and criteria.

The commission may adopt regulations under chapter 01.60, establishing standards and criteria for awarding bonuses.

(Serial No. 87-49, § 2, 1987; Serial No. 96-41, § 18, 1996)

49.75.220 Historic district design review standards.

- (a) The commission may adopt and enforce regulations under chapter 01.60, establishing standards for the historic district.
- (b) Such standards may include criteria relating to:
 - (1) The relationship of structures to the site and to each other;
 - (2) The relationship of structures to adjoining sites and structures;
 - (3) Landscaping and site treatment;
 - (4) Building and structure design, including:
 - (A) Architectural style;
 - (B) Use of color, including exterior structure lighting;
 - (C) Location and visibility of mechanical equipment;
 - (D) Exterior site lighting; and
 - (E) Variations in multi-structure developments.
 - (5) Design features, arrangement, location, color, illumination and similar features of signs not otherwise regulated by this title;
 - (6) Design and aesthetic standards for outside furniture and miscellaneous structures; and

-
- (7) Such other matters as may be appropriate and which will help provide consistency in agency decisions and guidance to property owners in making site development plan applications.

(Serial No. 87-49, § 2, 1987; Serial No. 96-41, § 19, 1996; Serial No. 99-22, § 14, 1999)

Administrative Code of Regulations cross references—Design review district standards, Part IV, § 04 CBJAC 060.010 et seq.; historic district standards, Part IV, § 04 CBJAC 080.010 et seq.

ARTICLE IV. TEXT AMENDMENTS

49.75.410 Text amendments.

- (a) *Commission initiated.* The commission shall initiate an amendment to this title by holding a public hearing to consider whether it should recommend such amendment to the assembly. The director shall provide at least ten days public notice of the hearing.
- (b) *Assembly initiated.* The assembly shall initiate an amendment to this title by referring such amendment to the commission for proceeding in accordance with subsection (a) of this section.

(Serial No. 87-49, § 2, 1987)

Presented by: The Manager
Introduced: 08/17/87
Drafted by: K.B./J.R.C./T.M.
Planning Commission

ORDINANCE OF THE CITY AND BOROUGH OF JUNEAU, ALASKA

Serial No. 87-49

AN ORDINANCE REPEALING TITLE 49 OF THE CODE OF THE CITY AND BOROUGH OF JUNEAU, ENTITLED "PLANNING AND ZONING," AND REENACTING A NEW TITLE 49, ENTITLED "LAND USE," WHICH NEW TITLE ESTABLISHES A COMPREHENSIVE PROGRAM FOR LAND USE, PLANNING, ZONING AND PLATTING IN THE CITY AND BOROUGH OF JUNEAU.

BE IT ENACTED BY THE ASSEMBLY OF THE CITY AND BOROUGH OF JUNEAU, ALASKA:

* Section 1. Classification. This ordinance is of a general and permanent nature and shall become a part of the city and borough code.

* Section 2. Repeal and Reenactment. Title 49 of the code of the City and Borough of Juneau, Alaska, entitled "Planning and Zoning," is repealed and reenacted as follows:

Title 49

LAND USE

Chapters:

- 49.05 Establishment
- 49.10 Administration and Compliance
- 49.15 Permits
- 49.20 Appeals, Variances and Interpretations
- 49.25 Zoning Districts
- 49.30 Nonconforming Development
- 49.35 Public Improvements
- 49.40 Access, Parking, and Traffic

(P) Drainage. Conditions may be imposed to improve on and off-site drainage over and above the minimum requirements of this title.

(Q) Lighting. Conditions may be imposed to control the type and extent of illumination.

(R) Such other conditions as may be reasonably necessary pursuant to the standards listed in the preceding subsection (f).

Chapter 49.15

PERMITS

Part IV: Minor and Major Subdivisions: Type of Development Permit Required: Standards

49.15.410 GENERAL. (a) This section is intended to:

(1) regulate the subdivision of land by furthering the orderly layout and use of land;

(2) standardize construction procedures for public rights-of-way and utilities;

(3) establish a procedure for vacating or revising existing subdivision lines;

(4) establish a procedure for reviewing boundary and land survey plats for recording; and

(5) provide for the use of shadow plats, in transition areas, in order to accommodate eventual redevelopment at higher densities in the designated urban service area not served by public sanitary sewer or public water when initially developed.

49.15.420 MINOR SUBDIVISIONS. (a) Applicability. A minor subdivision procedure may be used for subdivision of a parcel into not more than four lots; provided, no minor subdivision may be filed or approved:

(1) for the subdivision of a parcel any part of which is within a landslide or avalanche area identified as such in the comprehensive plan or attachments thereto;

(2) if it is a part of or made in connection with a present or projected subdivision development as determined by the director; or

intended to follow property lines, centerlines of streets, alleys, streams, or the extension of such lines as they existed on the date of adoption of the ordinance codified herein.

(g) Street vacations. Whenever any street, alley, or other public way is vacated as provided by law, the zoning districts adjoining the side of such public way shall automatically be extended to follow property lines legally created by such vacation. Such extension following vacation shall have the same force and effect as boundary changes accomplished by explicit amendment.

(h) Stability. In addition to designation as a particular zone, areas on the map shall be designated as stable areas not subject to bonus regulations.

49.25.120 DISTRICTS ADJOINING WATER OR TIDELANDS. Areas under water or tidelands which are not shown as included within any district shall be subject to the regulation of the adjacent district.

49.25.130 UNMAPPED AREAS. All areas of the city and borough not shown on the official zoning map are in the RR, rural reserve zoning district.

Chapter 49.25

ZONING DISTRICTS

Part II: Zoning Districts

49.25.200 RR, RURAL RESERVE DISTRICT is intended for lands primarily in public ownership managed for the conservation and development of natural resources and for future community growth. In addition, recreation cabins, lodges, and small seasonal recreational facilities may be allowed.

49.25.220 RESIDENTIAL DISTRICTS. The following districts are established to provide a healthy, safe, and pleasant environment for residential living protected from incompatible and disruptive activities.

(a) The D-1 residential district is intended to accommodate primarily single-family and duplex residential development in areas outside the urban service boundary at a density of one dwelling unit per acre. Certain D-1 zoned lands, however, may exist within the urban service boundary in transition areas if public sewer or water are absent but planned for. The D-1 classification will be changed to a higher density upon provision of services.

49.70.300 Landslide and Avalanche Areas

49.70.310 Habitat

49.70.320 Watersheds

Part IV: Flood Hazard Areas

Sections:

49.70.400 Floodplain

49.70.410 Exceptions

Part V: Historic District

Sections:

49.70.500 Purpose

49.70.510 Map

49.70.520 Site Plan Review and Approval Required

49.70.530 Exemptions

49.70.540 Standards for Approval of Plans

Part VI: Design Review District

Sections:

49.70.600 Purpose

49.70.610 Map

49.70.620 Site Plan Review and Approval Required

49.70.630 Exemptions

49.70.640 Standards for Approval of Plans

Part VII: Transition Zones

Sections:

49.70.700 Transit Zones, General

49.70.710 Subdivisions in Transition Zones - Shadow
Platting

49.70.630 EXEMPTIONS. One, two, three, and four family residential buildings and accessory buildings thereto on a single zoning lot are exempt from this part unless such buildings are determined by the director to be a part of a larger development.

49.70.640 STANDARDS FOR APPROVAL OF PLANS. (a) General standards. The design review board may approve a site development plan when it is satisfied that the site development under the plan as submitted or as ordered changed by the board will

(1) not result in buildings, signs, or other structures which will be graceless, dominated by long uninterrupted lines or otherwise generally aesthetically displeasing. The board may require the addition, modification, or reduction of exterior architectural details and treatment.

(2) employ design features to minimize the impact on present and future neighborhood developments and traffic arising out of the number of employees, independent contractors, customers, or clients using or servicing the building and their use and activities both inside and outside structures on the site, and

(3) retain or provide for the maximum amount of vegetated area consistent with reasonable use of the site.

Plan amendments ordered by the board must be substantially related to impacts which would be caused by the plan as submitted.

(b) Specific standards. The board shall approve a site development plan when it is satisfied that site development under the plan as submitted or as ordered changed, meets the specific design standards established by the commission by regulation as set forth in Section 49.75.220.

Chapter 49.70

SPECIFIED AREA PROVISIONS

Part VII: Transition Zones

49.70.700 TRANSITION ZONES, GENERAL. (a) Purpose. A transition zone is an overlay zone district for certain lands located in the urban service boundary that are set aside for higher density development after public water and sewer have been provided. Transition zones shall be identified as such by the designator "T" on the official zoning maps adopted

pursuant to Section 49.25.110.

The overlay district specifies the current lower density zoning classification as well as the proposed increase. The increase in density will take place at the time public services are provided.

(b) Applicability. All properties in transition zones shall comply with the provisions of this section.

49.70.710 SUBDIVISIONS IN TRANSITION ZONES - SHADOW PLATTING. (a) When a plat is submitted under Part IV of Chapter 15 for a major subdivision in a transition zone, the application shall include a shadow plat of the property.

The shadow plat shall be a sketch plat overlay of the actual lot layout proposed. This overlay shall reflect as nearly as possible the future resubdivision of the parcels into smaller lots, based upon the density and lot size allowed after public sewer and water are provided.

(b) Commission decision. The commission shall review and approve the application for a major subdivision based on how well the proposed lot layout will lend itself to future resubdivision as well as other requirements of this title.

49.70.720 ZONING CHANGE. For lands located within a transition zone, the official zoning maps will identify the zoning both before and after public water and sewer are provided.

The zoning shall be changed according to the following procedures:

(a) Procedure. The applicant for a development permit in a transition zone may make a concurrent request for a zoning change. A request for a zoning change shall include preliminary plans for public sewer and water service and a determination by a certified engineer that extension of such services is feasible.

(b) Decision. The commission shall base its decision on a future zoning change in a transition zone solely on the determination of the feasibility of providing public water and sewer to the development. The staff report to the commission shall include a review of the plans and feasibility report by the city and borough engineer.

The commission may only grant conditional approval to the zoning upgrade request. The effective date of the zoning upgrade will be the date of final acceptance or bonding of the

sewer and water system.

(c) Applicant options. The applicant may submit a development permit application at the same time the request is made for approval of the zoning upgrade. The applicant is assured of the upgraded density if public water and sewer is provided, and therefore can incorporate the higher density in project plans. The applicant may apply for the zoning change prior to submitting the actual development permit application. This allows the applicant to receive a determination of the allowable density prior to developing final project plans.

Chapter 49.70

SPECIFIED AREA PROVISIONS

Part VIII: Height District

49.70.800 PURPOSE. The superimposed height district shall be used in conjunction with other districts and is established to define the zones in which view plane preservation is particularly significant.

49.70.810 MAP. There is adopted for the purpose of defining the height district in the city and borough the Height District Map dated September 9, 1987, as the same may be amended from time to time by the Assembly by ordinance.

49.70.820 COMPLIANCE REQUIRED. No person may construct or reconstruct any structure within the superimposed height district except in conformity with the height restrictions set out in the superimposed height district map.

Chapter 49.70

SPECIFIED AREA PROVISIONS

Part IX: Coastal Management

49.70.900 49.70.900 GENERAL PROVISIONS. (a) This chapter establishes the coastal management enforceable policies of the Juneau Coastal Management Program.

(b) The director shall be responsible for carrying out the provisions of this chapter except as such is specifically delegated to other parties. The director is specifically authorized to carry out and is responsible for:

(1) All functions allocated to the city and borough under the state's consistency decision making procedure set forth in 6 AAC 50.



Attachment C - Map of Rezone Area & Documents from CBJ E&PW

From: [John Bohan](#)
To: [Ilsa Lund](#); [Bridget LaPenter](#)
Subject: RE: Glacier Highway- Rezone requiring wastewater utilities
Date: Tuesday, April 30, 2024 4:00:18 PM
Attachments: [image.png](#)

Hi Ilsa,

CBJ doesn't have plans to extend Wastewater beyond the current terminus at 12280 GH. Duran has a subdivision proposal for the large tract just past Waydelich Creek that he would extend sewer to at his expense in order to maximize density of the large tract subdivision. The CBJ had committed to provide a trestle for conveying sewer across Waydelich Creek to encourage the development of the large tract, but that is the only commitment to a sewer extension.

Make sense?

Thanks

John Bohan, PE

CBJ Chief CIP Engineer
155 Heritage Way
Juneau AK 99801
(907)586-0800 x-4188

From: Ilsa Lund <Ilsa.Lund@juneau.gov>
Sent: Tuesday, April 30, 2024 3:40 PM
To: John Bohan <John.Bohan@juneau.gov>; Bridget LaPenter <Bridget.LaPenter@juneau.gov>
Subject: Glacier Highway- Rezone requiring wastewater utilities

Hi Bridget and Bohan,

I'm reaching out to get your input on an application that was submitted requesting a rezone in a transitional zoning district. From what I understand, approval of the rezone is contingent on providing public wastewater line to the properties. What is the feasibility that this could be achieved? I'm told that these properties were part of a recent rezone request that was denied, but I can't find any documentation on that. Perhaps you recall?

I've attached a map of the area and the submitted application. It's just west of Auke Bay. The addresses are 12400 and 12410 Glacier Highway.

Please let me know if you require further information.

Kind regards,

Ilsa Lund | Planner I

[Community Development Department](#) | City & Borough of Juneau, AK

Location: 230 S. Franklin Street, Marine View Building

Contact of visit the Permit Center on the 4th floor for an in-person meeting. 907-568-0715

Office: 907.586.0753 ext. 4128



Fostering excellence in development for this generation and the next.

From: John Bohan
To: Lisa Lund; Bridget LaPenter
Subject: FW: PWFC Item for 6-2 - Waydelich Creek Sewer crossing
Date: Wednesday, May 1, 2024 12:20:36 PM
Attachments: Sewer Crossing - 6-2-24.pdf
PWFC Item for 6-2 - Waydelich Creek

A little more info on sewer extension on Glacier Hwy – documentation on the trestle offer and some background. Never got legs then.

Needs
John Bohan, PE
CBJ Chief CIP Engineer
155 Heritage Way
Juneau AK 99801
(907)586-0800 x-4188

From: John Bohan
Sent: Thursday, May 5, 2022 5:18 PM
To: Katie Koester <Katie.Koester@Juneau.org>
Subject: PWFC Item for 6-2 - Waydelich Creek Sewer crossing

Short version: Land owner outside of existing sewer service area made a deal for us (Rorie) to extend sewer to the property in 2015 via a pipe bridge over the creek to be able to provide gravity sewer to the property instead of forcing them to construct and install a new sewer lift station and CBJ WW having to maintain another lift station. The owner was selling the property to a developer, and this was part of the deal for selling the property to Duran.

The new property owner / developer – Marciano Duran - has expressed interest in starting his development and wants to get the ball rolling on the sewer for the property...

PWFC was amenable to the idea then, when costs were under \$50k for CBJ portion. That was before project escalation, covid and major material price increases.

I have requested new quotes on the pipe bridge pieces, given our quote was from 2015 and per the new sales rep at the company, “very generous pricing” (of course!)

Hopefully will have information in time to get it into the packet for the 6-2 PWFC to determine their interest and then figure out where we would get money from to move the pipe bridge procurement forward.

Waydelich Creek is located on Glacier Highway about a half mile past Auke Bay and before Stabler’s quarry entrance.

Will keep you posted when I get more information.

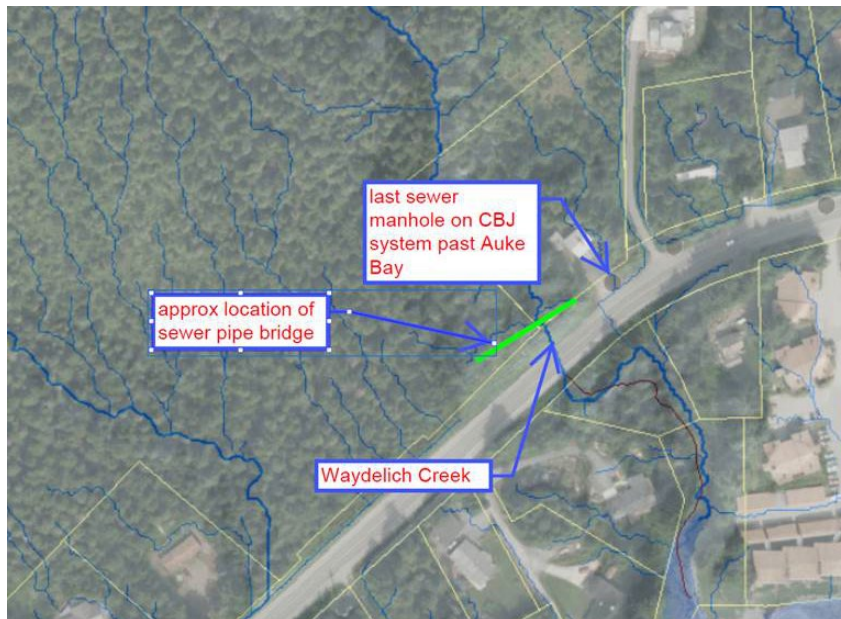



Thanks
John Eolan, PE
CBJ Chief CIP Engineer
155 S. Seward St
Juneau AK 99801
(907)586-0800 x-4188
fax 463-2606

From: [John Bohan](#)
To: [Ilsa Lund](#); [Bridget LaPenter](#)
Subject: RE: PWFC Item for 6-2 - Waydelich Creek Sewer crossing
Date: Wednesday, May 1, 2024 12:22:54 PM
Attachments: [RE: PWFC Item for 6-2 - Waydelich Creek Sewer crossing](#)

One more... ball was in Duran's court to move forward with the Subdivision in 2022 and it died before we had to present to the PWFC for concurrence of the original agreement.

Thanks
John Bohan, PE
CBJ Chief CIP Engineer
155 Heritage Way
Juneau AK 99801
(907)586-0800 x-4188

From: Rorie Watt
Sent: Friday, August 30, 2013 3:38 PM
To: John Bohan
Subject: FW: Emailing: Waydelich Sewer Extention
Attachments: Waydelich Sewer Extention.pdf

Put this one your list of things to think about. Not exactly the greatest report, I'll leave my copy in your mailbox. Thanks.

-----Original Message-----

From: Rorie Watt
Sent: Friday, August 30, 2013 3:36 PM
To: 'Marciano Duran'
Cc: 'Josette Duran'
Subject: RE: Emailing: Waydelich Sewer Extention

We should look at a sewer project for the remaining properties in Auke Bay that are in the urban service boundary. I understand the grade issues on your property, but before we would do a project for just you, we would need to look at whether it made sense to serve all of the properties out to Auke Nu Creek.

Second, I do not know how far back on your property you could develop before you lose water pressure and flow. I'm pretty sure that pressure is controlled by the elevation of the pool in the Auke Lake reservoir, which is typically about 200'.

Once you get to about 130' in elevation, there will only be 50' of static head or 30psi. The Fire Department is going to require a minimum flow of 1000gpm with a residual pressure of 20 psi at all fire hydrants. I guess what I am saying is that it is unlikely that your development could go much above 130' without a water booster station. They are expensive. This would be a good thing to have your engineer analyze. You can get actual existing pressures from Water Utility.

In the mean time, we'll look at a sewer project. I'll get back to you on that.

-----Original Message-----

From: Marciano Duran [mailto:mduran@acsalaska.net]
Sent: Friday, July 26, 2013 11:51 AM
To: Rorie Watt
Cc: 'Josette Duran'
Subject: Emailing: Waydelich Sewer Extention

Rorie-

Per our conversation some weeks ago enclosed is the Waydelich Creek sewer extension information/ study that Moore engineering was working on and has now completed. As I mentioned by having the CBJ do this project it will ensure housing units availability for the next 10+ years as well as other future development potential. In reviewing this information, I am of the opinion the pressure sewer line would be more beneficial now and for the

future sewer needs on Glacier Highway. Please let me know if you have any questions or would like to meet to discuss further.

Thank you,

M

Your message is ready to be sent with the following file or link attachments:

Waydelich Sewer Extention

Note: To protect against computer viruses, e-mail programs may prevent sending or receiving certain types of file attachments. Check your e-mail security settings to determine how attachments are handled.

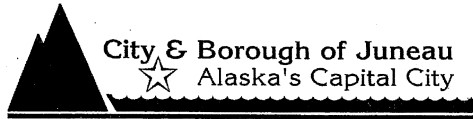

City and Borough of Juneau
Engineering and Public Works Department
155 South Seward Street
Juneau, Alaska 99801
Telephone: 586-0800 FAX: 586-4530

May 20, 2015

RE: Waydelich Creek Property Gravity Sewer Offer –
Parcel Number 4B2801040270

Southeastern Land and Development Co.
Attn. Mal Menzies
19005 Glacier Hwy
Juneau AK 99801

Dear Mr. Menzies,

Thank you for discussing the potential development of your property adjacent to Waydelich Creek and the proximity of the sewer system to aid in the development. The CBJ offers to provide you with a pipe trestle structure to cross Waydelich Creek for the property developer to install that would enable the majority of the property to be served with gravity sewer from the existing sewer manhole on the east side of Waydelich Creek.

The materials the CBJ would provide include:

- an engineered sewer pipe trestle structure to cross Waydelich Creek
- engineered design plans for construction of abutments and the sewer pipe trestle
- ADOT/PF permit for the pipe trestle and gravity sewer line from the existing manhole to the end of the trestle
- Inspection and testing services for the installation and construction of the trestle system.

The remainder of the work; including sewer design, permitting, supply and installation of all pipe (including arctic pipe) to CBJ Standards and necessary fittings etc., and installation of the pipe trestle would be the responsibility of the development contractor / property owners.

Given the topography of the property, the expected alignment of the gravity sewer within the property, outside of future rights of way, the CBJ will require access and maintenance easements to the sewer system, including an access and maintenance easement for future connections to the sewer system from Glacier Highway.

As you or a future developer completes plans to subdivide and improve the property, you can determine the best location for the pipe trestle. We do not think it makes sense to guess at a location and for that reason, suggest that CBJ's contribution be as described in this letter.

Please contact us if you would like to discuss this offer further. To proceed forward, we will need to formalize an agreement through the CBJ Assembly in order to make this official. The Assembly Public Works and Facilities Committee are receptive to the concept when presented at the May 4, 2015 meeting.

Sincerely,

John Bohan
Chief Engineer
john.bohan@juneau.org

cc. Marciano Duran, Vista Del Mar

From: [John Bohan](#)
To: "Marciano Duran"
Cc: ["duancoak@gmail.com"](mailto:duancoak@gmail.com)
Subject: RE: Waydelich
Date: Thursday, June 30, 2022 4:32:09 PM

Hi Marciano,

Have started getting information from the suppliers regarding trestles and are discussing with the leadership how to present this good idea to the Assembly for their approval and for them to fund it. A couple of things have come up that we will need prior to moving this to the Assembly for approval:

- Preliminary Plat approved by the PC
- Construction Plans, drainage plans, etc. (all the requirements associated with Platting)
- Commitment letter from Duran Construction to construct the subdivision ROW improvements to completion within a construction period.

Please confirm your willingness to complete these tasks and your timeframe to complete them, so I can report back to leadership of how we will proceed forward.

Let me know if you have any questions.

I'll be out for most of next week, so, weather pending should be returning sometime around the 11th.

Have a great 4th.

Thanks. jb

Thanks

John Bohan, PE

CBJ Chief CIP Engineer

155 S. Seward St

Juneau AK 99801

(907)586-0800 x-4188

fax 463-2606

From: Marciano Duran <mduran@acsalaska.net>

Sent: Monday, June 6, 2022 12:56 PM

To: John Bohan <John.Bohan@juneau.org>

Cc: duancoak@gmail.com

Subject: RE: Waydelich

EXTERNAL E-MAIL: BE CAUTIOUS WHEN OPENING FILES OR FOLLOWING LINKS

Cool Thanks for the update!

M

From: John Bohan [<mailto:John.Bohan@juneau.org>]

Sent: Monday, June 06, 2022 9:13 AM

To: 'Marciano Duran'

Cc: duancoak@gmail.com

Subject: RE: Waydelich

Hi Marciano,

Just getting back to town.

I have reached out multiple times since we last spoke and have spoken with the supplier we had used to estimate the sewer trestle costs. They said they will quote us, however we have not received any feedback from them on price increases except to be prepared for a significant increase in costs. They have yet to provide anything back in writing that we can provide to the Assembly for their

consideration and determination on funding.

I will keep you posted.

Thanks

John Bohan, PE

CBJ Chief CIP Engineer

155 S. Seward St

Juneau AK 99801

(907)586-0800 x-4188

fax 463-2606

From: Marciano Duran <mduran@acsalaska.net>

Sent: Friday, June 3, 2022 3:03 PM

To: John Bohan <John.Bohan@juneau.org>

Cc: durancoak@gmail.com

Subject: Waydelich

EXTERNAL E-MAIL: BE CAUTIOUS WHEN OPENING FILES OR FOLLOWING LINKS

Hello John just checking to see how we are doing on the Sewer pipe and Trussell materials?

Thank you,

Marciano

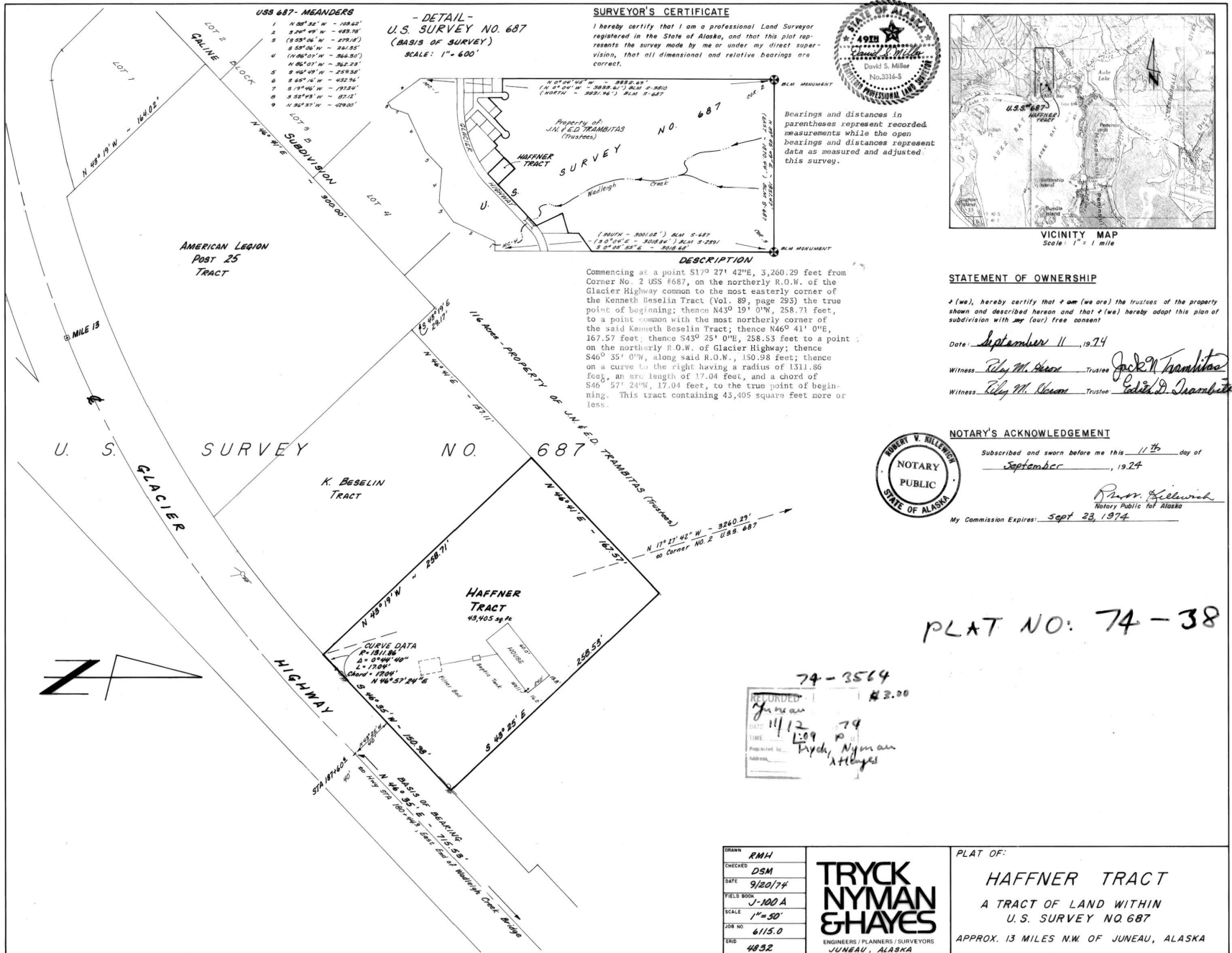

Attachment D - Plat 74-38W

74-38

CITY AND BOROUGH OF JUNEAU, ALASKA

PLATTING RESOLUTION NO. 385

WHEREAS, Jack N. & Edith D. Trambitas
Applicant(s)

has applied to the City and Borough of Juneau Planning Commission in proper form for a waiver of platting requirements of the subdivision of the following described real property:

Commencing at a point S17°27'42" E, 3,260.29 feet from Corner No. 2 USS 687, on the northerly R.O.W. of the Glacier Highway common to the most easterly corner of the Kenneth Beselin Tract (Vol. 89, page 293) the true point of beginning; thence N 43°19'0" W, 258.71 feet, to a point common with the most northerly corner of the said Kenneth Beselin Tract; thence N 46°41'0"E, 167.57 feet; thence S 43°25'0" E., 258.53 feet to a point on the northerly R.O.W. of Glacier Highway, thence S46°35'0" W, along said R.O.W., 150.98 feet; thence on a curve to the right having a radius of 1311.86 feet, an arc length of 17.04 feet, and a chord of S 46°57'24"W, 17.04 feet to the true point of beginning. This tract contains 43,405 square feet more or less.

SEE PLAT NO. 74 - 38

74-3564
3.00
RECORDED-FILED
JUNEAU REC.
DISTRICT
NOV 12 1 09 PM '74
REQUESTED BY Trambitas
ADDRESS _____
Myman
Flayes

according to the attached plat, sketch or diagram.

WHEREAS, The Commission finds that the proposed conveyance: (a) is not being made for the purpose of or in connection with a present or projected subdivision development; (b) is an isolated transaction which does not fall within the general intent of Title 40, Chapter 15, Alaska- Statutes; and (c) does not involve or require any dedication of a street, alley thoroughfare, park or other public area.

BE IT RESOLVED BY THE CITY AND BOROUGH PLANNING COMMISSION AS THE PLATTING AUTHORITY FOR THE CITY AND BOROUGH OF JUNEAU, ALASKA:

The said application for a statutory waiver of plat and recording requirements to a proposed conveyance of the above-described property is hereby granted.

Dated October 14, 1974

CITY AND BOROUGH OF JUNEAU, ALASKA
PLANNING COMMISSION

Attest
Karl O. Mielke
Clerk

By: Steve L...
Chairman

Presented by: The Manager
Introduced: 06/08/2015
Drafted by: A. G. Mead

ORDINANCE OF THE CITY AND BOROUGH OF JUNEAU, ALASKA

Serial No. 2015-03(c)(am)

An Ordinance Amending the Land Use Code.

BE IT ENACTED BY THE ASSEMBLY OF THE CITY AND BOROUGH OF JUNEAU, ALASKA:

Section 1. Classification. This ordinance is of a general and permanent nature and shall become a part of the City and Borough of Juneau Municipal Code.

Section 2. Amendment of Section. CBJ 49.10.130, Meetings, is amended to read:

49.10.130 Meetings.

- (a) Regular meetings shall be held on the second and fourth Tuesday of each month.
- (b) Special meetings may be called by the chair or any three members of the commission. Public notice of special meetings shall be made 24 hours in advance and shall be supplied to the local news media and posted on the municipal bulletin board. Commission members will be notified by the department.
- (c) Public notice for all permits and other land use ordinance actions shall be according to the requirements established for such actions.
- (d) Meetings shall be conducted under Robert's Rules of Order, as modified by the commission.
- (e) The commission may, by motion, establish its own rules of procedure and committees, meeting times, dates and places, media for public notice, development application forms, referral and review agencies and procedures, and any other matter reasonably necessary or desirable for the full and complete conduct of its duties pursuant to this title and any other provision of law.

//

//

(g) *Specific conditions.* The commission may alter the director's proposed permit conditions, impose its own, or both. Conditions may include one or more of the following:

...

(4) *Dedications.* Conveyance of title, easements, licenses, or other property interests to government entities, private or public utilities, owners' associations, or other common entities may be required.

...

Section 10. Repeal and Reenactment of Article. CBJ 49.15, Article IV Minor and Major Subdivisions, is repealed in its entirety and reenacted to read:

Article IV. Subdivisions

Division 1. Permits

49.15.400 Purpose and applicability.
49.15.401 Minor subdivisions.
49.15.402 Major subdivisions.
49.15.403 Lot consolidations.
49.15.404 Public way vacations.

Division 2. Plat Requirements

49.15.410 Sketch plat.
49.15.411 Preliminary plat requirements.
49.15.412 Final plat requirements.
49.15.413 Plat expiration.
49.15.414 Plat effective date.
49.15.415 Recorded plats legalized.

Division 3. Design

49.15.420 Lots.
49.15.421 Cul-de-sac lots.
49.15.422 Public use lots.
49.15.423 Panhandle lots.
49.15.424 Access.

Division 4. Privately Maintained Access in Rights-of-Way

49.15.430 Purpose.
49.15.431 Application.
49.15.432 Department action.
49.15.433 Design criteria.
49.15.434 Access agreement.

49.15.435 Other requirements.

Division 5. Remote Subdivisions

49.15.440 Remote subdivisions.
49.15.441 Applicability.
49.15.442 Improvement standards.

Division 6. Survey and Monumentation Standards

41.15.450 Licensed surveyor required.
49.15.451 Boundary lines – basis of bearing.
49.15.451 Accuracy of survey.
49.15.453 Monumentation.

Division 1. Permits

49.15.400 Purpose and applicability.

(a) The purpose of this article is to facilitate the subdivision of land to promote the public health, safety, and general welfare of the citizens of the CBJ in accordance with The Comprehensive Plan of the City and Borough of Juneau, Alaska. To meet this objective, this article is intended to:

- (1) Establish a process that facilitates the fair and predictable division of land;
- (2) Encourage the efficient and cost-effective provision of public services;
- (3) Address traffic and circulation to reduce congestion;
- (4) Provide for flexibility in the division and establishment of residential and commercial lots;
- (5) Establish procedures for subdividing land to accommodate a variety of housing types; and
- (6) Accomplish uniform monumentation for land subdivision and facilitate accurate legal descriptions for land conveyance.

(b) This article shall apply to any division or redivision of real property within the City and Borough. This article shall not apply to cemetery plots or land leases.

(E) Space for approval signature by the director of engineering and public works.

(F) A north arrow and scale.

(3) *Scale.* Horizontal scale must be one inch equals 50 feet or greater. Vertical scale must be one inch equals five feet or less with a minimum scale of one inch equals ten feet. The director of engineering and public works may approve alternative scales.

(4) *Benchmarks.* The locations, elevations and description of datum of permanent benchmarks must be shown.

(5) *Street profiles.* Profiles of streets shall indicate finished and existing grades for centerline of the street and shall extend a minimum of 200 feet beyond the limits of the proposed project or, if intersecting an existing street, extend to the far side of the existing street.

(6) Plans and profiles, where applicable, shall include location, elevation, size, materials, and all other details of the proposed improvements.

(7) Complete survey data must be shown for all horizontal and vertical curves.

(8) Construction plans shall include the location of all existing and proposed utilities.

(d) *As-built drawings.* The developer, upon completion of required improvements, must submit a reproducible and digital format copy of as-built plans unless otherwise required by the director of engineering and public works.

Section 24. Repeal and Reenactment of Section. CBJ 49.35.210 Street system, is repealed and reenacted to read:

49.35.210 Street system.

(a) Subdivision street systems shall be designed for the most advantageous development of the entire neighborhood area and shall meet the following criteria:

(1) The street system shall provide for connecting streets into adjoining unsubdivided lands.

(2) Subdivision street systems shall be designed to maximize the number of connecting streets in a given area in order to reduce the volume of traffic and traffic delays on major streets (arterials and major collectors), to minimize bypass and through trips on residential streets, and to increase the number of local street

connections facilitating safer bicycle and pedestrian travel.

(3) Traffic calming should be taken into account in street layout and design.

(b) *Major and minor arterials.* Except as provided in subsection (3) of this section, if a new subdivision involves frontage along an arterial street:

(1) The plat shall note that no lots shall access directly onto the arterial;

(2) Access shall be provided onto an interior access street or a separate frontage road.

(3) A parcel of land with less than 500 feet of frontage on a street, or with less than 350 feet in depth may be subdivided so as to allow access directly onto a minor arterial street if all of the following conditions are met:

(A) All of the resulting lots must meet the minimum lot area standard for a single family dwelling in the D-1 zoning district (36,000 sq. ft.).

(B) All of the lots must share a common access point and further subdivision of the newly created lots is not allowed.

(C) Common access to all lots is required and back out parking is prohibited. The applicant must submit a plan that shows the feasibility of off street parking for all lots and an adequate area for a turnaround to prevent back out parking.

(D) The applicant must provide assurance in the form of an easement, plat note, and a maintenance agreement that is recorded with the subdivision, all of which must be acceptable to the director, that ensures the required common access will be constructed and maintained by the property owners.

(E) The proposed subdivision must meet all other applicable subdivision standards and requirements.

(c) *Collector streets.* Collector streets in adjoining subdivisions shall be continued in the new subdivision as needed.

(1) *Major collectors.* Except as provided in subsection (C) of this section, if a new subdivision involves frontage along a major collector street:

(A) The plat shall note that no lots shall access directly onto the major collector.

(B) Access shall be provided onto an interior access street or a separate frontage road.

From: [Drown, Arthur EE \(DOT\)](#)
To: [Ilsa Lund](#)
Cc: [Siverly, Ryan J \(DOT\)](#)
Subject: RE: Glacier Highway- Rezone requiring wastewater utilities
Date: Tuesday, April 30, 2024 3:27:48 PM
Attachments: [image.png](#)

EXTERNAL E-MAIL: BE CAUTIOUS WHEN OPENING FILES OR FOLLOWING LINKS

Good afternoon Ilsa,

My quick response to this would be that I think our permitting process would be the least cumbersome part of installing nearly 1,000 feet of waste water utility within the right of way. We also would not permit the waste water service to the property owners as I understand it but we would permit it to the City as a City utility. So as long as CBJ is willing to own and maintain the subject utility and between the City and the developer the cost of planning, engineering and construction can all be worked out, I think we would most likely have no issue permitting it. I would of course have to leave the final say of that to our Right of Way Utilities staff, but this is my 30,000' review of your inquiry.

I will also mention that we currently have a project underway at Waydelich Creek to repair the embankment and culvert at Glacier Highways crossing of the stream. I am not sure how the embankment rebuild might impact future installation of a utility crossing through that area but it could add to the complications and or restrictions.

Arthur Drown

Right of Way Agent
Property Management, Right of Way
Department of Transportation & Public Facilities
Southcoast Region
6860 Glacier Hwy, Juneau, AK 99801
(907)465-4517

From: Ilsa Lund <Ilsa.Lund@juneau.gov>
Sent: Tuesday, April 30, 2024 2:46 PM
To: Drown, Arthur EE (DOT) <arthur.drown@alaska.gov>
Subject: Glacier Highway- Rezone requiring wastewater utilities

You don't often get email from ilsa.lund@juneau.gov. [Learn why this is important](#)

CAUTION: This email originated from outside the State of Alaska mail system.

Do not click links or open attachments unless you recognize the sender and know the content is safe.

Hi Arthur,

I'm reaching out to get your input on an application that was submitted requesting a rezone in a transitional zoning district. Approval of the rezone is contingent on providing public wastewater line to the properties. What is the feasibility that this project would be able to obtain the required ROW permits to put in that utility?

I've attached a map of the area and the submitted application. It's just west of Auke Bay. The addresses are 12400 and 12410 Glacier Highway.

Please let me know if you require further information.

Kind regards,

Ilsa Lund | Planner I

Community Development Department | City & Borough of Juneau, AK

Location: 230 S. Franklin Street, Marine View Building

Contact of visit the Permit Center on the 4th floor for an in-person meeting. 907-568-0715

Office: 907.586.0753 ext. 4128



Fostering excellence in development for this generation and the next.

From: [llolmb](#)
To: [PC Comments](#)
Subject: AME2024 0001: Zone Change
Date: Sunday, June 2, 2024 10:04:23 AM

EXTERNAL E-MAIL: BE CAUTIOUS WHEN OPENING FILES OR FOLLOWING LINKS

Very difficult to figure out what this zone change is all about in order to make an informed comment.

That said, my biggest concern regarding development in this area is protecting the salmon stream, Wadelich Creek.

Thank you.

Linda Blefgen
Auke Bay

From: [Kay Kay](#)
To: [PC Comments](#)
Subject: Rezone 12400 and 12410 Glacier Hwy - please deny D3
Date: Monday, June 3, 2024 9:12:21 AM

EXTERNAL E-MAIL: BE CAUTIOUS WHEN OPENING FILES OR FOLLOWING LINKS

Rezone 12400 and 12410 Glacier Hwy

Please deny the change from D1(T) D3 to D3 for this property. The area would not safely support higher density D3 without extensive infrastructure upgrades at a cost to the community. This includes utilities, access connections, pedestrians safety and vehicle interaction upgrades.

Invitation to Comment

On a proposal to be heard by the CBJ Planning Commission

Your Community, Your Voice

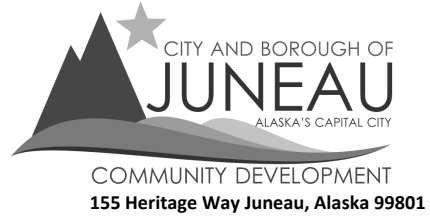

TO

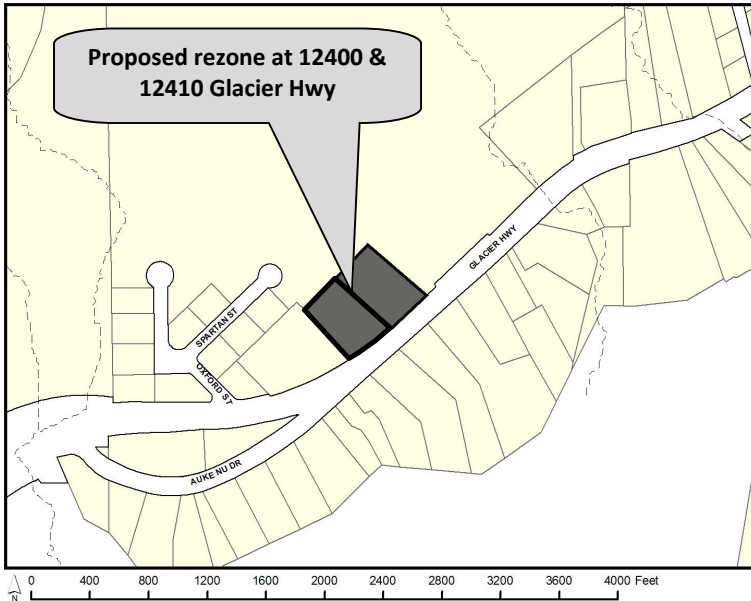

A Zone Change Application has been submitted for consideration and public hearing by the Planning Commission for a **zone upgrade from D1 (T) D3 to D3 at 12400 & 12410 Glacier Highway.**

PROJECT INFORMATION:

Project Information can be found at:

<https://juneau.org/community-development/short-term-projects>

PLANNING COMMISSION DOCUMENTS:

Staff Report expected to be posted **June 17, 2024** at

<https://juneau.org/community-development/planning-commission>

Find hearing results, meeting minutes, and more here, as well.

Now through June 3	June 4 — noon, June 21	HEARING DATE & TIME: 7:00 pm, June 25, 2024	June 26
Comments received during this period will be sent to the Planner, Ilsa Lund to be included as an attachment in the staff report.	Comments received during this period will be sent to Commissioners to read in preparation for the hearing.	This meeting will be held in person and by remote participation. For remote participation: join the Webinar by visiting https://juneau.zoom.us/j/83127986319 and use the Webinar ID: 831 2798 6319 OR join by telephone, calling: 1-253-215-8782 and enter the Webinar ID (above). You may also participate in person in City Hall Assembly Chambers, 155 Heritage Way Juneau, Alaska.	The results of the hearing will be posted online.

FOR DETAILS OR QUESTIONS,

Phone: (907)586-0753 ext. 4128

Email: pc_comments@juneau.gov or ilsa.lund@juneau.gov

Mail: Community Development, 155 Heritage Way, Juneau AK 99801

Case No.: AME2024 0001
Parcel No.: 4B2301080010 & 4B2301080020
CBJ Parcel Viewer: <http://epv.juneau.org>



Attachment H - Abutters Notice and Public Notice Sign Photo

Waydelich Creek Subdivision

VISTA DEL MAR

WASTEWATER FEASIBILITY STUDY

INCLUDING

COST ESTIMATE FOR SEWER LINE CONNECTION TO CBJ
AUKE BAY WASTEWATER COLLECTION SYSTEM

For
Duran Construction
Juneau, Alaska

BY

Moore Engineering
July 2013



Moore Engineering

Page 1

Waydelich Creek Subdivision

INDEX

- Purpose of the Study
- Design Requirements
- Cost Estimate
- List of figures

Figure 1- Planning Map for Vista Del Mar

Figure 2 – Alternative connection options

Figure 3 – Site Map

Figures 4,5 CBJ Planning Mapping

Figures 6-9 ADOT plans on Glacier Highway and Wadelich Creek

Figures 10 CBJ Utility Plans Water

Waydelich Creek Subdivision

PURPOSE OF THE STUDY

1. Waydelich Creek Proposed Subdivision Wastewater Treatment Alternatives

Moore Engineering has been asked to perform a qualitative engineering analysis of the preliminary wastewater disposal options for a proposed new subdivision north of the Glacier Highway near Auke Bay and Waydelich Creek.

The proposed Waydelich Creek Subdivision contains roughly 120 acres of undeveloped native forest land. Waydelich Creek, a major fish stream, runs through the middle of the subdivision. This will make full development of the parcel difficult as a major stream crossing of Waydelich Creek will be required to access roughly 35 percent of the subdivision area. All drainages in the subdivision flow into Auke Bay.

No accurate field survey work has been completed to date and a boundary adjust problem exists with the parcel. Preliminary work indicates that closure of the property boundary is roughly 25 feet off. Due to the dense forest cover a spring survey should be completed to obtain necessary topography and property mapping information. The maps contained in this report were developed from either uncontrolled aerial mapping or are just form lines based on the USGS quadrangle mapping and have been determined not accurate enough for further design or planning work.

There are three options for wastewater disposal for this subdivision; 1) on-site disposal for each lot, 2) a central treatment plant for the subdivision and then off site disposal such as a new deep water outfall in Auke Bay and 3) collection and piping into the City and Borough of Juneau Auke Bay Treatment plant. The last option will be discussed in more detail in this report. The wastewater for the subdivision will need to be transported to the existing sewer line on the west side (Juneau side) of Waydelich creek along the north side of Glacier Highway to an existing manhole. This report will outline the design and cost of the wastewater transport system needed for the proposed subdivision as well as determine estimate wastewater design flows.

2. General Planning Information

The proposed subdivision is zoned by the City and Borough of Juneau as two separate residential areas as shown on the map labeled Figure 1. This figure is shown on the next page and identifies a high and low density residential development areas within the subject parcel. It may be possible to adjust these boundaries and further study and work is needed to make any recommendations in that direction. Any new development most likely will be opposed by the neighborhood, hence making further changes to the zoning boundaries problematic.

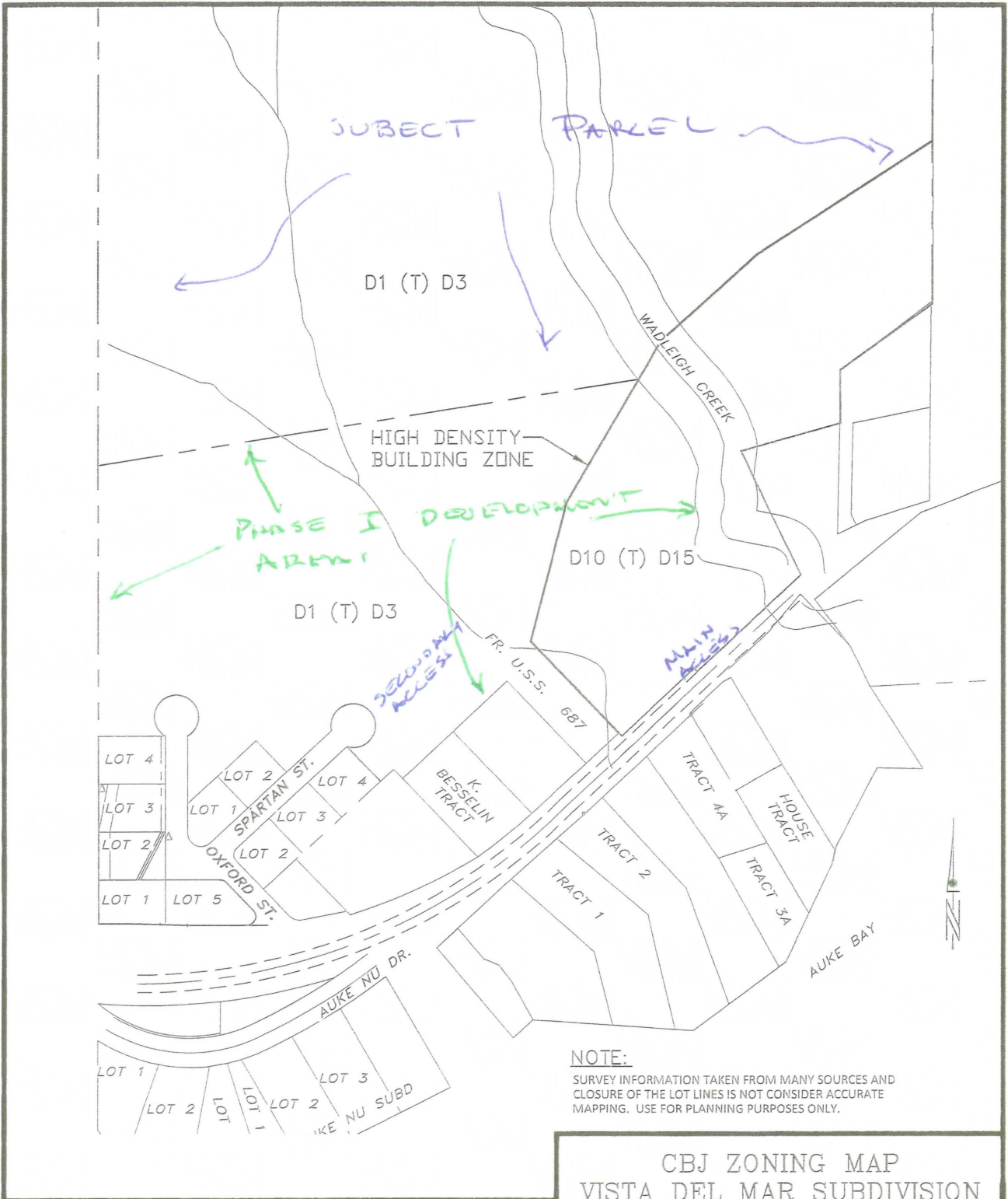

NOTE:
 SURVEY INFORMATION TAKEN FROM MANY SOURCES AND CLOSURE OF THE LOT LINES IS NOT CONSIDER ACCURATE MAPPING. USE FOR PLANNING PURPOSES ONLY.

MOORE ENGINEERING
 P.O. BOX 397 CRAIG, ALASKA 99921 (907) 530-7008

CBJ ZONING MAP
VISTA DEL MAR SUBDIVISION
DURAN CONSTRUCTION
JUNEAU, AK 99801

TRACY MOORE, P.E. REGISTERED PROFESSIONAL CIVIL ENGINEER

DRAWN/CHECKED: GDM/T.M.
 DATE: JULY 2013 SCALE: 1"=300' SHEET: FIG. 1

Waydelich Creek Subdivision

The upper area is zoned as a low density occupancy residential area, D1-D3 (1 to 3 residences per acre depending on the connection to the community water and wastewater services). For the purpose of this study, it has been assumed that a connection to the CBJ wastewater collection and treatment system will be made. There is roughly 100 available acres for use in the upper area (low density). In addition, the CBJ planning restrictions for the development include a green area of 20 percent for the low density area of the subdivision. Making assumptions for roads, a setback to Waydelich creek (150 feet corridor) for building restrictions and free spaces, it has been estimated that approximately 230 homes could be built in this area. The average home would be classified as a 3 bedroom home in this area with 25 percent of the homes having an accessory apartment or 4th bedroom.

The lower area is zoned as a high density occupancy residential area, D10-D15 (10 to 15 residences per acre). Again, it is assumed that a connection to the CBJ wastewater treatment system will be made so the higher value of residential development has been assumed. There is approximately 20 available acres for use in the lower high density area. A green space requirement of 30% is required for the high density portion of the subdivision. Making assumptions for the roads, creek setbacks and green space, it is estimated that a maximum of 180 residential units could be built in the high density area. It is assumed that the units would be split equally between one, two and three bedroom units, which are a conservative estimate for wastewater flow.

3. Site Characteristics

The topographic survey of the site shows that the ground rises from the Glacier Highway at a medium grade of 6 percent. Along higher elevations the grade increases to about 8 percent on an average. There are steep grades associated with the slopes adjacent to the creeks that run through the area and rock outcroppings are visible with steep drop offs making access to some areas more difficult.

Probing the ground surface with a metal rod indicates overburden to 4 to 6 feet is common. There are deeper areas of peat and bare rock outcroppings exposed on the site. Beneath the overburden, it is suspected that loose to dense glacial till material is present with rock beneath the till at a varying depth. Groundwater at the site generally flows downhill towards Auke Bay and the creeks that run through the subdivision drain similarly.

It is suspected that the majority of land is classified as a forested wetland with some areas of riparian wetlands associated with the creeks on the property.

High organic soil and the lack of a well graded substrate make on-site disposal of wastewater problematic. Even with site treatment to secondary standards an on-site disposal is not considered practical for a dense subdivision development plan. This may

Waydelich Creek Subdivision

restrict some areas of the subdivision to D1 development standards if any on-site wastewater is planned. For the purpose of this study all wastewater is assumed to be collected and transported to a community treatment system.

4. Existing AUKE BAY Treatment Facilities

The Auke Bay wastewater treatment plant is located on the shore of Auke Bay directly across Glacier Highway from the Auke Bay School. It has a treatment capacity of 80,000 to 90,000 gallon per day. It has a marine outflow into Auke Bay. According to information obtained from Tom Trego, the Wastewater Utility Superintendent for the City and Borough of Juneau, he indicated that the treatment plant is currently running at 50 to 60 percent capacity.

There is a gravity sewer line 8 inch in size that ends in a manhole on the south end of Wadelich Creek just off the shoulder of the Glacier Highway, shown on the map labeled figure 2.

The 8 inch sewer pipe continues by gravity to the treatment plant and has an estimated capacity of 0.5 MGD.

It has been determined that the existing treatment facilities at Auke Bay are not sufficient to handle all of the wastewater from the proposed Wadelich Creek Subdivision. For this reason, it has been proposed that the subdivision would be constructed in many different phases. The first phase would be to developed access to the area closest to and directly off Glacier Highway and the existing side streets which anticipated the future development of this area by calling out temporary cul-de-sac at each end of the public streets. None of the existing streets conform to current CBJ street standards and upgrades should be anticipated with the development of the subdivision.

The phase one development area would be roughly 22 acres in size and be bounded on the south by the Glacier Highway and existing platted subdivisions, and bounded on the east by the assumed edge of the setback from Wadelich Creek and on the west by the property boundary and on the north on a line shown on the attachment. It would enjoy roughly 4.5 acres in the high density zone (D15) and 17.5 acres in the low density zone (D3). Wastewater flow requirements for the phase one development have been estimated below and it has been determined that the existing facilities at the Auke Bay Wastewater treatment plant could handle the amount of additional wastewater flow from the Phase 1 development.

Waydelich Creek Subdivision

DESIGN ESTIMATES AND REQUIREMENTS

1. Alternatives for connection to the existing sewer system

There are two means for connection to the existing community sewer system. Both would connect into the last existing manhole just east of Wadelich creek and on the north side of the Glacier Highway. They are as follow;

- 1) Municipal sewer connection by gravity.
- 2) Municipal sewer connection by pump station.

Both of these alternatives are shown on the Figure 2 below.

Moore Engineering has conducted a preliminary investigation into the existing geodetic mapping and has concluded that an elevated gravity system and a pump lift station are both feasible options for the sewer extension and collection to the proposed Wadelich Creek Subdivision

2. Occupancy Loading and Estimated Flow

Based on the assumptions listed above for the occupancies listed and using EPA reference materials as well as Water and Wastewater Engineering Design Principles and Practice: Davis, Mackenzie, dated 2010, a wastewater flow rate of 120 gallons per day per bedroom has been used.

For the hydraulic flow a **factor of safety of 1.2** will be used to account for unknowns and estimates, infiltration rates etc.

Phase One Development – roughly 22 acres

Daily wastewater flow estimate

120 gpd x 44 low density area residences x 3 bedrooms	= 5280 gpd
120 gpd x 11 low density accessory residences	= 1320 gpd
120 gpd x 18 high density residences x 1 bedrooms	= 2160 gpd
120 gpd x 17 high density residences x 2 bedrooms	= 4080 gpd
120 gpd x 17 high density residences x 3 bedrooms	= 6120 gpd
Total	= 18960 gpd

Estimated Design flow total daily flow x FS = 22,750 gallons per day

Waydelich Creek Subdivision

Total Wadelich Creek Subdivision Development- roughly 120 acres

Daily wastewater flow estimate

120 gpd x 230 low density area residences x 3 bedrooms	=	27600 gpd
120 gpd x 58 low density accessory residences	=	6960 gpd
120 gpd x 60 high density residences x 1 bedrooms	=	7200 gpd
120 gpd x 60 high density residences x 2 bedrooms	=	14400 gpd
120 gpd x 60 high density residences x 3 bedrooms	=	21600 gpd
Total	=	77,760 gpd

Estimated Design flow total daily flow x FS = 93,120 gallons per day

3) Existing Facility Connection

The existing 8 inch wastewater transport line for the manhole on the south side of Wadelich Creek can handle the increased flow from both the phase 1 and total development estimates. This was confirmed using a check of manning formula and a general rule of thumb.

4) Profile and Gradient Discussion

From the last manhole, the Glacier Highway has a negative grade (falls away) from the invert elevation of the manhole. The map labeled figure 3ows a planned of the road and to a possible subdivision access. This map also shows a potential location of both a gravity connection and a pressure line or pump station from the subdivision. Due to the grade of Glacier Highway and the location of the existing sewer line, the gravity line will be located uphill within the subdivision then crosses Wadelich Creek via an elevated bridge structure using arctic pipe for the gravity connection.

E:\proj\moore\Drawings\Drawings\01\144845.dwg 7/11/2013 14:45:45 AM SST 021 Drawings (6/2) 106-3798 (6/2) 106-3801 (6/4)

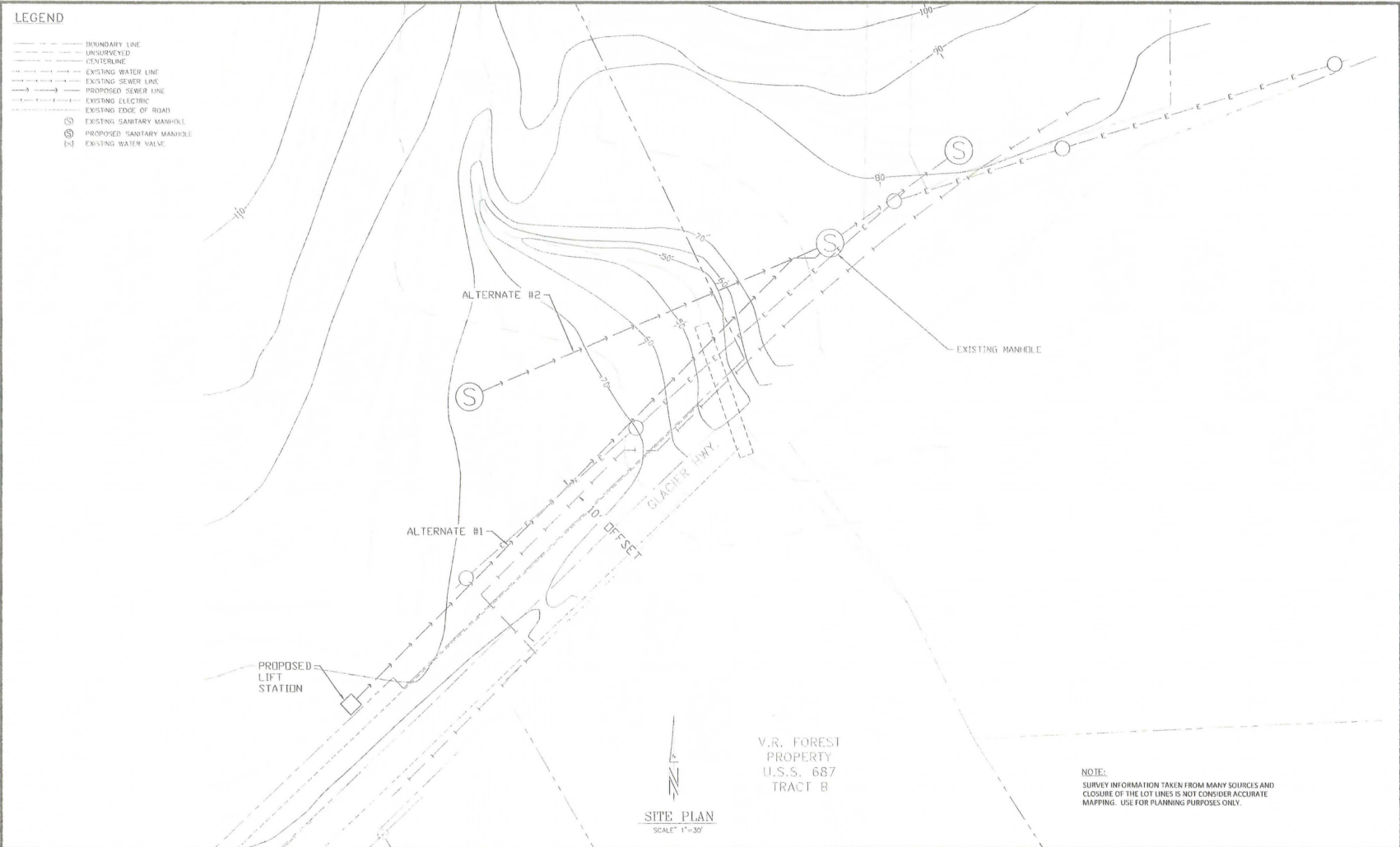

MOORE ENGINEERING
 P.O. BOX 397 CRAIG, ALASKA 99921 (907) 530-7008
 TRACY MOORE, P.E. REGISTERED PROFESSIONAL CIVIL ENGINEER

REVISIONS

PRELIMINARY ALTERNATE
 WASTEWATER TRANSPORT
 VISTA DEL MAR SUBDIVISION
 DURAN CONSTRUCTION
 JUNEAU, AK 99801

DRAWN/CHECKED
 GDM/T.M.
REVISION

DATE
 JULY 2013
SHEET
 FIG. 2



*pages 21 26
 25 27*

PAGE 9

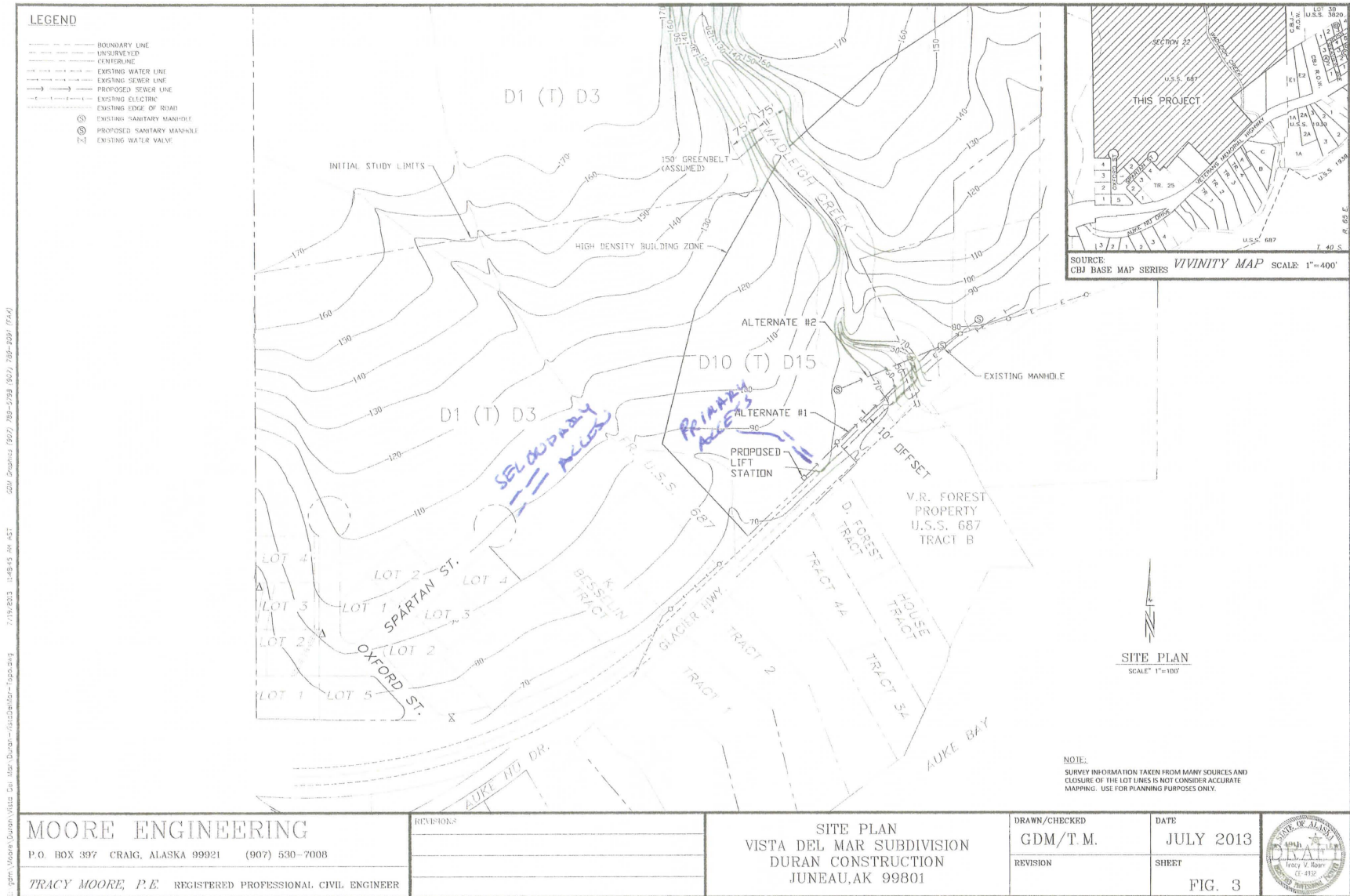

1/19/2013 1:58:45 AM 45T 0201 Drawings (2013) 288-5288 (2013) 288-2981 (254)

PAGE 10

Waydelich Creek Subdivision

COST ESTIMATE

The estimated initial capital cost for each wastewater transport alternative was estimated for planning purposes.

Gravity Sewer Line \$390,000

- 300 LF 8 inch PVC sewer line
- 150 LF 10 inch Arctic sewer line (sliding 8 inch through)
- 4 Elevated support structures (long span 50 feet)
- 2 Transition Joints Arctic Pipe to PVC
- 1 Manhole Connection
- 1 New Manhole

The crossing of Wadelich Creek would be in an exposed Arctic pipe insulated and with a protective covering. The supports would be steel A-frame type and connections on each end would be anchored and mechanically restrained. It may be possible to reduce the span by constructing MSE walls that encroach into the creek banks but stay clear of the high water zone (permit area). As shown on the sketch, the line would align northwesterly from the last CBJ manhole on Glacier Highway.

Pressure Sewer Line \$760,000

- 400 LF 6 inch HDPE Sewer Line
- Pump Station CBJ standard w/ scada
- Separation protection from existing Water Line
- 1 Manhole Connection
- 1 Electrical Service

Because Glacier Highway drops from the last manhole it is not possible to achieve a gravity line from the most likely access point to the subdivision. The pump station would be located in the highway right of the way on the north side of Glacier Highway and a 4 or 6 inch pressure line would be used to pump the raw wastewater to the last manhole as referenced above. The pressure line would conflict with a portion of the existing waterline on the north side of Wadelich Creek. After that conflict area the water line crosses the Glacier Highway and is located on the south side of Glacier Highway.

Life cycle cost estimates are not included for these planning estimates but would be higher for the pressure system than the gravity system. Further refinement is needed once an overall development plan is formulated and site development, preliminary engineering and surveying work completed.

Additional reference mapping is shown on the following pages:



Map current as of January 30th, 2015



Auke Bay to Tee Harbor ZONING MAP

ZONING DISTRICTS		
D1 Single Family & Duplex	I Industrial	D1(T)D3
D3 Single Family & Duplex	MU Mixed Use	D1(T)D5
D5 Single Family & Duplex	MU2 Mixed Use	D1(T)D15
D10 Multi Family	WC Waterfront Commercial	D10(T)D18
D15 Multi Family	WI Waterfront Industrial	D3(T)D5
D16 Multi Family	RR Rural Reserve	D3(T)D16
LC Light Commercial	RR(T)D15 Transition Zones	D5(T)D16
GC General Commercial	RR(T)D3	D5(T)D18

Disclaimer:
 This map was prepared, has been used, and is distributed by the City and Borough of Juneau, Alaska (CBJ). The CBJ makes no warranty, expressed or implied, nor does it assume any legal responsibility for the accuracy, completeness, or usefulness of any information, apparatus, product, or process disclosed in this map. The CBJ does not represent that use of this would not infringe private rights.

Reference in this map to any commercial product, process, or service by trade name, trademark, manufacturer, or otherwise does not constitute or imply an endorsement by CBJ. Use of this map by any person constitutes agreement by that person to the foregoing paragraph.

These terms may be changed, suspended, or revoked only in writing signed by the City and Borough Manager or the City and Borough Director of Community Development Department.



Suggestions for corrections and improvements to the CBJ zoning map should be directed to:

Geographic Information Systems
 215 E. Juneau Avenue
 Juneau, Alaska 99701-555-6752

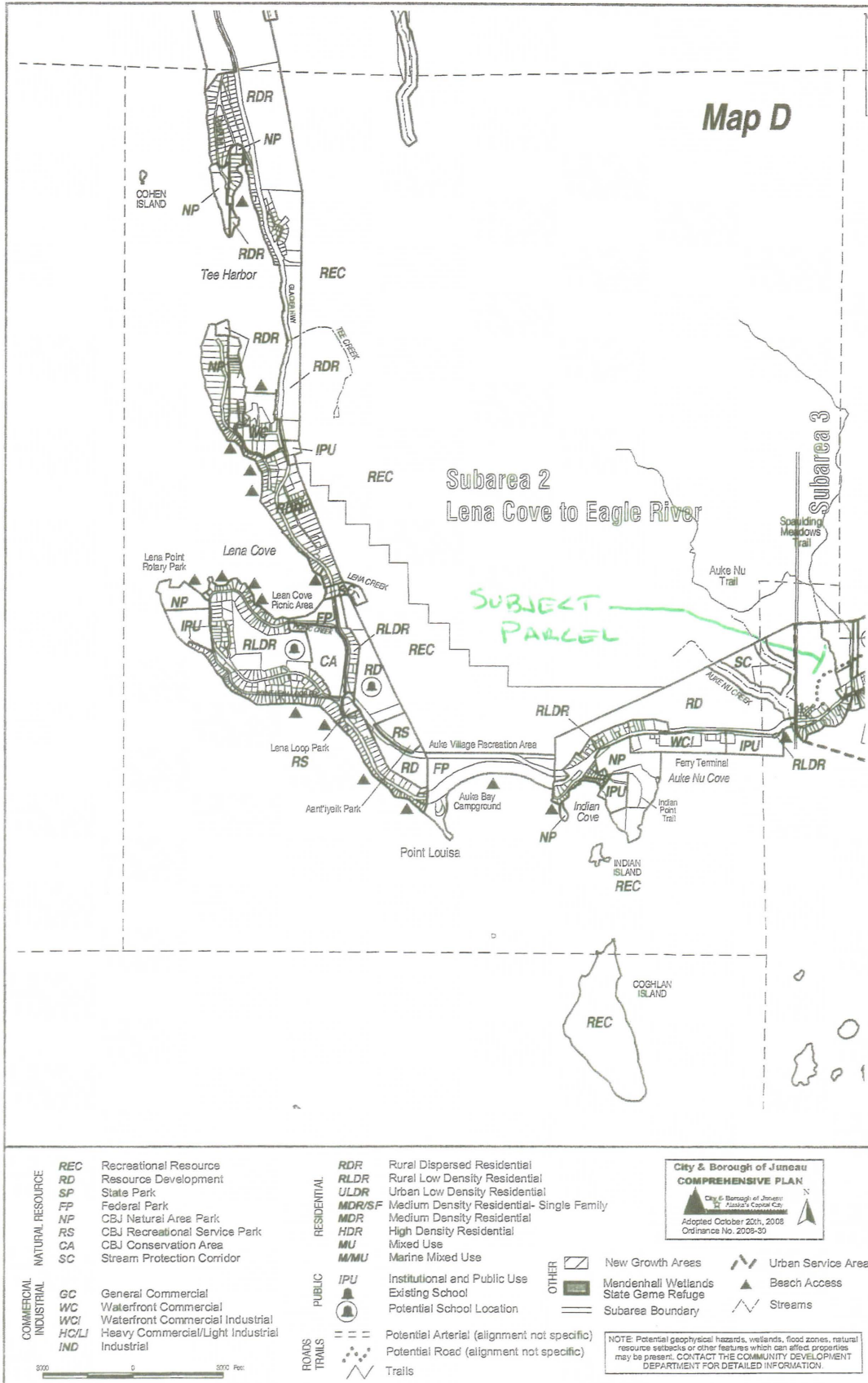

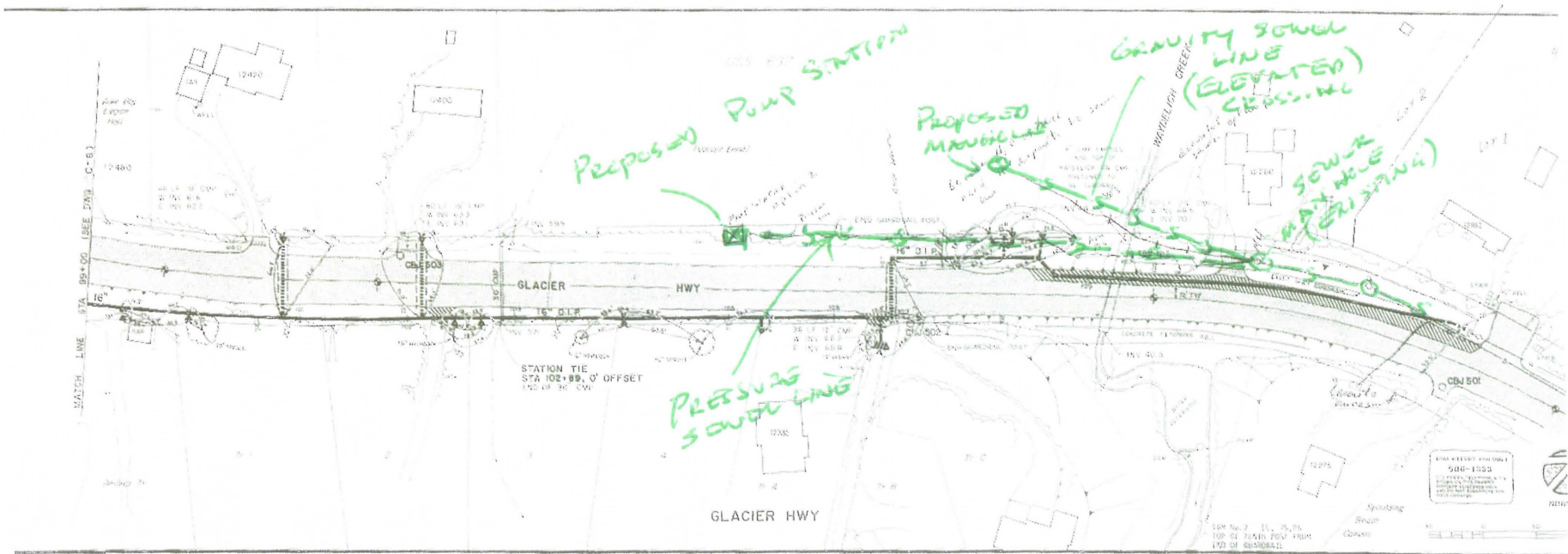



REVISIONS BY DATE PRINTED		CITY AND BOROUGH OF JUNEAU DEPARTMENT OF ENGINEERING JUNEAU AREAWIDE WATER SYSTEM		JAMES M. MONTGOMERY CONSULTING ENGINEERS, INC. 712 WEST 12th STREET JUNEAU ALASKA 99901 586-4447	INDIAN POINT GLACIER HWY STA 99+00 TO STA 112+74	DRAWING C-C SHEET # 15 OF 1 CBJ FILE NO. 86
DRAWN: [] DESIGNED: [] CHECKED: []		DATE: MAY, 1999 JOB No. 95-0980 SCALE: GRAPHIC				

Attachment I - 2013 Waydelich Sewer Extension Feasibility Study

STATE	PROJECT DESIGNATION	YEAR	SHEET NO.	TOT. SHEETS
ALASKA	F-053-2(8)	1979	26	47

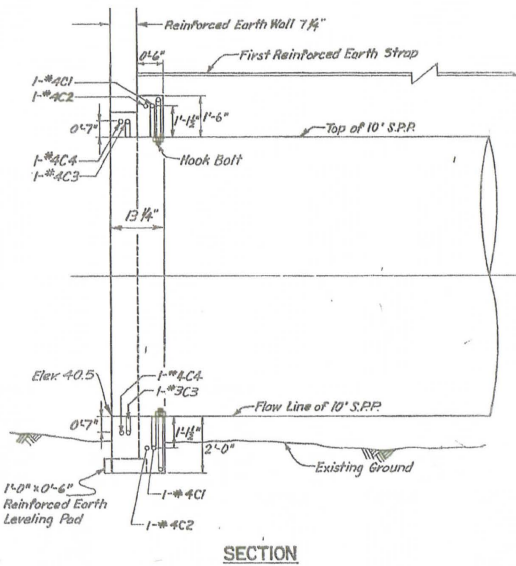
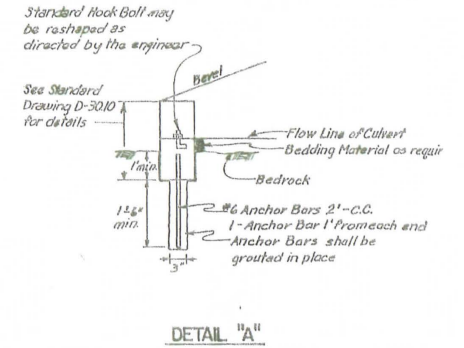
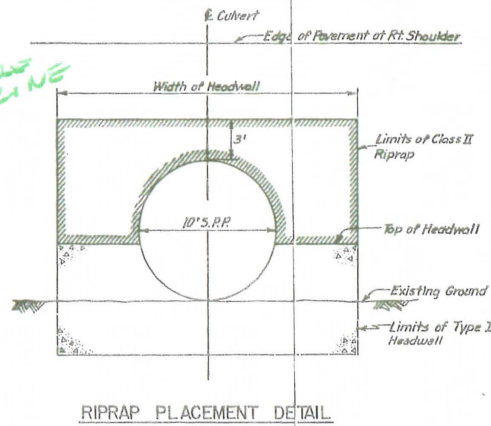
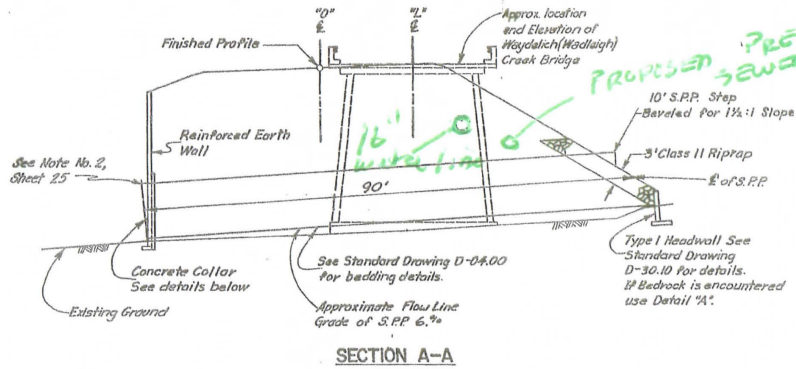

CONCRETE COLLAR DETAILS

