

DEVELOPMENT SUMMARY

Total Property Acreage	+/- 243.3 Ac
Total Wetlands	+/- 60.1 Ac
Impacted Wetlands	+/- 0.3 Ac
Preserved Wetlands	+/- 59.8 Ac
Required Open Space (25%)	+/- 60.8 Ac
Additional Wetlands	+/- 29.4 Ac
Developable (Net Land Area)	+/- 153.1 Ac

Max. Number of Residential Units **438 du**

Unit Type: **Single Family - Detached**

Unit Sizes:

60' x 120'

80' x 120'

OPEN SPACE ACREAGE¹

Required (Min 25%) +/- 60.8 Ac

Provided (28.0%) +/- 67.4 Ac

Stormwater +/- 25.7 Ac

Misc. Open Space +/- 11.3 Ac

Wetlands² +/- 30.4 Ac

Public Recreation³ +/- 7.2 Ac

RESIDENTIAL ACREAGE

Required (Max. 85%) +/- 130.0 Ac

Provided (85%) +/- 130.0 Ac

NOTES:

- Amenities, multimodal trail, and additional open space areas located in Non-Residential tracts are not included in required Open Space calculations.
 - Up to 50% of required Open Space can be from Preserved Wetland.
 - Min. 10% of usable Open Space has to be designated as Public Recreation.
 - The community will feature complimentary architectural styles including craftsman, bungalow, Florida cracker, low country, Florida vernacular, or similar.
 - Trees preservation will be in accordance with LDC 711.02 and 711.03
- * Future Potential Access Connections will be provided subject to obtaining legal access from adjacent parcels.

LOCATION MAP



LEGEND

- Public Recreation Area
 - Pedestrian Paths
 - Multimodal Trail
 - End-cap Parallel Parking
 - ROW Reservation
 - Trail Head Site (Civic)
 - Amenity/Mini Parks
 - Neighborhood Park
 - Stormwater
 - Wetlands
 - Mis. Open Space
- #### FLOOD ZONE
- A
 - AE

Copyright RVI



MISSION RISE • CONCEPTUAL PLAN

Town of Howey Hills, FL

February 14, 2024

22003786

Turnstone Group / ASF TAP FL I LLC.

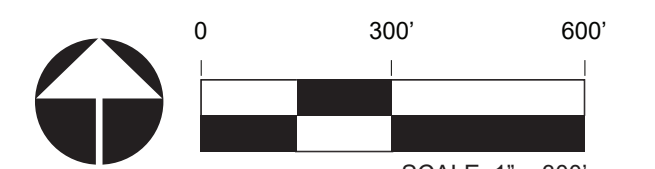

The plan is conceptual in nature. Final details, layout, development parameters, calculations, and site conditions may change upon further development of the Preliminary and/or Master Site Plans, and upon evaluation of topographic survey, water management and existing historic and specimen trees to remain.

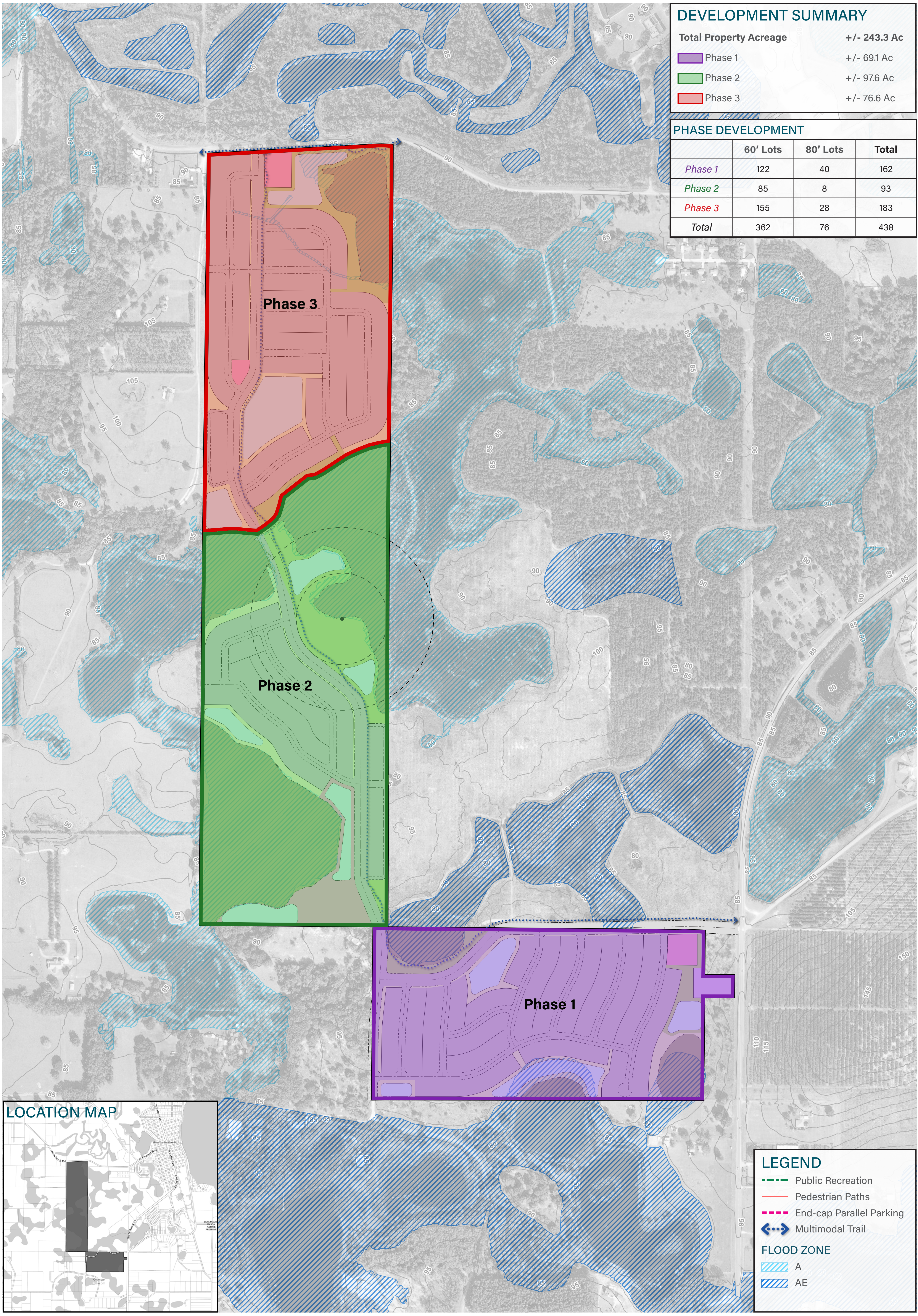

DEVELOPMENT SUMMARY

Total Property Acreage	+/- 243.3 Ac
Phase 1	+/- 69.1 Ac
Phase 2	+/- 97.6 Ac
Phase 3	+/- 76.6 Ac

PHASE DEVELOPMENT

	60' Lots	80' Lots	Total
Phase 1	122	40	162
Phase 2	85	8	93
Phase 3	155	28	183
Total	362	76	438

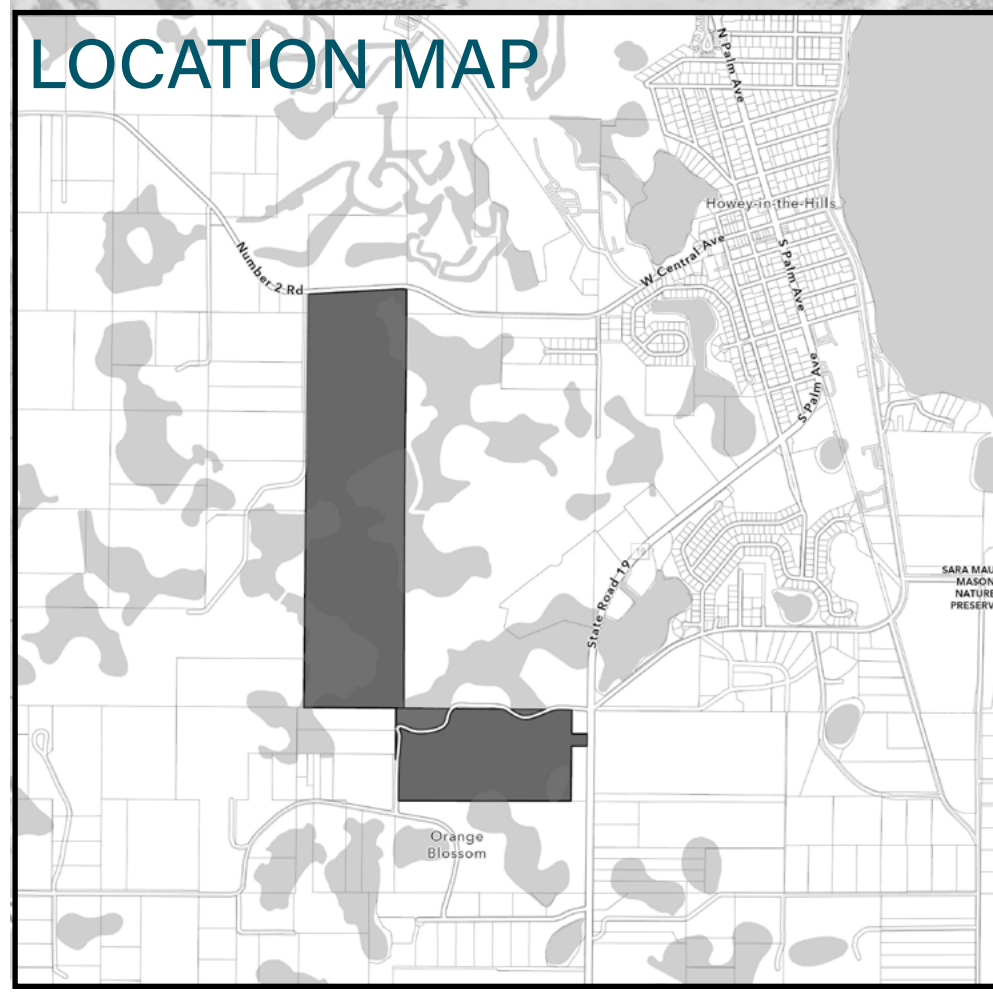

LEGEND

- Public Recreation
- Pedestrian Paths
- End-cap Parallel Parking
- Multimodal Trail

FLOOD ZONE

- A
- AE

PARK & AMENITY FEATURES

Amenity / Park	Acreage	Access Restrictions	Minimum Features
Trail Head Site	1.3 Ac	Public	Restrooms, benches, picnic tables, bike repair station, cooling station, pet station(s)
Trail Head Park	0.6 Ac	Public	Benches, pathway(s)
Amenity 1	1.2 Ac	Private	Dog park or tot lot; flex lawn, benches, picnic table(s)
Amenity 2	4.0 Ac	Private	Pool & Cabana, Pickball Court(s), tot lot, flex lawn, pet station(s), pathways, gathering area
Neighborhood Park 1	2.2 Ac	Public	Benches, picnic table(s), exercise station(s), flex lawn, pet station, gathering area
Neighborhood Park 2	8.2 Ac	Public	Benches, picnic table(s), flex lawn, pathways, exercise station(s), gathering area, pet station(s)
Mini Park	0.4 Ac	Private	Benches, picnic table(s), flex lawn, pet station, gathering area
Neighborhood Park 3	3.9 Ac	Public	Benches, picnic table(s), flex lawn, pathways, gathering area, pet station(s)
Amenity 3	1.2 Ac	Private	Dog park or tot lot; flex lawn, benches, picnic table(s)
Total	23.0 Ac		

Note: Features may be change with the approval of the Town Council during the Subdivision Plan process without necessitating a change to these plans.

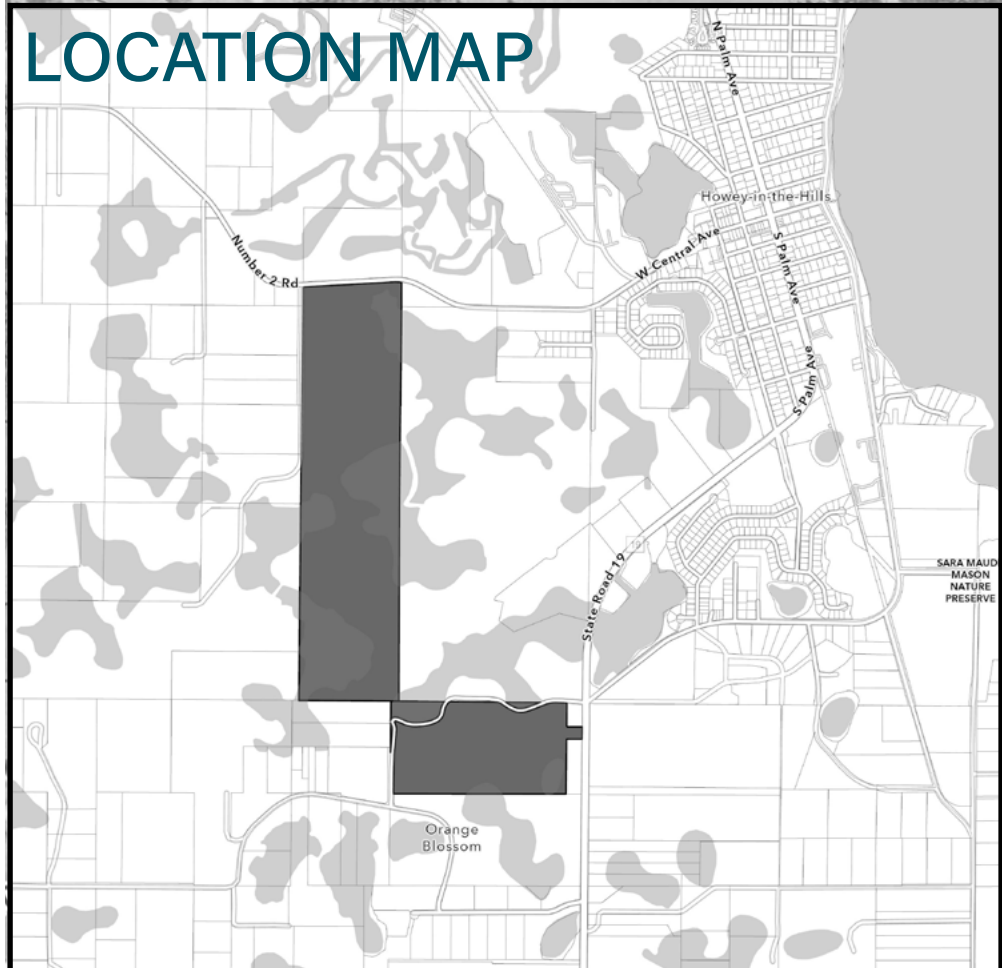
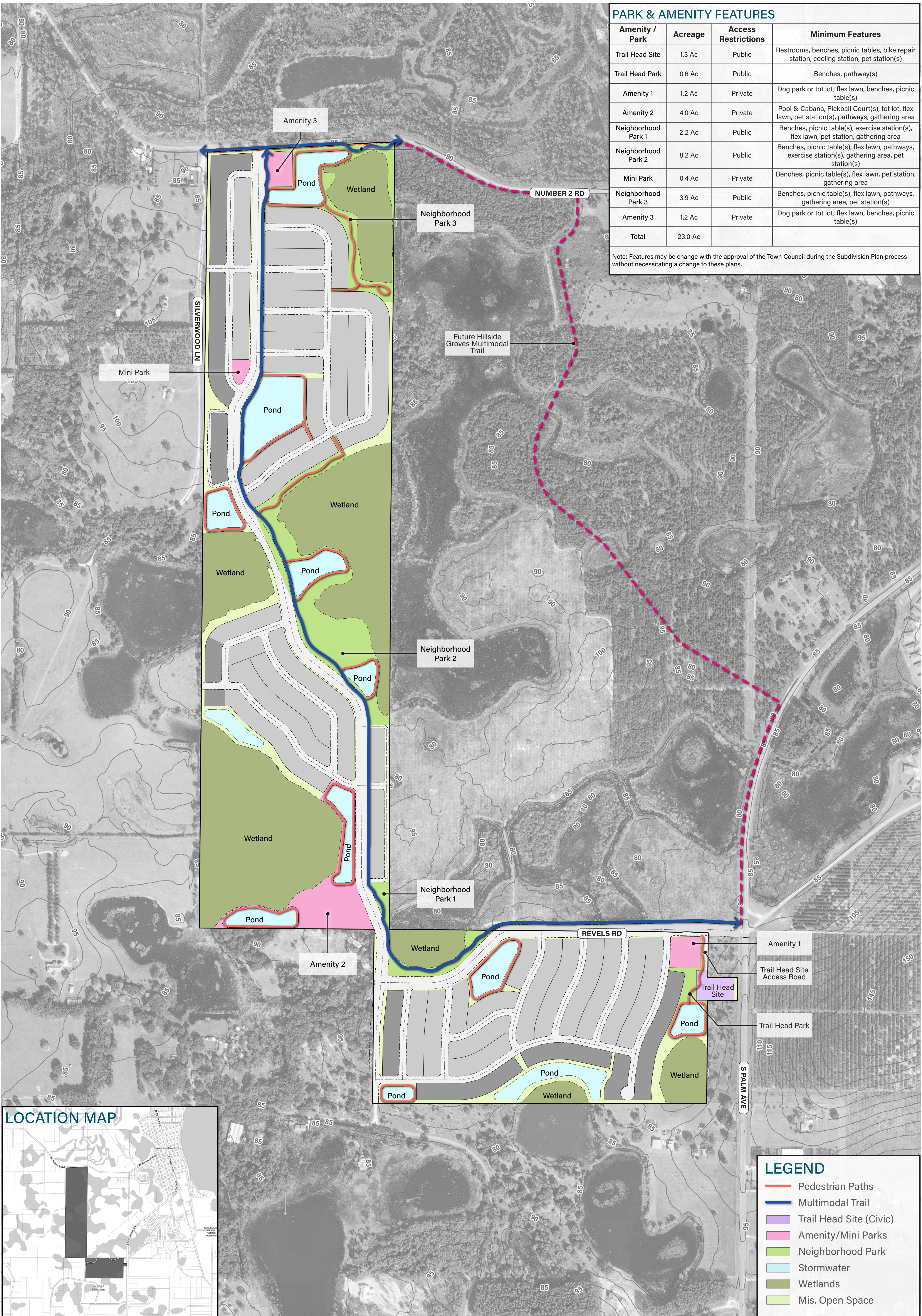

LEGEND

- Pedestrian Paths
- Multimodal Trail
- Trail Head Site (Civic)
- Amenity/Mini Parks
- Neighborhood Park
- Stormwater
- Wetlands
- Mis. Open Space

Copyright RVI



MISSION RISE • PARKS, TRAILS & OPEN SPACE PLAN

Town of Howey Hills, FL
 February 14, 2024
 22003786
 Turnstone Group / ASF TAP FL I LLC.

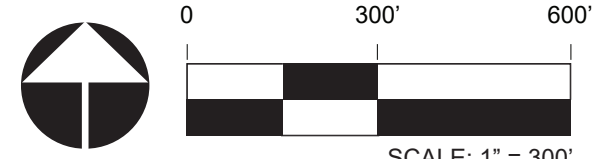

The plan is conceptual in nature. Final details, layout, development parameters, calculations, and site conditions may change upon further development of the Preliminary and/or Master Site Plan, and upon evaluation of topographic survey, water management and existing historic and specimen trees to remain.

NON-RESIDENTIAL ACREAGE

Required (Min 15%)	+/- 23.0 Ac
Provided (15%)	+/- 23.0 Ac
Civic (Required 5%)	+/- 1.3 Ac
Amenities ¹	+/- 6.8 Ac
Neighborhood Park System	+/- 14.9 Ac
Regional Multimodal Trail	+/- 1.5 Ac

NOTES:

- Amenities, multimodal trail, and additional open space areas located in Non-Residential tracts are not included in required Open Space calculations.
- Ponds located inside Neighborhood Parks are not included in the Non-Residential acreage.

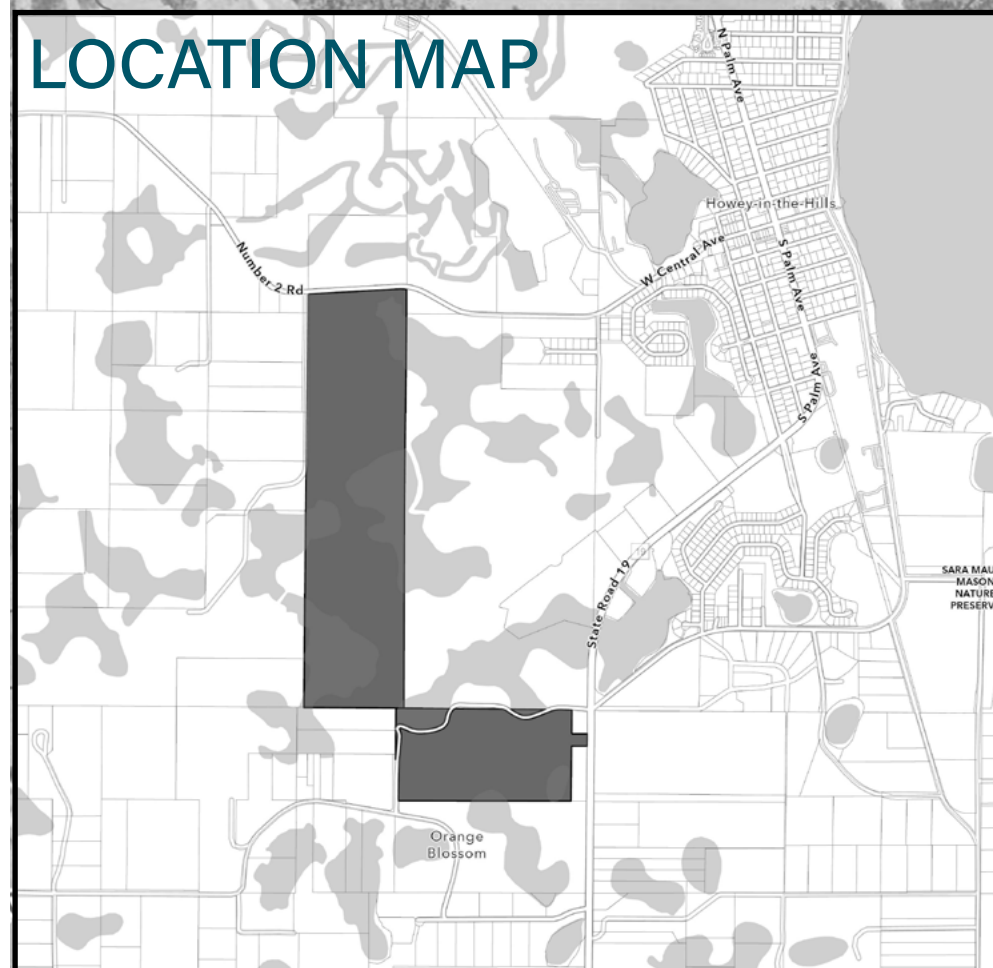
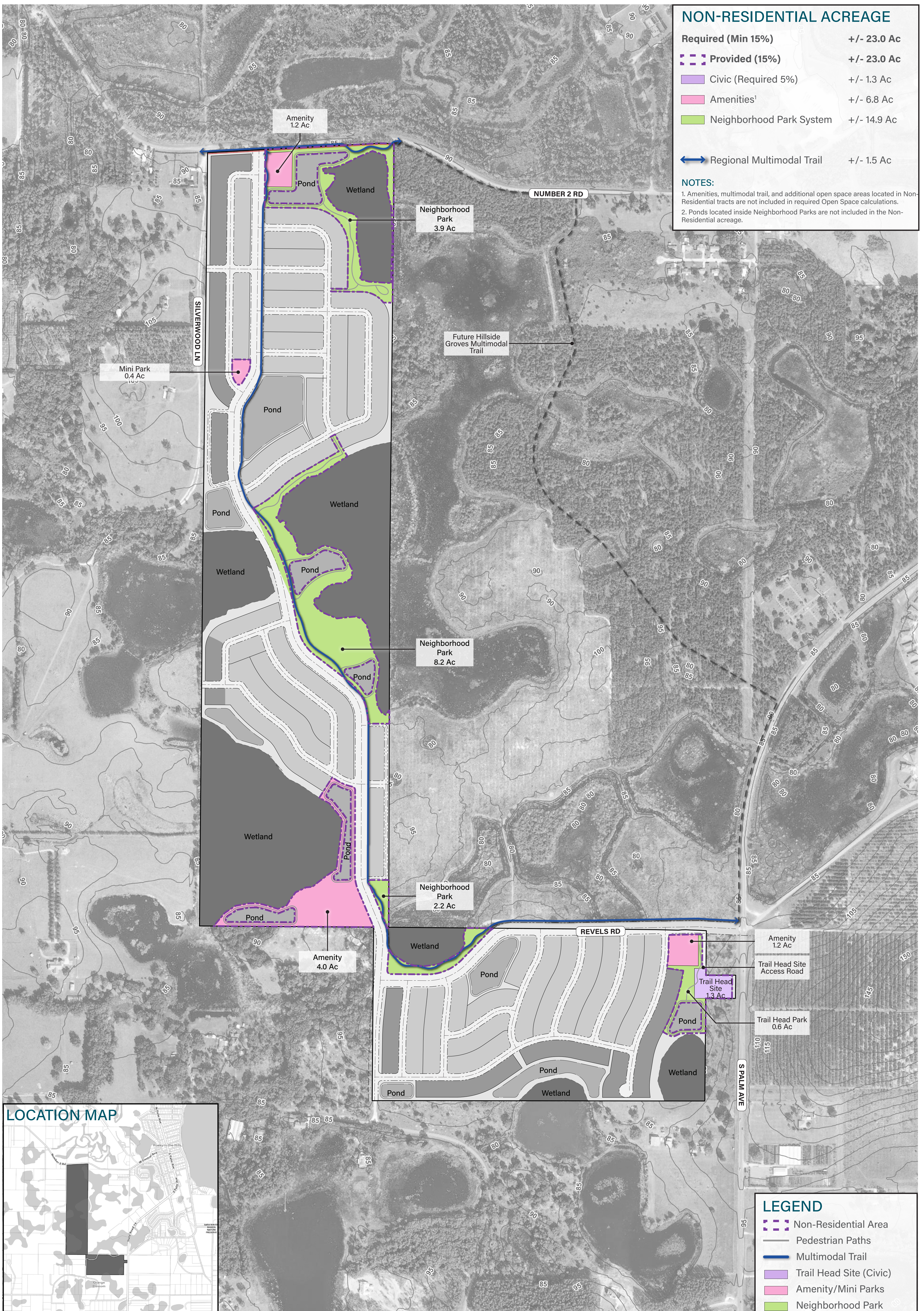

LEGEND

- Non-Residential Area
- Pedestrian Paths
- Multimodal Trail
- Trail Head Site (Civic)
- Amenity/Mini Parks
- Neighborhood Park

RESIDENTIAL BUFFERS

25' LANDSCAPE BUFFER, TYPICAL

A landscaped berm with a total depth of at least 25 feet and no steeper than 3H:1V. The berm shall be at least three feet (3') in height and the berm together with the landscaping, shall comprise a continuous screen of at least 5 and one half feet (5.5') at time of planting and six feet (6') within one year of planting. Canopy trees shall also be planted every 50 feet along the berm.

For single family subdivisions, these buffers shall be on common property and dedicated to the homeowners' association for ownership and maintenance responsibilities.

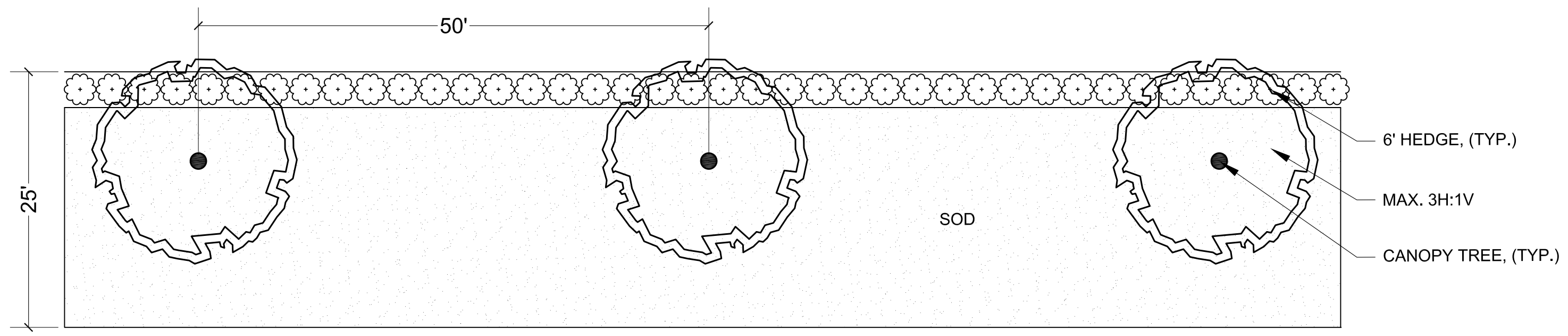

15' LANDSCAPE BUFFER, TYPICAL

A landscaped wall buffer with a minimum depth of 15 feet. The wall shall maintain a height of six feet (6') from grade on highest side and all walls shall have a decorative exterior (no exposed block). Acceptable materials for wall faces are brick, stucco or stone or a combination of those materials. Wall columns shall have a maximum spacing of thirty feet (30') on walls up to two hundred feet (200') in length and forty feet (40') on walls more than two hundred feet (200') in length. Wall columns may extend up to two feet (2') above the height of the wall.

Within each fifty-foot (50') increment along the wall, two (2) canopy trees, two (2) understory trees, and 30 linear feet of shrubs shall be planted. The trees shall not be closer than five feet (5') to a walk or wall. The shrubs shall be at least 30" in height at time of planting.

For single family subdivisions, these buffers shall be on common property and dedicated to the homeowners' association for ownership and maintenance responsibilities.

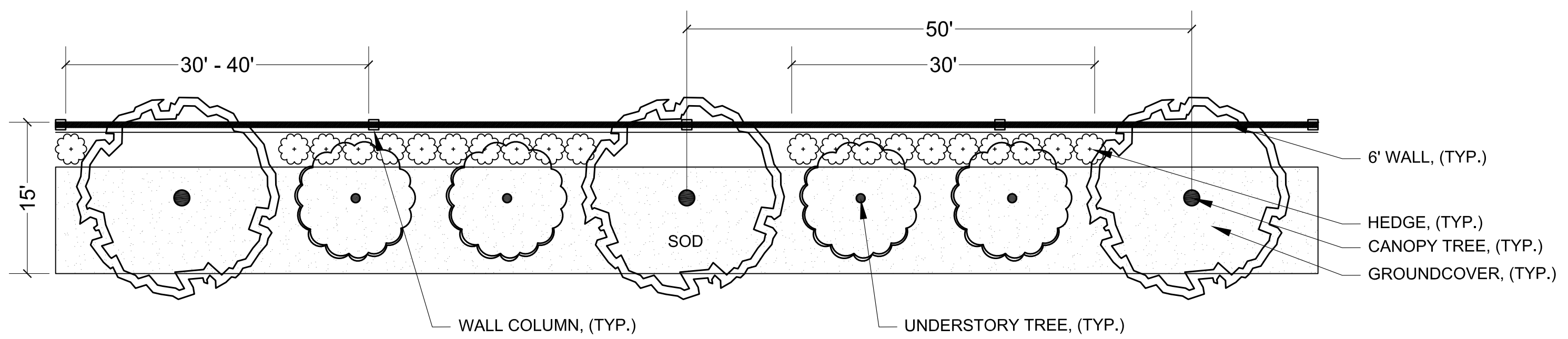

10' LANDSCAPE BUFFER, TYPICAL

Ten-foot-wide (10') landscaped buffer with trees spaced no more than 50 feet on center.

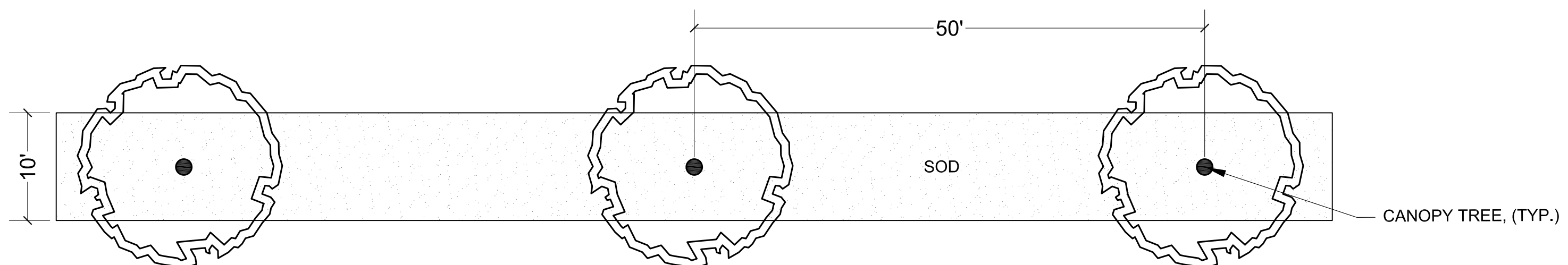

NON-RESIDENTIAL BUFFERS

15' LANDSCAPE BUFFER, TYPICAL

The landscaped buffer shall contain at least one (1) canopy tree, two understory trees and 30 linear feet of shrubs and ground cover for each 50 linear feet of buffer. Canopy trees shall be located no less than five feet (5') and no more than eight feet (8') from sidewalks and other walkways in order to provide shade while minimizing conflicts between tree roots and sidewalks. Similarly, canopy trees shall be used to shade parking areas that adjoin buffers. Understory trees may be planted in groupings and palms may be planted in place of understory trees when clustered in groupings of three or more trees.

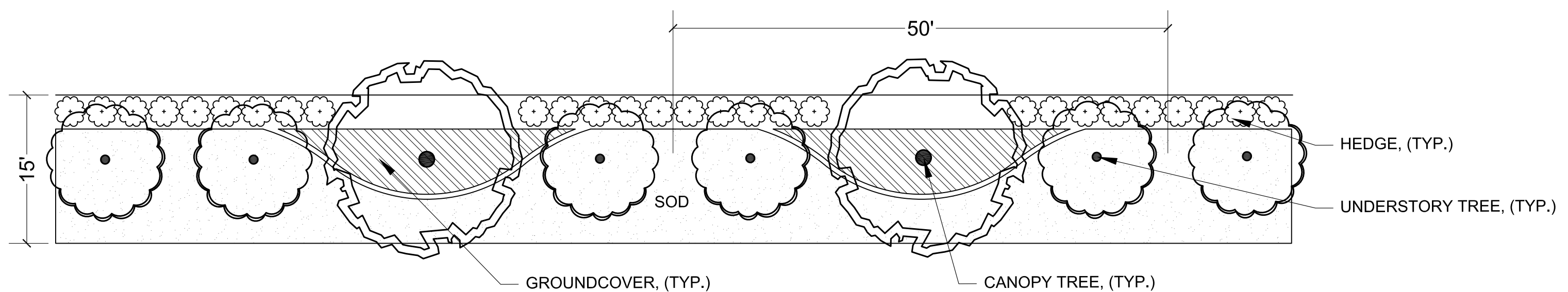

SPINE ROAD

90' ROW WITH BIKE LANE & 12' MULTIMODAL TRAIL

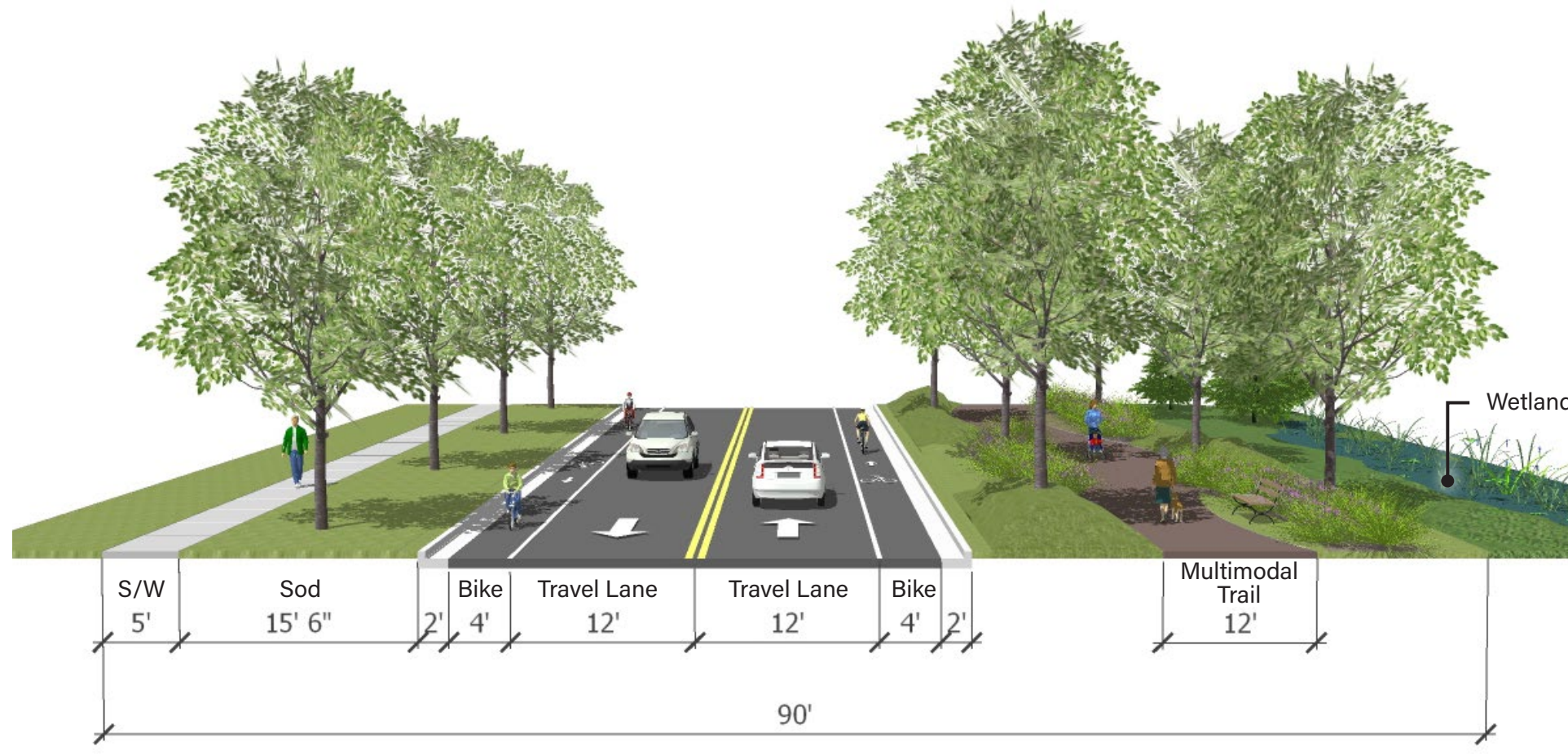

NOTE:

Multimodal Trail is intended to meander in and out of the proposed ROW. Final location may vary based on grading, utilities & final engineering.

NEIGHBORHOOD ROAD OPTION 1 - 50' ROW

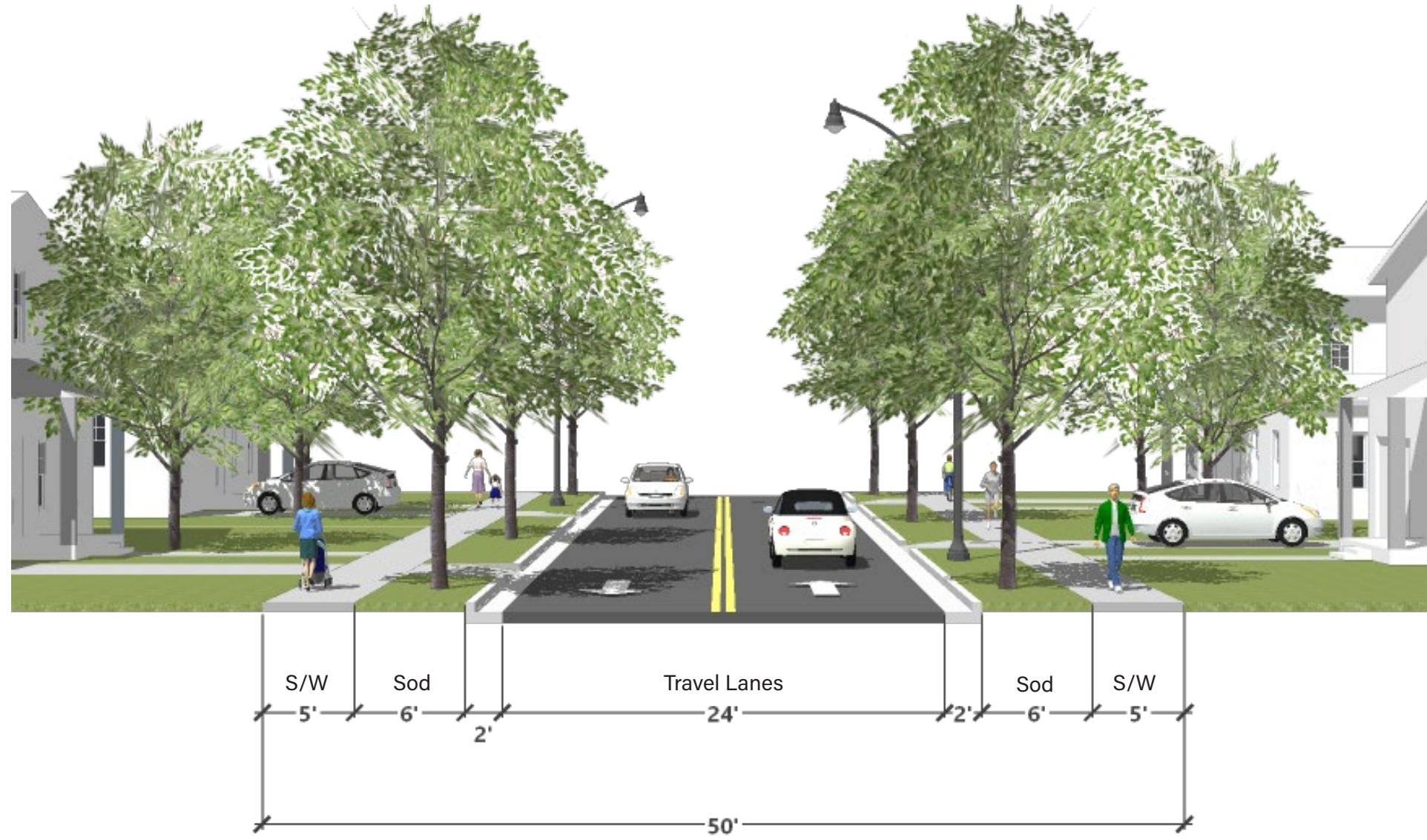

OPTION 2 - 50' ROW WITH PARKING ON ONE SIDE

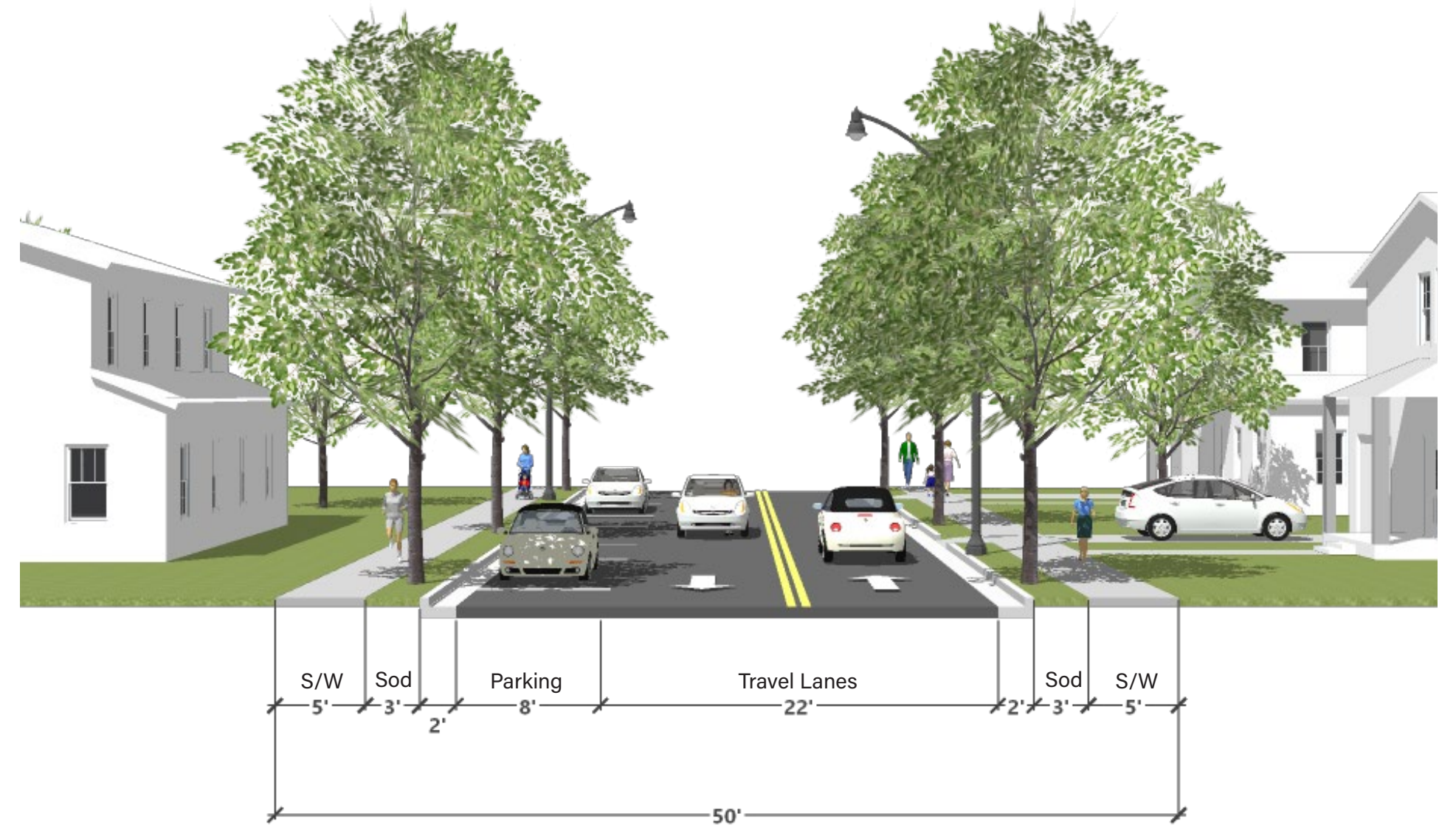

ALLEY ROAD

OPTION 1 - PARALLEL 24' ROW

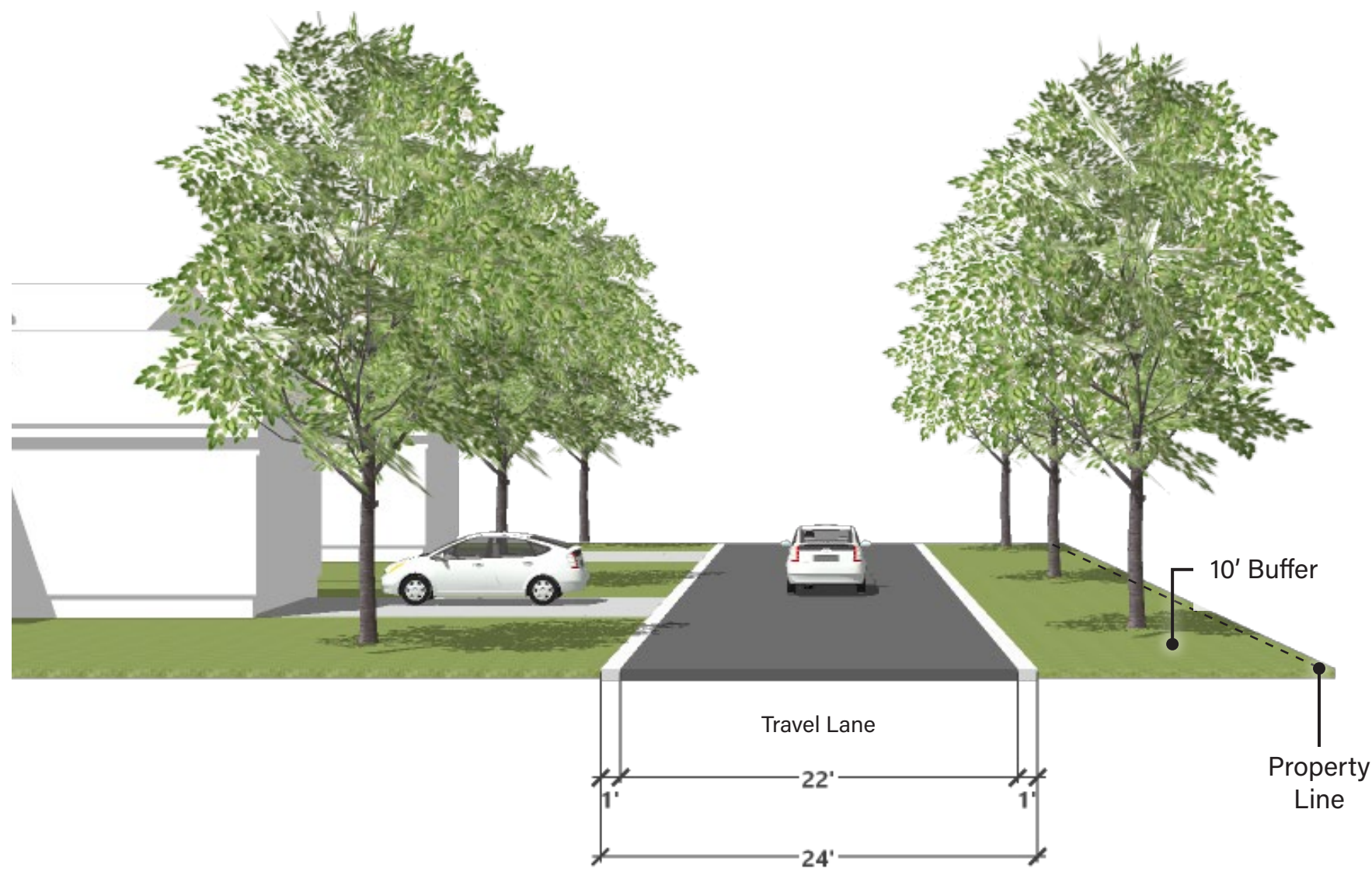

OPTION 2 - PAIRED 24' ROW

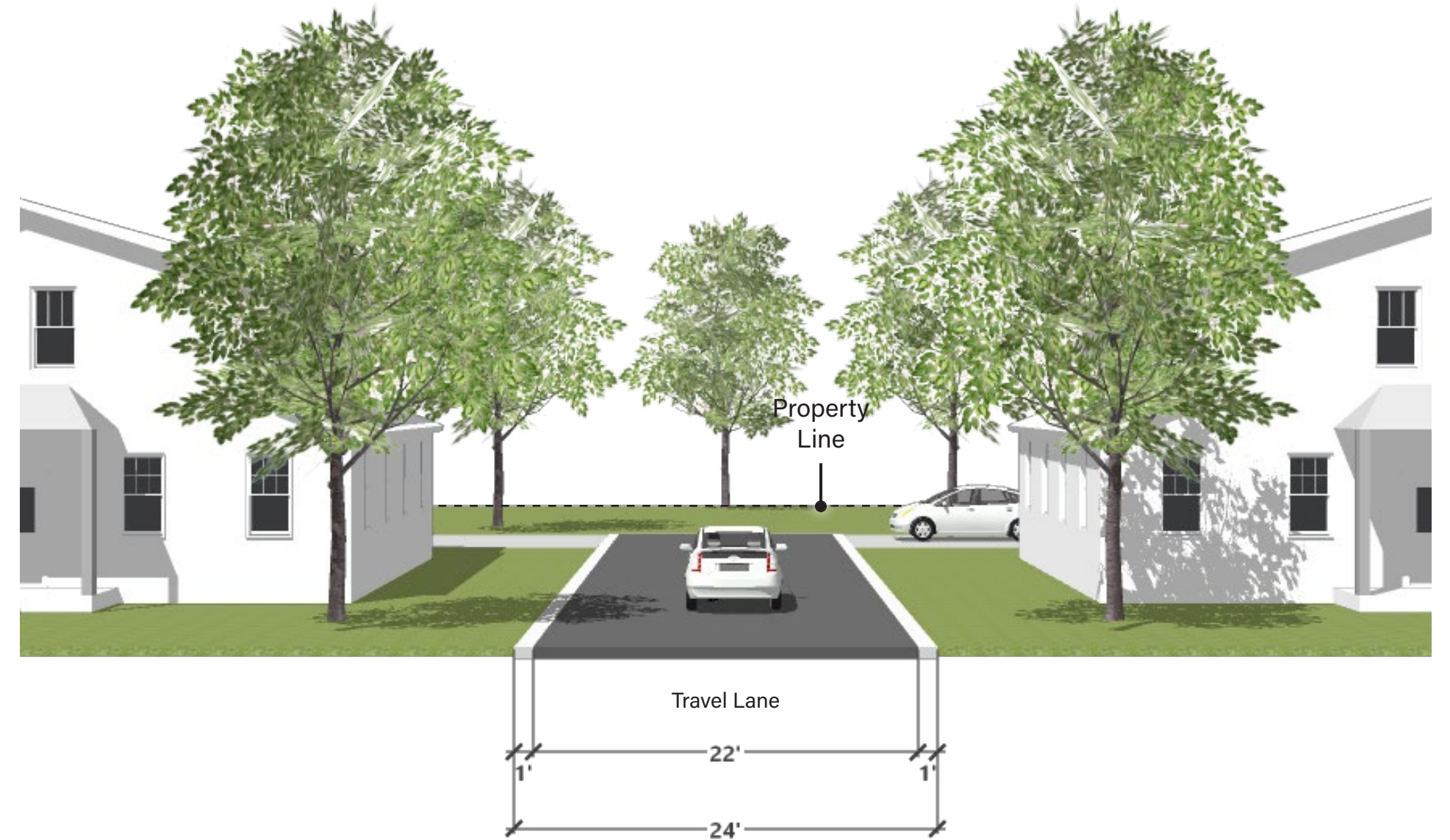

PEDESTRIAN PATH 6' TRAIL

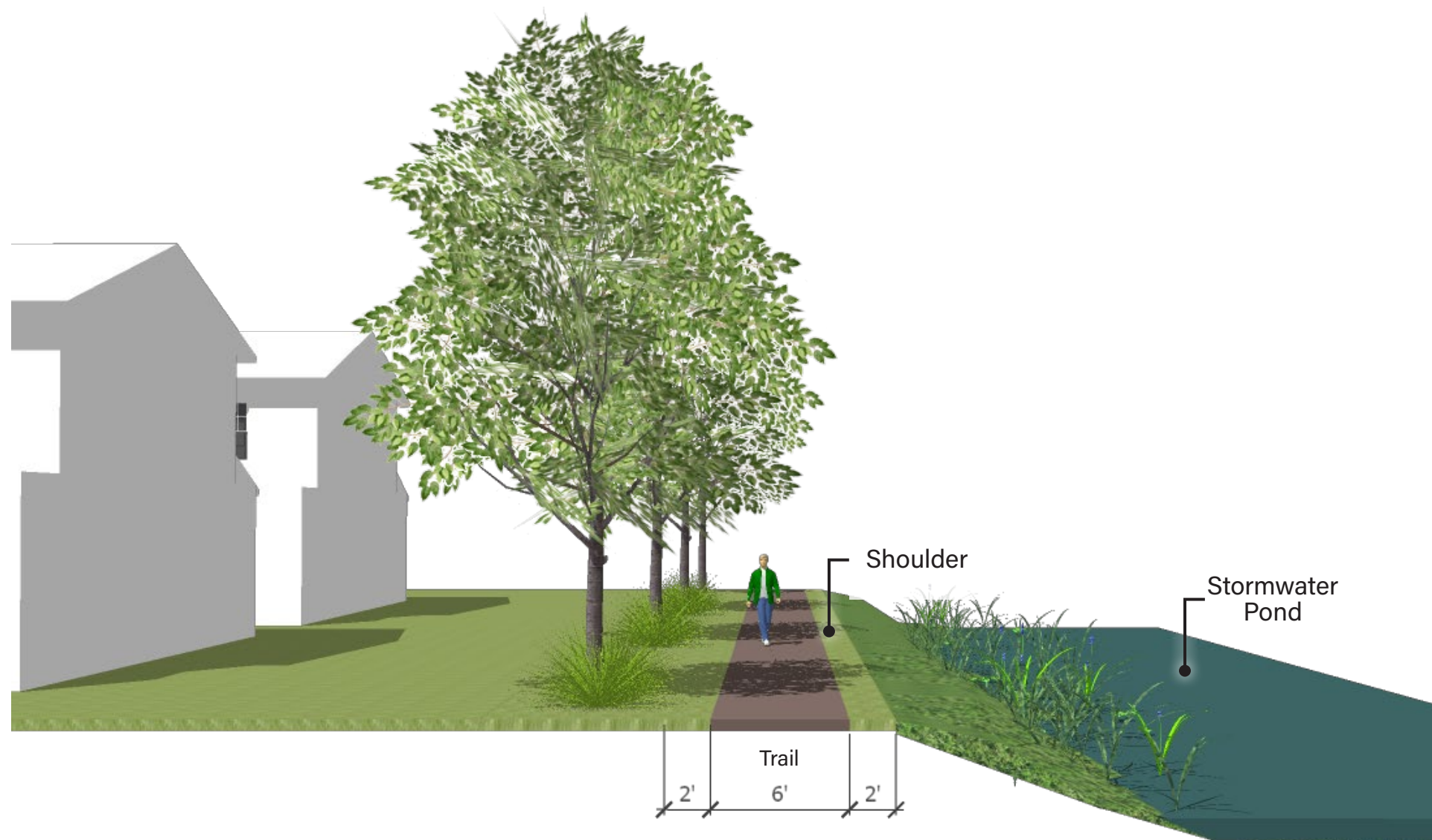

Copyright RVI

60' LOT FRONT LOAD GARAGE

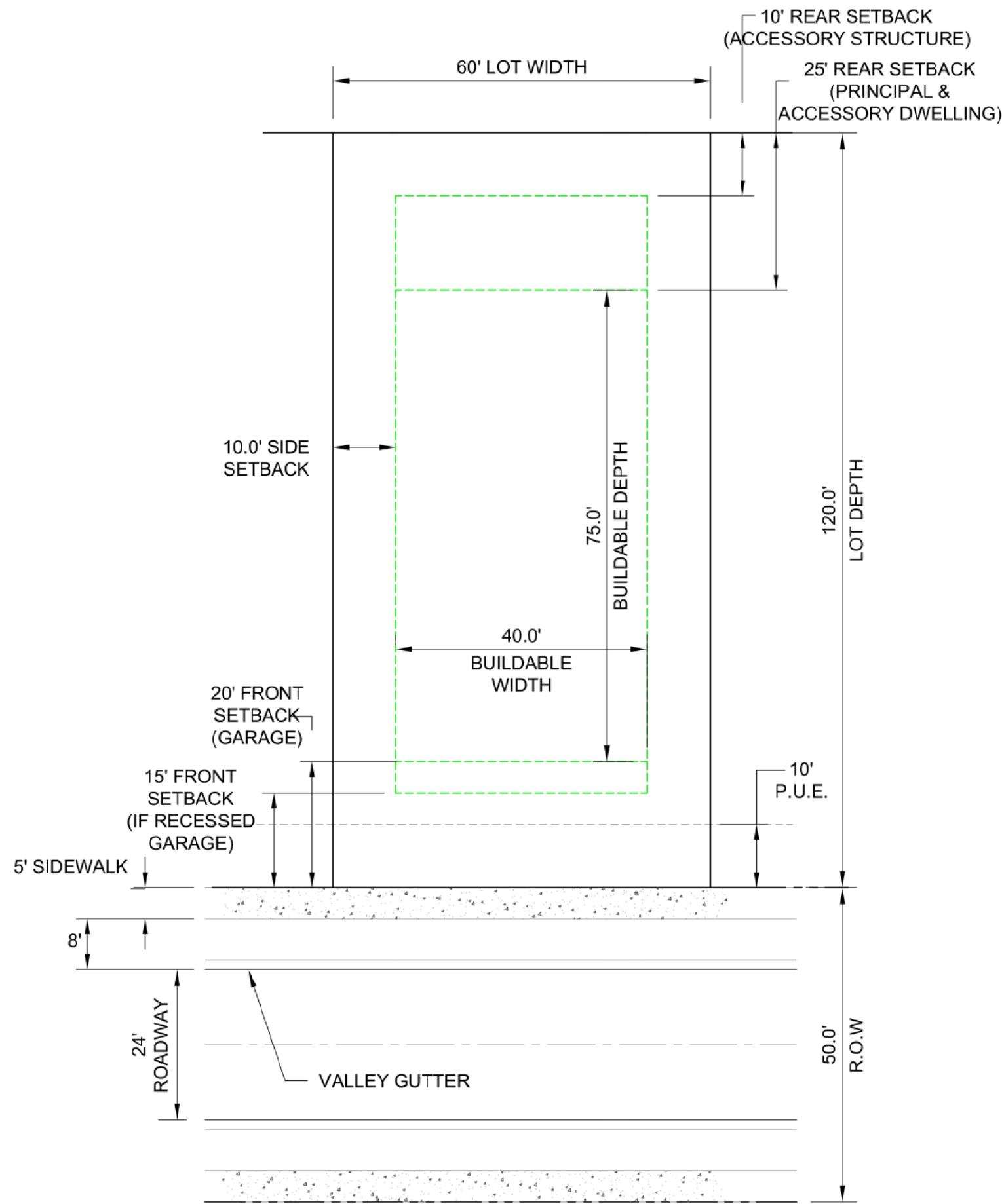

80' LOT FRONT LOAD GARAGE

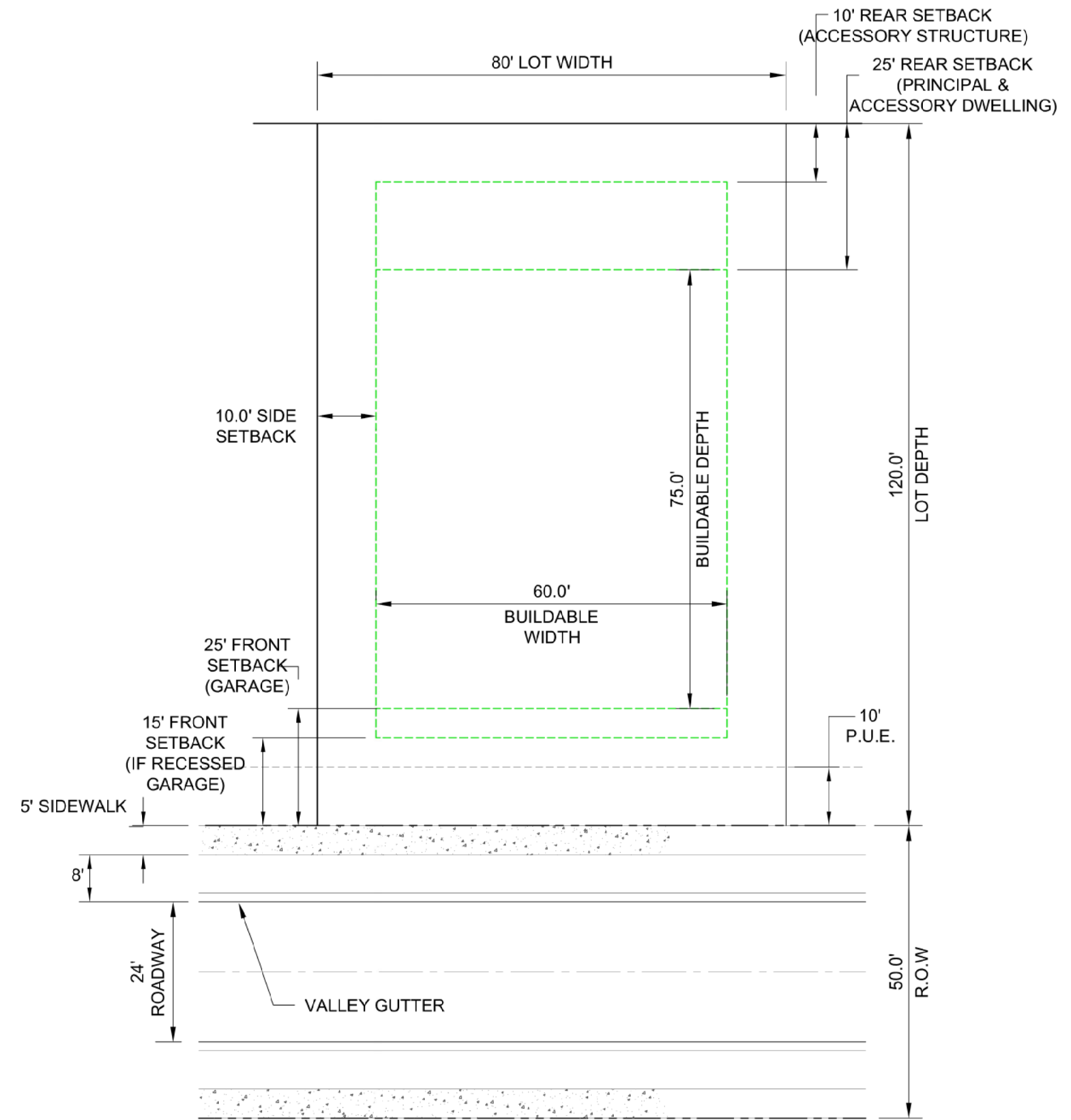

60' LOT REAR LOAD GARAGE

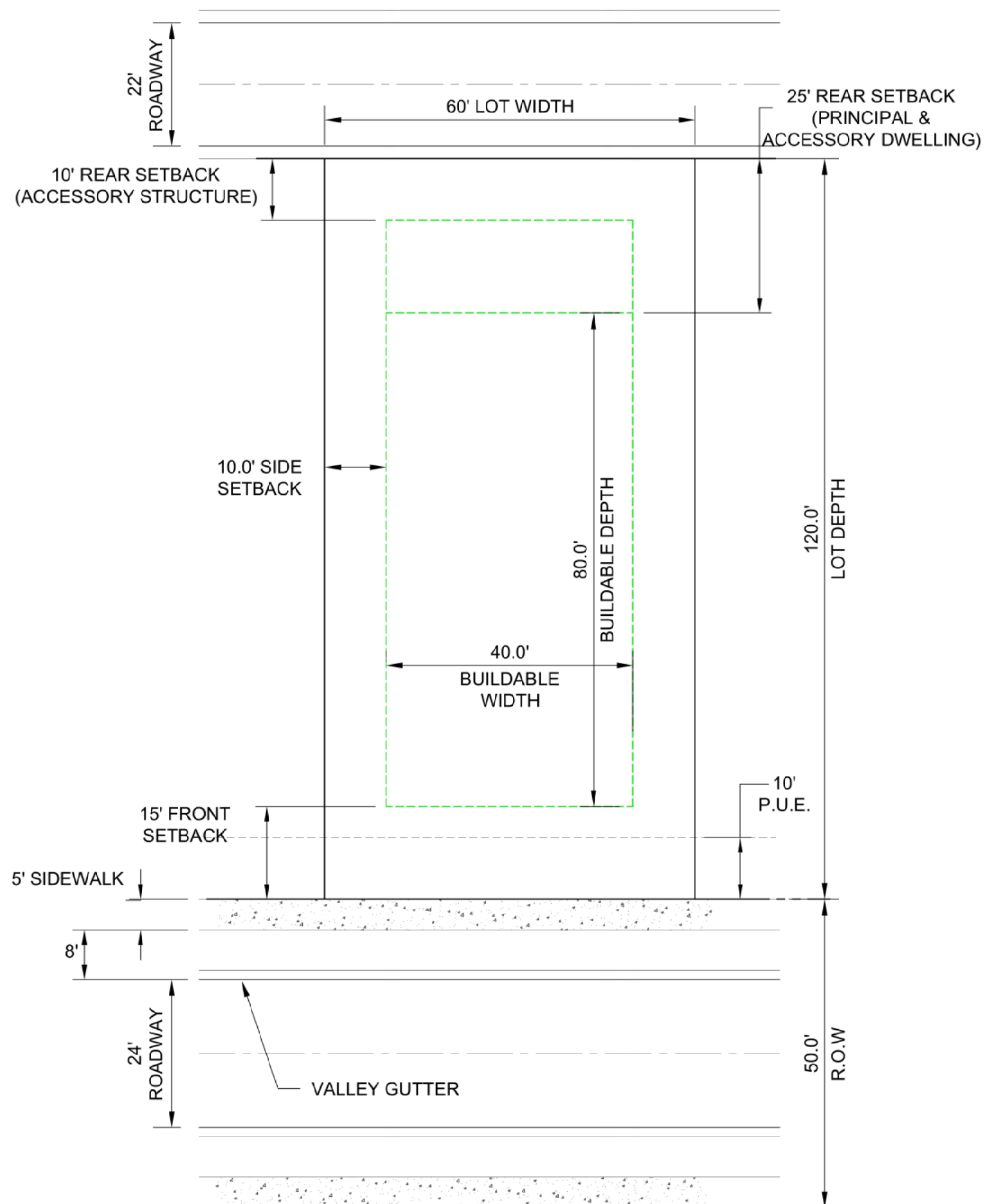

80' LOT REAR LOAD GARAGE

