

LUM NO.	LABEL	MTG. HT.	TILT
1 - 11	XF	11.33	0
12	XL	20.875	0
13	XL	18.25	5
14	XL	18.599	5
15	XL	18.948	5
16	XL	19.297	5
17	XL	19.646	5
18	XL	19.995	5
19	XL	20.344	5
20	XL	20.693	5
21	XL	18.25	5
22	XL	18.599	5
23	XL	18.948	5
24	XL	19.297	5
25	XL	19.646	5
26	XL	19.995	5
27	XL	20.344	5
28	XL	20.693	5
29 - 71	XL	20.875	0
72 - 115	XL	18.076	0
116 - 131	XM	12	0
132 - 215	XP	18	0
216 - 226	XP	19	0
227 - 295	XP	18	0
296 - 327	XP-D	18	0
328 - 330	XP-D	19	0
331 - 377	XP-D	18	0
378, 379	XP01	23	0
380 - 383	XP02	23	0
384 - 386	XP03	23	0
387, 388	XP04	23	0
389 - 392	XP05	23	0
393	XP2F	1	166
394 - 407	XR1	17.67	0
408 - 421	XR1	18.83	0
422 - 428	XT	13.5	50
429 - 431	XT1	13.5	50
432	XT2	15	0
433 - 436	XX	15.42	0
437	XX	11.33	0
438, 439	XX	9.33	0

NOTE:  
 - AREA LIGHTS ON NEW 30 FT. POLES MOUNTED ON 3 FT. CONCRETE BASES  
 - FOOTCANDLE LEVELS CALCULATED AT GRADE USING INITIAL LUMEN VALUES UNLESS NOTED OTHERWISE.

LABEL	AVG	MAX	MIN	AVG/MIN	MAX/MIN
PROPERTY LINES	0.32	1.0	0.0	N.A.	N.A.
SITE PAVED AREA	5.03	24.2	1.0	5.03	24.20
UNDEFINED	0.32	5.7	0.0	N.A.	N.A.
UNDER CANOPY	47.97	62	31	1.55	2.00

THIS SITE IS LOCATED IN A REGION WHERE LIGHTING IS REGULATED BY LOCAL ORDINANCES

SYMBOL	QTY	LABEL	ARRANGEMENT	LUMENS	LLF	BUG RATING	WATTS/LUMINAIRE	TOTAL WATTS	MANUFACTURER	CATALOG LOGIC
⊙	11	XF	Single	1037	1.000	N.A.	10	110	Amerlux, LLC	ORDX4-10-409-M-CSTM-RB-UDM
—	104	XL	SINGLE	136	1.000	N.A.	4.12	428.48	Blair Companies	LINEAR STRIP LIGHT (BY OTHERS, SHOWN FOR CONTRIBUTION)
—	16	XM	SINGLE	136	0.700	N.A.	4.12	65.92	Blair Companies	LB-110-00-XX-025-RD[1]FR4-15
→	164	XP	Single	305	1.000	N.A.	3.66	600.24	P-LED	STREET WRAP FLEX BACK BEND 4000K
↖	82	XP-D	Single	25	1.000	N.A.	0.305	25.01	P-LED	STREET WRAP FLEX BACK BEND 4000K
—	2	XP01	Single	11129	1.020	B2-U0-G3	93	186	Lithonia Lighting	DSX0 LED P4 40K 70CRI T3M MVOLT SPA FAO DXXXX
—	4	XP02	Single	9647	1.020	B1-U0-G3	93	372	LITHONIA LIGHTING	DSX0 LED P4 40K 70CRI T3M MVOLT SPA FAO HS DXXXX
—	3	XP03	Single	11295	1.020	B2-U0-G3	93	279	Lithonia Lighting	DSX0 LED P4 40K 70CRI T4M MVOLT SPA FAO DXXXX
—	2	XP04	2 @ 90 degrees	11295	1.020	B2-U0-G3	93	372	Lithonia Lighting	DSX0 LED P4 40K 70CRI T4M MVOLT SPA FAO DXXXX
—	4	XP05	Single	9717	1.020	B1-U0-G3	93	372	LITHONIA LIGHTING	DSX0 LED P4 40K 70CRI T4M MVOLT SPA FAO HS DXXXX
—	1	XP2F	Single	11830	1.030	N.A.	100	100	LITHONIA LIGHTING	DSXF2 LED P3 40K 70CRI NSP MVOLT IS DXXXX + MOUNTING POST
—	28	XR1	Single	15146	1.000	B3-U0-G2	107	2996	Lithonia Lighting	RCNY LED AL02 50K 90CRI SYMF MVOLT BZS DWHXD SETTING 6
—	7	XT	Single	1840	1.000	N.A.	20	140	SPI Lighting Inc.	SEW12146 5FT L20W AN08 120-277V 4000K PSE SMA OAP (6.00 IN.) FIXT. HEAD FACTORY SET TO 50 DEGREE TILT AWAY FROM BLDG.
—	3	XT1	Single	1472	1.000	N.A.	16	48	SPI Lighting Inc.	SEW12146 4FT L16W AN08 120-277V 4000K PSE SMA OAP (6.00 IN.) FIXT. HEAD FACTORY SET TO 50 DEGREE TILT AWAY FROM BLDG.
—	1	XT2	Single	2208	1.000	N.A.	24	24	SPI Lighting Inc.	SEW12146 6FT L24W AN08 120-277V 4000K PSE SMA OAP12
—	7	XX	Single	1921	1.000	B1-U0-G0	16	112	WILLIAMS OUTDOOR	VWM-H-L17/840-TL-DBZ-CGL-DIM-UNV (BRONZE COLOR 80CRI)

DISCLAIMER

ANY SITE PLAN(S), FLOOR PLAN(S), RENDERING(S), LIGHTING LAYOUT(S) AND PHOTOMETRIC PLAN(S) INCLUDING BUT NOT LIMITED TO ANY PROJECT(S) CREATED/PRODUCED BY RED LEONARD ASSOCIATES INC., ARE ONLY INTENDED FOR ILLUSTRATION AND QUOTING PURPOSES ONLY. RED LEONARD ASSOCIATES HAS THE RIGHT TO USE THIRD PARTY LASERS, SCANNERS, AND CAMERAS BUT ACTUAL PROJECT CONDITIONS, DIMENSIONS, AND ACCURACY OF MEASUREMENTS MAY VARY FROM THE INFORMATION PROVIDED. RED LEONARD ASSOCIATES INC. ASSUMES NO LIABILITY FOR WHAT IS CREATED/PRODUCED IN THESE RECOGNITIONS. THIS INCLUDES BUT IS NOT LIMITED TO THE USE OF, INSTALLATION OF AND/OR INTEGRITY OF EXISTING BUILDINGS(S), SURROUNDING AREA FOR PRODUCT(S) SUCH AS EXISTING POLES(S), ANCHOR BOLTS(S), BASE(S), ARCHITECTURAL AND SIGNAGE STRUCTURE(S), LANDSCAPING PLAN(S), LIGHTING PLAN(S), FIXTURE SELECTION(S) AND PLACEMENT, MATERIAL(S), COLOR ACCURACY, TEXTURE(S), AND ANYTHING ATTRIBUTED TO PHOTO REALISM THAT IS CREATED. FURTHERMORE, RED LEONARD ASSOCIATES INC. DOES NOT ASSUME LIABILITY WHATSOEVER FOR ANY PURCHASES MADE BY CLIENT BEFORE, DURING, OR AT THE CONCLUSION OF THE PUBLISHED WORK. THE CUSTOMER, ITS RELATIVE AFFILIATES, AS WELL AS ANY OTHER PERSON(S) IN VIEWING OF THIS PRODUCT IS RESPONSIBLE FOR VERIFYING COMPLIANCE WITH ANY BUT NOT LIMITED TO ALL CODES, PERMITS, RESTRICTIONS, INSTRUCTIONS, PURCHASES, AND INSTALLATIONS OF OBJECTS VIEWED WITHIN THIS DOCUMENT(S) OR PROJECT(S). SYMBOLS ARE NOT DRAWN TO SCALE. SIZE IS FOR CLARITY PURPOSES ONLY. SIZES AND DIMENSIONS ARE APPROXIMATE. ACTUAL MEASUREMENTS MAY VARY. DRAWINGS ARE NOT INTENDED FOR ENGINEERING OR CONSTRUCTION USE. THIS DOCUMENT, ANY RED LEONARD DRAWING(S) OR PROJECT(S) IS NOT TO BE USED AND/OR INTENDED FOR ENGINEERING OR CONSTRUCTION PURPOSES, BUT FOR ILLUSTRATIVE PURPOSES ONLY. ANY LOCATIONS OF EMERGENCY LIGHTING SHOWN WERE PROVIDED BY OTHERS. RED LEONARD ASSOCIATES IS NOT RESPONSIBLE FOR INSUFFICIENT LIGHTING DURING AN EMERGENCY EVENT. ANY USE OF THIS DOCUMENTATION AND/OR OTHER ARTICLES PRODUCED BY RED LEONARD WITHOUT WRITTEN AUTHORIZATION FROM JAVINE J. LEONARD IS STRICTLY PROHIBITED.



QTY	LABEL	DESCRIPTION
11	XF	ORDX4-10-409-M-CSTM-RB-UDM



**Features and Specs**

- Cast aluminum top housing with integral driver.
- Dust and water tight (IP66) sealed optical chamber.
- Die-cast aluminum trim and faceplate.
- Stainless steel hardware.

**Finish**

- Architectural Grade Polyester Powder Coat.

**Options**

- Beam Spread: 30°, 24°, 30°
- CCT: 2700K, 3000K, 4000K
- CRN 50 or 50+ type
- Polycarbonate TR optic with white backing for maximum efficiency.

**Electrical**

- Integral LED driver included, 120-277V.
- Primary wiring compartment with power supply.
- Standard driver supports 40 different dimming protocols - TRIAC/ELV/0V/0VPM.
- Dimming percentage less than 1% - All dimming methods.

**Adjustable from 0.017" to 1.02" ceiling thickness.**

**LifeSpan**

- Estimated 50,000+ hour LED life span based on IES LM-80 results and TM-C calculations.

**Lighting**

- UL listed for wet locations (suitable for use in open or unenclosed applications).

**Assembled in the USA**

**5 year limited warranty**

**5 year limited warranty**

**5 year limited warranty**

## ORDX4

Open Rated Exterior Downlight

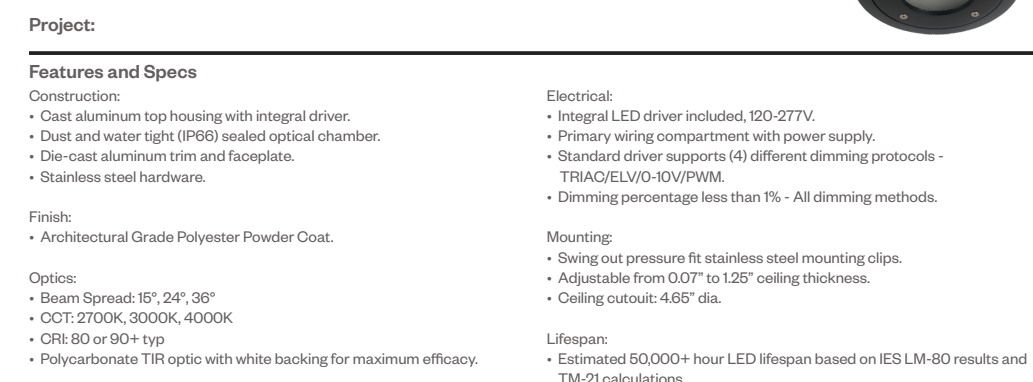

**Performance Data (with Medium beam)**

Wattage	Delivered Lumens	Color Temp/CRI
10	~1040	4000K/90+
10	~1040	4000K/90+

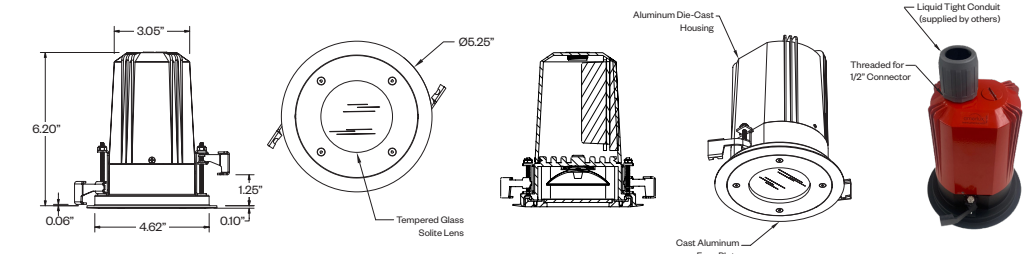

**Ordering Information**

Model	Wattage	CCT/CRI	Beam Spread	Finish	Driver
ORDX4	10 W	27 2700K/90-CRI	SP spot 10°	BLK black	UDM universal 4-in dimming track/0-10V/0-10VPM
ORDX4	10 W	30 3000K/90-CRI	M narrow 24°	BLK white	UDM universal 4-in dimming track/0-10V/0-10VPM
ORDX4	10 W	40 4000K/90-CRI	M medium 30°	BLK white	UDM universal 4-in dimming track/0-10V/0-10VPM
ORDX4	10 W	27 2700K/90-CRI	UDM universal	CSTM-RB custom red/black	UDM universal 4-in dimming track/0-10V/0-10VPM
ORDX4	10 W	30 3000K/90-CRI	UDM universal	CSTM-RB custom red/black	UDM universal 4-in dimming track/0-10V/0-10VPM
ORDX4	10 W	40 4000K/90-CRI	UDM universal	CSTM-RB custom red/black	UDM universal 4-in dimming track/0-10V/0-10VPM

Amelux reserves the right to change details that do not affect overall function and performance.

Amelux, LLC - 178 Baker Drive, Oakland, NJ 07036 - P: 878-885-5200 F: 878-885-9000 - amelux.com

LF1 02/02/2024 - Page 1 of 1

**amerlux**  
A Delta Group Company

QTY	LABEL	DESCRIPTION
164	XP	STREET WRAP FLEX BACK BEND 4000K
82	XP-D	STREET WRAP FLEX BACK BEND 4000K



**Need to understand how this light will emit. May need to be shielded to prevent uplift.**

## Streetstone Design Studio LIGHTING DESIGN SHEETZ 2.0



**STREET WRAP™ FLEX BACK-BEND**

*Our binder solution is perfect for adding an extra punch of color to your building. The primary customization or set-up. Easy wrapping your building quickly and easily.*

**Specifications**

Dimensions	Value
Length	26.18" (665mm)
Width	14.06" (357mm)
Height H1	2.26" (57mm)
Height H2	7.46" (190mm)
Weight	23 lbs (10kg)

**Features**

- Break free track
- 2.3" maximum bending radius
- Drift resistant, offset shaver lens and thermal conductive base
- Easy installation
- Applications: street lights, outdoor building and sign-outdoor lighting, and more lighting applications
- UV resistant
- Stainless steel construction
- 50000+ Hours, RGB available every 2.3" (57mm)

**Product Options**

Color	Material	Length	Width	Weight
White	305K	305K	305K	305K
Black	305K	305K	305K	305K
Blue	305K	305K	305K	305K
Green	305K	305K	305K	305K
Yellow	305K	305K	305K	305K
Orange	305K	305K	305K	305K
Red	305K	305K	305K	305K
Purple	305K	305K	305K	305K
Blue	305K	305K	305K	305K
Green	305K	305K	305K	305K
Yellow	305K	305K	305K	305K
Orange	305K	305K	305K	305K
Red	305K	305K	305K	305K
Purple	305K	305K	305K	305K
Blue	305K	305K	305K	305K
Green	305K	305K	305K	305K
Yellow	305K	305K	305K	305K
Orange	305K	305K	305K	305K
Red	305K	305K	305K	305K
Purple	305K	305K	305K	305K

**Important Warranty Info**

This warranty is void if any cuts are made in the field. Any cuts must be made by Principal LED to maintain warranty.

Principal LED is not responsible for any damage caused by misuse or improper installation. Please refer to the installation manual for proper installation. Principal LED is not responsible for any damage caused by misuse or improper installation. Please refer to the installation manual for proper installation.

**Ordering Information**

EXAMPLE: DSXO LED P4 40K 70CRI T3M MVOLT SPA FAO DXXXX

Series	Color Temperature	Color Rendering Index	Mounting	Beam Spread	Beam Diameter	Beam Angle	Beam Spread	Beam Diameter	Beam Angle
DSXO LED	4000K	90+	70CRI	15°	1.5"	15°	1.5"	15°	1.5"
DSXO LED	4000K	90+	70CRI	15°	1.5"	15°	1.5"	15°	1.5"
DSXO LED	4000K	90+	70CRI	15°	1.5"	15°	1.5"	15°	1.5"

**Accessories**

Accessories	Part Number	Description
External Glare Shield (EGSR)	A-508H-CAL	External Glare Shield (EGSR)
House Side Shield (HSS)	A-508H-CAL	House Side Shield (HSS)
End Cap	A-508H-CAL	End Cap
Wiring	A-508H-CAL	Wiring

Amelux reserves the right to change details that do not affect overall function and performance.

Amelux, LLC - 178 Baker Drive, Oakland, NJ 07036 - P: 878-885-5200 F: 878-885-9000 - amelux.com

LF1 02/02/2024 - Page 1 of 1

**amerlux**  
A Delta Group Company

## Streetstone Design Studio LIGHTING DESIGN SHEETZ 2.0



**INSTALLATION ACCESSORIES**

Type	Description	Part Number
1	Transparent PC Caps	A-508H-CAL
2	3.0" x 1.5" x 0.125" Aluminum Mill Finish Extrusion for outdoor application	A-508H-FRAL
3	Aluminum Mill Finish Clips for outdoor applications - 1.6667" Dia	A-508H-CAL

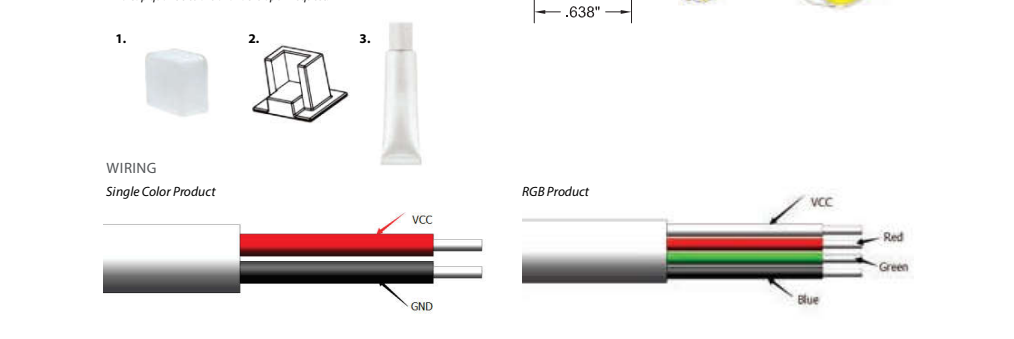
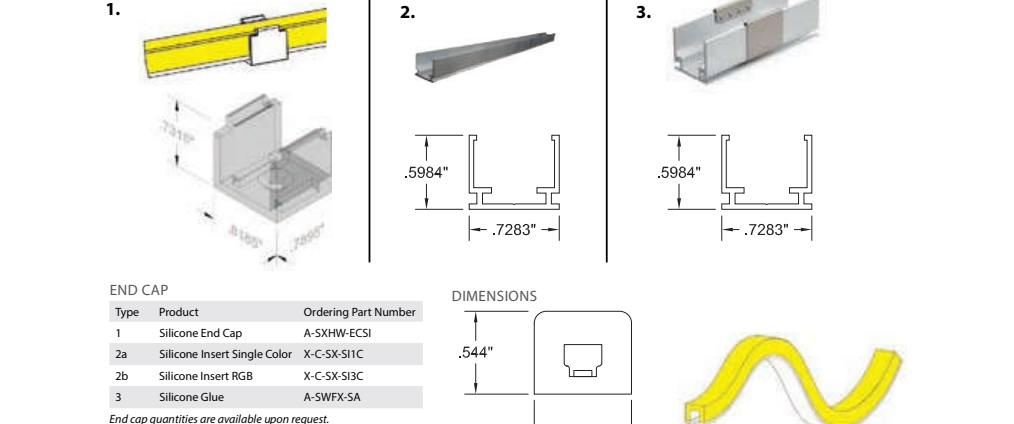

Amelux reserves the right to change details that do not affect overall function and performance.

Amelux, LLC - 178 Baker Drive, Oakland, NJ 07036 - P: 878-885-5200 F: 878-885-9000 - amelux.com

LF1 02/02/2024 - Page 1 of 1

**amerlux**  
A Delta Group Company

QTY	LABEL	DESCRIPTION
2	XP01	DSXO LED P4 40K 70CRI T3M MVOLT SPA FAO DXXXX
4	XP02	DSXO LED P4 40K 70CRI T3M MVOLT SPA FAO HS DXXXX
3	XP03	DSXO LED P4 40K 70CRI T4M MVOLT SPA FAO DXXXX
2	XP04	DSXO LED P4 40K 70CRI T4M MVOLT SPA FAO DXXXX
4	XP05	DSXO LED P4 40K 70CRI T4M MVOLT SPA FAO HS DXXXX

## Streetstone Design Studio LIGHTING DESIGN SHEETZ 2.0



**D-Series Size 0 LED Area Luminaire**

**Specifications**

Dimensions	Value
Length	14.06" (357mm)
Width	14.06" (357mm)
Height H1	2.26" (57mm)
Height H2	7.46" (190mm)
Weight	23 lbs (10kg)

**Features**

- Break free track
- 2.3" maximum bending radius
- Drift resistant, offset shaver lens and thermal conductive base
- Easy installation
- Applications: street lights, outdoor building and sign-outdoor lighting, and more lighting applications
- UV resistant
- Stainless steel construction
- 50000+ Hours, RGB available every 2.3" (57mm)

**Ordering Information**

EXAMPLE: DSXO LED P4 40K 70CRI T3M MVOLT SPA FAO DXXXX

Series	Color Temperature	Color Rendering Index	Mounting	Beam Spread	Beam Diameter	Beam Angle	Beam Spread	Beam Diameter	Beam Angle
DSXO LED	4000K	90+	70CRI	15°	1.5"	15°	1.5"	15°	1.5"
DSXO LED	4000K	90+	70CRI	15°	1.5"	15°	1.5"	15°	1.5"
DSXO LED	4000K	90+	70CRI	15°	1.5"	15°	1.5"	15°	1.5"

**Accessories**

Accessories	Part Number	Description
External Glare Shield (EGSR)	A-508H-CAL	External Glare Shield (EGSR)
House Side Shield (HSS)	A-508H-CAL	House Side Shield (HSS)
End Cap	A-508H-CAL	End Cap
Wiring	A-508H-CAL	Wiring

Amelux reserves the right to change details that do not affect overall function and performance.

Amelux, LLC - 178 Baker Drive, Oakland, NJ 07036 - P: 878-885-5200 F: 878-885-9000 - amelux.com

LF1 02/02/2024 - Page 1 of 1

**amerlux**  
A Delta Group Company

## Streetstone Design Studio LIGHTING DESIGN SHEETZ 2.0

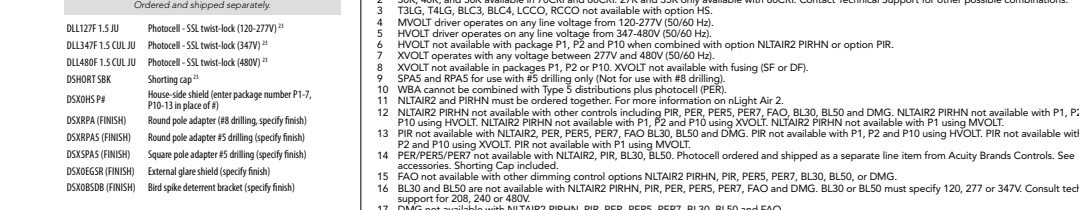

**D-Series DSXF2 LED Floodlight**

**Specifications**

Dimensions	Value
Length	12.87" (327mm)
Width	12.87" (327mm)
Height H1	7.87" (200mm)
Height H2	15.37" (391mm)
Weight	12.0 lbs (5.4kg)

**Features**

- Break free track
- 2.3" maximum bending radius
- Drift resistant, offset shaver lens and thermal conductive base
- Easy installation
- Applications: street lights, outdoor building and sign-outdoor lighting, and more lighting applications
- UV resistant
- Stainless steel construction
- 50000+ Hours, RGB available every 2.3" (57mm)

**Ordering Information**

EXAMPLE: DSXF2 LED P1 40K 70CRI MSP MVOLT THK DBXDB

Series	Color Temperature	Color Rendering Index	Mounting	Beam Spread	Beam Diameter	Beam Angle	Beam Spread	Beam Diameter	Beam Angle
DSXF2 LED	4000K	90+	70CRI	15°	1.5"	15°	1.5"	15°	1.5"
DSXF2 LED	4000K	90+	70CRI	15°	1.5"	15°	1.5"	15°	1.5"
DSXF2 LED	4000K	90+	70CRI	15°	1.5"	15°	1.5"	15°	1.5"

**Accessories**

Accessories	Part Number	Description
External Glare Shield (EGSR)	A-508H-CAL	External Glare Shield (EGSR)
House Side Shield (HSS)	A-508H-CAL	House Side Shield (HSS)
End Cap	A-508H-CAL	End Cap
Wiring	A-508H-CAL	Wiring

Amelux reserves the right to change details that do not affect overall function and performance.

Amelux, LLC - 178 Baker Drive, Oakland, NJ 07036 - P: 878-885-5200 F: 878-885-9000 - amelux.com

LF1 02/02/2024 - Page 1 of 1

**amerlux**  
A Delta Group Company

QTY	LABEL	DESCRIPTION
1	XP2F	DSXF2 LED P3 40K 70CRI NSP MVOLT IS DXXXX + MOUNTING POST



**No Floodlights permitted**

## Streetstone Design Studio LIGHTING DESIGN SHEETZ 2.0



**D-Series DSXF2 LED Floodlight**

**Specifications**

Dimensions	Value
Length	12.87" (327mm)
Width	12.87" (327mm)
Height H1	7.87" (200mm)
Height H2	15.37" (391mm)
Weight	12.0 lbs (5.4kg)

**Features**

- Break free track
- 2.3" maximum bending radius
- Drift resistant, offset shaver lens and thermal conductive base
- Easy installation
- Applications: street lights, outdoor building and sign-outdoor lighting, and more lighting applications
- UV resistant
- Stainless steel construction
- 50000+ Hours, RGB available every 2.3" (57mm)

**Ordering Information**

EXAMPLE: DSXF2 LED P1 40K 70CRI MSP MVOLT THK DBXDB

Series	Color Temperature	Color Rendering Index	Mounting	Beam Spread	Beam Diameter	Beam Angle	Beam Spread	Beam Diameter	Beam Angle
DSXF2 LED	4000K	90+	70CRI	15°	1.5"	15°	1.5"	15°	1.5"
DSXF2 LED	4000K	90+	70CRI	15°	1.5"	15°	1.5"	15°	1.5"
DSXF2 LED	4000K	90+	70CRI	15°	1.5"	15°	1.5"	15°	1.5"

**Accessories**

Accessories	Part Number	Description
External Glare Shield (EGSR)	A-508H-CAL	External Glare Shield (EGSR)
House Side Shield (HSS)	A-508H-CAL	House Side Shield (HSS)
End Cap	A-508H-CAL	End Cap
Wiring	A-508H-CAL	Wiring

Amelux reserves the right to change details that do not affect overall function and performance.

Amelux, LLC - 178 Baker Drive, Oakland, NJ 07036 - P: 878-885-5200 F: 878-885-9000 - amelux.com

LF1 02/02/2024 - Page 1 of 1

**amerlux**  
A Delta Group Company

## Streetstone Design Studio LIGHTING DESIGN SHEETZ 2.0



**RCNY LED Recessed LED Canopy/Ceiling Luminaire**

**Specifications**

Dimensions	Value
Width	11.5"
Height	5.9"
Length	11.5"
Weight	14lbs

**Features**

- Break free track
- 2.3" maximum bending radius
- Drift resistant, offset shaver lens and thermal conductive base
- Easy installation
- Applications: street lights, outdoor building and sign-outdoor lighting, and more lighting applications
- UV resistant
- Stainless steel construction
- 50000+ Hours, RGB available every 2.3" (57mm)

**Ordering Information**

EXAMPLE: RCNY LED AL02 50K 70CRI SYMC MVOLT BZS DWXHD

Series	Color Temperature	Color Rendering Index	Mounting	Beam Spread	Beam Diameter	Beam Angle	Beam Spread	Beam Diameter	Beam Angle
RCNY LED	5000K	90+	70CRI	15°	1.5"	15°	1.5"	15°	1.5"
RCNY LED	5000K	90+	70CRI	15°	1.5"	15°	1.5"	15°	1.5"
RCNY LED	5000K	90+	70CRI	15°	1.5"	15°	1.5"	15°	1.5"

**Accessories**

Accessories	Part Number	Description
External Glare Shield (EGSR)	A-508H-CAL	External Glare Shield (EGSR)
House Side Shield (HSS)	A-508H-CAL	House Side Shield (HSS)
End Cap	A-508H-CAL	End Cap
Wiring	A-508H-CAL	Wiring

Amelux reserves the right to change details that do not affect overall function and performance.

Amelux, LLC - 178 Baker Drive, Oakland, NJ 07036 - P: 878-885-5200 F: 878-885-9000 - amelux.com

LF1 02/02/2024 - Page 1 of 1

**amerlux**  
A Delta Group Company

QTY	LABEL	DESCRIPTION
28	XR1	RCNY LED AL02 50K 70CRI SYMC MVOLT BZS DWXHD SETTING 6



**INSTALL INSTRUCTIONS**

## Streetstone Design Studio LIGHTING DESIGN SHEETZ 2.0

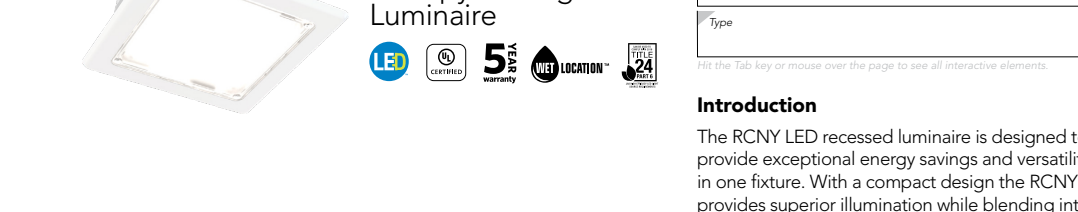

**RCNY LED Recessed LED Canopy/Ceiling Luminaire**

**Specifications**

Dimensions	Value
Width	11.5"
Height	5.9"
Length	11.5"
Weight	14lbs

**Features**

- Break free track
- 2.3" maximum bending radius
- Drift resistant, offset shaver lens and thermal conductive base
- Easy installation
- Applications: street lights, outdoor building and sign-outdoor lighting, and more lighting applications
- UV resistant
- Stainless steel construction
- 50000+ Hours, RGB available every 2.3" (57mm)

**Ordering Information**

EXAMPLE: RCNY LED AL02 50K 70CRI SYMC MVOLT BZS DWXHD

Series	Color Temperature	Color Rendering Index	Mounting	Beam Spread	Beam Diameter	Beam Angle	Beam Spread	Beam Diameter	Beam Angle
RCNY LED	5000K	90+	70CRI	15°	1.5"	15°	1.5"	15°	1.5"
RCNY									

QTY	LABEL	DESCRIPTION
7	XT	SEW12146 5FT L20W AN08 120-277V 4000K PSE SMA OAP (6.00 IN.) FIXT. HEAD FACTORY SET TO 50 DEGREE TILT AWAY FROM BLDG.

Should be tilted down so as to create 0 Uplight

QTY	LABEL	DESCRIPTION
3	XT1	SEW12146 4FT L16W AN08 120-277V 4000K PSE SMA OAP (6.00 IN.) FIXT. HEAD FACTORY SET TO 50 DEGREE TILT AWAY FROM BLDG.

Should be tilted down to create 0 Uplight

QTY	LABEL	DESCRIPTION
1	XT2	SEW12146 6FT L24W AN08 120-277V 4000K SMA PSE OAP12

Should be tilted down to create 0 Uplight

QTY	LABEL	DESCRIPTION
7	XX	VWM-H-L17/840-TL-DBZ-CGL-DIM-UNV (BRONZE COLOR BR01)

Should be tilted down to create 0 Uplight

## Styk Exterior Wall - Stem

SEW12146 2.20 in

JOB NAME: SHEETZ  
TYPE: 5' Aiming Light  
NOTES: Fixture head to be fixed at a 50 degree angle down away from the building.



ORDERING CODE: SEW12146 | 5FT-L20W(AN08) | 120-277V | 4000K | PSE | SMA | (DAP)6.00m |  
Please Note: Default specifications \*DF\_XXX\* will not appear in the ordering code.

### DESCRIPTION

Styk was built to provide the most lumens with the smallest luminaire package, while optimizing life. Not limited to decorative lighting, effective functional lighting is provided through the optimal light control in this minimal package. Its three optical offerings enable tremendous flexibility including wall washing, wall grazing, and asymmetric lighting solutions. It is excellent at lighting signs and facades. The family features wall, ceiling, and pendant models in a variety of stylish, clean mounting options. Available in 1' to 8' lengths, Styk can be mounted individually or configured in runs.

### FEATURES & BENEFITS

- Sleek 1.5" diameter housing
- A forward throw optic, for even wall wash illumination, is standard
- Symmetrical optic options are available for more volumetric illumination
- Lamp body can be rotated up to 330° and locks into position for precise fixture alignment
- Up to 1,450 lumens per foot delivered (with Forward Throw distribution)
- Up to 18" projection with no vertical support needed
- Anodized finish provides durable corrosion protection
- All visible fasteners are flush mounted, providing a clean design
- Handcrafted in USA, BABA Compliant

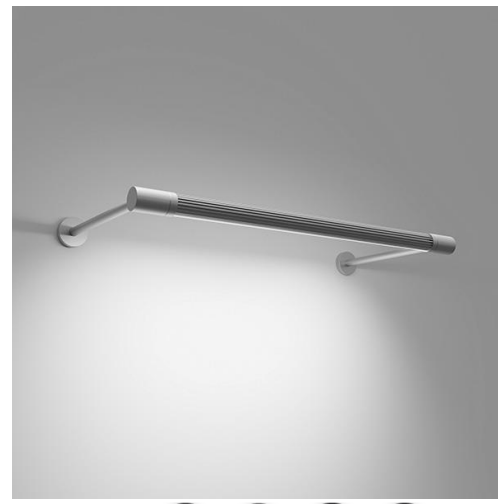

### SPECIFICATIONS

- LIGHT SOURCE:** IP66 white LED light engine
- CR:** 80+ or 90+
- LUMEN MAINTENANCE:** L70 => +50,000 Hrs.
- EFFICACY:** 102 lm/W delivered (with Forward Throw distribution)
- CCT:** 2700K, 3000K, 3500K, 4000K, 5000K
- VOLTAGE:** 120-277V standard
- DRIVER:** Includes one remote damp listed Class 2 power supply and either a damp location or wet location enclosure, except

SPI LIGHTING P.262.242.1420 | SPHeam@spilighting.com | Last Revised: 10/26/2025 | Design Rights Reserved | SEW12146 | 1 of 8

## Styk Exterior Wall - Stem

SEW12146 2.20 in

JOB NAME: SHEETZ  
TYPE: 4' Aiming Light  
NOTES: Fixture head to be fixed at a 50 degree angle down away from the building.



ORDERING CODE: SEW12146 | 4FT-L16W(AN08) | 120-277V | 4000K | PSE | SMA | (DAP)6.00m |  
Please Note: Default specifications \*DF\_XXX\* will not appear in the ordering code.

### DESCRIPTION

Styk was built to provide the most lumens with the smallest luminaire package, while optimizing life. Not limited to decorative lighting, effective functional lighting is provided through the optimal light control in this minimal package. Its three optical offerings enable tremendous flexibility including wall washing, wall grazing, and asymmetric lighting solutions. It is excellent at lighting signs and facades. The family features wall, ceiling, and pendant models in a variety of stylish, clean mounting options. Available in 1' to 8' lengths, Styk can be mounted individually or configured in runs.

### FEATURES & BENEFITS

- Sleek 1.5" diameter housing
- A forward throw optic, for even wall wash illumination, is standard
- Symmetrical optic options are available for more volumetric illumination
- Lamp body can be rotated up to 330° and locks into position for precise fixture alignment
- Up to 1,450 lumens per foot delivered (with Forward Throw distribution)
- Up to 18" projection with no vertical support needed
- Anodized finish provides durable corrosion protection
- All visible fasteners are flush mounted, providing a clean design
- Handcrafted in USA, BABA Compliant



### SPECIFICATIONS

- LIGHT SOURCE:** IP66 white LED light engine
- CR:** 80+ or 90+
- LUMEN MAINTENANCE:** L70 => +50,000 Hrs.
- EFFICACY:** 102 lm/W delivered (with Forward Throw distribution)
- CCT:** 2700K, 3000K, 3500K, 4000K, 5000K
- VOLTAGE:** 120-277V standard
- DRIVER:** Includes one remote damp listed Class 2 power supply and either a damp location or wet location enclosure, except

SPI LIGHTING P.262.242.1420 | SPHeam@spilighting.com | Last Revised: 10/26/2025 | Design Rights Reserved | SEW12146 | 1 of 8

## Styk Exterior Wall - Stem

SEW12146 2 in

JOB NAME: SHEETZ  
TYPE:  
NOTES:



ORDERING CODE: SEW12146 | 5FT-L20W(AN08) | 120-277V | 4000K | SMA  
Please Note: Default specifications \*DF\_XXX\* will not appear in the ordering code.

### DESCRIPTION

Styk was built to provide the most lumens with the smallest luminaire package, while optimizing life. Not limited to decorative lighting, effective functional lighting is provided through the optimal light control in this minimal package. Its three optical offerings enable tremendous flexibility including wall washing, wall grazing, and asymmetric lighting solutions. It is excellent at lighting signs and facades. The family features wall, ceiling, and pendant models in a variety of stylish, clean mounting options. Available in 1' to 8' lengths, Styk can be mounted individually or configured in runs.

### FEATURES & BENEFITS

- Sleek 1.5" diameter housing
- A forward throw optic, for even wall wash illumination, is standard
- Symmetrical optic options are available for more volumetric illumination
- Lamp body can be rotated up to 330° and locks into position for precise fixture alignment
- Up to 1,450 lumens per foot delivered (with Forward Throw distribution)
- Up to 18" projection with no vertical support needed
- Anodized finish provides durable corrosion protection
- All visible fasteners are flush mounted, providing a clean design
- Handcrafted in USA

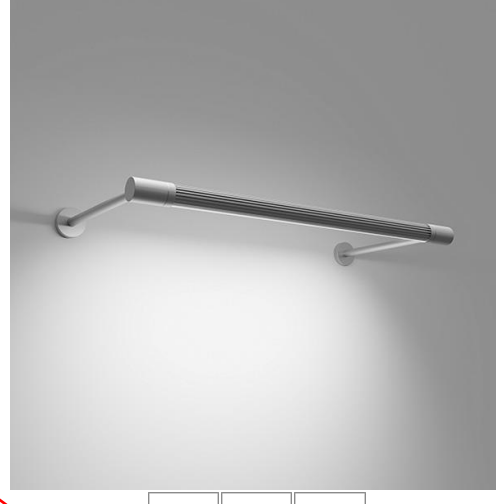

### SPECIFICATIONS

- LIGHT SOURCE:** IP66 white LED light engine
- CR:** 80+ (contact factory for 90+)
- LUMEN MAINTENANCE:** L70 => +50,000 Hrs.
- EFFICACY:** 102 lm/W delivered (with Forward Throw distribution)
- CCT:** 3000K, 3500K, or 4000K
- VOLTAGE:** 120-277V standard
- DRIVER:** Includes one remote damp listed Class 2 power supply and wet location enclosure, except 8FT-L113W which has two.

SPI LIGHTING P.262.242.1420 | SPHeam@spilighting.com | Last Revised: 01/20/2023 | Design Rights Reserved | SEW12146 | 1 of 6

Black power cord standard unless otherwise specified. Max distance to the driver (including DAP) is: #18 AWG = 50', #16 AWG = 75', #14 AWG = 100'. For extended distances, contact factory.

- DIMMING:** 0-10V controls standard to 1%
- EMERGENCY:** Emergency battery remote optional
- INTEGRATED SURGE PROTECTION:** LED components are protected against minor surge events
- CONSTRUCTION:** Extruded aluminum construction provides durable protection for internal components and is recyclable
- FINISH:** Housing available in anodized finishes only. End caps and mounting components painted to match.
- MODIFICATIONS:** Consult factory for all modification requests, including RGB and static LED colors
- APPROVALS:** ETL listed to UL standards (US and Canada) for use in wet locations

### DIMENSIONS

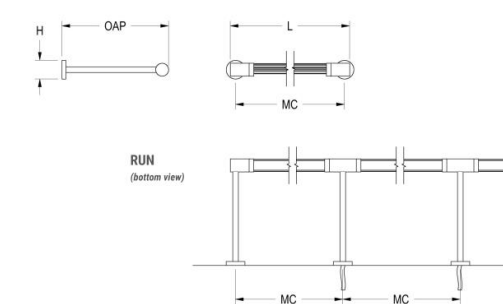

MT	L	H	W	G	MC
5FT	17.5 in	2.2 in	12 in	16.2 in	44.1 cm
4FT	14.5 in	2.2 in	12 in	13.2 in	35.6 cm
3FT	11.5 in	2.2 in	12 in	10.2 in	27.1 cm
2FT	7.5 in	2.2 in	12 in	6.2 in	17.1 cm
1FT	3.5 in	2.2 in	12 in	2.2 in	7.1 cm

8FT-L113W which has two. Black power cord standard unless otherwise specified. Max distance to the driver (including DAP) is: #18 AWG = 50', #16 AWG = 75', #14 AWG = 100'. For extended distances, contact factory.

- DIMMING:** 0-10V controls standard to 1%
- CONTROLS:** Contact factory for control options (e.g., Lutron Athena, Current NX, nLight, Enlighted, Enceium, Wattstopper, WaveLinx, or Casambi).
- EMERGENCY:** Remote battery option is provided with 10W Constant Power Battery back-up, providing 90 Minutes of Emergency operation. Contact factory for other Emergency options.
- INTEGRATED SURGE PROTECTION:** LED components are protected against minor surge events
- CONSTRUCTION:** Extruded aluminum construction provides durable protection for internal components and is recyclable
- FINISH:** Housing available in anodized finishes only. End caps and mounting components painted to match.
- MODIFICATIONS:** Consult factory for all modification requests, including RGB and static LED colors
- APPROVALS:** ETL listed to UL standards (US and Canada) for use in wet locations

SPI LIGHTING P.262.242.1420 | SPHeam@spilighting.com | Last Revised: 10/26/2025 | Design Rights Reserved | SEW12146 | 2 of 8

SPI LIGHTING P.262.242.1420 | SPHeam@spilighting.com | Last Revised: 10/26/2025 | Design Rights Reserved | SEW12146 | 2 of 8

SPI LIGHTING P.262.242.1420 | SPHeam@spilighting.com | Last Revised: 01/20/2023 | Design Rights Reserved | SEW12146 | 2 of 6

## Shimstone Design Studio

SEW12146 2.20 in

JOB NAME: SHEETZ  
TYPE:  
NOTES:

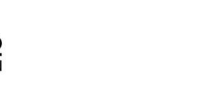

ORDERING CODE: SEW12146 | 5FT-L20W(AN08) | 120-277V | 4000K | SMA  
Please Note: Default specifications \*DF\_XXX\* will not appear in the ordering code.

### DESCRIPTION

Styk was built to provide the most lumens with the smallest luminaire package, while optimizing life. Not limited to decorative lighting, effective functional lighting is provided through the optimal light control in this minimal package. Its three optical offerings enable tremendous flexibility including wall washing, wall grazing, and asymmetric lighting solutions. It is excellent at lighting signs and facades. The family features wall, ceiling, and pendant models in a variety of stylish, clean mounting options. Available in 1' to 8' lengths, Styk can be mounted individually or configured in runs.

### FEATURES & BENEFITS

- Sleek 1.5" diameter housing
- A forward throw optic, for even wall wash illumination, is standard
- Symmetrical optic options are available for more volumetric illumination
- Lamp body can be rotated up to 330° and locks into position for precise fixture alignment
- Up to 1,450 lumens per foot delivered (with Forward Throw distribution)
- Up to 18" projection with no vertical support needed
- Anodized finish provides durable corrosion protection
- All visible fasteners are flush mounted, providing a clean design
- Handcrafted in USA, BABA Compliant

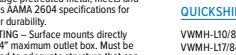

### SPECIFICATIONS

- LIGHT SOURCE:** IP66 white LED light engine
- CR:** 80+ or 90+
- LUMEN MAINTENANCE:** L70 => +50,000 Hrs.
- EFFICACY:** 102 lm/W delivered (with Forward Throw distribution)
- CCT:** 2700K, 3000K, 3500K, 4000K, 5000K
- VOLTAGE:** 120-277V standard
- DRIVER:** Includes one remote damp listed Class 2 power supply and either a damp location or wet location enclosure, except

SPI LIGHTING P.262.242.1420 | SPHeam@spilighting.com | Last Revised: 10/26/2025 | Design Rights Reserved | SEW12146 | 1 of 8

## Shimstone Design Studio

SEW12146 2.20 in

JOB NAME: SHEETZ  
TYPE:  
NOTES:

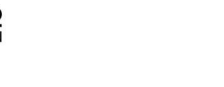

ORDERING CODE: SEW12146 | 5FT-L20W(AN08) | 120-277V | 4000K | SMA  
Please Note: Default specifications \*DF\_XXX\* will not appear in the ordering code.

### DESCRIPTION

Styk was built to provide the most lumens with the smallest luminaire package, while optimizing life. Not limited to decorative lighting, effective functional lighting is provided through the optimal light control in this minimal package. Its three optical offerings enable tremendous flexibility including wall washing, wall grazing, and asymmetric lighting solutions. It is excellent at lighting signs and facades. The family features wall, ceiling, and pendant models in a variety of stylish, clean mounting options. Available in 1' to 8' lengths, Styk can be mounted individually or configured in runs.

### FEATURES & BENEFITS

- Sleek 1.5" diameter housing
- A forward throw optic, for even wall wash illumination, is standard
- Symmetrical optic options are available for more volumetric illumination
- Lamp body can be rotated up to 330° and locks into position for precise fixture alignment
- Up to 1,450 lumens per foot delivered (with Forward Throw distribution)
- Up to 18" projection with no vertical support needed
- Anodized finish provides durable corrosion protection
- All visible fasteners are flush mounted, providing a clean design
- Handcrafted in USA, BABA Compliant

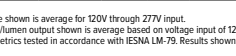
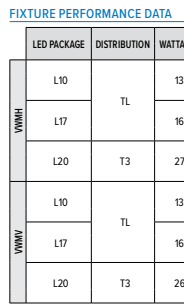

SPI LIGHTING P.262.242.1420 | SPHeam@spilighting.com | Last Revised: 10/26/2025 | Design Rights Reserved | SEW12146 | 2 of 8













1340 Kemper Meadow Dr. Forest Park, OH 45240  
513-674-9500 | redleonard.com

ANY SITE PLAN(S), FLOOR PLAN(S), RENDERING(S), LIGHTING LAYOUT(S) AND PHOTOMETRIC PLAN(S) INCLUDING BUT NOT LIMITED TO ANY PROJECT(S) CREATED/PRODUCED BY RED LEONARD ASSOCIATES INC., ARE ONLY INTENDED FOR ILLUSTRATION AND QUOTING PURPOSES ONLY. RED LEONARD ASSOCIATES HAS THE RIGHT TO USE THIRD PARTY LASERS, SCANNERS, AND CAMERAS BUT ACTUAL PROJECT CONDITIONS, DIMENSIONS, AND ACCURACY OF MEASUREMENTS MAY DIFFER FROM THESE OR ANY PARAMETERS. RED LEONARD ASSOCIATES INC. ASSUMES NO LIABILITY FOR WHAT IS CREATED/PRODUCED IN THESE RECREATIONS. THIS INCLUDES BUT IS NOT LIMITED TO THE USE OF, INSTALLATION OF AND/OR INTEGRITY OF EXISTING BUILDING(S), SURROUNDING AREA FOR PRODUCT(S) SUCH AS EXISTING POLES(S), ANCHOR BOLTS(S), BASE(S), ARCHITECTURAL AND SIGNAGE STRUCTURE(S), LANDSCAPING PLAN(S), LIGHTING PLAN(S), FIXTURE SELECTION(S) AND PLACEMENT, MATERIALS, COLOR ACCURACY, TEXTURES, AND ANYTHING ATTRIBUTED TO PHOTO REALISM THAT IS CREATED. FURTHERMORE, RED LEONARD ASSOCIATES INC. DOES NOT ASSUME LIABILITY WHATSOEVER FOR ANY PURCHASES MADE BY CLIENT BEFORE, DURING, OR AT THE CONCLUSION OF THE PUBLISHED WORK. THE CUSTOMER, ITS RELATIVE AFFILIATES, AS WELL AS ANY OTHER PERSONS IN VIEWING OF THIS PRODUCT IS RESPONSIBLE FOR VERIFYING COMPLIANCE WITH ANY BUT NOT LIMITED TO ALL CODES, PERMITS, RESTRICTIONS, INSTRUCTIONS, PURCHASES, AND INSTALLATIONS OF OBJECTS VIEWED WITHIN THIS DOCUMENT(S) OR PROJECT(S). SYMBOLS ARE NOT DRAWN TO SCALE. SIZE IS FOR CLARITY PURPOSES ONLY. SIZES AND DIMENSIONS ARE APPROXIMATE. ACTUAL MEASUREMENTS MAY VARY. DRAWINGS ARE NOT INTENDED FOR ENGINEERING OR CONSTRUCTION USE. THIS DOCUMENT, ANY RED LEONARD DRAWING(S), OR PROJECT(S) IS NOT TO BE USED AND/OR INTENDED FOR ENGINEERING OR CONSTRUCTION PURPOSES, BUT FOR ILLUSTRATIVE PURPOSES ONLY. ANY USE OF THIS DOCUMENTATION AND/OR OTHER ARTICLES PRODUCED BY RED LEONARD WITHOUT WRITTEN AUTHORIZATION FROM JAYME J. LEONARD IS STRICTLY PROHIBITED.

PROJECT NAME:  
**SHEETZ**  
**FLAT ROCK, NC**  
DRAWING NUMBER:  
**RL-11108-S1**



DOWNLIGHT	
	
STREET WRAP	
	
AREA	
	
FLOOD	
	
CANOPY	
	
WALL MOUNTED	
	
WALL MOUNTED	
