

**JADA Manufacturing Conceptual Review, 24PLN-14**

**ATTACHMENTS:**

1. Conceptual Site Exhibit
2. Building Plans (floor plan, cross sections, elevations, etc)
3. Renderings
4. Photos of adjacent buildings/roads
5. Proposed Parking Lighting

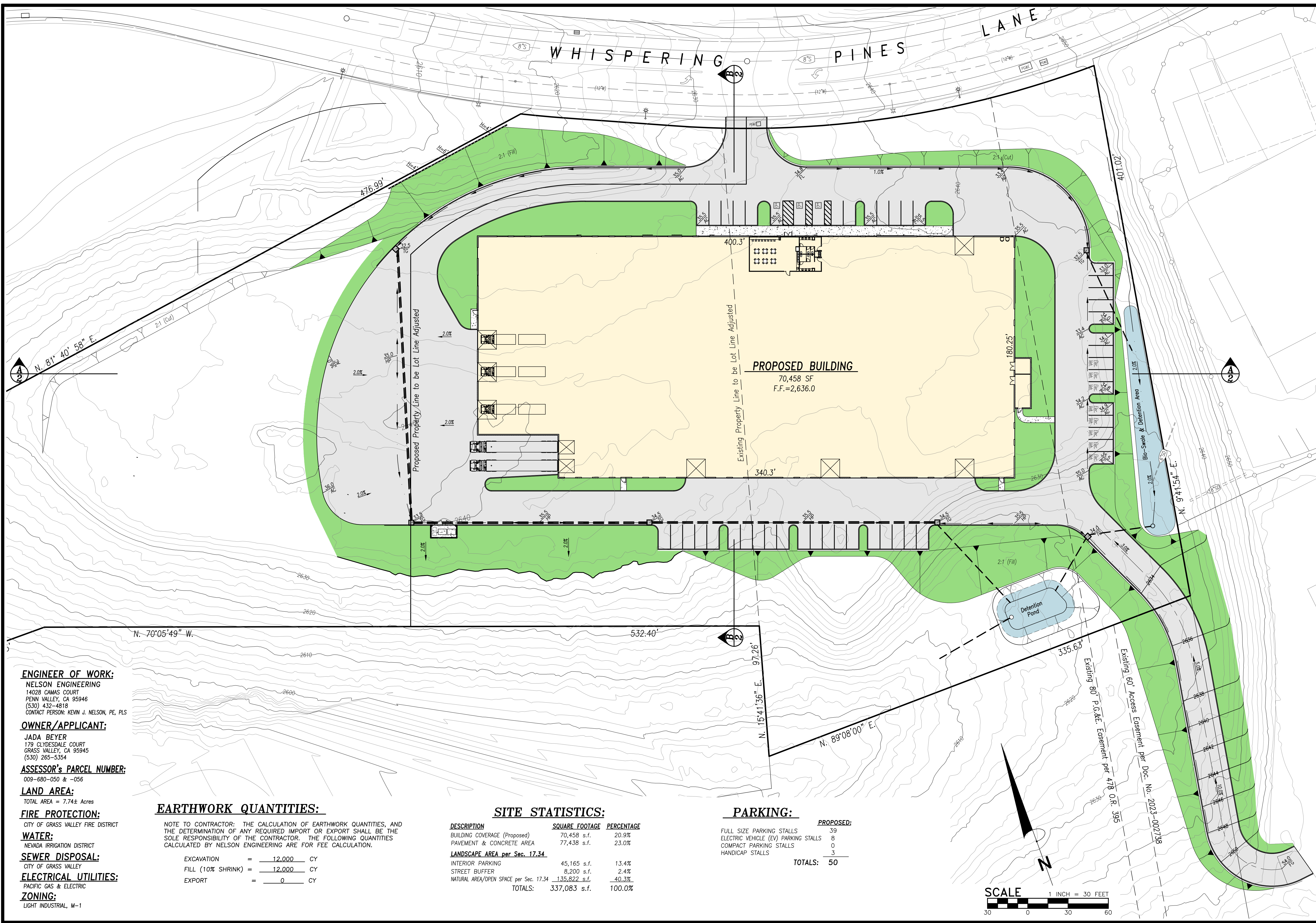



**ENGINEER OF WORK:**  
**NELSON ENGINEERING**  
 14028 CAMAS COURT  
 PENNY VALLEY, CA 95946  
 (530) 432-4818  
 CONTACT PERSON: KEVIN J. NELSON, PE, PLS

**OWNER/APPLICANT:**  
**JADA BEYER**  
 179 CLYDESDALE COURT  
 GRASS VALLEY, CA 95945  
 (530) 265-5354

**ASSESSOR'S PARCEL NUMBER:**  
 009-680-050 & -056

**LAND AREA:**  
 TOTAL AREA = 7.74± Acres

**FIRE PROTECTION:**  
 CITY OF GRASS VALLEY FIRE DISTRICT

**WATER:**  
 NEVADA IRRIGATION DISTRICT

**SEWER DISPOSAL:**  
 CITY OF GRASS VALLEY

**ELECTRICAL UTILITIES:**  
 PACIFIC GAS & ELECTRIC

**ZONING:**  
 LIGHT INDUSTRIAL, M-1

**EARTHWORK QUANTITIES:**

NOTE TO CONTRACTOR: THE CALCULATION OF EARTHWORK QUANTITIES, AND THE DETERMINATION OF ANY REQUIRED IMPORT OR EXPORT SHALL BE THE SOLE RESPONSIBILITY OF THE CONTRACTOR. THE FOLLOWING QUANTITIES CALCULATED BY NELSON ENGINEERING ARE FOR FEE CALCULATION.

EXCAVATION	=	12,000	CY
FILL (10% SHRINK)	=	12,000	CY
EXPORT	=	0	CY

**SITE STATISTICS:**

DESCRIPTION	SQUARE FOOTAGE	PERCENTAGE
BUILDING COVERAGE (Proposed)	70,458 s.f.	20.9%
PAVEMENT & CONCRETE AREA	77,438 s.f.	23.0%
<b>LANDSCAPE AREA per Sec. 17.34</b>		
INTERIOR PARKING	45,165 s.f.	13.4%
STREET BUFFER	8,200 s.f.	2.4%
NATURAL AREA/OPEN SPACE per Sec. 17.34	135,822 s.f.	40.3%
<b>TOTALS:</b>	<b>337,083 s.f.</b>	<b>100.0%</b>

**PARKING:**

	PROPOSED:
FULL SIZE PARKING STALLS	39
ELECTRIC VEHICLE (EV) PARKING STALLS	8
COMPACT PARKING STALLS	0
HANDICAP STALLS	3
<b>TOTALS:</b>	<b>50</b>



PRELIMINARY SITE PLAN FOR:  
**JADA WINDOWS**  
 A.P.N. 009-680-050 & -056

**NELSON ENGINEERING**  
 Civil Engineering, Surveying & Land Planning  
 (530) 432-4818  
 www.nelsonengineer.com

14028 Camas Court  
 Penny Valley, CA 95946

DESIGNED: KJN  
 DRAWN: KJN  
 CHECKED BY: KJN  
 DATE: August 26, 2024  
 PROJECT No.: 21-242  
 DWG. NAME: 21-242 Site Plan-4.dwg

NO. REVISIONS

COUNTY OF NEVADA, CALIFORNIA

1 OF 2



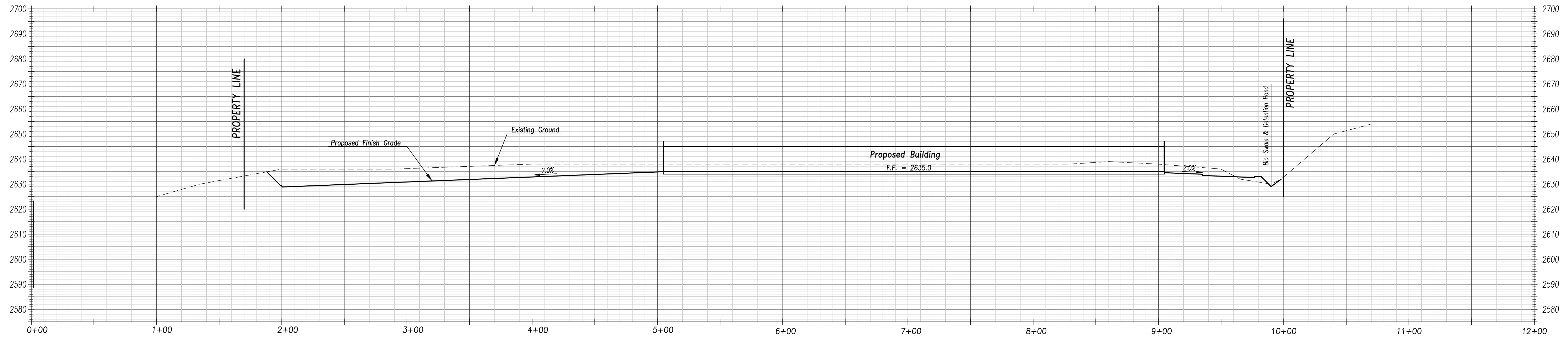

**Cross Section "A-A"**

Scales: Horiz.: 1" = 40'  
Vert.: 1" = 20'

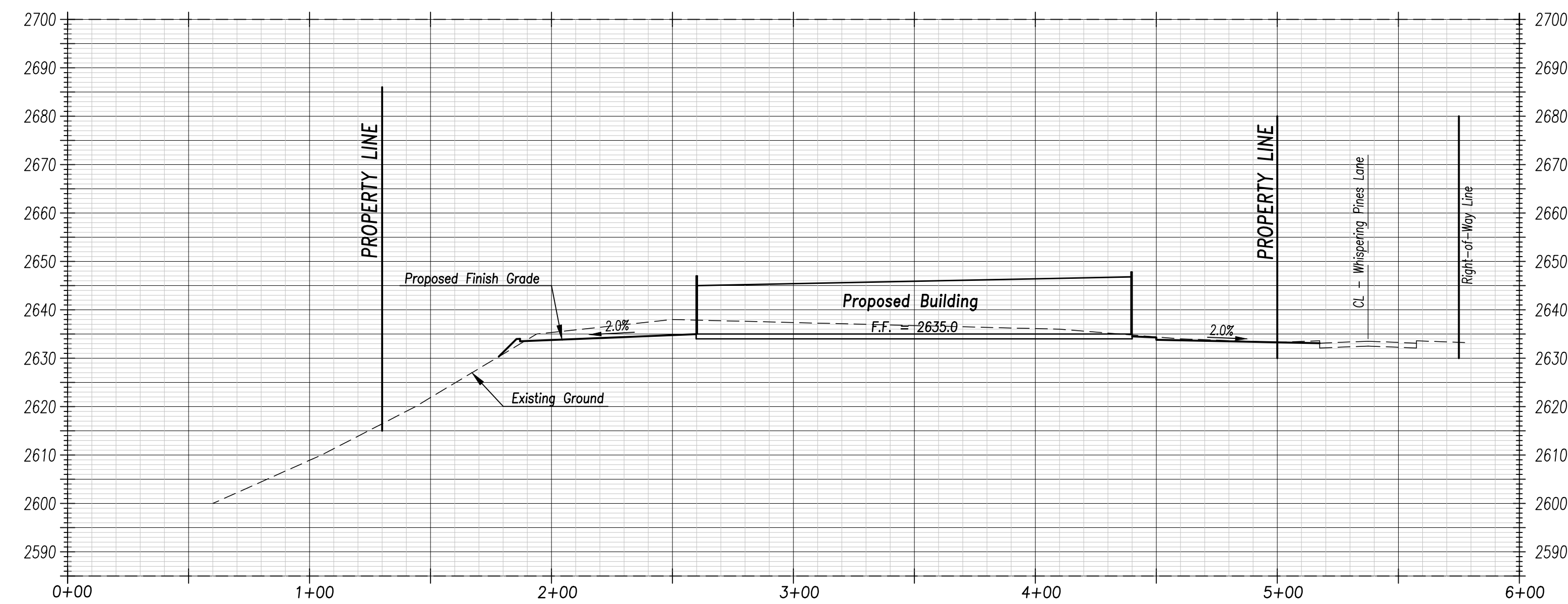

**Cross Section "B-B"**

Scales: Horiz.: 1" = 40'  
Vert.: 1" = 20'

DESIGNED BY:	KUN
DRAWN BY:	KUN
CHECKED BY:	KUN
DATE:	August 26, 2024
PROJECT NO.:	21-242
DWG. NAME:	21-242 Site Plan-4.dwg

NO.	REVISIONS	DATE

PRELIMINARY CROSS-SECTIONS FOR:  
**JADA WINDOWS**  
 A.P.N. 009-680-050 & -056  
 COUNTY OF NEVADA, CALIFORNIA

**NELSON ENGINEERING**  
 Civil Engineering, Surveying & Land Planning  
 (530) 432-4618  
 www.nelsonengr.com  
 14028 Camas Court  
 Fern Valley, CA 95946





VISUAL

Symbol	Label	Image	QTY	Manufacturer	Catalog	Description	Number	Lamp	LLF	Input	Polar Plot
□	PRV-XL PA3 A		0	COOPER LIGHTING SOLUTIONS - LINMARK (FORMERLY GATOR)	PRV-XL-PA3A-740-U-New	PREVAL AREA AND ROADWAY LUMINAIRE (25 TO 35K, 4000K, 700MA LIGHT ENGINES) WITH 24 LEDs AND TYPE IV WIDE OPTICS	24	1014	1	172	
□	PRV PA2 B		14	COOPER LIGHTING SOLUTIONS - LINMARK (FORMERLY GATOR)	PRV-PA2B-740-U-New	PREVAL AREA AND ROADWAY LUMINAIRE (25 TO 35K, 4000K, 700MA LIGHT ENGINES) WITH 24 LEDs AND TYPE IV WIDE OPTICS	96	203	1	151	

Description	Symbol	Avg	Max	Min	Max/Min	Avg/Min
Calc Zone #3	+	1.2 fc	2.0 fc	0.8 fc	2.5:1	1.5:1
Commercial Spill Zone	+	0.0 fc	0.0 fc	0.0 fc	N/A	N/A
Parking Lot		2.1 fc	6.2 fc	0.5 fc	12.4:1	4.3:1
Whispering Lane Rd	+	0.0 fc	0.1 fc	0.0 fc	N/A	N/A
Calc Zone #1	+	2.2 fc	6.2 fc	0.5 fc	12.4:1	4.4:1

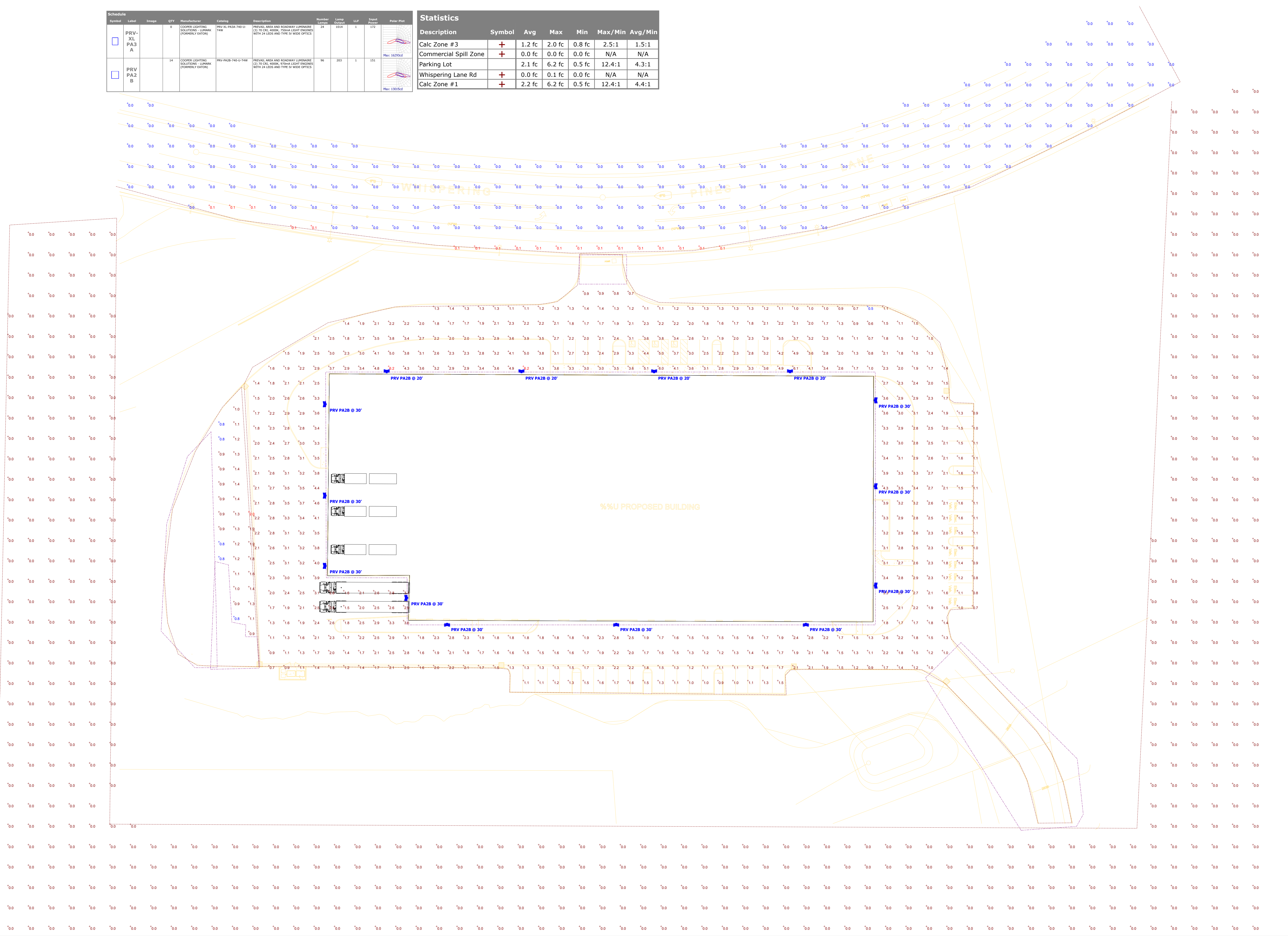

Plan View

Designer  
Date 5/5/2022  
Scale Not to Scale  
Drawing No.  
Summary







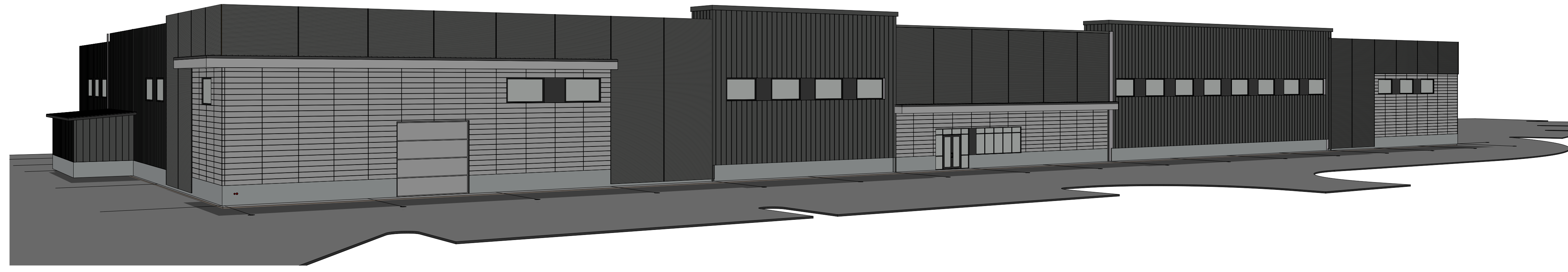

4 EAST ELEVATION  
SCALE: 1/16" = 1'-0"

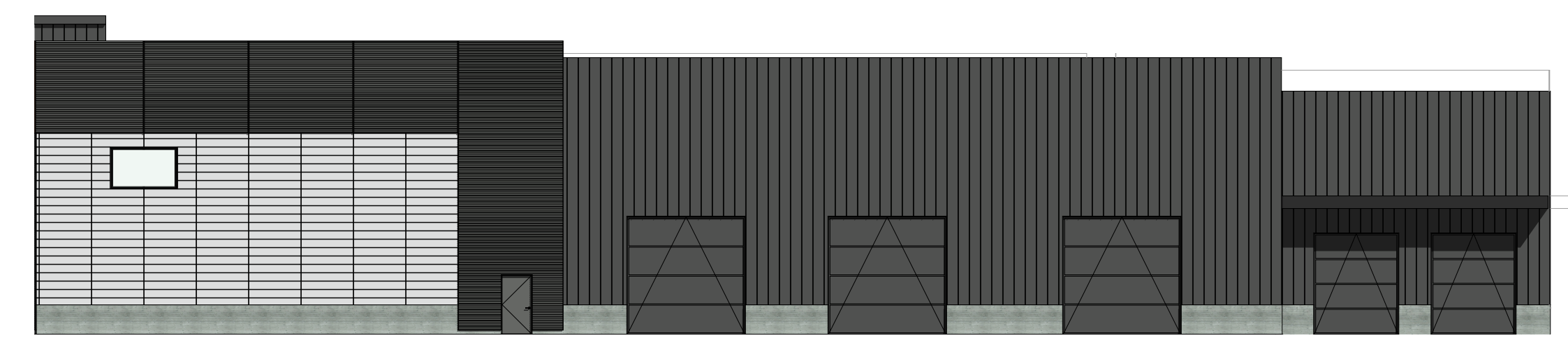

3 WEST ELEVATION  
SCALE: 1/16" = 1'-0"

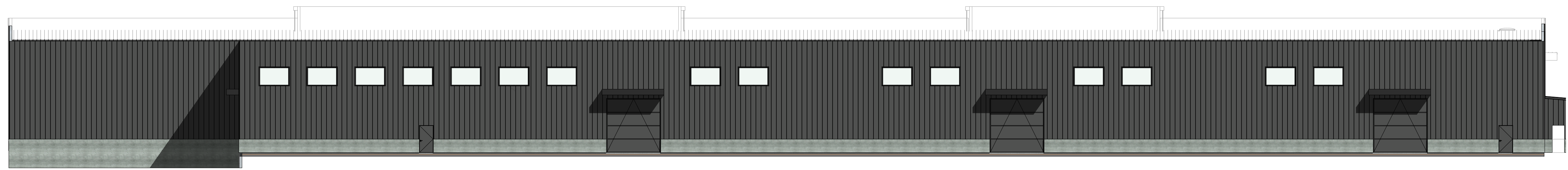

2 SOUTH ELEVATION  
SCALE: 1/16" = 1'-0"

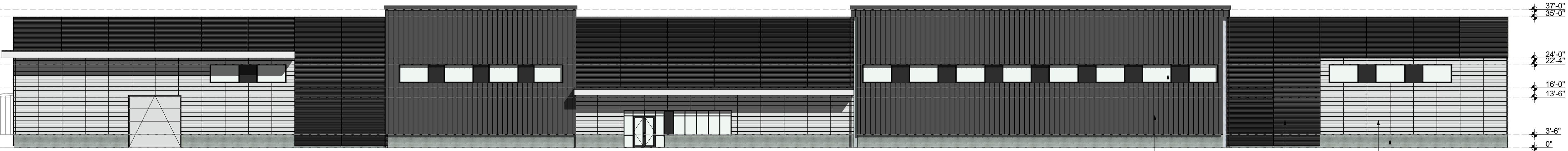

1 NORTH ELEVATION  
SCALE: 1/16" = 1'-0"

**GENERAL NOTES**

1. REFER TO SHEET A6.0 FOR WINDOW & DOOR SCHEDULES.
2. INSTALL ALL FINISHES PER MANUFACTURER SPECIFICATIONS

**FINISH KEYNOTES**

- F1 BASE PRODUCT: CAST IN PLACE CONC. FINISH: BOARD FORMED
- F2 WALL - TYPICAL MANUFACTURE: METAL SIDING TYPE: MCELROY PRODUCT: FW PANEL FINISH: BRITE WHITE
- F3 WALL - TYPICAL MANUFACTURE: METAL SIDING TYPE: MCELROY PRODUCT: MULTI-COR FINISH: ASH GRAY
- F4 WALL - TYPICAL MANUFACTURE: METAL SIDING TYPE: MCELROY PRODUCT: MEDALLION-LOK FINISH: CHARCOAL
- F5 WALL - TYPICAL MANUFACTURE: METAL SIDING TYPE: MCELROY PRODUCT: MEDALLION-LOK FINISH: MATTE BLACK

**KEYNOTES**

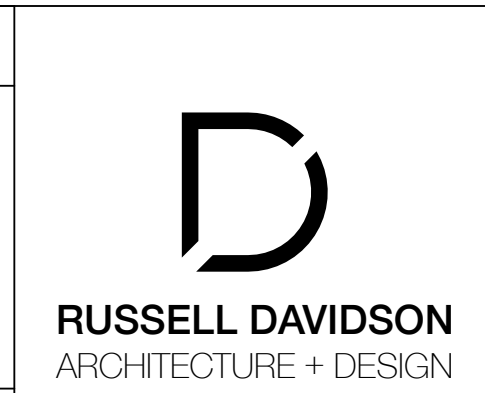

**COORDINATION SET  
NOT FOR CONSTRUCTION**

**JADA ASSEMBLY FACILITY**  
#Site Address1  
#Site City, #Site State #Site Postcode  
APN: #APN

ID	NAME	DATE

SUBMITTED:	DATE
SCALE:	AS NOTED
DRAWN BY:	RPD
CHECKED BY:	RPD
JOB:	---

**BUILDING  
ELEVATIONS**

**A2.0**

J:\Users\russellrda\OneDrive - Russell Davidson Architecture\Projects\Current\2024\_25\_Jada\Arch\CAD\Current\Jada New Building.rvt



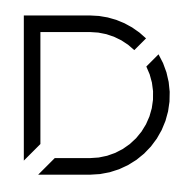

**RUSSELL DAVIDSON**  
ARCHITECTURE + DESIGN

COORDINATION SET  
NOT FOR CONSTRUCTION

**JADA ASSEMBLY FACILITY**

#Site Address1  
#Site City, #Site State #Site Postcode  
APN: #APN

ID	NAME	DATE

SUBMITTED:	DATE
SCALE:	AS NOTED
DRAWN BY:	RPD
CHECKED BY:	RPD
JOB:	---

**BUILDING  
ELEVATIONS**

**A2.1**

J:\Users\russellrda\OneDrive - Russell Davidson Architecture + Design\Projects\Current\2024\_25\_Jada\Arch\CAD\Current\Jada New Building.rvt





J:\Users\russell\RD\A\1\Dropbox\RD\A\1\Projects\Current\2024\_25\_Jada\Achl\CA\Current\Jada\_New\_Building.rvt

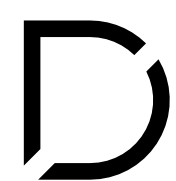

**RUSSELL DAVIDSON**  
ARCHITECTURE + DESIGN

COORDINATION SET  
NOT FOR CONSTRUCTION

**JADA ASSEMBLY FACILITY**

#Site Address1  
#Site City, #Site State #Site Postcode  
#APN: #APN

ID	NAME	DATE

SUBMITTED:	DATE
SCALE:	AS NOTED
DRAWN BY:	RPD
CHECKED BY:	RPD
JOB:	---

**BUILDING  
ELEVATIONS**

**A2.2**







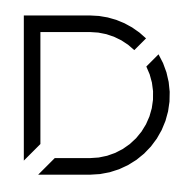

**RUSSELL DAVIDSON**  
ARCHITECTURE + DESIGN

COORDINATION SET  
NOT FOR CONSTRUCTION

**JADA ASSEMBLY FACILITY**

#Site Address1  
#Site City, #Site State #Site Postcode  
APN: #APN

ID	NAME	DATE

SUBMITTED:	DATE
SCALE:	AS NOTED
DRAWN BY:	RPD
CHECKED BY:	RPD
JOB:	--

**SITE VIEWS**



Project		Catalog #		Type	
Prepared by		Notes		Date	



# Lumark

## Prevail Discrete LED

Area / Site Luminaire

### Product Features



### Product Certifications



### Interactive Menu

- Ordering Information [page 2](#)
- Mounting Details [page 3, 4](#)
- Optical Configurations [page 5](#)
- Product Specifications [page 5](#)
- Energy and Performance Data [page 6](#)
- Control Options [page 8](#)

### Quick Facts

- Direct-mounted discrete light engine for improved optical uniformity and visual comfort
- Lumen packages range from 4,300 - 68,000 nominal lumens (30W - 550W)
- Replaces 70W up to 1,000W HID equivalents
- Efficacies up to 157 lumens per watt
- Standard universal quick mount arm with universal drill pattern

### Connected Systems

- WaveLinx PRO Wireless
- WaveLinx LITE Wireless

### Dimensional Details

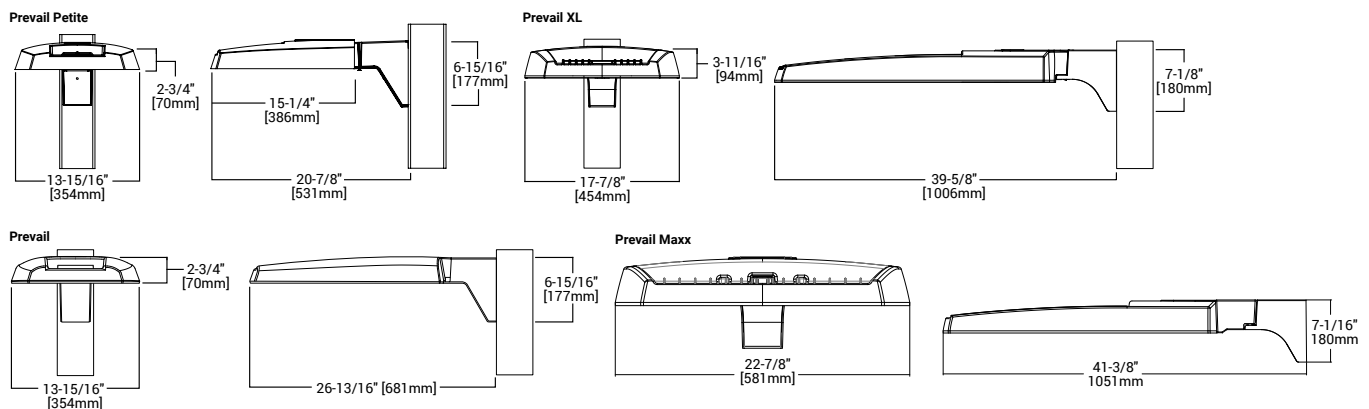

NOTES:  
 1. Visit <https://www.designlights.org/search/> to confirm qualification. Not all product variations are DLC qualified.  
 2. IDA Certified for 3000K CCT and warmer only.



Ordering Information

SAMPLE NUMBER: PRV-XL-PA4B-740-U-T4W-BZ

Product Family <sup>1,2</sup>	Light Engine		Color Temperature	Voltage	Distribution	Mounting (Included)	Finish			
	Configuration	Drive Current <sup>4</sup>								
<b>PRV-P</b> =Prevail Petite <b>BAA-PRV-P</b> =Prevail Petite BAA Buy American Act Compliant <sup>3</sup> <b>TAA-PRV-P</b> =Prevail Petite TAA Trade Agreements Act Compliant <sup>3</sup>	<b>PA1</b> =1 Panel, 24 LED Rectangle	<b>A</b> =400mA Nominal <b>B</b> =700mA Nominal <b>C</b> =950mA Nominal <b>D</b> =1200mA Nominal	<b>740</b> =70CRI, 4000K <b>730</b> =70CRI, 3000K <b>750</b> =70CRI, 5000K <b>8540</b> =85CRI, 4000K	<b>U</b> =Universal, 120-277V <b>H</b> =High Voltage, 347-480V 1=120V 2=208V 3=240V 4=277V 8=480V <sup>5</sup> 9=347V <b>DV</b> =DuraVolt, 277-480V <sup>5,6</sup>	<b>T2R</b> =Type II Roadway <b>T2U</b> =Type II Urban <b>T3</b> =Type III <b>T4W</b> =Type IV Wide <b>5WQ</b> =Type V Square Wide	<b>SA</b> =QM Standard Versatile Arm <b>MA</b> =QM Mast Arm <b>FMA</b> =Fixed Mast Arm <sup>27</sup> <b>WM</b> =QM Wall Mount Arm <b>ADJA-WM</b> = Adjustable Arm - Wall Mount <sup>29</sup> <b>ADJA</b> =Adjustable Arm - Pole Mount <sup>29</sup> <b>ADJS</b> =Adjustable Arm - Slipfitter, 3" vertical tenon <sup>29</sup> <b>SP2</b> =Adjustable Arm - Slipfitter, 2 3/8" vertical tenon <sup>27, 29</sup>	<b>AP</b> =Grey <b>BZ</b> =Bronze <b>BK</b> =Black <b>DP</b> =Dark Platinum <b>GM</b> =Graphite Metallic <b>WH</b> =White			
<b>PRV</b> =Prevail <b>BAA-PRV</b> =Prevail BAA Buy American Act Compliant <sup>3</sup> <b>TAA-PRV</b> =Prevail TAA Trade Agreements Act Compliant <sup>3</sup>	<b>PA1</b> =1 Panel, 24 LED Rectangle <b>PA2</b> =2 Panels, 48 LED Rectangles	<b>A</b> =700mA Nominal <b>B</b> =950mA Nominal								
<b>PRV-XL</b> =PRV XL <b>BAA-PRV-XL</b> =Prevail XL BAA Buy American Act Compliant <sup>3</sup> <b>TAA-PRV-XL</b> =Prevail XL TAA Trade Agreements Act Compliant <sup>3</sup>	<b>PA3</b> =3 Panels, 72 LED Rectangles <b>PA4</b> =4 Panels, 96 LED Rectangles	<b>A</b> =750mA Nominal <b>B</b> =950mA Nominal								
<b>PRV-M</b> =Prevail Maxx <b>BAA-PRV-M</b> =Prevail Maxx BAA Buy American Act Compliant <sup>3</sup> <b>TAA-PRV-M</b> =Prevail Maxx TAA Trade Agreements Act Compliant <sup>3</sup>	<b>PA6</b> = 6 Panels, 144 LED Rectangles	<b>A</b> =600mA Nominal <b>B</b> =800mA Nominal <b>C</b> =1000mA Nominal <b>D</b> =1200mA Nominal								
<b>Options (Add as Suffix)</b>			<b>Accessories (Order Separately) <sup>20, 21</sup></b>							
<b>10K</b> =10kV UL 1449 Fused Surge Protective Device <b>20MSP</b> =20kV MOV Surge Protective Device <b>20K</b> =20kV UL 1449 Fused Surge Protective Device <b>F</b> =Single Fuse (Used with Voltages 120, 277 or 347V) <b>FF</b> =Double Fuse (Used with Voltages 208, 240 or 480V) <b>FADC</b> =Field Adjustable Dimming Controller <sup>30</sup> <b>L90</b> =Optics Rotated 90° Left <b>R90</b> =Optics Rotated 90° Right <b>CC</b> =Coastal Construction finish <sup>9</sup> <b>HSS</b> =House Side Shield (Factory Installed) <sup>7</sup> <b>HA</b> =50°C High Ambient Temperature <sup>8</sup> <b>PR</b> =NEMA 3-PIN Twistlock Photocontrol Receptacle <sup>10</sup> <b>PR7</b> =NEMA 7-PIN Twistlock Photocontrol Receptacle <sup>10</sup> <b>MS/DIM-L08</b> =Motion Sensor for Dimming Operation, Up to 8' Mounting Height <sup>11, 12, 13</sup> <b>MS/DIM-L20</b> =Motion Sensor for Dimming Operation, 9' - 20' Mounting Height <sup>11, 12, 13</sup> <b>MS/DIM-L40</b> =Motion Sensor for Dimming Operation, 21' - 40' Mounting Height <sup>11, 12, 13</sup> <b>SPB1</b> =Motion Sensor for Dimming Operation, BLE Interface, Up to 8' Mounting Height <sup>11, 14</sup> <b>SPB2</b> =Motion Sensor for Dimming Operation, BLE Interface, 8' - 20' Mounting Height <sup>11, 14, 27, 28</sup> <b>SPB4</b> =Motion Sensor for Dimming Operation, BLE Interface, 21' - 40' Mounting Height <sup>11, 14, 28</sup>			<b>WPS2XX</b> =Wavelinx Pro, SR Driver, Dimming Motion and Daylight, WAC Programmable, 7' - 15' Mounting Height <sup>11, 12, 15, 16, 17</sup> <b>WPS4XX</b> =Wavelinx Pro, SR Driver, Dimming Motion and Daylight, WAC Programmable, 15' - 40' Mounting Height <sup>11, 12, 15, 16, 17</sup> <b>WLS2XX</b> =WaveLinx Lite, SR Driver, Dimming Motion and Daylight, Bluetooth Programmable, 7' - 15' Mounting Height <sup>11, 12, 15, 16, 17</sup> <b>WLS4XX</b> =WaveLinx Lite, SR Driver, Dimming Motion and Daylight, Bluetooth Programmable, 15' - 40' Mounting Height <sup>11, 12, 15, 16, 17</sup> <b>(See Table Below)</b> =LumenSafe Integrated Network Security Camera <sup>18, 19</sup>			<b>PRVSA-XX</b> =Standard Arm Mounting Kit <sup>22</sup> <b>PRVMA-XX</b> =Mast Arm Mounting Kit <sup>22</sup> <b>PRVWM-XX</b> =Wall Mount Kit <sup>22</sup> <b>PRVADJA-XX</b> =Adjustable Arm - Pole Mount Kit <sup>22</sup> <b>PRVADJS-XX</b> =Adjustable Arm - Slipfitter Kit <sup>22</sup> <b>PRVADJA-WM-XX</b> =Adjustable Arm - Wall Mount Kit <sup>22</sup> <b>PRVXLSA-XX</b> =Standard Arm Mounting Kit <sup>28</sup> <b>PRVXLMMA-XX</b> =Mast Arm Mounting Kit <sup>28</sup> <b>PRVXLWM-XX</b> =Wall Mount Kit <sup>28</sup> <b>PRV-XL-ADJA-XX</b> =Adjustable Arm - Pole Mount Kit <sup>28</sup> <b>PRV-XL-ADJA-WM-XX</b> = Adjustable Arm - Wall Mount Kit <sup>28</sup> <b>PRV-XL-ADJS-XX</b> = Adjustable Arm - Slipfitter Kit <sup>28</sup> <b>PRV-M-ADJA-XX</b> =Adjustable Arm - Pole Mount Kit <sup>27</sup> <b>PRV-M-ADJS-XX</b> =Adjustable Arm - Slipfitter Kit <sup>27</sup> <b>PRV-M-ADJA-WM-XX</b> =Adjustable Arm - Wall Mount Kit <sup>27</sup> <b>MA1010-XX</b> =Single Tenon Adapter for 3-1/2" O.D. Tenon <b>MA1011-XX</b> =2@180° Tenon Adapter for 3-1/2" O.D. Tenon <b>MA1017-XX</b> =Single Tenon Adapter for 2-3/8" O.D. Tenon <b>MA1018-XX</b> =2@180° Tenon Adapter for 2-3/8" O.D. Tenon <b>SRA238</b> =Tenon Adapter from 3" to 2-3/8" <b>PRV/DIS-FDV</b> =Full Drop Visor <sup>23</sup> <b>PRVXL/DIS-FDV</b> =Full Drop Visor <sup>18</sup> <b>HSS-VP</b> =House Side Shield Kit, Vertical Panel <sup>7, 24</sup> <b>HSS-HP</b> =House Side Shield Kit, Horizontal Panel <sup>7, 24</sup> <b>VGS-ARCH</b> = Panel Drop Shield, Short <b>VGL-ARCH</b> = Panel Drop Shield, Long <b>OA/RA1013</b> =Photocontrol Shorting Cap <b>OA/RA1014</b> =NEMA Photocontrol - 120V <b>OA/RA1016</b> =NEMA Photocontrol - Multi-Tap 105-285V <b>OA/RA1201</b> =NEMA Photocontrol - 347V <b>OA/RA1027</b> =NEMA Photocontrol - 480V <b>FSIR-100</b> =Wireless Configuration Tool for Occupancy Sensor <sup>25</sup> <b>WOLC-7P-10A</b> =WaveLinx Outdoor Control Module (7-PIN) <sup>26</sup>				
<b>NOTES:</b> 1. DesignLights Consortium® Qualified. Refer to <a href="http://www.designlights.org">www.designlights.org</a> Qualified Products List under Family Models for details. 2. Customer is responsible for engineering analysis to confirm pole and fixture compatibility for applications. Refer to installation instructions and pole white paper WPS13001EN for additional support information. 3. Only product configurations with these designated prefixes are built to be compliant with the Buy American Act of 1933 (BAA) or Trade Agreements Act of 1979 (TAA), respectively. Please refer to <a href="http://www.designlights.org">www.designlights.org</a> website for more information. Components shipped separately may be separately analyzed under domestic preference requirements. 4. Nominal drive currents shown here. For actual drive current by configuration, refer to Power and Lumens tables. 5. 480V not to be used with ungrounded or impedance grounded systems. 6. DuraVolt drivers feature added protection from power quality issues such as loss of neutral, transients and voltage fluctuations. Visit <a href="http://www.signify.com/duravolt">www.signify.com/duravolt</a> for more information. 7. House Side Shield not for use with 5WQ distribution. 8. Not available with PATD light engine in Petite housing (PRV-P). 9. Coastal construction finish salt spray tested to over 5,000-hours per ASTM B117, with a scribe rating of 9 per ASTM D1654. 10. If High Voltage (H) or DuraVolt (DV) is specified, use a photocontrol that matches the input voltage used. 11. Controls system is not available in combination with a photocontrol receptacle (PR or PR7) or another controls system (MS SPB). 12. Option not available with High Voltage (H) or DuraVolt (DV). Must specify Universal (U), 347V (9), or 480V (8) voltage. 13. Utilizes the Wattstopper sensor FSP-211. Sensor color white unless specified otherwise via PDR. To field-configure, order FSIR-100 accessory separately. 14. Utilizes the Wattstopper sensor FSP-3XX series. Sensor color determined by product finish. See Sensor Color Reference Table. Field-configures via mobile application. See Controls section for details. 15. Sensor passive infrared (PIR) may be overly sensitive when operating below -20°C (-4°F). 16. In order for the device to be field-configurable, requires WAC Gateway components WAC-PoE and WPOE-120 in appropriate quantities. Only compatible with WaveLinx system and software and requires system components to be installed for operation. See website for more WaveLinx application information. 17. Replace XX with sensor color (WH, BZ or BK). 18. Only available in PRV-XL configurations. 19. Not available with High Voltage (H, DV, 8 or 9) or HA options. Consult LumenSafe system product pages for additional details and compatibility information. 20. Replace XX with paint color. 21. For BAA or TAA requirements, Accessories sold separately will be separately analyzed under domestic preference requirements. Consult factory for further information. 22. Not for use with PRV-XL or PRV-M configurations. 23. Only for use with PRV. Not applicable to PRV-M, PRV-XL, or PRV-P. 24. Must order one per optic/LED when ordering as a field-installable accessory (1, 2, 3, 4, or 6). Refer to House Side Shield reference table for details. 25. This tool enables adjustment to Motion Sensor (MS) parameters including high and low modes, sensitivity, time delay, cutoff and more. Consult your lighting representative for more information. 26. Requires 7-PIN NEMA twistlock photocontrol receptacle (PR7) option. The WOLC-7 cannot be used in conjunction with other controls systems (MS or LWR). Only for use at 120-347V. 27. Only available for PRV-M configurations. 28. Only for use with PRV-XL. 29. Fixed for PRV-M. 30. Cannot be used with PR7 or other motion response control options.										

LumenSafe Integrated Network Security Camera Technology Options (Add as Suffix)

Product Family	Camera Type	Data Backhaul
<b>L</b> =LumenSafe Technology 	<b>H</b> =Dome Camera, High Res <b>Z</b> =Dome Camera, Remote PTZ	<b>C</b> =Cellular, Customer Installed SIM Card <b>A</b> =Cellular, Factory Installed AT&T SIM Card <b>V</b> =Cellular, Factory Installed Verizon SIM Card <b>S</b> =Cellular, Factory Installed Sprint SIM Card <b>E</b> =Ethernet Networking



Mounting Details

SA=QM Pole Mount Arm (PRV & PRV-P)

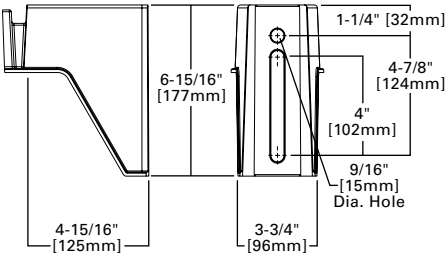

SA=QM Pole Mount Arm (PRV-XL)

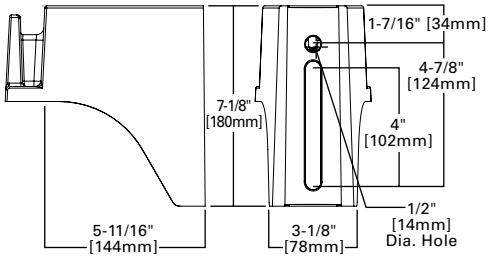

WM=QM Wall Mount Arm (PRV & PRV-P)

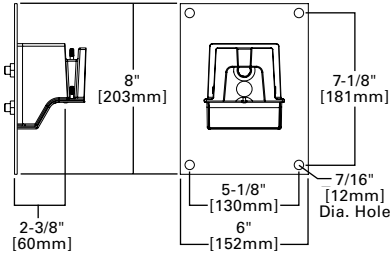

WM=QM Wall Mount Arm (PRV-XL)

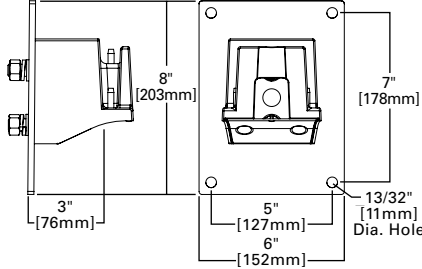

MA=QM Mast Arm (PRV & PRV-P)

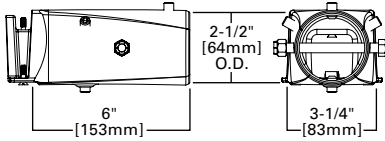

MA=QM Mast Arm (PRV-XL)

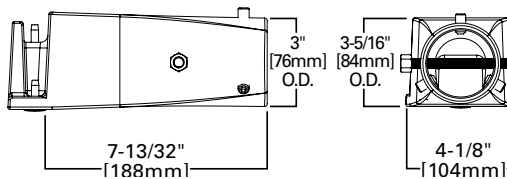

ADJA=Adjustable Arm Pole Mount (PRV & PRV-P)

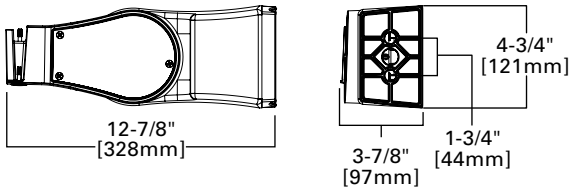

ADJA=Adjustable Arm Pole Mount (PRV-XL)

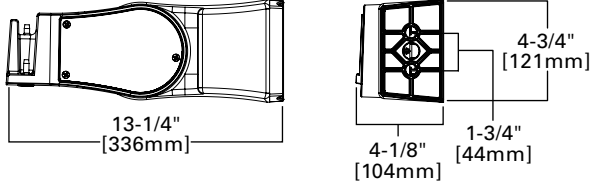

ADJA-WM=Adjustable Arm Wall Mount (PRV & PRV-P)

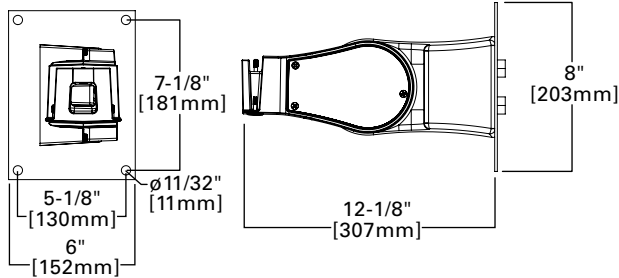

ADJA-WM=Adjustable Arm Wall Mount (PRV-XL)

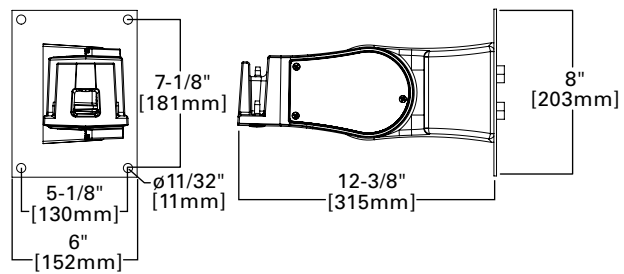

ADJS=Adjustable Slipfitter 3 (PRV & PRV-P)

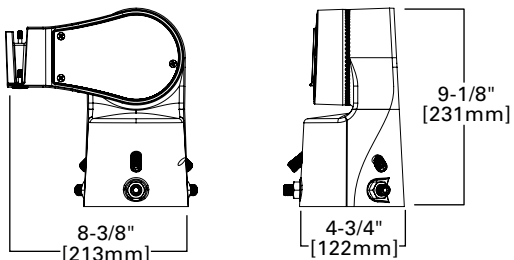

ADJS=Adjustable Slipfitter 3 (PRV-XL)

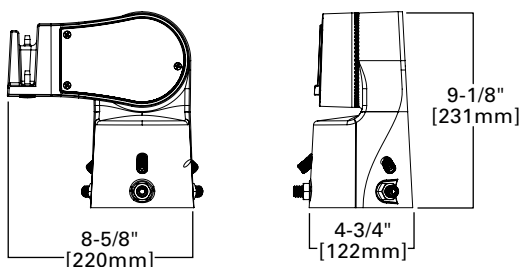



Mounting Details

SA=QM Pole Mount Arm (PRV-M)

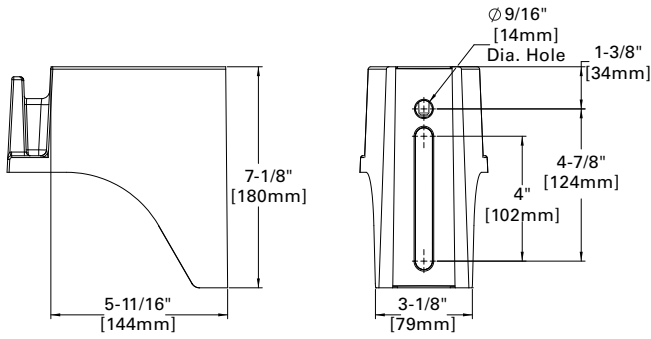

WM=QM Wall Mount Arm (PRV-M)

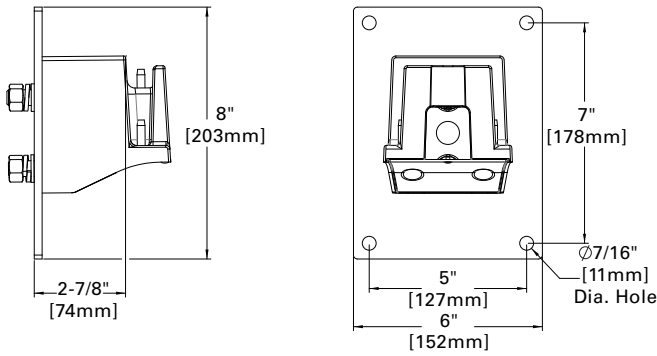

MA=QM Mast Arm (PRV-M)

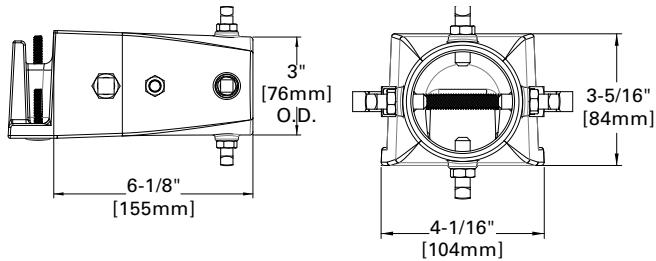

FMA=Fixed Mast Arm (PRV-M)

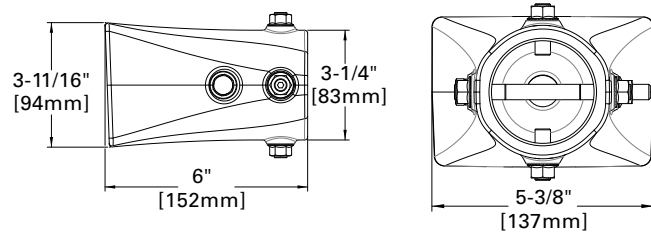

ADJA=Adjustable Pole Mount Arm (PRV-M)

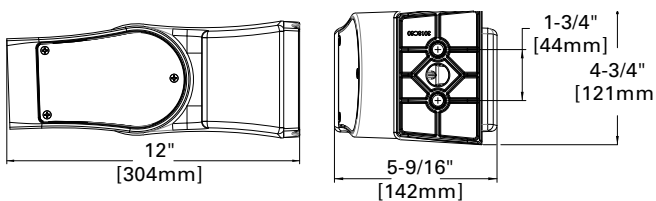

Versatile Mount System

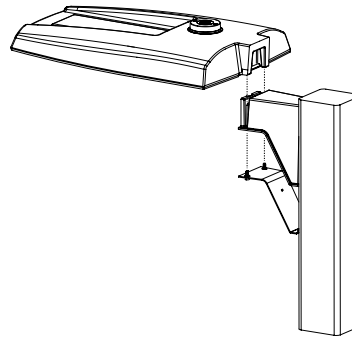

ADJS=Adjustable Slipfitter (PRV-M)

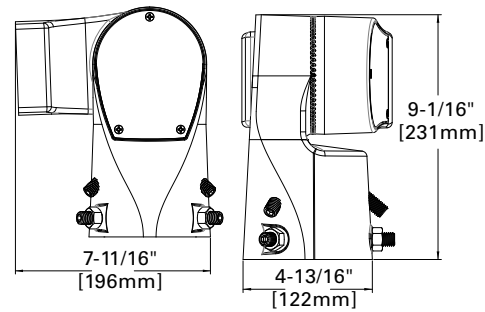

SP2=Adjustable Slipfitter 2-3/8\" (PRV-M)

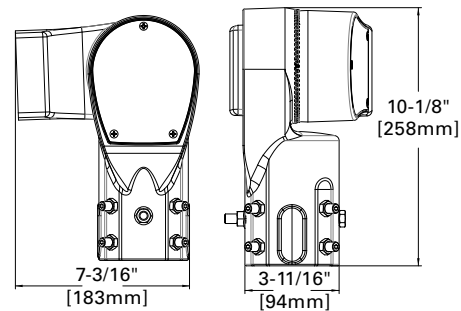



## Mounting Details

### Mounting Configurations and EPAs

**NOTE:** For 2 PRV's mounted at 90°, requires minimum 3" square or 4" round pole for fixture clearance. For 2 PRV-XL's mounted at 90°, requires minimum 4" square or round pole for fixture clearance. Customer is responsible for engineering analysis to confirm pole and fixture compatibility for applications

Housing Size	Tilt Angle (Degrees)	Arm Mount Single	Arm Mount 2 @ 180°	Arm Mount 2 @ 90°	Arm Mount 3 @ 90°	Arm Mount 4 @ 90°
Prevail Petite	0°	0.54	1.08	0.84	1.38	1.38
	60°	1.68	1.85	2.42	3.15	3.30
Prevail	0°	0.92	1.35	1.42	1.63	1.63
	60°	2.20	2.40	3.05	3.88	4.07
	60° + Full Drop Visor	2.20	2.40	3.25	4.28	4.47
Prevail XL	0°	1.12	2.25	2.13	2.52	2.52
	60°	3.99	4.30	5.26	6.51	6.79
	60° + Full Drop Visor	3.99	4.30	5.59	7.17	7.49
Prevail Maxx	0°	1.28	2.56	1.7	2.69	2.69
	60°	5.09	5.52	6.34	7.49	7.81

## Optical Configurations

PRV-P-PA1X

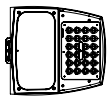

PRV-PA1X

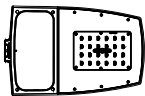

PRV-PA2X

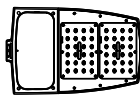

PRV-XL-PA3X

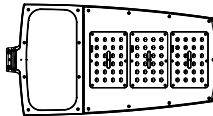

PRV-XL-PA4X

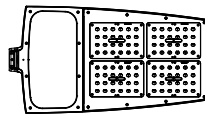

PRV-M-PA6X

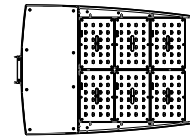

### Optical Distributions

T2R  
(Type II Roadway)

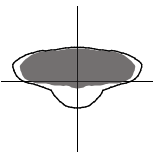

T2U  
(Type II Urban)

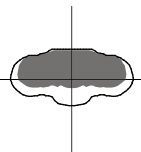

T3  
(Type III)

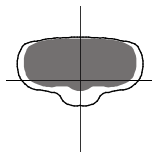

T4W  
(Type IV Wide)

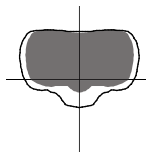

5WQ  
(Type V Square Wide)

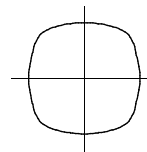

■ = Distribution with House Side Shield (HSS)  
□ = Optical Distribution

## Product Specifications

### Construction

- Single-piece die-cast aluminum housing
- Tethered die-cast aluminum door

### Optics

- Dark Sky Approved (3000K CCT and warmer only)
- Precision molded polycarbonate optics

### Electrical

- -40°C minimum operating temperature
- 40°C maximum operating temperature
- >.9 power factor
- <20% total harmonic distortion
- Class 1 electronic drivers have expected life of 100,000 hours with <1% failure rate
- 0-10V dimming driver is standard with leads external to the fixture
- Standard MOV surge protective device designed to withstand 10kV of transient line surge

- Luminaire available with the field adjustable dimming controller (FADC) to manually adjust wattage and reduce the total lumen output and light levels; Comes pre-set to the highest position at the lumen output selected

### Mounting

- Versatile, patented, standard mount arm accommodates multiple drill patterns ranging from 1-1/2" to 4-7/8" (Type M drilling recommended for new installations)
- A knock-out on the standard mounting arm enables round pole mounting
- Adjustable pole and wall mount arms adjust in 5° increments from 0° to 60°; Downward facing orientation only (Type N drilling required for ADJA mount)
- Adjustable slipfitter arm adjusts in 5° increments from -5° to 85°; Downward facing orientation only
- Prevail and Prevail Petite: 3G vibration rated (all arms)
- Prevail XL Mast Arm: 3G vibration rated

- Prevail XL Standard Arm: 1.5G vibration rated
- Adjustable Arms: 1.5G vibration rated

### Finish

- Five-stage super TGIC polyester powder coat paint, 2.5 mil nominal thickness
- Finish is compliant to 3,000 hour salt spray standard (per ASTM B117)

### Typical Applications

- Parking lots, Walkways, Roadways and Building Areas

### Shipping Data

- Prevail Petite: 18 lbs. (7.94 kgs.)
- Prevail: 20 lbs. (9.09 kgs.)
- Prevail XL: 45 lbs. (20.41 kgs.)
- Prevail Maxx: 49 lbs. (22.23 kgs.)

### Warranty

- Five year limited warranty, consult website for details. [www.cooperlighting.com/legal](http://www.cooperlighting.com/legal)



Energy and Performance Data

Power and Lumens

[View PRV-P IES files](#)

[View PRV IES files](#)

[View PRV-XL IES files](#)

Product Family	Prevail Petite				Prevail				Prevail XL				Prevail Maxx				
Light Engine	PA1A	PA1B	PA1C	PA1D	PA1A	PA1B	PA2A	PA2B	PA3A	PA3B	PA4A	PA4B	PA6A	PA6B	PA6C	PA6D	
Power (Watts)	31	53	72	93	54	74	113	151	172	234	245	303	274	366	457	544	
Drive Current (mA)	375	670	930	1200	670	930	720	970	750	980	785	970	600	800	1000	1200	
Input Current @ 120V (A)	0.26	0.44	0.60	0.78	0.45	0.62	0.93	1.26	1.44	1.95	2.04	2.53	2.30	3.05	3.83	4.54	
Input Current @ 277V (A)	0.12	0.20	0.28	0.35	0.21	0.28	0.41	0.55	0.62	0.85	0.93	1.12	0.99	1.30	1.62	1.94	
Input Current @ 347V (A)	0.10	0.17	0.23	0.29	0.17	0.23	0.33	0.45	0.52	0.70	0.74	0.90	0.78	1.05	1.32	1.60	
Input Current @ 480V (A)	0.07	0.13	0.17	0.22	0.12	0.17	0.24	0.33	0.39	0.52	0.53	0.65	0.58	0.76	0.95	1.14	
<b>Distribution</b>																	
Type II Roadway	4000K/5000K Lumens	4,505	7,362	9,495	11,300	7,605	9,896	15,811	19,745	24,718	30,648	34,067	39,689	41,611	52,596	61,921	67,899
	BUG Rating	B1-U0-G1	B1-U0-G2	B1-U0-G2	B1-U0-G2	B1-U0-G2	B1-U0-G2	B2-U0-G3	B2-U0-G3	B3-U0-G3	B3-U0-G4	B3-U0-G4	B3-U0-G4	B3-U0-G4	B4-U0-G5	B4-U0-G5	B4-U0-G5
	Lumens per Watt	147	139	132	121	141	134	141	131	144	131	139	131	152	144	135	125
	3000K Lumens <sup>1</sup>	4,103	6,705	8,647	10,291	6,926	9,012	14,399	17,982	22,511	27,912	31,025	36,145	37,896	47,900	56,392	61,837
Type II Roadway w/ HSS	4000K/5000K Lumens	3,727	6,091	7,855	9,349	6,006	7,815	12,487	15,594	19,521	24,204	26,094	31,334	32,874	41,553	48,919	53,642
	BUG Rating	B0-U0-G1	B0-U0-G2	B0-U0-G2	B1-U0-G2	B0-U0-G1	B1-U0-G2	B1-U0-G2	B1-U0-G2	B1-U0-G3	B1-U0-G3	B1-U0-G4	B1-U0-G4	B2-U0-G4	B2-U0-G4	B2-U0-G5	B2-U0-G5
	Lumens per Watt	121	115	109	100	111	106	111	103	113	103	107	103	120	114	107	99
	3000K Lumens <sup>1</sup>	3,394	5,547	7,154	8,514	5,470	7,117	11,372	14,201	17,778	22,043	24,502	28,545	29,939	37,843	44,552	48,853
Type II Urban	4000K/5000K Lumens	4,496	7,347	9,476	11,277	7,597	9,886	15,795	19,724	24,692	30,616	34,031	39,647	41,372	52,294	61,565	67,509
	BUG Rating	B1-U0-G1	B2-U0-G2	B2-U0-G2	B3-U0-G3	B2-U0-G2	B3-U0-G3	B3-U0-G3	B3-U0-G3	B4-U0-G4	B4-U0-G4	B4-U0-G4	B4-U0-G4	B4-U0-G4	B5-U0-G5	B5-U0-G5	B5-U0-G5
	Lumens per Watt	146	139	131	121	141	134	141	131	144	131	139	131	151	143	135	124
	3000K Lumens <sup>1</sup>	4,095	6,691	8,630	10,271	6,919	9,003	14,384	17,963	22,488	27,882	30,992	36,107	37,678	47,625	56,068	61,481
Type II Urban w/ HSS	4000K/5000K Lumens	3,253	5,316	6,856	8,160	5,297	6,893	11,013	13,753	17,217	21,347	23,728	27,644	28,951	36,594	43,082	47,241
	BUG Rating	B1-U0-G1	B1-U0-G1	B1-U0-G2	B1-U0-G2	B1-U0-G1	B1-U0-G2	B1-U0-G2	B2-U0-G2	B2-U0-G2	B2-U0-G3	B2-U0-G3	B3-U0-G4	B3-U0-G4	B3-U0-G4	B3-U0-G5	B3-U0-G5
	Lumens per Watt	106	101	95	87	98	93	97	91	100	91	97	91	106	100	94	87
	3000K Lumens <sup>1</sup>	2,963	4,841	6,244	7,431	4,824	6,277	10,029	12,525	15,680	19,441	21,609	25,176	26,366	33,327	39,235	43,023
Type III	4000K/5000K Lumens	4,443	7,261	9,364	11,145	7,575	9,857	15,749	19,667	24,621	30,527	33,932	39,532	41,155	52,020	61,242	67,155
	BUG Rating	B1-U0-G1	B1-U0-G2	B2-U0-G2	B2-U0-G2	B1-U0-G2	B2-U0-G3	B3-U0-G3	B3-U0-G3	B3-U0-G4	B3-U0-G5	B3-U0-G5	B4-U0-G5	B4-U0-G5	B4-U0-G5	B4-U0-G5	B4-U0-G5
	Lumens per Watt	145	138	130	119	140	133	141	130	143	130	138	130	150	142	134	123
	3000K Lumens <sup>1</sup>	4,046	6,612	8,528	10,150	6,899	8,977	14,343	17,911	22,423	27,802	30,903	36,002	37,480	47,375	55,774	61,159
Type III w/ HSS	4000K/5000K Lumens	3,406	5,566	7,179	8,543	5,592	7,277	11,626	14,519	18,176	22,536	25,049	29,183	30,159	38,121	44,879	49,212
	BUG Rating	B0-U0-G1	B1-U0-G2	B1-U0-G2	B1-U0-G2	B1-U0-G2	B1-U0-G2	B1-U0-G2	B1-U0-G3	B2-U0-G4	B2-U0-G4	B2-U0-G4	B2-U0-G5	B2-U0-G5	B3-U0-G5	B3-U0-G5	B3-U0-G5
	Lumens per Watt	111	105	100	91	104	98	103	96	106	96	102	96	110	104	98	90
	3000K Lumens <sup>1</sup>	3,102	5,069	6,538	7,781	5,093	6,627	10,588	13,222	16,553	20,524	22,813	26,578	27,466	34,717	40,872	44,818
Type IV Wide	4000K/5000K Lumens	4,348	7,106	9,164	10,906	7,484	9,738	15,560	19,431	24,325	30,161	33,525	39,057	41,207	52,086	61,320	67,240
	BUG Rating	B1-U0-G2	B2-U0-G2	B2-U0-G2	B2-U0-G3	B2-U0-G2	B2-U0-G3	B3-U0-G3	B3-U0-G4	B3-U0-G4	B3-U0-G5	B3-U0-G5	B4-U0-G5	B4-U0-G5	B4-U0-G5	B4-U0-G5	B4-U0-G5
	Lumens per Watt	142	135	127	117	139	132	139	129	141	129	137	129	151	142	134	124
	3000K Lumens <sup>1</sup>	3,960	6,471	8,346	9,932	6,816	8,869	14,170	17,696	22,153	27,468	30,531	35,570	37,528	47,435	55,845	61,236
Type IV Wide w/ HSS	4000K/5000K Lumens	3,318	5,422	6,993	8,323	5,420	7,053	11,268	14,072	17,617	24,843	24,279	28,286	30,005	37,926	44,650	48,961
	BUG Rating	B0-U0-G1	B1-U0-G2	B1-U0-G2	B1-U0-G2	B1-U0-G2	B1-U0-G2	B1-U0-G3	B1-U0-G3	B1-U0-G4	B2-U0-G4	B2-U0-G4	B2-U0-G5	B2-U0-G5	B3-U0-G5	B3-U0-G5	B3-U0-G5
	Lumens per Watt	108	103	97	89	100	95	100	93	102	106	99	93	110	104	98	90
	3000K Lumens <sup>1</sup>	3,022	4,938	6,369	7,580	4,936	6,423	10,262	12,816	16,044	19,892	22,111	25,760	27,326	34,540	40,664	44,589
Type V Square Wide	4000K/5000K Lumens	4,497	7,349	9,478	11,280	7,831	10,190	16,281	20,332	25,453	31,559	35,079	40,868	42,947	54,285	63,909	70,079
	BUG Rating	B3-U0-G1	B3-U0-G2	B4-U0-G2	B4-U0-G2	B3-U0-G2	B4-U0-G3	B4-U0-G3	B5-U0-G3	B5-U0-G4	B5-U0-G5	B5-U0-G5	B5-U0-G5	B5-U0-G5	B5-U0-G5	B5-U0-G5	B5-U0-G5
	Lumens per Watt	146	139	131	121	145	138	145	135	148	135	143	135	157	143	136	129
	3000K Lumens <sup>1</sup>	4,095	6,693	8,632	10,273	7,132	9,280	14,827	18,517	23,180	28,741	31,947	37,219	39,112	49,438	58,203	63,822

NOTES:  
1. For 3000K or HSS BUG Ratings, refer to published IES files



## Energy and Performance Data

House Side Shield Reference Table

Product Family		Prevail	Prevail		Prevail XL		Prevail Maxx
Light Engine		PA1	PA1	PA2	PA3	PA4	PA6
Rotated Optics	Standard	HSS-HP (Qty 1)	HSS-VP (Qty 1)	HSS-HP (Qty 2)	HSS-HP (Qty 3)	HSS-VP (Qty 4)	HSS-HP (Qty 6)
	L90 or R90 option	HSS-VP (Qty 1)	HSS-HP (Qty 1)	HSS-VP (Qty 2)	HSS-VP (Qty 3)	HSS-HP (Qty 4)	HSS-VP (Qty 6)

Sensor Color Reference Table (SPBx)

Housing Finish	Sensor Color
AP=Grey	Grey
BZ=Bronze	Bronze
BK=Black	Black
DP=Dark Platinum	Grey
GM=Graphite Metallic	Black
WH=White	White

Lumen Multiplier

Ambient Temperature	Lumen Multiplier
0°C	1.02
10°C	1.01
25°C	1.00
40°C	0.99
50°C	0.97

FADC Settings

FADC Postion	Percent of Typical Lumen Output
1	25%
2	48%
3	55%
4	62%
5	72%
6	77%
7	82%
8	85%
9	90%
10	100%

Note: +/-5% typical value

Lumen Maintenance

Ambient Temperature	TM-21 Lumen Maintenance (78,000 Hours)	Theoretical L70 (Hours)
Up to 50°C	96.76%	> 896,000



### Control Options

**0-10V** This fixture provides 0-10V dimming wire leads for use with a lighting control panel or other control method.

**Photocontrol** (PR and PR7) Photocontrol receptacles provide a flexible solution to enable "dusk-to-dawn" lighting by sensing light levels. Advanced control systems compatible with NEMA 7-PIN standards can be utilized with the PR7 receptacle.

**Dimming Occupancy Sensor** (SPB, MS/DIM-LXX) These sensors are factory installed in the luminaire housing. When the SPB or MS/DIM sensor options are selected, the luminaire will dim down after five minutes of no activity detected. When activity is detected, the luminaire returns to full light output. These occupancy sensors include an integral photocell for "dusk-to-dawn" control or "daylight harvesting." Factory default is enabled for the MS sensors and disabled for the SPB. SPB motion sensors require the Sensor Configuration mobile application by Wattstopper to change factory default dimming level, time delay, sensitivity and other parameters. Available for iOS and Android devices. The SPB sensor is factory preset to dim down to approximately 10% power with a time delay of five minutes.

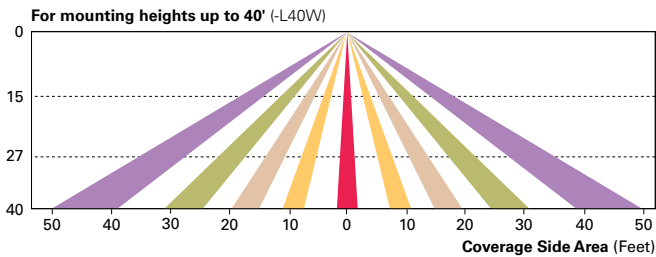
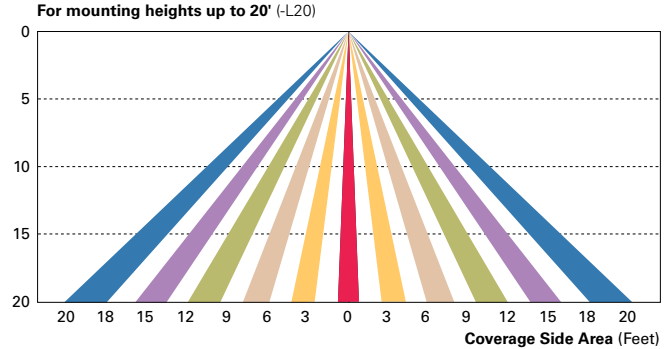
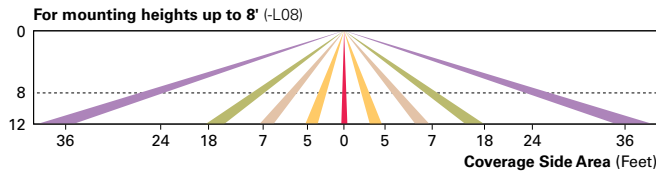

**WaveLinx Wireless Control and Monitoring System** Available in 7-PIN or 4-PIN configurations, the WaveLinx Outdoor control platform operates on a wireless mesh network based on IEEE 802.15.4 standards enabling wireless control of outdoor lighting. At least one Wireless Area Controller (WAC) is required for full functionality and remote communication (including adjustment of any factory pre-sets).

**WaveLinx Outdoor Control Module (WOLC-7P-10A)** A photocontrol that enables astronomical or time-based schedules to provide ON, OFF and dimming control of fixtures utilizing a 7-PIN receptacle. The out-of-box functionality is ON at dusk and OFF at dawn.

**WaveLinx PRO Wireless Sensor (WPS2 and WPS4)** These outdoor sensors offer passive infrared (PIR) occupancy sensing and a photocell for closed-loop daylight sensing. These sensors are factory preset to dim down to approximately 50 percent power after 15 minutes of no activity detected, and the photocell for "dusk-to-dawn" control is default enabled. A variety of sensor lenses are available to optimize the coverage pattern for mounting heights from 7'-40'.

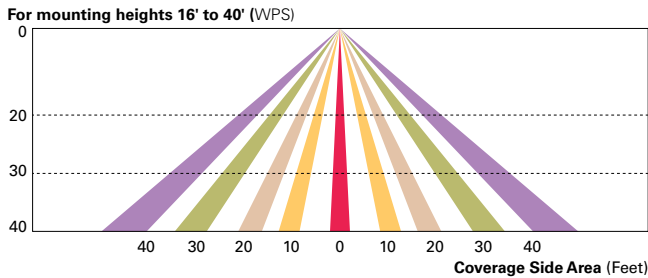

**LumenSafe (LD)** The LumenSafe integrated network camera is a streamlined, outdoor-ready camera that provides high definition video surveillance. This IP camera solution is optimally designed to integrate into virtually any video management system or security software platform of choice. No additional wiring is needed beyond providing line power to the luminaire. LumenSafe features factory-installed power and networking gear in a variety of networking options allowing security integrators to design the optimal solution for active surveillance.