



ARTICLE 7

RULES OF MEASUREMENT and DEFINITIONS

TABLE OF CONTENTS

DIVISION 7.1 MEASUREMENT

7.1.1 General.

7.1.2 Rules of measurement.

DIVISION 7.2 DEFINITION

7.2.1 General.

7.2.2 Definitions.

ARTICLE 7

RULES OF MEASUREMENT and DEFINITIONS

DIVISION 7.1 MEASUREMENT

7.1.1 GENERAL.

The rules of measurement set forth in 7.1.2 shall generally apply to this Code unless otherwise specified. For words, terms, and phrases words used in the Rules of Measurement that are not defined in Sections 7.1.2, or Division 7.2, the Director shall have the authority and power to interpret or define such words, terms and phrases. In making such interpretations or definitions, the Director may consult appropriate secondary sources.

7.1.2 RULES OF MEASUREMENT.

The following words, terms and phrases, when used in this Code, shall have the meanings ascribed to them in this section:

Block shall mean a unit of land bounded by streets or by a combination of streets and public lands, railroad rights-of-way, waterways or any barrier to the continuity of development, but shall not include in the calculation of the block size measurement the barriers creating the boundary.

Building frontage shall mean that side of a building that faces and is parallel to or most nearly parallel to a public or private street. The length of the frontage is determined by measuring along the outside walls of the building and including eaves that are at least eight (8) feet above grade and are an integral part of the roof or building wall. There can be only one (1) building frontage for each street upon which a building faces.

Build-to line shall mean the line on which the front of a building or structure must be located or built and which is measured as a distance from a public right-of-way street. To establish "build-to" lines, buildings shall be located and designed to align or approximately align with any previously established building/sidewalk relationships that are consistent with this standard. block patterns. Accordingly, at least thirty (30) percent of the total length of the building along the street shall be extended to the build-to line area. If a parcel, lot or tract has multiple streets, then the building shall be built to at least two (2) of the built to lines m according to (A) through (C) below, i.e. to a street corner. If there is a choice of two (2) or more corners, then the building shall be built to the corner that is projected to have the most pedestrian activity associated with the building.

- (A) Buildings shall be located no more than fifteen (15) feet from the right-of-way of an adjoining street if the street is smaller than a full arterial or has on-street parking.
- (B) Buildings shall be located at least ten (10) and no more than twenty-five (25) feet behind the street right-of-way of an adjoining street that is larger than a two-lane arterial that does not have on-street parking.
- (C) Exceptions to the build-to line standards shall be permitted:

- (1) in order to form an outdoor space such as a plaza, courtyard, patio or garden between a building and the sidewalk. Such a larger front yard area shall have landscaping, low walls, fencing or railings, a tree canopy and/or other similar site improvements along the sidewalk designed for pedestrian interest, comfort and visual continuity.
- (2) if the building abuts a four-lane or six-lane arterial street, and the Director has determined that an alternative to the street sidewalk better serves the purpose of connecting commercial destinations due to one or more of the following constraints:
 - (a) high volume and/or speed of traffic on the abutting street(s),
 - (b) landform,
 - (c) an established pattern of existing buildings that makes a pedestrian-oriented streetfront infeasible. Such an alternative to the street sidewalk must include a connecting walkway(s) and may include internal walkways or other directly connecting outdoor spaces such as plazas, courtyards, squares or gardens.
- (3) in the case of Large Retail Establishments, Supermarkets or other anchor-tenant buildings that face internal connecting walkways with pedestrian frontage in a development that includes additional outlying buildings abutting the street(s).
- (4) if a larger or otherwise noncompliant front yard area is required by the City to continue an established drainage channel or access drive, or other easement.
- (5) in order to conform to an established pattern of building and street relationships, a contextual build-to line may fall at any point between the required build-to line and the build-to line that exists on a lot that abuts, and is oriented to, the same street as the subject lot. If the subject lot is a corner lot, the contextual build-to line may fall at any point between the required build-to line and the build-to line that exists on the lot that is abutting and oriented to the same street as the subject lot. A contextual build-to line shall not be construed as allowing a vehicular use area between the building and the street.

Bulk plane shall mean the imaginary plane that limits the allowable space a building may occupy. Dormer, eaves, chimneys and other architectural details are exempt from the bulk plane requirements. Bulk Plane requirements vary by zone district. Specific dimensions vary for lots with north facing walls along side-interior lot lines with an adjoining property.

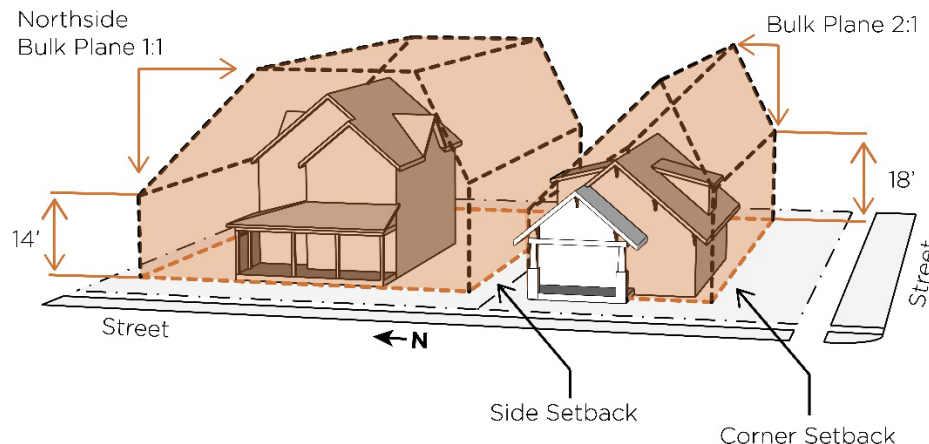

Contextual build-to line shall mean a build-to line that falls at any point between the required build-to line and the build-to line that exists on a lot that abuts, and is oriented to, the same street as the subject lot, in order to conform to an established pattern of building and street relationships. A contextual build-to line shall not be construed as allowing a vehicular use area between the building and the street.

Contextual Height Setback. Properties adjacent to lower scaled residential zone districts shall comply with the Contextual Height Setback, which requires floors above the second story to be setback an additional 25' from the property line. This does not apply to detached homes, duplexes, or accessory structures.

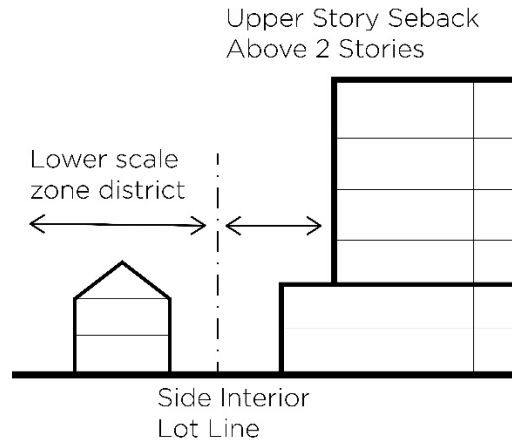

Density shall mean the overall number of dwelling units located on the gross or net residential acreage (as applicable) contained within the development and calculated on a per-acre basis.

(A) Calculation of the gross residential density shall be performed (and included on the development plan) in the following manner:

- (1) Determining the gross acreage. The gross acreage of all the land within the boundaries of the development shall be included in the density calculation except:
 - (a) any interest in land that has been deeded or dedicated to any governmental agency for public use prior to the date of approval of the development plan; provided, however, that this exception shall not apply to any such acquisition of an interest in land solely for open space, parkland or stormwater purposes; and
 - (b) land devoted to nonresidential uses such as commercial, office, industrial or civic uses.
- (2) The foregoing gross acreage calculation shall be shown in a table format on the development plan and shall form the basis for calculating the gross residential density.
- (3) The total number of dwelling units shall be divided by the gross residential acreage. The resulting gross residential density shall also be shown in a table format on the development plan.

(B) Calculation of the net residential density shall be performed (and included on the development plan) in the following manner:

- (1) Determining the net residential acreage. The net residential acreage shall be calculated by subtracting the following from the gross acreage, as determined in subsection (A) above:

- (a) land to be dedicated for arterial streets;
- (b) land containing natural areas or features that are to be protected from development and disturbance in accordance with the requirements of LUC Section 5.6.1, "Natural Habitats and Features,";
- (c) land set aside from development due to a geologic hazard in accordance with the requirements of LUC Section 5.6.5, "Hazards,";
- (d) land containing outdoor spaces that are to be dedicated to the public or deeded to the homeowner's association and preserved for a park or central green, but only if the total area of land does not exceed twenty-five (25) percent of the gross acreage of the project development plan and the outdoor space meets the following criteria:
 - (I) At least thirty-five (35) percent of the boundary of the outdoor space is formed by nonarterial, public streets, and the rear facades and rear yards of houses abut not more than two (2) sides or more than fifty (50) percent of the boundary frontage of the outdoor space.
 - (II) At a minimum, the outdoor space consists of maintained turf. In addition, such outdoor spaces may include features such as: buildings containing recreation or meeting rooms,, playgrounds,, plazas,, pavilions,, picnic tables,, benches,, orchards,, walkways or other similar features.
 - (III) The outdoor space is no less than ten thousand (10,000) square feet in area.
 - (IV) The outdoor space does not consist of a greenbelt or linear strip but has a minimum dimension of fifty (50) feet in all directions in any nonrectangular area, or seventy-five (75) feet in any rectangular area.
 - (V) The outdoor space is located and designed to allow direct, safe and convenient access to the residents of surrounding blocks.
 - (VI) Storm drainage functions that are integrated into outdoor spaces allow adequate space for active recreation purposes and do not result in slopes or gradients that conflict with active recreation. Stormwater retention areas (which have no outlet) shall not be allowed. No more than ten (10) percent of an outdoor space shall consist of gradients greater than four (4) percent.
- (e) land dedicated to public alleys.
- (f) land dedicated to pedestrian/bicycle path connections when required pursuant to subsection 5.9.1(C)(6) or subsection 5.3.2(E)(3) or when provided voluntarily by the applicant to connect cul-de-sacs to nearby streets, provided that such connections do not exceed two hundred fifty (250) feet in length.
- (g) land dedicated to landscaped traffic circles, squares, islands and boulevard strips separating the travel lanes of collector or local streets, provided that such features have the following minimum width dimensions:

- (I) boulevard strips: twenty-five (25) feet at any point; and
 - (II) traffic circles, squares, or islands: forty (40) feet at any point.
- (2) The foregoing net acreage calculation shall be shown in a table format on the development plan and shall form the basis for calculating the net residential density.
- (3) The total number of dwelling units shall be divided by the net residential acreage. The resulting density shall also be shown in a table format on the development plan.

Floor area shall mean the gross floor area of all buildings on the property, greater than 120sf or greater than 8ft in height, as measured along the outside walls of a building and shall be calculated to include each floor level.

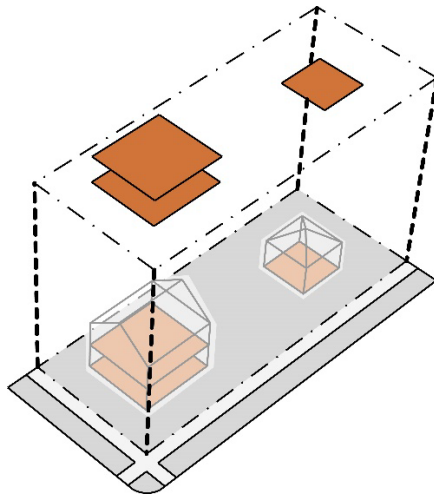

Floor area shall be calculated as follows:

- (A) In all zone districts except in the Old Town zone district Floor area calculations shall not include open balconies, the first seven hundred twenty (720) square feet of the total of all sheds, garages or other enclosed automobile parking areas, basements and one-half ($\frac{1}{2}$) of all storage and display areas for hard goods.
- (B) In the Old Town Zone district floor area shall be calculated to include the floor area of the following spaces and building elements.
 - (1) One hundred (100) percent of the floor area of the following spaces and building elements:
 - (a) The total floor area of all principal buildings as measured along the outside walls of such buildings; and
 - (b) each finished floor level at and above grade; and
 - (c) unfinished floor levels at and above grade excluding unfinished attic space; and
 - (d) basement floor areas where any exterior basement wall is exposed by more than three (3) feet above the existing grade at the interior side lot line adjacent to the wall; and
 - (e) roofed porches, balconies and breezeways that are enclosed on more than two (2) sides; and
 - (f) attached carports, garages and sheds; and
 - (g) Detached accessory buildings larger than one hundred and twenty (120) square feet, including the area of the upper story having a ceiling of height of seven and one-half ($7\frac{1}{2}$) feet. **Detached accessory building floor area shall not be calculated into the allowed floor area of the primary building.**
 - (2) Two hundred (200) percent for the floor area of the following spaces and building elements:

- (a) High volume spaces on the first or second floor where the distance between the floor and the ceiling or roof rafters directly above is greater than fourteen (14) feet.

Floor Area Ratio (FAR) shall mean the amount of gross floor area of all principal buildings on a lot or block, as the case may be, divided by the total area of such lot, or the block size, respectively, on which such buildings are located. For mixed-use blocks, the residential square footage shall be added to the commercial development for a total block FAR.

Front Facade Design. At least one (1) front façade feature from the menu below shall be included to promote pedestrian orientation and compatibility with the character of the structures on the block face:

- (A) *Limited 2-story facade.* Two-story front-facade width is no more than 40', with any remaining two-story front facade setback an additional six (6) feet.

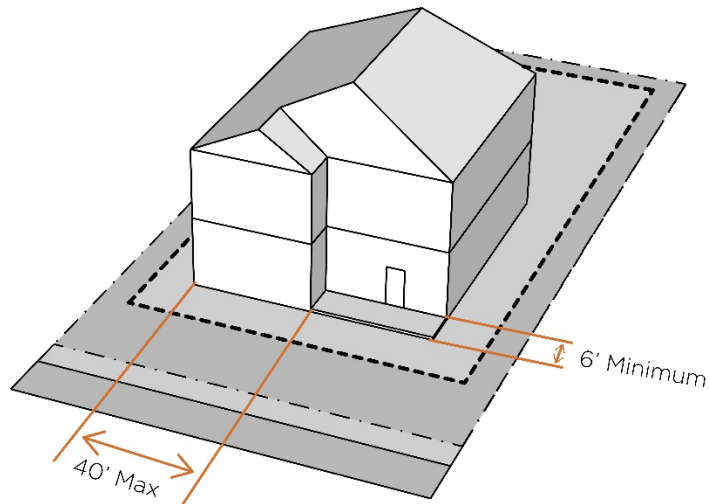

- (B) *1-story element.* The portion of the facade closest to the street is one-story, with any two-story facade setback an additional six (6) feet from the street.

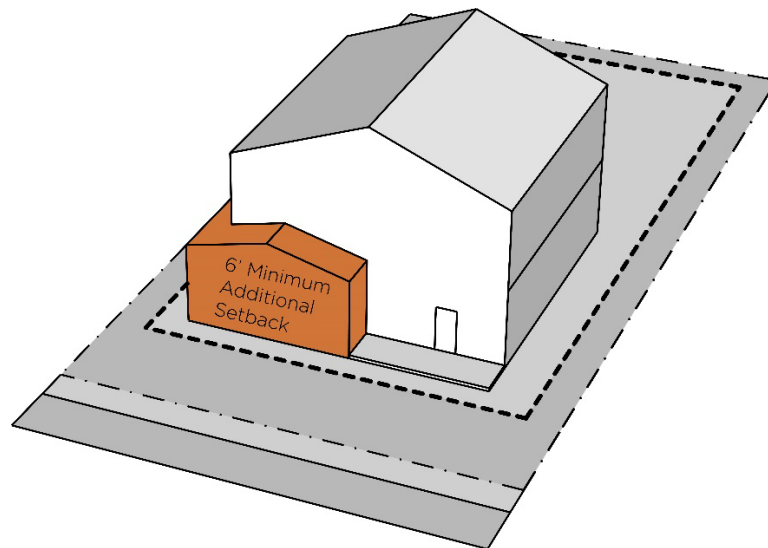

- (C) *Covered entry*. The portion of the facade closest to the street is one- story, with any two-story facade setback an additional six (6) feet from the street.

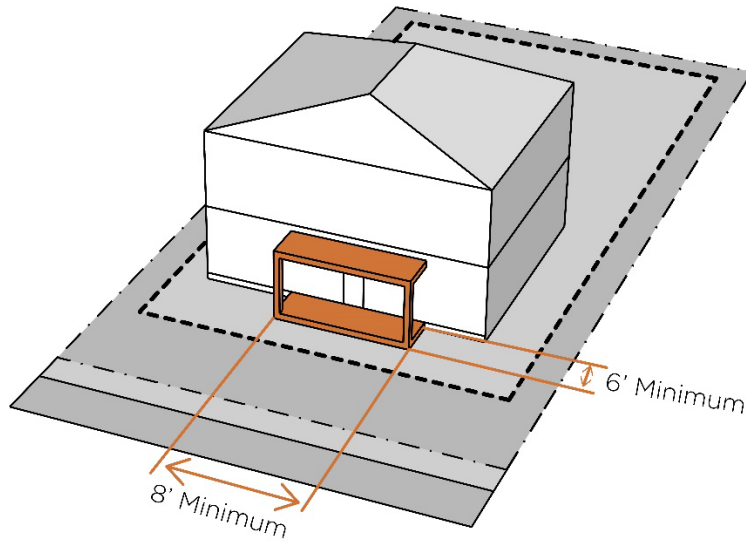

Half story. When the floor area of the top story is less than, or equal to half of the ground floor area.

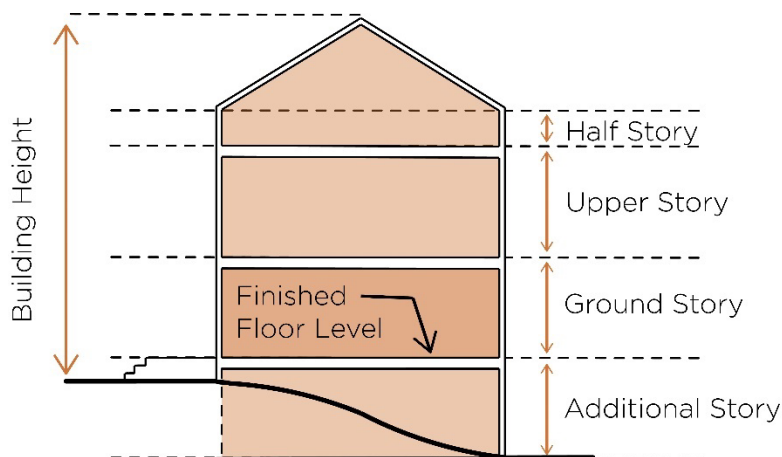

Height shall mean the distance above a given level. Depending upon the context, height may be measured according to any of several methods, as follows:

- (A) Building Height Measured in Stories. In measuring the height of a building in stories the following measurement rules shall apply:
- (1) A balcony or mezzanine shall be counted as a full story when its floor area is in excess of one-third (1 /3) of the total area of the nearest full floor directly below it.
 - (2) Half (1/2) story shall mean a space under a sloping roof that has the line of intersection of the roof and wall face not more than three (3) feet above the floor level, and in which space the possible floor area with head room of five (5) feet or less occupies at least forty (40) percent of the total floor area of the story directly beneath.

- (3) No story of a commercial or industrial building shall have more than twenty-five (25) feet from average ground level at the center of all walls to the eave/wall intersection or wall plate height if there is no eave, or from floor to floor, or from floor to eave/wall intersection or wall plate height as applicable.
- (4) A maximum vertical height of twelve (12) feet eight (8) inches shall be permitted for each residential story measured from average ground level at the center of all walls to the eave/wall intersection or wall plate height if there is no eave, or from floor to floor, or from floor to eave/wall intersection or wall plate height as applicable. This maximum vertical height shall apply only in the following zone districts: U-E; R-F; R-L; L-M-N; M-M-N; OT-A; OT-B; OT-C; R-C; C-C-N; N-C; H-C; and M-H.

(B) Building Height Measured in Feet. When measured in feet, building height shall be measured from the average of the finished ground level at the center of all walls of a building or structure to the highest point of the roof surface or structure.

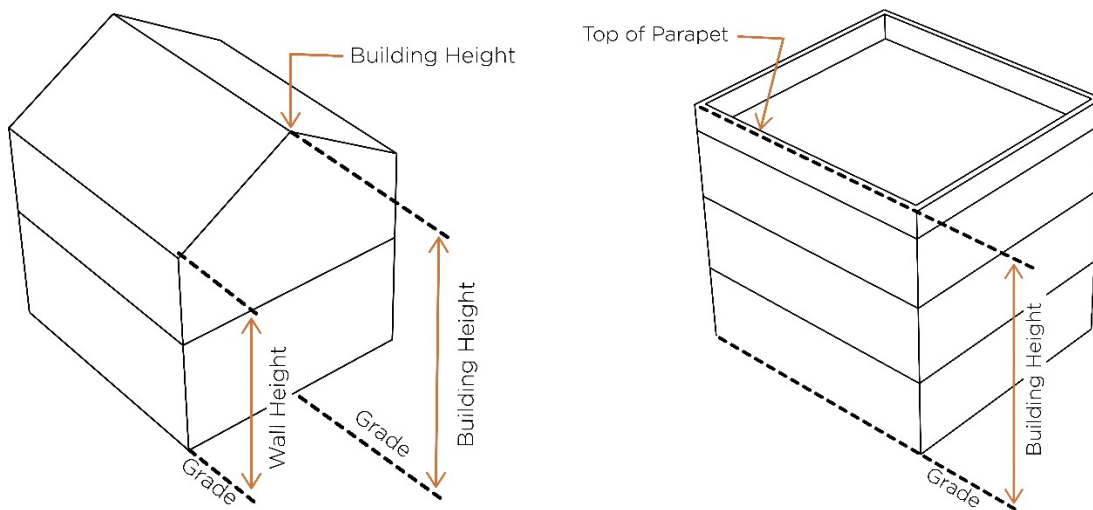

(C) Transitional Height. Regardless of the maximum building height limit imposed by the zone district standards of this Land Use Code, applicants shall be allowed to use a "transitional" height limit. The allowed "transitional" height may fall at or below the midpoint between the zone district maximum height limit and the height, in feet, of a building that exists on a lot that abuts the subject lot and faces the same street as the building on the subject lot. This provision shall not be interpreted as requiring greater minimum heights or lower maximum heights than imposed by the underlying zone district.

Integrate with existing structure shall mean using the existing structure to achieve a new use and/or using the existing structure to achieve an increase in the number of dwelling units at an existing use. In order to meet the definition of *integrate existing structure*, the following requirements must be met:

- (A) Exterior walls must remain and cannot be demolished except for the following:
 - (1) New windows, doors, or entry features may be added and only the area of the new features may be removed from the existing wall;
 - (2) 0% of front walls, 25% of side walls, and 100% of rear walls may be removed; and
 - (3) Exterior finishes may be maintained or replaced without increasing the footprint.
- (B) In conjunction with the demolition exceptions in (A), additions to existing structure may occur. Additions shall be subordinate to the existing structure by satisfying all of the following requirements:

- (1) The addition must be the same height as the existing structure or lower;
- (2) The addition must be placed to the rear of the existing structure;
- (3) The addition must be designed to be compatible with defining features including but not limited to materials, finishes, windows, doors, entries, porches, decks, and balconies of the existing structure; and
- (4) The addition may not increase the footprint of the existing structure by more than 50%.

(C) Any allowed demolition or additions shall be identified in the building permit submittal.

Lot shall mean a designated parcel, tract or area of land established by plat, subdivision or otherwise permitted by law to be used, occupied or designed to be occupied by one (1) or more buildings, structures or uses, that abuts a dedicated right-of-way, private street or private drive, any of which is at least twenty (20) feet wide at all points.

Lot area shall mean the amount of horizontal (plan view) land area within lot lines. (See also Section 5.7.4)

Lot line, front shall mean the property line dividing a lot from a street. On a corner lot only one (1) street line shall be considered as a front line, and the street to which the primary entrance of the principal building faces or to which the building is addressed, shall be considered the front line.

Lot line, rear shall mean the line opposite the front lot line.

Lot line, side shall mean any lot lines other than front lot line or rear lot line.

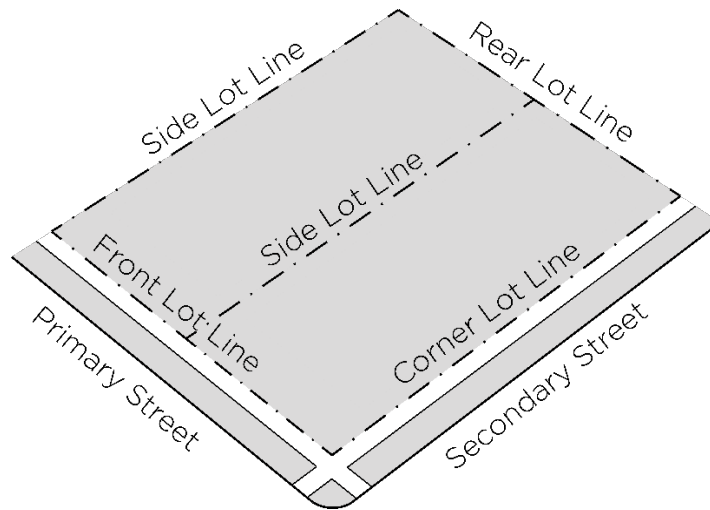

Lot width shall mean the horizontal (plan view) distance between the side lot lines as measured along a straight line parallel to the front lot line or the chord thereof. The minimum lot width shall be measured between the side lot lines along a line that is parallel to the front lot line and located at the minimum front setback distance from the front lot line. In the case of cul-de-sac lots, the minimum lot width may be measured between the side lot lines along a line that is parallel to the front lot line and located at the actual front building line.

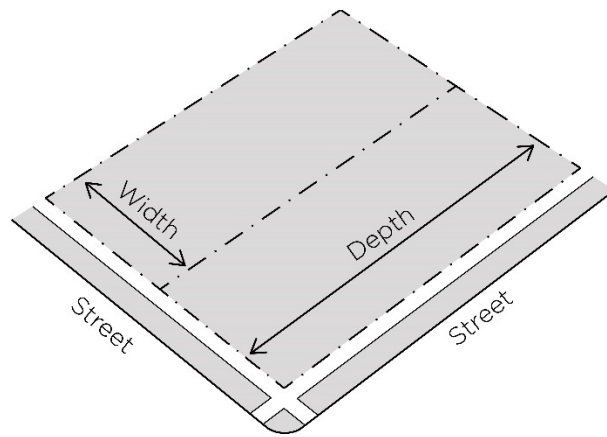

Measuring distances between uses. When a distance is required between uses, the distance shall be measured in a straight line from the closest point on the boundary line of one (1) property to the closest point on the boundary line of the other property.

Minimum frontage or minimum building frontage shall mean a measurement equal to a fraction, the denominator of which is the sum of the length of all perimeter streets bounding the block, and the numerator of which is the sum of the length (as measured within twenty [20] feet of the perimeter street right-of-way) of all buildings that have windows and entries oriented to the street, plus twenty (20) percent of the length (as measured within thirty [30] feet of the perimeter street right-of-way) of any plazas or pedestrian accessible landscaped areas within the block. In no case shall parking lots or blank rear or side walls be included in the minimum frontage calculation.

Mounting height (MH) shall mean the vertical distance between the finish grade and the center of the apparent light source of the luminaire.

Secondary roof shall mean a flat roof structure that is at least 10 feet lower than another roof structure on the same building.

Setback shall mean the required unoccupied open space between the nearest projection of a structure and the property line of the lot on which the structure is located, except as modified by the standards of this Code. Required setbacks shall be unobstructed from the ground to the sky except as specified in Section 5.13.2.

Side Facade Design. Side facade design can be accomplished by offsetting the floor plan, recessing or projection of design elements, change in materials and/or change in contrasting colors. Projections shall fall within setback requirements.

- (A) *Wall Offset.* Two-story facade width at minimum is no more than forty (40) feet, with any remaining two-story facade setback an additional six (6) feet beyond the minimum required side yard.

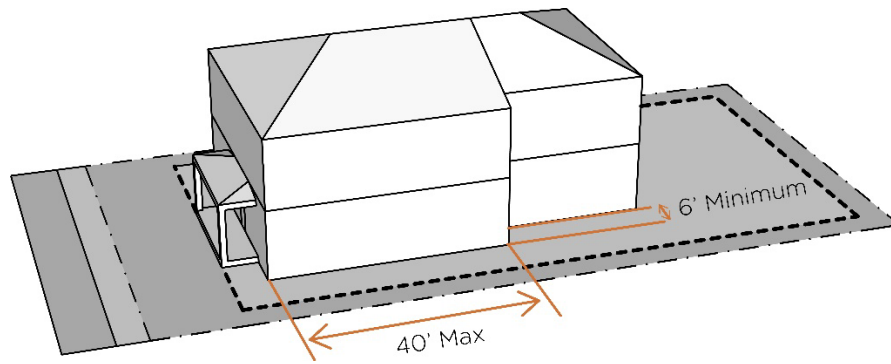

(B) *Step Down in Height.* Two story facade width at minimum is no more than forty (40) feet, with any remaining facade width at the side yard reduced to one-story.

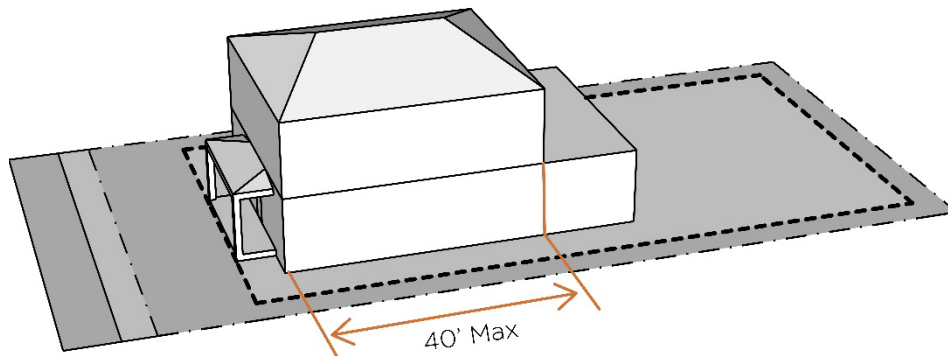

(C) *One-Story Element.* One-story building element with a minimum depth of six (6) feet is located at the minimum side yard.

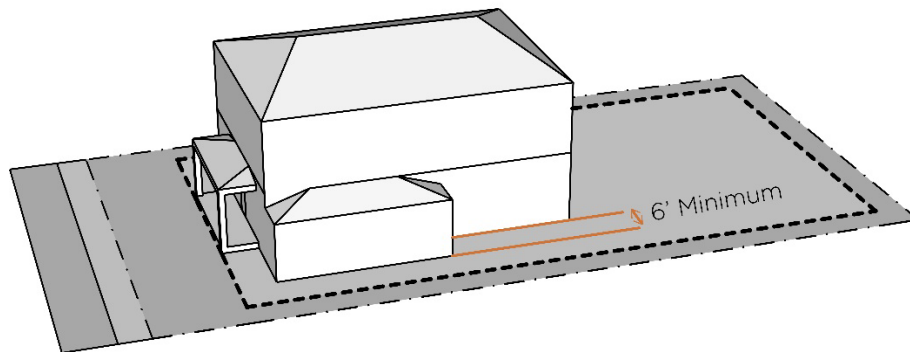

(D) *Additional Setback.* Any two-story facade is set back an additional six (6) feet beyond the minimum required side yard.

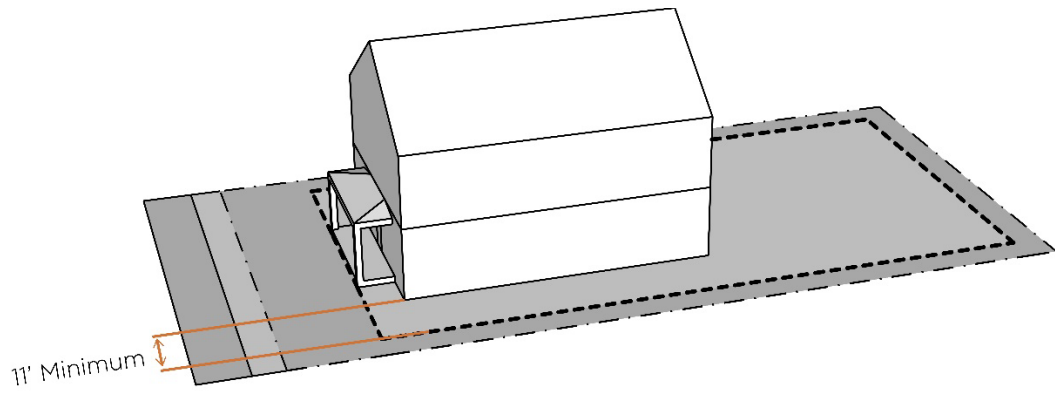

DIVISION 7.2 DEFINITION

7.2.1 GENERAL.

For words, terms and phrases used in this Land Use Code that are not defined in Section 7.2.2 or elsewhere in this Land Use Code, the Director shall have the authority and power to interpret or define such words, terms and phrases. In making such interpretations or definitions, the Director may consult appropriate secondary sources.

7.2.2 DEFINITIONS.

The following words, terms and phrases, when used in this Code, shall have the meanings ascribed to them in this section:

Abut or abutting shall mean touching. An abutting condition shall not be affected by the parcelization or division of land that results in an incidental, nonbuildable, remnant lot, tract or parcel.

Accessory building (or structure) shall mean a building (or structure) detached from a principal building and customarily used with, and clearly incidental and subordinate to, the principal building, and ordinarily located on the same lot with such principal building.

Accessory dwelling unit (ADU), detached shall mean an additional, subordinate dwelling unit created on a lot with a primary dwelling unit. The additional unit is smaller than the primary dwelling unit (except when the accessory dwelling unit is in an existing basement). The accessory dwelling unit includes its own independent living facilities including habitable space. It is designed for residential occupancy by one or more people, independent of the primary dwelling unit.

Accessory dwelling unit (ADU), attached shall be defined as an additional, subordinate dwelling unit created on a lot with a primary dwelling unit. The additional unit is smaller than the primary dwelling unit (except when the accessory dwelling unit is in an existing basement). The accessory dwelling unit includes its own independent living facilities which constitute habitable space. It is designed for residential occupancy by one or more people, independent of the primary dwelling unit. The unit may have a separate exterior entrance or an entrance to an internal common area accessible to the outside.

Accessory use shall mean a use of land or of a building or portion thereof customarily used with, and clearly incidental and subordinate to, the principal use of the land or building and ordinarily located on the same lot with such principal use.

Adequate public facilities ("APF") shall mean the public facilities and services necessary to maintain the adopted level of service standards.

Adequate public facilities management system ("APF management system") shall mean the procedures and/or process that the city utilizes to assure that development approvals and permits, including but not limited to building permits and site-specific development plans, are not issued unless the necessary facilities and services are available concurrently with the impacts of development.

Adjacent shall mean nearby, but not necessarily touching. The determination of "nearby" shall be made by the City on a case-by-case basis, taking into consideration the context in which the term is used and the variables (such as but not limited to size, mass, scale, bulk, visibility, nature of use, intensity of use) that may be relevant to deciding what is "nearby" in that particular context. Adjacency shall not be affected by the existence of a platted street or alley, a public or private right-of-way, or a public or private transportation right-of-way or area.

Administrative review shall mean review by the Director in accordance with the provisions of Article 6. Also known as Type 1 review.

Adult day/respice care center shall mean a nonresidential facility providing for the care, supervision, protection and social activities of adults and persons over sixteen (16) years of age during normal daytime working hours and allowing overnight stay on a short-term basis as a subordinate function.

Adult material shall mean any material including, but not limited to, books, magazines, newspapers, movie films, slides or other photographic or written materials, video tapes, video disks, computer software and/or other items or devices that are distinguished or characterized by their emphasis on depicting, describing or relating to "specified anatomical areas" or "specified sexual activities."

Adult-oriented use shall mean a use of property where the principal use, or a significant or substantial adjunct to another use of the property, is the sale, rental or display of adult material, or is an offering of live entertainment, dancing or material that is distinguished or characterized by its emphasis on depicting, exhibiting, describing or relating to "specified sexual activities" or "specified anatomical areas" as the primary attraction to the premises, including, but not limited to:

- (A) *Adult bookstore, adult novelty store or adult retail store*: any establishment that has adult material as a significant or substantial portion of its stock-in-trade, or derives a significant or substantial portion of its revenues from such material, or devotes a significant or substantial portion of its interior business or interior advertising to such material, or maintains a substantial or significant portion of its gross floor area or display space for the sale or rental, for any form of consideration, of such material, including, but not limited to, books, magazines, newspapers, movie films, slides or other photographic or written material, video tapes, video disks, computer software and/or other items or devices. For the purpose of this subparagraph (1), "significant or substantial" shall mean more than twenty (20) percent.
- (B) *Adult cabaret, restaurant or place of business*: a cabaret, restaurant or place of business that features waitresses, waiters, dancers, go-go dancers, exotic dancers, strippers, gender impersonators or similar entertainers attired in such manner as to display "specified anatomical areas."
- (C) *Adult hotel or motel*: any hotel or motel in which the presentation of adult material is the primary or principal attraction.
- (D) *Adult mini-motion picture theater*: any theater or establishment with a capacity of less than fifty (50) persons in which the presentation of adult material is the primary or principal attraction.
- (E) *Adult motion picture theater*: any theater or establishment with a capacity of fifty (50) or more persons in which the presentation of adult material is the primary or principal attraction.
- (F) *Adult photo studio*: any establishment that, upon payment of a fee, provides photographic equipment and/or models for the purpose of photographing, sketching, drawing, painting or sculpturing "specified anatomical areas," but shall not include a private school licensed by the State of Colorado or a college, junior college or university supported entirely or in part by public funds or a private college or university that maintains and operates educational programs in which credits are transferable to a college, junior college or university supported entirely or in part by public funds.
- (G) *Other adult amusement or entertainment*: any other amusement, entertainment or business which is distinguished or characterized by an emphasis on acts or adult material depicting, describing or relating to "specified sexual activities" or "specified anatomical areas."

Adverse effect, for purposes of Section 5.8.1 only, shall mean that a project or undertaking may alter, directly or indirectly, any of the characteristics that qualify a property for designation in a manner that would diminish

the property's integrity. Adverse effects may include reasonably foreseeable effects caused by the undertaking that may occur later in time, be removed in distance, or be cumulative.

Affordable housing development shall mean a development project in which at least ten (10) percent of said dwelling units (the "affordable housing units") are to be available for rent or purchase on the terms described in the definitions of affordable housing unit for rent or affordable housing unit for sale (as applicable).

Affordable housing unit for rent shall mean a dwelling unit that is available for rent on terms that would be affordable to households earning eighty (80) percent or less of the Area Median Income (AMI) as calculated for Fort Collins by the Department of Housing and Urban Development (HUD) and adjusted for household size, and at a cost that results in a household paying thirty (30) percent or less of their gross income for housing, including rent and utilities.

Affordable housing unit for sale shall mean a dwelling unit that is available for purchase on terms that would be affordable to households earning one hundred (100) percent or less of the Area Median Income (AMI) as calculated for Fort Collins by the Department of Housing and Urban Development (HUD) and adjusted for household size, and at a cost that results in a household paying less than thirty-eight (38) percent of their gross income for housing, including principal, interest, taxes, insurance, utilities and homeowners' association fees.

Air contaminant shall mean any fume, smoke, particulate matter, vapor, gas or any combination but not including water vapor or steam condensation.

Air contamination source shall mean any source whatsoever at, from or by reason of which there is emitted or discharged into the atmosphere any air contaminant.

Alley shall mean a minor way used primarily for vehicular service access to the back of properties abutting on a street.

Animal boarding shall mean the operation of an establishment in which domesticated animals other than household pets are housed, groomed, bred, boarded, trained or sold. This term shall not include the operation of a kennel.

Antenna(s) shall have the meaning set forth in § 29-27-402, Colorado Revised Statutes.

Architectural Features shall mean the architectural elements embodying style, design, general arrangement, and components of the exterior of any building or structure, include, but not limited to, the kind, color, and texture of the building materials, and the style and type of such items as a porch, covered stoop, portico or other similar feature.

Arterial street shall mean a street that is anticipated to carry in excess of three thousand five hundred (3,500) vehicles per day in traffic volume, at desirable speeds ranging from thirty (30) to forty-five (45) miles per hour, and that is defined specifically as such on the Master Street Plan of the City and is used for travel between areas within and outside the City.

Artisan and photography studio and gallery shall mean the workshop or studio of an artist, craftsperson, sculptor or photographer, which workshop is primarily used for on-site production of unique custom goods through the use of hand tools or small-scale equipment, and only incidentally used, on an infrequent basis if at all, as an accessory gallery or for incidental sales.

Auto-oriented development shall mean development that is designed primarily to attract or accommodate customers, workers or residents who travel to the site by automobile, rather than pedestrians.

Auto-related and roadside commercial shall mean those retail and wholesale commercial activities that are typically found along highways and arterial streets. Uses include freestanding department stores; auction rooms; automobile service stations; repair facilities, car washes; boat, car, trailer, motorcycle showrooms, sales

and repair; fuel and ice sales; greenhouses and nurseries; warehouses and storage; repair or rental of any article; exterminating shops; drive-in restaurants; adult-oriented uses; and other uses that are of the same general character. *This definition applies only for the purpose of clarifying the classification and measurement system as found in the Sign Regulations of this Code, and shall not be deemed to permit such uses under this Code.*

Auto-related uses shall mean establishments primarily engaged in the sale, rental, service, repair, storage or salvage of automobiles and trucks.

Banner shall mean a type of temporary sign that is painted or printed on cloth, vinyl, or other flexible material, which is designed to be stretched between poles, fence posts or wire, mounted in a freestanding frame, or hung on walls with ties, clips, rails, brackets, hooks, or frames.

Banner frame shall mean a type of wall sign composed of a frame that is secured to a building wall and used to stretch banners such that they are tightly stretched and their mounting hardware is hidden from view.

Bar shall mean an establishment providing or dispensing fermented malt beverages, and/or malt, special malt, vinous or spirituous liquors and in which the sale of food products such as sandwiches or light snacks is secondary (also known as a tavern).

Base station shall mean a structure or equipment at a fixed location that enables FCC-licensed or authorized wireless communications between user equipment and a communications network, except that a base station does not include or encompass a tower or any equipment associated with a tower, as defined herein. *Base station* does include:

(1) Equipment associated with wireless communications services such as private broadcast, and public safety services, as well as unlicensed wireless services and fixed wireless services such as microwave backhaul that, at the time the relevant application is filed with the City under this Article, has been reviewed and approved under the applicable zoning or siting process, or under another State or local regulatory review process, even if the structure was not built for the sole or primary purpose of providing such support.

(2) Radio transceivers, antennas, coaxial or fiber-optic cable, regular and backup power supplied, and comparable equipment, regardless of technological configuration that, at the time the relevant application is filed with the City under this Article, has been reviewed and approved under the applicable state or local regulatory review process, even if the structure was not built for the sole or primary purpose of providing such support.

Base station does not include any structure that, at the time the relevant application is filed with the City under this Article, does not support or house equipment described in sub-paragraphs (1) and (2) above.

Basic development review shall mean a review without a public hearing by the Director for the purpose of determining compliance with the applicable standards of this Code for any use that is not subject to a Type 1 or Type 2 review.

Bay (building bay) shall mean a wall plane projection or recess that forms an articulated wall surface on a building elevation, and that can be formed by pilasters, columns or other vertical elements such as a group of windows. Building bay does not mean a service bay for autos or trucks and does not mean a bay window.

Bed and breakfast shall mean an establishment operated in a private residence or portion thereof, that provides temporary accommodations for a fee to overnight guests, a morning meal limited to guests only, and that is occupied by the operator of such establishment. A bed and breakfast may provide accommodations to individuals or multiple separate parties concurrently on both a reservation and walk-in basis. The term party as used in this definition shall mean one (1) or more persons who stay at a bed and breakfast as a single group pursuant to a single reservation and payment.

Bicycle parking, enclosed shall mean bicycle storage in lockers, a garage, a room or other space within a parking structure or other building, including a shed or carport. All types of enclosed bicycle storage must be easily accessible to entrances and walkways, secure, lighted and protected from the weather. Each storage space shall provide a minimum of six (6) square feet in area. The storage space shall not impede fire exits or be located so that parked bicycles interfere with public access.

Bicycle parking, fixed shall mean bicycle parking that allows the bicycle frame and both wheels to be securely locked to the parking structure. The structure shall be of permanent construction such as heavy gauge tubular steel with angle bars permanently attached to the pavement foundation. Fixed bicycle parking facilities shall be at least two (2) feet in width and five and one-half (5½) feet in length, with additional back-out or maneuvering space of at least five (5) feet.

Billboard shall mean a type of freestanding sign that incorporates a sign face that is larger than seventy (70) square feet, mounted on one or more pole structures, such that the lowest part of the sign face is ten (10) feet or more above adjacent grade.

Illustrative Billboard

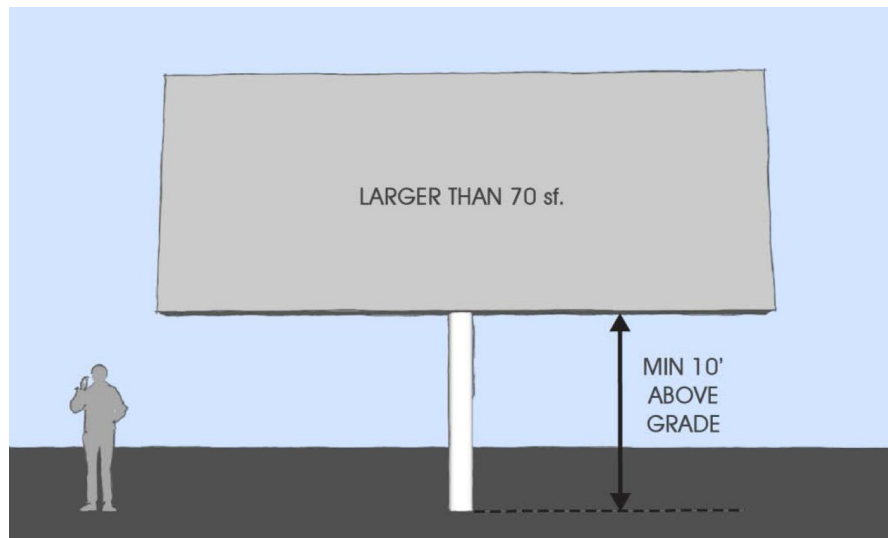

Blank wall shall mean an exterior building wall with no openings and a single material and uniform texture on a single plane.

Block (See Section 7.1.2)

Block face shall mean the portion of a block that abuts a street.

BUG (Backlight, Uplight, Glare) Rating shall mean the quantity of light within various beam angles, consisting of:

- (A) Backlight - the percent lamp lumens (non-LED luminaires) or the luminaire initial lumens (LED luminaires) distributed behind a luminaire between zero (0) degrees vertical (nadir) and ninety (90) degrees vertical.
- (B) Uplight - the percent lamp lumens (non-LED luminaires) or the luminaire initial lumens (LED luminaires) distributed above a luminaire between ninety (90) and one hundred eighty (180) degrees vertical.
- (C) Glare - the percent lamp lumens (non-LED luminaires) or the luminaire initial lumens distributed sixty (60) and ninety (90) degrees vertical.

Buffer yards shall mean land area devoted to providing separation between two (2) land uses of different intensity for the purpose of providing a transition. Such area may consist of passive open space, landscaping, fences, walls, earthen berms, topographic elevation changes or any combination thereof used to physically separate one (1) use or property from another so as to visually shield or block or mitigate noise, lights or other aspects of the urban environment.

Building shall mean any permanent structure built for the shelter or enclosure of persons, animals, chattels or property of any kind, that is governed by the following characteristics:

- (A) Is permanently affixed to the land;
- (B) Has one (1) or more floors and a roof; and
- (C) Is bounded by either open space or the lot lines of a lot.

Building elevation, for the purposes of Division 5.16 only, shall mean the external face of a building, projected onto a two-dimensional plane. For purposes of calculating allowed sign area, the building elevation is the two-dimensional representation of the side of the building upon which the sign is proposed.

Building mass shall mean the three-dimensional bulk of a building: height, width and depth.

Building permit valuation shall mean the dollar amount used for the valuation of Building Permit fees as calculated by the city's Building and Zoning Director for the issuance of a Building Permit.

Building-mounted solar energy system shall mean a solar energy system mounted on a building.

Bulletin board shall mean a type of wall sign composed of a cork, letter board, white board, or comparable surface that is within a secured, weather-resistant enclosure and used for the display of temporary messages. Bulletin board does not include manual changeable copy center.

Caliper shall mean the American Association of Nurserymen standard for trunk measurement of nursery stock, as measured at six (6) inches above the ground for trees up to and including four-inch caliper size, and as measured at twelve (12) inches above the ground for larger sizes.

Camouflage design techniques shall mean measures used in the design and siting of wireless communications facilities with the intent to minimize or eliminate the visual impact of such facilities to surrounding uses. A WCF site utilizes camouflage design techniques when it (i) is integrated as an architectural feature of an existing structure such as a cupola, or (ii) is integrated in an outdoor fixture such as a flagpole, while still appearing to some extent as a WCF. This definition does not include the use of concealment design elements.

Candela (see luminous intensity), (cd) shall mean the unit of luminous intensity.

Carport shall mean an accessory building attached or detached from a principal building and customarily used with, and clearly incidental and subordinate to the principal building or use, consisting of a roof but no more than one (1) wall and typically intended to provide weather protection for vehicles, boats, trailers, and the like.

Certified xeriscape landscaping shall mean a plant (or grouping of plants) that does not require any supplemental irrigation for survival, as determined by the City Forester, and that is used to meet the standards of Section 5.10.1, Landscaping and Tree Protection.

Change of use shall mean the act of changing the occupancy of a building or land to a different use that is specifically listed as a "Permitted Use" in Article 4. A change of use occurs whenever:

- (A) The occupancy of a single-tenant building or of a parcel of land changes from the most recent previously existing use to a different use;

- (B) The occupancy of a tenant space in a multi-tenant building changes to a use that is not currently existing in another tenant space of the building or that did not previously exist in any tenant space of the building within the last twenty-four (24) months; or
- (C) The most recent previously existing use of a building or land has been abandoned, by cessation of active and continuous operations during a period of twenty-four (24) consecutive months, and either the same type of use is proposed to be reestablished or a different use that did not exist on the property is proposed to be established.

Character shall mean those attributes, qualities and features that make up and distinguish a development project and give such project a sense of purpose, function, definition and uniqueness.

Child care center shall mean a facility, by whatever name known, that is maintained for the whole or part of a day for the care of seven (7) or more children under the age of sixteen (16) years who are not related to the owner, operator or manager, whether such facility is operated with or without compensation for such care and with or without stated educational purposes, except that a child care center shall not include any of the following five (5) types of family child care homes as defined by the State of Colorado: regular family child care home, three under two family child care home, infant/toddler home, experienced family child care provider home or large family child care home. The term includes, but is not limited to, facilities commonly known as day care centers, day nurseries, nursery schools, preschools, play groups, day camps, summer camps, centers for developmentally disabled children and those facilities that give twenty-four-hour-per-day care for dependent and neglected children. Child care centers are also those facilities for children under the age of six (6) years with stated educational purposes that are operated in conjunction with a public, private or parochial college or a private or parochial school, except that the term shall not apply to a kindergarten maintained in connection with a public, private or parochial elementary school system of at least six (6) grades.

Clubs and lodges shall mean organizations of persons for special purposes or for the promulgation of sports, arts, literature, politics or other common goals, interests or activities, characterized by membership qualifications, dues or regular meetings, excluding clubs operated for profit and/or places of worship or assembly.

Cohesive shall mean having a natural or logical agreement of parts; connected; as in a cohesive neighborhood. If used in this Land Use Code, coherent shall mean cohesive.

Collector street shall mean a street that is anticipated to carry from two thousand five hundred (2,500) to five thousand (5,000) vehicles per day in traffic volume at desirable speeds ranging from twenty-five (25) to thirty-five (35) miles per hour and that serves a collecting function by distributing traffic between local streets and arterial streets, thereby providing access to adjacent properties and linking neighborhoods with arterial streets.

Collector street system shall mean a system of one (1) or more collector street(s) that allows traffic to be distributed to at least two (2) arterial streets.

Collocation shall mean:

- (A) For the purposes of eligible facilities requests, the mounting or installation of transmission equipment on an eligible support structure for the purpose of transmitting and/or receiving radio frequency signals for communications purposes.
- (B) For the purposes of other WCFs subject to presumptively reasonable time frames set by the FCC, accounting for any tolling or extension, within which the City generally must act pursuant to 47 U.S.C.

Section 332, i.e. “shot clocks”, attachment of facilities to existing structures, regardless of whether the structure or location has previously been zoned or otherwise approved for wireless facilities.

Color shade shall mean the degree of lightness or brightness, as opposed to darkness or neutrality, of a color as determined by the proportion of black, white or gray.

Commercial development shall mean any land development activity except development activity intended solely for residential, industrial and/or light industrial use.

Commercial speech shall mean expression by a speaker for the purposes of commerce, where the intended audience is actual or potential consumers, and where the content of the message is commercial in character. Commercial speech typically advertises a business or business activity or proposes a commercial transaction.

Community based shelter services shall mean an accessory use to a facility owned and operated by a place of worship, public benefit corporation as defined by the Colorado Revised Statutes, or a tax exempt corporation as defined by Section 503 of the U.S. Internal Revenue Code, that provides overnight accommodations on a temporary basis for a maximum of fifteen (15) persons.

Community facility shall mean a publicly owned or publicly leased facility or office building that is primarily intended to serve the recreational, educational, cultural, administrative or entertainment needs of the community as a whole.

Community park shall mean a city-owned park of not less than thirty (30) acres that serves the recreational and open space needs of the community as a whole.

Community shopping center shall mean a shopping and service center located in a complex that is planned and developed as a unit, and that is intended to serve consumer demands from residents and employees who live and work in surrounding neighborhoods as well as the community as a whole. A community shopping center provides, in addition to the convenience goods of a neighborhood service center, a wider range of facilities for the sale of goods, such as, but not limited to, food, books, apparel and furniture. A community shopping center may include multi-unit residential, as well as nonretail employment generating uses (such as professional offices) within the retail component of the center.

Compatibility shall mean the characteristics of different uses or activities or design that allow them to be located near or adjacent to each other in harmony. Some elements affecting compatibility include height, scale, mass and bulk of structures. Other characteristics include pedestrian or vehicular circulation, access and parking design. Other important characteristics that affect compatibility are landscaping, lighting, noise, odor and architecture. Compatibility does not mean “the same as.” Rather, compatibility refers to the sensitivity of development proposals in respecting the character of existing development.

Composting facility shall mean any site where decomposition processes are used on solid waste (including leaves, grass, manures and nonmeat food production wastes received from residential, commercial, industrial nonhazardous and community sources, but not including bio-solids) to produce compost; provided, however, that the term composting facility shall not include composting as an accessory use.

Concealment shall mean utilization of elements of stealth design in a facility so that the facility looks like something other than a wireless tower or base station. Language such as “stealth,” “camouflage,” or similar in any existing permit or other document required by the City Code is included in this definition to the extent such permit or other document reflects an intent at the time of approval to condition the site’s approval on a design that looks like something else. *Concealment* can further include a design which mimics and is consistent with the nearby natural, or architectural features (such as an artificial tree), or is incorporated into (including without limitation, being attached to the exterior of such facility and painted to match it) or replaces existing permitted facilities (including without limitation, stop signs or other traffic signs or freestanding light standards) so that the presence of the WCF is not apparent. This definition does not include conditions that merely minimize visual

impact but do not incorporate *concealment* design elements so that the facility looks like something other than a wireless tower or base station.

Connecting walkway shall mean (1) any street sidewalk, or (2) any walkway that directly connects a main entrance of a building to the street sidewalk without requiring pedestrians to walk across parking lots or driveways, around buildings or around parking lot outlines that are not aligned to a logical route.

Connector street shall mean a local street for residential areas that is anticipated to carry from one thousand (1,000) to two thousand five hundred (2,500) vehicles per day in traffic volume at desirable speeds of up to twenty-five (25) miles per hour and that connects with collector and arterial streets and adjoining neighborhoods.

Convenience retail store (also known as convenience store) shall mean a retail store containing less than five thousand (5,000) square feet of gross floor area that sells everyday goods and services which may include, without limitation, ready-to-eat food products, groceries, over-the-counter drugs and sundries.

Convenience shopping center shall mean a shopping and service center situated on seven (7) or fewer acres with four (4) or more business establishments with separate exterior entrances, located in a complex that is planned, developed and managed as a single unit, and located within and intended to primarily serve the consumer demands of adjacent employment areas. The principal uses permitted include retail stores; business services; convenience retail stores with fuel sales (possibly including an accessory one-bay automatic carwash); personal business and service shops; standard or fast food restaurants (without drive-up windows); vehicle minor repair, servicing and maintenance uses; liquor sales (for on- or off-premise consumption); beauty or barber shops; dry-cleaning outlets; equipment rental (not including outdoor storage); limited indoor recreational uses; pet shops; and uses of similar character. Secondary uses may include professional offices; limited banking services such as branch banks (with limited drive-up facilities) and automated teller machines; multi-unit dwellings; medical offices and clinics; small animal veterinary clinics; child care centers; and elderly day care facilities.

Convenience stores with fuel sales shall mean a convenience retail store that also sells gasoline or other fuel products.

Convention and conference center shall mean a facility used for business or professional conferences and seminars, often with accommodations for sleeping, eating and recreation.

Correlated color temperature (CCT) shall mean the absolute temperature of a blackbody whose chromaticity most nearly resembles that of the light source.

Day shelter shall mean a facility that provides temporary daytime shelter and/or food and that may also provide personal care, social or counseling services to those experiencing homelessness or indigency, provided that such a facility contains a private, outdoor space.

Department shall mean the Community Development and Neighborhood Services Department, or the successor department existing from time-to-time in the City's organizational structure.

Development shall mean the carrying out of any building activity or mining operation, the making of any material change in the use or appearance of any structure or land, or, except as is authorized in LUC Section 6.24.7, the dividing of land into two (2) or more parcels.

(A) Development shall also include:

- (1) Any construction, placement, reconstruction, alteration of the size, or material change in the external appearance of a structure on land;

- (2) Any change in the intensity of use of land, such as an increase in the number of dwelling units in a structure or on a tract of land or a material increase in the intensity and impacts of the development;
 - (3) Any change in use of land or a structure;
 - (4) Any alteration of a shore or bank of a river, stream, lake, pond, reservoir or wetland;
 - (5) The commencement of drilling (except to obtain soil samples), mining, stockpiling of fill materials, filling or excavation on a parcel of land;
 - (6) The demolition of a structure;
 - (7) The clearing of land as an adjunct of construction;
 - (8) The deposit of refuse, solid or liquid waste, or fill on a parcel of land;
 - (9) The installation of landscaping within the public right-of-way, when installed in connection with the development of adjacent property;
 - (10) The construction of a roadway through or adjoining an area that qualifies for protection by the establishment of limits of development.
- (B) Development shall not include:
- (1) Work by the City, or by the Downtown Development Authority (if within the jurisdictional boundary of the Downtown Development Authority and if such work has been agreed upon in writing by the City and the Authority), or work by a highway or road agency or railroad company for the maintenance or improvement of a road or railroad track, if the work is carried out on land within the boundaries of the right-of-way, or on land adjacent to the right-of-way if such work is incidental to a project within the right-of-way. Notwithstanding, such work shall be considered development if it is determined to require a permit pursuant to Land Use Code Division 6.27, *Guidelines and Regulations for Areas and Activities of State Interest*;
 - (2) Work by the City or any public utility for the purpose of restoring or stabilizing the ecology of a site, or for the purpose of inspecting, repairing, renewing or constructing, on public easements or rights-of-way, any mains, pipes, cables, utility tunnels, power lines, towers, poles, tracks or the like; provided, however, that this exemption shall not include work by the City or a public utility in constructing or enlarging mass transit or railroad depots or terminals or any similar traffic-generating activity. Notwithstanding, such work shall be considered development if it is determined to require a permit pursuant to Land Use Code Division 6.27, *Guidelines and Regulations for Areas and Activities of State Interest*;
 - (3) Work by any person to restore or enhance the ecological function of natural habitats and features, provided that such work does not result in adverse impacts to rivers, streams, lakes, ponds, wetlands other natural habitats or features, or adjacent properties as determined by the Director; and provided that all applicable State, Federal, and local permits or approvals have been obtained;
 - (4) The maintenance, renewal, improvement, or alteration of any structure, if the work affects only the interior or the color of the structure or the decoration of the exterior of the structure (however, Chapter 14 of the Code of the City of Fort Collins is still applicable);

- (5) The use of any land for the purpose of growing plants, crops, trees and other agricultural or forestry products; for raising or feeding livestock (other than in feedlots); for other agricultural uses or purposes; or for the delivery of water by ditch or canal to agricultural uses or purposes, provided none of the above creates a nuisance, and except that an urban agriculture license is required in accordance with LUC Section 4.3.5(l) of this Code;
 - (6) A change in the ownership or form of ownership of any parcel or structure;
 - (7) The creation or termination of rights of access, easements, covenants concerning development of land, or other rights in land;
 - (8) The installation, operation, maintenance, or upgrade of a small cell or broadband facility by a telecommunications provider principally located within a public highway as the terms small cell facility, telecommunications provider, and public highway are defined in Section 38-5.5-102, C.R.S. The regulation of such activities is addressed in Chapter 23 of the Code of the City of Fort Collins.
- (C) When appropriate in context, development shall also mean the act of developing or the result of development.

Development application shall mean any application or request submitted in the form required by the Land Use Code and shall include only applications for an overall development plan, a PUD Overlay, a project development plan, a final plan, a basic development review, a Building Permit, a modification of standards, amendments to the text of this Code or the Zoning Map, a variance or an appeal from administrative decisions prescribed in this Code, a minor or major plan amendment, or a permit application pursuant to Division 6.27, *Guidelines and Regulations for Areas and Activities of State Interest*.

Development application for permitted use shall mean a development application submitted in the form required by this Code to the City for an overall development plan, a project development plan, a final plan or a Building Permit, including only uses described as permitted uses in the applicable zone district. A PUD Overlay is also considered to be a development application for a permitted use even though the PUD Overlay may request uses that are not permitted in the applicable underlying zone district.

Development plan shall mean an application submitted to the City for approval of a permitted use that depicts the details of a proposed development. Development plan includes an overall development plan, a project development plan, a final plan, a basic development review, and/or an amendment of any such plan. A PUD Overlay is also considered to be a development plan even though the PUD Overlay may request uses that are not permitted in the applicable underlying zone district. Additionally, an application for a permit pursuant to Division 6.27, *Guidelines and Regulations for Areas and Activities of State Interest*, is considered a development plan even though the application may propose uses that are not permitted in the applicable zone district or districts.

Development project shall mean a project that has been reviewed under the applicable city review process and has been approved and is ready for development construction to begin. For the purposes of the Development Construction Permit and its related requirements, bonds, warranties and fees, if such a project has defined phases, then each phase shall be considered a development project independent from the other phases.

Development site shall mean the real property, whether consisting of one (1) or more lots or areas of land, that is the subject of any application allowed under the Land Use Code.

Developmentally disabled shall mean a person five (5) years of age or older with a severe, chronic disability that:

- (A) Is attributable to a mental or physical impairment or combination of mental and physical impairments;
- (B) Is manifested before the person attains age twenty-two (22);
- (C) Results in substantial functional limitations in three or more of the following areas of major life activity:
 - (1) Self-care;
 - (2) Receptive and expressive language;
 - (3) Learning;
 - (4) Mobility;
 - (5) Self-direction;
 - (6) Capacity for independent living;
 - (7) Economic self-sufficiency; and
- (D) Reflects the person's need for a combination and sequence of special, interdisciplinary or generic care, treatment or other services and supports that are of lifelong or extended duration and are individually planned and coordinated; except that such term, when applied to infants and young children, shall mean individuals from birth to age five (5) years, inclusive, who have substantial developmental delay or specific congenital or acquired conditions with a high probability of resulting in developmental disabilities if services or supports are not provided.

Diameter-at-breast-height (DBH) shall mean tree trunk diameter as measured in inches at a height of four and one-half (4.5) feet above the ground or, in the case of a tree that is divided into multiple trunks below four and one-half (4.5) feet, as measured at the most narrow point beneath the point of division.

Digital electronic message center shall mean a display surface that is composed of light emitting diodes (LEDs) or comparable light sources that is capable of displaying variable messages and graphics, which are generally created on a computer. Digital electronic message centers are also known as EMCs.

Director shall mean the Director of the Department.

Dog day care facility shall mean a facility providing such services as canine day care for all or part of a day, obedience classes, training, grooming and/or behavioral counseling, provided that overnight boarding is not permitted.

Dormitory shall mean a building used as group living quarters for students or religious adherents as an accessory use for a bona fide college, university, boarding school, seminary, convent, monastery or other similar institutional use.

Drip line shall mean a vertical line extending from the outermost edge of the tree canopy or shrub branch to the ground.

Drive aisles shall mean the lanes in a parking lot devoted to the passage of vehicles, as opposed to the parking stalls. The term drive aisle does not include lanes used only or primarily for drive-in customer service.

Drive-in use shall mean an establishment that by design, physical facilities, service or packaging procedures encourages or permits customers to receive services, obtain goods or be entertained while remaining in their motor vehicles.

Drop-in child care center shall mean a center that provides occasional care for forty (40) or fewer children between the ages of twelve (12) months and thirteen (13) years for periods of time not to exceed six (6) hours in any twenty-four-hour period or fifteen (15) hours in any seven-day period.

Dust control manual shall mean the dust control and prevention standards enacted to protect air quality adopted under Chapter 12 of the City Code.

Dwelling shall mean a building with habitable space used exclusively for residential occupancy and for permitted accessory uses. The term dwelling shall not include hotels, motels, homeless shelters, seasonal overflow shelters, tents or other structures designed or used primarily for temporary occupancy with the exception of short term primary and non-primary rentals.

Dwelling, multi-unit shall mean a dwelling containing three (3) or more dwelling units, not including hotels, motels, fraternity houses and sorority houses and similar group accommodations.

Dwelling, single-unit shall mean a dwelling containing no more than one (1) dwelling unit.

Dwelling, single-unit attached shall mean a single-unit dwelling attached to one (1) or more dwellings or buildings, with each dwelling located on its own separate lot.

Dwelling, single-unit detached shall mean a single-unit dwelling that is not attached to any other dwelling or building by any means, including mobile homes and manufactured housing situated on a permanent foundation.

Dwelling, two-unit shall mean a dwelling containing two (2) dwelling units.

Dwelling, two-unit attached shall mean a two-unit dwelling attached to one other two-unit dwelling with each such two-unit dwelling located on its own separate lot.

Dwelling unit shall mean habitable floor space intended for the exclusive use of a single household with a single kitchen, or including a second kitchen pursuant to Section 5.3.6.

ECMC shall mean the Colorado Energy and Carbon Management Commission.

Elderly shall mean a person sixty (60) years of age or older.

Electronic message center, or EMC, shall mean the portion of an on-premise ground or wall sign that is capable of displaying words or images that can be electronically changed by remote or automatic means.

Eligible facilities request or EFR shall mean any request for modification of an existing tower or base station that does not substantially change the physical dimensions of such tower or base station involving: (i) collocation of new transmission equipment, (ii) removal of transmission equipment, or (iii) replacement of transmission equipment. A request for modification of an existing tower or base station that does not comply with the generally applicable building, structural, electrical, and safety codes or with other laws codifying objective standards reasonably related to health and safety, or does not comply with any relevant federal requirements, is not an eligible facilities request.

Eligible support structure shall mean any tower or base station as defined in this Section, provided it exists at the time the relevant application is filed with the City under this Code.

Employees shall mean the total number of persons reasonably anticipated to be employed in a building or on land during normal periods of use.

Enclosed mini-storage shall mean a building containing separate, individual, private storage spaces, that may be of various sizes, and that are rented pursuant to individual leases for varying periods of time.

Engineer shall mean the City Engineer, who shall have those duties and powers as set forth in Section 24-39 of the City Code.

Entertainment facilities and theaters shall mean a building or part of a building devoted to showing motion pictures or dramatic, musical or live performances.

Equipment Cabinets shall mean a structure used to house equipment used by service providers at a WCF. This definition does not include relatively small electronic components, such as remote radio units, radio transceivers, amplifiers, or other devices mounted behind antennas, if they are not used as physical containers for smaller, distinct devices.

Exhibit hall shall mean a privately owned building or part of a building devoted to the routine display for public viewing (but not sale) of works of art or other similar articles or collectibles of enduring interest or value, and where such display is intended, in part, to serve the educational and cultural needs of the community as a whole.

Exists and Existing shall mean a constructed tower or base station that was reviewed, approved, and lawfully constructed in accordance with all requirements of applicable law as of the time of an eligible facilities request is received by the City, provided that a tower that exists as a legal, non-conforming use and was lawfully constructed is existing for purposes of this definition.

Existing limited permitted use shall mean any use that was permitted for a specific parcel of property pursuant to the zone district regulations in effect for such parcel on March 27, 1997, that is not specifically listed as a permitted use under the zone district regulations of the zone district of this Code in which the parcel of property is located, and that physically existed upon such parcel on March 27, 1997. Such use is permitted in the various zone districts established in Article 2 under the limitation that such use shall constitute a permitted use only on such parcels of property.

Extent reasonably feasible shall mean that, pursuant to the City's determination, under the circumstances, reasonable efforts have been undertaken to comply with the regulation, that the costs of compliance clearly outweigh the potential benefits to the public or would unreasonably burden the proposed project, and reasonable steps have been undertaken to minimize any potential harm or adverse impacts resulting from noncompliance with the regulation.

Extra occupancy shall mean the use of a building or portion of a building by a number of occupants that exceeds the occupancy limits set forth in Section 5.14.1.

FAA shall mean the United States Federal Aviation Administration.

Family shall mean any number of persons who are all related by blood, marriage, adoption, guardianship or other duly authorized custodial relationship, and who live together as a single housekeeping unit and share common living, sleeping, cooking and eating facilities.

Family-care home shall mean a facility for child care in a place of residence of a family or person for the purpose of providing family care and training for a child under the age of sixteen (16) years who is not related to the occupants of such home, or a facility in a place of residence of a family or person for the purposes of providing elderly day care. The three (3) categories of family-care homes are defined as follows:

- (A) Day care home shall mean a facility licensed by the State of Colorado that provides on a regular basis in a place of residence, less than twenty-four-hour care for two (2) or more children from different family households who are not related to the caregiver. Such a facility may be any of the following three (3) types of family care homes as defined by the State of Colorado: family child care home, infant/toddler home or experienced family child care provider home.
- (B) Family foster home shall mean a facility providing care and training for a child or children not related to the caretaker for regular twenty-four-hour care, provided that such child or children are received from

any state-operated institution for child care or from any child placement agency as defined in Section 26-6-903(10), C.R.S.

- (C) Elderly day care home shall mean a home in a place of residence of a family or person for the daytime care, protection and supervision of persons of at least sixty (60) years of age, who are not related to the caretakers, for more than two (2) full days per week.

Farm animals shall mean animals commonly raised or kept in an agricultural, rather than an urban, environment, including, but not limited to, chickens, pigs, sheep, goats, horses, cattle, llamas, emus, ostriches, donkeys and mules; provided, however, that farm animals shall not include chicken hens, ducks or pygmy or dwarf goats kept pursuant to Section 4-121 of the City Code.

FCC shall mean the United States Federal Communications Commission.

Feedlot shall mean any tract of land or structure, pen or corral, wherein cattle, horses, sheep, goats, emus, ostriches or swine are maintained in close quarters for the purpose of fattening such livestock for final shipment to market.

Festoon lighting shall mean electric lighting with individual bulbs suspended along a string that incorporates power wiring and is suspended between two (2) or more points.

Flag shall mean a flexible piece of fabric, that is attached along one (1) edge to a straight, rigid flagpole (directly or with rope), and that is designed to move when the wind blows. Flags are typically (but not necessarily) rectangular in shape, and often (but not always) include printed or embroidered insignia that symbolizes a nation, state, or organization, or that display a graphic or message.

Flag, feather shall mean a flexible piece of fabric that is attached to a flexible pole along a long edge such that the pole stretches the fabric taut regardless of wind conditions. Feather flags are also commonly referred to as "teardrop banners," "teardrop flags," and "flutter flags."

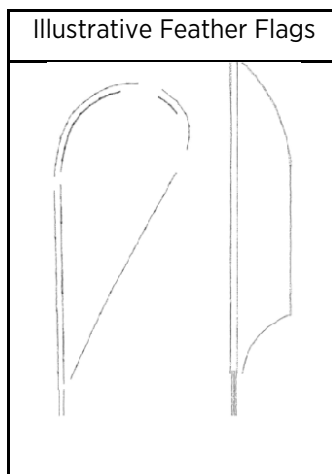

Flowback shall mean the process of allowing fluids and entrained solids to flow from a well following stimulation, either in preparation for a subsequent phase of treatment or in preparation for cleanup and placing the Well into production. The term flowback also means the Fluids and entrained solids that emerge from a Well during the flowback process.

Flowline shall mean a segment of pipe transferring oil, gas, or condensate between a wellhead and processing equipment to the load point or point of delivery to a U.S. Department of Transportation Pipeline and Hazardous Materials Safety Administration or Colorado Public Utilities Commission regulated gathering line or a segment of pipe transferring produced water between a wellhead and the point of disposal discharge or loading. This definition of flowline does not include gathering line.

Food catering or small food product preparation shall mean an establishment in which the principal use is the preparation of food and/or meals on the premises, and where such food and/or meals are delivered to another location for consumption or distribution, and where such use occupies not more than five thousand (5,000) square feet in gross floor area.

Food membership distribution site shall mean a site where a producer of agricultural products delivers them for pick-up by customers who have pre-purchased an interest in the agricultural products.

Food truck rally shall mean a temporary or periodic special event, operating under a Special Vending License, of more than two (2) outdoor vendors (such as food trucks and carts), held on an improved private lot with permission of the owner thereof, and only serving pedestrians.

Foot-candle shall mean a unit of measurement referring to illumination incident to a single point. One (1) foot-candle is equal to one (1) lumen uniformly distributed over an area of one (1) square foot.

Fraternity and sorority houses shall mean residences housing students in organizations established primarily to promote friendship and welfare among the members (i.e., Greek-letter social fraternities and similar organizations), and which residences are affiliated with Colorado State University.

Fully shielded shall mean shielded or constructed so that no light rays are emitted by the installed outdoor light fixtures at angles above the horizontal plane, as certified by a photometric test report.

Funeral home shall mean a building used for the preparation of the deceased for burial or cremation, for the display of the deceased and/or for ceremonies or services related thereto, including cremation and the storage of caskets, funeral urns, funeral vehicles and other funeral supplies.

Gasoline station shall mean any building, land area, premises or portion thereof, where gasoline or other petroleum products or fuels are sold and light maintenance activities such as engine tune-ups, lubrication, minor repairs and carburetor cleaning may be conducted. *Gasoline station* shall not include premises where heavy automobile maintenance activities such as engine overhaul, automobile painting and body fender work are conducted.

Gathering line shall mean a gathering pipeline or system as defined by the Colorado Utilities Commission, Regulation No. 4, 4 C.C.R. 723-4901, Part 4, (4 C.C.R. 723-4901) or a pipeline regulated by the U.S. Department of Transportation Pipeline and Hazardous Materials Safety Administration pursuant to 49 C.F.R. §§ 195.2 or 192.8. 49 C.F.R. §§ 195.2 or 192.8 and 4 C.C.R. 723-4901 in existence as of the date of this regulation and does not include later amendments.

Geologic hazards shall mean unstable or potentially unstable slopes, faulting, landslides, rockfalls, flood, wildfire or similar naturally occurring dangerous features or soil conditions or natural features unfavorable to development.

Glare shall mean the sensation produced by luminances within the visual field that are sufficiently greater than the luminance to which the eyes are adapted that causes annoyance, discomfort, or loss in visual performance or visibility.

Grade shall mean the elevation of the edge of the paved surface of the street at the closest point to the sign for the purpose of measuring the height of signs.

Grocery store shall mean a retail establishment that primarily sells food, but also may sell other convenience and household goods, and that occupies a space of at least five thousand (5,000) square feet but not more than forty-five thousand (45,000) square feet.

Gross leasable area shall mean the total floor area designed for tenant occupancy and exclusive use, including basements, mezzanines and upper floors, if any, expressed in square feet measured from centerlines of joint partitions and exteriors of outside walls.

Ground-mounted solar energy system shall mean a solar energy system with a supporting framework that is placed on, or anchored in, the ground and that is structurally independent from any building. Carports, garages, breezeways, covered walkways or similar nonclimatized accessory structures that incorporate building-mounted solar energy systems shall not be classified as ground-mounted solar energy systems and shall instead be subject to height and setback regulations governing accessory structures.

Group home shall mean either of the following:

- (A) Residential group home shall mean a residence operated as a single dwelling, licensed by or operated by a governmental agency, or by an organization that is as equally qualified as a government agency and having a demonstrated capacity for oversight as determined by the Director, for the purpose of providing special care or rehabilitation due to homelessness, physical condition or illness, mental condition or illness, elderly age or social, behavioral or disciplinary problems, provided that authorized supervisory personnel are present on the premises.
- (B) Large group care facility shall mean a residential facility that is planned, organized, operated and maintained to offer facilities and services to a specified population and is licensed by or operated by a governmental agency, or by an organization that is as equally qualified as a government agency and having a demonstrated capacity for oversight as determined by the Director, for the purpose of providing special care or rehabilitation due to homelessness, physical condition or illness, mental condition or illness, elderly age or social, behavioral or disciplinary problems, provided that authorized supervisory personnel are present on the premises.

Habitable floor space shall mean the space in a building approved for living, sleeping, eating, cooking, bathing and personal hygiene. Crawl spaces, storage, laundry rooms, utility spaces and similar areas are not considered habitable spaces.

Hard goods shall mean bulky, durable goods such as household appliances, furniture, automobiles and farm and construction equipment, that all require extensive floor area for display.

Hardscape shall mean any non-living horizontal site element, including but not limited to patios, decks, walkways, sidewalks, driveways, and steps.

Hazardous materials shall mean those chemicals or substances that are physical or health hazards as defined and classified in the Fire and Building Codes. Hazardous materials categories include explosives and blasting agents, compressed gases, flammable and combustible liquids, flammable solids, organic peroxides, oxidizers, pyrophoric materials, unstable (reactive) materials, water-reactive solids and liquids, cryogenic fluids, highly toxic and toxic materials, radioactive materials, corrosives, carcinogens, irritants, sensitizers and other health hazards. Each category is defined separately in the Fire and Building Codes in accordance with the Code of Federal Regulations Title 29 and other nationally recognized standards.

Health club shall mean an establishment that is open only to members and guests and that provides facilities for at least three (3) of the following: aerobic exercises, running and jogging, exercise equipment, game courts and swimming facilities, and that also includes amenities such as spas, saunas, showers and lockers.

Heavy industrial uses shall mean uses engaged in the basic processing and manufacturing of materials or products predominately from extracted or raw materials, or a use engaged in storage of, or manufacturing processes using flammable or explosive materials, or storage or manufacturing processes that potentially involved hazardous conditions. *Heavy industry* shall also mean those uses engaged in the operation, parking and maintenance of vehicles, cleaning of equipment or work processes involving solvents, solid waste or sanitary waste transfer stations, recycling establishments, and transport terminals (truck terminals, public works yards, container storage).

High occupancy building unit shall mean:

- (a) Any public or private school, nursing facility as defined in § 25.5-4-103(14), C.R.S., hospital, life care institution as defined in § 12-13-101, C.R.S., or correctional facility as defined in § 17-1-102(1.7), C.R.S., provided the facility or institution regularly serves 50 or more persons;
- (b) An operating Child Care Center as defined in § 26-6-102(5), C.R.S.; or
- (c) A multiunit dwelling with four or more units

Historic comparison boundary shall mean the two hundred (200) foot boundary measured in all directions from the perimeter of each historic resource identified in Section 5.8.1(C)(2)(a), (b), or (c).

Historic influence area shall mean the overlapping area formed when the outer boundary of a development site and a historic comparison boundary overlap.

Historic preservation staff shall mean City Historic Preservation Division staff who meet the professional qualification standards provided in Code of Federal Regulations, 36 CFR Part 61.

Historic resource shall mean a building, site, structure, or object that is located on a lot, lots, or area of property and is (1) designated as a Fort Collins landmark or is contributing to a Fort Collins landmark district; (2) designated on the Colorado State Register of Historic Properties, either individually or contributing to a district, or the National Register of Historic Places, either individually or contributing to a district; or (3) determined to be eligible for designation as a Fort Collins landmark either through a binding or non-binding determination pursuant to Land Use Code Section 5.8.1(D).

Home occupation shall mean an occupation or business activity that results in a product or service and is conducted in whole or in part in a dwelling unit, and is subordinate to the residential use of the dwelling unit.

Homeless shelters shall mean a fully enclosed building other than a hotel, motel, or lodging establishment that is suitable for habitation and that provides residency only for people experiencing homelessness at no charge at any time during the year. Community based shelter services are exempt from this definition.

Hoop house shall mean a structure used for the purpose of growing crops that has a semi-flexible, nonmetallic frame covered by a flexible polyethylene film of not more than six (6) mil, but not containing any mechanical or electrical systems or equipment or storage items.

Hotel/motel/lodging establishment shall mean a building intended and used for occupancy as a temporary abode for individuals who are lodged with or without meals, in which there are five (5) or more guest rooms. The terms *hotel/motel/lodging establishment* shall not include homeless shelters, seasonal overflow shelters, and short term primary and non-primary rentals.

Housing model shall mean a single-unit or two-unit dwelling having at least three (3) distinguishing major exterior features, including elevations, material treatments, front facade, rooflines and entryway.

Hydrozone shall mean an area within the landscape defined by a grouping of plants requiring a similar amount of water to sustain health. For the purposes of this Code, hydrozones are divided into the following four (4) categories:

- (A) Very low hydrozones include plantings that need supplemental water when first planted, but little or none once established.
- (B) Low hydrozones include plantings that generally do not require more than three (3) gallons per square foot of supplemental water per year. These plantings require additional water during plant establishment or drought.
- (C) Moderate hydrozones include plantings that generally require ten (10) gallons per square foot of supplemental water per year.
- (D) High hydrozones include plantings that generally require eighteen (18) gallons per square foot of supplemental water per year.

I-25 activity center (located as described in the I-25 Subarea Plan) shall mean an area of concentrated development containing more than one (1) principal land use type and generally served by high frequency transit. Such land uses may include office, retail, residential or service uses such as hotels, motels and personal and business services. In an I-25 activity center, the different types of land uses are in close proximity, planned as a unified complementary whole, and functionally integrated to the use of vehicular and pedestrian access and parking areas.

Ideally oriented luminaire shall mean a luminaire mounted with the backlight portion of the light output oriented perpendicular to and towards the property line of concern.

Illuminance shall mean the incidental light falling on a surface as measured in footcandles (fc). Total illuminance at a point is a combination of all light sources that contribute.

Improved arterial street shall mean that portion of an arterial street which has been totally or partially constructed to arterial street standards and accepted by the City.

Improved arterial street network shall mean the system of improved arterial streets that are interconnected and that are defined on the city map titled Improved Arterial Streets Network maintained by the City Engineer.

Improvement shall mean any man-made, immovable item that becomes part of, is placed upon or is affixed to real estate.

Indoor kennel shall mean an establishment in which twenty-four (24) hour care and boarding is provided for household dogs or cats within a soundproof building (or buildings) that contains exercise facilities, separate ventilation systems for dogs and cats if they are boarded in the same building, and wherein other services such as grooming and training are offered. Dogs in an indoor kennel are only allowed in an outdoor exercise area during the hours of 8am-5pm.

Infrastructure shall mean those man-made structures that serve the common needs of the population, such as: potable water systems; wastewater disposal systems, solid waste disposal sites or retention areas; storm drainage systems; electric, gas or other utilities; bridges; roadways; bicycle paths or trails; pedestrian sidewalks, paths or trails; and transit stops.

Inhabitant shall mean a person who dwells and is domiciled in a place, as distinguished from a lodger or visitor.

Initial luminaire lumens shall mean the light output of the lamp or luminaire before any light loss factors are considered.

Junkyard shall mean an industrial use (not permitted in residential, business or commercial districts) contained within a building, structure or parcel of land, or portion thereof, used for collecting, storing or selling wastepaper, rags, scrap metal or discarded material or for collecting, dismantling, storing, salvaging or

demolishing vehicles, machinery or other material and including the sale of such material or parts thereof. Junkyard shall not include a recycling facility.

Kenel shall mean a facility where the overnight boarding of dogs, cats or other household pets is conducted as a business.

Kitchen shall mean a portion of a dwelling unit used, or designated to be used for, the purposes of cooking, preserving, or otherwise preparing food and contains a range or a combination of a cook-top and oven. An area of a dwelling unit with a cooking appliance that is not a range or combination of a cook-top and oven, such as a microwave or hot-plate, is not a kitchen.

Landscaping shall mean any combination of living plants such as trees, shrubs, plants, vegetative ground cover or turf grasses, and may include structural features such as walkways, fences, benches, works of art, reflective pools, fountains or the like. Landscaping shall also include irrigation systems, mulches, topsoil use, soil preparation, revegetation or the preservation, protection and replacement of existing trees.

Large base industry shall mean a firm that:

- (A) Produces, or will produce, manufactured goods, at least eighty (80) percent of which are, or will be, produced for export to areas outside of the City; or provides medical, internet, telecom, education or publishing products and services for local and regional users; or establishes corporate offices;
- (B) Employs, or will employ, no fewer than one hundred (100) persons for at least thirty-five (35) hours of year-round employment per week; and
- (C) Owns or leases, or will own or lease, real property or equipment within the city limits that is used in the operation of the firm's business and that has, or will have, as of the date of the commencement of the firm's operation, a fair market value of no less than one hundred million dollars (\$100,000,000).

Large retail establishment shall mean a retail establishment, or any combination of retail establishments in a single building or in separate but abutting buildings, or a movie theater or an indoor recreational use, occupying more than twenty-five thousand (25,000) gross square feet of floor area.

Laundry and dry-cleaning retail outlet shall mean a laundry or dry-cleaning outlet whose business consists primarily of serving retail customers, provided that any laundry and dry-cleaning processing that occurs on the premises is limited to items that are brought directly to the premises by the retail customer.

Level of service shall mean an indicator of the extent or degree of service provided by, or proposed to be provided by, a facility based on, and related to, the operational characteristics of the facility. Level of service shall indicate the capacity per unit of demand for each public facility.

Lifestyle shopping center shall mean a shopping center that is planned and developed as a unit and intended to serve consumer demands from the community as a whole and the region, with primary offerings of specialty retailers such as apparel, home furnishings/accessories, books/music, bath/body, sporting goods and grocery stores, and that offers sit-down restaurants, coffee shops, ice cream parlors, entertainment facilities and theatres, office uses and/or uses of similar character. Such a center is designed with architectural distinction, individual identity for each store and buildings that are brought together along a sidewalk network in an open-air setting, with a small park or plaza, and a high level of amenity in landscaping and urban furnishings.

Light industrial shall mean uses engaged in the manufacture, predominantly from previously prepared materials, of finished products or parts, including processing, fabrication, assembly, treatment, packaging, incidental storage, sales or distribution of such products. Further, light industrial shall mean uses such as the manufacture of electronic instruments, preparation of food products, pharmaceutical manufacturing, research

and scientific laboratories or the like. Light industrial shall not include uses such as mining and extracting industries, petrochemical industries, rubber refining, primary metal or related industries.

Light loss factor (LLF) shall mean a depreciation factor that describes the drop in light output over the life of the system. The total LLF is determined by a combination of factors, such as lumen depreciation and luminaire dirt depreciation. Light Loss Factors = 1.0 for evaluating compliance with Section 5.12.1.

Lighting, indirect when applied to the lighting of signs, shall mean reflected light only from a concealed light source outside the sign face that reflects from the sign face only or from the sign face and sign copy.

Limited indoor recreation use shall mean facilities established primarily for such activities as exercise or athletic facilities; and amusement or recreational services, such as billiard or pool parlors, pinball/video arcades, dance studios, martial art schools, arts or crafts studios; or exercise clubs, but not including bowling alleys or establishments which have large-scale gymnasium-type facilities for such activities as tennis, basketball or competitive swimming. This definition is intended to restrict the type of recreational use allowed to those small-scale facilities containing no more than five thousand (5,000) square feet that would be compatible with typical buildings and uses in the zone district in which this use is allowed.

Limits of development shall mean the areas described and established pursuant to Section 5.6.1(N).

Local street shall mean a street that is anticipated to carry under two thousand five hundred (2,500) vehicle trips per day in traffic volume at desirable speeds of up to twenty-five (25) miles per hour, and that provides access to abutting property and primarily serves local traffic.

Local street system shall mean a system of one (1) or more local streets that allow traffic to be distributed throughout a neighborhood.

Lodging establishment shall mean hotel/motel.

Logo shall mean a graphic symbol or emblem that conveys a recognizable meaning, which symbol or emblem may include script (words) provided that such script is contained entirely within the boundaries of the symbol or emblem; and script alone, or outside of the boundaries of the symbol or emblem, whether registered as a trademark or not, is not included within the meaning of the term logo.

Long-term care facility shall mean any of the following:

- (A) Convalescent or rehabilitation center shall mean a health institution that is planned, organized, operated and maintained to offer facilities and services to inpatients requiring restorative care and treatment and that is either an integral patient care unit of a general hospital or a facility physically separated from, but maintaining an affiliation with, all services in a general hospital.
- (B) Nursing or memory care facility shall mean a health institution planned, organized, operated and maintained to provide facilities and health services with related social care to inpatients who require regular medical care and twenty-four (24) hour per day nursing services for illness, injury or disability. Each patient shall be under the care of a physician licensed to practice medicine in the State of Colorado. The nursing services shall be organized and maintained to provide twenty-four (24) hour per day nursing services under the direction of a registered professional nurse employed full time.
- (C) Intermediate health care or assisted living facility shall mean a health-related institution planned, organized, operated and maintained to provide facilities and services which are supportive, restorative or preventive in nature, with related social care, to individuals who because of a physical or mental condition, or both, require care in an institutional environment but who do not have an illness, injury or disability for which regular medical care and twenty-four (24) hour per day nursing services are required.

(D) Independent living or continuing care facility shall mean a single-unit, two-unit and/or multi-unit dwelling that is located within a development that contains one (1) or more of the facilities described in (A) through (C) above, wherein the residents of such dwellings have access to the common amenities and services available to residents of the facilities described in (A) through (C) above.

Long-term parking shall mean parking that has limited turnover during a normal working weekday. Long-term parking includes employee-type parking or residential-type parking.

Lumen (lm) shall mean the luminous flux emitted within a unit solid angle by a point source (one steradian) having a uniform luminous intensity of one candela (cd). See luminous flux.

Luminaire shall mean a complete lighting device consisting of the light source, lens, reflector, refractor, driver, housing and such support as is integral with the housing. If the driver is located within the housing, it is considered integral and therefore part of the luminaire. The pole, posts, and bracket or mast arm are not considered to be part of the luminaire.

Luminance (candelas per square meter, cd/m² or nits) shall mean the luminous intensity of any surface in a given direction per unit of projected area of the surface as viewed from that direction; i.e., the apparent brightness of a surface.

Luminous flux (lumen, lm) shall mean a unit of measure of the quantity of light. One lumen is the amount of light that falls on an area of one square meter, every point of which is one meter from a source of one candela. A light source of one candela emits a total of 12.57 lumens. Light sources are rated in terms of luminous flux. Lumens are used for evaluating compliance with Section 5.12.1.

Luminous intensity (candela, cd) shall mean the basic unit of light quantity as measured in candelas. The candela can be thought of as the number of photons per second emitted by the light source.

Maintenance (of a newly constructed street) shall mean keeping the street free of dirt, mud, debris and any other foreign material that would constitute a safety hazard or a nuisance or cause damage to the newly constructed street, and shall also include repainting traffic control striping, repairing and replacing traffic control signs and signals as necessary, and maintaining median/parkway landscaping and irrigation systems and supplying water therefor.

Major addition shall mean the extension of an existing building where the cost of the addition, not including repairs and reconstruction of the existing building, is in excess of the assessed valuation of the existing building as assessed by the county Assessor during the year immediately preceding the year in which such major addition takes place.

Major public facilities shall mean structures or facilities, such as electrical generation plants, water treatment plants, wastewater treatment plants, natural gas generation power plants, railroad depots and transportation fleet maintenance facilities, that are generally occupied by persons on a daily basis to conduct operations and that contain or involve traffic-generating activities. *Major public facilities* include outdoor storage but shall not include wireless communication facilities.

Major walkway spine shall mean a tree-lined connecting walkway that is at least five (5) feet wide, with landscaping along both sides, located in an outdoor space that is at least thirty-five (35) feet in its smallest dimension, with all parts of such outdoor space directly visible from a street.

Manual changeable copy message center shall mean a sign element in which letters, numbers, or symbols may be changed manually without altering the face of the sign (e.g., by placement of letters into tracks that are enclosed within a cabinet structure). Manual changeable copy centers are sometimes known as "readerboards."

Manufactured home shall mean a preconstructed, transportable dwelling unit built on a permanent chassis and anchored at the site where it will be occupied as a dwelling unit. The term manufactured home shall also include mobile homes, which are similar transportable dwelling units constructed prior to federal manufactured home standards adopted in 1976.

Manufactured housing community shall mean a parcel of land that has been planned, improved, or is currently used for the placement of five or more manufactured homes. Manufactured housing communities may also contain accessory uses intended primarily for the use and benefit of their residents, including but not limited to clubhouses, playgrounds and recreational amenities, childcare, meeting and assembly spaces, retail, and personal and business services.

Marginal-access street shall mean a local street that is parallel to and adjacent to expressways or arterials and that provides access to abutting properties and protection from through traffic.

Marijuana products shall mean concentrated marijuana products and marijuana products that are comprised of marijuana and other ingredients and are intended for use or consumption, such as, but not limited to, edible products, ointments, and tincture as defined in Section 16 (2)(k) of Article XVIII of the Colorado State Constitution.

Massing shall refer to the perception of the overall shape, form, and size of a building.

Maximum extent feasible shall mean that pursuant to the City's determination, no feasible and prudent alternative exists, and all possible efforts to comply with the regulation or minimize potential harm or adverse impacts have been undertaken.

Medical marijuana center shall mean a person licensed pursuant to Title 12, Article 43.3, C.R.S., to operate a business as described in Section 44-10-103(34) C.R.S., that sells medical marijuana to registered patients or primary caregivers as defined in Section 14 of Article XVIII of the State Constitution, but is not a primary caregiver.

Medical marijuana-infused products manufacturer shall mean a person licensed pursuant to Title 12, Article 43.3, C.R.S., to operate a business as described in Section 12-44-10-103(39), C.R.S.

Medical marijuana optional premises cultivation operation shall mean a person licensed pursuant to Title 12, Article 43.3, C.R.S., to operate a business as described in Section 12-43.3-404, C.R.S.

Medical marijuana research and development cultivation shall mean a facility used by a person or entity licensed pursuant to Title 12, Article 43.3, C.R.S., to operate a business as described in Section 12-44-10-103(37), C.R.S.

Medical marijuana research and development facility shall mean a facility used by a person or entity licensed pursuant to Title 12, Article 43.3, C.R.S., to operate a business as described in Section 12-44-10-103(35), C.R.S.

Medical marijuana testing facility shall mean a facility used by a person or entity licensed pursuant to Title 12, Article 43.3, C.R.S., to operate a business as described in Section 12-44-10-103(35), C.R.S.

Microbrewery shall mean a facility that produces no more than fifteen thousand (15,000) barrels per year of fermented malt beverages on site and shall include a taproom in which guests/customers may sample the product.

Microdistillery shall mean a facility that produces no more than fifteen thousand (15,000) gallons per year of spirituous beverages on site and shall include a tasting room in which guests/customers may sample the product.

Microwinery shall mean a facility that produces no more than one hundred thousand (100,000) gallons per year of vinous beverages on site and shall include a tasting room in which guests/customers may sample the product.

Minor public facilities shall mean structures or facilities, such as electrical generating and switching stations, substations, underground vaults, poles, conduits, water and sewer lines, pipes, pumping stations, natural gas pressure-reducing stations, repeaters, antennas, transmitters and receivers, valves and stormwater detention ponds, that are not occupied by persons on a daily basis except for periodic inspection and maintenance, are capable of operation without daily oversight by personnel and do not generate daily traffic. Such facilities also include similar structures for fire protection, emergency service, parks and recreation and natural areas. *Minor public facilities* shall not include outdoor storage and wireless communication facilities.

Minor subdivision shall mean the subdivision of a lot, tract or parcel into not more than one (1) new lot and may include adjustments to lot lines.

Mixed use shall mean the development of a lot, tract or parcel of land, building or structure with two (2) or more different uses, including, but not limited to, residential, office, retail, public uses, personal service or entertainment uses (but not including accessory uses), designed, planned and constructed as a unit.

Mobility Assisted Device shall mean a wheelchair, motorized scooter, or other tool that aids those living with physical or mental disabilities in moving along City sidewalks, non-vehicular paths, and trails. These do not include recreational motorized devices such as skateboards and toy vehicles or road machinery/road tractor as defined in the City of Fort Collins Traffic Code.

Monument style shall mean a style of freestanding sign characterized by a supporting sign structure that is at least seventy (70) percent of the width of the sign face, and that contains not more than two (2) sign faces.

Music facility, multi-purpose, shall mean a facility that may include indoor and outdoor space for the purpose of music workshops, meetings, informal gatherings, occasional small-scale music performances, and occasional recitals and open microphone sessions where performance spaces do not include permanent or designated seating or paid admission.

Music studio shall mean a fully enclosed soundproof studio for the recording, producing, writing or rehearsing of music.

Native vegetation shall mean any plant identified in Fort Collins Native Plants: Plant Characteristics and Wildlife Value of Commercial Species, prepared by the City's Natural Resources Department, updated February 2003.

Natural area shall mean all areas shown as "natural areas" on the City's *Parks and Natural Areas Map* or the *Natural Habitats and Features Inventory Map*. Any land that qualifies as a "wetland" pursuant to the Federal Clean Water Act shall also be deemed a natural area, in addition to the areas designated as wetlands on the City's *Natural Habitats and Features Inventory Map*. Any land area that possesses such characteristics as would have supported its inclusion on the *Natural Habitats and Features Inventory Map*, or contains natural habitats or features that have significant ecological value listed in subparagraph 5.6.1(A), if such area is discovered during site evaluation and/or reconnaissance associated with the development review process, shall also be deemed a natural area.

Natural area buffer zone shall mean any area described and established pursuant to subsection 5.6.1(E).

Natural features shall mean the following:

- (A) natural springs,
- (B) areas of topography which, because of their steepness, erosion characteristics/geologic formations, high visibility from off-site locations and/or presence of rock outcroppings, and

(C) view corridors that present vistas to mountains and foothills, water bodies, open spaces and other regions of principal environmental importance, provided that such natural features are either identified on the City's *Natural Habitats and Features Inventory Map*, or otherwise meet the definition of *natural area* as contained in this Article.

Neighborhood center shall mean a combination of at least two (2) uses as listed in the Low Density Mixed-Use Neighborhood zone district in addition to an outdoor space, which together provide a focal point and a year-round meeting place for a neighborhood.

Neighborhood park shall mean a publicly owned park as defined in the Parks and Recreation Policy Plan.

Neighborhood plan shall mean a document adopted by the City Council as a part of the Comprehensive Plan of the City containing public policies relating to a specific neighborhood.

Neighborhood service center shall mean a shopping and service center, approximately fifteen (15) acres in size, designed to meet consumer demands from an adjacent neighborhood. The primary functional offering is usually a supermarket with an approximately equivalent amount of associated mixed retail and service-oriented gross square footage. Other functional offerings may include employment uses, such as offices and/or commercial development traditionally located along arterial streets.

Neighborhood support/recreation facilities shall mean recreation/pool facilities and/ or meeting rooms intended for the use and enjoyment of residents and guests of the neighborhood.

Nightclub shall mean a bar or similar nonalcoholic establishment containing more than one hundred (100) square feet of dance floor area.

Nonconforming building shall mean a building that was lawful and nonconforming under prior law on the day before the effective date of this Code or subsequent amendment thereof.

Nonconforming structure shall mean a structure that was lawful and nonconforming under prior law on the day before the effective date of this Code or subsequent amendment thereof.

Nonconforming use shall mean either a use that was lawful and nonconforming under prior law on the day before the effective date of this Code or subsequent amendment thereof, or with respect to lands newly annexed, a use that was lawful immediately before annexation but that does not conform to the use regulations for the zone district in which such use is located either at the time of annexation or as the result of subsequent amendments to this Code.

Nonconformities shall mean a nonconforming use, structure or building.

Object, for purposes of Section 5.8.1 only, shall mean a material thing of functional, aesthetic, cultural, historical or scientific value that may be, by nature or design, movable.

Occupant, in relation to extra occupancy and in other parts of this Code, shall mean a person who occupies habitable space in a dwelling unit or any portion thereof.

Off-site construction staging shall mean the use of land or building or portion thereof for activities commonly associated with and supportive of construction or development, when such activities are not located on the parcel, or in the building, being constructed or developed. Such activities include but are not limited to storage of construction material and equipment, parking for those working on the construction or development, temporary restrooms and construction offices.

Off-street parking area or vehicular use area shall mean all off-street areas and spaces designed, used, required or intended to be used for the parking, storage, maintenance, service, repair, display or operation of motor vehicles, including driveways or accessways in and to such areas, but not including:

(A) any outdoor storage area used principally as *recreational vehicle, boat or truck storage* use;

- (B) any parking area that is primarily used for long-term storage of vehicles that more closely resembles an outdoor storage area than it does a parking lot (such as impound lots, junkyards or other similar uses);
- (C) any internal drive lane located in an enclosed mini-storage facility; or
- (D) any public street or right-of-way.

Oil and gas facility shall mean equipment or improvements used or installed at an oil and gas location for the exploration, production, withdrawal, treatment, or processing of crude oil, condensate, exploration, development, and production waste, or gas.

Oil and gas location shall mean the area where an operator has disturbed or intends to disturb the land surface in order to locate an oil and gas facility.

Oil and gas pipeline shall mean a flowline, crude oil transfer line, gathering line, as such terms are defined by the ECOM, and transmission lines.

Oil and gas operation shall mean exploration for oil and gas, including the conduct of seismic operations and the drilling of test bores; the siting, drilling, deepening, recompletion, reworking or abandonment of an oil and gas well, underground injection well or gas storage well; production operations related to any such well, including the installation of flow lines and gathering systems; the generation, transportation, storage, treatment or disposal of exploration and production wastes; and any construction, site preparation or reclamation activities associated with such operations.

Opacity shall mean the degree to which air contaminant emission obscures the view of an observer, expressed in percentage of the obstruction, or the degree (percent) to which the transmittance of light is reduced by an air contaminant emission.

Open-air farmers market shall mean an occasional or periodic market held in an open area or in a structure where groups of individual sellers offer for sale to the public such items as fresh produce, seasonal fruits, fresh flowers, arts and crafts items, and food and beverages (but not to include second-hand goods) dispensed from booths located on-site. *Operator* as used in Section 4.3.4(F) shall mean any person who exercises the right to operate and control an oil and gas facility or oil and gas pipeline.

Orient shall mean to bring in relation to, or adjust to, the surroundings, situation or environment; to place with the most important parts facing in certain directions; to set or arrange in a determinate position: *to orient a building*.

Outdoor amphitheaters (other than *community facilities*) shall mean permanent stage and seating facilities that are open or partially open to the outdoors, the principal use of which is the showing of motion pictures or the presentation of dramatic, musical or live performances, which facilities are accessible to persons only by permission given at the doors or gates.

Outdoor café shall mean that portion of a restaurant with tables located on the sidewalk or other open area in front of or adjoining the restaurant premises.

Outdoor recreation facility shall mean an area devoted to active sports or recreation such as go-cart tracks, miniature golf, archery ranges, sport stadiums or the like, and may or may not feature stadium-type seating.

Outdoor storage shall mean the keeping, in an unroofed area, of any equipment, goods, junk, material, merchandise or vehicles in the same place for more than twenty-four (24) hours.

Outdoor vendor shall mean any person, whether as owner, agent, consignee or employee, who sells or attempts to sell, or who offers to the public free of charge, any services, goods, wares or merchandise, including, but not limited to, food or beverage, from any outdoor location, except for those activities excluded from the definition of *outdoor vendor* in §15-381 of the City Code.

Over the air reception device or *OTARD* shall mean:

- (A) An antenna that is designed to receive direct broadcast satellite service, including direct-to-home satellite services, that is one (1) meter or less in diameter; or
- (B) An antenna that is designed to receive video programming services via multipoint distribution services, including multichannel multipoint distribution services, instruction television fixed services, and local multipoint distribution services, and that is one (1) meter or less in diameter or diagonal measurement; or
- (C) An antenna that is designed to receive television broadcast signals.

Owner shall mean any person (as defined in Code of the City of Fort Collins Section 1-2) whose name appears on the tax bill for the property or who, alone or jointly or severally with others, has legal title to any dwelling or dwelling unit, with or without actual possession thereof, or has charge, care or control of any dwelling or dwelling unit as owner, executor, executrix, administrator, trustee, guardian of the estate of the owner, mortgagee or assignee of rents. *Owner* shall not include any person who holds only a security interest or easement on the real property upon which the dwelling or dwelling unit is situated.

Parking garage shall mean an off-street parking area within a building.

Parking lot shall mean off-street parking area or vehicular use area.

Parking structure shall mean any building containing motor vehicle parking that is a principal use, with or without any additional uses.

Parks, recreation and open lands shall mean natural areas as described in the Natural Areas Policy Plan, parks and recreation facilities as described in the Parks and Recreation Policy Plan whether such facilities are owned or operated by the City or by another not-for-profit organization, environmental interpretation facilities, outdoor environmental research or education facilities, or public outdoor places.

Party-in-interest shall mean a person who or organization that has standing to appeal the final decision of the decision maker. Such standing to appeal shall be limited to the following:

- (A) The applicant;
- (B) Any party holding a proprietary or possessory interest in the real or personal property which was the subject of the decision of the decision maker whose action is to be appealed;
- (C) Any person to whom or organization to which the City mailed notice of the hearing of the decision maker;
- (D) Any person who or organization which sent written comments to the decision maker prior to the action which is to be appealed;
- (E) Any person who appeared before the board or commission at the hearing on the action that is to be appealed;
- (F) The City Council as represented by the request of a single member of the City Council.

Passive open space shall mean land area devoted exclusively to activities such as walking, nature walks, wildlife observation, sitting, picnicking, card games, chess, checkers and similar table games, which space may be used in conjunction with buffer yards.

Pedestrian frontage shall mean an area abutting a connecting walkway, developed to provide continuous safety, interest and comfort for people walking or sitting; pedestrian frontage shall consist of building faces, site design features and/or landscape areas on one (1) or both sides, and not parking stalls on both sides.

Pedestrian-oriented development shall mean development that is designed with a primary emphasis on the street sidewalk and/or connecting walkway access to the site and building, rather than on auto access and parking lots. In *pedestrian-oriented developments*, buildings are typically placed relatively close to the street and the main entrance is oriented to the street sidewalk or a walkway. Although parking areas and garages may be provided, they are not given primary emphasis in the design of the site.

Pedestrian scale (human scale) shall mean the proportional relationship between the dimensions of a building or building element, street, outdoor space or streetscape element and the average dimensions of the human body, taking into account the perceptions and walking speed of a typical pedestrian.

Pennant shall mean a narrowing or tapering flag or similar shape that is two (2) square feet in size or less, that is repeated along a common line and is not attached to a flag pole.

Personal and business service shops shall mean shops primarily engaged in providing services generally involving the care of the person or such person's apparel or rendering services to business establishments such as laundry or dry-cleaning retail outlets, portrait/photographic studios, beauty or barber shops, employment service, or mailing or copy shops.

Place shall mean a minor way used primarily for vehicular access to the abutting properties, provided that no *place* shall have a greater length than three hundred fifty (350) feet, and provided further that no *place* shall provide access to more than fifteen (15) lots, and provided further that no discontinuous *place* (cul-de-sac) shall provide access to more than fifteen (15) dwelling units.

Place of worship or assembly shall mean a building containing a hall, auditorium or other suitable room or rooms used for the purpose of conducting religious or other services or meetings of the occupants of such structure. *Places of worship or assembly* shall include churches, synagogues or the like, but shall not include buildings used for commercial endeavors, including, but not limited to, commercial motion picture houses or stage productions.

Planned Unit Development (PUD) Overlay shall mean an area of land approved for development pursuant to a PUD Comprehensive Plan under Division 2.6.3. An approved PUD Overlay overlays the PUD Comprehensive Plan entitlements and restrictions upon the underlying zone district requirements.

Planned Unit Development (PUD) Comprehensive Plan shall mean an approved plan for development of an area within an approved PUD Overlay, which identifies the general intent of the development and establishes vested uses, densities and certain modification of development standards. An approved PUD Comprehensive Plan substitutes for the requirement for an Overall Development Plan. A PUD Comprehensive Plan is considered a site specific development plan solely with respect to vested property rights regarding specific uses, densities, Land Use Code development standards, and variances from Engineering Design Standards granted pursuant to Division 2.6.3(K).

Planning and Zoning Commission review shall mean review by the Planning and Zoning Commission in accordance with the provisions in Article 6. Also known as Type 2 review.

Plant nursery and greenhouse shall mean any land or structure used primarily to raise trees, shrubs, flowers or other plants for sale or for transplanting and may include the sale of nonliving landscape and decorating products.

Plat shall mean:

- (A) a map of a subdivision;

(B) a map of a parcel or parcels contained within an annexation;

(C) a map representing a tract of land showing the boundaries and location of individual properties and streets.

Plugging and abandonment shall mean the cementing of a well, the removal of its associated production facilities, the abandonment of its flowline(s), and the remediation and reclamation of the wellsite.

Pole cover shall mean a durable, permanent decorative cover that encloses the structural supports of a detached sign. The phrase "pole cover" does not include paints, stains, powder coating, or other finishes that are applied directly to the structural supports.

Primary residence shall mean the dwelling unit in which a person resides for nine (9) or more months of the calendar year. Under this definition, a person has only one (1) primary residence at a time.

Principal building entrance, for purposes Division 5.16 only, shall mean a street-level primary point of public pedestrian access into a building. The phrase "principal building entrance" does not include doors used principally as emergency exits, or doors that provide restricted access (e.g., for employees or deliveries).

Print shop shall mean an establishment in which the principal business consists of duplicating and printing services using photocopy, blueprint or offset printing equipment, and may include the collating of booklets and reports.

Private drive shall mean a parcel of land not dedicated as a public street, over which a private easement for road purposes has been granted to the owners of property adjacent thereto, which intersects or connects with a public or private street, and where the instrument creating such easement has been recorded in the Office of the Clerk and Recorder of Larimer County. A *street-like private drive* is a type of private drive that may be used instead of a street under the provisions of Section 5.4.6(M).

Private driveway shall mean the area of a platted lot that is specifically designed for the parking and movement of the vehicles of the property owner and that generally leads directly to a garage, carport or other such structure. Such area shall not include the area of a private street or private drive, except that a private driveway may be shared between two (2) abutting platted lots.

Private street shall mean a parcel of land not dedicated as a public street, over which a public access easement for street purposes has been granted to the City, and where the instrument creating such easement has been recorded or filed in the Office of the Clerk and Recorder of Larimer County. The public access easement shall allow for access by police, emergency vehicles, trash collection and other service vehicles, utility owners and the public in general.

Professional office shall mean an office for professionals such as physicians, dentists, lawyers, architects, engineers, artists, musicians, designers, teachers, accountants or others who through training are qualified to perform services of a professional nature and where no storage or sale of merchandise exists.

Property, for the purposes of Division 5.16 only, shall mean the real property owned or controlled by the applicant for a sign permit or alternative sign program. Property may be a single lot or parcel, or may be a combination of abutting lots or parcels that will be bound by the approval.

Property frontage, for purposes of Division 5.16 only, shall mean the length of a front, side, or rear property line that abuts a public street right-of-way.

Property manager shall mean any person, group of persons, company, firm or corporation charged with the care and control of rental housing as defined in Section 5-236 of the City Code who performs services with respect to such rental housing under a contract with the owner thereof or who otherwise acts as representative of an owner with respect to such rental housing.

Public highway shall have the meaning set forth in § 38-5.5-102, Colorado Revised Statutes.

Public use shall mean any use intended to be conducted in a facility or upon land that is owned by and operated for public use by school districts or by city, county, state or federal governments.

Public utility shall mean a common carrier supplying electricity, wire telephone service, natural gas, water, wastewater or stormwater service, railroads or similar public services, but shall not include mass transit or railroad depots or terminals or any similar traffic-generating activity, or any person or entity that provides communication services to the public.

Qualified Preservation Partner (QPP) shall mean an organization that has applied to, and been selected by, the City for inclusion on the list of entities that will qualify as an eligible buyer for affordable home ownership projects as defined under *affordable housing unit for purchase*. To be a QPP the organization shall agree that the homes purchased will be affordable for a time period prescribed by the City upon purchase as an Eligible Buyer and that it will promptly convey the property to a natural person who qualifies as an Eligible Buyer pursuant to the terms of the restricted home ownership program.

Rare, threatened or endangered species shall mean those species of wildlife and plants listed by the Colorado Parks and Wildlife Division, the Colorado Natural Heritage Program, or the U.S. Fish and Wildlife Service as rare, threatened or endangered.

Reclamation shall mean the process of returning or restoring the surface of disturbed land to its condition prior to development.

Recreational space shall mean privately owned space that is designed for active recreational use for more than three (3) families and that meets either of the following criteria:

- (A) Active open space. A parcel of not less than ten thousand (10,000) square feet and not less than fifty (50) linear feet in its smallest dimension, where no public dedication has contributed to its area. Such open space areas may include areas devoted to flood control channels or areas encumbered by flowage, floodway or drainage easements.
- (B) Active indoor space. Recreational facilities or structures, and their accessory uses, that are located in city approved areas, including, but not limited to, game rooms, swimming pools, gymnasiums, bowling alleys, exercise rooms or tennis or racquetball courts; provided, however, that the residents of the projects for which such facilities are planned must automatically be members of such facilities without additional charge.

Recreational vehicle, boat and truck storage shall mean the renting of space in an unroofed area for the purpose of storing any recreational vehicle, boat or truck. For the purposes of this definition, a *recreational vehicle* shall be a transportable structure that is primarily designed as a temporary living accommodation for recreational, camping and travel use, including, but not limited to, travel trailers, truck campers, camping trailers and self-propelled motor homes.

Recyclable material shall mean reusable material, including, but not limited to, metals, glass, plastic and paper, that are intended for reuse or reconstitution for the purpose of using the altered form. *Recyclable material* shall not include refuse or hazardous materials.

Recycling facility shall mean a building or land used for the collection and/or processing of recyclable material. *Processing* shall mean the preparation of material for efficient shipment by such means as baling, compacting, flattening, grinding, crushing, mechanical sorting or cleaning. Such a facility, if entirely enclosed within a building or buildings, shall be considered a warehouse.

Redevelopment shall mean the intensification of use of existing buildings and/or development sites, building rehabilitation, or removal or demolition of existing buildings, followed promptly by construction of replacement buildings.

Regional shopping center shall mean a cluster of retail and service establishments designed to serve consumer demands from the community as a whole or a larger area. The primary functional offering is at least one (1) full-line department store. The center also includes associated support shops that provide a variety of shopping goods including general merchandise, apparel and home furnishings, as well as a variety of services, and perhaps entertainment and recreational facilities.

Research laboratory shall mean a building or group of buildings in which are located facilities for scientific research, investigation, testing or experimentation, but not facilities for the manufacture or sale of products except as incidental to the main purpose of the laboratory.

Resource extraction, processes and sales shall mean removal or recovery by any means whatsoever of sand, gravel, soil, rock, minerals, mineral substances or organic substances other than vegetation, from water or land on or beneath the surface thereof, exposed or submerged, but does not include oil and gas operations.

Resource recovery shall mean the process of obtaining materials or energy, particularly from solid waste.

Restaurant, drive-in (also known as *Restaurant, drive-thru*) shall mean any establishment in which the principal business is the sale of foods and beverages to the customer in a ready-to-consume state and in which the design or principal method of operation of all or any portion of the business is to allow food or beverages to be served directly to the customer in a motor vehicle without the need for the customer to exit the motor vehicle.

Restaurant, drive-thru: See *Restaurant, drive-in*.

Restaurant, fast food shall mean any establishment in which the principal business is the sale of food and beverages to the customer in a ready-to-consume state, and in which the design or principal method of operation includes all of the following characteristics:

- (A) food and beverages are usually served in edible containers or in paper, plastic or other disposable containers; and
- (B) there is no drive-in facility as a part of the establishment.

Restaurant, limited mixed-use shall mean any establishment in which the principal business is the sale of food and beverages to the customer in a ready-to-consume state, and in which the design or principal method of operation includes all of the following characteristics:

- (A) food and beverages are usually served in edible containers or in paper, plastic or other disposable containers;
- (B) there is no drive-in or drive-through facility as a part of the establishment;
- (C) the establishment is contained within or physically abuts a multi-unit dwelling;
- (D) the establishment is clearly subordinate and accessory to a multi-unit dwelling;
- (E) the establishment shall not exceed one thousand five hundred (1,500) feet in gross leasable floor area;
- (F) the establishment shall not engage in serving alcohol; and

(G) the establishment shall not engage in the playing of amplified music.

Restaurant, standard shall mean any establishment in which the principal business is the sale of food and beverages to customers in a ready-to-consume state; where fermented malt beverages, and/or malt, special malt or vinous and spirituous liquors may be produced on the premises as an accessory use; and where the design or principal method of operation includes one (1) or both of the following characteristics:

(A) customers are served their food and/or beverages by a restaurant employee at the same table or counter at which the items are consumed; or

(B) customers are served their food and/or beverages by means of a cafeteria-type operation where the food or beverages are consumed within the restaurant building.

Retail establishment (also known as retail store) shall mean an establishment of twenty-five thousand (25,000) square feet or less of gross leasable floor area in which sixty (60) percent or more of the gross floor area is devoted to the sale or rental of goods, including stocking, to the general public for personal or household consumption or to services incidental to the sale or rental of such goods.

Retail marijuana cultivation facility shall mean an entity licensed to cultivate, prepare and package marijuana, and to sell marijuana to retail marijuana stores, to marijuana product manufacturing facilities and to other marijuana cultivation facilities, but not to consumers.

Retail marijuana product manufacturing facility shall mean an entity licensed to purchase marijuana; manufacture, prepare and package marijuana products; and sell marijuana and marijuana products to other marijuana product manufacturing facilities and to retail marijuana stores, but not to consumers.

Retail marijuana store shall mean an entity licensed to purchase marijuana from marijuana cultivation facilities and marijuana and marijuana products from marijuana product manufacturing facilities and to sell marijuana and marijuana products to consumers.

Retail marijuana testing facility shall mean an entity licensed to analyze and certify the safety and potency of marijuana as defined in Section 16(2)(1) of Article XVIII of the Colorado State Constitution.

Retail stores with vehicle servicing shall mean an establishment in which vehicle parts are sold and are ordinarily installed on the premises, and where the majority of the floor area of the establishment is devoted to the installation and maintenance of such parts (e.g., tire shops and muffler shops).

Revegetation shall mean restoration and mitigation measures for a disturbed natural area or buffer zone in accordance with the requirements of LUC subsections 5.6.1(D)(2) and 5.10.1(F).

Reverse vending machine shall mean an automated mechanical device that accepts one (1) or more types of empty beverage containers, including, but not limited to, aluminum cans, glass or plastic bottles; and that issues a cash refund or a redeemable credit. A *reverse vending machine* may be designed to accept more than one (1) container at a time, paying by weight instead of by container.

Rider shall mean a subordinate sign panel that is attached to a swing sign, either above the horizontal member or below the principal sign face. To illustrate, but without limiting the range of messages that a rider may convey, if the swing sign is used to advertise a property as "for sale," a rider is often used to convey a related message such as "contract pending."

Ridgeline protection area shall mean the area described and established pursuant to Section 5.6.1(G).

Rights-of-way shall mean any portion of a public highway dedicated to the City. Rights-of-way shall not include (i) trails and (ii) specific-purpose utility easements, when the specific purpose of the utility easement dedication does not include communication facilities or public access.

River shall mean the Cache la Poudre River unless the context indicates a general meaning.

School facility shall mean any discrete facility or area, whether indoor or outdoor, associated with a public or private school, that students use commonly as part of their curriculum or extracurricular activities. A school facility is either adjacent to or owned by the school or school governing body, and the school or school governing body has the legal right to use the school facility at its discretion. The definition includes future school facility as defined by the ECMC.

Screen shall mean an opaque structure, typically located on top of, but integrated with the design of, a building that conceals mechanical, communications or other equipment from view from the surrounding rights-of-ways and properties.

Seasonal overflow shelters shall mean a homeless shelter that allows homeless persons to stay on its premises overnight from the beginning of November through the end of April, unless, because of inclement weather, specific and limited exceptions to such seasonal limitations are granted by the Director. Community based shelter services are exempt from this definition.

Semipublic use shall mean uses operated by recognized religious, philanthropic, educational or other charitable institutions on a nonprofit basis and in which goods, merchandise and services are not provided for sale on the premises.

Sensitive or specially valued species shall mean species included on the City of Fort Collins Species of Interest List, as developed and updated by the Natural Areas Department.

Services shall mean the programs and employees determined necessary by the city to provide for the adequate operation and maintenance of its public facilities and infrastructure, including, but not limited to, those educational, healthcare, social and other programs necessary to support the programs, public facilities and infrastructure required by this Land Use Code, the City Code, the policies and administrative manuals promulgated pursuant thereto, or state or federal law.

Shared parking shall mean required parking that is provided both on-site and in a municipal parking lot or a private lot constructed and located in accordance with the requirements of the city, where the same parking spaces are assigned to more than one (1) use at one (1) time.

Shelters for victims of domestic violence shall mean a residential facility operating twenty-four (24) hours per day and seven (7) days per week, the purpose of which facility is to receive, house, counsel and otherwise serve victims of domestic violence, as that term is defined in Section 18-6-800.3, C.R.S. and their dependents. Such facility may also include day care, professional, administrative and security staff.

Short term non-primary rental shall mean a dwelling unit that is not a primary residence and that is leased in its entirety to one (1) party at a time for periods of less than thirty (30) consecutive days. The term party as used in this definition shall mean one (1) or more persons who as a single group rent a short term non-primary rental pursuant to a single reservation and payment. The term short term non-primary rental shall not include the rental of a dwelling unit to the former owner immediately following the transfer of ownership of such dwelling unit and prior to the former owner vacating the dwelling unit. Short term non-primary rental is a distinct use from short term primary rental under the Land Use Code.

Short-term parking shall mean customer parking that has regular turnover. Parking that is intended to serve a retail business and provide access to commercial activity is short-term parking.

Short term primary rental shall mean a dwelling unit that is a primary residence of which a portion is leased to one (1) party at a time for periods of less than thirty (30) consecutive days. The term party as used in this definition shall mean one (1) or more persons who as a single group rent a short term primary rental pursuant to a single reservation and payment. An accessory dwelling unit that is not a primary residence is eligible to be

a short term primary rental if it is located on a lot containing a primary residence. A dwelling unit of a two-unit dwelling that is not a primary residence is eligible to be a short term primary rental if the connected dwelling unit is a primary residence and both dwelling units are located on the same lot. The term short term primary rental shall not include the rental of a dwelling unit to the former owner immediately following the transfer of ownership of such dwelling unit and prior to the former owner vacating the dwelling unit. Short term primary rental is a distinct use from short term non-primary rental under the Land Use Code.

Side alley, for purposes of Section 5.8.1 only, shall mean a minor way used primarily for vehicular or pedestrian access to the side, rather than the rear, of a historic resource. On a corner where a historic resource and a development site are divided by a single alley that serves as a side alley for the historic resource and a rear alley for the development site, the alley shall be considered a side alley.

Sign shall mean any writing (including letter, word or number), pictorial representation (including illustration or declaration), product, form (including shapes resembling any human, animal or product form), emblem (including any device, symbol, trademark, object or design that conveys a recognizable meaning, identity or distinction) or any other figure of similar character that is a structure or any part thereof or is written, painted, projected upon, printed, designed into, constructed or otherwise placed on or near a building, board, plate or upon any material object or device whatsoever, that by reason of its form, location, manner of display, color, working, stereotyped design or otherwise attracts or is designed to attract attention to the subject or to the premises upon which it is situated, or is used as a means of identification, advertisement or announcement. The term *sign* shall not include the following:

- (A) Window displaying merchandise or products;
- (B) Works of art that do not include commercial speech, such as branding;
- (C) Products, merchandise or other materials that are offered for sale or used in conducting a business, when such products, merchandise, or materials are kept or stored in a location that is designed and commonly used for the storage of such products, merchandise or materials; and
- (D) Any display that would otherwise be considered a sign, but that has been found by the Landmark Preservation Commission to be an integral part of a building that is designated as an historic landmark, and the display is a contributing feature of the historic character of such building. Sign face means the surface area of a sign that is designed for placement of text, symbols, or images. The sign face does not include the supporting structure, if any, unless the supporting structure is used for the display of text, symbols, or images. For wall signs, the sign face is equal to the sign area of the wall sign, or the area within any frame or color used to define, differentiate, or mount the wall sign, whichever is larger.

Sign, abandoned shall mean a sign that does not contain a message, or contains a commercial or event-based message that is obviously obsolete (e.g., the name of a business that is no longer operational, or an advertisement for an event that has already occurred), for a continuous period of sixty (60) days or more.

Sign, applied or painted shall mean a type of wall sign that is applied to or painted on a building wall, such that the sign appears flush with, or within not more than one (1) inch of, the surface of the wall.

Sign, attached shall mean a flush wall sign, a window sign, a roof sign, or a projecting sign.

Sign, awning shall mean a sign that is painted on, integrated into, or attached to an awning. For the purposes of this definition, an awning is a projection from the building that is supported entirely from the exterior wall of the building, and that gives shelter from the sun or weather over doors, windows, or storefronts. An awning is different from a canopy in that an awning is covered with fabric or other flexible material.

Sign, cabinet shall mean a type of sign composed of a frame or external structure with a box-like design that encloses a sign face and other functional elements of the sign, including dimensional or electrical components.

Sign, canopy shall mean a type of sign with one face affixed to a canopy. For the purposes of this definition, a canopy is an attached or detached structure, open on at least one side, that is designed to provide overhead shelter from the sun or weather. Canopies include, but are not limited to, service station canopies, carports, porte-cochères, arcades, and pergolas. A canopy is different from an awning in that a canopy is not covered with fabric or flexible material.

Sign, detached shall mean a sign that is not attached to or located inside of a building.

Sign, dimensional wall shall mean a three-dimensional sign that is attached to building wall, such that the elements of the sign do not extend more than eight (8) inches from the building wall. Dimensional wall signs include but are not limited to channel lettering.

Illustrative Dimensional Wall Sign



Sign face shall mean the surface area of a sign that is designed for placement of text, symbols, or images. The sign face does not include the supporting structure, if any, unless the supporting structure is used for the display of text, symbols, or images. For wall signs, the sign face is equal to the sign area of the wall sign, or the area within any frame or color used to define, differentiate, or mount the wall sign, whichever is larger.

Illustrative Sign Face

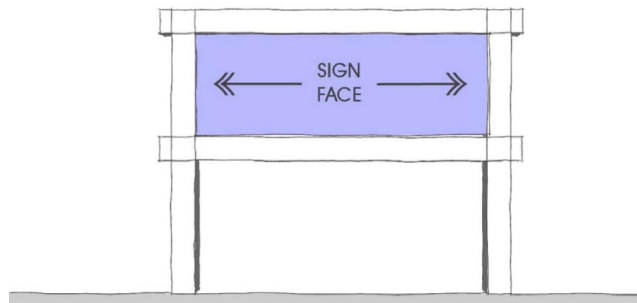

Sign, fin shall mean a projecting sign that is mounted on or affixed to a building wall, such that the sign face is generally perpendicular to the building wall. In addition to the wall mount or mounts, a fin sign may include ground-mounted support structures.

Illustrative Fin Signs



Sign, flush wall shall mean any sign attached to, painted on or erected against the wall of a building in such a manner that the sign face is parallel to the plane of the wall and is wholly supported by the wall. Framed banners attached directly to the building fascia are considered to be a type of flush wall sign. Unframed banners attached directly to the building fascia are not considered to be flush wall signs and shall be subject to the banner regulations contained in Section 5.16.2.

Sign, freestanding shall mean a detached sign that is supported by one (1) or more columns, uprights, poles or braces extended from the ground or from an object on the ground, or a detached sign that is erected on the ground, provided that no part of the sign is attached to any part of any building, structure or other sign.

Sign, ground shall mean a type of freestanding sign that is erected on the ground and that contains no more than twenty (20) percent total free air space. Free air space shall mean any open area between the top of the sign and the ground, vertically, and between the extreme horizontal limits of the sign extended perpendicular to the ground.

Sign, hanging shall mean a sign that is mounted under an awning or canopy as such terms are defined above, or under a cantilevered portion of a building. Generally, hanging signs are oriented perpendicular to the building wall.

Sign, illegal shall mean any sign that was erected in violation of the City Code at the time of its erection and has never been in conformance with the City Code, including this Land Use Code and that shall include signs that are posted, nailed or otherwise fastened or attached to or painted upon structures, utility poles, trees, fences or other signs.

Sign, individual letter shall mean a type of flush wall sign consisting of individual letters, incised letters, script or symbols with no background material other than the wall of the building to which the letters, script or symbols are affixed.

Sign, inflatable shall mean a sign that is constructed from an envelope flexible material that is given shape and/or movement by inflation. The phrase inflatable sign does not include balloons that are less than eighteen (18) inches in all dimensions.

Sign, interactive window shall mean one (1) or more illuminated screens that are displayed inside storefront windows that can be programmed to allow customers to navigate content interactively from outside the window.

Sign, legal nonconforming shall mean any sign that was lawful and nonconforming under prior law on the day before the effective date of this Land Use Code or subsequent amendment thereof.

Sign, marquee shall mean a projecting sign that is designed as a canopy structure, which includes a combination of permanent lettering or graphics and either manual changeable copy or electronic message center components.

Sign, off-premise shall mean a sign or billboard that is used or intended for use to advertise, identify, direct or attract the attention of the public to a business, institution, product, organization, event or location offered or existing elsewhere than upon the same lot, tract or parcel of land where such sign or billboard is displayed.

Sign, optional residential shall mean a wall sign, affixed to a residential building on a street-facing elevation, with a single sign face that does not exceed four (4) square feet in area.

Sign, permanent shall mean a durable sign that is mounted or affixed for long-term use, not easily removed, and resistant to weather and other wear and tear.

Sign, portable shall mean a sign that is designed to be easily moved from one location to another, and when placed, is neither fastened to a permanent structure or building, nor staked or otherwise installed into the ground.

Illustrative Portable Sign



Sign, primary detached shall mean a detached sign that is visually dominant over other detached signs on the same property, due to its taller height and/or larger sign area.

Sign, primary fin shall mean a fin sign that is visually dominant over other fin signs on the same building, due to its taller height and/or larger sign area.

Sign, projected light shall mean any image, text, or other content that is projected onto an outdoor surface (e.g., a building wall or sidewalk) by a laser projector, video projector, video mapping, or other comparable technology, in a location such that the image, text, or content is obviously visible from outside of the premises.

Sign, projecting shall mean a type of attached sign that extends from a building wall, usually perpendicular to the wall's surface. Projecting signs include awning signs, fin signs, marquee signs, and hanging signs.

Sign, projecting wall shall mean any sign other than a flush wall sign that projects from and is supported by a wall or a building.

Sign, required shall mean a sign that is required by an applicable building code (e.g., address numbers) or health and safety regulations (e.g., the Occupational Safety and Health Act ("OSHA") or other laws or regulations, whether such sign is temporary or permanent.

Sign, roof shall mean a type of attached sign that is mounted onto a building's roof structure.

Sign, rooftop shall mean a sign erected upon or above a roof or above a parapet wall of a building.

Sign, secondary detached shall mean a detached sign that is subordinate to a primary detached sign in terms of height and/or sign area.

Sign, secondary fin shall mean a fin sign that is subordinate to a primary fin sign in terms of height and/or sign area.

Sign, secondary roof shall mean a sign that is mounted upon the horizontal plane of a flat roof structure of secondary roof of a building, which may include the roof of a canopy or porte-cochère that is attached to a building.

Sign side shall mean the combination of all faces or modules of a freestanding or ground sign that can be viewed from a single direction, except when such sign faces or modules are separated by an angle of more than two hundred seventy (270) degrees.

Sign, sidewalk shall mean a type of portable sign that is designed to be placed upon a hard surface in order to attract the attention of pedestrians.



Sign, under-canopy shall mean a sign that is located beneath a permanent-roofed shelter covering a sidewalk, driveway or other similar area, which shelter may be wholly supported by a building or may be wholly or partially supported by columns, poles or braces extended from the ground.

Sign, site shall mean a type of temporary sign that is constructed of vinyl, plastic, wood, metal, or other comparable rigid material, that is displayed on a structure that includes at least two (2) posts.

Illustrative Site Sign

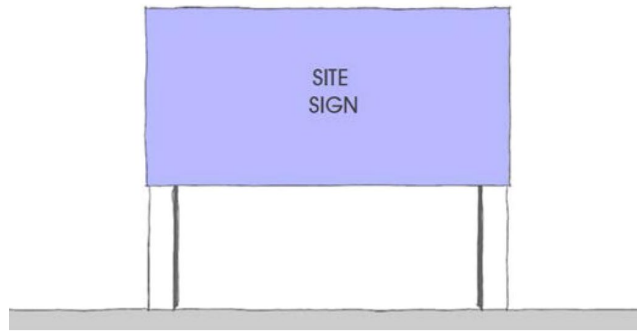

Sign, swing shall mean a type of temporary sign that is suspended from a horizontal swing post that is attached to a post that is staked into the ground. Swing signs may include riders that are mounted to the swing post or suspended under the sign panel.

Sign, temporary shall mean a sign that is designed or intended to be displayed for a short period of time.

Sign, vehicle-mounted shall mean any sign that is painted on, affixed to or otherwise mounted on any vehicle or on any object that is placed on, in or attached to a vehicle. For the purposes of this definition, the term vehicle shall include trucks, buses, vans, railroad cars, automobiles, tractors, trailers, motor homes, semi-tractors or any other motorized or nonmotorized transportational device, whether or not such vehicle is in operating condition.

Sign, wall shall mean a sign that is painted on, applied to, or affixed to a building wall. Wall signs include applied or painted signs, bulletin boards, cabinet signs, and dimensional wall signs.

Sign, wind-driven shall mean any sign consisting of one (1) or more banners, flags, pennants, ribbons, spinners, streamers, captive balloons, inflatable signs, or other objects or material fastened in such a manner as to move, upon being subjected to pressure by wind or breeze.

Sign, window shall mean a sign that is painted on, applied or attached to a window or door, or located within three (3) feet of the interior of the window or door and is visible from the exterior of the building.

Sign with backing shall mean any sign that is displayed upon, against or through any material or color surface or backing that forms an integral part of such display and differentiates the total display from the background against which it is placed.

Sign without backing shall mean any word, letter, emblem, insignia, figure or similar character or group thereof that is neither backed by, incorporated in nor otherwise made a part of any larger display area.

Sign, yard shall mean a type of temporary sign that is constructed of paper, vinyl, plastic, wood, metal or other comparable material, that is mounted on a stake or a frame structure (often made from wire) that includes one (1) or more stakes.

Illustrative Yard Signs

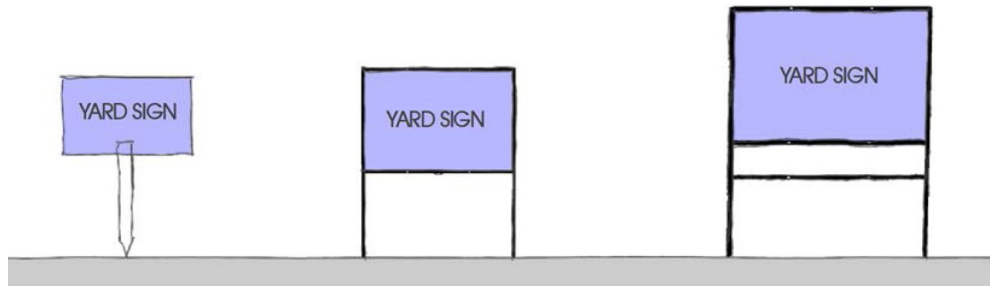

Site, for purposes of Section 5.8.1 only, shall mean the location of a significant event, a prehistoric or historic occupation or activity or a structure or object whether standing, ruined or vanished, where the location itself maintains historical or archeological value regardless of the value of any existing structure.

Site, for the purposes of Section 4.3.5(H) only, shall mean that area comprising the base of a City-owned structure on which is mounted wireless communication equipment subject to this Code and to other related transmission equipment already deployed on the ground surrounding such vertical structure; regarding private property structures, the site shall include the current boundaries of the leased or owned property and any access or utility easements currently related thereto.

Site specific development plan shall mean and be limited to a final plan as approved pursuant to this Land Use Code, including a plan approved pursuant to basic development review; or, under prior law in effect on the day before the effective date of this Land Use Code, any of the following: the final plan; the final subdivision plat; a minor subdivision plat; cluster development plans; group home review; a PUD Comprehensive Plan for the purpose of acquiring a vested property right with respect to uses, densities, development standards and engineering standards for which variances have been granted pursuant to Section 2.6.3(K); and a development agreement in connection with a PUD Comprehensive Plan that grants a vested property right for a period exceeding three (3) years. In addition, a site specific development plan shall mean a final plan or plat that was approved by Larimer County for property that, at the time of approval, was located in the county but has been subsequently annexed into the city. All references to districts or sections herein pertain to the law in effect on the day before the effective date of this Land Use Code and which is repealed by the adoption of this Land Use Code.

Small cell facility or SCF shall mean a WCF where each antenna is located inside an enclosure of no more than three (3) cubic feet in volume, or, in the case of an antenna that has exposed elements, the antenna and all of its exposed elements could fit within an imaginary enclosure of no more than three (3) cubic feet, and primary equipment enclosures are not larger than seventeen (17) cubic feet in volume. The following associated equipment may be located outside the primary equipment enclosure and, if so located, is not included in the calculation of equipment volume: electric meter, concealment, telecommunications demarcation box, ground-based enclosure, back-up power systems, grounding equipment, power transfer switch and cut-off switch. All associated equipment, even if located outside the primary equipment enclosure, shall be included within the definition of small cell facility.

Small scale reception center shall mean a place of assembly that may include a building or structure containing a hall, auditorium, a structure for housing such events (barns are the new rage) or ballroom used for celebrations or gatherings (such as weddings, graduations or anniversaries) for which the owner receives compensation for the use. The building or structure may also include meeting rooms and facilities for serving food. Outdoor spaces such as lawns, plazas, gazebos and/or terraces used for social gatherings or ceremonies are a common component of the center. A small scale reception center shall not include sporting events or concerts.

Solar energy system shall mean a system of solar collectors and other equipment that relies upon sunshine as an energy source and is capable of collecting, distributing and storing (if appropriate to the technology) the sun's radiant energy. A *solar energy system* includes, but is not limited to, ground-mounted and building-mounted photovoltaic, solar thermal or solar hot water panels, and light pole and electric charging station-mounted solar panels. Solar energy systems may be considered accessory uses to other uses on a lot, or principal uses if located on vacant lots.

Solar energy system, large-scale shall mean a solar energy system covering more than five (5) acres.

Solar energy system, medium-scale shall mean a solar energy system covering between one half (0.5) acre and five (5) acres.

Solar energy system, small-scale shall mean a solar energy system covering less than one-half (0.5) acre.

Solar-oriented lot shall mean:

- (A) A lot with a front lot line oriented to within thirty (30) degrees of a true east-west line. When the lot line abutting a street is curved, the "front lot line" shall mean the chord or straight line connecting the ends of the curve. For a flag lot, the "front lot line" shall mean the lot line that is most parallel to the closest street, excluding the "pole portion of the flag lot"; or
- (B) A lot that, when a straight line is drawn from a point midway between the side lot lines at the required front yard setback to a point midway between the side lot lines at the required rear yard setback, is oriented to within thirty (30) degrees of true north along said line; or
- (C) A corner lot with a south lot line oriented to within thirty (30) degrees of a true east-west line, which south lot line adjoins a public street or permanently reserved open space; provided, however, that the abutting street right-of-way or open space has a minimum north-south dimension of at least fifty (50) feet. For the purposes of this definition, "permanently reserved open space" shall include, without limitation, parks, cemeteries, golf courses and other similar outdoor recreation areas, drainage ditches and ponds, irrigation ditches and reservoirs, lakes, ponds, wetlands, open spaces reserved on plats for neighborhood use and other like and similar permanent open space.

Solid-to-void pattern shall mean the area of the façade covered by openings divided by the area of the solid wall, as a measure of the proportion of the area of fenestrations to that of the wall.

South College Gateway Area shall mean that area shown on the figure below:

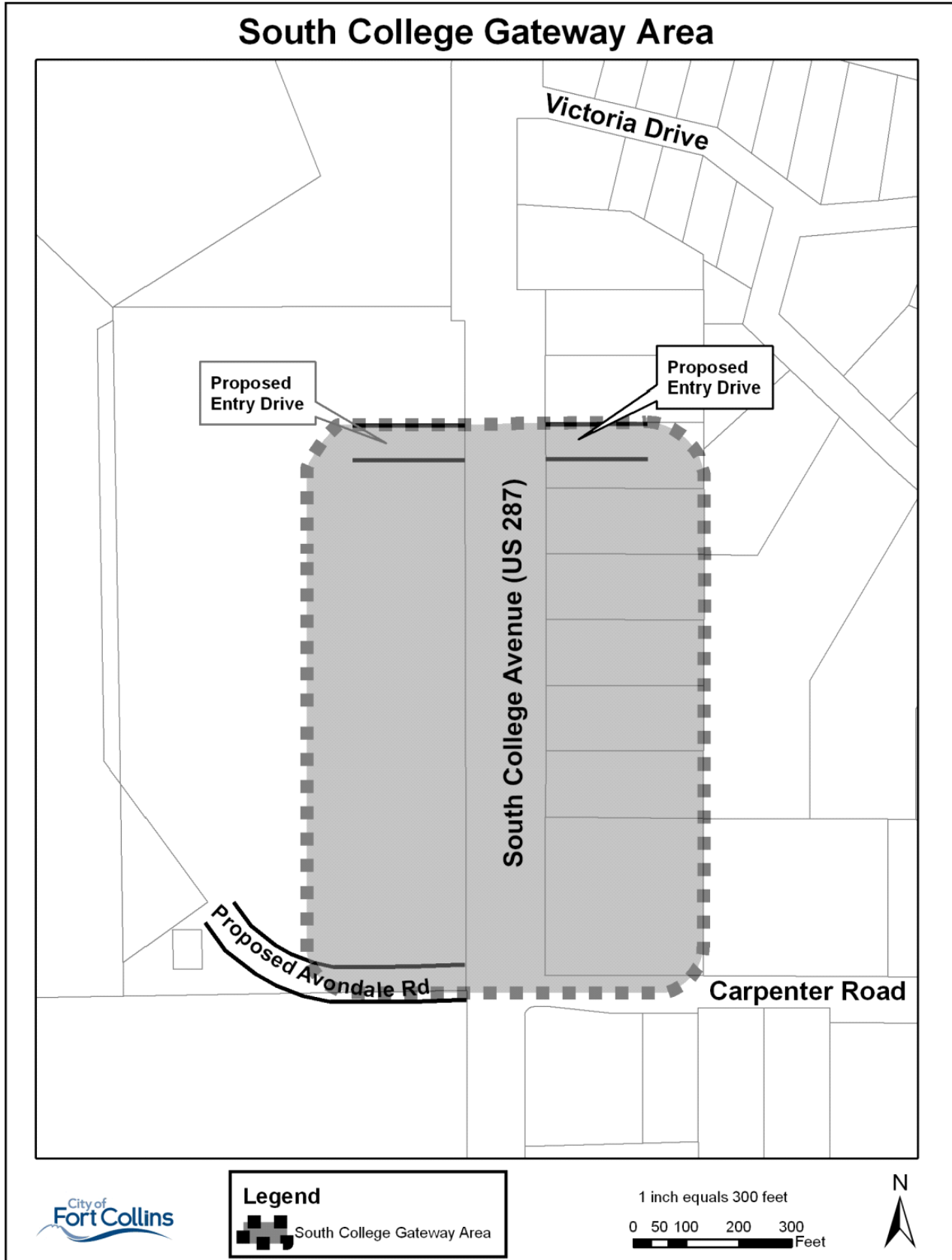

Special habitat features shall mean specially valued and sensitive habitat features including key raptor habitat features including nest sites, night roosts and key feeding areas as identified by the Colorado Parks and Wildlife Division ("CPW") or the Fort Collins Natural Areas Department ("NAD"); key production areas, wintering areas and migratory feeding areas for waterfowl; key use areas for wading birds and shorebirds; heron rookeries; key use areas for migrant songbirds; key nesting areas for grassland birds; fox and coyote dens; mule deer winter concentration areas as identified by the CPW or NAD; prairie dog colonies one (1) acre or greater in size; key areas for rare, migrant or resident butterflies as identified by the NAD; areas of high terrestrial or aquatic insect diversity as identified by the NAD; remnant native prairie habitat; mixed foothill shrubland; foothills ponderosa pine forest; plains cottonwood riparian woodlands; and wetlands of any size.

Specified anatomical areas shall mean less than completely and opaquely covered human genitals, pubic region, buttocks, female breast or breasts below a point immediately above the top of the areola or human male genitals in a discernibly turgid state, even if completely and opaquely covered.

Specified sexual activities shall mean:

- (A) Human genitals in a state of sexual stimulation or arousal;
- (B) Acts of human masturbation, sexual intercourse or sodomy;
- (C) Fondling or other erotic touching of human genitals, pubic region, buttocks or female breast or breasts.

Stationary vendor shall mean an outdoor vendor who is licensed under Article XIV, Chapter 15 of the City Code to engage in stationary vending.

Stationary vending shall mean one (1) or more outdoor vendors vending on the same private parcel of land or lot for more than three (3) consecutive calendar days, or for more than three (3) calendar days within any calendar week, defined for purposes of this definition as Sunday through Saturday, and when vending, do so from a mobile food truck, pushcart, or any other vehicle as such terms are defined in Section 15-381 of the City Code.

Stockpiling shall mean the act by which soil or similar inorganic material to be used in connection with anticipated development on such parcel of property is deposited on such property. The stockpiling of material is intended to be temporary in terms of the appearance, shape and grade of the material. Stockpiling shall not include activities such as the grading, leveling or compaction of the deposited material or the surrounding ground. *Stockpiling* shall also not include residential landscaping activities.

Storefront the front portion of building façade at street level that belongs to one occupant.

Stormwater criteria manual shall mean the standards for design, planning, and implementation of practices and improvements to manage stormwater adopted under Chapter 26 of the City Code.

Street shall mean a public way (whether publicly or privately owned) used or intended to be used for carrying vehicular, bicycle and pedestrian traffic and shall include the entire area within the public right-of-way and/or public access easement; provided, however, that with respect to the application of Division 5.16, the term *street* shall only mean a dedicated public right-of-way (other than an alley) used or intended to be used for carrying motorized vehicular traffic.

Street-facing building elevation shall mean Building Elevation that is oriented toward a public or private street that abuts the property.

Street sidewalk shall mean the sidewalk within the right-of-way of a public street designed to the standards specified in the *Larimer County Urban Area Street Standards* or the sidewalk within the public access easement of a private street designed in accordance with the standards specified in subsection 5.4.6(J) of this Code.

Structure shall mean a combination of materials to form a construction for use, occupancy or ornamentation whether installed on, above or below the surface of land or water.

Structures associated with an occupied roof shall mean improvements to the primary or lowest portion of a roof deck of a structure that may include, but not be limited to, accessory rooftop improvements such as pools, decks, raised planters, outdoor furniture, shade structures, snack bars, televisions, clubhouse or other clubhouse-like elements. *Structures associated with an occupied roof* is not a story as that term is used in this Land Use Code.

Subdivider or developer shall mean any person, partnership, joint venture, limited liability company, association or corporation who participates as owner, promoter, developer or sales agent in the planning, platting, development, promotion, sale or lease of a development.

Subdivision shall mean the platting of a lot or the division of a lot, tract or parcel of land into one (1) or more lots, plots or sites.

Substantial change, for the purposes of Section 4.3.5(H) only, shall mean a modification which, after the modification of an eligible support structure, the structure meets any of the following criteria:

- (A) For towers, it increases the height of the tower by more than ten percent (10%) or by the height of one additional antenna array with separation from the nearest existing antenna not to exceed twenty (20) feet, whichever is greater, as measured from the top of an existing antenna to the bottom of a proposed new antenna; for other eligible support structures, it increases the height of the structure by more than ten percent or more than ten (10) feet, whichever is greater, as measured from the top of an existing antenna to the bottom of a proposed new antenna;
- (B) For towers, it involves adding an appurtenance to the body of the tower that would protrude from the edge of the tower more than twenty (20) feet, or more than the width of the tower structure at the level of the appurtenance, whichever is greater; for eligible support structures, it involves adding an appurtenance to the body of the structure that would protrude from the edge of the structure by more than six (6) feet;
- (C) For any eligible support structure, it involves installation of more than the standard number of new equipment cabinets for the technology involved, as determined on a case-by-case basis based on the location of the eligible support structure but not to exceed four cabinets per application; or for base stations, it involves installation of any new equipment cabinets on the ground if there are no pre-existing ground cabinets associated with the structure, or else involves installation of ground cabinets that are more than ten percent (10%) larger in height or overall volume than any other ground cabinets associated with the structure;
- (D) It entails any excavation or deployment outside of the current site, except that, for towers other than towers in the public rights-of-way, it entails any excavation or deployment of transmission equipment outside of the current site by more than thirty (30) feet in any direction. The site boundary from which the 30 feet is measured excludes any access or utility easements currently related to the site.
- (E) For any eligible support structure, it would defeat the concealment elements of the eligible support structure by causing a reasonable person to view the structure's intended stealth design as no longer effective; or
- (F) For any eligible support structure, it does not comply with record evidence of conditions associated with the siting approval of the construction or modification of the eligible support structure or base

station equipment, unless the non-compliance is due to an increase in height, increase in width, addition of cabinets, or new excavation that would not exceed the thresholds identified in paragraphs (1)-(4) of this definition.

For purposes of determining whether a substantial change exists, changes in height are measured from the original support structure in cases where deployments are or will be separated horizontally, such as on building rooftops; in other circumstances, changes in height are measured from the dimensions of the tower or base station, inclusive of approved appurtenances and any modifications that were approved prior to February 22, 2012.

Supermarket shall mean a retail establishment primarily selling food, as well as other convenience and household goods, that occupies a space of not less than forty-five thousand one (45,001) square feet.

Temporary seasonal decorations shall mean decorations and signs that are clearly incidental, customary, and commonly associated with a holiday.

Temporary sign cover shall mean a type of temporary sign that is constructed of flexible material, designed to fit over a permanent sign face or mount.

Top of bank shall mean the topographical break in slope between the bank and the surrounding terrain. When a break in slope cannot be found, the outer limits of riparian vegetation shall demark the top of bank.

Tower shall mean any structure built for the sole or primary purpose of supporting any FCC-licensed or authorized antennas and their associated facilities, including structures that are constructed for wireless communications services including private, broadcast, and public safety services, unlicensed wireless services, fixed wireless services such as microwave backhaul, and the associated site. The term includes radio and television transmission towers, self-supporting lattice towers, guy towers, monopoles, microwave towers, common carrier towers, cellular telephone towers and other similar structures, though not including utility or light poles that are less than thirty-five (35) feet in height.

Transportation Demand Management shall mean a comprehensive program utilizing strategies to be implemented that result in more efficient use of transportation and parking resources. These strategies typically include, but are not limited to, transit subsidies, enhanced bicycle facilities, car/vanpool options, and shared parking.

Tree shall mean:

- (A) any self-supporting woody plant growing upon the earth that usually provides one (1) main trunk and produces a more or less distinct and elevated head with many branches; or
- (B) any self-supporting woody plant, usually having a single woody trunk and a potential DBH of two (2) inches or more.

Tree significant shall mean any tree with a DBH of six (6) inches or more.

Truck stop shall mean an establishment engaged primarily in the fueling, servicing, repair or parking of tractor trucks or similar heavy commercial vehicles, including the sale of accessories and equipment for such vehicles. A truck stop may also include overnight accommodations, showers or restaurant facilities primarily for the use of truck crews.

Truck terminal shall mean an area or building where cargo or containers are stored and where trucks load and unload cargo or containers on a regular basis. The terminal cannot be used for permanent or long-term accessory storage for principal land uses at other locations. The terminal facility may include storage areas for trucks or buildings or areas for the repair of trucks associated with the terminal.

Type 1 review shall mean review by the Director in accordance with the provisions of Article 6. Also known as administrative review.

Type 2 review shall mean review by the Planning and Zoning Commission in accordance with the provisions of Article 6.

Unlimited indoor recreational use and facility shall mean establishments primarily engaged in operations and activities contained within large-scale gymnasium-type facilities such as for tennis, basketball, swimming, indoor soccer, indoor hockey or bowling.

Urban agriculture shall mean gardening or farming involving any kind of lawful plant, whether for personal consumption, sale and/or donation, except that the term *urban agriculture* does not include the cultivation, storage and sale of crops, vegetables, plants and flowers produced on the premises in accordance with Section 4.4.5(A) of this Code. Urban agriculture is a miscellaneous use that does not include plant nursery and greenhouse as a principal use and that is subject to licensing in accordance with Section 4.4.5(D) of this Code.

Vegetation shall mean trees, shrubs or vines.

Vehicle shall mean a truck, bus, van, railroad car, automobile, tractor, trailer, motor home, recreational vehicle, semi-tractor or any other motorized transportation device, regardless of whether it is in operating condition.

Vehicle major repair, servicing and maintenance shall mean any building, or portion thereof, where heavy maintenance activities such as engine overhauls, automobile/truck painting, body or fender work, welding or the like are conducted. Such use shall not include the sale of fuel, gasoline or petroleum products.

Vehicle minor repair, servicing and maintenance shall mean the use of any building, land area, premises or portion thereof, where light maintenance activities such as engine tune-ups, lubrication, carburetor cleaning, brake repair, car washing, detailing, polishing or the like are conducted.

Vehicle rentals for cars, light trucks and light equipment shall mean the use of any building, land area or other premises for the rental of cars, light trucks and/or light equipment.

Vehicle rentals for heavy equipment, large trucks and trailers shall mean the use of any building, land area or other premises for the rental of heavy equipment, large trucks or trailers.

Vehicle sales and leasing for cars and light trucks shall mean the use of any building, land area or other premises for the display and sale or lease of any new or used car or light truck, and may include outside storage of inventory, any warranty repair work or other repair service conducted as an accessory use.

Vehicle sales and leasing for farm equipment, mobile homes, recreational vehicles, large trucks and boats with outdoor storage shall mean the use of any building, land area or other premises for the display and sale or lease of new or used large trucks, trailers, farm equipment, mobile homes, recreational vehicles, boats and watercraft, and may include the outside storage of inventory, any warranty repair work or other repair service conducted as an accessory use.

Vested property right shall mean the right to undertake and complete the development and use of property under the terms and conditions of a site specific development plan.

Veterinary facilities, hospital shall mean any facility that is maintained by or for the use of a licensed veterinarian in the diagnosis, treatment or prevention of animal diseases.

Veterinary facilities, small animal clinic shall mean any facility maintained by or for the use of a licensed veterinarian in the diagnosis, treatment or prevention of animal diseases wherein the animals are limited to dogs, cats or other comparable household pets and wherein the overnight care of said animals is prohibited except when necessary in the medical treatment of the animal.

Veterinary facilities, small animal hospital shall mean any facility that is maintained by or for the use of a licensed veterinarian in the diagnosis, treatment or prevention of animal diseases wherein the animals are limited to dogs, cats or other comparable household pets and wherein the overnight care of said animals is permitted.

Visibility shall mean the quality or state of being perceivable by the eye. Visibility may be defined in terms of the distance at which an object can be just perceived by the eye or it may be defined in terms of the contrast or size of a standard test object, observed under standardized view-conditions, having the same threshold as the given object.

Walkway shall mean an off-street pedestrian path.

Warehouse shall mean a building used primarily for the storage of goods or materials excluding marijuana products.

Where physical conditions permit shall mean that the development application must comply with the regulation unless the applicant can demonstrate that it is not physically possible to do so due to land form, sight line requirements, existing trees, utilities, drainage requirements, access requirements or other constraints of the land.

Wholesale distribution shall mean a use primarily engaged in the sale and distribution of manufactured products, supplies or equipment, including accessory offices or showrooms, and including incidental retail sales, but excluding marijuana products, bulk storage of materials that are inflammable or explosive or that create hazardous or commonly recognized offensive conditions, and where the products, supplies or equipment that are distributed from the facility are not used or consumed on the premises. Activities customarily include receiving goods in bulk or large lots and assembling, sorting or breaking down such goods into smaller lots for redistribution or sale to others for resale.

Wildlife rescue and education center shall mean a facility that provides shelter services for the rescue and care of injured birds or other wildlife with associated education and research.

Window transparency shall mean the surface area of a window that is not covered or obstructed by a sign, such that the visibility through the window in both directions is not blocked by a sign.

Wireless communications facility or *WCF* shall mean a facility used to provide personal wireless services as defined at 47 U.S.C. Section 332 (c)(7)(C); or wireless information services provided to the public or to such classes of users as to be effectively available directly to the public via licensed or unlicensed frequencies; or wireless utility monitoring and control services. A WCF does not include a facility entirely enclosed within a permitted building where the installation does not require a modification of the exterior of the building; nor does it include a device attached to a building, used for serving that building only and that is otherwise permitted under other provisions of the Code. A WCF includes an antenna or antennas, including without limitation, directional, omni-directional and parabolic antennas, support equipment, small cell facilities, alternative tower structures, and towers. It does not include the support structure to which the WCF or its components are attached if the use of such structures for WCFs is not the primary use. The term does not include mobile transmitting devices used by wireless service subscribers, such as vehicle or handheld radios/telephones and their associated transmitting antennas, nor does it include other facilities specifically excluded from the coverage of this Code.

Working pad surface shall mean the portion of an oil and gas location that has an improved surface upon which oil and gas facilities are placed.

Workshop and custom small industry shall mean a facility wherein goods are produced or repaired by hand, using hand tools or small-scale equipment, including small engine repair, furniture making and restoring, upholstery, custom car or motorcycle restoring or other similar uses.

Yard shall mean that portion of the open area on a lot extending open and unobstructed from the ground upward from a lot line for a depth or width specified by the regulations for the district in which the lot is located.

Yard, front shall mean a yard extending across the full width of the lot between the front line and the nearest line or point of the building.

Yard, rear shall mean a yard extending across the full width of the lot between the rear lot line and the nearest line or point of the building.

Yard, side shall mean a yard extending from the front yard to the rear yard between the side lot line and the nearest line or point of the building.

Zero lot line development plan shall mean a development plan where one (1) or more buildings are placed on lots in such a manner that at least one (1) of the building's sides rests directly on a lot line, as measured from the outer edge of the foundation at the ground line, so as to enhance the usable open space on the lot.

Zero lot line structure shall mean a structure with at least one (1) wall conterminous with the lot line, which wall may include footings, eaves and gutters that may encroach onto the abutting lot under the authority of an encroachment and maintenance easement.

Zone district shall mean a zone district of the City as established in Article 2 unless the term is used in a context that clearly indicates that the term is meant to include both the zone district(s) of the City and the zone district(s) of an adjoining governmental jurisdiction.

Zoning Map shall mean the official zoning map adopted by the City by ordinance, as amended.