

Quote	Bill To	Ship To
Quote Number: 155500 - 2	Forest Park Fire Department	Forest Park Fire Department
Date: 3/12/2024	785 LINDA WAY	785 LINDA WAY
Purchase Order:	FOREST PARK GA 30297-2758	FOREST PARK GA 30297-2758
Sales Person: Colby Mock	US	US
Valid Until: 4/11/2024	Sara Hudson	Sara Hudson
Desired Delivery: 6/30/2024	6786036084	6786036084

Quote Items				
Part #	Product	Quantity	Unit Price	Total Price
6070	FORCE MACHINE	2	\$3,980.50	\$7,961.00

Equipment Subtotal:	\$	\$7,961.00
+Parts:	\$	\$0.00
+Installation:	\$	\$0.00
+Shipping(Standard w/Lift):	\$	\$2,215.51
Subtotal Before Tax:	\$	\$10,176.51
+ Tax:	\$	\$0.00
Total with Tax & Discounts:	\$	\$10,176.51

Installation By: customer
 Deliver To: customer
 Shipping Type: Standard w/Lift
 Currency: USD

Initial: _____

Quote Number: 155500 - 2

Bill To: Forest Park Fire Department

Ship To: Forest Park Fire Department

Shipping Terms:

The freight quote includes inside delivery to a ground level, with a lift gate on delivery vehicle. For residential customers this is limited to garage/car port drop off. Construction delays, late pick-ups, and/or changes to an order are required to be arranged with Keiser Corporation three weeks prior to ship date listed on the Sales Order Acknowledgement. If order is held at the loading dock at our Fresno, CA location for more than three business days, a storage fee of \$170 per day will be charged. Any additional labor, special moving equipment, special handling services, redelivery or storage will result in additional charges. Initial: _____

Installation:

Keiser will not be responsible for the structural integrity of the building for any wall or floor mounted equipment. It is the responsibility of the purchaser to ensure that said wall or floor is structurally prepared to properly secure said equipment while in use. [Reference attached document "INSTALLATION INSTRUCTIONS PERFORMANCE TRAINER" for more information.]

Cancellation:

Cancellation of shipped orders, that are unopened and/or unused, will be charged a 15% restocking fee plus the return freight charges. Returned equipment will only be accepted by Keiser with prior written authorization, accompanied with a valid Return Authorization Number and within 30 days of the original ship date.

Standard Terms:

The use of any exercise equipment, including, without limitation, Keiser's strength training equipment in which resistance can be changed at anytime during the repetition, and any fixed gear bike, including, without limitation, the Keiser M3 bike, without proper instruction and supervision violates the terms of this agreement for purchase of such products. The ability to add resistance anytime during a repetition, including, without limitation, the ability to do a heavy negative may be dangerous, especially for anyone that does not recognize or respect the potential danger. The inability to stop pedaling on a fixed gear bike before the flywheel stops may also be dangerous to anyone riding, especially anyone that does not recognize or respect the potential danger. Therefore, users, agents, or anyone directing the use of said equipment shall determine the suitability of the product for its intended use, and said parties are specifically put on notice that they shall assume all risk and liability in connection herewith. This does not include liabilities arising out of, connected with, and/or relating to the design, manufacture, materials, or workmanship of any Keiser Product.

Instructions:

Please ensure you complete and return by either Fax or e-mail a copy of the signed quote to the sales rep noted above. Failure to do so could result in a delay of your shipment and may also incur additional shipping charges. Keiser will acknowledge your order and confirm your ship date within 48 hours of booking the order. All ship dates are assigned on a first come, first served basis. Quote is in U.S. dollars and does not include applicable duties, taxes and/or customs fees, which are the responsibility of the buyer. The customer is responsible for inspection of each unit and part for shipping damage at time of delivery or installation, and prior to signing receiving paperwork. If the customer signs an unqualified receipt for freight damage goods, the customer is solely responsible for the cost of the repair or replacement for such freight damage. The signing of this quote and /or the issuance of a purchase order acknowledge that the person authorized to purchase the products listed on this quote and /or listed on the purchase order has read and agrees to the terms of this quote. These terms are in addition to and supersede all other terms of this sale.

I have read and accept the terms of this quote.

Initial: _____



Home » Fire Responder Equipment & Supplies » Keiser Force Machine

Keiser Force Machine

\$4,050.80

1

ADD TO CART



SEE ADD TO QUOTE

Part Number: 006070

BETTER KNOWN TO FIREFIGHTERS AS "THE KEISER SLED"

The Keiser FORCE Machine was originally designed for the Fire fighter Combat Challenge® to simulate the chopping motion used in firefighting. It employs the same kinetics and ergonomics as those used with an axe, with the benefit of a safer and resource-free training and conditioning exercise. It is an efficient and durable means of training and testing emergency services personnel who use axes and sledgehammers in their occupations.

Description Additional information Reviews (0) Ask an Expert

- Biomechanically correct design
- Polyethylene glides on bottom of I-beam for consistent running service
- Used in the annual Firefighter Combat Challenge
- Certified and endorsed by On-Target
- To use the FORCE Machine, an individual stands on the footwalks, straddling the I-beam then strikes the I-beam using the specifically designed 9 lb dead-blow sledgehammer
- It takes an average of twenty to twenty-five strikes to move the I-beam 5 feet (1.5m) a level of effort consistent with many forcible entry situations
- The movement accurately reflects structural firefighting tasks

SPECIFICATIONS

- Height: 11" / 280 mm
- Width: 37" / 940 mm
- Length: 86" / 2439 mm
- Platform Height: 6" / 229 mm
- Total Weight: 346 lbs / 157 kg
- Striking Block Weight: 151 lbs / 69 kg
- Sledgehammer Weight: 9 lbs / 4.1 kg

Related products



FOREST PARK, CITY OF

03/28/2024



03/28/2024

FOREST PARK, CITY OF
4539 JONESBORO RD
FOREST PARK, GA 30297

Dear Jon Baker,

Motorola Solutions is pleased to present FOREST PARK, CITY OF with this quote for quality communications equipment and services. The development of this quote provided us the opportunity to evaluate your requirements and propose a solution to best fulfill your communications needs.

This information is provided to assist you in your evaluation process. Our goal is to provide FOREST PARK, CITY OF with the best products and services available in the communications industry. Please direct any questions to Dena Nunz at dena.nunz@deir.com.

We thank you for the opportunity to provide you with premier communications and look forward to your review and feedback regarding this quote.

Sincerely,

Dena Nunz

Motorola Solutions Manufacturer's Representative

Billing Address:
 FOREST PARK, CITY OF
 4539 JONESBORO RD
 FOREST PARK, GA 30297
 US

Quote Date:03/28/2024
 Expiration Date:05/27/2024
 Quote Created By:
 Dena Nunz
 dena.nunz@deirr.com

End Customer:
 FOREST PARK, CITY OF
 Jon Baker

Contract: 36273 - SOURCEWELL
 042021-MOT

Line #	Item Number	Description	Qty	List Price	Sale Price	Ext. Sale Price
	APX™ 6000 Series	APX6000				
1	H98UCF9PW6BN	APX6000 700/800 MODEL 2.5 PORTABLE	1	\$3,595.00	\$2,624.35	\$2,624.35
1a	H869BZ	ENH: MULTIKEY	1	\$363.00	\$264.99	\$264.99
1b	Q361AR	ADD: P25 9600 BAUD TRUNKING	1	\$330.00	\$240.90	\$240.90
1c	QA00580AC	ADD: TDMA OPERATION	1	\$495.00	\$361.35	\$361.35
1d	QA05100AA	EHN: STD 1 YR WARRANTY APPLIES	1	\$0.00	\$0.00	\$0.00
1e	H38BT	ADD: SMARTZONE OPERATION	1	\$1,320.00	\$963.60	\$963.60
1f	QA09113AB	ADD: BASELINE RELEASE SW	1	\$0.00	\$0.00	\$0.00
1g	Q806BM	ADD: ASTRO DIGITAL CAI OPERATION	1	\$567.00	\$413.91	\$413.91
1h	Q629AK	ENH: AES ENCRYPTION AND ADP	1	\$523.00	\$381.79	\$381.79
2	LSV00Q00202A	DEVICE PROGRAMMING	1	\$121.43	\$121.43	\$121.43
3	NNTN8860B	CHARGER, SINGLE-UNIT, IMPRES 2, 3A, 115VAC, US/NA	1	\$186.50	\$136.15	\$136.15
4	PMMN4065AL	MICROPHONE,IMPRES RSM, IP57	1	\$115.24	\$84.13	\$84.13



Any sales transaction following Motorola's quote is based on and subject to the terms and conditions of the valid and executed written contract between Customer and Motorola (the "Underlying Agreement") that authorizes Customer to purchase equipment and/or services or license software (collectively "Products"). If no Underlying Agreement exists between Motorola and Customer, then Motorola's Standard Terms of Use and Motorola's Standard Terms and Conditions of Sales and Supply shall govern the purchase of the Products.

Motorola Solutions, Inc.: 500 West Monroe, United States - 60661 - #: 36-1115800



Grand Total

\$5,592.60(USD)

Notes:

- Unless otherwise noted, this quote excludes sales tax or other applicable taxes (such as Goods and Services Tax, sales tax, Value Added Tax and other taxes of a similar nature). Any tax the customer is subject to will be added to invoices.



Purchase Order Checklist

Marked as PO/ Contract/ Notice to Proceed on Company Letterhead
(PO will not be processed without this)

PO Number/ Contract Number

PO Date

Vendor = Motorola Solutions, Inc.

Payment (Billing) Terms/ State Contract Number

Bill-To Name on PO must be equal to the *Legal* Bill-To Name

Bill-To Address

Ship-To Address (If we are shipping to a MR location, it must be documented on PO)

Ultimate Address (If the Ship-To address is the MR location then the Ultimate Destination address must be documented on PO)

PO Amount must be equal to or greater than Order Total

Non-Editable Format (Word/ Excel templates cannot be accepted)

Bill To Contact Name & Phone # and EMAIL for customer accounts payable dept

Ship To Contact Name & Phone #

Tax Exemption Status

Signatures (As required)



FOREST PARK, CITY OF

03/28/2024



QUOTE-2579849

03/28/2024

FOREST PARK, CITY OF
4539 JONESBORO RD
FOREST PARK, GA 30297

Dear Jon Baker,

Motorola Solutions is pleased to present FOREST PARK, CITY OF with this quote for quality communications equipment and services. The development of this quote provided us the opportunity to evaluate your requirements and propose a solution to best fulfill your communications needs.

This information is provided to assist you in your evaluation process. Our goal is to provide FOREST PARK, CITY OF with the best products and services available in the communications industry. Please direct any questions to Dena Nunz at dena.nunz@deirr.com.

We thank you for the opportunity to provide you with premier communications and look forward to your review and feedback regarding this quote.

Sincerely,

Dena Nunz

Motorola Solutions Manufacturer's Representative



Billing Address:
FOREST PARK, CITY OF
4539 JONESBORO RD
FOREST PARK, GA 30297
US

Quote Date:03/28/2024
Expiration Date:05/27/2024
Quote Created By:
Dena Nunz
dena.nunz@deirr.com

End Customer:
FOREST PARK, CITY OF
Jon Baker

Contract: 36273 - SOURCEWELL
042021-MOT

Line #	Item Number	Description	Qty	List Price	Sale Price	Ext. Sale Price
	APX™ 6000 Series	APX6000 XE				
1	H98UCF9PW6BN	APX6000 700/800 MODEL 2.5 PORTABLE	1	\$3,595.00	\$2,624.35	\$2,624.35
1a	H869BZ	ENH: MULTIKEY	1	\$363.00	\$264.99	\$264.99
1b	Q361AR	ADD: P25 9600 BAUD TRUNKING	1	\$330.00	\$240.90	\$240.90
1c	QA02006AA	ENH: APX6000XE RUGGED RADIO	1	\$880.00	\$642.40	\$642.40
1d	QA00580AC	ADD: TDMA OPERATION	1	\$495.00	\$361.35	\$361.35
1e	QA05100AA	EHN: STD 1 YR WARRANTY APPLIES	1	\$0.00	\$0.00	\$0.00
1f	H38BT	ADD: SMARTZONE OPERATION	1	\$1,320.00	\$963.60	\$963.60
1g	QA09113AB	ADD: BASELINE RELEASE SW	1	\$0.00	\$0.00	\$0.00
1h	QA01427AB	ALT: IMPACT GREEN HOUSING	1	\$28.00	\$20.44	\$20.44
1i	Q806BM	ADD: ASTRO DIGITAL CAI OPERATION	1	\$567.00	\$413.91	\$413.91
1j	Q629AK	ENH: AES ENCRYPTION AND ADP	1	\$523.00	\$381.79	\$381.79
2	LSV00Q00202A	DEVICE PROGRAMMING	1	\$121.43	\$121.43	\$121.43



Any sales transaction following Motorola's quote is based on and subject to the terms and conditions of the valid and executed written contract between Customer and Motorola (the "Underlying Agreement") that authorizes Customer to purchase equipment and/or services or license software (collectively "Products"). If no Underlying Agreement exists between Motorola and Customer, then Motorola's Standard Terms of Use and Motorola's Standard Terms and Conditions of Sales and Supply shall govern the purchase of the Products.
Motorola Solutions, Inc.: 500 West Monroe, United States - 60661 - #: 36-1115800



Line #	Item Number	Description	Qty	List Price	Sale Price	Ext. Sale Price
3	NNTN8860B	CHARGER, SINGLE-UNIT, IMPRES 2, 3A, 115VAC, US/NA	1	\$186.50	\$136.15	\$136.15
4	PMMN4107C	AUDIO ACCESSORY- REMOTE SPEAKER MICROPHONE.XE500 REMOTE SPKR MIC WITHOUT CHANNEL KNOB, HIGH IMPACT GREEN	1	\$594.00	\$433.62	\$433.62
Grand Total					\$6,604.93(USD)	

Notes:

- Unless otherwise noted, this quote excludes sales tax or other applicable taxes (such as Goods and Services Tax, sales tax, Value Added Tax and other taxes of a similar nature). Any tax the customer is subject to will be added to invoices.



Any sales transaction following Motorola's quote is based on and subject to the terms and conditions of the valid and executed written contract between Customer and Motorola (the "Underlying Agreement") that authorizes Customer to purchase equipment and/or services or license software (collectively "Products"). If no Underlying Agreement exists between Motorola and Customer, then Motorola's Standard Terms of Use and Motorola's Standard Terms and Conditions of Sales and Supply shall govern the purchase of the Products.
 Motorola Solutions, Inc.: 500 West Monroe, United States - 60661 ~ #: 36-1115800



Purchase Order Checklist
Marked as PO/ Contract/ Notice to Proceed on Company Letterhead (PO will not be processed without this)
PO Number/ Contract Number
PO Date
Vendor = Motorola Solutions, Inc.
Payment (Billing) Terms/ State Contract Number
Bill-To Name on PO must be equal to the <i>Legal</i> Bill-To Name
Bill-To Address
Ship-To Address (If we are shipping to a MR location, it must be documented on PO)
Ultimate Address (If the Ship-To address is the MR location then the Ultimate Destination address must be documented on PO)
PO Amount must be equal to or greater than Order Total
Non-Editable Format (Word/ Excel templates cannot be accepted)
Bill To Contact Name & Phone # and EMAIL for customer accounts payable dept
Ship To Contact Name & Phone #
Tax Exemption Status
Signatures (As required)



2825 Airview Boulevard
Kalamazoo, MI 49002 USA

Invoice

9205737705

Bill to: 20135455

212686-5.9 0 7109-1.1 1oz

 FOREST PARK FIRE AND EMS
ATTN: ACCOUNTS PAYABLE DEPARTMENT
4539 JONESBORO RD
FOREST PARK GA 30297 - 3542

Customer Information	
Invoice #	9205737705
Invoice Date	03/06/2024
Currency	USD
Payer Number	20135455
Payer Name	FOREST PARK FIRE AND EMS

Ship to
20135455
FOREST PARK FIRE AND EMS 4539 JONESBORO RD FOREST PARK GA 30297-3542

Remit to :	
Electronic Payments:	Checks:
JPMorgan Chase ABA 071000013 (ACH) Account: 1035237 ABA 021000021 (WIRE) SWIFT Code: CHASUS33XXX	Stryker Sales, LLC 21343 NETWORK PLACE CHICAGO IL 60673-1213 USA

For product related inquiries please contact:
Stryker Medical Customer Service: 800-327-0770
For accounts and billing related inquiries please contact:
Stryker account receivable: 800-733-2383(Option 2)

Please transmit in CTX format. If CTX is not possible, please send remittance information by email to EFTpayments@stryker.com

Header Information			
Customer PO	23-02133	Payment Due Date	04/05/2024
Payment Terms	Net due in 30 days		
Terms of Delivery	PCO ORIGIN		

Item	Item#/GTIN	Description	Quantity / Unit	Unit Price	Extended Price
1	99576-000063 GTIN: 00883873834329	LUCAS 3, 3.1, IN SHIPPING BOX, EN Serial Number 3523GY14	1 PC	15,431.57	15,431.57
				Item Total	15,431.57
				Freight and Handling	192.89
				Gross Amount	15,624.46
Service Level	Ground Carrier	FEDEX EXPRESS			
Tracking Numbers	733632240160				





2825 Airview Boulevard
Kalamazoo, MI 49002 USA

Invoice
9205737705

Tracking Numbers	733632240160
------------------	--------------

The purchase of products pursuant to this invoice is subject to Stryker's then current terms of sale set forth at (see www.stryker.com/stnc). Any different or additional terms on any purchase order or other document submitted by Buyer are expressly rejected by Stryker. Acceptance of Buyer's purchase order and shipping of Stryker product to Buyer does not serve as acceptance of any such different or additional terms.

The total price shown on this invoice is net of discounts provided at the time of purchase. Some of the products listed on this invoice may be subject to rebates or additional discounts for which separate documentation is provided by Stryker. Customer must (1) claim the value of all discounts and rebates in the fiscal year earned or immediately following fiscal year, (2) properly report and appropriately reflect and allocate prices paid net of all discounts and rebates in Medicare/Medicaid cost reports and all claims for payment filed with third party payers as may be required by law or contract, and (3) provide agents of the United States or a state agency with access to all information from Stryker concerning discounts and rebates upon request.

STRYKER RESERVES THE RIGHT TO CHARGE A 1.5% MONTHLY FINANCE CHARGE (18% PER ANNUM) ON ALL AMOUNTS REMAINING UNPAID AT THE END OF THE NET PERIOD.

NO MERCHANDISE WILL BE ACCEPTED FOR RETURN WITHOUT PRIOR AUTHORIZATION. TO OBTAIN A RETURN AUTHORIZATION OR TO REPORT DISCREPANCIES, PLEASE CALL CUSTOMER SERVICE AT THE NUMBER INDICATED ABOVE. Please refer to www.stryker.com/returnpolicy for Stryker's product return policies.

Andrew Gelmini
EMS Coordinator

City of Forest Park
Department of Fire and Emergency Services
2336 Anvil Block Road • Forest Park, GA 30297

Chiefs,

Attached you will find a quote for 1 LUCAS v3.1. The LUCAS Device is a plunger type automatic chest compression system designed to deliver regulated and consistent chest compressions to a victim of out of hospital cardiac arrest. This device further offers the users the ability to use this device during transport minimizing the amount of people standing up, unrestrained in the back of an ambulance. This device is being requested to replace the current LUCAS v2 that is house on Battalion 1. This device is used in the event that all ambulances are out of the City and a patient requires the care that this device offers while awaiting a transport unit. The current LUCAS v2 is beyond its useful life by manufacturers standards and has required repairs recently to function. This device is also nearing the end of ProCare coverage as parts and technology to service this device have been upgraded and are harder and more expensive. I would like to replace the Battalion 1 LUCAS with a v3.1 with ProCare coverage for 5 years after the warranty period to cover any and all issues, updates, and maintenances. The currently owned LUCAS v2, I am requesting be placed in the Training Division for use in Initial EMS Education.

Thank you,



Andrew Gelmini, A.S., NRP, I/C-P
EMS Coordinator, Forest Park Fire and Emergency Services





Serving Self-Service & On-Premise Laundries
throughout the South since 1980

Wholesale Commercial Laundry Equipment S.E., LLC

If it's laundry equipment, we've got it.

2950 HIGHWAY 77
SOUTHSIDE, AL 35907

1-866-5GIRBAU (544-7228)
FAX: 1-256-413-0955
Serving: AL, FL, GA, MS, NC, SC, TN,
PA, NJ, DE

Invoice

Date	Invoice #
3/13/2024	39720

Bill To	Ship To
CITY OF FOREST PARK F.D. DAVID HALCOME 2236 ANVIL BLOCK RD. FOREST PARK, GA 30297	CITY OF FOREST PARK F.D. GEOFF MAY 4539 JONESBORO ROAD FOREST PARK, GA 30297

Check out our online parts store at www.alaundryman.com for DEEP discounts on your needed parts. New parts added daily!
Our online store also contains free PDF downloads of many of our available parts manuals! Check it out today!

Customer PO	Terms	Due Date	Rep	Our PO
23-03179		3/13/2024	DEB	18436

Item	Description	Qty	Rate	Returns	Amount
XDH-4	CONTINENTAL OPL XD SERIES EXPRESS DRY GEAR DRYER, TURN OUT GEAR TYPE, STATIONARY STICKMAN, DIGITAL DISPLAY CONTROL, WITH HEAT, REMOVABLE BLOWER, 240/60/1 VOLTAGE, 4-PLACE UNIT. G10365, G10382	2	13,825.00		27,650.00
FREIGHT	SHIPPING & HANDLING CHARGES DROP SHIP WITH LIFT GATE AND APPOINTMENT TO FS #1 - GEOFF MAY, DEPUTY CHIEF OPS 470-591-9113 gmay@forestparkga.gov	1	895.00		895.00

Customer Understands & Agrees There Are No Returns On Electrical, Electronic, Or Special Order Parts. New Equipment Comes With A Manufacturers 3/5 Year Limited Warranty, & Covers Defects In Workmanship & Or Material. Please See Warranty Bond For Details. Warranty Replacement Parts Must Be Purchased. Once the Defective Part Is Returned To The Manufacturer & Credit Is Issued By The Manufacturer, A Credit Will Be Issued To The Customer. All Related Shipping Charges For The Incoming Replacement Part & Return Of The Defective Part To The Manufacturer Is The Sole Responsibility Of The Purchaser. All Warranty Information Must be Provided At The Time Of Purchase Of The Replacement Part, Including Machine Model# Serial# Installation Date & Specific Condition Or Failure Of The Defective Part. Abuse, Vandalism, Improper Operation Or Other Conditions Not Tied To A Defect In Materials Or Workmanship Is Not Covered. Labor Is Not Covered Unless Specifically Noted On Sales Contract or Invoice.

Subtotal	\$28,545.00
Sales Tax (0.0%)	\$0.00
Total	\$28,545.00
Payments/Credits	\$0.00

Customer understands and agrees to pay 1.5% interest per month on past due balances. Customer understands and agrees that should Past Due Balances exceed 15 days past the due date, Wholesale Commercial Laundry Equipment SE LLC may take legal action to collect past due balances, Customer understands and agrees that they shall be responsible for all costs incurred in the collections of said past due balances. Invoice price reflects factory rebates, discounts & special pricing. Parts or equipment that is drop shipped to the customer is FOB. Customer cannot refuse shipment, and is responsible for filing freight damage claims with the carrier. Deposits are Non- Refundable once order is placed.

Balance Due \$28,545.00

getparts@alaundryman.com

www.alaundryman.com

*** IF YOU BELIEVE THE INFO IN THIS INVOICE TO NOT BE CORRECT- YOU HAVE 21 DAYS FROM THE DATE OF THE INVOICE TO CONTEST- OTHER WISE NO ALTERATIONS WILL BE CONSIDERED***

Terms	P.O. Number	Ship Via
-------	-------------	----------

Line	Qty	Description	Unit Price	Ext. Price
1	2	XDH-4 RAM-AIR / CONTINENTAL-GIRBAU OPL XDH-4 HEATED EXPRESS DRY GEAR DRYER -4-PLACE UNIT, Capacity: Up to 4 sets of turnout gear, 16 Accessory drying ports for gloves, helmets balaclavas, Touchscreen Control, with heat, and no heat, timed options or continuous drying. Maximum temperature programable up to 105 degree, Dimensions: 72" W X 28" D x 78" H, 220-240/60/1/20A.	\$13,825.00	\$27,650.00
				
2	1	INSTALLATION START UP OPTIONAL - DELIVER DRYERS INTO STATIONS 1 + 2, UNCRATE, ASSEMBLE AND CONNECT TO OWNER PROVIDED ELCTRIC CONNECTION. OUTLET MUST BE WITHIN 5' OF THE BLOWER MOTOR OF THE DRYER AND BE OF THE PROPER SIZE. START UP, TESTING AND TRAINING FOR ALL RELEVANT PERSONNEL.	\$0.00	\$0.00
3	1	WARRANTY 3 YEARS FACTORY WARRANTY, 90 DAYS LABOR W/INSTALLATION.	\$0.00	\$0.00

ORDERS REQUIRE A 20% NON-REFUNDABLE DEPOSIT. ORDER CANCELLATION IS SUBJECT TO A 25% RESTOCKING FEE. ORDER IS SECURED WITH UCC-1 FILING. PRICES ARE VALID FOR 90 DAYS, PRICES ARE BASED UPON TOTAL PURCHASE PAYABLE BY CASH OR CHECK CREDIT CARD PAYMENTS WILL INCUR AN ADDITONAL 4%.



Serving Self-Service & On-Premise Laundries
throughout the South since 1980

**Wholesale Commercial
Laundry Equipment S.E., LLC**

If it's laundry equipment, we've got it.

2950 Highway 77, Southside, AL 35907
t. 256-413-7623 f. 256-413-0955

QUOTE

Number AAAQ4991

Date Feb 2, 2024

Sold To

CITY OF FOREST PARK FIRE DEPT
GEOFF MAY
4539 JONESBORO ROAD
FOREST PARK, GA 30297

Phone 770-652-4811
Fax

Here is the quote you requested.

Ship To

CITY OF FOREST PARK FD # 1+ 2
GEOFF MAY
4539 JONESBORO ROAD
FOREST PARK, GA 30297

Phone 770-652-4811
Fax

Your Sales Rep

Jim
404-416-4406
JIM@ALAUNDRYMAN.CO
M

Line	Qty	Description	Unit Price	Ext. Price
<p>WE SHALL NOT BE LIABLE FOR ANY LOSS OF PROFITS, BUSINESS, GOODWILL, INTERRUPTION OF BUSINESS, NOR FOR INCIDENTAL OR CONSEQUENTIAL MERCHANTABILITY OR FITNESS OF PURPOSE, DAMAGES RELATED TO THIS AGREEMENT. CUSTOMER UNDERSTANDS AND AGREES THERE ARE NO RETURNS ON ELECTRICAL, ELECTRONIC, OR SPECIAL ORDER PARTS/EQUIPMENT. CUSTOMER UNDERSTANDS AND AGREES THAT PARTS OR EQUIPMENT THAT IS DROP SHIPPED TO THE CUSTOMER IS FOB. CUSTOMER CANNOT REFUSE SHIPMENT, AND IS RESPONSIBLE FOR FILING FREIGHT DAMAGE CLAIMS (IF ANY) WITH THE CARRIER. WARRANTIES ARE AS PROVIDED BY THE MANUFACTURER, PLEASE SEE SPECIFIC WARRANTY BOND FOR DETAILS. WARRANTY REPLACEMENT PARTS MUST BE PURCHASED, ONCE THE DEFECTIVE PART IS RETURNED TO THE MANUFACTURER AND CREDIT IS ISSUED BY THE MANUFACTURER, CREDIT WILL BE ISSUED TO THE CUSTOMER, ALL RELATED SHIPPING CHARGES FOR THE INCOMING REPLACEMENT PART AND THE RETURN OF THE DEFECTIVE PART TO THE MANUFACTURER IS THE SOLE RESPONSIBILITY OF THE PURCHASER. ALL WARRANTY INFORMATION MUST BE PROVIDED AT THE TIME OF THE PURCHASE OF THE REPLACEMENT PART INCLUDING MACHINE MODEL # MACHINE SERIAL #, INSTALLATION DATE, AND SPECIFIC CONDITION OF FAILURE OF THE DEFECTIVE PART. ABUSE VANDALISM, IMPROPER OPERATION OR OTHER CONDITIONS NOT SPECIFICALLY TIED TO A DEFECT IN MATERIALS OR WORKMANSHIP IS NOT COVERED. LABOR IS NOT COVERED UNLESS SPECIFICALLY NOTED ON THE INVOICE. CUSTOMER UNDERSTANDS AND AGREES TO PAY 1.5% INTEREST PER MONTH ON PAST DUE BALANCES. CUSTOMER UNDERSTANDS AND AGREES THAT SHOULD PAST DUE BALANCES EXCEED 15 DAYS PAST THE DUE DATE, WHOLESALE COMMERCIAL LAUNDRY EQUIPMENT SE LLC MAY TAKE LEGAL ACTION TO COLLECT PAST DUE BALANCES.</p>			SubTotal	\$27,650.00
			Tax	\$0.00
			Shipping	\$645.00
			Total	\$28,295.00

Please contact me if I can be of further assistance.

ORDERS REQUIRE A 20% NON-REFUNDABLE DEPOSIT. ORDER CANCELLATION IS SUBJECT TO A 25% RESTOCKING FEE. ORDER IS SECURED WITH UCC-1 FILING. PRICES ARE VALID FOR 90 DAYS, PRICES ARE BASED UPON TOTAL PURCHASE PAYABLE BY CASH OR CHECK CREDIT CARD PAYMENTS WILL INCUR AN ADDITIONAL 4%.

240V20amp.JPG

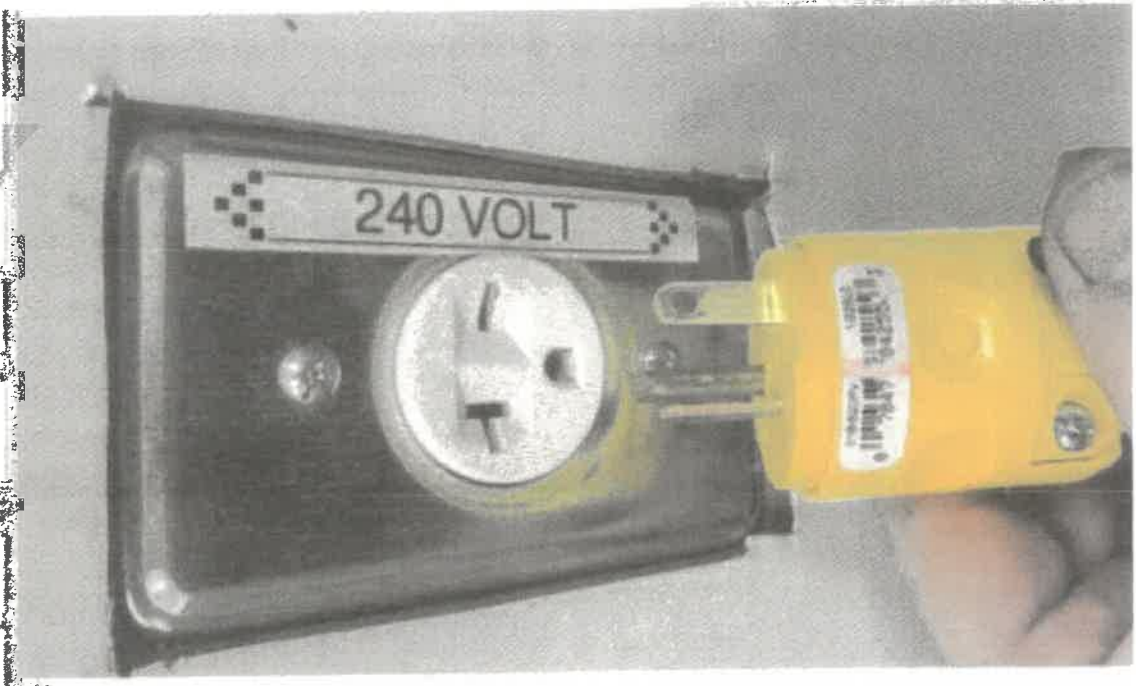

XD-4 / XDH-4

EXPRESSDRY GEAR DRYER

ARCHITECTURAL/MECHANICAL
PRODUCT SPECIFICATIONS

PRODUCT SPECS	TG-4 (no heat)	TG-4H (with heat)
Maximum Number of Gear Sets		4
Number of Accessory Drying Ports		12
Machine Dimensions <i>inch</i> WxDxH	72.2 x 28 x 77.8	
Shipping Dimensions <i>inch</i> WxDxH	75 x 30 x 40	
Machine Weight <i>lbs</i>	303	311
Shipping Weight <i>lbs</i>	362	370
Constructed Material	stainless steel / 12 gauge steel / powder coated paint	
Caster Type	360° swivel	
Motor Power <i>Hp</i>	1	
Motor Speed <i>rpm</i>	3450	
Air Flow <i>cfm</i>	800	
Available Voltages	120/60/1	220/60/1
Breaker Size Required <i>Amp</i>	15	20
Amps	7.8	10.9
Fan Diameter <i>inch</i>	10-5/8	
Fan Wheel Bore <i>inch</i>	5/8	
Thermal Protection	auto	—
Timed Interval Selections	2 - 4 - 8 or 12 hours	
Max Temperature	n/a	105° F
Control Type	Touchscreen	

* Specifications subject to change without notice or obligation. Contact Continental Girbau at (800) 256-1073 for dimensions not shown or for clarification.

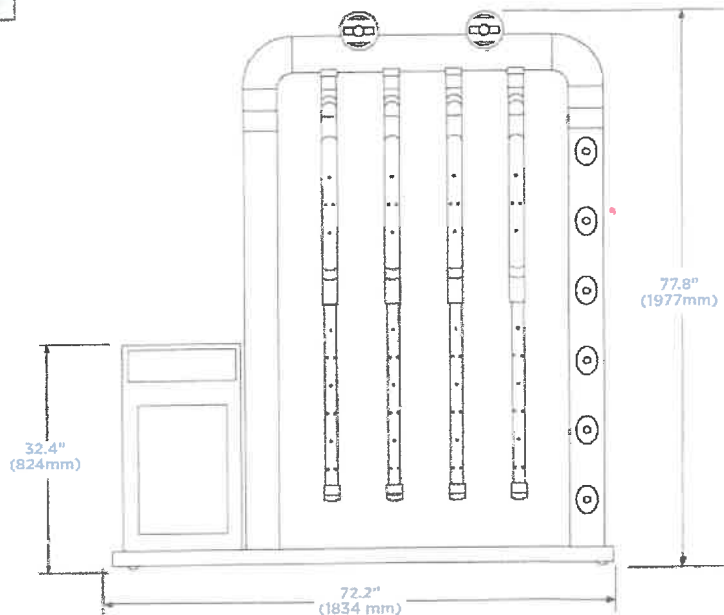
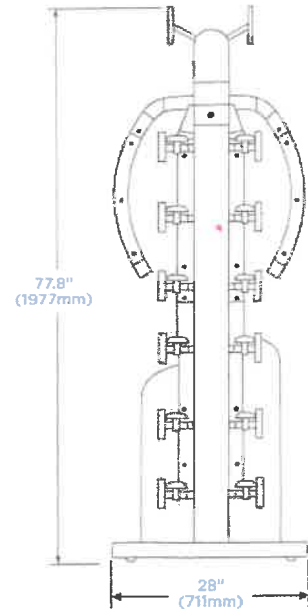

JHB Group, Inc.

8545 Pyott Rd
 Lake In The Hills, IL 60156
 US
 team@jhbgroup.org
 www.JHBGroup.org



Estimate

ADDRESS	SHIP TO	ESTIMATE	27FSS-FPGA.1
Forest Park Fire and Emergency Services	Forest Park Fire and Emergency Services	DATE	03/27/2024
2336 Anvil Block Rd	2336 Anvil Block Rd	EXPIRATION	04/30/2024
Forest Park, GA 30297	Forest Park, GA 30297	DATE	

DATE	DESCRIPTION	QTY	RATE	AMOUNT
	Fire Safety Simulator - 27FT Configuration	1	140,737.08	140,737.08
	Fire Safety Simulator- 27FT	1	140,737.08	
	Aluminum Tube Construction	1	0.00	
	Cross Members 16 O/C	1	0.00	
	V-Nose Design	1	0.00	

14,000BTU				
PowerAwning - 16ft PowerAwning with Weatherguard	PowerAwning - 16ft PowerAwning with Weatherguard	1	0.00	
Swivel Rear Skid Bogie Wheel	Swivel Rear Skid Bogie Wheel	2	0.00	
3M Commercial VHB Tape	3M Commercial VHB Tape	1	0.00	
3M High Grade Silicone	3M High Grade Silicone	1	0.00	
Exterior TV Compartment with 37In LED TV	JHB-OPT-39EXT Custom Exterior TV Compartment with 37In LED Smart TV. 110V Outlet. HDMI Input. Wall Mount Bracket.	1	2,398.00	2,398.00
Severe Weather Package - FSS	JHB-FSS-SVRWTH : Shake, Rattle and Roll Severe Weather System featuring 4 types of weather emergencies with special lighting, sound and vibration effects. Only available with Fire Safety Simulators (JHB-FSS-27).	1	7,992.60	7,992.60
FSS-Industrial/Utility Hazard Package	JHB-FSS-BBQ Flammable liquids cabinet with hidden TV, electrical hazard, leaking gas hazard, lock-out tag-out and BBQ grill simulator. Available option with HAT-FS-TL.	1	9,650.30	9,650.30
PolyCorAP- Exterior - 27FT	JHB-PSP-POLY27 Poly-Cor AP is structurally designed to prevent oil canning even in extreme temperatures, and has a polyester paint that can be easily cleaned with standard household cleaning products. Poly-Cor AP makes for a cooler, brighter, quieter and better looking trailer.	1	5,900.00	5,900.00
Custom Graphic Package - Partial Wrap	JHB-ART-PAR Partial graphics package with custom design, printing of 3M vinyl and installation.	1	7,879.00	7,879.00
FIAR - Augmented Reality Fire Extinguisher Training System	JHB-ARVR-FIAR Includes FIAR Fire Extinguisher Training System. FIAR App, 10# Fire Extinguisher, FIAR Handle, iPad Pro, Chargers, Laser-cut Pelican Case, 2dz Spare Shear Pins, Quickstart Magnets, Manuals and Training Video.	1	14,516.25	14,516.25
Transport Prep & Virtual Training		1	1,250.00	1,250.00

SUBTOTAL	190,323.23
TAX	0.00
SHIPPING	7,203.12
TOTAL	\$197,526.35

FIRE SAFETY SIMULATOR

HANDS-ON LEARNING DESIGNED BY FIREFIGHTERS



JHB-FSS-27 Fire Safety Simulator
 The most advanced fire safety education unit featuring all-ages programming, interactive hazard props and immersive learning systems.



FULLY CUSTOMIZABLE

Our simulators are designed and built for your needs including: size, theme, branding and other innovative options.



FIRE EXTINGUISHER TRAINING

Innovation that brings the training to life without placing the individual in harm's way



ACCESSIBILITY

Easy wheelchair access with low profile rear ramp, two foot extension, torsion axles and zero thresholds.



INTERACTIVE SAFETY ACTIVITIES

Interactive hazard props including Kitchen, Bedroom, BBQ Grill, Industrial and other Multidimensional Hazard Props.



TABLET CONTROL

Control lighting, operate awnings and monitor cameras remotely with the use of an iPad.



1-PERSON SETUP AND OPERATION

Designed with the operator in mind, the trailer includes an XO ratchet jack set up, tablet control system, and CCTV cameras.

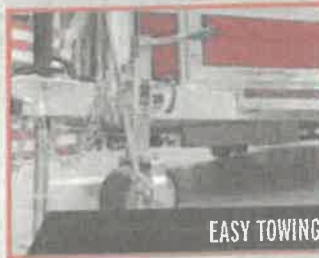

EASY TOWING

Short overall length and lighter weight, all-aluminum construction makes for easy towing.



ADVANCED SOLAR CHARGING

On-board solar charging system, so you're never without power.

FIREFIGHTER OWNED AND OPERATED

JHBGROUP.ORG

FIRE SAFETY SIMULATOR

HANDS-ON LEARNING DESIGNED BY FIREFIGHTERS

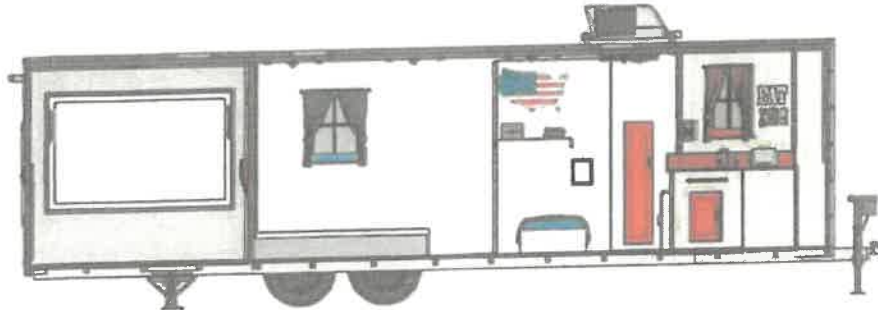

PASSENGER SIDE INTERIOR with BEDROOM OPTION

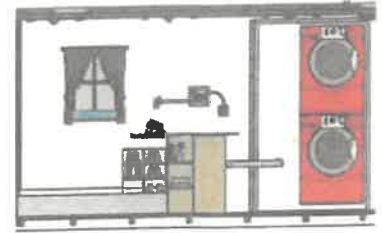

LAUNDRY ROOM OPTION



DRIVER SIDE INTERIOR with INDUSTRIAL / BBQ OPTION

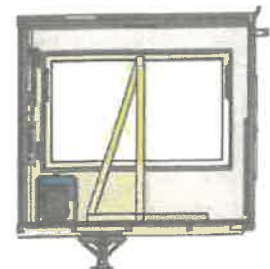

FORCIBLE ENTRY PROP OPTION

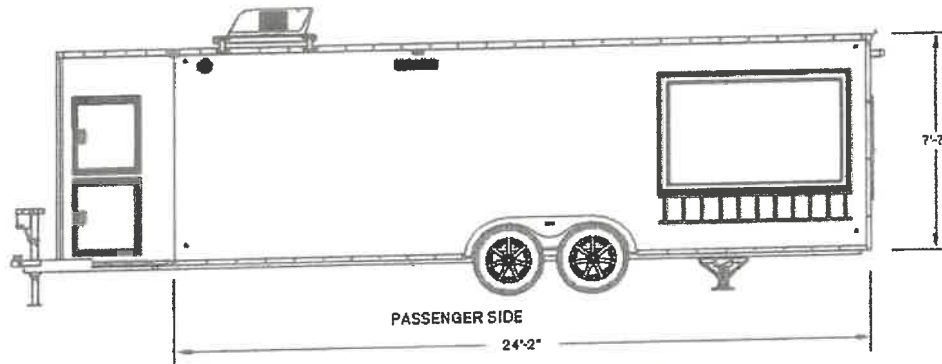

PASSENGER SIDE
24'-2"

7'-7"

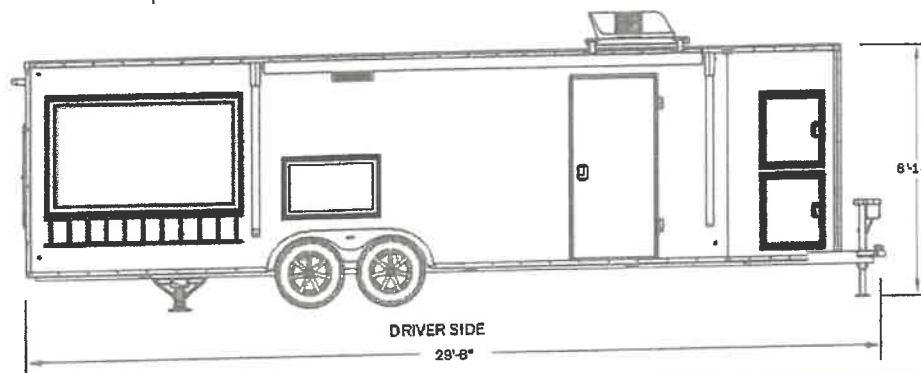

DRIVER SIDE
29'-8"

8'-10"

FIREFIGHTER OWNED AND OPERATED

JHBGROUP.ORG

FiAR Fire Extinguisher

AUGMENTED REALITY FIRE SAFETY TRAINING

FiAR Augmented Reality Fire Extinguisher

FiAR is the world's first AR fire extinguisher training system, delivering the most immersive experience possible for a variety of teaching and training needs. Utilizing 3D innovation, FiAR makes every room the training room, with realistic scenarios, reactive simulation, and quick program customization to meet the training needs of today and tomorrow.

FIAR



- BETTER TRAINING
- MORE REALISTIC
- FULLY RESPONSIVE
- LESS HASSLE



Easy Set Up

- Sets up in less than a minute
- "Quick Start" capability
- Stored scenarios



Fully Customized Scenarios

- Choose the extinguisher
- Set safe distances
- Custom fire behavior



3D Mapping Technology

- With 3D mapping - every room becomes a training room.
- Create lifelike fire scenarios.
- Add realistic 3D props.



Responsive Teaching & Training

- Learn the steps of P.A.S.S.
- Reacts if you turn away
- Feedback for participants



Included in the Package:

- Patented FiAR application
- 10 lb fire extinguisher
- iPad
- Pelican Case
- Chargers
- Quick start magnets
- Spare extinguisher pins
- Training manual

JHB GROUP

FIREFIGHTER OWNED
AND OPERATED
WWW.JHBGROUP.ORG

CALL US
(657)667-3473

GSA Contract Holder
C794240000



(877) 637-3473

Quote

Quote # QT1773804
Date 01/04/2024
Expires 02/23/2024
Sales Rep Adams, Jeremy L
Shipping Method FedEx Ground
Customer FOREST PARK FIRE DEPT(GA)
Customer # C64692

Bill To
 FOREST PARK FIRE DEPT
 2336 Anvil Block Road
 Forest Park GA 30297
 United States

Ship To
 FOREST PARK FIRE DEPT
 2336 Anvil Block Road
 Forest Park GA 30297
 United States

Item	Alt. Item #	Units	Description	QTY	Unit Price	Amount
SPX-2KIT			SUPER X 2 Strut Kit Short Struts	2	\$10,846.00	\$21,692.00
SPX-12EX			SUPER X 1' EXTENSION	2	\$480.00	\$960.00
SPX-24EX			Super-X Struts 2' Extension	2	\$521.00	\$1,042.00
1070-Yellow			Jumbo Lock	8	\$67.00	\$536.00

Subtotal \$24,230.00
Shipping Cost \$400.00
Tax Total \$0.00
Total \$24,630.00

This Quotation is subject to any applicable sales tax and shipping and handling charges that may apply. Tax and shipping charges are considered estimated and will be recalculated at the time of shipment to ensure they take into account the most current information.

All returns must be processed within 30 days of receipt and require a return authorization number and are subject to a restocking fee.

Custom orders are not returnable. Effective tax rate will be applicable at the time of invoice.



QT1773804



(877) 637-3473

Invoice

Invoice # IN2005824
Date 02/12/2024
Terms Net 30
Due Date 03/13/2024
Customer # C64692
PO # David Flagg- Battalion Chief
Sales Rep Adams, Jeremy L
Sales Order SO1859185

Bill To
 FOREST PARK FIRE DEPT
 2336 Anvil Block Road
 Forest Park GA 30297
 United States

Ship To
 FOREST PARK FIRE DEPT
 2336 Anvil Block Road
 Forest Park GA 30297
 United States

Item #	Description	QTY	Units	Back Ordered	Unit Price	Amount
SPX-2KIT	SUPER X 2 Strut Kit Short Struts	2		0	\$10,846.00	\$21,692.00
SPX-12EX	SUPER X 1' EXTENSION	2		0	\$480.00	\$960.00
SPX-24EX	Super-X Struts 2' Extension	2		0	\$521.00	\$1,042.00
1070-Yellow	Jumbo Lock	8		0	\$67.00	\$536.00

Subtotal \$24,230.00
Shipping Cost \$400.00
Tax Total \$0.00
Total \$24,630.00
Amount Due \$24,630.00

Tracking #: 1ZA84K930308954219

All returns must be processed within 30 days of receipt and require a return authorization number and are subject to a restocking fee.
 Custom orders are not returnable.
 All payments must be clearly marked with the Customer and Invoice numbers. Payments not marked will be applied to the oldest invoice first.

PLEASE NOTE OUR REMITTANCE ADDRESS HAS CHANGED AND CHECKS WILL BE RETURNED IF NOT SENT TO THE ONE ON THE REMITTANCE SLIP.

Wire/ ACH:
 Routing#: 121000248
 Acct#: 2000030294606
 Bank Name: Wells Fargo Bank, N.A.

Wire/ ACH Remittance Advice: AR@MESFIRE.COM
 Please include Customer# and Invoice#

Please call us for invoice questions:
 1-877-MES-FIRE (1-877-637-3473)

Remittance Slip

Customer C64692 FOREST PARK FIRE DEPT(GA)
Invoice # IN2005824
Amount Due \$24,630.00
Amount Paid _____

Make Checks Payable To
 MUNICIPAL EMERGENCY SERVICES, INC.
 PO BOX 856892
 MINNEAPOLIS, MN 55485-6892



IN2005824

CITY OF FOREST PARK PURCHASE REQUISITION FORM

For purchases valued \$1,000 and up
This form must be completed prior to creating a Purchase Order

Department :	Fire	Requisition Date:	1/16/2024
Prepared By:	Dep. Chief D. H. [Signature]		
Explanation			
This Requisition is for:		2 sets of Super X Struts with 1' and 2' extensions and Jumbo Locks.	
<input type="checkbox"/> Services	See attachment.		
<input checked="" type="checkbox"/> Goods			
<input type="checkbox"/> Public Works Construction			
<input type="checkbox"/> Other	ENGINE 2 & ENGINE 3		
Justification for Requisition			
See attached		page(s) or line item(s) and attached specifications pages	

Budget

Attach proof of available funds and provide the following:

Budget Line Item:	Fire Fighting Equip. 100-61-3520-53-1136	Cost of goods or services:	\$24,630.00
Funds Available:	\$179,907.30		

Vendor

New vendors must complete the Vendor/Supplier Information Form and provide a w-9 and E-Verify Affidavit.

Select whether vendor is a new or current vendor of the City and provide the following:

<input type="checkbox"/> New	<input checked="" type="checkbox"/> Current	Vendor Name:	MES - Municipal Emergency Services
Current Vendor Number:		01-026760	
If Statewide Contract, provide the following: (Attach one quote. Three quotes are not needed)			
Statewide Contract ID number:		GS-07F-0348V Expires 6/2024	
If Requisition is replacing a current Contract, provide the following:			
Current Contract Number:		887-637-3473	
		Contract Expiration Date:	

Solicitation

Complete this section only if a formal bid or RFP advertisement is needed.

Also attach Solicitation Request Form.

Estimated cost of goods or services:	\$24,630.00
Is cooperative purchase option available?	No
Date goods or services are needed:	When Available

Signatures

Department Head Authorization:	[Signature]	Date:	1/24/24
Purchasing Authorization:	[Signature]	Date:	1/31/24
Finance Director:	[Signature]	Date:	1-31-24
City Manager:	[Signature]	Date:	2-1-24

- Instructions:
1. Complete requisition form in its entirety. (No previous versions of the Requisition Form will be accepted)
 2. Attach 3 quotes (or justification if 3 quotes could not be obtained) and proof of budgeted funds.
 3. Have New Vendors to send Vendor Information Form, w-9, and E-Verify directly to accounts payable@forestparkga.gov.
 4. Email Requisition form and additional documents to procurement@forestparkga.gov.
 5. Once a fully signed requisition has been returned to you, create PO and proceed with purchase.
 6. Once service is received, submit signed Requisition, Invoice, and PO to Accounts Payable (copy Procurement) for payment.

Please complete, sign, and return Requisition Form along with all required documents to procurement@forestparkga.gov
Requisition will not be approved and PO will not be paid if not completed properly.



THE FOREST



MUNICIPAL EMERGENCY SERVICES

(877) 637-3473

Invoice

Invoice # IN2005140
Date 02/09/2024
Terms Net 30
Due Date 03/10/2024
Customer # C64692
PO # Ian Hogan- Captain
Sales Rep Adams, Jeremy L
Sales Order SO1860848

Bill To
 FOREST PARK FIRE DEPT
 2336 Anvil Block Road
 Forest Park GA 30297
 United States

Ship To
 FOREST PARK FIRE DEPT
 2336 Anvil Block Road
 Forest Park GA 30297
 United States

Item	Description	QTY	Unit Price	Amount
201275-01	EPIC 3 Voice Amplifier (Individually Packaged)	25	\$652.53	\$16,313.25

Subtotal \$16,313.25
Shipping Cost \$0.00
Tax Total \$0.00
Total \$16,313.25
Amount Due \$16,313.25

Tracking #: 6132820349

All returns must be processed within 30 days of receipt and require a return authorization number and are subject to a restocking fee.
 Custom orders are not returnable.
 All payments must be clearly marked with the Customer and Invoice numbers. Payments not marked will be applied to the oldest invoice first.

PLEASE NOTE OUR REMITTANCE ADDRESS HAS CHANGED AND CHECKS WILL BE RETURNED IF NOT SENT TO THE ONE ON THE REMITTANCE SLIP.

Wire/ ACH:
 Routing#: 121000248
 Acct#: 2000030294606
 Bank Name: Wells Fargo Bank, N.A.

Wire/ ACH Remittance Advice: AR@MESFIRE.COM
 Please include Customer# and Invoice#

Please call us for invoice questions:
 1-877-MES-FIRE (1-877-637-3473)

Remittance Slip

Customer C64692 FOREST PARK FIRE DEPT(GA)
Invoice # IN2005140
Amount Due \$16,313.25
Amount Paid _____

Make Checks Payable To

MUNICIPAL EMERGENCY SERVICES, INC.
 PO BOX 856892
 MINNEAPOLIS, MN 55485-6892



IN2005140

CITY OF FOREST PARK PURCHASE REQUISITION FORM

For purchases valued \$1,000 and up





This form must be completed prior to creating a Purchase Order

Department :	Fire	Requisition Date:	1/24/2024
Prepared By:	Dep. Chief David Halcome		
Explanation			
This Requisition is for:		25 Epic 3 Voice Amplifiers.	
<input type="checkbox"/> Services	Used to amplify the voice during radio traffic while wearing a		
<input checked="" type="checkbox"/> Goods	SCBA Face piece on the fire ground.		
<input type="checkbox"/> Public Works Construction	GSA Contract - Sourcewell		
<input type="checkbox"/> Other _____			
Justification for Request:			
See attached <u>2</u> page(s) or _____ line item(s) and attached specifications _____ pages			

Budget			
Attach proof of available funds and provide the following:			
Budget Line Item:	Radio Equipment 100-61-3510-52-2209	Cost of goods or services:	\$16,313.25
Funds Available:	\$39,697.05		

Vendor			
New vendors must complete the Vendor/Supplier Information Form and provide a w-9 and E-Verify Affidavit			
Select whether vendor is a new or current vendor of the City and provide the following:			
<input checked="" type="checkbox"/> New	<input type="checkbox"/> Current	Vendor Name:	MES (Municipal Emergency Services)
Current Vendor Number:		01-026760	
If Statewide Contract, provide the following: (Attach one quote. Three quotes are not needed)			
Statewide Contract ID number:		GS-07F-0348V EXPIRES 6/2024	
If Requisition is replacing a current Contract, provide the following:			
Current Contract Number:		877-637-3473	
		Contract Expiration Date:	

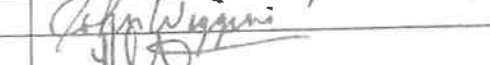
Solicitation			
Complete this section only if a formal bid or RFP advertisement is needed			
Also attach Solicitation Request Form			
Estimated cost of goods or services:	\$16,313.25		
Is cooperative purchase option available?	No		
Date goods or services are needed:	When Available		

Signatures			
Department Head Authorization:		Date:	1/25/2024
Purchasing Authorization:		Date:	1/31/24
Finance Director:		Date:	1-31-24
City Manager:		Date:	2-01-24

- Instructions:**
1. Complete requisition form in its entirety. (No previous version of the Requisition Form will be accepted)
 2. Attach 3 quotes (or justification if 3 quotes could not be obtained) and proof of budgeted funds.
 3. Have New Vendors to send Vendor Information Form, w-9, and E-Verify directly to accountspayable@forestparkga.gov.
 4. Email Requisition form and additional documents to procurement@forestparkga.gov.
 5. Once a fully signed requisition has been returned to you, create PO and proceed with purchase.
 6. Once service is received, submit signed Requisition, invoice, and PO to Accounts Payable (copy Procurement) for payment.

Please complete, sign, and return Requisition Form along with all required documents to procurement@forestparkga.gov
Requisition will not be approved and PO will not be paid if not completed properly.



FOREST PARK