

CITY OF CLEARLAKE

www.clearlake.ca.us



AGENDA

REGULAR MEETING OF THE
CLEARLAKE PLANNING COMMISSIONCLEARLAKE CITY HALL COUNCIL CHAMBERS
14050 OLYMPIC DRIVE
CLEARLAKE, CA 95422

| | | |
|---------|---------------|-----------|
| TUESDAY | March 9, 2021 | 6:00 P.M. |
|---------|---------------|-----------|

On March 12, 2020, Governor Newsom issued Executive Order N-25-20, which allows Planning Commissioners to attend Planning Commission meetings telephonically. Please be advised that some, or all, of the Clearlake Planning Commissioners may attend this meeting telephonically.

Furthermore, on March 17, 2020, Governor Newsom issued Executive Order N-29-20, which waives the mandate of public, in-person accessibility to public meetings provided there are other means for the public to participate. **Effective immediately** and continuing only during the period in which state or local public health officials have imposed or recommended social distancing measures, the Clearlake Planning Commission meetings will be viewable only via livestreaming.

Balancing the health risks associated with COVID-19, while appreciating the public's right to conduct the people's business in a transparent and open manner, the City wants you to know that you can submit your comments and questions in writing for Planning Commission consideration by sending them to the Assistant Planner at sgutierrez@clearlake.ca.us. To give the Planning Commission adequate time to review, please submit your written comments prior to 6:00 p.m. on Tuesday, March 9th.

This meeting, and any future meetings while under a declared emergency, **will not** be viewable in person. You may view the meeting live on YouTube at the City of Clearlake's YouTube Channel (https://www.youtube.com/channel/UCTyifT_nKS-3woxEu1ilBXA) or **Lake County PEG TV Live Stream** YouTube Channel, and you may participate through Zoom <https://clearlakeca.zoom.us/j/95699275174>

CALL TO ORDER

ROLL CALL

_____ Chair Kathryn Davis
 _____ Vice Chair Robert Coker
 _____ Commissioner Lisa Wilson
 _____ Commissioner Erin McCarrick
 _____ Commissioner Fawn Williams

PLEDGE OF ALLEGIANCE

MEETING PROCEDURES

During the March 9th, 2021 Planning Commission meeting, public comment will be accepted via email. If you would like to comment remotely, please follow the protocols

below:

- Send comments via email to the Assistant Planner at sgutierrez@clearlake.ca.us prior to the commencement of the Planning Commission meeting.
- Identify the subject you wish to comment on in your email's subject line.
- Each Public Comment emailed to the Assistant Planner will be read aloud by the Chair or a member of staff for up to three minutes or will be displayed on a screen.
- Public Comment emails received after the beginning of the meeting will not be included in the record.
- Any live comments will be accepted throughout the meeting via Zoom. Staff requests that commenters please utilize Zoom's "hand raise" feature to signify when they would like to speak.

ADOPTION OF THE AGENDA

Notice to the Public

The Planning Commission, when considering the matter scheduled for hearing, will take the following actions:

1. Open the Public Hearing
2. Presentations by Staff
3. Presentation by Applicant or Appellant (if applicable)
4. Accept Public Testimony
5. Applicant or Appellant Rebuttal Period (if applicable)
6. Close the Public Hearing
7. Commissioner Comments and Questions
8. Commissioner Action

Once the hearing is closed, no further public comment will be taken.

If you wish to challenge in court any of the matters on this agenda for which a public hearing is to be conducted, you may be limited to raising only those issues, which you, or someone else, raised orally at the public hearing or in written correspondence received by the city at or before the public hearing.

Public hearings listed for continuance will be continued as noted and posting of this agenda serves as notice of continuance. Any matter not noted for continuance will be posted separately.

PUBLIC HEARING:

1. Conditional Use Permit Applications UP 06-20 Cannabis Cultivation, 07-20 Manufacturing, 08-20 Distribution, 09-20 Nursery, and 10-20 Retail delivery

Recommendation: Adopt PC Resolution 2021-04 approving the above Use Permit Applications, reaccommodating the existing commercial cannabis operation and allowing cultivation, manufacturing, distribution, nursery, and retail delivery to span both parcels of Olympic Plaza, and finding the project exempt from environmental

review (Section 15301. Existing Facilities – Class 1).

2. Development Agreement DA 2021-01 for commercial cannabis within an existing building. Subject use permit is contingent upon City Council approval of the development agreement.

Recommendation: Approve PC Resolution 2021-05 recommending approval of the Development Agreement to the City Council.

CITY MANAGER AND COMMISSIONER REPORTS

FUTURE AGENDA ITEMS

ADJOURNMENT

AMERICANS WITH DISABILITY ACT (ADA) REQUESTS

If you need disability-related modification or accommodation, including auxiliary aids or services, to participate in this meeting, please contact Melissa Swanson, City Clerk, at the Clearlake City Hall, 14050 Olympic Drive, Clearlake, California 95422, phone (707) 994-8201, ext. 106, or via email at mswanson@clearlake.ca.us at least 72 hours prior to the meeting, to allow time to provide for special accommodations.

AGENDA REPORTS

Staff reports for each agenda item are available for review at www.clearlake.ca.us.

Any writings or documents pertaining to an open session item provided to a majority of the Planning Commission less than 72 hours prior to the meeting, shall be made available for public inspection on the City's website at www.clearlake.ca.us.

POSTED: March 5, 2021



Melissa Swanson, City Clerk



**STAFF REPORT
CLEARLAKE PLANNING COMMISSION
For the Meeting of March 9, 2021**

Agenda Item No. 1

To: City of Clearlake Planning Commission
From: Mark Roberts, Senior Planner & Susanna Gutierrez
Application File: Conditional Use Permit UP 06-20, 07-20, 08-20, 09-20 & 10-20
Development Agreement 2021-01
Subject: 1. Use permit for Commercial Cannabis operation in existing buildings;
cultivation, manufacturing, distribution, nursery, and retail delivery.
2. Development Agreement for commercial cannabis within an existing
building. Subject use permit is contingent upon City Council approval of
the development agreement

Data Summary

Location: 14935 & 14915 Olympic Drive, units A, B-2, O, G, H, I, K, M & N
Assessor's Parcel: 039-550-450-000; 039-550-460-000
Applicant: Chandra Martinez
Zoning: Designation: GC, General Commercial
General Plan: Commercial

I. Recommendations:

1. Adopt PC Resolution 2021-04* approving the above Use Permit Applications, reaccommodating the existing commercial cannabis operation and allowing cultivation, manufacturing, distribution, nursery, and retail delivery to span both parcels of Olympic Plaza, and finding the project exempt from environmental review (Section 15301 Existing Facilities – Class 1).
2. Approve PC Resolution 2021-05† recommending approval of the Development Agreement DA 2021-01 to the City Council.

* Attachment 5

† Attachment 6

II. Background/Situation:

- The applicant, Chandra Martinez, is looking to expand their current use permit (UP 16-18) at 14935 Olympic Drive (Olympic Plaza) allowing cannabis cultivation in order to modify the existing site plan and to allow manufacturing, distribution, nursery, and retail delivery spanning both parcels (039-550-450-000; 039-550-460-000).
- This site has gone through multiple public hearings for cannabis use permit applications in recent years (Attachment 1 includes an updated overall layout for review). The units involved in this application previously approved for cannabis operations include:
 - Units A and B2
Applicant: Steven Malone
UP 16-18* *Cultivation*
 - Unit K
Applicant: Brian Galperin (Bliss X)
UP 17-18 *Manufacturing*

Other currently active permits in the plaza (not included in this application):

- Unit B1
Applicant: Gold Country Growers (Bob “Roy” Harris)
UP 10-18 *Distribution*
 - Units C/D and E/F
Applicant: Justin Jones
UP 13-18 *Cultivation*; UP 14-18 *Distribution*
- The parcels (039-550-450-000; 039-550-460-000) are mostly flat, long and rectangular extending about 435 feet from Olympic Drive, each with commercial/industrial corridors with a central parking lot to form what is recognized as “Olympic Plaza.” Owned by Howard Levin, it is located approximately 1.42 miles west of Highway 53 appears compatible with the existing commercial/industrial development surrounding the area. Entry is gained by turning south into the shared parking area (recently restriped) from Olympic Drive. The entire complex consists of four (4) buildings - mostly corrugated metal with concrete slabs - and 14 distinct units, totaling 40,130 square feet.
 - Each of the buildings has external access points. The general public will not be allowed onsite or access to any of the facilities (retail being delivery only). The nearest school and park are 1,000-plus feet away from the site.
 - The applicant’s proposal involves nine (9) of the units, totaling 25,966 square feet. Minor interior and exterior modifications to the units are included and will go through standard building permit review process upon Use Permit approval. No new doors or windows will be closed or created, except where required by the City.

* Later transferred to current applicant Martinez

III. Project Description:

- The City recently adopted regulations addressing commercial cannabis that requires conditional use permits for the following activities:
 1. **Use Permit 06-20 Cannabis Cultivation.** Cultivation: the planting, growing, harvesting, drying, or processing of one or more marijuana plants in any location.
 2. **Use Permit UP 07-20 Manufacturing.** Manufacturing involves the production of tinctures, lotions and edible products, either directly or indirectly or by extraction methods, at a fixed location, and that packages or repackages Cannabis or Cannabis Products or labels or relabels its container.
 3. **Use Permit UP 08-20 Distribution.** Distribution includes procuring Cannabis from permitted Cannabis Cultivation Sites or Cannabis Manufacturers for sale to permitted Cannabis Dispensaries, and the inspection, quality assurance, batch testing by a Type 8 licensee, storage, labeling, packaging and other processes prior to transport to permitted Medical Cannabis Dispensaries.
 4. **Use Permit UP 09-20 Nursery.** Nurseries produce only clones, immature plants, seeds, and other agricultural products used specifically for the planting, propagation, and cultivation of medical cannabis.
 5. **Use Permit 10-20 Retail delivery.** The commercial transfer of cannabis or cannabis products from a licensed or permitted dispensary to a customer. “Delivery” also includes the use by a licensed or permitted dispensary of any technology platform owned or accessed via software license that enables the consumer to arrange for or facilitate the commercial transfer of cannabis by a licensed dispensary or retailer of cannabis or cannabis products.

IV. General Plan, Land Use and Zoning Compliance Consideration:

The site is designated for Commercial land uses in the General Plan, which appears to be consistent with the project.

V. Environmental Determination: Upon review, staff determined the project is Categorical Exempt from the California Environmental Quality Act (CEQA) pursuant to Section 15301 (Existing Facilities – Class 1) as the project will be operating in an existing permitted facility No expansion of the existing facilities will occur at this time.

“Class 1 consists of the operation, repair, maintenance, permitting, leasing, licensing, or minor alteration of existing public or private structures, facilities, mechanical equipment, or topographical features, involving negligible or no expansion of existing or former use. Existing highways and streets, sidewalks, gutters, bicycle and pedestrian trails, and similar facilities (this includes road grading for the purpose of public safety, and other alterations such as the addition of bicycle facilities, including but not limited to bicycle parking, bicycle-share facilities and bicycle lanes, transit improvements such as bus lanes, pedestrian crossings, street trees, and other similar alterations that do not create additional automobile lanes).”

VI. Zoning Code Compliance:

- Ordinance No. 249-2021 recently amended section 18-43.050 (A) of Chapter 18 of the Municipal Code to re-remove the numerical cap on cannabis businesses located within the boundaries of the Commercial Cannabis Combining District Map.
- Use Consistency with the Zoning Code:
 - The project is located in the GC, General Commercial Zoning District and the CB, Commercial Cannabis Combining District. Surrounding uses are mostly comprised of other commercial operations that exist along both sides of Olympic Drive, but does border some residential development located to the south and west of the business complex which may be of some concern. However, the only residential parcel directly neighboring the site is zoned High Density Residential (HDR), whose 191,664 square feet is mostly vacant with the exception of a 2,100 square foot house and 1,200 square foot garage (demolition permit unfinaled but pulled in January of this year).
 - There are no youth facilities, such as schools or parks located nearby. This use permit process provides the Commission the opportunity to consider any comments raised during the public hearing and consider whether or not the proposed cannabis operation is compatible with the neighborhood.
- The applicant's business plan as submitted and conditions of approval as adopted shall fulfill all operating requirements* as specified in section 18-43 of the Zoning Code.

VII. Other Project Considerations:

- Regulatory Permitting: In accordance with section 5-25.030 (a) of the Municipal Code, (Police Regulations), a regulatory permit be first approved by the Planning Commission and then issued by the City Manager. This use permit constitutes the regulatory permit from the Planning Commission for approval of a cannabis operation.
- Development Agreement: In accordance with Section 5-25.030 (b) of the Municipal Code, a development agreement for the commercial cannabis operations is required. A development agreement has been prepared which requires separate Planning Commission review and recommendation to the City Council and is subject to review and recommendation to the City Council. The use permit has been conditioned to not be effective until or unless the development agreement has been adopted by the City Council. The applicant concurs with all provisions of the development agreement.

VIII. Alternatives: The Planning Commission should open and close the public hearing, consider the applicant's, staff's and public comments and then either approve the project by recommendation/adoption of the attached resolutions or decline and provide alternative direction to staff.

* Attachment 3

Attachments:

1. Site Plan
2. Operational plan
3. Operating Requirements
4. Agency Comments
5. Resolution No. PC 2021-04
6. Resolution No. PC 2021-05

Attachment 1: Site Plan

OLYMPIC DRIVE: OVERVIEW

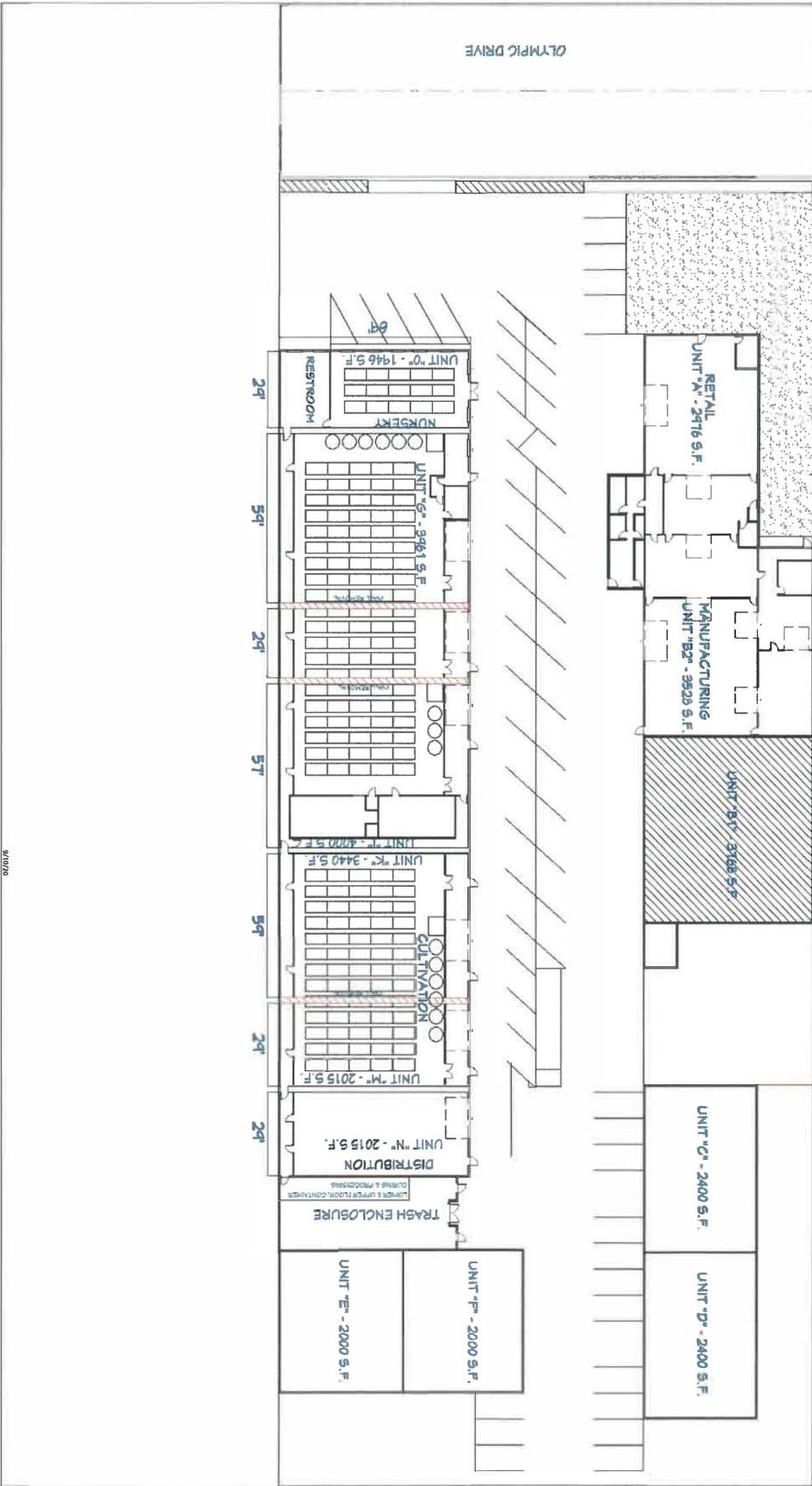

| # | REVISIONS | DATE | BY |
|---|---|------|----|
| 1 | ADDED COLORING ZONE EXISTING BLANDS ALLOCATION. | | |
| | | | |
| | | | |
| | | | |

COPYRIGHT © 2020 HTH CONSTRUCTION
 (707) 533-6121 INFO@HTHCONSTRUCTION.COM

HTH
CONSTRUCTION

TENANT IMPROVEMENT FOR:
 CMS GROUP, LLC
 14915 OLYMPIC DR,
 CLEARLAKE, CA 95422

| | |
|--------------|-------------|
| DRAWN BY | JAN CARROLL |
| CHECKED BY | MARTHA |
| DATE CREATED | |
| DATE ISSUED | 9/10/20 |
| SCALE | AS NOTED |
| PAGE | |

A0-

SHEET OF



FUEGO
— TRIBE —

Square footage of proposed building: _____

Describe the site plan and floor plan (attach additional page if necessary):

See Attached Plan

Number of Managers/Supervisors: **TBD** Number of employees: **TBD**

Names and addresses of anyone who will act as an owner, manager or supervisor of the facility (attach additional page if necessary):

For right now it is myself _____

Describe proposed business and operations (attach additional page if necessary):

See Attached Plan

Anticipated gross annual revenues:

See Attached Plan

DOCUMENTS TO SUBMIT

Please provide additional information as required in Section 18-12.050, 18-12.060, and Section 5-25 including but not limited to the following:

- { } 1. Two passport quality, current photographs of the applicant.
- { } 2. Copy of birth certificate, passport, or valid California Driver's License (not to include an AB60 federally restricted license).
- { } 3. Sign off by Lake County Fire Protection District permitting the use.
- { } 4. The applicant must complete a criminal history check for the State of California and F.B.I. which is approved by the
Chief of Police or his designee.

- { } 5. A sketch or diagram depicting the interior configuration of the premises, including the total floor area, drawn to scale.
- { } 6. A site plan drawing depicting the facility and all properties within 600 feet.
- { } 7. A lighting plan showing existing and proposed exterior and interior lighting placement and levels.
- { } 8. A detailed security plan.
- { } 9. An odor control plan.
- { } 10. A detailed business plan.
- { } 11. Previous addresses for the past five years.
- { } 12. Property ownership and lease details.

AGREEMENT

APPLICANT'S SIGNATURE (Attach Notarized documents)

I hereby certify that I will abide by the City of Clearlake's Commercial Cannabis Ordinance No. 200-2017 and this agreement and that the information provided in this application is, to my knowledge, true and correct. I hereby authorize City staff, including the police department, authority to conduct a criminal background check pursuant to California Penal Code Section 11105(b)(11) and 13300(b)(11), which authorizes city authorities to access state and local summary criminal history information for employment, licensing, or certification purposes; and authorizes access to federal level criminal history information by transmitting fingerprint images and related information to the Department of Justice to be transmitted to the FBI every person listed as an owner manager or supervisor of the marijuana business must submit fingerprints and other information deemed necessary by the City Manager or his designee for a background check by the Clearlake Police Department. I understand that any material misrepresentation may result in either denial or revocation of dispensary permit.

Applicant's Signature:

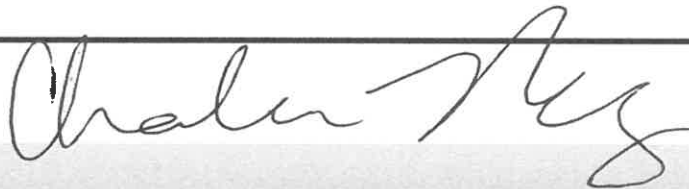

Date:

FOR OFFICE USE ONLY

APPROVED BY: _____

DATE: _____

Credit Card Debit Card Money Order Cash Check # _____

{ } 6. A site plan drawing depicting the facility and all properties within 600 feet.

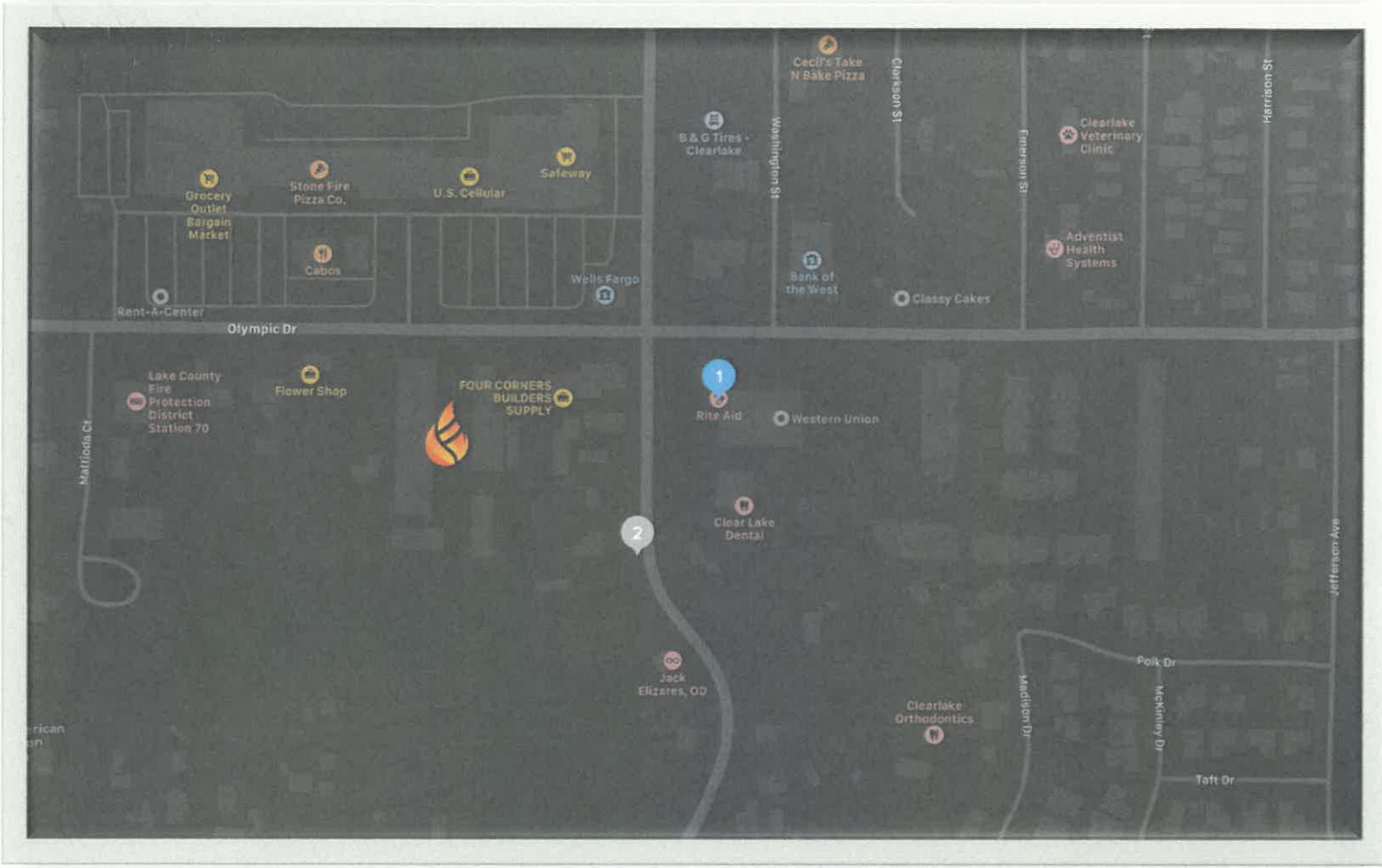

{ } 7. A lighting plan showing existing and proposed exterior and interior lighting placement and levels.

Please see attached site plans from Ruff and Associates.

{ } 8. A detailed security plan.

CANNA SENTRY

CANNA SENTRY provides cannabis related business owners, event promoters, managers and private customers with integrated solutions designed to quickly, efficiently and effectively address any security concerns. The modern world is a frightening place with evolving dangers that pose extremely dangerous security concerns. CANNA SENTRY will address these concerns with customized solutions designed by specialists that represent the best and most up to date talent and technology that can be found in the industry, let alone on the West Coast. CANNA SENTRY provide innovative solutions such as:

- Trained Security – When the cargo or customer needs trained specialists, we're here
- Around the Clock Security – 24/7 security and monitoring
- Commercial & Private Security – Any and all properties of any size
- Event Security – Any size event, from small gatherings to huge, filled arenas.

Over twenty plus years of experience providing security guard services in numerous industries have afforded CANNA SENTRY a broad understanding of security that we depend on to develop and refine our internal best practices from lessons learned. We employ that collective knowhow to deliver our clients with security solutions that fit their individual circumstances and needs.

The cannabis industry has its own unique set of challenges that will continue to change over time. We have created The Green Team as a separate division of Security Resources to service this emerging industry.

The Green Team Provides:

- Fully licensed, trained and insured security officers that meets and exceeds all State and Local requirements.
- Weapons training qualification in each of the following areas: weapons and safety, legal limitations of firearm use, marksmanship and range safety and qualifications on the range.
- Customized post orders, policies and procedures.
- On-going training and re-certifications.
- Security officers that are fully trained and qualified on the actual electronic and physical security systems where they are required to work.

While there may be similarities among different security systems, there can be vast differences in how those systems are utilized. Ultimately, their use is governed based upon the unique circumstances in each facility. This is why we require each of our security officers to be trained on the actual equipment that they will use each and every day.

**DEEP VALLEY SECURITY**

960 N. State St.

Ukiah, CA 95482

Tel: (707)462-5200

Fax: (707)462-1478

*Proposal***Client Information**

FUEGO PREMIUM [BURG]
14935 OLYMPIC DR STE G-O
CLEARLAKE CALIFORNIA 95422

Proposal Number 5665
Date 10/5/2020 **Expires** 11/5/2020
Salesperson JAVIER MORENO

| Qty | Description | Unit Price | Labor | Taxes | Total |
|-----|--|------------|--------|---------|------------|
| 1 | 128 ZONE BURG PANEL, KP, H/W MOTION, (3) RECESSED CONTACTS | \$525.00 | \$0.00 | \$45.94 | \$570.94 |
| 3 | BATTERY-12V, 7AH | \$45.00 | \$0.00 | \$11.81 | \$146.81 |
| 7 | HONEYWELL H/W RECESSED 3/4" CONTACT WHITE | \$35.00 | \$0.00 | \$21.44 | \$266.44 |
| 3 | HONEYWELL ROLL UP DOOR CONTACT | \$45.00 | \$0.00 | \$11.81 | \$146.81 |
| 12 | CONTACT-HONEYWELL WIRELESS DOOR/WINDOW WHITE | \$50.00 | \$0.00 | \$52.50 | \$652.50 |
| 2 | ALPHA ENGLISH KEYPAD HONEYWELL | \$175.00 | \$0.00 | \$30.63 | \$380.63 |
| 1 | 4G LTE COMMUNICATOR (VERIZON) | \$205.00 | \$0.00 | \$17.94 | \$222.94 |
| 3 | MOTION-HONEYWELL WIRELESS PASSIVE INFRARED | \$95.00 | \$0.00 | \$24.94 | \$309.94 |
| 4 | HONEYWELL WIRELESS DUAL-TEC MOTION | \$170.00 | \$0.00 | \$59.50 | \$739.50 |
| 2 | GLASSBREAK-HONEYWELL WIRELESS | \$105.00 | \$0.00 | \$18.38 | \$228.38 |
| 2 | OUTDOOR SIREN 120DB W/CLEAR STROBE | \$125.00 | \$0.00 | \$21.88 | \$271.88 |
| 1 | 12/24VDC 4/3AMP POWER SUPPLY | \$225.00 | \$0.00 | \$19.69 | \$244.69 |
| 1 | ALTRONIX BREAKAWAY RELAY [STOCK] | \$25.00 | \$0.00 | \$2.19 | \$27.19 |
| 2 | RECEIVER HONEYWELL WIRELESS | \$165.00 | \$0.00 | \$28.88 | \$358.88 |
| 2 | HONEYWELL 1-BUTTON PANIC | \$65.00 | \$0.00 | \$11.38 | \$141.38 |
| 1 | MISC LOT OF CONDUIT, BOXES, FITTINGS. | \$275.00 | \$0.00 | \$24.06 | \$299.06 |
| 2 | 18/4 STRANDED WIRE 1000' WHITE | \$265.00 | \$0.00 | \$46.38 | \$576.38 |
| 1 | LABOR CHARGE | \$2,860.00 | \$0.00 | \$0.00 | \$2,860.00 |

Sub Total \$7,995.00
Labor \$0.00
Sales Tax \$449.32
Total This Proposal \$8,444.32

Burglary Alarm

D/C = door contact

R/U = roll up door contact

KP = Keypad

M = Motion sensor

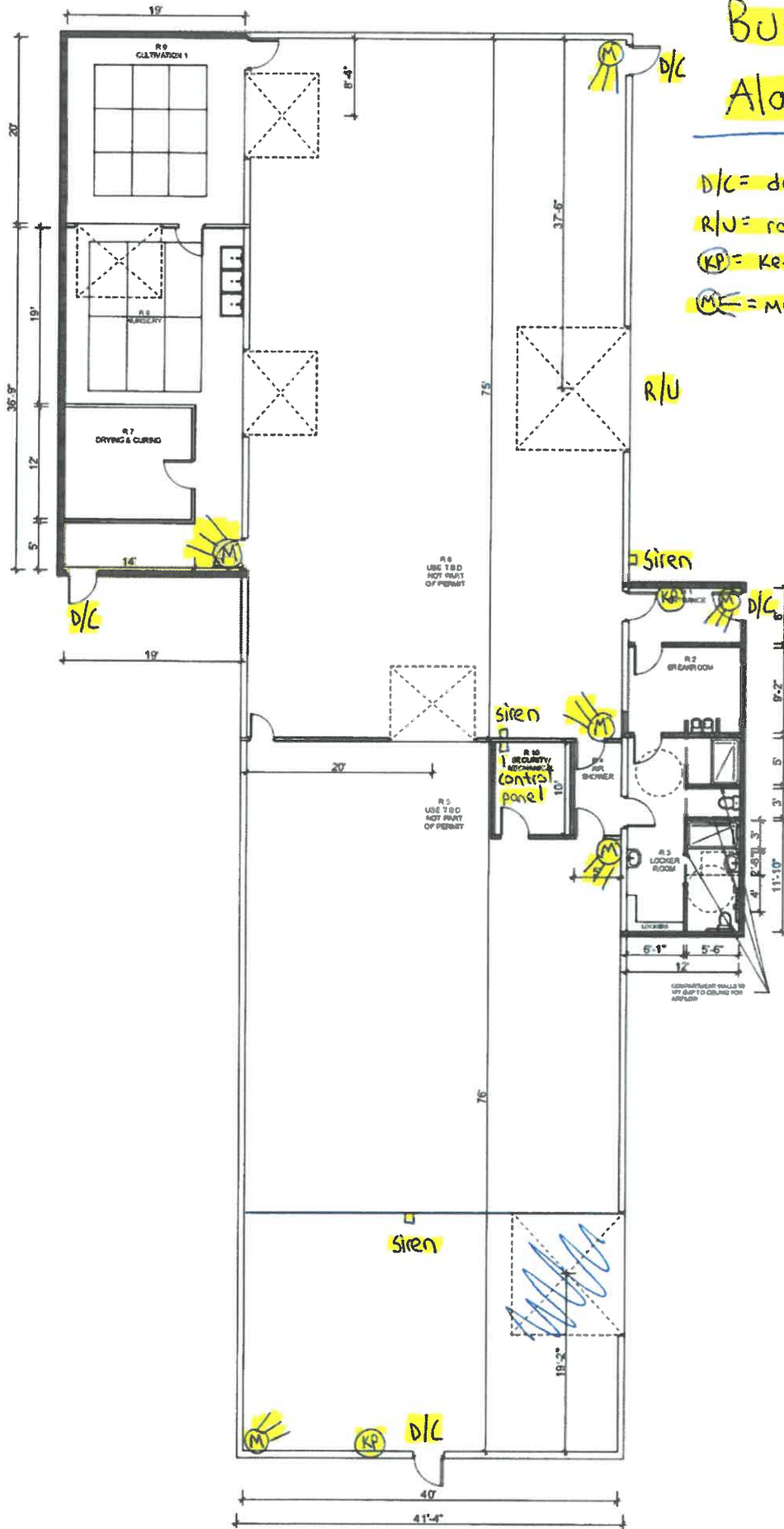

**DEEP VALLEY SECURITY**

960 N. State St.

Ukiah, CA 95482

Tel: (707)462-5200

Fax: (707)462-1478

Proposal**Client Information**

FUEGO PREMIUM [BURG]
14935 OLYMPIC DR STE A-B2
CLEARLAKE CALIFORNIA 95422

Proposal Number 5572
Date 10/5/2020 **Expires** 11/5/2020
Salesperson JAVIER MORENO

| Qty | Description | Unit Price | Labor | Taxes | Total |
|-----|--|------------|--------|---------|------------|
| 1 | 128 ZONE BURG PANEL, KP, H/W MOTION, (3) RECESSED CONTACTS | \$525.00 | \$0.00 | \$45.94 | \$570.94 |
| 3 | BATTERY-12V, 7AH | \$45.00 | \$0.00 | \$11.81 | \$146.81 |
| 1 | ALPHA ENGLISH KEYPAD HONEYWELL | \$175.00 | \$0.00 | \$15.31 | \$190.31 |
| 1 | 4G LTE COMMUNICATOR (VERIZON) | \$205.00 | \$0.00 | \$17.94 | \$222.94 |
| 2 | HONEYWELL H/W RECESSED 3/4" CONTACT WHITE | \$35.00 | \$0.00 | \$6.13 | \$76.13 |
| 1 | HONEYWELL ROLL UP DOOR CONTACT | \$45.00 | \$0.00 | \$3.94 | \$48.94 |
| 2 | MOTION-HONEYWELL WIRELESS PASSIVE INFRARED | \$95.00 | \$0.00 | \$16.63 | \$206.63 |
| 4 | HONEYWELL WIRELESS DUAL-TEC MOTION | \$170.00 | \$0.00 | \$59.50 | \$739.50 |
| 1 | 12/24VDC 4/3AMP POWER SUPPLY | \$225.00 | \$0.00 | \$19.69 | \$244.69 |
| 1 | ALTRONIX BREAKAWAY RELAY [STOCK] | \$25.00 | \$0.00 | \$2.19 | \$27.19 |
| 1 | OUTDOOR SIREN 120DB W/CLEAR STROBE | \$125.00 | \$0.00 | \$10.94 | \$135.94 |
| 2 | INDOOR DUAL TONE WALL SIREN | \$25.00 | \$0.00 | \$4.38 | \$54.38 |
| 2 | RECEIVER HONEYWELL WIRELESS | \$165.00 | \$0.00 | \$28.88 | \$358.88 |
| 2 | HONEYWELL 1-BUTTON PANIC | \$65.00 | \$0.00 | \$11.38 | \$141.38 |
| 1 | CONDUIT, BOXES, FITTINGS. | \$175.00 | \$0.00 | \$15.31 | \$190.31 |
| 1 | 18/4 STRANDED WIRE 1000' WHITE | \$265.00 | \$0.00 | \$23.19 | \$288.19 |
| 8 | CONTACT-HONEYWELL WIRELESS DOOR/WINDOW WHITE | \$50.00 | \$0.00 | \$35.00 | \$435.00 |
| 1 | LABOR CHARGE | \$1,950.00 | \$0.00 | \$0.00 | \$1,950.00 |

Sub Total \$5,700.00
Labor \$0.00
Sales Tax \$328.13
Total This Proposal \$6,028.13

{ } 9. An odor control plan.

Fuego Premium, LLC

Type 3A Cultivation License

Odor Mitigation Executive Summary

Legal Business Name: Fuego Premium LLC

Application Type: Type 3A Medium Indoor Cultivation License Primary Contact Name: Chandra Martinez
Primary Contact Email: Chandra@fuegothc.com Primary Contact Phone: (707) 533-6121

INTRODUCTION TO FUEGO PREMIUM LLC'S ODOR MITIGATION PLAN

Odor Mitigation Plan Executive Summary

Odor Mitigation

The FUEGO PREMIUM facility will contain a three-phase odor reduction system (beyond Best Practices) to eliminate odor within and around our production facility. Cannabis production is organized into a series of separately sealed zones including but not limited to: vegetative, flowering, trimming, curing, storage, processing, and hallways connecting rooms. Within each zone, a predetermine number of activated carbon filters will circulate and scrub the air at a flow rate calculated to filter all the air in the room every 15 minutes. Each zone will maintain neutral air pressure created by exhausting the air through one point at the same rate fresh air enters the zone. The exhaust from each zone is filtered a second time through an activated carbon filter before entering a sealed ducting system to be transferred to a common air bank. Before exiting the building through a filter system, all exhaust is filtered a third time through a series of activated carbon filtration screens thoroughly reducing odor emission rates. In addition, FUEGO PREMIUM will be adding additional ozonation procedures in the sealed HVAC exhausts to additionally mitigate odor.

Step 1: Create sealed zones. Step 2: Exhaust system with neutral pressure systems. Step 3: Three phase odor reduction system

1. Air within zone filtered through activated carbon on a constant basis within grow rooms and other areas on a consistent basis to ensure odor control is clean and constantly maintained inside the facility.
2. Air exhausted from rooms filtered through activated carbon, transferred through sealed ducting system.
3. All exhaust is collected in a common air-bank where it is filtered a third time before leaving the building through an engineered filter system

Fuego Premium is committed to cultivating high quality, safe cannabis and has aligned the Company's ODOR MANAGEMENT AND MITIGATION practices to the regulations set forth by the following governing entities and regulatory documents:

- California Bureau of Cannabis Control ("BCC");
- California Business and Professions Code.
- Local municipality requirements for Cannabis Odor Mitigation

Element Air Wall Mount / Dry Trim Air Purification System - 120V Covers Up To 2,500 Cu. Ft.

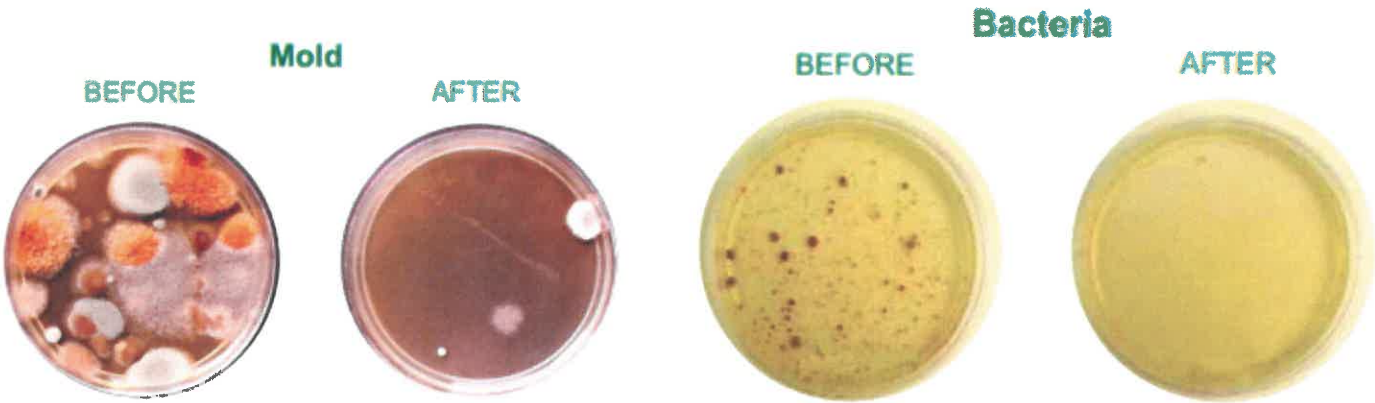

AiroClean420 AIRO-50 - Grow Room Air Sanitation System

A safe alternative for pesticides! The AiroClean 420 processes your contaminated room air and leaves it 99.999987% contaminant free! The AiroClean 420 will effectively eliminate

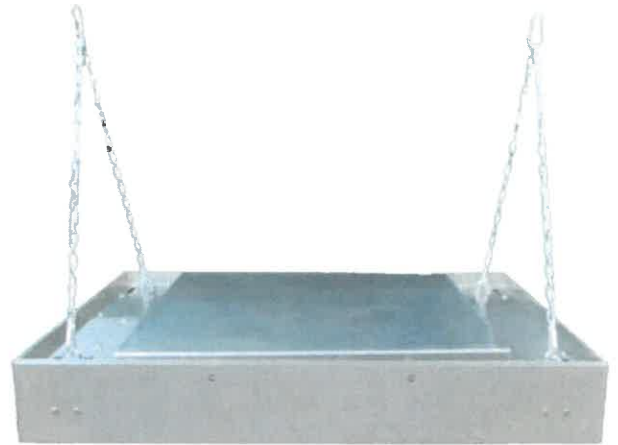

naturally occurring pest!

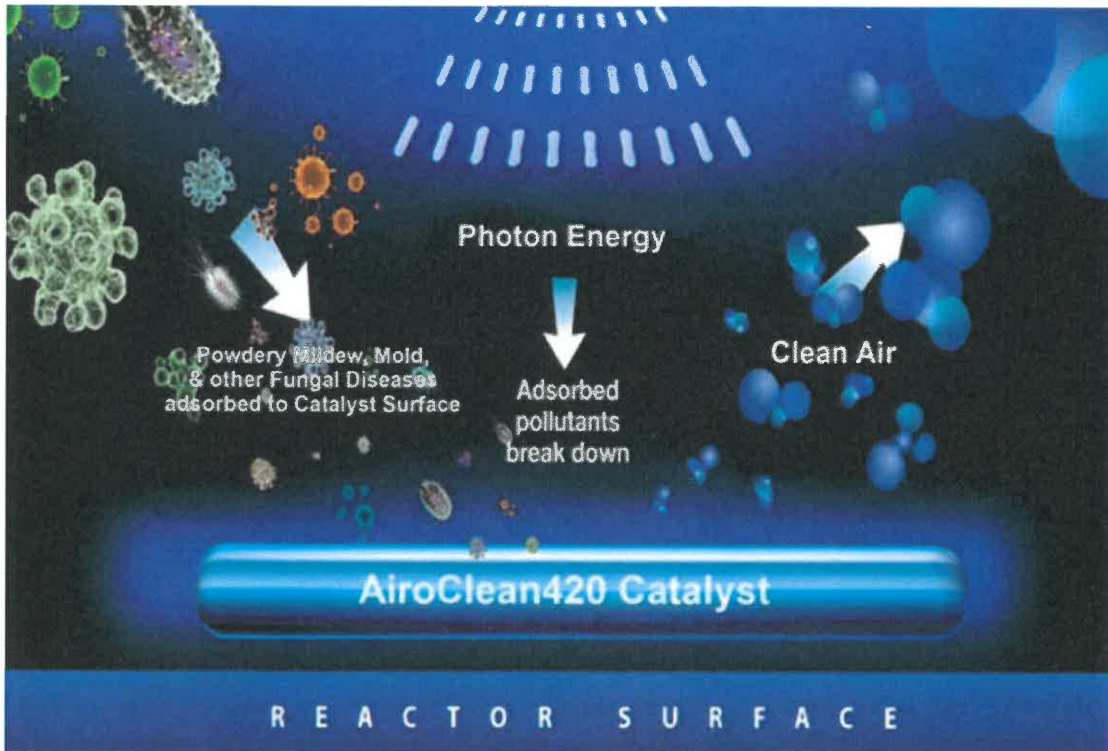

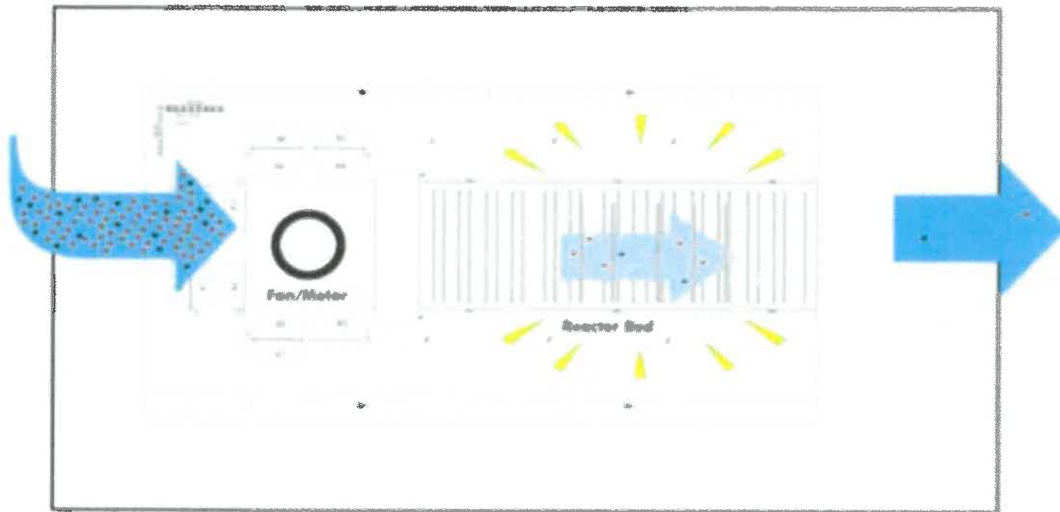

Spore and pathogen-filled air enters through the fan and is pushed into the reactor bed. Spores are **IMMOBILIZED** onto photocatalyst surfaces (and other interior surfaces), are exposed to surface-bound radicals (e.g., hydroxyl radical - OH.) and UVGI.



· Phat Fan - 12 inch 1708 CFM

12 inch 1708 CFM Inline Fan. Tough, Cool & Efficient. Airtight housing for quiet, high flow mixed flow impeller design, stable mounting bracket, ETL Listed.

The Phat Fan is an inline mixed flow fan capable of medium to high static pressure. This line of fans features aerodynamically optimized airflow, quiet operation, and extremely high efficiency. Airtight housing offers streamlined performance while the sleek design offers quiet operation Mixed flow impeller designed for high-flow operation Extreme motor cooling for improved life performance Super-efficient speed controllable motor to better adapt to individual needs Motor safeguarded with thermal overheat protection Stable mounting bracket offers easy installation High performance operation Energy efficient Thermal overload protection UL recognized components 5-year warranty Voltage 120 Diameter 12in Rated Amperage 4.1 Frequency 60Hz Approx. CFM @ 0.0 SP 1708 Rated Wattage 489 RPM 3374



Can-Lite Carbon Filter 12 inch - 1800 CFM

Can Lite Carbon Filters use a finer grade carbon so they are lighter and easier to hang from ceilings as part of your ventilation. The Can Lite 12" carbon filter comes with a 12" flange attached to one side of the carbon filter. Use a fan that's approximately 1800 CFM or less with this filter.



Uvonair 5000 Plus



{ } 10. A detailed business plan.

Fuego Premium, LLC

Cultivation

Emerald Mountain Factory

Non Volatile Manufacturing

Canna Cudo

Nursery

Emerald Mountain Express

Delivery

Emerald Mountain Supply

Distribution

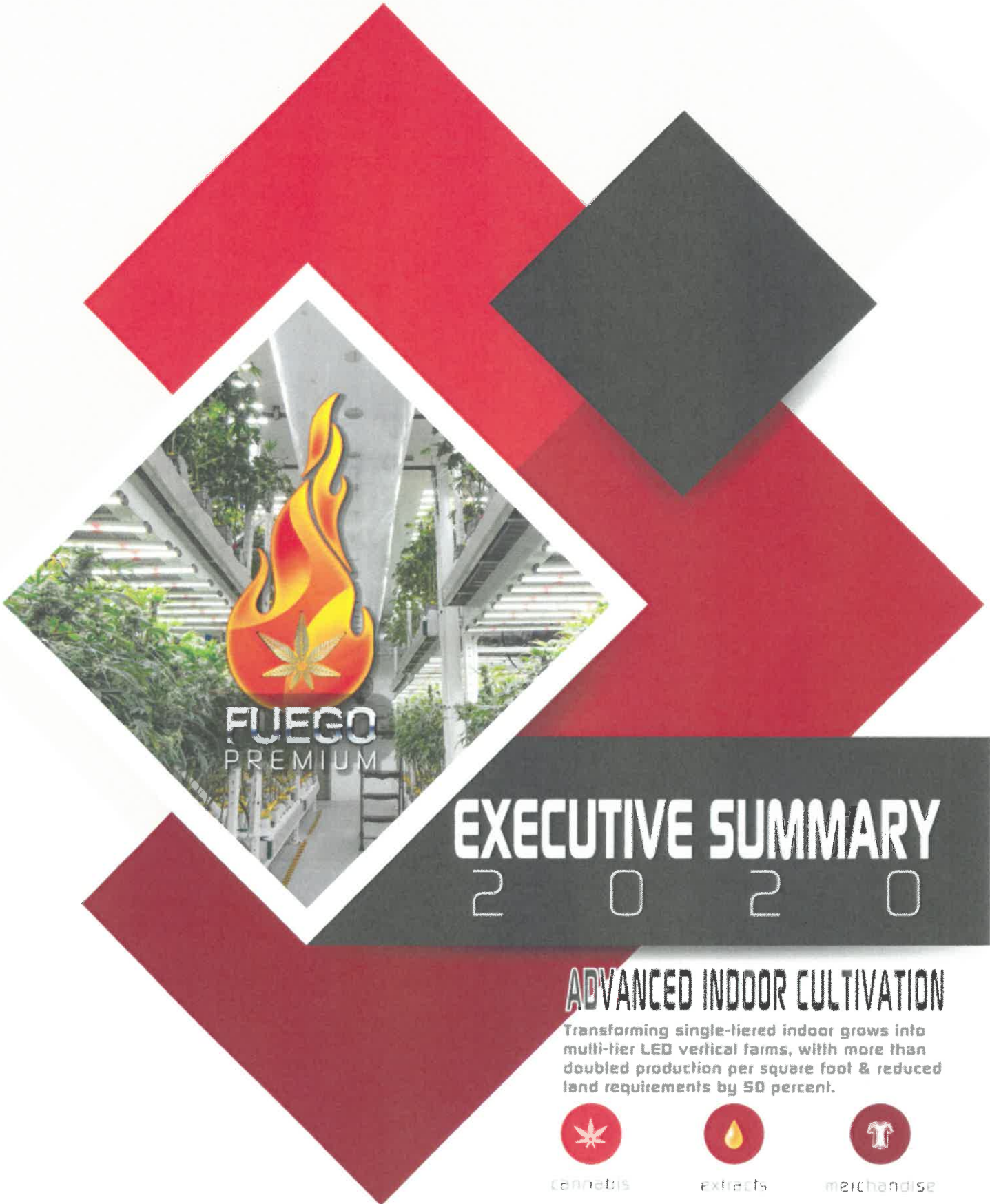

EXECUTIVE SUMMARY

2 0 2 0

ADVANCED INDOOR CULTIVATION

Transforming single-tiered indoor grows into multi-tier LED vertical farms, with more than doubled production per square foot & reduced land requirements by 50 percent.



cannabis



extracts



merchandise



TABLE OF CONTENTS

| | |
|--|----|
| APPLICATION..... | 1 |
| MISSION & VALUES..... | 3 |
| ABOUT FUEGO PREMIUM..... | 3 |
| THE CONCEPT..... | 4 |
| THE CONCEPT ROBOTIC BUILDING..... | 10 |
| THE CONCEPT FUEGO PREMIUM BLUEPRINT..... | 11 |
| MILESTONES..... | 12 |
| STRATEGIC ADVANTAGES..... | 12 |
| COMPETITION..... | 13 |
| SOURCES OF REVENUE..... | 13 |
| MARKETING & STRATEGIC ALLIANCES..... | 13 |
| SALES GOALS..... | 13 |
| FINANCIAL OVERVIEW..... | 14 |

Confidentiality Notice: This document is confidential and contains proprietary information and intellectual property of CMS GROUP, LLC. Neither this document nor any of the information contained herein may be reproduced or disclosed under any circumstances without the express written permission of CMS GROUP, LLC. Please be aware that disclosure, copying, distribution or use of this document and the information contained therein is strictly prohibited.



MISSION & VALUES

OUR PURPOSE

Our purpose is to restore health to people and the planet through the reconnection of Cannabis & Culinary. We're a purpose-driven company that aims to set the standards of excellence for the caregiver's market initiating a specialization in the production, distribution and sales of cannabis drinks.

Quality is a state of mind at **FUEGO PREMIUM**.

OUR CORE VALUES

These core values are the backbone of our company culture and how we aspire to do business every day – with patients, our supplier partners, our customers, communities and each other.

OUR LEADERSHIP PRINCIPLES

We believe that every team member is a leader who is ultimately responsible for customer happiness. We use our leadership principles every day, whether we're discussing ideas for new projects or deciding on the best approach to solving a problem.

OUR DECLARATION OF INTERDEPENDENCE

We recognize the interdependence among our stakeholders – those who benefit or are impacted by our company. Our success is optimized by a win-win-win-win strategy, and all of our stakeholders benefit simultaneously.

ABOUT FUEGO PREMIUM

FUEGO PREMIUM is a unique shopping & education center that focuses on caregiving, nutritional products & services to treat Physical illness symptoms of greater imbalances that may or may not have physical root causes.

FUEGO PREMIUM focuses on "wholistic" healing that addresses all parts of the individual, not just the physical aspect which is often the most apparent. Holistic healing is not intended to serve as a one-time repair. It is rather an ongoing journey in search of more answers and ultimately it leads to better and healthier life with a constant strive for wholeness.

The focus on quality and customer satisfaction will set new standards and heights of expectations in all aspects of products and services to be provided to its patients and patrons from the shops at FUEGO PREMIUM.



THE CONCEPT

We're on the cusp of a major paradigm shift about how to prevent and treat chronic illness. As holistic-leaning modalities garner respect and reach the masses, medical marijuana gains the same traction as a healing modality.

While the science is advancing along with the ground swell of interest and testimonials from consumers, there remains an educational gap among chronic pain patient practitioners.

Patients statewide are asking questions about the appropriate use of cannabis, yet most health + wellness practitioners are at a loss to provide credible answers.

The search ends! **FUEGO PREMIUM**. provides current, evidence-based cancer co-op cannabis manufacturing services, product services, counselling, spa therapy, education via an engaging series of learning options through its integrated network of shops connected and located within the **FUEGO PREMIUM**.

PHAS E ONE: THE FUEGO PREMIUM BUILDING

FUEGO PREMIUM's team of engineers was assembled to create sustainable growing environments by pairing innovative and energy-efficient design with data driven climate control technologies.

We partner with our technology providers to ensure a flourishing year-round production.

We design our hybrid greenhouses with a more sustainable and greener future in mind. At **FUEGO PREMIUM**, care about our environmental impact and understand that many of our clients do too. That's why our number one priority is creating complete, earth-conscious growing systems that use less energy and even function to create more renewable energy. **FUEGO PREMIUM** team of greenhouse designers and engineers will work to come up with a custom greenhouse solution that has minimal environmental impact without sacrificing yield.

- BUILDING DEMO / BUILDING REMEDIATION
- SECURITY SYSTEMS
- MICROBIAL / FIRE PROOF WALL SYSTEMS
- MODULAR FIRE PROOF WALL SYSTEMS
- GREEN ENERGY BACKUP UPGRADE
- GROW RACK SYSTEMS
- MIXED LIGHTING SYSTEMS
- DYNAGLASS CORRUGATED CEILING & WALL PANELS
- ENERGY SYSTEMS
- GEOTHERMAL AC/HEATING SYSTEMS

MASTERGRO W WALL: FIREPROOF, MOLDPROOF, BUGPROOF

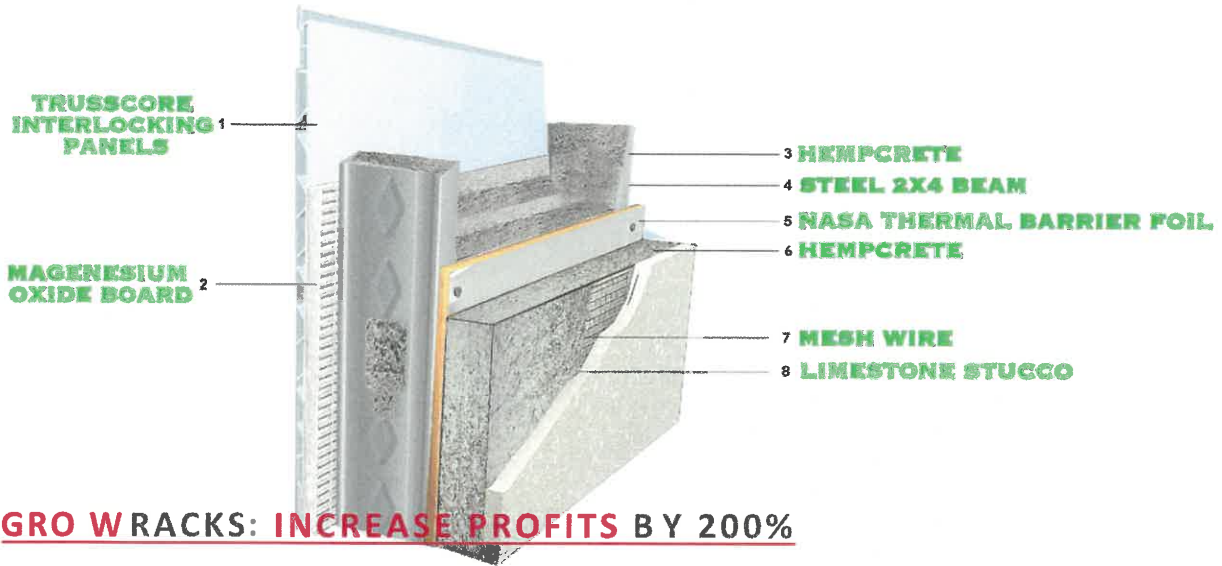

GRO WRACKS: INCREASE PROFITS BY 200%

Specifications:
 Height: 10'
 Size: 8'x4'
 No. of Grow Levels: 3
 Tray: ABS Combination Tray
 Finish: 420 White with Anti-Fungal and Anti-Microbial Finish

Vertical Grow Rack

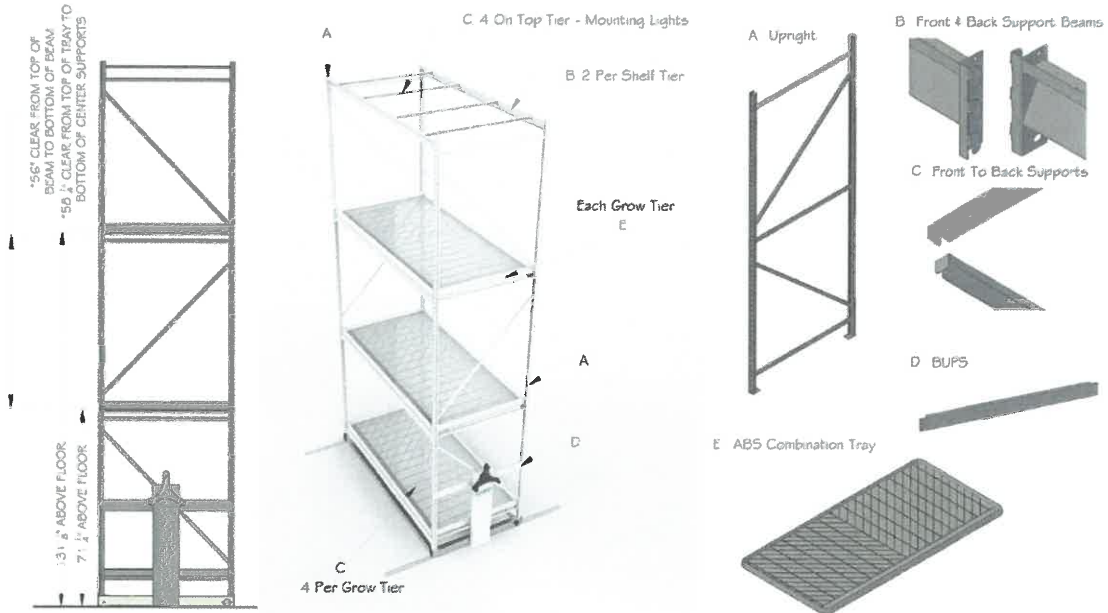

THE ABOVE DIMENSIONS AND SPECIFICATIONS AND IDEAS, DESIGN AND ARRANGEMENTS REPRESENTED THEREIN ARE AND SHALL REMAIN THE PROPERTY OF PIPP MOBILE STORAGE SYSTEMS, AND NO PART THEREOF SHALL BE COPIED, DISCLOSED TO OTHERS OR USED IN THE CONNECTION WITH ANY WORK OR PROJECT OTHER THAN THE SPECIFIC PROJECT FOR WHICH THEY HAVE BEEN PREPARED AND DEVELOPED WITHOUT THE WRITTEN CONSENT OF PIPP MOBILE STORAGE SYSTEMS. VISUAL CONTACT WITH THESE DRAWINGS OR SPECIFICATIONS SHALL CONSTITUTE CONCLUSIVE EVIDENCE OF ACCEPTANCE OF THESE RESTRICTIONS. WRITTEN DIMENSIONS ON THESE DRAWINGS SHALL HAVE PRECEDENCE OVER SCALED DIMENSIONS. NOTE: THIS DRAWING IS PROVIDED FOR INFORMATIONAL PURPOSES ONLY. IF USED FOR CONSTRUCTION, THE CLIENT AND CONTRACTOR ASSUMES ALL RESPONSIBILITY FOR FEDERAL, STATE AND LOCAL CODE COMPLIANCE, ALL DIMENSIONS, PLANS, SPECIFICATIONS ETC. ARE PROVIDED TO OUR CLIENTS BASED UPON INFORMATION PROVIDED BY THE CLIENT AND DRAWN ACCORDANCE WITH REQUIREMENTS PROVIDED BY CLIENT. NONE OF THE EMPLOYEES OF PIPP MOBILE ARE REGISTERED ARCHITECTS, ENGINEERS OR LAND SURVEYORS. ALL DIMENSIONS AND SPECIFICATIONS SHOULD BE VERIFIED BY CLIENT AND/OR CONTRACTOR BEFORE ACTUAL CONSTRUCTION BEGINS. IF DIMENSIONS AND SPECIFICATIONS ARE NOT VERIFIED BY BEST AND/OR CONTRACTOR FOR CODE COMPLIANCE WITHOUT ACTUAL CONSTRUCTION BEGINS, PIPP MOBILE WILL BE HELD HARMLESS. PIPP MOBILE AND ITS AGENTS ASSUME NO LIABILITY FOR FINAL DESIGN, CHANGES AND/OR REVISIONS BASED TO PLANS BY CLIENT AND/OR CONTRACTOR.



ADVANCED LED'S: BY L FLUENCE PART S & PERFORMANCE

ORIGULM®
plant grow lighting

3-Channel Spectrum Tuning
Samsung L8351B 660nm
730nm

Integrated Dimming:
85539PCS lights in 2.6KM
to be dimming



50-277VAC, 3870-4200K hpa,
48VDC output Safety protection
from water spraying

Simple Installation
Each bar supplied with a push
lock, for growers' convenience

Spectrum Irradiance Colorimeter

Digital Wi-Fi
Wired Ethernet



3-Channel Spectral Tuning
Integrated Dimming LED System

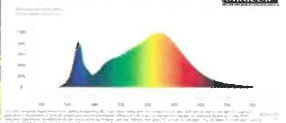

ORIGULM®
plant grow lighting

DIMMING
SPECTRAL TUNING

LED
PLANT GROW LIGHT



◆ Dimming and Tuning LED system
with 3 channels for any plant type
at any stage of growth, from veg.
to bloom.

By WiFi, PWM, or wired Ethernet



◆ Full spectrum: Samsung 3500K,
4500K + CREE 660nm, 730nm.
240-660W, 48VDC output, 90-480VAC,
1530umol/s, 2.3umol/l

◆ LoRa(Long Range) technology
used for WiFi communication and
computer control to realize to make
control of the lights.

65535ers lights around 2-5KM

◆ For growers' convenience of
installation
Each bar with a push lock annexed
with the bracket;
2 notches for freely raising and
lowering the luminaire



for spec, quotations, samples light,
local sales, warranty, please contact
cabin@origulm.net

www.origulm.net

ENERGY STORAGE: SUPER CAPACITOR ADVANCEMENTS

ADVANCED OFFGRID POWER 1.2 MEGA WATTS

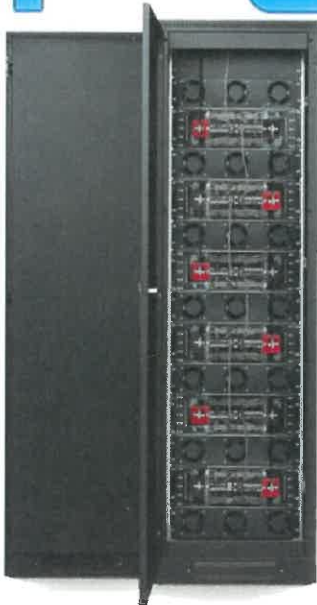

| EXAMPLES OF 8KELGIM SETUPS | | | | |
|-----------------------------|---------|---------|----------|---------|
| Max power** | 1500 kW | 7200 kW | 10800 kW | 5200 kW |
| Max current* | 3000 A | 2900 A | 1500 A | 1600 A |
| Nominal power** | 300 kW | 225 kW | 150 kW | 75 kW |
| Nominal current** | 1200 A | 750 A | 600 A | 250 A |
| Nominal voltage | 672 V | 672 V | 672 V | 672 V |
| Efficiency at Max power | 74.8 % | 81.7 % | 88.8 % | 92.4 % |
| Efficiency at nominal power | 91.7 % | 95.9 % | 97.8 % | 98.8 % |
| Modules in series | 6 | 6 | 6 | 6 |
| Modules in total | 6 | 6 | 6 | 6 |
| Cable in series | 216 | 216 | 216 | 216 |
| Cable in total | 1296 | 1296 | 1296 | 1296 |

*Max power and max current are short period peak power and peak current **Nominal power and current are the rated values for the switchgear used in the system

GEOHERMA LAC/ HEATING: GREEN ENVIORNMENTALS

GEOHERMAL AC/HEATING

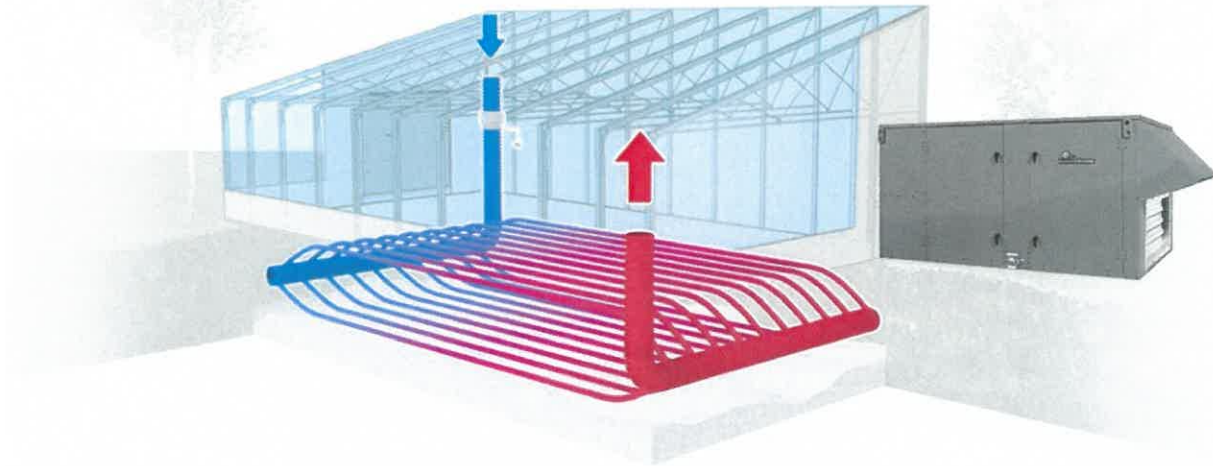

GEOHERMA LAC/ HEATING: GREEN ENVIORNMENTALS





PHASE TWO: ROBOTIC ENVIRONMENTALS

The best kind of climate change: controlled

Atom Controllers provides powerful automation systems for indoor and greenhouse environments.

From single-zone greenhouses to multi-site agriculture operations, Atom enables the modern farm to consolidate dozens of analog systems, collect real-time data, and ensure healthy crops, all for less energy.

Solutions for any grow scenario

Whether building new or retrofitting a current facility, Atom Controllers has you covered. The Atom Integrated in-line power unit is a turn-key contact panel control system for new builds, while the Atom Universal can sit on top of an existing system, giving you full control over any environment.

IOT AUTOMATION ROBOTICS

Know what happens between the grid and the greenhouse. Reduce your highest costs of ownership.

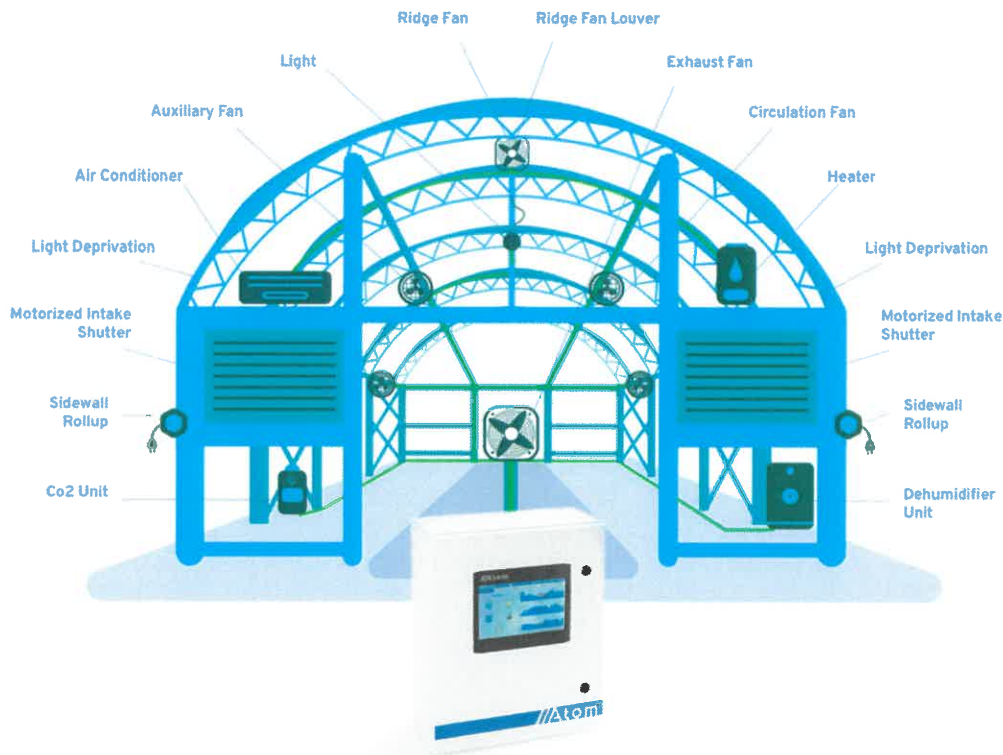



GROW ON- THE- GO: HYBRID CLOUD WEB SERVICES

Set stages, make changes, and pull reports at any time, from anywhere. Never feel out of the loop on your greenhouse again.

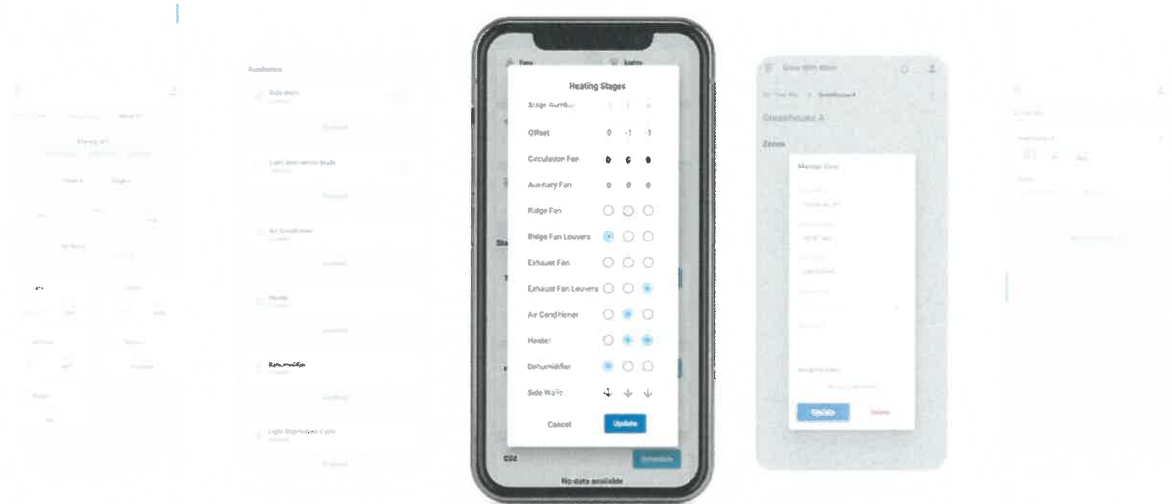

EASILY MONITOR: ANYWHERE, ANYTIME, ANYWAY

Understand your entire operation from a simple overview. Zone by zone, crop by crop, everything you need.

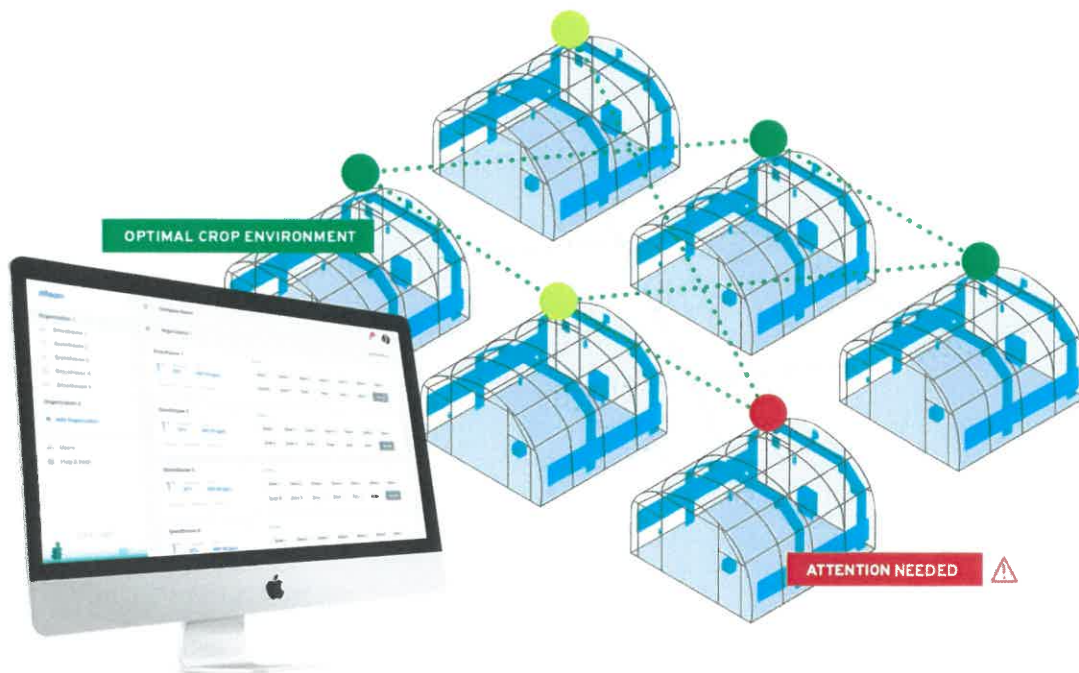



AUTOMATE CLIMATE RECIPES

Be in control of every aspect of your grow. Grow your crops, your way.

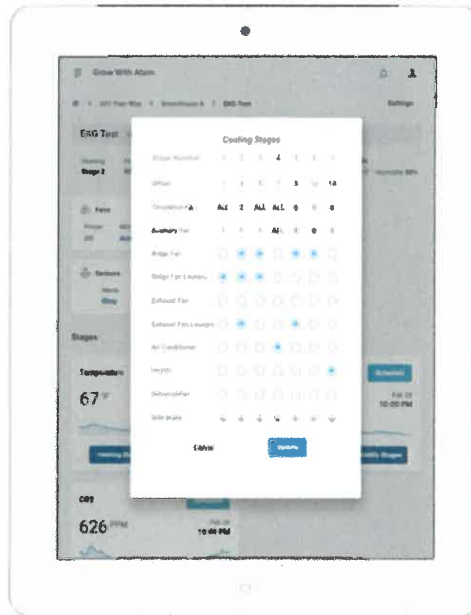

AUTOMATE LIGHTING RECIPES

Specify by Strain lighting treatments to enhance flavors, THC levels, yields and more.





A COMPREHENSIVE APPROACH

Unity is more than a set of solutions. Unity is a process that provides the path forward to meeting your energy savings goals. We work with manufactures, incentive providers and lenders to make it happen.

IT STARTS WITH MEASURING & MONITORING

How do you know what to replace and what to defer? We use data to provide the information you need to make smart decisions. We don't sell you a solution. We show you the math. We provide you with the ROI, payback and financing options that make your decisions easy.

SERVICE OFFERINGS

- **In-depth Building Analysis**
- **UNITY controls Sales & Installation**
- **Certified Test & Balance**
- **Incentive Procurement**
- **Variable Speed Fan Installation**
- **Lighting Upgrades & Retrofits**
- **Customized Integration**
- **Cloud Based Asset Management**

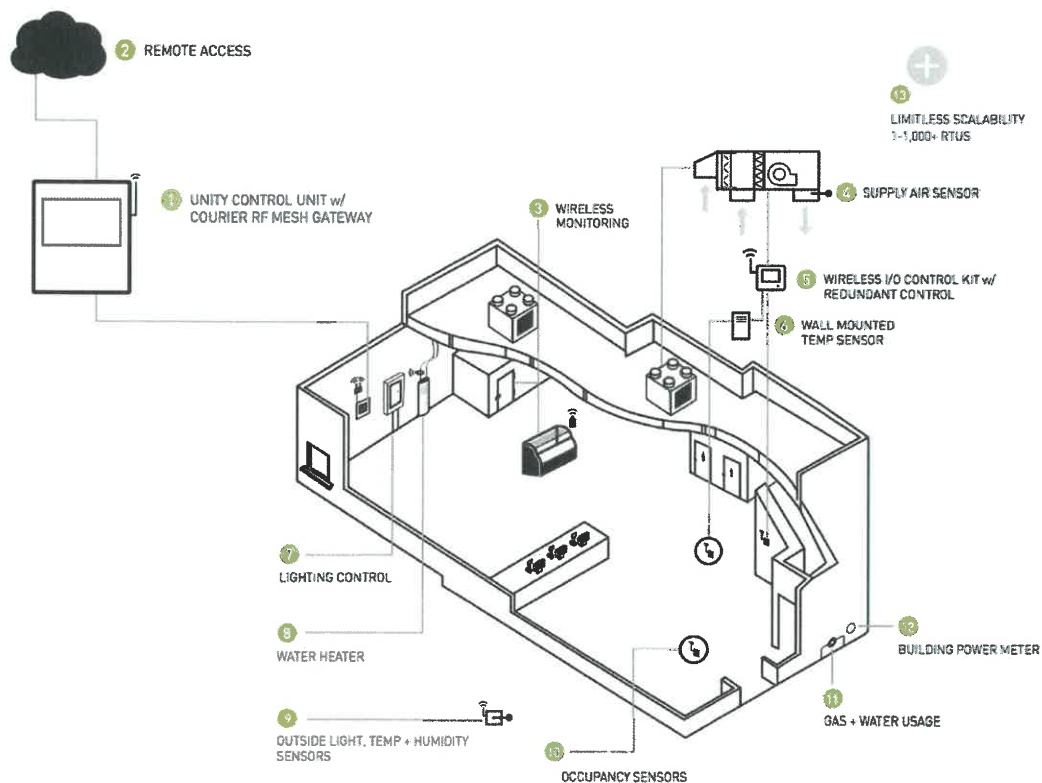



TAKE CONTROL
**IT'S NEVER BEEN
EASIER TO MANAGE
YOUR BUILDING**

Introducing UNITY™, a complete building efficiency solution in one package. HVAC, Lighting, Refrigeration, Air Balance and more UNITY™ does it all.

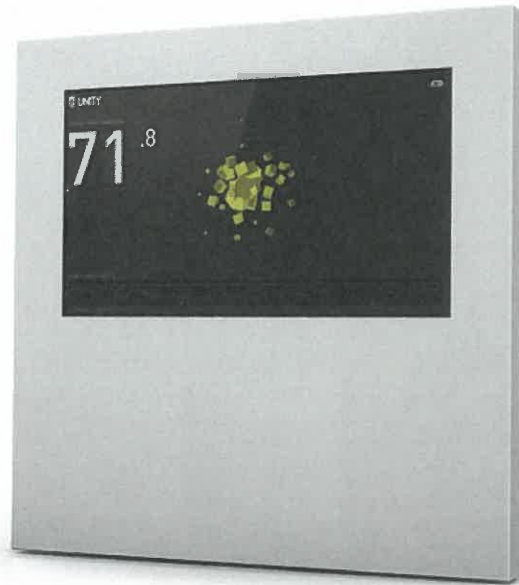

REMOTE ACCESS
**ADJUST, ANALYZE
AND TUNE FROM
ANYWHERE.**

UNITY's Cloud Control provides complete access to your facility via our integrated web dashboard.





WIRELESS MESH
REDUCED INSTALL COSTS AND EASY SET UP

UNITY's patented wireless mesh architecture is the smoothest, fastest most cost effective solution available.

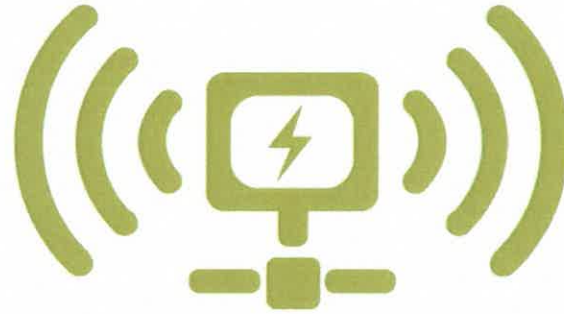

5K - 150K SQ FT
IDEAL FOR SMALL TO MID SIZE COMMERCIAL

UNITY's flexible wireless architecture allows for simplified and cost effective installations in new construction or retrofit projects.

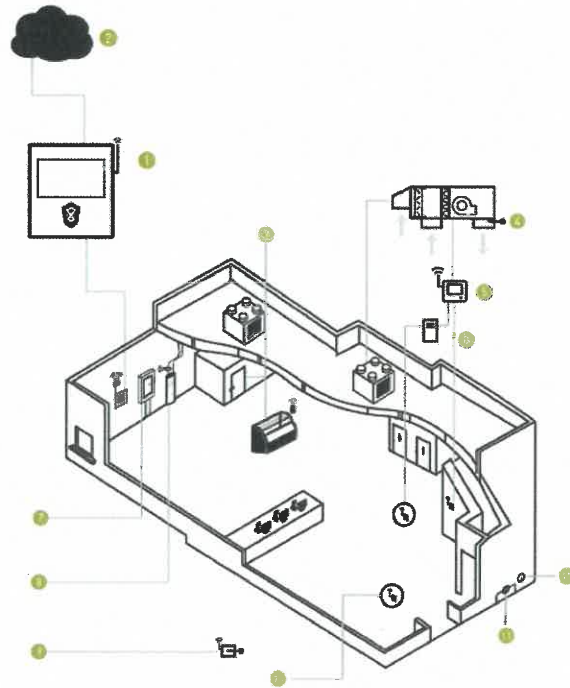

COMPLETE BUILDING AUTOMATION



CLOUD CONTROL

Our remote access dashboard provides complete control of your facility at anytime from anywhere

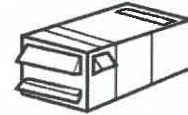

HI-EFFICIENT HVAC

Hi-Efficiency HVAC control system monitors the unique performance capabilities maximizes performance based on real-time conditions.



LIGHTING

Available Lighting packages centralize control and offer multiple automation options for all your lighting needs



REFRIGERATION

Our refrigeration monitoring package with text & email alerts alert you when temperature



KW MANAGEMENT

The kW management package allows you to see real-time energy usage data and easily manage set backs.

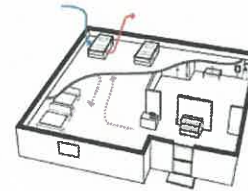

AIR BALANCE

The Economizer & building air-balance package maintains optimal air-pressure in your building greatly reducing heating & cooling waste. drifts and doors are left open.

AUTONOMOUS AGRICULTURE SOLUTIONS

The Future of Farming. Technological innovation in agriculture is rapidly evolving, allowing for farms to move closer to population centers. We can customize solutions for your rooftops, empty lots, or any space you want to transform into a growing facility. Urban farming can increase economic opportunity for both communities and individual businesses, as well as help build stronger social networks and provide economic and health-related growth.

THE FUTURE IN FARMING IS ROBOTICS & WE ARE INTEGRATING & SHAPING ITS FUTURE



INNER CITY CULTIVATION HYBRID BLOOM ROOM

BLOOM ROOM

Specifications:
Height: 12'
Size: 8'x4'
No. of Grow Levels: 3
Tray: ABS Compostion Tray
Finish: K20 White with Anti-Fungal and Anti-Microbial Finish

Vertical Grow Rack

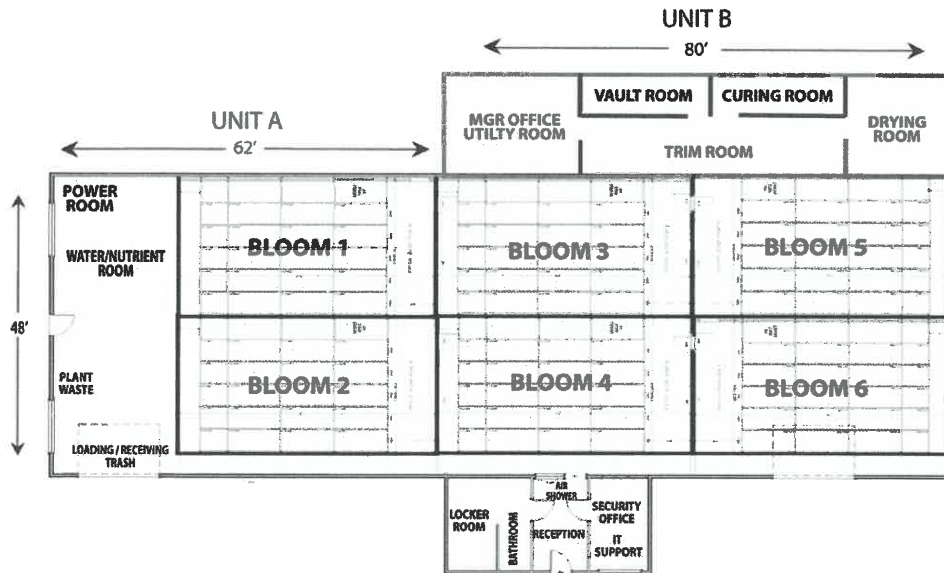
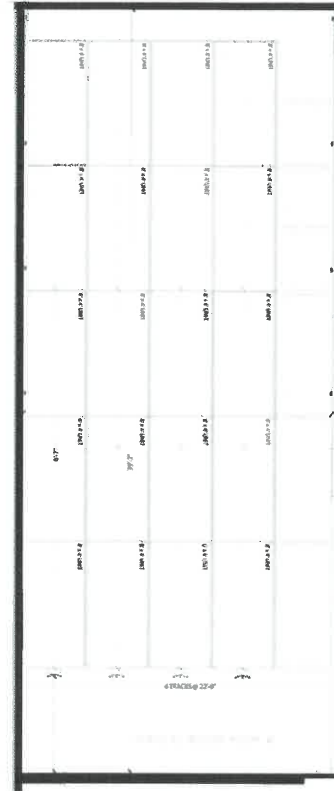
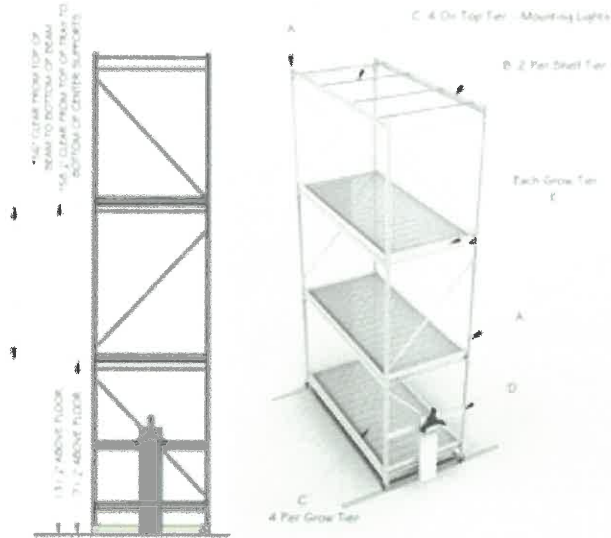



CULTIVATION ACCOUNTING

BLOOM ROOM SPECS

| | |
|--------------|--------------------------------|
| 24 | - ROWS BLOOM 1 |
| 5 | - RACKS PER ROW |
| 120 | - RACKS BLOOM 1 |
| 5 | - 8'X4' TRAYS PER LEVEL |
| 2 | - LEVELS PER RACK |
| 240 | - TRAYS BLOOM 1 |
| 4 | - LIGHTS PER RACK |
| 480 | - LIGHTS BLOOM 1 |
| 24 | - PLANTS PER TRAY |
| 5,760 | - PLANTS BLOOM 1 |

ESTIMATED REVENUE

| | |
|-----------------------------------|-------------------------------------|
| ESTIMATED* 1.5 LBS | PER LIGHT |
| 720 LBS ESTIMATED YIELD | PER ROOM HARVEST |
| \$2,000 PER LB x 720 LBS | \$1,400,000.00 PER HARVEST 1 |
| HARVEST PER MONTH* | \$1,400,000.00 A MONTH |
| ESTIMATED* \$16,800,000.00 | PER YEAR REVENUE |



SALES GOALS

A complete set of financials is found in this Business Plan, but key metrics include:

| | 2021 | 2022 | 2023 |
|-----------------------------------|--------------|---------------|---------------|
| Projected Units produced per Year | 8,640 | 17,080 | 26,020 |
| Delivery Service Members | 100 | 1000 | 5000 |

FINANCIAL OVERVIEW

A complete set of financials is found in this Business Plan, but key metrics include:

| | 2021 | 2022 | 2023 |
|--|------------------------|------------------------|------------------------|
| FUEGO PREMIUM Locations | 1 | 2 | 3 |
| Lake County Location Vert Rack Revenue | \$16,800,000.00 | \$33,600,000.00 | \$50,400,000.00 |
| Distribution Revenue | \$5,000,000.00 | \$10,000,000.00 | \$20,000,000.00 |
| Delivery Services Revenue | \$750,000.00 | \$1,500,000.00 | \$2,500,000.00 |
| Total Revenues (\$) | \$22,550,000.00 | \$45,100,000.00 | \$72,900,000.00 |
| Expenses (\$) | \$2,353,800.00 | \$6,793,058.00 | \$12,339,000.00 |
| Operating profit/loss (\$) | \$20,196,200.00 | \$38,306,942.00 | \$60,561,000.00 |

MANAGEMENT TEAM

Our management team combines the experiences of executives and an advisory board with extensive backgrounds in managing and developing successful businesses within the cultivation and caregiving industries. FUEGO PREMIUM currently has four executives and is in the process of identifying and hiring additional support staff, which will be involved in business development, technical implementation and administration.

Upon obtaining its first round of financing, FUEGO PREMIUM will hire a full-time staff to fully implement the business as outlined in this plan. The Company's executive staff and operations will be in Clearlake, California.

Management, Board of Directors, Advisory Board, and Other Partners For further information please contact:

Chandra



NON-VOLATILE CANNABIS MANUFACTURING
CLEARLAKE, CALIFORNIA

ABOUT EMERALD MOUNTAIN FACTORY

EMERALD MOUNTAIN FACTORY is a unique organic cannabis-infused culinary extraction & Non-Volatile manufacturing center that focuses on farm to market solutions, nutritional products & services to treat Physical illness symptoms of greater imbalances that may or may not have physical root causes. Medicinal & Recreational products are capable to be custom tailored for personal and catering events.

EMERALD MOUNTAIN FACTORY is set to define the culinary infusion of CBD & THC gourmet edibles, cooking sauces, salad dressings, toppings, with endless by products.

We will lead in the organic gourmet culinary infusion revolution with water soluble full spectrum THC & CBD recipes that are focused for the betterment of health in harmony with nature and our bodies.

THE CONCEPT

EMERALD MOUNTAIN FACTORY provides current, evidence-based Bio-Mineral Therapy solutions which are developed as natural vegetation cell food products. A living substance which nourishes the body and detoxifies at the cellular level infused with THC & CBD dosage levels for both patient & recreational consumers.

From cannabis manufacturing (Farms), product processing, extractions, culinary infusions, state distribution, green delivery services, spa therapy, education via our Farmers Market with an engaging series of learning options through its integrated network of shops connected and inter operating with the **EMERALD MOUNTAIN FACTORY**.

The fusion with culinary products, services, organic farmers & ranchers to join in the provision of high-quality organic vegetables, fruits, nuts, meats & dairy that are infused with cannabinoids through either CBD, THC or the combination of both.

Our goal is to make **EMERALD MOUNTAIN FACTORY** the beacon of where to go for every person's everyday needs with cannabis infused Bio-Mineral Therapies through our various natural vegetation cell food products.

The foundation and principles of **EMERALD MOUNTAIN FACTORY** are to provide the highest levels of customer service through our extensively educated representatives at each **EMERALD MOUNTAIN FACTORY SHOP**.

Our Extraction & manufacturing area will include:

- **Non-Volatile C02 Extraction**
- **Concentrate Processing** (Rosin, Shatter, Caviar, etc.)
- **Pre-Rolls Processing**
- **Water Soluable Processing**
- **Culinary Infusion**
- **Drink Manufacturing**
- **Topical Manufacturing**
- **Extraction processing lab**
- **DEA certified storage rooms**

EQUIPMENT

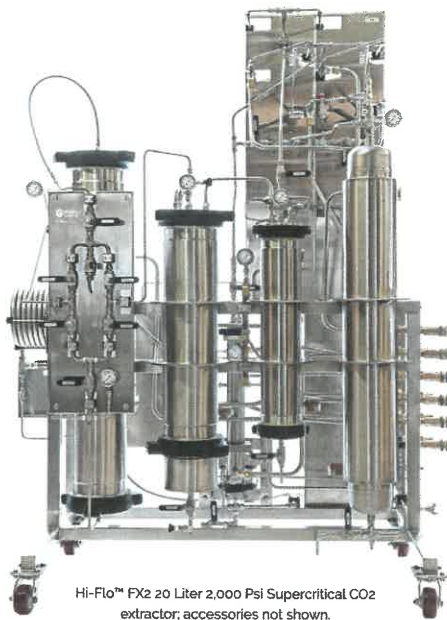

times.

Extraction & Manufacturing Technologies HI-FLO™ FX2 HIGH PERFORMANCE SERIES SUPERCRITICAL CO2 EXTRACTION

The Hi-Flo™ FX2 High Performance Series is our lineup of commercial supercritical extractors capable of processing as much as 107 lbs. biomass daily. With Psi up to 5,000, this series offers best-in-class performance for efficient extraction 24 hours a day, 7 days a week. Our systems comply with US pharmaceutical and nutraceutical requirements. Each is built in accordance with Good Manufacturing Practice (GMP).

The Hi-Flo™ FX2 High Performance Series supports temperature ranges of minus 60 ° C to 60 ° C. Yields are 12 to 25%, depending on material and extraction parameters. Collection cup design keeps oil cool to preserve integrity. Which Psi is right for you? 2,000 Psi is fine for many botanical and whole plant extractions. Higher Psi like 5,000 gives operators greater tunability and faster run

FEATURES & BENEFITS The Hi-Flo™ FX2 High Performance Series has the same reputation for reliability, ease of use, and low-cost maintenance as our Hi-Flo Professional Series. The High Performance Series comes in single 20 Liter and 2 x 20 Liter models. Advanced automation capabilities are available.

With over 20 years of botanical and whole plant extraction expertise, you get fast run times and high yields. Each Eden Labs extractor comes with proven standard operating practices for efficient use and specific products, as well as a three-year warranty.

NON-STOP RELIABILITY

- Engineered for round-the-clock use
- High quality, durable materials such as 316 stainless steel
- Electric pump for quiet, dependable operations
- Temperature and pressure settings from single console panel
- Fast terpene capture with advanced oil integrity cup design
- Rapid change-over for maximum extraction times
- Closed-loop design with up to 95% CO2 recapture rate
- No internal moving parts so fewer points of failure
- Easy step-by-step protocol for upkeep

EQUIPMENT COSTS: \$500,000.00
EQUIPMENT MAINTENANCE: \$45,000.00 /yr

DISTILLATION

VKL 70-5 — SHORT PATH DISTILLATION A TURNKEY SOLUTION

Root Sciences specializes in commercial-scale short path distillation equipment for the cannabis



VK 100-10

industry. Our system can refine cannabis and hemp concentrates into a golden clear distillate that can be infused into a variety of edible products or fine oils to be used in vape cartridges and tinctures.

In our cannabis distillation process we take advantage of the melting points of cannabinoids. By using molecular separation, we can separate the THC from the terpenes, lipids, impurities and solvents, leaving you with an odorless and clear golden distillate. The main advantages to using distillate is that it is safer to smoke, has a much higher potency than extracts or flower and activates immediately after use.

VK 100-10 Stepping up into serious distillation needs, the VK 100-10 can process 2,041 kg per shift and yields 25

to 30 litres. This machine is best suited for processors who need large production. The VK 100 is a bit larger than its smaller counterparts.

Be sure to note the space requirement and differing electrical supply that this machine requires when planning a distillation space.

ADVANTAGES TO USING OUR SYSTEM:

- Continuous feed so you don't have to break vacuum
- Short residence time
- High evaporation rates
- Low processing temperatures
- Compact design
- Cannabinoid separation
- Automated controls
- Fully Jacketed for precise temperature controls
- Included with the VKL 70-5 is the feeding system, short path evaporator with internal condenser, cold trap, discharge systems for distillate and residue, heating and vacuum system

WATER SOLUABLE MANUFACTURING

You do not have to be a scientist to make high-quality water-soluble CBD and THC! Industrial Sonomechanics' customers no longer need to develop their own formulations and production protocols for cannabis extract nanoemulsions. We are pleased to announce the launch of a new product: all-in-one NanoStabilizer™. This convenient product can tremendously simplify the ultrasonic production of high-quality, translucent nanoemulsions of bio-active ingredients such as cannabis extracts. This product is designed to work in conjunction with our laboratory, bench and industrial ultrasonic processors, and comes with detailed, easy-to-follow instructions.

What is NanoStabilizer™?

The new NanoStabilizer™ product is a proprietary blend of food-grade (GRAS) carrier oils, emulsifiers, and preservatives, all derived from natural sources. It contains the entire formulation necessary for producing translucent nanoemulsions of a variety of hydrophobic biologically active ingredients, including cannabis extracts (oils, distillates and isolates), pharmaceuticals and oil-soluble vitamins.

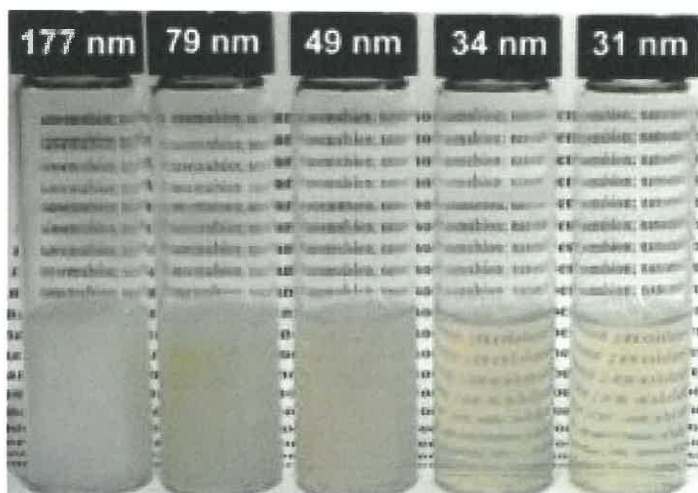

NanoStabilizer™ has practically no taste of its own and yields highly translucent and fully water-compatible nanoemulsions with droplet sizes of about 20 nanometers, ensuring a high bioavailability, accelerated onset of action, and permanent product stability. Loaded with up to 50 mg/ml of cannabinoids and/or other active ingredients, these nanoemulsions can be easily sterilized by filtration and infused into a variety of water-based products without changing their appearance. Finished products made by our customers include CBD and THC-infused beverages (water, tea, coffee, beer, juice, etc.), creams, oral

and nasal sprays, tinctures, tablets, powders, edibles, and many more.

Benefits

- Quickly and easily manufacture water-compatible translucent nanoemulsions loaded with up to 50 mg/ml of cannabinoids and/or other actives.
- Enhance the bioavailability and accelerate the onset of action.
- Ensure precise and reproducible therapeutic dosing.
- Infuse water with a strong medicinal dose while retaining optical clarity.
- Achieve droplet sizes of about 20 - 40 nanometers, ensuring translucency and permanent stability.
- Easily sterile-filter to remove any microbial contamination.

How it works

Translucent nanoemulsions are hard to design – they require optimized carrier oil and surfactant formulations and well-adjusted ultrasonic exposure parameters (amplitude, temperature, exposure time, etc.). With our NanoStabilizer™, ultrasonic equipment, and easy-to-follow processing instructions, these R&D efforts are unnecessary.

What you need to do:

- Follow the provided step-by-step instructions to produce the nanoemulsion.
- Dose the nanoemulsion into your finished product (e.g., beverage, cream, edible).

What you need to have:



- Your active ingredient (e.g., cannabis oil, distillate or isolate)
- Distilled water
- ISM ultrasonic processor
- NanoStabilizer™ (stabilizer package)
- Basic lab equipment (beakers, magnetic stir plate, digital balance)

Industrial-Scale Processor

The ISP-3000 ultrasonic liquid processor is designed for industrial-scale production. It is suitable for working with liquid volumes above 1 L, with no upper limit.

• The ISP-3000 ultrasonic liquid processor is most commonly supplied with a 3000 W ultrasonic generator, water-cooled transducer, half-wave booster half-wave Barbell Horn™ (HBHB), and flow-through reactor chamber (flow cell). Optional items include a half-wave Barbell Horn™ (HBH) and support stand.

- The ISP-3000 processor can be used in batch and flow-through configurations (see schematics on the left). Details are available under the SPECIFICATIONS tab.

The ISP-3000 processor utilizes patented Barbell Horn™ Ultrasonic Technology (BHUT), which makes it possible to generate extremely high ultrasonic amplitudes at any scale of operation. With the ISP-3000, any process optimized with our smaller units, the LSP-500 or BSP-1200, can

PRODUCT LINES

| | |
|--|---|
| <ul style="list-style-type: none">1. EMERALD MOUNTAIN MINTZ2. TERPZ GUSHER GUMZ3. TERPZ POPZ4. CANNABIS CANDIDED BACON5. EMERALD HONEY6. TEA H.C. 7. EMERALD MOUNTAIN DRYHOUSE<ul style="list-style-type: none">- THSEA - www.thsea.com- Candied Salmon- Candied Trout 8. EMERALD MOUNTAIN CHOCOLATIER<ul style="list-style-type: none">- Truffles- Emerald Nutz 9. 707 ELECTRIC DREAMZ<ul style="list-style-type: none">- Purple Punch- Lime Pop- Tangerine Dream- Limoncello- Blueberry Slushy- Fizzy Peach | <ul style="list-style-type: none">10. ALTUM<ul style="list-style-type: none">- Canna Cream- Canna Soap- Canna Balm- Canna Ointments- Cooking Oilz<ul style="list-style-type: none">- Olive (infused*)- Coconut- Grape Seed- Peanut- Sesame- Canola (Vegetable)- Butterz- Salad Dressing<ul style="list-style-type: none">- Mendo Ranch- Strawberry Diesel Vinaigrette 11. HALF BAKED 2GO<ul style="list-style-type: none">- Cookie Dough- Gourmet Biscotti- Cinnamon Rolls- Croissant- Donuts- Cheesecake |
|--|---|

THE COMMUNITY NEED

At **EMERALD MOUNTAIN FACTORY**, regardless of economic status we will support the inclusion of every epileptic, cancer & chronic pain patient who requests assistance with treatment for their chronic debilitating health issues treated with medical cannabis.

At **EMERALD MOUNTAIN FACTORY**, we are looking to establish contributions to the city Clearlake and its surrounding residents by providing on the job training and work closely with the city to find our more immediate needs that are brought to our attention.

MILESTONES

- ESTABLISHED A COMMERCIAL LEASE / PURCHASE AT CLEARLAKE
- SECURED PERMISSION FROM PROPERTY OWNER
- DESIGNED CAD LAYOUT OF THE CURRENT BUILDING
- DESIGNED OPTIMAL GMP CERTIFIED PRODUCTION FACILITIES
- DESIGNED MARKET PLACE INTER-RELATED BUSINESSES
- SECURED LEGAL COUNSEL FOR CANNABIS LICENSING
- SUBMISSION FOR LOCAL NON-VOLATILE MANUFACTURING LICENSE
- SUBMISSION FOR STATE NON-VOLATILE MANUFACTURING LICENSE

STRATEGIC ADVANTAGES

• **Brand Identity** – The custom branded **EMERALD MOUNTAIN FACTORY**, Unique natural environmentally responsible and sustainable green logo, with elegant natural décor at all delivery locations, wellness centers and social media marketing campaigns will create a strong brand Identity.

• **First Mover Advantage** – As a first mover in the cannabis holistic organic grocery food market chain will help us gain the advantage by being the first to market. Being first typically enables a company to establish strong brand recognition and customer loyalty before competitors enter the arena. Other advantages include additional time to perfect its product or service and setting the market price for the new item.

“And it seems Mackey may even be open to a variety of products. When asked whether we would ever see cannabis edibles in a Whole Foods outlet, Mackey said, “Let’s see what happens with the market and the government regulations over time.”

<https://moneymorning.com/2019/03/14/heres-the-thing-about-buying-weed-from-the-grocery-store/>

• **Service marks and Domain Names** – **EMERALD MOUNTAIN FACTORY** has acquired the domain name CannaMarketSquare.com, Foreign Entity Registration in California. Trademarks are published and in the process of being submitted and processed.

• **State Distribution** – **EMERALD MOUNTAIN FACTORY** is geared to acquire a State Distribution license through our Clearlake C4 District, Heavy Commercial, Light Industrial zoned facility for the State of California.

COMPETITION

In general there are no viable competitors in the Market at this time, WHOLE FOODS touched on this subject as is documented in the following article:

“After all, if cannabis were available in major grocery stores, the potential profits for any party involved would be incredible; it would certainly be a turning point in cannabis’ lucrative journey into the American mainstream.”

Source: <https://moneymorning.com/2019/03/14/heres-the-thing-about-buying-weed-from-the-grocery-store/>

With this said, it is a key market indicator of the potential and with First Mover momentum and the proper corporate infrastructure would be poised to lead the market and industry for the world.

SOURCES OF REVENUE

1. CANNABIS LICENSING ASSISTANCE PROGRAM
2. MARKETING & BRANDING SERVICES
3. CANNABIS / CBD FLOWER DISTRIBUTION
4. CANNABIS / CBD FLOWER PACKAGING
5. CANNABIS / CBD DRYING & CURING
6. EDIBLE DISTRIBUTION
7. EDIBLE PACKAGING & LABELING
8. PRODUCT BOXING
9. ISOLATE DISTRIBUTION
10. ISOLATE PACKAGING & LABELING
11. DRINK DISTRIBUTION
12. DRINK PACKAGING & LABELING

MARKETING & STRATEGIC ALLIANCES

Marketing will consist of targeted growers, Farms, Chefs and inventors with proven track records. An extensive screening and acceptance process will take place with only the best of the best taken as clients. Multi-channel social media campaigns along with word of mouth with a clear foundation of a clean, sustainable marketplace that will consolidate the best of premium cannabis, edibles, drinks that will fan the flames of the Cannabis Culinary Revolution.

SALES GOALS

A complete set of financials is found in this Business Plan, but key metrics include:

| | 2020 | 2021 | 2022 |
|--------------------------------|------------------------|------------------------|------------------------|
| Cannabis Flower Distribution | \$2,000,000.00 | \$4,000,000.00 | \$8,000,000.00 |
| Edible Distribution | \$ 1,000,000.00 | \$2,000,000.00 | \$4,000,000.00 |
| Drink Distribution | \$1,200,000.00 | \$2,400,000.00 | \$4,800,000.00 |
| Packaging & Labeling | \$500,000.00 | \$1,000,000.00 | \$2,000,000.00 |
| Boxing Services | \$100,000.00 | \$200,000.00 | \$400,000.00 |
| Marketing Services | \$150,000.00 | \$300,000.00 | \$600,000.00 |
| Multimedia / Branding Services | \$50,000.00 | \$100,000.00 | \$200,000.00 |
| | \$5,000,000.00 | \$10,000,000.00 | \$20,000,000.00 |

FINANCIAL OVERVIEW

A complete set of financials is found in this Business Plan, but key metrics include:

| | 2019 | 2020 | 2021 |
|---------------------------------|----------------|-----------------|-----------------|
| EMERALD MOUNTAIN FACTORY | 1 | 6 | 12 |
| Locations | | | |
| Total Revenues (\$) | \$5,000,000.00 | \$10,000,000.00 | \$20,000,000.00 |
| Expenses (\$) | \$1,500,000.00 | \$3,000,000.00 | \$6,000,000.00 |
| Operating profit/loss (\$) | \$3,500,000.00 | \$7,000,000.00 | \$14,000,000.00 |

MANAGEMENT TEAM

Our management team combines the experiences of executives and an advisory board with extensive backgrounds in managing and developing successful businesses within the cultivation, culinary, engineering & construction and software engineering industries.

EMERALD MOUNTAIN FACTORY currently has four executives and is in the process of identifying and hiring additional support staff, which will be involved in business development, technical implementations and administration.

Upon obtaining the first round of funding, **EMERALD MOUNTAIN FACTORY** will hire a full-time staff to fully implement the business as outlined in this plan. The Company's executive staff and operations will be in Clearlake, California.

Management, Board of Directors, Advisory Board, and Other Partners

For further information please contact:

Chandra Martinez

Founder / General Manager

eMail: chandra@CannaMarketSquare.com

Mobile: (707) 533-6121



EXECUTIVE SUMMARY

CLEARLAKE, CALIFORNIA 2019

TABLE OF CONTENTS

| | |
|--|-----------|
| APPLICATION----- | 1 |
| MISSION & VALUES ----- | 3 |
| ABOUT CANNACUDO ----- | 3 |
| THE CONCEPT ----- | 4 |
| THE CONCEPT MARKET DIRECTORY ----- | 10 |
| THE CONCEPT BLUEPRINT ----- | 11 |
| MILESTONES ----- | 12 |
| STRATEGIC ADVANTAGES ----- | 12 |
| COMPETITION ----- | 13 |
| SOURCES OF REVENUE ----- | 13 |
| MARKETING & STRATEGIC ALLIANCES ----- | 13 |
| SALES GOALS ----- | 13 |
| FINANCIAL OVERVIEW ----- | 14 |
| MANAGEMENT TEAM ----- | 15 |

APPLICATION

PHASE ONE: CUPS active and awaiting construction buildout & final inspections to finalize full activation.

MISSION & VALUES

OUR PURPOSE

Our purpose is to restore health to people and the planet through the reconnection of Cannabis & Culinary. We're a purpose-driven company that aims to set the standards of excellence for the caregiver's market initiating a specialization in the production, distribution and sales of cannabis drinks.

Quality is a state of mind at **CANNACUDO**.

OUR CORE VALUES

These core values are the backbone of our company culture and how we aspire to do business every day — with patients, our supplier partners, our customers, communities and each other.

OUR LEADERSHIP PRINCIPLES

We believe that every team member is a leader who is ultimately responsible for customer happiness. We use our leadership principles every day, whether we're discussing ideas for new projects or deciding on the best approach to solving a problem.

OUR DECLARATION OF INTERDEPENDENCE

We recognize the interdependence among our stakeholders — those who benefit or are impacted by our company. Our success is optimized by a win-win-win-win strategy, and all of our stakeholders benefit simultaneously.

ABOUT CANNACUDO

CANNACUDO will be located in Clearlake, California, and we have been able to lease a facility for 5 years with the option of acquiring the property once the property is put up for sale. The facility is well positioned and it matches the ideal picture of a community delivery and nursery business. We are not going to spend much to face lift the facility. Before taking over the facility, it was used as a delivery shop and remains in good condition.

The business will be launching with just one outlet in Clearlake, but we have plans to open other outlets in key locations around California. CANNACUDO will be involved in the delivery of plants including seedlings, clones, teens & mother plants for the medical & recreational cultivation of marijuana and in future develop an onsite training & certification center for the cultivation of cannabis with certified master growers.

We are in the recreational and medical marijuana nursery business to delivery as permitted by the law in California to our customers at the best genetics and quality plants with lowest prices they can get anywhere in the United States of America. Our employees are well trained and qualified to handle the wide range of customers that we are positioned to serve. We will engage in the sale of both at the counter and online orders. CANNACUDO plans to operate a 24 hours 7 days a week nursery.

We are in business to service both customers and mail order customers and shipping provisions have been finalized through delivery. Our work force is going to be well trained to operate within the framework of our company's corporate culture and also to meet the needs of all our customers. CANNACUDO will ensure that all

our customers are given first class treatment whenever they visit our store.

We have an ERP framework with CRM software that will enable us to manage one on one relationships with our customers no matter how large the number of our customer base grows. In regards to conniseur growers and large cultivation operations, we will ensure that we get our customers involved in the selection of the best strains and genetics that will be on our rack.

THE CONCEPT

PHASE ONE: ADVANCED CORE INFRASTRUCTURE

CANNACUDO 's team of engineers was assembled to create sustainable growing environments by pairing innovative and energy-efficient design with data driven climate control technologies.

We partner with our technology providers to ensure a flourishing year-round production.

We design our hybrid greenhouses with a more sustainable and greener future in mind. At CANNACUDO , care about our environmental impact and understand that many of our clients do too. That’s why our number one priority is creating complete, earth-conscious growing systems that use less energy and even function to create more renewable energy. CANNACUDO team of greenhouse designers and engineers will work to come up with a custom greenhouse solution that has minimal environmental impact without sacrificing yield.

GROW RACK SYSTEMS

Specifications:
 Height: 10'
 Size: 8x4'
 No. of Grow Levels: 3
 Tray: ABS Combination Tray
 Finish: 420 White with Anti-Fungal and Anti-Microbial Finish

Vertical Grow Rack

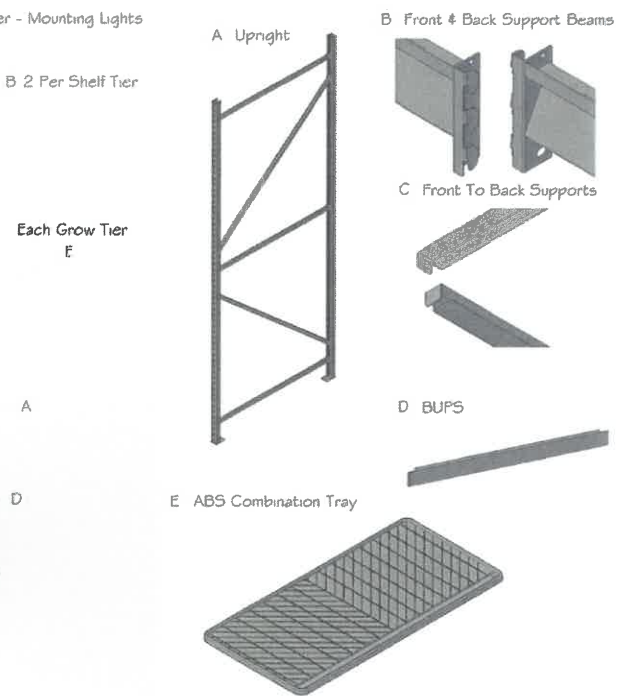
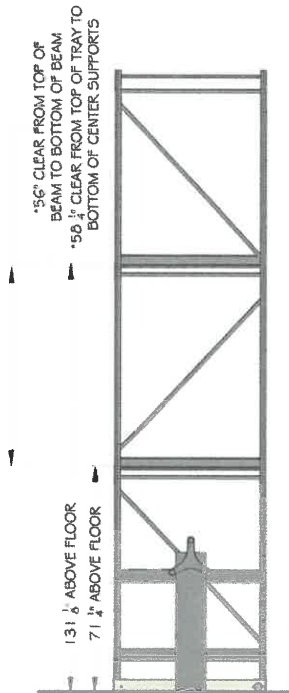

THE ABOVE DRAWINGS AND SPECIFICATIONS AND IDEAS, DESIGNS AND ARRANGEMENTS REPRESENTED THEREBY ARE AND SHALL REMAIN THE PROPERTY OF PIPP MOBILE STORAGE SYSTEMS, AND NO PART THEREOF SHALL BE COPIED, DISCLOSED TO OTHERS OR USED IN THE CONNECTION WITH ANY WORK OR PROJECT OTHER THAN THE SPECIFIC PROJECT FOR WHICH THEY HAVE BEEN PREPARED AND DEVELOPED WITHOUT THE WRITTEN CONSENT OF PIPP MOBILE STORAGE SYSTEMS. VISUAL CONTACT WITH THESE DRAWINGS OR SPECIFICATIONS SHALL CONSTITUTE CONCLUSIVE EVIDENCE OF ACCEPTANCE OF THESE RESTRICTIONS. WRITTEN DIMENSIONS ON THESE DRAWINGS SHALL HAVE PRECEDENCE OVER SCALED DIMENSIONS.
 © 2024 PIPP MOBILE STORAGE SYSTEMS INC.
 NOTE: THIS DRAWING IS PROVIDED FOR INFORMATIONAL PURPOSES ONLY. IT IS NOT TO BE USED FOR CONSTRUCTION. THE CLIENT AND CONTRACTOR ASSUMES ALL RESPONSIBILITY FOR FEDERAL, STATE AND LOCAL CODE COMPLIANCE. ALL DRAWINGS, PLANS, SKETCHES ETC. ARE PROVIDED TO OUR CLIENTS BASED UPON INFORMATION PROVIDED BY THE CLIENT AND DRAWN IN ACCORDANCE WITH REQUIREMENTS PROVIDED BY CLIENT. NONE OF THE EMPLOYEES OF PIPP MOBILE ARE REGISTERED ARCHITECTS, ENGINEERS OR LAND SURVEYORS. ALL DIMENSIONS AND SPECIFICATIONS SHOULD BE VERIFIED BY CLIENT AND/OR CONTRACTOR BEFORE ACTUAL CONSTRUCTION BEGINS. IF DIMENSIONS AND SPECIFICATIONS ARE NOT VERIFIED BY CLIENT AND/OR CONTRACTOR FOR CODE COMPLIANCE BEFORE ACTUAL CONSTRUCTION BEGINS PIPP MOBILE WILL BE HELD HARMLESS. PIPP MOBILE AND ITS AGENTS ASSUME NO LIABILITY FOR FINAL DESIGN, CHANGES AND/OR REVISIONS MADE TO PLANS BY CLIENT AND/OR CONTRACTOR.

MIXED LIGHTING SYSTEMS

GEO THERMAL AC/HEATING

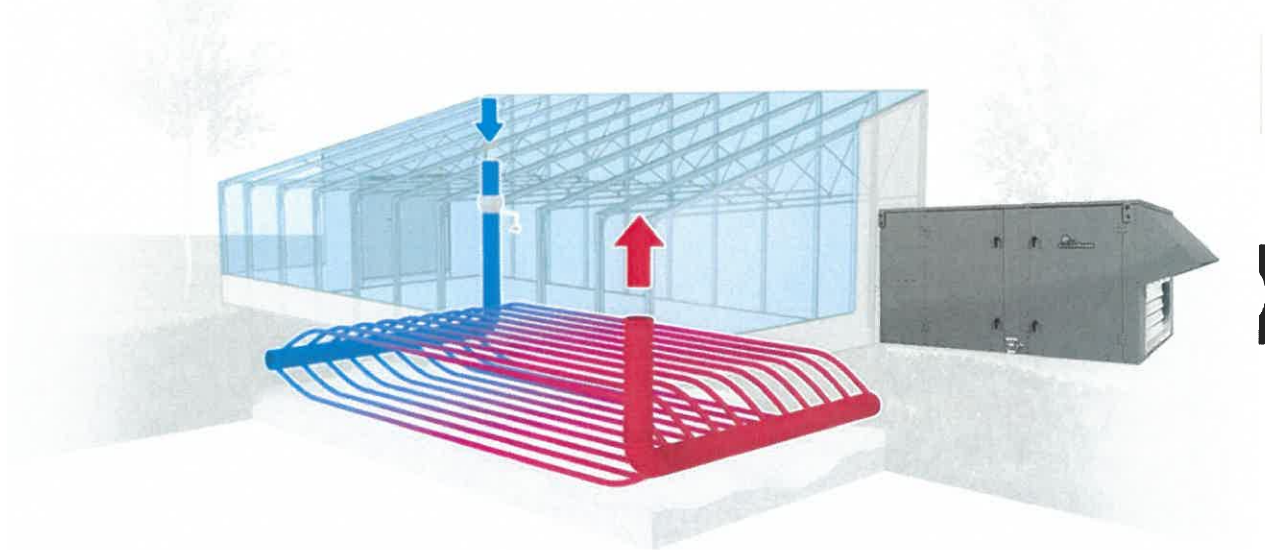

ENERGY SYSTEMS

ADVANCED OFFGRID POWER

1.2 MEGA WATTS

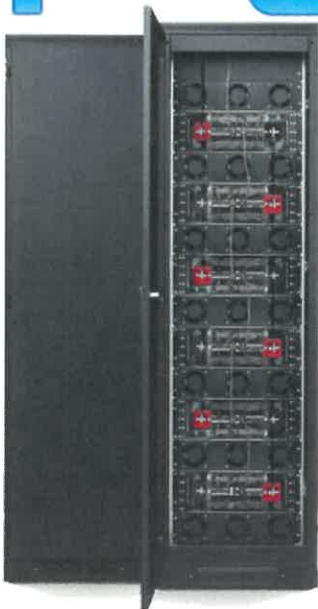

| EXAMPLES OF BRANDED SETUPS | | | | |
|-----------------------------|---------|--------|---------|--------|
| Max power** | 1300 kW | 720 kW | 1050 kW | 570 kW |
| Max current* | 5000 A | 3000 A | 1700 A | 1000 A |
| Nominal power** | 880 kW | 200 kW | 150 kW | 70 kW |
| Nominal current* | 3200 A | 750 A | 500 A | 250 A |
| Nominal voltage | 612 V | 612 V | 612 V | 612 V |
| Efficiency at max power | 74.3 % | 87.9 % | 80.6 % | 82.6 % |
| Efficiency at nominal power | 93.1 % | 95.9 % | 97.2 % | 98.4 % |
| Modules in series | 5 | 5 | 5 | 5 |
| Modules in total | 4 | 4 | 4 | 4 |
| Cable in series | 216 | 216 | 216 | 216 |
| Capacitors | 16.8 F | 16.8 F | 16.8 F | 16.8 F |

*Max power and max current are short period peak power and peak current **Nominal power and current are the rated values for the switchgear used in the system

GEO THERMAL AC/HEATING SYSTEMS

SECURITY SYSTEMS



PHASE TWO: WHAT IF YOUR BUILDING COULD THINK FOR ITSELF WHILE LETTING YOU KNOW WHATS GOING ON?

The best kind of climate change: controlled

Atom Controllers provides powerful automation systems for indoor and greenhouse environments.

From single-zone greenhouses to multi-site agriculture operations, Atom enables the modern farm to consolidate dozens of analog systems, collect real-time data, and ensure healthy crops, all for less energy.

Solutions for any grow scenario

Whether building new or retrofitting a current facility, Atom Controllers has you covered. The Atom Integrated in-line power unit is a turn-key contact panel control system for new builds, while the Atom Universal can sit on top of an existing system, giving you full control over any environment.

Monitor Energy Use

Know what happens between the grid and the greenhouse. Reduce your highest costs of ownership.

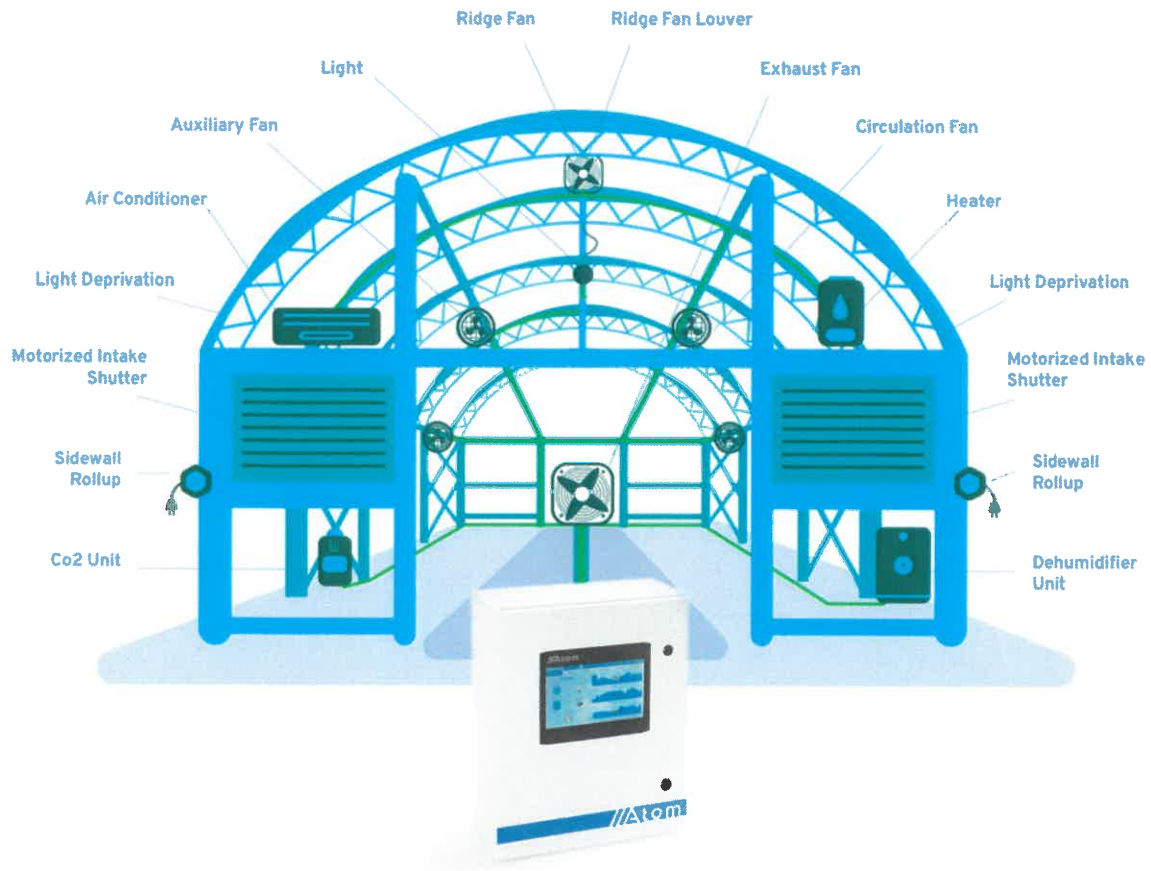

Grow On-the-Go with Atom Cloud

Set stages, make changes, and pull reports at any time, from anywhere. Never feel out of the loop on your greenhouse again.

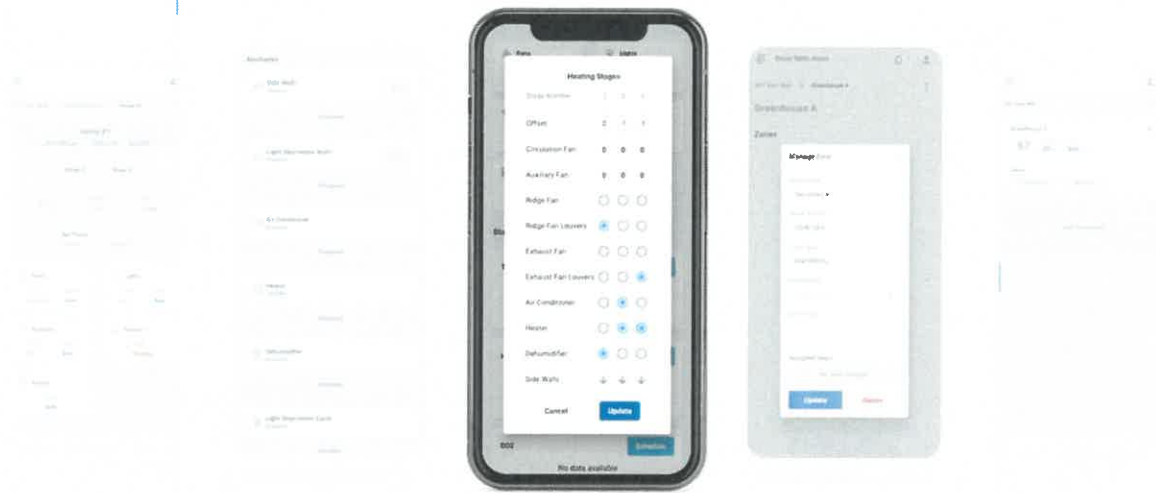

Easily Monitor Operations

Understand your entire operation from a simple overview. Zone by zone, crop by crop, everything you need.



Automate Climate Recipes

Be in control of every aspect of your grow. Grow your crops, your way.

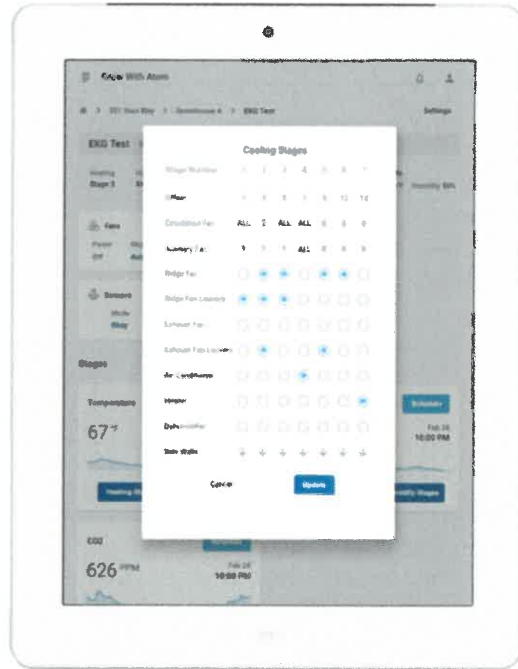

Automate Lighting Recipes

Be in control of every aspect of your grow. Grow your crops, your way.



LIGHT DEP AUTOMATION: Spend time growing, not cranking.

Finally, easily automate your sidewall and light-dep sequences. Let your team get back to the plants

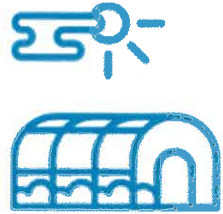

Sidewall Controls



Light-Dep Controls



Temperature Settings



20-Amp DC Output



Multi-day Set Points



Wifi Enabled*

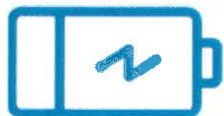

2yr. Battery Backup



75ft Cord

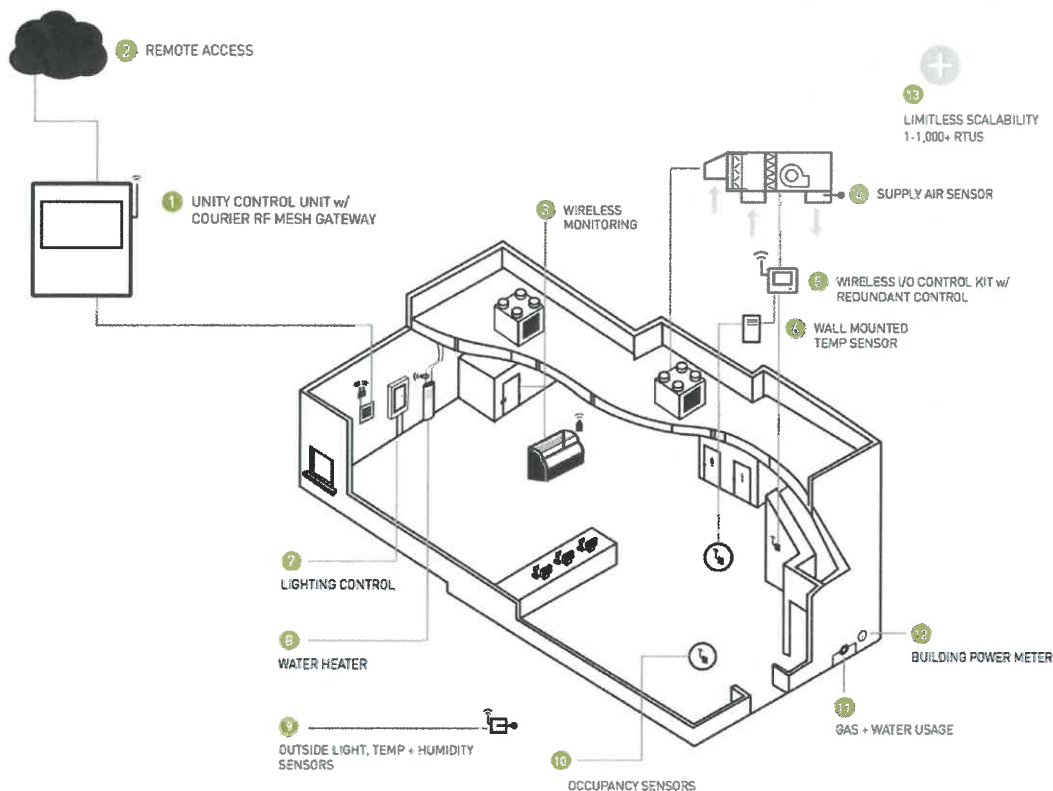

COMPREHENSIVE APPROACH

Unity is more than a set of solutions. Unity is a process that provides the path forward to meeting your energy savings goals. We work with manufactures, incentive providers and lenders to make it happen.

IT STARTS WITH MEASURING & MONITORING

How do you know what to replace and what to defer? We use data to provide the information you need to make smart decisions. We don't sell you a solution. We show you the math. We provide you with the ROI, payback and financing options that make your decisions easy.

SERVICE OFFERINGS

- **In-depth Building Analysis**
- **UNITY controls Sales & Installation**
- **Certified Test & Balance**
- **Incentive Procurement**
- **Variable Speed Fan Installation**
- **Lighting Upgrades & Retrofits**
- **Customized Integration**
- **Cloud Based Asset Management**



TAKE CONTROL IT'S NEVER BEEN EASIER TO MANAGE YOUR BUILDING

Introducing UNITY™, a complete building efficiency solution in one package. HVAC, Lighting, Refrigeration, Air Balance and more UNITY™ does it all.

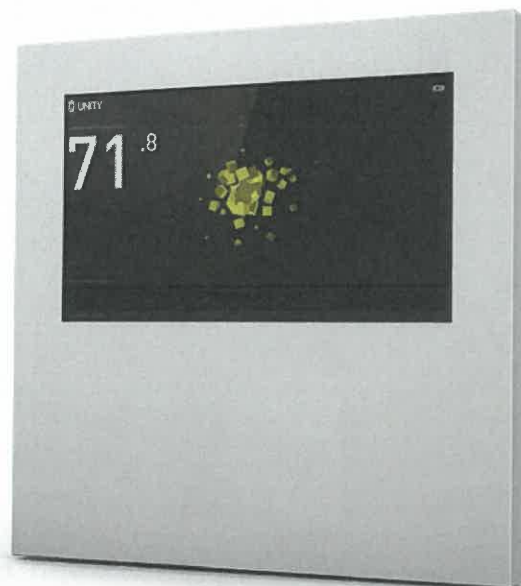

REMOTE ACCESS ADJUST, ANALYZE AND TUNE FROM ANYWHERE.

UNITY's Cloud Control provides complete access to your facility via our integrated web dashboard.



TAKE CONTROL: IT'S NEVER BEEN EASIER TO MANAGE YOUR



WIRELESS MESH
**REDUCED INSTALL
COSTS AND EASY
SET UP**

UNITY's patented wireless mesh architecture is the smoothest, fastest most cost effective solution available.



5K - 150K SQ FT
**IDEAL FOR SMALL
TO MID SIZE
COMMERCIAL**

UNITY's flexible wireless architecture allows for simplified and cost effective installations in new construction or retrofit projects.

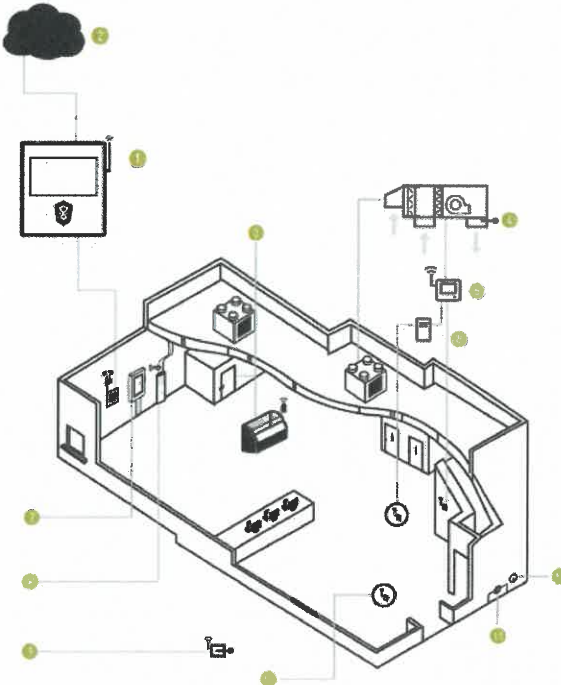

BUILDING



CLOUD CONTROL

Our remote access dashboard provides complete control of your facility at anytime from anywhere.

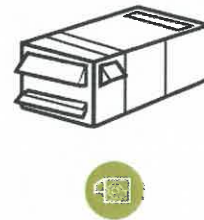

HI-FEC HVAC

Our Hi-Efficiency HVAC control system monitors the unique performance capabilities of each rooftop unit and maximizes performance based on real-time conditions.



LIGHTING

Available Lighting packages centralize control and offer multiple automation options for all your lighting needs.



REFRIGERATION

Our refrigeration monitoring package with text & email alarms alert you when temperature drifts and doors are left open.



KW MANAGEMENT

The kW management package allows you to see real-time energy usage data and easily manage set backs.

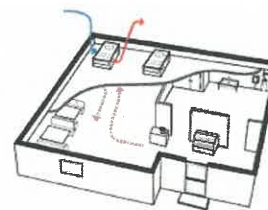

AIR BALANCE

The Economizer & building air-balance package maintains optimal air-pressure in your building greatly reducing heating & cooling waste.

OTHER FEATURES & BENEFITS

MONITORING & ALARMS

UNITY provides continuous insight and visibility into equipment and environmental conditions. Robust data tracking, alerts and detailed reporting features allow you to understand individual unit performance and diagnose issues before they cause costly problems.

EVALUATE ENERGY USE

Validate energy conservation initiatives and uncover additional savings opportunities.

AUTOMATED INTELLIGENT CONTROL

UNITY generates immediate savings by running equipment efficiently, leveraging free cooling, managing air balance and systematically reacting to high demand periods.

EFFICIENCY & PRODUCTIVITY

Total seamless control and remote access to all your temperature and lighting adjustments, schedules, equipment performance and reporting across multiple sites all from one integrated web dashboard.



PHASE THREE: AUTONOMOUS ROBOTIC ASSISTANTS

Canna Sentry has created a comprehensive technology platform to help farmers transition into the digital age with ease. The days of overly complex, and expensive, farm automation systems are giving way to decentralized computing and wireless networks enabled by advancements in Internet-of-Things technology. Canna Sentry exists to help farmers leverage this technology to improve operations and reduce complexity. The Canna Sentry team wants farmers to be able to spend more time on what is most important. We developed our platform with over 20 years of combined team experience managing farming operations, with important features we know growers need.

Our system is designed for any controlled growing environment including greenhouses, hoop houses, indoor farms, grow rooms, prop houses, and commercial vertical farms. Enterprise farm solutions are often too costly for small to mid-size growers, and Canna Sentry can deliver a more affordable solution with similar robust commercial farming functionality. Our wireless, internet-enabled solution is not only easier to install and maintain than other wired solutions, but is also flexible enough to move from one location to another when needed.

The system is flexible enough that you can pick and choose what elements of the Canna Sentry solution meet your needs or even pop open the hood and integrate your custom software and hardware solutions to create the ultimate Master Grow Control system.

In reality, autonomy has many different levels. In designing robotic systems, it's important to determine the level of

autonomy required for each task and ensure that considerations such as cyber security and classification have been fully thought through.

CANNA SENTRY has been at the forefront of establishing frameworks to help us think about appropriate levels of autonomy when applied to different tasks or systems for several years.

Today, smart robots are useful not just for carrying out tasks, but also for building up a digital representation of their environment as they work.

Survey teams at CANNA SENTRY's office in California, USA, proposes to use drones to inspect high voltage transmission facilities for damage during wind events for PG&E. As they go about the task, the drones also map the physical structure using light sensors to create a point cloud. For other facilities, "high density scanning" is used which can create a highly accurate digital model of most structures.

These advanced inspection market systems are what CANNA SENTRY's vision of agricultural monitoring and crop inspections with the following functions in performance:

- **LEAF INSPECTIONS**
- **PEST MANAGEMENT**
- **NUTRIENT DOSSAGING MANAGEMENT**
- **CANOPY MEASURING**
- **CUTTING / CLONING**
- **PLANT THERAPY MANAGEMENT**
- **EQUIPMENT INSPECTIONS**
- **AUGMENTED REALITY REMOTE CONTROL MANAGEMENT**
- **TESTING & TISSUE CULTURE COLLECTION MANAGEMENT**
- **SECURITY & PATROL MANAGEMENT**

PROFITABLE AUTONOMOUS AGRICULTURE SOLUTIONS

The Future of Farming. Technological innovation in agriculture is rapidly evolving, allowing for farms to move closer to population centers. We can customize solutions for your rooftops, empty lots, or any space you want to transform into a growing facility. Urban farming can increase economic opportunity for both communities and individual businesses, as well as help build stronger social networks and provide economic and health-related growth.

PROJECTED MARKET REVENUE POTENTIAL

FREMONT, California, May 7, 2019 /PRNewswire/ -- According to a new market intelligence report by BIS Research, titled 'Global Agriculture Drones and Robots Market - Analysis and Forecast, 2018-2028', the global

market for agriculture drones and robots is projected to grow from \$2.53 billion in 2018 to \$23.06 billion by 2028. The market is expected to witness a CAGR of 24.76% from 2018 to 2028. The high growth in the market is expected to be driven by the need to apply site-specific farming, variable rate application of raw materials and resources as per requirement and decline in agricultural labor across the world.

MILESTONES:

PHASE ONE: ADVANCED CORE INFRASTRUCTURE

- ESTABLISHED A LEASE AT CLEARLAKE LOCATION
- SECURED PERMISSION FROM PROPERTY OWNER
- DESIGNED CAD LAYOUT OF CURRENT BUILDINGS
- DESIGNED OPTIMAL INDOOR GROW SYSTEM CAPACITY
- DESIGNED MARKET PLACE INTER-RELATED BUSINESSES
- SECURED LEGAL COUNSEL FOR LICENSING EXPEDITION
- FORMED LLC IN NEVADA AND REGISTERED IN CALIFORNIA
- SUBMISSION FOR LOCAL OPERATING LICENSE
- SUBMISSION FOR LOCAL CULTIVATOR LICENSE
- SUBMISSION FOR CAREGIVER LICENSE
- SUBMISSION FOR EXTRACTION PROCESSING?
- SUBMISSION FOR DELIVERY SERVICE
- SUBMISSION FOR DISPENSARY STORE FRONT
- SUBMISSION FOR APPROVAL TO LOCAL CITY COUNCIL

STRATEGIC ADVANTAGES

Brand Identity – The custom branded **CANNACUDO**, Unique natural environmentally responsible and sustainable green logo, with elegant natural décor at all delivery locations, wellness centers and social media marketing campaigns will create a strong brand Identity.

Proprietary Technology – The Automated Intelligence Grow Engine for **CANNACUDO** and its correlated market place businesses is complete solution from the ground up from **CANNACUDO** team servicing the first location at Clearlake, California.

Service marks and Domain Names – **CANNACUDO** has acquired the domain name CannaCudo.com to represent the specified services provided to patients and customers within Clearlake, California. Trademarks are submitted and being processed.

Strategic Partnerships – **CANNACUDO** is geared to the expansion of services through the usage and promotions by our strategic partners whom adopt the **CANNACUDO** in locations targeted throughout the state of California.

COMPETITION

Because of prevailing law in California there are presently 15 facilities and 70 or more in the pipe-line.

Should all additional compassion center licenses be granted, they could pose competition.

Indirectly, the Centers faces competition from illegal sales of cannabis, although this is very difficult to quantify because it is a prohibited activity.

SOURCES OF REVENUE

1. **CLONES**
2. **TEENS**
3. **MOTHERS**
4. **CUSTOM GENETICS**
5. **GENETIC PURIFICATION/ENHANCEMENT**
6. **ORGANIC FARM SUPPORT/PARTNERS**

MARKETING & STRATEGIC ALLIANCES

Marketing will consist of word of mouth with a clear foundation of a clean, sustainable market place that will consolidate the best genetics for clones, teens, mothers and vertical nursery services identified.

With that will make strategic partnerships, alliances with key providers of resources that will be needed in order to properly provide clean cost effective operations and growth infrastructures.

SALES GOALS

A complete set of financial s is found in this Business Plan, but key metrics include:

| | 2020 | 2021 | 2022 |
|------------------------------|-----------------------|------------------------|------------------------|
| Clone Sales | 139 | 2000 | 5000 |
| Hydroponics Grow Store Sales | <u>\$2,000,000.00</u> | <u>\$12,000,000.00</u> | <u>\$24,000,000.00</u> |

FINANCIAL OVERVIEW:

A complete set of financials is found in this Business Plan, but key metrics include:

| | 2020 | 2021 | 2022 |
|------------------------------|---------------------|-----------------------|-----------------------|
| Hydroponics Grow Store Sales | \$250,000.00 | \$1,500,000.00 | \$3,000,000.00 |
| CANNACUDO Locations | 1 | 6 | 12 |
| Clone Sales Revenue | \$158,676.80 | \$952,060.80 | \$1,904,121.60 |
| Teen Sales Revenue | \$150,859.04 | \$905,154.24 | \$1,810,308.48 |
| Mother Sales Revenue | \$52,000.00 | \$312,000.00 | \$624,000.00 |
| Custom Genetic Sales Revenue | \$100,000.00 | \$600,000.00 | \$1,200,000.00 |
| Bulk Commercial Revenue | \$600,000.00 | \$3,600,000.00 | \$7,200,000.00 |
| Total Revenues (\$) | \$1,061,535.84 | \$6,369,215.04 | \$12,738,430.08 |
| Expenses (\$) | \$415,000.00 | \$2,490,000.00 | \$4,980,000.00 |
| Operating profit/loss (\$) | \$646,535.84 | \$3,879,215.04 | \$7,758,430.08 |



TABLE OF CONTENTS

| | |
|--|-----------|
| APPLICATION----- | 1 |
| MISSION & VALUES ----- | 3 |
| ABOUT EMERALD MOUNTAIN EXPRESS ----- | 3 |
| THE CONCEPT ----- | 4 |
| THE CONCEPT ROBOTIC BUILDING ----- | 10 |
| THE CONCEPT FACILITY BLUEPRINT ----- | 11 |
| MILESTONES ----- | 12 |
| STRATEGIC ADVANTAGES ----- | 12 |
| COMPETITION ----- | 13 |
| SOURCES OF REVENUE ----- | 13 |
| MARKETING & STRATEGIC ALLIANCES ----- | 13 |
| SALES GOALS ----- | 13 |
| FINANCIAL OVERVIEW ----- | 14 |
| FUNDING & USE OF FUND ----- | 14 |

MISSION& VALUES

OUR PURPOSE

Our purpose is to restore health to people and the planet through the reconnection of Cannabis & Culinary delivery services right to your home. We're a purpose-driven company that aims to set the standards of excellence for the caregiver's market initiating a specialization in the delivery service to home for cannabis and cannabis infused culinary.

OUR CORE VALUES

These core values are the backbone of our company culture and how we aspire to do business every day — with patients, our supplier partners, our customers, communities and each other.

OUR LEADERSHIP PRINCIPLES

We believe that every team member is a leader who is ultimately responsible for customer happiness. We use our leadership principles every day, whether we're discussing ideas for new projects or deciding on the best approach to solving a problem.

OUR DECLARATION OF INTERDEPENDENCE

We recognize the interdependence among our stakeholders — those who benefit or are impacted by our company. Our success is optimized by a win-win-win-win strategy, and all of our stakeholders benefit simultaneously.

ABOUT EMERALD MOUNTAIN EXPRESS

EMERALD MOUNTAIN EXPRESS was formed with a singular vision in mind where there was a cannabis delivery service that could safely and environmentally consciously provide cannabis and cannabis infused culinary delivered to safe and convenient space of your choice.

We will provide services to the lake county area.

SOURCES OF REVENUE

- 7. **ONLINE ORDERING & DELIVERY**
- 8. **CALL IN ORDERING & DELIVERY**
- 9. **MOBILE APP ORDERING & DELIVERY**

THE CONCEPT

As a target there are many patients and customers whom don't have the transportation means or physical capability due to medical conditions. Our goal is to act as the conduit for connecting the products and medicinal services with culinary to be safely and conveniently delivered to a customers' home or safe place.

THE CANNA SENTRY BUILDING



EME's team of engineers was assembled to create sustainable cannabis distribution environments by pairing IOT driven highly secured innovative and energy-efficient building designs with data driven climate control & Enterprise Resource Planning technologies. Self-monitoring & regulating drying & curing automation with live personnel 24/7/365 provides up to the minute support.

We partner with our technology providers to ensure a flourishing year-round production facility & services pipeline.

We design our facilities with a more sustainable and greener future in mind. At EME, we care about our environmental impact and understand that many of our clients do too. That's why our number one priority is creating complete, earth-conscious drying, curing, packaging, storing systems that use less energy and even function to create more renewable energy. EME team of greenhouse designers and engineers will work to come up with a custom cannabis farms all in one solution that has minimal environmental impact without sacrificing quality.

- **24/7/365 AI CAMERAS AND ONSITE ARMED SECURITY**
- **PERSONAL ACCESS CONTROLLED UNITS**
- **CANNABIS HUMIDOR CLIMATE CONTROLLED ENVIRONMENT & ALERT SYSTEM**
- **GREEN ENERGY POWERED SYSTEMS**
- **24/7/365 ONSITE DRYING & CURING STAFF**
- **METRC COMPLIANT TRACKING SOFTWARE INTEGRATION**
- **ERP INTEGRATION / COMPLETE BUSINESS AUTOMATION**

With this said, it is a key market indicator of the potential and with First Mover momentum and the proper corporate infrastructure would be poised to lead the market and industry for the world.

MARKETING & STRATEGIC ALLIANCES

Marketing will consist of targeted growers, Farms, Chefs and inventors with proven track records. An extensive screening and acceptance process will take place with only the best of the best taken as clients. Multi-channel social media campaigns along with word of mouth with a clear foundation of a clean, sustainable marketplace that will consolidate the best of premium cannabis, edibles, drinks that will fan the flames of the Cannabis Culinary Revolution.

SALES GOALS

A complete set of financials is found in this Business Plan, but key metrics include:

| | 2021 | 2022 | 2023 |
|--------------------------------|------------------------|------------------------|------------------------|
| Online Orders | \$2,000,000.00 | \$4,000,000.00 | \$8,000,000.00 |
| Mobile App Delivery | \$ 1,000,000.00 | \$2,000,000.00 | \$4,000,000.00 |
| Phone In Delivery | \$1,200,000.00 | \$2,400,000.00 | \$4,800,000.00 |
| Marketing Services | \$150,000.00 | \$300,000.00 | \$600,000.00 |
| Multimedia / Branding Services | \$50,000.00 | \$100,000.00 | \$200,000.00 |
| | \$5,000,000.00 | \$10,000,000.00 | \$20,000,000.00 |

FINANCIAL OVERVIEW

A complete set of financials is found in this Business Plan, but key metrics include:

| | 2021 | 2022 | 2023 |
|---|-----------------------|-----------------------|------------------------|
| EMERALD MOUNTAIN EXPRESS Locations | 1 | 6 | 12 |
| Total Revenues (\$) | \$5,000,000.00 | \$10,000,000.00 | \$20,000,000.00 |
| Expenses (\$) | \$1,500,000.00 | \$3,000,000.00 | \$6,000,000.00 |
| Operating profit/loss (\$) | \$3,500,000.00 | \$7,000,000.00 | \$14,000,000.00 |

MANAGEMENT TEAM

Our management team combines the experiences of executives and an advisory board with extensive backgrounds in managing and developing successful businesses within the cultivation, culinary, engineering & construction and software engineering industries.

EMERALD MOUNTAIN EXPRESS currently has four executives and is in the process of identifying and hiring additional support staff, which will be involved in business development, technical implementations and administration.

Upon obtaining the first round of funding, **EMERALD MOUNTAIN EXPRESS** will hire a full-time staff to fully implement the business as outlined in this plan. The Company's executive staff and operations will be in Clearlake, California.

Management, Board of Directors, Advisory Board, and Other Partners For further information please contact:

Chandra Martinez
Founder / General Manager
eMail: chandra@CannaMarketSquare.com
Mobile: (707) 533-6121



Executive Summary

2 ○ 2 ○

MISSION& VALUES

OUR PURPOSE

Our purpose is to restore health to people and the planet through the reconnection of Cannabis & Culinary. We're a purpose-driven company that aims to set the standards of excellence for the caregiver's market initiating a specialization in the production, distribution and sales of cannabis drinks.

Quality is a state of mind at **EMERALD MOUNTAIN SUPPLY, CO.**

OUR CORE VALUES

These core values are the backbone of our company culture and how we aspire to do business every day – with patients, our supplier partners, our customers, communities and each other.

OUR LEADERSHIP PRINCIPLES

We believe that every team member is a leader who is ultimately responsible for customer happiness. We use our leadership principles every day, whether we're discussing ideas for new projects or deciding on the best approach to solving a problem.

OUR DECLARATION OF INTERDEPENDENCE

We recognize the interdependence among our stakeholders – those who benefit or are impacted by our company. Our success is optimized by a win-win-win-win strategy, and all of our stakeholders benefit simultaneously.

ABOUT EMERALD MOUNTAIN SUPPLY, CO.

EMERALD MOUNTAIN SUPPLY, CO. was formed with a singular vision in mind where there was a cannabis distribution talent agency one stop shop that catered to the specific needs of the grower, extractor and producer of cannabis & CBD infused products. A Cannabis Talent Agency like no other before, one with processing power from steps A through Z that reaches from the tips of Northern California to the Shores of Long Beach.

Introducing the **CURE STATIONS CANNABIS CULTIVATION PARK** processing facilities. From Licensing Assistance to Distribution & Sales, **EMERALD MOUNTAIN SUPPLY, CO.** is dedicated to providing every aspect of the transaction for those who want to focus on what they do best, Grow and Process Cannabis premium flower & infused products. Here is a list of services to be provided by **EMERALD MOUNTAIN SUPPLY, CO.**

SOURCES OF REVENUE

1. CANNABIS LICENSING ASSISTANCE PROGRAM
2. MARKETING & BRANDING SERVICES
3. CANNABIS / CBD FLOWER DISTRIBUTION
4. CANNABIS / CBD FLOWER PACKAGING
5. CANNABIS / CBD DRYING & CURING
6. EDIBLE DISTRIBUTION
7. EDIBLE PACKAGING & LABELING
8. PRODUCT BOXING

- 9. ISOLATE DISTRIBUTION
- 10. ISOLATE PACKAGING & LABELING
- 11. DRINK DISTRIBUTION
- 12. DRINK PACKAGING & LABELING

THE CONCEPT

The gap in the market for a centralized location of Distribution & Sales services which can eliminate the objections in participating in the legally licensed cannabis market when assuring a seasoned and experienced cannabis & hemp grower/processor that all they will have to do is what they do best, grow or process, we got the rest.

EMERALD MOUNTAIN SUPPLY, CO. provides a hands-on, human approach that meets the needs that farmers and manufacturers are not comfortable engaging with every step of the way for all their cannabis Licensing, Branding, Marketing, sales, security, drying, curing, packaging, boxing,



distribution management, reporting , reputation management and general guidance in market related subjects. Our main credo for all of our clients and shareholders alike is simply that, "We live to serve & protect."

U.S. CANNABIS CULTIVATION IN CALIFORNIA
2019 SUPPLY AND DEMAND

FOR MORE INSIGHTS
LIKE THIS, VISIT:
NEWFRONTIERDATA.COM

DESPITE INCREMENTAL LEGAL MARKET GAINS, CALIFORNIA'S ILLICIT CANNABIS STILL DOMINATES IN-STATE & NATIONAL SUPPLY.



SUPPLY
17.3 MILLION LBS.
CALIFORNIA TOTAL CULTIVATION OUTPUT
(LEGAL + ILLICIT + EXPORTS)

DEMAND
4.8 MILLION LBS.
TOTAL POUNDS REQUIRED TO SATISFY
ALL DEMAND IN CALIFORNIA FOR FLOWER,
OILS, AND ALL OTHER DERIVATIVE PRODUCTS



58%
OF ALL OF THE NATION'S
CANNABIS IS GROWN
IN CALIFORNIA

© 2019 New Frontier Data | Source: New Frontier Data





THE CANNA SENTRY BUILDING

EMSC's team of engineers was assembled to create sustainable cannabis distribution environments by pairing IOT driven highly secured innovative and energy-efficient building designs with data driven climate control & Enterprise Resource Planning technologies. Self-monitoring & regulating drying & curing automation with live personnel 24/7/365 provides up to the minute support.

We partner with our technology providers to ensure a flourishing year-round production facility & services pipeline.

We design our facilities with a more sustainable and greener future in mind. At EMSC, we care about our environmental impact and understand that many of our clients do too. That's why our number one priority is creating complete, earth-conscious drying, curing, packaging, storing systems that use less energy and even function to create more renewable energy. EMSC team of greenhouse designers and engineers will work to come up with a custom cannabis farms all in one solution that has minimal environmental impact without sacrificing quality.

- **24/7/365 AI CAMERAS AND ONSITE ARMED SECURITY**
- **PERSONAL ACCESS CONTROLLED UNITS**
- **CANNABIS HUMIDOR CLIMATE CONTROLLED ENVIRONMENT & ALERT SYSTEM**
- **GREEN ENERGY POWERED SYSTEMS**
- **24/7/365 ONSITE DRYING & CURING STAFF**
- **METRC COMPLIANT TRACKING SOFTWARE INTEGRATION**
- **ERP INTEGRATION / COMPLETE BUSINESS AUTOMATION**

With this said, it is a key market indicator of the potential and with First Mover momentum and the proper corporate infrastructure would be poised to lead the market and industry for the world.

MARKETING & STRATEGIC ALLIANCES

Marketing will consist of targeted growers, Farms, Chefs and inventors with proven track records. An extensive screening and acceptance process will take place with only the best of the best taken as clients. Multi-channel social media campaigns along with word of mouth with a clear foundation of a clean, sustainable marketplace that will consolidate the best of premium cannabis, edibles, drinks that will fan the flames of the Cannabis Culinary Revolution.

SALES GOALS

A complete set of financials is found in this Business Plan, but key metrics include:

| | 2021 | 2022 | 2023 |
|--------------------------------|-----------------------|------------------------|------------------------|
| Cannabis Flower Distribution | \$2,000,000.00 | \$4,000,000.00 | \$8,000,000.00 |
| Edible Distribution | \$1,000,000.00 | \$2,000,000.00 | \$4,000,000.00 |
| Drink Distribution | \$1,200,000.00 | \$2,400,000.00 | \$4,800,000.00 |
| Packaging & Labeling | \$500,000.00 | \$1,000,000.00 | \$2,000,000.00 |
| Boxing Services | \$100,000.00 | \$200,000.00 | \$400,000.00 |
| Marketing Services | \$150,000.00 | \$300,000.00 | \$600,000.00 |
| Multimedia / Branding Services | \$50,000.00 | \$100,000.00 | \$200,000.00 |
| | \$5,000,000.00 | \$10,000,000.00 | \$20,000,000.00 |

FINANCIAL OVERVIEW

A complete set of financials is found in this Business Plan, but key metrics include:

| | 2021 | 2022 | 2023 |
|-------------------------------------|-----------------------|-----------------------|------------------------|
| EMERALD MOUNTAIN SUPPLY, CO. | | | |
| Locations | 1 | 6 | 12 |
| Total Revenues (\$) | \$5,000,000.00 | \$10,000,000.00 | \$20,000,000.00 |
| Expenses (\$) | \$1,500,000.00 | \$3,000,000.00 | \$6,000,000.00 |
| Operating profit/loss (\$) | \$3,500,000.00 | \$7,000,000.00 | \$14,000,000.00 |

MANAGEMENT TEAM

Our management team combines the experiences of executives and an advisory board with extensive backgrounds in managing and developing successful businesses within the cultivation, culinary, engineering & construction and software engineering industries.

EMERALD MOUNTAIN SUPPLY, CO. currently has four executives and is in the process of identifying and hiring additional support staff, which will be involved in business development, technical implementations and administration.

Upon obtaining the first round of funding, **EMERALD MOUNTAIN SUPPLY, CO.** will hire a full-time staff to fully implement the business as outlined in this plan. The Company's executive staff and operations will be in Clearlake, California.

Management, Board of Directors, Advisory Board, and Other Partners

For further information please contact:

Chandra Martinez

Founder / General Manager

eMail: chandra@CannaMarketSquare.com

Mobile: (707) 533-6121

{ } 11. Previous addresses for the past five years.

**40603 Adante St - 2 years
Fremont, Ca**

**10849 North Slope Dr. 1.5 years
Kelseyville, Ca**

**7381 Gross Road
Kelseyville, Ca 1.5 years**

{ } 12. Property ownership and lease details.

Howard Levin 707-494-8498

Howard Levin
3611 Williams Rd
Santa Rosa, Calif

November 1, 2020

To: The City of Clearlake

Re: Authorization & Acknowledgement

14915 Olympic Drive, Clearlake, Ca. 95422

Please be advised that I own the warehouses at
14915 Olympic Drive, Clearlake, Ca.

This letter serves as acknowledgement that Chandra
Martinez, Fuego Premium, LLC, may use the
following properties pursuant to state law:

Unit O for a marijuana nursery

Units G, H, I, K, and M for marijuana indoor
cultivation.

Unit N for marijuana distribution

Sincerely,

Howard Levin

11/10/20

See Notary
Attachment

ACKNOWLEDGMENT

A notary public or other officer completing this certificate verifies only the identity of the individual who signed the document to which this certificate is attached, and not the truthfulness, accuracy, or validity of that document.

State of California
County of Sonoma)

On November 10, 2020 before me, Lester Theriot Notary Public
(insert name and title of the officer)

personally appeared Howard Levin,
who proved to me on the basis of satisfactory evidence to be the person(s) whose name(s) is/are subscribed to the within instrument and acknowledged to me that he/she/they executed the same in his/her/their authorized capacity(ies), and that by his/her/their signature(s) on the instrument the person(s), or the entity upon behalf of which the person(s) acted, executed the instrument.

I certify under PENALTY OF PERJURY under the laws of the State of California that the foregoing paragraph is true and correct.

WITNESS my hand and official seal.

Signature Lester Theriot (Seal)

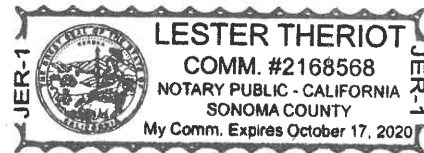

COORDINATION ONLY
NOT FOR CONSTRUCTION

| ELECTRICAL SYMBOLS | |
|--------------------|---|
| | GROUND FAULT INTERRUPT DOUBLE RECEPTACLE MOUNT @ 14" TEMPER-RESISTANT |
| | GROUND FAULT INTERRUPT DOUBLE RECEPTACLE MOUNT @ 44" TEMPER-RESISTANT |
| | ARCH FAULT INTERRUPT TEMPER-RESISTANT |
| | DOUBLE RECEPTACLE MOUNT @ 14" WATERPROOF TEMPER-RESISTANT |
| | DOUBLE RECEPTACLE MOUNT @ 14" WATERPROOF TEMPER-RESISTANT |
| | EXHAUST FAN DUCTED TO OUTSIDE BROAN NEO 1485 680 |
| | LIGHT SWITCH/ROCKER |
| | 3 POLE LIGHT SWITCH/ROCKER |
| | LIGHT SWITCH/ROCKER W/ VACANCY SENSOR |
| | RECESSED LIGHT, 4" LED FIXED, LC-DL-Cantless-20W-40K |
| | LED TROFFER LIGHT 1'x4' C-FH-CCT BTWN FLOOR JOISTS |
| | HIGH BAY LC-LHB-233W-50K |
| | WALL MOUNT FLOOD LC-SB-3042-320W-50K |
| | SMALL WALL PACK LC-WP-25W-50K |
| | ELECTRIC VEHICAL CHARGER "TURBODOCK" |
| | SUB PANEL |
| | GROW LIGHT 660 WATT |

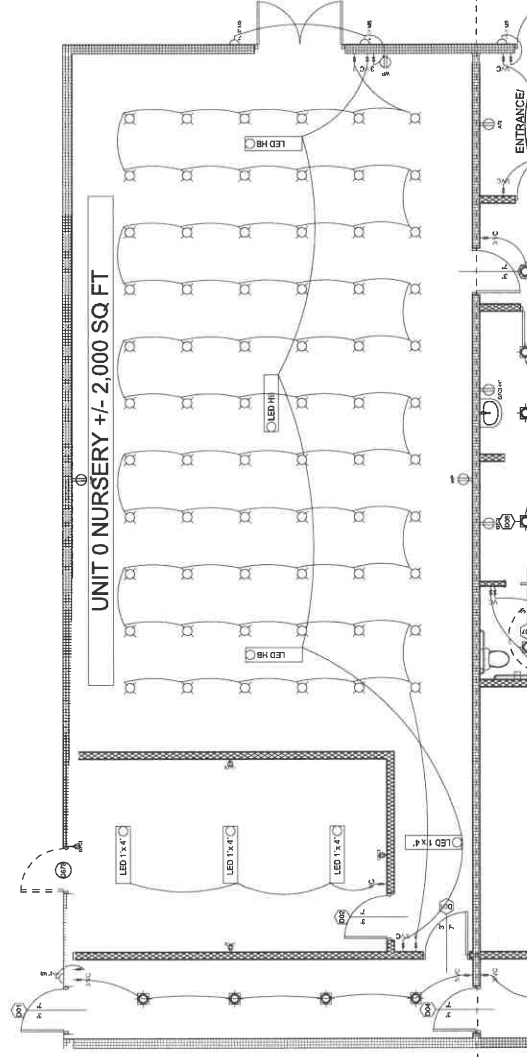

1st FLOOR ELECTRICAL

1/4" = 1'-0"

COORDINATION ONLY
NOT FOR CONSTRUCTION

| ELECTRICAL SYMBOLS | |
|--------------------|---|
| | RECESSED LIGHT, 4" LED FIXED, LC-DL-Cantless-20W-40K |
| | LED TRIGGER LIGHT 1'x4' LC-PL-LCT-1M |
| | BETWN FLOOR JOISTS LC-LHB-223W-50K |
| | HIGH BAY LC-LHB-223W-50K |
| | WALL MOUNT FLOOD LC-SR-3042-320W-50K |
| | SMALL WALL PACK LC-WP-25W-50K |
| | ELECTRIC VERTICAL CHARGER "TURBODOCK" |
| | SUB PANEL |
| | GROW LIGHT 660 WATT |
| | GROUND FAULT INTERRUPT DOUBLE RECEPTACLE MOUNT @ 14" TEMPER-RESISTANT |
| | GROUND FAULT INTERRUPT DOUBLE RECEPTACLE MOUNT @ 44" TEMPER-RESISTANT |
| | ARCH FAULT INTERRUPT DOUBLE RECEPTACLE MOUNT @ 14" TEMPER-RESISTANT |
| | DOUBLE RECEPTACLE MOUNT @ 14" WATERPROOF TEMPER-RESISTANT |
| | EXHAUST FAN DUCTED TO OUTSIDE BROAN NEO 1485 680 |
| | LIGHT SWITCH/ROCKER |
| | 3 POLE LIGHT SWITCH/ROCKER |
| | LIGHT SWITCH/ROCKER W/ VACANCY SENSOR |

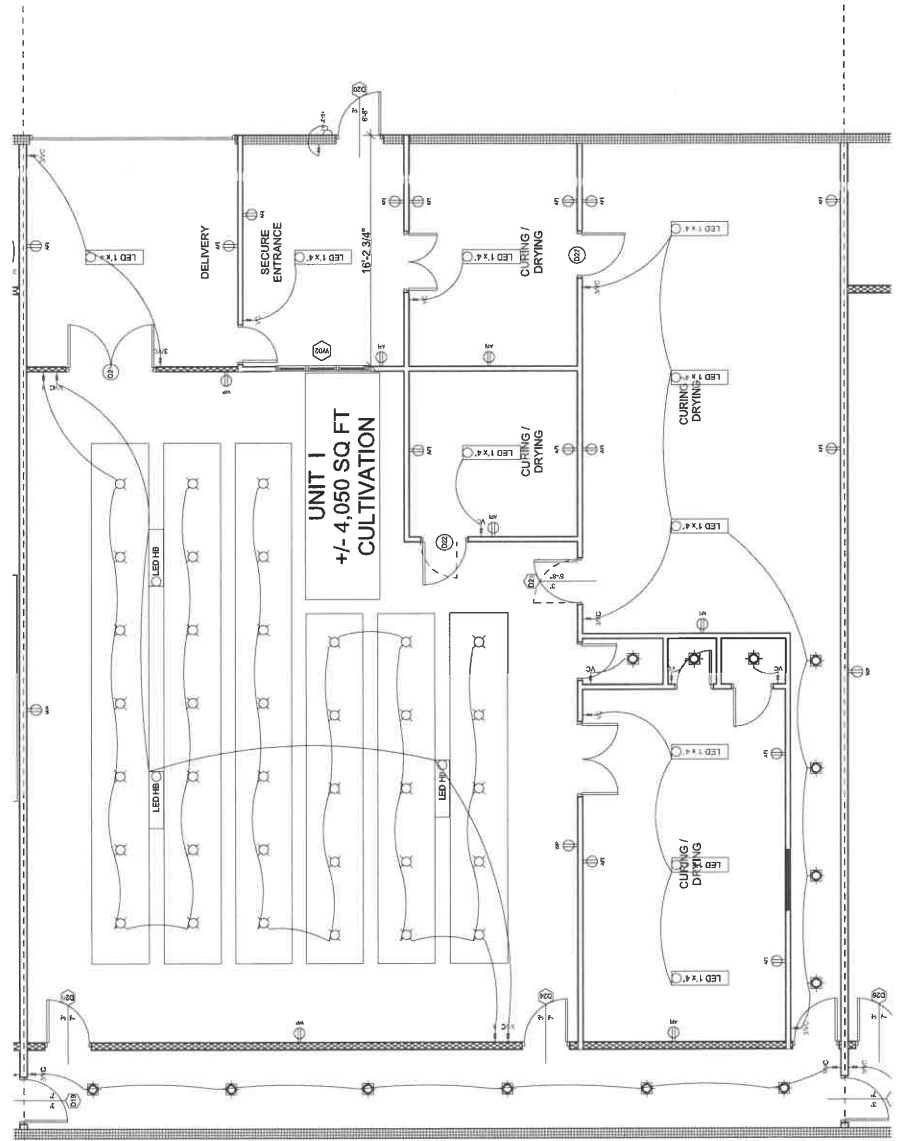

1st FLOOR ELECTRICAL

1/4" = 1'-0"

RUFF + ASSOCIATES
Architecture Planning Development

107 West Standby Street, Upland, CA 91786
Phone: 767-422-0225 Fax: 767-422-0227
Email: info@ruffandassociates.com

© BY RUFF + ASSOCIATES. ALL RIGHTS RESERVED.

FUEGO PREMIUM LLC
TENANT IMPROVEMENT
UNIT G
14915 OLYMPIC DRIVE CLEAR
LAKE CA 95422

SHEET TITLE
ELECTRICAL

DATE
10-27-2020

DESIGNED BY
RJR

CHECKED BY
RJR

DATE
10-27-2020

SCALE
AS SHOWN

STATUS
ISSUED FOR PERMITS

PROJECT NO.
14-023

SHEET NO.
OF 16

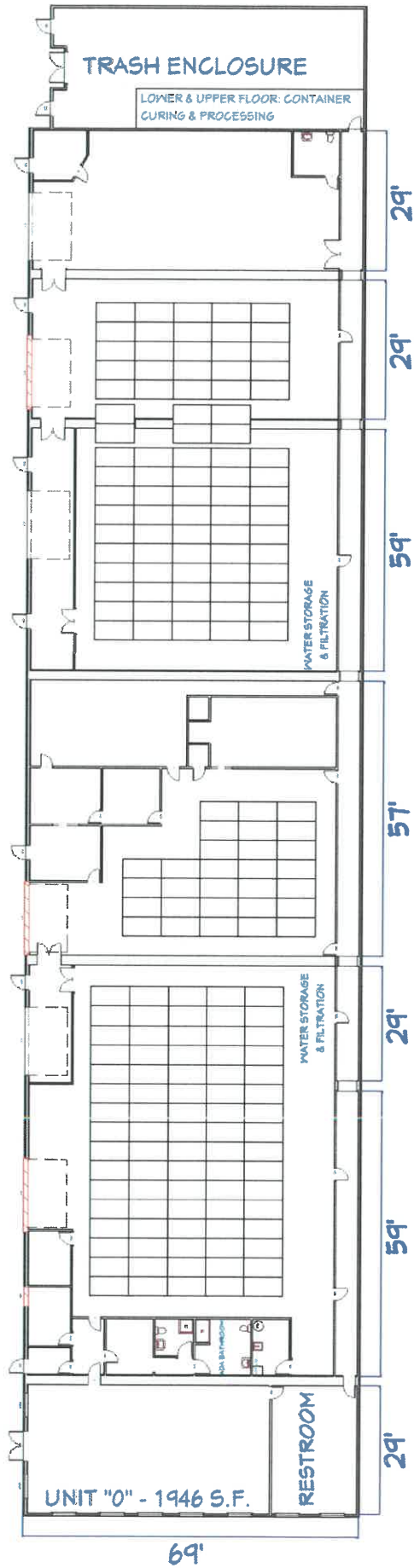

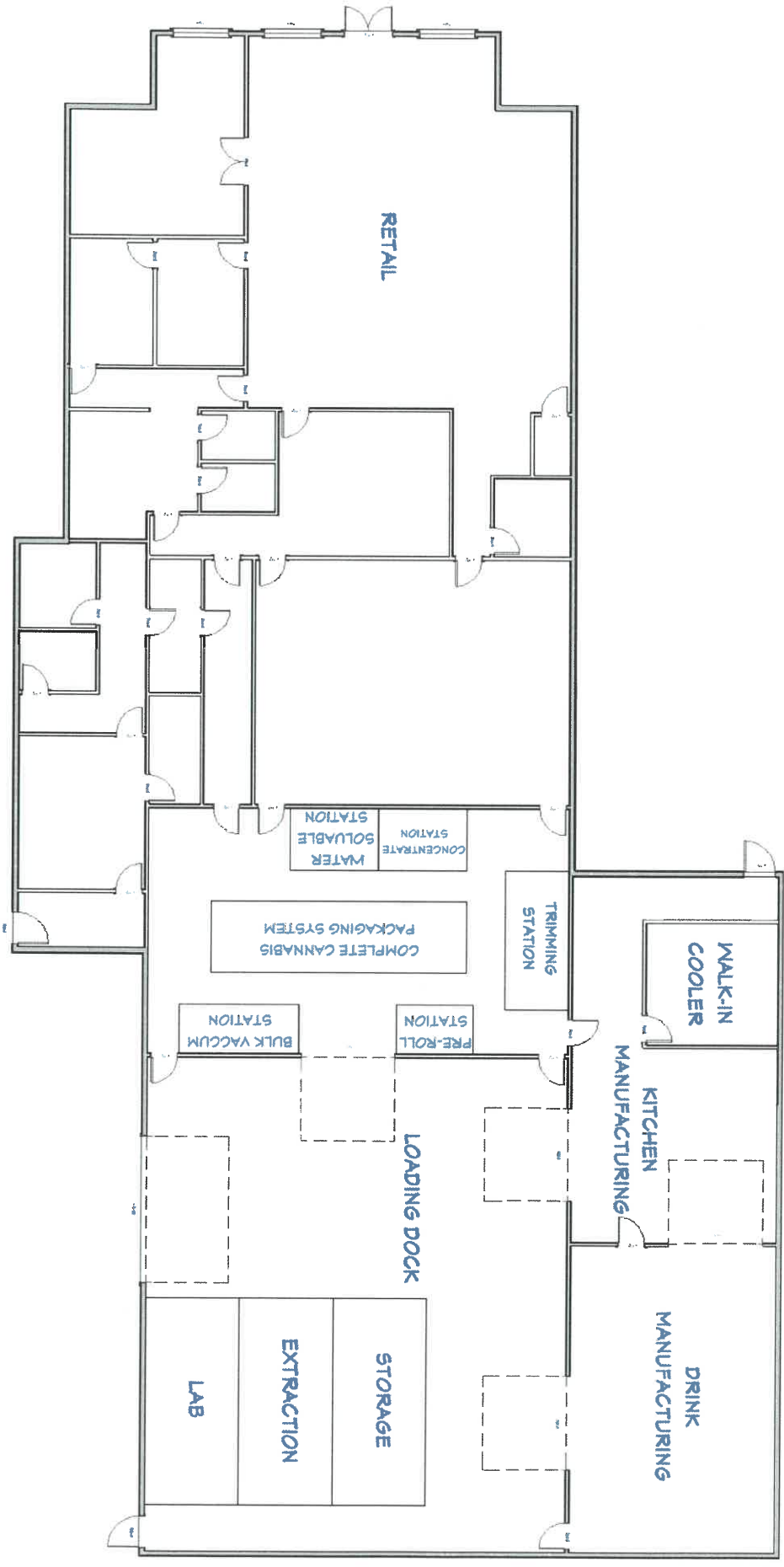

include the name and address of the owner and lessor of the prospective cannabis business premises and a copy of the lease or other such proof of the legal right to occupy and use the premises and a statement from the owner or agent of the owner of the real property where the facility will be located demonstrating the landowner has acknowledged and consented to permit the cannabis business to operate on the property, and all other information required by the Community Development Department use permit application checklist.

- B. Cannabis Business Regulatory Permit.** No person or entity shall operate a cannabis business facility within the City of Clearlake without first obtaining a cannabis business regulatory permit from the City. The regulatory permit shall be site specific and shall specifically identify the cannabis business activities that will be allowed at that site. No cannabis business activities will be allowed unless specifically identified in the regulatory permit. In addition, all persons or entities who undertake any subcomponent of a cannabis business performed by a subcontractor or tenant of the holder of a cannabis business use permit within the cannabis business permitted premises shall first obtain a cannabis business regulatory permit from the City. (Ord. #229-2019, § 4 (Ex. A))

18-43.060 General Operating Requirements.

The following general operating requirements are applicable to all applications for commercial cannabis business use permits subject to the additional requirements set forth in subsections 18-43.070 (Cultivation Operating Requirements), 18-43.080 (Manufacturing Operating Requirements), 18-43.090 (Distribution Operating Requirements), and 18-43.100 (Testing Laboratory Operating Requirements), respectively.

A. Compliance with State and Local Law.

1. **State Licensing.** All cannabis operators shall be required to obtain a State cannabis license at such time as the State begins issuing such licenses pursuant to MAUCRSA, and shall comply at all times with any applicable State licensing requirements, including, but not limited to, operational standards such as, by way of illustration but not limitation, background checks, prior felony convictions, restrictions on multiple licenses and license types, and locational criteria. Failure to apply for, receive, maintain, and operate in full compliance with a State cannabis license, when available, shall be grounds for revocation of City approval of commercial cannabis permits as set forth in this chapter.
2. **State Law and Agency Compliance.** Compliance with the provisions of the MAUCRSA, as may be amended, as well as any and all rules and regulations for commercial cannabis as may now be adopted or hereafter promulgated by any of the State agencies and departments with oversight of cannabis activity and licensing including, but not limited to, the Bureau

of Cannabis Control, the Department of Food and Agriculture, the Department of Public Health, the Department of Pesticide Regulation, the State Water Resources Control Board, and the Department of Tax and Fee Administration shall be considered conditions of zoning clearance or permit approval for any commercial cannabis use in the City.

3. Inventory and Tracking. Cannabis operators shall comply with any track and trace program established by the State agencies and shall operate in a manner to prevent diversion of cannabis.
- B. Building and Fire Permits.** All applicants must illustrate that their facilities are compliant with all applicable local building and fire codes.
- C. Management and on-Site Community Relations Contacts.** Each applicant for a commercial cannabis business shall provide the Community Development Department, Fire Department, and Police Department with full contact information for the person or persons having management and/or supervision of the cannabis business as well as an on-site community relations contact. Subsequently cannabis operators shall provide prompt written notice to the Planning Department, Fire Department, and Police Department of any changes to such contact information.
- D. Transfer of Ownership or Control.** A permittee shall not transfer ownership or control of a cannabis business or transfer a use permit or zoning clearance for a cannabis business to another person unless and until the transferee obtains an amendment to the permit or zoning clearance from the Community Development Director stating that the transferee is now the permittee. Such an amendment is obtained through the issuance of a zoning clearance that documents the transfer and commits the transferee to compliance with each of the conditions of the original use permit or zoning clearance.
- E. Security Plan.** Every cannabis business shall provide adequate security on the premises, including lighting and alarms, to ensure the safety of persons and to protect the premises from theft. As part of an application for a cannabis use, each applicant shall prepare and submit a security plan, which plans shall remain updated and secured on file in the protective custody of the Building Department. The information provided for purposes of this section shall be maintained by the Building Department as confidential information, and shall not be disclosed as public records unless pursuant to subpoena issued by a court of competent jurisdiction. Minimum security plan requirements include the following:
1. Security Cameras. Security surveillance cameras shall be installed to provide coverage on a twenty-four (24) hour basis of all areas where cannabis is cultivated, weighed, manufactured, packaged, stored and dispensed in a manner that provides clear and certain identification of individuals. Cameras shall remain in active, operable condition and capable of operating under any lighting condition. Security video must use standard industry format to support criminal investigations and shall be maintained for ninety (90) days.

2. **Alarm System.** A professionally monitored robbery alarm system shall be installed and maintained in good working condition. The alarm system shall be installed in accordance with Section 5-13 of the City of Clearlake Municipal Code and shall include sensors to detect entry and exit from all secure areas and windows. Cannabis operators shall keep the name and contact information of the alarm system installation company as part of the business's on-site books and records.
 3. **Limited Access Areas.** A cannabis business shall establish limited access areas accessible only to authorized personnel and enforcement.
 4. **Storage.** All cannabis on the permitted premises shall be stored and secured in a store room, safe, or vault in a manner that prevents diversion, theft, and loss.
 5. **Transportation.** Each cannabis business shall provide as a part of its security plan a description of its procedures for transportation delivery, and safely and securely transporting cannabis products and currency in accordance with State law.
 6. **Locks.** All points of ingress and egress to a cannabis business shall ensure the use of commercial-grade, nonresidential door locks and window locks.
 7. **Emergency Access.** Security measures shall be designed to ensure emergency access in compliance with fire safety standards.
- F. Odor Control.** All cannabis businesses in the City shall be required to incorporate and maintain adequate odor control measures such that the odors of cannabis cannot be readily detected from outside of the structure in which the permitted premises is located. The cannabis operator shall be solely responsible for taking any and all appropriate measures to meet this standard and to install, operate and maintain appropriate odor mitigation measures consistent with the manufacturer's specifications and requirements.
- G. Lighting.** Exterior lighting shall be provided for security purposes in a manner that shall be sufficient to provide illumination and clear visibility to all outdoor areas, including all points of ingress and egress, with minimal spillover on adjacent properties. The lighting shall be stationary, directed away from adjacent properties and public rights-of-way, and of an intensity compatible with the neighborhood, and in compliance with all illumination standards adopted by the City on a City-wide basis.
- H. Inspections.** The cannabis business shall be open for inspection by any City law enforcement officer or City Code Enforcement Officer at any time the cannabis business is operating, at any other time upon responding to a call for service related to the property where the cannabis business is occurring, or otherwise upon reasonable notice. Recordings made by security cameras at any cannabis business shall be made immediately available to the Police Chief upon verbal request. No search warrant or subpoena shall be needed to view the recorded materials.

- I. **Modifications to Premises.** A permittee shall not make physical change, alteration, or modification of the permitted premises that materially or substantially alters the permitted premises from the plans approved by the review authority without the prior written approval of the review authority. Material changes include, but are not limited to: an increase or decrease in the total square footage of the permitted premises, or modifications made for the purpose of increasing power usage, or the addition, sealing off, or relocation of a wall, common entryway, doorway, or other means of public ingress and/or egress.
- J. **Display of Permit.** Every commercial cannabis facility shall display at all times during business hours the use permit or zoning clearance issued pursuant to the provisions of this article for such dispensary in a conspicuous place so that the same may be readily seen by all persons entering the facility.
- K. **Hours of Operation.** Cannabis businesses shall be allowed to operate per the requirements of the underlying zone district or the use permit, whichever is the more restrictive, and subject to the City’s noise and nuisance ordinances.
- L. **Permit Requirements for a Cannabis Microbusiness.** A cannabis microbusiness shall be subject to approval of a use permit by the Planning Commission.
- M. Cannabis processing operations that are an ancillary and integral part of the operations of a cannabis manufacturer or cannabis cultivator are not required to have an additional cannabis processing permit.

18-43.070 Cultivation Operating Requirements.

- A. **Applicability.** In addition to the general operating requirements set forth in subsection 18-43.060, this section provides specific requirements for all cannabis cultivation in the City.
- B. **Permit Requirements.** In the CB combining district, all cannabis cultivation businesses shall be subject to approval of a use permit by the Planning Commission.
- C. All cultivation facilities must be secured from public access with metal security fencing and drive and pedestrian gates with electronic key code or similar access controls approved by the Chief of Police, as set forth in subsection 18-03.300.

18-43.080 Manufacturing Operating Requirements.

- A. **Applicability.** In addition to the general operating requirements set forth in subsection 18-43.060, this section provides specific requirements for all cannabis manufacturers in the City.
- B. **Permit Requirements.** In the CB combining district, all cannabis manufacturing businesses shall be subject to approval of a use permit by the Planning

Commission.

C. Operating Requirements.

1. All cannabis manufacturers shall utilize only extraction processes that are approved by the Lake County Fire Protection District Chief or designee and are generally recognized as safe pursuant to the Federal Food, Drug, and Cosmetic Act and/or use solvents exclusively within a closed loop system that meets the requirements under the Federal Food, Drug, and Cosmetic Act including use of specified solvents, prevention of off-gassing, and certification by a licensed engineer.
2. All cannabis manufacturers shall receive and maintain approval from the Fire Department for the closed-loop system, other equipment, the extraction operation and the facility.
3. All cannabis manufacturers shall meet required fire, safety, and building code requirements in one (1) or more of the California Fire Code, National Fire Protection Association standards, the International Building Code and the International Fire Code. Cannabis manufacturer facilities, all operations conducted therein, and all equipment used must be in compliance with all applicable State and local laws, including all building, electrical, and fire codes. Cannabis manufacturers shall prepare hazardous materials handling and safety plans as required by State law and departmental guidelines for review and approval by the Fire Chief of the Lake County Fire Protection District or his or her designee, or if the proposed location is under the jurisdiction of CalFire, review and approval by the appropriate CalFire official in coordination with the Fire Chief of the Lake County Fire Protection District.
4. All cannabis manufacturers shall possess a valid seller's permit issued by the Department of Tax and Fee Administration.
5. A hazardous materials disclosure/inventory statement shall be provided and kept current with the Fire Department. The cannabis manufacturer shall further provide the Fire Department with a lock box for keys to gates and doors.
6. All processing and analytical testing devices used by the cannabis manufacturer must be UL listed, or otherwise approved for the intended use by the City's Building Official or the Fire Department. Any processing devices using only non-pressurized water are exempt from such approval.
7. A cannabis manufacturer that produces edible cannabis products must comply with the provisions of all relevant State and local laws regarding the preparation, distribution, and sale of food.

18-43.090 Distribution Operating Requirements.

- A. Applicability.** In addition to the general operating requirements set forth in subsection 18-43.060, this section provides specific requirements for all cannabis distributors in the City.
- B. Permit Requirement.** A use permit issued by the Planning Commission shall be required to operate a cannabis distribution facility, and may only be issued for cannabis distribution uses located in the CB combining zone districts.
- C. Manifests.** Cannabis distributors shall maintain records of transactions and shipping manifests at its distribution or transportation site and shall operate in full compliance with State law.

18-43.100 Testing Laboratory Operating Requirements.

- A. Applicability.** In addition to the general operating requirements set forth in subsection 18-43.060, this section provides specific requirements for all cannabis testing laboratories in the City.
- B. Permit Requirements.** A use permit issued by the Planning Commission shall be required to operate a cannabis testing laboratory and may only be issued for a cannabis testing laboratory located in the CB combining zone districts.

18-43.110 Violations; Enforcement.

- A.** Any person that violates any provision of this article shall be guilty of a separate offense for each and every day during any portion of which any such person commits, continues, permits, or causes a violation thereof, and shall be penalized accordingly.
- B.** Any use or condition caused or permitted to exist in violation of any of the provisions of this article shall be and is hereby declared a public nuisance and may be summarily abated by the City pursuant to the City of Clearlake Municipal Code. Such abatement shall not include the eradication of marijuana plants without first obtaining an abatement warrant.
- C.** The violation of any provision of this article shall be, and is hereby declared to be, contrary to the public interest and shall, at the discretion of the City, create a cause of action for injunctive relief.

18-43.120 Severability.

The provisions of this article are hereby declared to be severable. If any provision, clause, word, sentence, or paragraph of this article or of the regulatory permit issued to implement this article, or the application thereof to any person, establishment, or



City of Clearlake

14050 Olympic Drive, Clearlake, California 95422
(707) 994-8201 Fax (707) 995-2653

RECEIVED

DEC 09 2020

Lake County
Environmental Health

DEVELOPMENT COORDINATION REVIEW

CITY DEPARTMENTS

- Building Inspection
- Code Enforcement
- Fire (Lake County Fire District)
- Police
- Public Works/Engineering

COUNTY AGENCIES

- Air Quality Management
- Environmental Health
- Flood Control
- Lake County Water Resources
- Planning
- Public Works
- Special Districts (sewers)
- Lake County Transit

STATE AGENCIES

- CalTrans
- Fish and Game
- Sonoma State University
- State Clearing House
- Water Resources

FEDERAL AGENCIES

- Fish and Wildlife
- U.S. Department of Agriculture
- OTHER
- Elem Indian Colony
- Middletown Rancheria
- Koi Nation of Northern California
- Water District (Highlands Water Company)
- PG & E
- Cannabis Agencies
 - Bureau of Cannabis Control
 - CalCannabis
 - CA Dept. of Public Health

REQUEST: Please review the enclosed Development Plan(s) and return comments by 12/28/20

Application: UP 06-20 Cannabis Cultivation, 07-20 Manufacturing, 08-20 Distribution, 09-20 Nursery, and 10-20 Retail delivery

DESCRIPTION OF PROJECT: Chandra Martinez, representative of Fuego Tribe, is looking to expand their current use permit (UP 16-18) at 14935 Olympic Drive (Olympic Plaza) allowing cannabis cultivation in order to modify the existing site plan and include manufacturing, distribution, nursery, and retail delivery spanning both parcels. The City recently removed the limit on the amount of cultivation, manufacturing, distribution, testing laboratory, nursery, processing, and delivery-only dispensary permits within the existing commercial cannabis combining district, for which both properties are zoned. No new structures have been proposed and the remodel of the existing structures has been included for review. The City ordinance requires a development agreement and use permit approval, aside from other standard business license/seller's permit requirements. **For additional information please see the attached application packet or contact the planning department.**

LOCATION: 14935 & 14915 Olympic Drive, Clearlake, CA 95422
ASSESSOR'S #: 039-550-450-000 & 039-550-460-000

APPLICANT: Chandra Martinez
ADDRESS: PO Box 4643, Clearlake, CA 95422
PHONE: 707-533-6121
Date Distributed: 12/8/2020

Staff : Mark Roberts & Susanna Gutierrez, Planning Dept.

RETURN DATE REQUESTED: December 28, 2020

Comments and/or conditions recommended if project approved for development: (add additional pages if necessary)

See attached memorandum

Date: 12/9/20 By: Ting Rubin

(For City of Clearlake use only)
Response Received:

SR0004058



COUNTY OF LAKE
Health Services Department
Environmental Health Division
922 Bevins Court
Lakeport, California 95453-9739
Telephone 707/263-1164
FAX 707/263-1681

Denise Pomeroy
Health Services Director

Gary Pace, MD, MPH
Public Health Officer

Craig Wetherbee
Environmental Health Director

Promoting an Optimal State of Wellness in Lake County

Memorandum

DATE: December 9, 2020

TO: Susanna Amaro-Gutierrez – Assistant Planner,
City of Clearlake

FROM: Tina Dawn-Rubin, Environmental Health Aide

RE: UP 06-20 Commercial Cannabis Cultivation; UP 07-20
Manufacturing; UP 08-20 Distribution; UP 09-20
Nursery; UP 10-20 Retail

APN: 039-550-45 & 46 14915 & 14935 Olympic Drive,
Clearlake

Environmental Health Division does not have any concerns on the wastewater treatment system since property is connected to a public sewer system.

Lake County Environmental Health requires all applicants to provide a written declaration of the chemical names and quantities of any Hazardous Material to be used on site. As a general rule, if a material has a Safety Data Sheet, that material may be considered as part of the facilities Hazardous Material Declaration.



COUNTY OF LAKE
HEALTH SERVICES
prevent.promote.protect.

MARIJUANA EDIBLES:

Cannabis Edibles:

- A product intended for consumption that has cannabis in it would be considered an “edible” pursuant BPC section 26001(t), and not a food, thus it would have to be manufactured under a Manufacturer Cannabis Safety Bureau (MCSB) license and in accordance with the Medical and Adult-Use Cannabis Regulation and Safety Act (MAUCRSA) and the regulations.
- Under the California Business and Professions Code (BPC) 26130(d), if the product is not manufactured in accordance with MAUCRSA and the regulations, the cannabis in the product would be considered an adulterant.
- Pursuant to the regulations, 17 CCR section 40175, food products and edible products cannot be manufactured at the same premises.
- Pursuant to BPC 26053, any entity engaged in the commercial manufacture, possession or sale of any product containing cannabis would require a license issued under MAUCRSA.

As for the retail sale of products containing cannabis, that would require a license from the Bureau of Cannabis Control.

- Under the Controlled Substances Act, Health and Safety Code (HSC) section 11362.3, it is illegal for cannabis products to be ingested in a public place unless it is in accordance with BPC section 26200.
- BPC Section 26200(g) requires that the local jurisdiction specifically allow for such consumption and that the consumption occur on the premises of a retailer or microbusiness that is licensed under MAUCRSA.
- The retailer or microbusiness would need to be licensed by the Manufacturer Cannabis Safety Bureau and comply with all the requirements established by the Bureau.



COUNTY OF LAKE
HEALTH SERVICES
prevent.promote.protect.

Tina Rubin

From: Susanna Amaro-Gutierrez <sgutierrez@clearlake.ca.us>
Sent: Tuesday, December 8, 2020 6:48 PM
To: Andrew White; swartz@cecusa.net; Dave Deakins; Lee Lambert; swartz@cecusa.net; Fahmy Attar; Doug Gearhart; Tina Rubin; Kelli Hanlon; Lori Baca; a.tyler@elemindiancolony.org; a.garcia@elemindiancolony.org; speterson@middletownrancheria.com; mshaver@middletownrancheria.com; Cory Smith; Dino Beltran; kn2@koination.com; Doug Gearhart; Jackman, Rex A@DOT; Jackman, Rex A@DOT; james.shupe@dot.ca.gov; kyle.stoner@wildlife.ca.gov; jeff@highlandswater.com; rick@highlandswater.com; cdfa.CalCannabis_Local_Verification@cdfa.ca.gov; MCLS.LocalRelations@cdph.ca.gov; kevin.ponce@cdfa.ca.gov; BCCLocalGov@dca.ca.gov
Cc: Mark Roberts; Alan Flora
Subject: [EXTERNAL] DCR UP Fuego Tribe Commercial Cannabis UP 06-20, 07-20, 08-20, 09-20, 10-20
Attachments: RFR Packet Fuego Tribe.pdf

Good Evening,

The City of Clearlake would like to request your review of use permit applications UP 06-20, 07-20, 08-20, 09-20 and 10-20 for a cannabis operation located at 14935 & 14915 Olympic Drive in the C4 Heavy Service Commercial - Light Industrial zone and Commercial Cannabis overlay district. Please refer to the attachment for further information in addition to the summary below:

Chandra Martinez, representative of Fuego Tribe, is looking to expand their current use permit (UP 16-18) at 14935 Olympic Drive (Olympic Plaza) allowing cannabis cultivation in order to modify the existing site plan and include manufacturing, distribution, nursery, and retail delivery spanning both parcels. The City recently removed the limit on the amount of cultivation, manufacturing, distribution, testing laboratory, nursery, processing, and delivery-only dispensary permits within the existing commercial cannabis combining district, for which both properties are zoned. No new structures have been proposed and the remodel of the existing structures has been included for review. The City ordinance requires a development agreement and use permit approval, aside from other standard business license/seller's permit requirements. For additional information please see the attached application packet or contact the planning department.

If you have any questions feel free to reach out to me; please submit your comments no later than December 22.

Best,



Susanna Amaro-Gutierrez
Assistant Planner
City of Clearlake

RE: DCR UP Fuego Tribe Commercial Cannabis UP 06-20, 07-20, 08-20, 09-20, 10-20

Lori Baca <Lori.Baca@lakecountyca.gov>

Fri 12/18/2020 11:25 AM

To: Susanna Amaro-Gutierrez <sgutierrez@clearlake.ca.us>

📎 1 attachments (18 KB)

Types of Wastes Prohibited.docx;

Susanna,

Both parcels, 039-550-450 and 039-550-460, located at 14935 and 14915 Olympic Drive in Clearlake, are within LACOSAN 1-2 service area and have multiple actively billed sewer accounts.

A Waste Management Plan (both solid and liquid) is required and I do not see anything addressing waste removal in the packet. This information is needed to determine if a Special Agreement would be required. I have attached our Sewer Use Ordinance which covers prohibited types of wastes in our sewer system. The full Sewer Use Ordinance can be found at the link below:

https://library.municode.com/ca/lake_county/codes/code_of_ordinances?nodeId=COOR_APXASEUSORLACOSADI

I will also need more information in order to determine the additional sewer capacity and also if additional Capacity Fees will be warranted. I would like to know the staffing levels and hours of operation, what facilities are existing and what facilities are being added (i.e. restrooms, kitchen/breakroom).

If you have any questions or need additional information please do not hesitate to contact me!

Have a great day!

Lori A. Baca

Customer Service Coordinator

Lori.Baca@lakecountyca.gov

Office Number (707) 263-0119

Fax (707) 263-3836



From: Susanna Amaro-Gutierrez [mailto:sgutierrez@clearlake.ca.us]

Sent: Tuesday, December 8, 2020 6:48 PM

To: Andrew White <awhite@clearlakepd.org>; swartz@cecusa.net; Dave Deakins <ddeakins@clearlake.ca.us>; Lee Lambert <llambert@clearlakepd.org>; swartz@cecusa.net; Fahmy Attar <FahmyA@lcaqmd.net>; Doug Gearhart <doug@lcaqmd.net>; Tina Rubin <Tina.Rubin@lakecountyca.gov>; Kelli Hanlon <Kelli.Hanlon@lakecountyca.gov>; Lori Baca <Lori.Baca@lakecountyca.gov>; a.tyler@elemindiancolony.org; a.garcia@elemindiancolony.org; speterson@middletownrancheria.com; mshaver@middletownrancheria.com; Cory Smith <CSmith@lakecountyfire.com>; Dino Beltran <dbeltran@koination.com>; kn2@koination.com; Doug Gearhart <doug@lcaqmd.net>; Jackman, Rex A@DOT <rex.jackman@dot.ca.gov>; Jackman, Rex A@DOT <rex.jackman@dot.ca.gov>; james.shupe@dot.ca.gov; kyle.stoner@wildlife.ca.gov; jeff@highlandswater.com; rick@highlandswater.com; cdfa.CalCannabis_Local_Verification@cdfa.ca.gov; MCLS.LocalRelations@cdph.ca.gov; kevin.ponce@cdfa.ca.gov; BCCLocalGov@dca.ca.gov

Cc: Mark Roberts <mroberts@clearlake.ca.us>; Alan Flora <aflora@clearlake.ca.us>

Subject: [EXTERNAL] DCR UP Fuego Tribe Commercial Cannabis UP 06-20, 07-20, 08-20, 09-20, 10-20

Good Evening,

The City of Clearlake would like to request your review of use permit applications UP 06-20, 07-20, 08-20, 09-20 and 10-20 for a cannabis operation located at 14935 & 14915 Olympic Drive in the C4 Heavy Service Commercial - Light Industrial zone and Commercial Cannabis overlay district. Please refer to the attachment for further information in addition to the summary below:

Chandra Martinez, representative of Fuego Tribe, is looking to expand their current use permit (UP 16-18) at 14935 Olympic Drive (Olympic Plaza) allowing cannabis cultivation in order to modify the existing site plan and include manufacturing, distribution, nursery, and retail delivery spanning both parcels. The City recently removed the limit on the amount of cultivation, manufacturing, distribution, testing laboratory, nursery, processing, and delivery-only dispensary permits within the existing commercial cannabis combining district, for which both properties are zoned. No new structures have been proposed and the remodel of the existing structures has been included for review. The City ordinance requires a development agreement and use permit approval, aside from other standard business license/seller's permit requirements. For additional information please see the attached application packet or contact the planning department.

If you have any questions feel free to reach out to me; please submit your comments no later than December 22.

Best,



Susanna Amaro-Gutierrez

Assistant Planner

City of Clearlake

14050 Olympic Drive

Clearlake, CA 95422

(707) [994-8201](tel:994-8201) ext: 103



City of Clearlake

14050 Olympic Drive, Clearlake, California 95422
(707) 994-8201 Fax (707) 995-2653

DEVELOPMENT COORDINATION REVIEW

CITY DEPARTMENTS

- Building Inspection
- Code Enforcement
- Fire (Lake County Fire District)
- Police
- Public Works/Engineering

COUNTY AGENCIES

- Air Quality Management
- Environmental Health
- Flood Control
- Lake County Water Resources
- Planning
- Public Works
- Special Districts (sewers)
- Lake County Transit

STATE AGENCIES

- CalTrans
- Fish and Game
- Sonoma State University
- State Clearing House
- Water Resources

FEDERAL AGENCIES

- Fish and Wildlife
- U.S. Department of Agriculture

OTHER

- Elem Indian Colony
- Middletown Rancheria
- Koi Nation of Northern California
- Water District (Highlands Water Company)
- PG & E
- Cannabis Agencies
 - Bureau of Cannabis Control
 - CalCannabis
 - CA Dept. of Public Health

REQUEST: Please review the enclosed Development Plan(s) and return comments by **12/28/20**

Application: UP 06-20 Cannabis Cultivation, 07-20 Manufacturing, 08-20 Distribution, 09-20 Nursery, and 10-20 Retail delivery

DESCRIPTION OF PROJECT: Chandra Martinez, representative of Fuego Tribe, is looking to expand their current use permit (UP 16-18) at 14935 Olympic Drive (Olympic Plaza) allowing cannabis cultivation in order to modify the existing site plan and include manufacturing, distribution, nursery, and retail delivery spanning both parcels. The City recently removed the limit on the amount of cultivation, manufacturing, distribution, testing laboratory, nursery, processing, and delivery-only dispensary permits within the existing commercial cannabis combining district, for which both properties are zoned. No new structures have been proposed and the remodel of the existing structures has been included for review. The City ordinance requires a development agreement and use permit approval, aside from other standard business license/seller's permit requirements. **For additional information please see the attached application packet or contact the planning department.**

LOCATION: 14935 & 14915 Olympic Drive, Clearlake, CA 95422
ASSESSOR'S #: 039-550-450-000 & 039-550-460-000

APPLICANT: Chandra Martinez
ADDRESS: PO Box 4643, Clearlake, CA 95422
PHONE: 707-533-6121
Date Distributed: 12/8/2020

Staff : Mark Roberts & Susanna Gutierrez, Planning Dept.

RETURN DATE REQUESTED: **December 28, 2020**

Comments and/or conditions recommended if project approved for development: (add additional pages if necessary)
Ownership: is Howard Levine, not Fuego Tribe. Whats the setback in commerical district, as the western PL is very close to existing bldg. Is there going to be new striping, paving? Show PLs on site plan. Complete TI cost estimate for calc of building permit fees. May require building code upgrades on items like electrical etc. Does this increase traffic at this location. Consider location of garbage.

Date: 1/2/21 By: David Swartz, City Engineer

(For City of Clearlake use only)
Response Received:

RE: DCR UP Fuego Tribe Commercial Cannabis UP 06-20, 07-20, 08-20, 09-20, 10-20

BCCLocalGov@DCA <BCCLocalGov@dca.ca.gov>

Mon 12/21/2020 4:12 PM

To: Susanna Amaro-Gutierrez <sgutierrez@clearlake.ca.us>; cdfa.CalCannabis_Local_Verification@cdfa.ca.gov <cdfa.CalCannabis_Local_Verification@cdfa.ca.gov>; MCLS.LocalRelations@cdph.ca.gov <MCLS.LocalRelations@cdph.ca.gov>; Ponce, Kevin@CDFA <Kevin.Ponce@cdfa.ca.gov>

📎 1 attachments (7 MB)

RFR Packet Fuego Tribe.pdf;

Good afternoon,

The Bureau of Cannabis Control (BCC) cannot prequalify applications for commercial cannabis activity. When an application is received it will be reviewed against regulations. You can find regulatory information regarding state licensure for commercial cannabis activities regulated by the BCC on our website [here](#). If you have specific questions about State license requirements or the State licensing process please let me know.

Thank you,



Janet Zimmer
Local Liaison/Equity Manager
(916) 465-9057
www.bcc.ca.gov
<https://cannabis.ca.gov>



From: Susanna Amaro-Gutierrez <sgutierrez@clearlake.ca.us>

Sent: Tuesday, December 8, 2020 6:48 PM

To: Andrew White <awhite@clearlakepd.org>; swartz@cecusa.net; Dave Deakins <ddeakins@clearlake.ca.us>; Lee Lambert <llambert@clearlakepd.org>; swartz@cecusa.net; Fahmy Attar <FahmyA@lcaqmd.net>; doug.gearhart@lakecountyca.gov; Tina Rubin <Tina.Rubin@lakecountyca.gov>; kelli.hanlon@lakecountyca.gov; Lori Baca <Lori.Baca@lakecountyca.gov>; a.tyler@elemindiancolony.org; a.garcia@elemindiancolony.org; speterson@middletownrancheria.com; mshaver@middletownrancheria.com; Cory Smith <CSmith@lakecountyfire.com>; Dino Beltran <dbeltran@koination.com>; kn2@koination.com; doug.gearhart@lakecountyca.gov; Jackman, Rex A@DOT <rex.jackman@dot.ca.gov>; Jackman, Rex A@DOT <rex.jackman@dot.ca.gov>; Shupe, James D@DOT <james.shupe@dot.ca.gov>; Stoner, Kyle@Wildlife <Kyle.Stoner@wildlife.ca.gov>; jeff@highlandswater.com; rick@highlandswater.com; cdfa.CalCannabis_Local_Verification@cdfa.ca.gov; MCLS.LocalRelations@cdph.ca.gov; Ponce, Kevin@CDFA <Kevin.Ponce@cdfa.ca.gov>; BCCLocalGov@DCA <BCCLocalGov@dca.ca.gov>

Cc: Mark Roberts <mroberts@clearlake.ca.us>; Alan Flora <aflora@clearlake.ca.us>

Subject: DCR UP Fuego Tribe Commercial Cannabis UP 06-20, 07-20, 08-20, 09-20, 10-20

[EXTERNAL]: sgutierrez@clearlake.ca.us

CAUTION: THIS EMAIL ORIGINATED OUTSIDE THE DEPARTMENT OF CONSUMER AFFAIRS!

DO NOT: click links or open attachments unless you know the content is safe.

NEVER: provide credentials on websites via a clicked link in an Email.

Good Evening,

The City of Clearlake would like to request your review of use permit applications UP 06-20, 07-20, 08-20, 09-20 and 10-20 for a cannabis operation located at 14935 & 14915 Olympic Drive in the C4 Heavy Service Commercial - Light

Industrial zone and Commercial Cannabis overlay district. Please refer to the attachment for further information in addition to the summary below:

Chandra Martinez, representative of Fuego Tribe, is looking to expand their current use permit (UP 16-18) at 14935 Olympic Drive (Olympic Plaza) allowing cannabis cultivation in order to modify the existing site plan and include manufacturing, distribution, nursery, and retail delivery spanning both parcels. The City recently removed the limit on the amount of cultivation, manufacturing, distribution, testing laboratory, nursery, processing, and delivery-only dispensary permits within the existing commercial cannabis combining district, for which both properties are zoned. No new structures have been proposed and the remodel of the existing structures has been included for review. The City ordinance requires a development agreement and use permit approval, aside from other standard business license/seller's permit requirements. For additional information please see the attached application packet or contact the planning department.

If you have any questions feel free to reach out to me; please submit your comments no later than December 22.

Best,



Susanna Amaro-Gutierrez

Assistant Planner

City of Clearlake

14050 Olympic Drive

Clearlake, CA 95422

(707) [994-8201](tel:994-8201) ext: 103

RE: DCR UP Fuego Tribe Commercial Cannabis UP 06-20, 07-20, 08-20, 09-20, 10-20

CDFA CalCannabis Local Verification@CDFA <cdfa.CalCannabis_Local_Verification@cdfa.ca.gov>

Wed 12/9/2020 10:19 AM

To: Susanna Amaro-Gutierrez <sgutierrez@clearlake.ca.us>

Hello Susanna,

Thank you for reaching out to CalCannabis.

I'm not sure this is meant for the CalCannabis, Local Verification unit for a response, but more so for our science staff to review.

I see you have included one of the CalCannabis science supervisors, Kevin Ponce.

I would recommend, also including the CalCannabis Science email box for any future requests so the email can be addressed by the appropriate science staff. Here is the CalCannabis Science email: cdfa.CalCannabis_Scientists@cdfa.ca.gov.

Sincerely,



AIMEE PASCHANE
Local Verification Unit



CalCannabis Cultivation Licensing Division
cdfa.CalCannabis_Local_Verification@cdfa.ca.gov
(916) 263-0801 | (833) CAL-GROW
calcannabis.cdfa.ca.gov



From: Susanna Amaro-Gutierrez <sgutierrez@clearlake.ca.us>

Sent: Tuesday, December 8, 2020 6:48 PM

To: Andrew White <awhite@clearlakepd.org>; swartz@cecusa.net; Dave Deakins <ddeakins@clearlake.ca.us>; Lee Lambert <llambert@clearlakepd.org>; swartz@cecusa.net; Fahmy Attar <FahmyA@lcaqmd.net>; doug.gearhart@lakecountyca.gov; Tina Rubin <Tina.Rubin@lakecountyca.gov>; kelli.hanlon@lakecountyca.gov; Lori Baca <Lori.Baca@lakecountyca.gov>; a.tyler@elemindiancolony.org; a.garcia@elemindiancolony.org; speterson@middletownrancheria.com; mshaver@middletownrancheria.com; Cory Smith <CSmith@lakecountyfire.com>; Dino Beltran <dbeltran@koination.com>; kn2@koination.com; doug.gearhart@lakecountyca.gov; Jackman, Rex A@DOT <rex.jackman@dot.ca.gov>; Jackman, Rex A@DOT <rex.jackman@dot.ca.gov>; Shupe, James D@DOT <james.shupe@dot.ca.gov>; Stoner, Kyle@Wildlife <Kyle.Stoner@wildlife.ca.gov>; jeff@highlandswater.com; rick@highlandswater.com; CDFA CalCannabis Local Verification@CDFA <cdfa.CalCannabis_Local_Verification@cdfa.ca.gov>; MCLS.LocalRelations@cdph.ca.gov; Ponce, Kevin@CDFA <Kevin.Ponce@cdfa.ca.gov>; BCCLocalGov@DCA <BCCLocalGov@dca.ca.gov>

Cc: Mark Roberts <mroberts@clearlake.ca.us>; Alan Flora <aflora@clearlake.ca.us>

Subject: DCR UP Fuego Tribe Commercial Cannabis UP 06-20, 07-20, 08-20, 09-20, 10-20

CAUTION: [External Email] - This email originated from outside of our CDFA organization. Do not click links or open attachments unless you recognize the sender and know the content is expected and is safe.

Good Evening,

The City of Clearlake would like to request your review of use permit applications UP 06-20, 07-20, 08-20, 09-20 and 10-20 for a cannabis operation located at 14935 & 14915 Olympic Drive in the C4 Heavy Service Commercial - Light Industrial zone and Commercial Cannabis overlay district. Please refer to the attachment for further information in addition to the summary below:

Chandra Martinez, representative of Fuego Tribe, is looking to expand their current use permit (UP 16-18) at 14935 Olympic Drive (Olympic Plaza) allowing cannabis cultivation in order to modify the existing site plan and include manufacturing, distribution, nursery, and retail delivery spanning both parcels. The City recently removed the limit on the amount of cultivation, manufacturing, distribution, testing laboratory, nursery, processing, and delivery-only dispensary permits within the existing commercial cannabis combining district, for which both properties are zoned. No new structures have been proposed and the remodel of the existing structures has been included for review. The City ordinance requires a development agreement and use permit approval, aside from other standard business license/seller's permit requirements. For additional information please see the attached application packet or contact the planning department.

If you have any questions feel free to reach out to me; please submit your comments no later than December 22.

Best,



Susanna Amaro-Gutierrez

Assistant Planner

City of Clearlake

14050 Olympic Drive

Clearlake, CA 95422

[\(707\) 994-8201](tel:(707)994-8201) ext: 103

RESOLUTION NO. PC 2021-05

A RESOLUTION OF THE PLANNING COMMISSION OF THE CITY OF CLEARLAKE, CALIFORNIA RECOMMENDING TO THE CITY COUNCIL THE ADOPTION OF AN ORDINANCE APPROVING THE DEVELOPMENT AGREEMENT DA 2021-01 FOR CHANDRA MARTINEZ FOR THE PROPERTY LOCATED AT 14935 & 14915 OLYMPIC DRIVE, CLEARLAKE, CALIFORNIA, APNS: 039-550-450-000; 039-550-460-000

WHEREAS, DEVELOPER owns the real property located at 14935 & 14915 Olympic Drive, identified as Assessor's Parcel Number 039-550-450-000; 039-550-460-000 ("Property") that is the subject of this agreement; and

WHEREAS, CITY is authorized to enter into binding development agreements with persons having legal or equitable interests in real property for the development of such property, pursuant to Section 65864, *et seq.* of the Government Code; and

WHEREAS, the Property is located within the City's GC General Commercial Zoning District and subject to the land use controls identified and reference in, *inter alia*, the pertinent sections of the City's Municipal Code; and

WHEREAS, DEVELOPER intends to operate a cannabis business on the Property including Cultivation, Manufacturing, Nursery, Retail Delivery, and Distribution and has received approval of related activities.

WHEREAS pursuant to 5-25.030 of the Municipal Code, a development agreement for the commercial cannabis business is required by the Municipal Code; and

WHEREAS, DEVELOPER has requested CITY to enter into a development agreement and proceedings have been taken in accordance with 5-25.030 of the Municipal Code and Section 68564, *et seq.* of the Government Code and the rules and regulations of CITY; and

WHEREAS, the Planning Commission has considered this Development Agreement (DA 2021-01 at a duly noticed public hearing.

NOW THEREFORE, THE PLANNING COMMISSION OF THE CITY OF ("PLANNING COMMISSION") HEREBY FINDS AND RESOLVES AS FOLLOWS:

SECTION 1. The property located at 14915 and 14935 Olympic Drive, Clearlake, CA legally described by Assessor's Parcel Number 039-550-450-000 and 039-550-460-000 ("Project Site" and/or "Property").

SECTION 2. The applicant has requested CITY to enter into a development agreement and proceedings have been taken in accordance with Section 68564, *et seq.* of the Government Code and the rules and regulations of CITY.

SECTION 3. On or about March 9th, 2021 the Planning Commission of the City of Clearlake held a duly noticed public hearing at which interested persons had the opportunity to testify and at which the Planning Commission considered the Development Agreement.

SECTION 4. The development agreement proposed herein is consistent with the General Plan of the City of Clearlake in that the Potential Activity consist of a cannabis micro business which is authorized in the zone subject to obtaining conditional use permits from the Planning Commission.

SECTION 5. Conditional Use Permits (UP 06-20, 07-20, 08-20, 09-20 & 10-20) approved by the Planning Commission in compliance with the Municipal Code on March 9, 2021 for a cannabis business permit is not operational until Development Agreement 2021-01 has been approved City Council and executed by the City and the Developer.

SECTION 6. The Planning Commission therefore recommends to the City Council to adopt Development Agreement DA 2021-01 attached hereto as Exhibit 1.

SECTION 7. If any section, division, sentence, clause, phrase or portion of this resolution is for any reason held to be invalid or unconstitutional by a decision of any court of competent jurisdiction, such decision shall not affect the validity of the remaining provisions.

The Secretary shall attest to the adoption of this resolution and shall forward a copy to the applicant, and any person requesting the same.

PASSED AND ADOPTED on this of 9th day of March, 2021 by the following vote:

AYES:
NOES:
ABSENT:
ABSTAIN:

Chairperson, Planning Commission

ATTEST:

City Clerk, Planning Commission

Exhibits: 1- Development Agreement DA 2021-01

RESOLUTION NO. PC 2021-04

A RESOLUTION OF THE PLANNING COMMISSION OF THE CITY OF CLEARLAKE CONCURRING WITH ISSUING AN EXEMPTION UNDER CEQA SECTION 15301 (CLASS 1 – EXISTING FACILITIES) AND APPROVING USE PERMITS UP 06-20, 07-20, 08-20, 09-20 & 10-20 AND COMMERCIAL CANNABIS REGULATORY PERMIT CBRP 01-2021 FOR COMMERCIAL CANNABIS CULTIVATION, MANUFACTURING, DISTRIBUTION, NURSERY, AND RETAIL DELIVERY FOR THE PROPERTY LOCATED AT 14935 & 14915 OLYMPIC DRIVE, UNITS A, B-2, O, G, H, I, K, M & N, CLEARLAKE, CALIFORNIA, APNS: 039-550-450-000 AND 039-550-460-000

WHEREAS, Chandra Martinez applied for approval of Cannabis Business Use Permits 06-20, 07-20, 08-20, 09-20 & 10-20 for cultivation, manufacturing, distribution, nursery, and retail delivery at 14915 and 14935 Olympic Drive, Clearlake, CA, in the GC General Commercial Zoning District, APN#s 039-550-450-000 AND 039-550-460-000; and

WHEREAS, Cannabis Business Use Permit Application UP 06-20, 07-20, 08-20, 09-20 & 10-20 has been made in accordance with Section 18-43 of the Municipal Code, Zoning Regulations, which refers to Commercial Cannabis Uses.

WHEREAS, Commercial Cannabis Regulatory Permit Application CBRP 01-2020 has been made in accordance with Section 5-25.030 (a) of the Municipal Code, Police Regulations, which requires that a regulatory permit for commercial cannabis be granted by the Planning Commission; and

WHEREAS, a companion application has been filed for commercial cannabis operations by Chandra Martinez at the same location at 14915 and 14935 Olympic Drive, Clearlake, CA, in the GC General Commercial Zone, APNs 039-550-450-000 and 039-550-460-000 as follows:

- Development Agreement DA 2021-01 for a Development Agreement for commercial cannabis operations in accordance with Section 5-25.030 (a) of the Municipal Code; and

WHEREAS, the General Plan designates the project site as commercial. As conditioned, the proposed use would be consistent with the General Plan; and

WHEREAS, the project is found to comply with the Zoning Code as conditioned by this use permit; and

WHEREAS, In accordance with Section 18-28.040 of the Zoning Code the use as proposed will not be detrimental to the health, safety, convenience, or general welfare of persons residing or working in the vicinity, or injurious to the property, improvements or potential development in the vicinity with respect to aspects including, but not limited to, the following:

- (a) The nature of the proposed site, including its size and shape, and the proposed size, shape, and arrangement of structures,
- (b) The accessibility and traffic patterns for persons and vehicles, the type and volume of such traffic and the adequacy of proposed off-street parking and loading,

- (c) The safeguards afforded to prevent noxious or offensive emissions such as noise, glare, dust and odor,
- (d) Treatment given, as appropriate, to such aspects as landscaping, screening, open spaces, parking areas, loading areas, service areas, lighting, and signs.

and;

WHEREAS, the project is exempt from environmental review in accordance with Section 153012 of the State CEQA Guidelines under "Existing Facilities"; and

WHEREAS, the Planning Commission has considered this project on this date at a duly noticed public hearing, the staff report, public testimony, and found that the project is compatible with the surrounding area, it will not be detrimental to adjacent property owners or the public at large, and approval is in the public interest.

NOW, THEREFORE, BE IT RESOLVED by the Planning Commission of the City of Clearlake that the project is hereby approved, subject to the following conditions being satisfied:

Conditions of Approval:

1. The use permit approval shall not become effective, operative, vested or final until a Notice of Categorical Exemption has been filed with the State Clearing House and the Lake County Clerk's Office.
2. Construction activities shall be conducted with adequate dust suppression methods, including watering during grading and construction activities to limit the generation of dust or other methods of approval by the Lake County Air Quality Management District.
3. The permit holder shall operate in full compliance with fire safety rules and regulations of the Lake County Fire District.
4. The Planning Commission may revoke or modify the permit in the future if the Commission finds that the use to which the permit allows is detrimental to health, safety, comfort, general welfare of the public; constitutes a public nuisance; if the permit was obtained or is being used by fraud; and/or if one or more the conditions upon which a permit was granted are in noncompliance or have been violated. Applicant shall be notified of potential violations of the use permit prior to action taken by the Planning Commission.
5. Cannabis Business Use Permit Application UP Permits 06-20, 07-20, 08-20, 09-20 & 10-20 have been made in accordance with Section 18-43 of the Municipal Code, Zoning Regulations, which refers to the Commercial Cannabis Uses
6. The developer/operator shall agree to indemnify, defend, and hold harmless the City or its agents, officers and employees from and against any and all claims, actions, demands or

proceeding (including damage, attorney fees, and court cost awards) against the City or its agents, officers, or employees to attach, set aside, void, or annul an approval of the City, advisory agency, appeal board, or legislative body concerning the permit or entitlement when such action is brought within the applicable statute of limitations. In providing any defense under this Paragraph, the applicant, business operator, property owner, developer shall use counsel reasonably acceptable to the City. The City shall promptly notify the applicant, business operator, property owner, developer of any claim, action, demands or proceeding and the City shall cooperate fully in the defense. If the City fails to promptly notify the developer/operator of any claim, action, or proceeding, or if the City fails to cooperate fully in the defense, the developer/operator shall not thereafter be responsible to defend, indemnify, or hold the City harmless as to that action. The City may require that the developer/operator to post a bond, in an amount determined to be sufficient, to satisfy the above indemnification and defense obligation. Developer/operator understands and acknowledges that City is under no obligation to defend any claim, action, demand or proceeding challenging the City's actions with respect to the permit or entitlement.

7. The Use Permits UP 06-20, 07-20, 08-20, 09-20 & 10-20 may be transferred to new owner's subject to obtaining a new commercial cannabis regulatory permit, upon the new owner's written agreement to maintain all conditions of approval.

8. The developer/operator shall be responsible to pay all sales, use, business and other applicable taxes, and all license, registration, and other fees and permits required under federal, state and local law and pursuant to the Development Agreement DA 2021-01 for the project.

9. This developer/operator shall cooperate with the City with respect to any reasonable request to audit the business' books and records for the purpose of verifying compliance with the Municipal Code and this Use Permit and related Development Agreement DA 2021-01 including but not limited to a verification of the amount of taxes required to be paid during any period for the project.

10. This Cannabis Business Use Permits UP 06-20, 07-20, 08-20, 09-20 & 10-20 shall not be operational unless or until a Development Agreement is fully executed by the City and the Development Agreement remains valid.

11. Secure any required permits from the City of Clearlake (Building Department, Planning and Public Works), Fire District, Lake County Air Quality Management District, Lake County Water Resources Department, Lake County Environmental Health Department and/or all applicable Federal, State and local agency permits.

13. The applicant shall install a proper ventilation system as approved by the Lake County Air Quality Control Management District, in order to prevent off site odors from impacting neighboring properties.

14. The applicant will only engage in nonvolatile methods of manufacturing as discussed with and approved by the Lake County Fire Protection District.

15. A fire alarm system shall be installed on site. The alarm notification appliances will activate upon sprinkler flow. Three sets of alarm plans will need to be submitted

16. In accordance with Section 18-12.060 and/or other sections of the Municipal Code and in accordance with requirements made by the Lake County Fire Protection District (per Ordinance No. 2018-801) Lake County Water Resources Department, Lake County Air Quality Management District and Lake County Health Department, the following detailed plans shall be submitted for review and approval by the Planning, Building, and/or Police Departments and other related agencies as applicable prior to operation/occupancy:

- a. Odor Control Plan
- b. Security Plan
- c. Exterior Lighting Plan
- d. Waste/Recycling and Enclosure Plan
- e. Fencing Plan for security of all cannabis businesses in the business center.
- f. Hazardous Materials Mitigation Plan
- g. Air Quality Management and Odor Control Plan
- h. Liquid Waste Management Plan
- i. Property frontage improvements, including new commercial driveway and sidewalk along Olympic Drive.
- k. Landscape and Irrigation for open area in front of Olympic Plaza fronting Olympic Drive.
- l. Parking area restriping plan in compliance with the City's Off-Street Parking Regulations.

These plans shall be implemented in accordance with the approved plans prior to building occupancy or operation. All on-going operation plans shall be maintained in accordance with the approved plans for the life of the operation.

17. All Electrical in the City will be brought up to current code.

18. Fire extinguishers shall be provided and placed in locations which have been approved by the Lake County Fire District.

19. All exits shall adhere to the 2019 California Fire Code Chapter 10.

20. An emergency key Knox Box system shall be installed

21. A final fire safety inspection will be required prior to occupancy.

22. A written declaration of the chemical names and quantities of any Hazardous Material to be used on site shall be provided to the Lake County Environmental Health Department.

~~232.~~ The owner shall allow a City of Clearlake representative or designee to make inspections as deemed necessary in order to assure that the activity being performed under authority of this permit is in accordance with the terms and conditions prescribed herein. The day, time and manner of entry onto the property shall be coordinated with the on-site store or property manager, and shall be conducted at a time and in a manner that minimizes interference with business operations.

~~243.~~ Use Permits UP 06-20, 07-20, 08-20, 09-20 & 10-20 shall be subject to revocation or modification by the Planning Commission if the Commission finds that there has been a) noncompliance with any of the foregoing conditions, or b) the Commission finds that the use for which this permit is hereby granted is so exercised as to be substantially detrimental to persons or property in the neighborhood of the use. Any such revocation shall be preceded by a public hearing noticed and heard pursuant to the City of Clearlake Municipal Code.

~~254.~~ All conditions of Use Permits UP 06-20, 07-20, 08-20, 09-20 & 10-20 are necessary to protect the general health, safety and welfare of the public. If any condition of this entitlement is held to be invalid by a court, then the whole entitlement shall be invalid. The Planning Commission specifically declares that it would not have approved this entitlement unless all of the conditions herein are held as valid.

PASSED AND ADOPTED on this 9th day of March, 2021 by the following vote:

AYES:

NOES:

ABSTAIN:

ABSENT:

Chairman, Planning Commission

ATTEST:

City Clerk, Planning Commission

**BY RECORDING REQUESTED
TO: AND WHEN RECORDED MAIL**

City of Clearlake
14050 Olympic Dr.
Clearlake, CA 95422
Attention: City Clerk

SPACE ABOVE THIS LINE FOR RECORDER'S USE

Recording Fee Exempt per Government Code §27383

DEVELOPMENT AGREEMENT

THIS DEVELOPMENT AGREEMENT (this "Agreement") is made and entered into this _____ day of _____, 2021 (the "Execution Date"), by and between the **CITY OF CLEARLAKE, a California municipal corporation** ("City") and **Chandra Martinez** ("Owner"). City and Owner are sometimes referenced together herein as the "Parties." In instances when a provision hereof applies to each of the Parties individually, either may be referenced as a "Party." The Parties hereby jointly render the following statement as to the background facts and circumstances underlying this Agreement.

RECITALS

- A. The State of California enacted California Government Code Sections 65864 *et seq.* ("Development Agreement Statutes") to authorize municipalities to enter into development agreements with those having an interest in real property to strengthen the public planning process, encourage private participation in comprehensive planning, and reduce the economic risk of development in connection with the development of real property within their jurisdiction.

- B. The purpose of the Development Agreement Statutes is to authorize municipalities, in their discretion, to establish certain development rights in real property for a period of years regardless of intervening changes in land use regulations, to vest certain rights in the developer, and to meet certain public purposes of the local government.
- C. Owner currently holds an option to lease an approximately 25,966 S.F. portion of buildings located at 14915 and 14935 Olympic Drive, City of Clearlake, County of Lake, State of California (the "Site").
- D. Owner intends to operate a cannabis facility and operation. All such cannabis facilities shall operate in accordance with the California State Compassionate Use Act (Health & Safety Code § 11362.5) ("CUA"), the Medical Marijuana Program Act (Health & Safety Code §§ 11362.7 et seq.) ("MMPA"), and the 2008 Guidelines for the Security and Non-Diversion of Marijuana Grown for Medical Use issued by the California Attorney General (the "AG Guidelines"), and Senate Bill 94, the Medicinal and Adult Use of Cannabis Regulation and Safety Act ("MAUCRSA"), creating a unified regulatory structure for adult use and medical cannabis, and all regulations promulgated by the responsible state agencies to implement MAUCRSA (collectively the "California Cannabis Laws"). Prior to operating a cannabis facility, Owner shall be required to obtain use and cannabis business regulatory permits from the City for the facility and operations.
- E. Ultimately, Owner intends to obtain state licenses issued pursuant to MAUCRSA to operate cannabis facilities at the Site, once such licenses are being issued.
- F. Owners presently intend to develop and open a cannabis operation on the Site consistent with the California Cannabis Laws and Project Approvals (known as the "Project").
- G. Owner applied to City for a development agreement and will subsequently need to obtain special use permits and regulatory permits for the Project. This Agreement, and the special use and regulatory permits, when and if issued by the City, shall collectively be referred to as "Project Approvals".
- H. The Project will maintain inventory of cannabis and cannabis products under the California Cannabis Laws.
- I. The City adopted Ordinance No's. 200-2017 and 201-2017 permitting Cannabis Delivery Only Dispensaries and Cannabis Businesses (as those terms are defined in the applicable city ordinances) in strict compliance with the applicable California Cannabis Laws regulating delivery only dispensaries and cannabis cultivation, manufacturing, processing, and distribution under certain conditions and provisions.
- J. City and Owner have agreed that, as a condition of allowing the Project, as defined herein, and due to the unique circumstances of the proposed Project, Owner shall pay to the City a semi-annual fee based on the gross revenue of the operations, and an annual Facility Fee, as hereinafter defined, which fees shall abate if and when the City adopts a tax on Cannabis Delivery Only Dispensaries and Cannabis Businesses.

- K. All procedures of the California Environmental Quality Act (“CEQA”), California Public Resources Code §21000 *et seq.*, and the CEQA guidelines, title 14 of the California Code of Regulations, chapter 3, §15000 *et seq.* have been satisfied as the project is categorically exempt under CEQA guidelines sec. 15301, for modification of existing facilities.
- L. City has given public notice of its intention to adopt this Agreement and has conducted public hearings thereon pursuant to California Government Code §65867. City has found that the provisions of this Agreement and its purposes are consistent with the objectives, policies, general land uses and programs specified in City’s General Plan, zoning code and municipal ordinances.
- M. City, in entering into this Agreement, acknowledges that certain City obligations hereby assumed shall survive beyond the terms of the present Council members, that this Agreement will serve to bind City and future Councils to the obligations hereby undertaken, and that this Agreement shall limit the future exercise of certain governmental and proprietary powers of City. By approving this Agreement, the Council has elected to exercise certain governmental powers at the time of entering into this Agreement rather than defer its actions to some undetermined future date. The terms and conditions of this Agreement have undergone extensive review by City and the Council and have been found to be fair, just and reasonable. City has concluded that the pursuit of the Project will serve the best interests of its citizens and that the public health, safety and welfare are best served by entering into this obligation. Owner has represented to City that it would not consider or engage in the Project absent City approving this Agreement; *i.e.*, assuring Owner that it will enjoy the development rights.
- N. The City agrees that Owner’s land use entitlements for the Project shall vest for the term of this Agreement as described below.
- O. After conducting a duly noticed hearing on March 9, 2021, in conjunction with certain amendments and additions to the City’s Municipal Code, the Planning Commission of the City reviewed, considered and approved the Project and recommended approval of the execution of this Agreement to the City Council. The Planning Commission found the Project: consistent with the objectives, policies, general land uses and programs specified in the general plan; compatible with the uses authorized zoning code; is in conformity with the public necessity, public convenience, general welfare and good land use practices; will not be detrimental to the health, safety and general welfare of the city; will not adversely affect the orderly development of property or the preservation of property values; and will have a positive fiscal impact on the City.
- P. After conducting a duly noticed hearing on March 9, 2021, in conjunction with amendments and additions to the City’s Municipal Code creating an allowable use, appropriate zoning, and comprehensive regulations for the proposed use, and after independent review and consideration, the City Council approved the execution of this Agreement. The City Council found the Project: consistent with the objectives, policies, general land uses and programs specified in the general plan; compatible with the uses authorized in the zoning code; is in conformity with good land use practices; will not be detrimental to the health, safety and general welfare of the City; and is in the best interest of the City of Clearlake and its residents.

NOW, THEREFORE, in consideration of the mutual covenants and agreements contained herein, and other good and valuable consideration, the receipt and legal sufficiency of which are hereby acknowledged, the Parties do hereby agree as follows:

AGREEMENT

1. Binding Effect of Agreement. The Parties agree that the Recitals above are true and correct and intend to be bound by same; the Parties further agree to the incorporation by reference herein of said Recitals, together with all definitions provided and exhibits referenced therein. This Agreement pertains to the Site as described in **Exhibit A (Legal Description)** and shown in **Exhibit B (Site Map)** and incorporates by reference all Development Approvals approved by the City for the Site. Except as otherwise provided in Section 15 of this Agreement, the burdens of this Agreement are binding upon, and the benefits of this Agreement inure to, all successors-in-interest of the Parties and constitute covenants which run with the Site. In order to provide continued notice thereof, the Parties will record this Agreement with the Lake County Recorder. The word "Owner" as previously defined and used herein shall include successor owners, apart from government or quasi-public agencies, of any portion of the Site. Should the size or orientation of any Site component specified above be changed in minor respects, *e.g.*, changed by a lot line adjustment, this Agreement shall not thereby be deemed to have been affected or invalidated, but the rights and obligations of the Parties and their successors shall remain as provided herein.

2. Relationship of the Parties. It is hereby specifically understood and acknowledged that the Project is a private project and that neither City nor Owners will be deemed to be the agent of the other for any purpose whatsoever. City and Owners hereby renounce the existence of any form of joint venture or partnership between or among them and agree that nothing contained herein or in any document executed in connection herewith shall be construed as making City and Owners joint ventures or partners.

3. Term. Except as otherwise specified herein, the term of this Agreement (the "Term") is 3 years from the date the Owner begins commercial operation at the Project Site ("Operation Date"). The Operation Date shall be no later than 12 months following the Execution Date. The Term shall generally be subject to earlier termination or extension as hereinafter provided.

3.1 Term Extension – Third Party Issues. Notwithstanding the Parties' expectation that there will be no limit or moratorium upon the Project's development or the issuance of building or other development related permits (a "Development Limitation") during the Term, the Parties understand and agree that various third parties may take action causing a *de facto* Development Limitation. Consequently, the Term shall be extended for any delay arising from or related to any of the potential Development Limitations that follow in the subsections below for a time equal to the duration of that delay occurring during the Term. No Development Limitation may arise or result from an action or omission by Owner.

3.1.1 Litigation. Any third party-initiated litigation that arises from or is related to

any City action or omission with respect to this Agreement or any subsequent City approval required in connection with the Project's development, or third party-initiated litigation having the actual effect of delaying the Project's development. This extension period related hereto shall include any time during which appeals may be filed or are pending.

3.1.2 Government Agencies. Any delay arising from or related to the act(s) or omission(s) any third party governmental agency, quasi-public entity or public utility, and beyond the reasonable control of Owner.

3.1.3 Force Majeure. Any delay resulting from riot, war, acts of terrorism, an event during the Term creating radioactive or toxic/hazardous contamination, a catastrophic earthquake, flood, fire or other physical natural disaster, excluding weather conditions regardless of severity, strikes or industrial disputes at national level effecting development involved personnel not employed by Owner, their subcontractors or suppliers and effecting an essential portion of the Project's development, excluding any industrial dispute that is specific to development taking place as a part of the Project.

3.2 Term Extensions. The Term of this Agreement will be extended for seven additional years upon a determination of the City Council, by way of resolution of the City Council acted on at a regularly scheduled meeting, that both of the conditions listed in subparts 3.2.1 and 3.2.2 below have been fully satisfied are the Owner is in full compliance:

3.2.1. No Default by Owner. Owner shall not be in default with respect to any provision of this Agreement or any subsequent agreement or understanding between the Parties arising from or related to this Agreement, having received notice from City of said default per this Agreement, or if Owner did in fact default as to this Agreement, upon notice from City, that Owner did cure said default during the period to cure provided herein to City's satisfaction.

3.2.2 Finding of Community Compatibility. The City Council shall review the operations of Owner prior to granting an extension of the term of this Agreement and make a finding that the Project, notwithstanding that the Project activities may not be in precise

technical compliance with the issued regulatory permit and special use permit, continue to be compatible with surrounding land uses and are not detrimental to the public health, safety and general welfare.

3.2.3. Mutual Agreement of Parties. In addition to the process listed above for a seven-year term extension, this Agreement's Term may be extended by mutual agreement of the Parties and formal amendment of this Agreement.

3.3 Termination of Agreement. Upon the termination of this Agreement, either by expiration or otherwise, Owner shall have no right to engage in the Project activities at the Project Site, except as may otherwise be allowed by City ordinance, law or separate development agreement.

4. Defined Terms. As used in this Agreement, the following terms shall have the meanings hereinafter set forth:

4.1. Certified Report. "Certified Report" shall mean a detailed document prepared by Owner on a form acceptable to the City's Director of Finance to report to the City the gross receipts of the Project's operations and sales, as defined herein, in the Project during each semi-annual period starting January 1 and July 1 of each calendar year. Each Certified Report shall be certified as true and correct by a duly-authorized officer of Owner.

4.2. Development Approvals. "Development Approvals" means the land use entitlements approved by the City for the development of site improvements and buildings on the Site which define the permitted uses of the property, the density or intensity of use, and the maximum height and size of proposed buildings.

4.3. Production Fee. "Production Fee" shall mean a semi-annual fee remitted to the City by Owner based on the Gross Receipts of its Project operations, as defined below, in the amount of 5% of gross sales from operations.

4.4. Certification of Non-Income Tax Exemption. Owner certifies that Owner is not income tax exempt under State or Federal Law and that Owner will not file for such an exemption from the Internal Revenue Service or the Franchise Tax Board.

4.5. Facility Fee. Facility Fee shall mean an annual fee remitted to the City by Owner in the amount of \$2 per gross square foot of the entire Project facility. The Facility Fee shall be paid annually, starting July 1st of each year. A late fee of 5% of the amount due shall be added to any payment 5 days past due. Fees later than 30 days past due will constitute a breach subject to Section 20 of this agreement.

4.6. Semi-Annual Production Fee. The semi-annual Production Fee will be due no later than July 30th for the preceding period of January 1st through June 30th and no later than January 31st for the preceding period of July 1st through December 31st. A late fee of 5% of the amount due shall be added to any payment 30 days past due.

4.7. "Land Use Regulations" shall mean all ordinances, resolutions, codes, rules, regulations and official policies of the City governing the development and use of land,

including, without limitation, the permitted use of land, the density or intensity of use, subdivision requirements, timing and phasing of development, the maximum height and size of buildings, the provisions for reservation or dedication of land for public purposes, and the design, improvement and construction and initial occupancy standards and specifications applicable to the Project. "Land Use Regulations" do not include any City ordinance, resolution, code, rule, regulation or official policy governing:

4.7.1. The conduct or taxation of businesses, professions, and occupations applicable to all businesses, professions, and occupations in the City;

4.7.2. Other than as provided in this Agreement, taxes and assessments of general application upon all residents of the City, provided that the taxes and assessments are not imposed for the purpose of taxing the right, power or privilege of developing or improving land (e.g., excise tax) or to directly finance the acquisition or dedication of open space or any other public improvement in respect of which the Developer is paying any fee or providing any improvement pursuant to this Agreement;

4.7.3. The control and abatement of nuisances;

4.7.4. The granting of encroachment permits and the conveyance of rights and interests which provides for the use of, access to or the entry upon public property, as may be approved by mutual agreement between Developer and City; and

4.7.5. The exercise of the power of eminent domain.

4.8. "Existing Land Use Regulations" means all Land Use Regulations in effect as of the approval date of this Agreement, including the Project Approvals.

4.9. "Gross Receipts" means 5% (five percent) for 1) wholesale and retail sales of cannabis products by Owner to third parties.

5. Fee Payments by Owner. In consideration of City's entering into this Agreement and authorizing the development and operation of the Project, the requirements for City services created by the Project, the City insuring Owner's compliance with this Agreement, California Cannabis Laws and the City's municipal ordinances, throughout the Term of this Agreement, Owner shall make the following payments to City:

5.1. Production Fee Payments by Owner. Semi-annual payments of the Production Fee by Owner to the City as specified in Section 7 herein. The obligations of Owner under this Section shall survive the expiration or any earlier termination, as applicable, of this Agreement, but the Production Fee under this Agreement shall cease if any City-wide tax is imposed specifically on Cannabis cultivation.

5.2. Facility Fee Payments by Owner. Annual payments of the Facility Fee by Owner to the City. The obligations of Owner under this Section shall survive the expiration or any earlier termination of this Agreement, but the Facility Fee shall cease if any City-wide tax is imposed specifically on Cannabis cultivation.

5.3. Sales Tax Point of Sale. Owner agrees that Clearlake will be designated as

the point of sale for all operations, as allowed by law.

6. Community Participation. Owner agrees to participate in the community as a good corporate citizen and sponsor events and organizations that improve the community.

6.1. Clearlake Chamber of Commerce. Owner agrees to immediately apply for membership in the Clear Lake Chamber of Commerce and, if accepted, maintain an annual membership in good standing.

7. Payment Procedures. The following payment procedures shall apply during the operation of the Project:

7.1. Remittance of Production Fee/Certified Reports. Within thirty (30) calendar days following the end of each semi-annual period during the Term of this Agreement, Owner shall submit the Certified Report to the City's Finance Director and a payment for the Production Fee for that Operational Period as identified in the Certified Report. Owner shall pay Production Fees to the City on a semi-annual basis without exception. Any material misstatement or misrepresentation in the Certified Report and any failure to pay Production Fees when due shall constitute events of default by Owner subject to the default provisions of this Agreement.

7.2. Maintenance of Records. Owner shall maintain complete records of their operations to substantiate and document the content of each Certified Report. Such records shall include, without limitation, invoices and payments taken by Tenants and/or any operator of the facility. Owner shall maintain such records in a form and location reasonably accessible to the City, following reasonable notice to Owner and/or any operator, for a period of at least five (5) calendar years following Owner's submission of the Certified Report to which the records apply.

7.3. Audit. Within ninety (90) calendar days following the end of each semi-annual payment term, the City may conduct an audit or arrange for a third-party independent audit, at Owner's expense, of Owner records regarding Certified Reports and the Production Fees. The City's Finance Director shall provide at least seven (7) business days written notice of the commencement of such audit to Owner, and shall reasonably attempt to schedule the audit so as to reduce the impact on Tenants' operations as much as is feasible. Owner shall cooperate with the City in completing the audit. If the audit reveals that Owner has underpaid the Production Fee, Owner shall pay such underpaid amounts to the City within thirty (30) calendar days of receipt of written notice from the City's Director of Finance in addition to all costs of the audit, including city staff time and outside consultants. If the audit reveals that the Owner has overpaid any amount of the Production Fee, City shall provide written notification to Owner and shall credit such amount against Owner's subsequent semi-annual payment of Production Fees.

8. Covenants of Owner. During the Term of this Agreement, Owner hereby covenants and agrees with the City as follows:

8.1. Implementation. Owner shall use commercial reasonable efforts to pursue the implementation of the Project as expeditiously as feasible, in the form approved by the City, subject to all applicable laws, this Agreement, the Project Approvals and the Municipal Code.

8.2. Enhanced Design Requirement. Owner shall submit a design plan for the

building and site, for review and approval by the Planning Director, which shall incorporate at a minimum upgraded fencing and landscaping improvements consistent with the Community Character and Design Policies in the City's General Plan.

8.3. Maintain & Operate Project. Owner shall maintain and operate the Project on the Site throughout the Term of this Agreement, in accordance with the Project Approvals and all City, and State laws.

8.4. Hold Harmless. Owner shall defend (with counsel reasonably acceptable to City), indemnify and hold City and its councilpersons, officers, attorneys, agents, contractors, and employees (collectively, the "Indemnified Parties") harmless from and against all losses, costs and expenses (including, without limitation, reasonable attorneys' fees and costs), damages (including, without limitation, consequential damages), claims and liabilities arising from the Project, this Agreement, the approval of the Project, and the activities of Owner, their members, officers, employees, agents, contractors, invitees and any third parties on the Site, from and against any challenges to the validity of this Agreement or other Project Approvals. The obligations of Owner under this Section shall survive the expiration or any earlier termination, as applicable, of this Agreement.

9. Covenants of City. During the Term of this Agreement, City hereby covenants and agrees with Owner as follows:

9.1. Expeditious Services. City shall process applications and address questions and concerns raised by Owner representatives at the "counter" at City Hall as expeditiously as reasonably possible. Upon Owner's request, or if, in an exercise of City's own discretion, City staff determines that it cannot comply with this section, City shall expeditiously engage the services of private contract planners, plan checkers or inspectors ("Private Contractors") to perform such services as may be necessary to assist in processing the project plans as described herein. Compensation of such Private Contractors shall be at Owner's sole cost and expense, inclusive of any administrative cost to City of integrating services by Private Contractors into the project's development processing. Owner shall pay such costs and expenses of Private Contractors via reimbursement to City, per City's applicable policies and procedures. City shall have absolute discretion in the selection of such Private Contractors.

9.2 Vested Rights. During the Term of this Agreement, Owner shall have the vested right and entitlement to develop and operate the Project in accordance with the Existing Land Use Ordinances, in addition to any Cannabis Cultivation Operating Standards adopted by the City Council, which may be amended at the City's discretion. Parties acknowledge that neither the City nor the Owner can at this time predict when or the rate at which or the order in which parts of the Project will be developed. Owner shall have the vested right to develop the Project in such order and at such rate and at such times as Owner deems appropriate in the exercise of its business judgment, provided that Owner is in compliance with the Project Approvals.

9.3 Building Permits and Other Approvals and Permits. Subject to (a) Owner's compliance with this Agreement, the Project Approvals the Existing Land Use Ordinances, the Building Ordinances, and Operating Standards; and (b) payment of the usual and customary fees and charges of general application charged for the processing of such

applications, permits and certificates and for any utility connection, or similar fees and charges of general application, the City shall process and issue to Owner promptly upon application therefore all necessary use permits, building permits, occupancy certificates, regulatory permits, licenses and other required permits for the construction, use and occupancy of the Project, or any portion thereof, as applied for, including connection to all utility systems under the City's jurisdiction and control (to the extent that such connections are physically feasible and that such utility systems are capable of adequately servicing the Project).

9.4 Procedures and Standards. The standards for granting or withholding permits or approvals required hereunder in connection with the development of the Project shall be governed as provided herein by the standards, terms and conditions of this Agreement and the Project Approvals, and to the extent not inconsistent therewith, the Existing Land Use Ordinances, but the procedures for processing applications for such permits or approvals (including the usual and customary fees of general application charged for such processing) shall be governed by such ordinances and regulations as may then be applicable.

10. Effect of Agreement.

10.1 Grant of Right. This Agreement shall constitute a part of the Enacting Ordinance, as if incorporated by reference therein in full. The Parties acknowledge that this Agreement grants to Owner the right and entitlement to develop the Project and use the land pursuant to specified and known criteria and rules as set forth in the Project Approvals and Existing Land Use Ordinances, and to grant the City and the residents of the City certain benefits which they otherwise would not receive.

10.2 Binding on City/Vested Right of Owner. This Agreement shall be binding upon the City and its successors in accordance with and subject to its terms and conditions notwithstanding any subsequent action of the City, whether taken by ordinance or resolution of the City Council, by referendum, initiative, or otherwise. The Parties acknowledge and agree that by entering into this Agreement and relying thereupon, the Owner has obtained, subject to the terms and conditions of this Agreement, a vested right to proceed with its development of the Project as set forth in the Project Approvals and the Existing Land Use Ordinances, and the timing provisions of Section 3, and the City has entered into this in order to secure the public benefits conferred upon it hereunder which are essential to alleviate current and potential problems in the City and to protect the public health, safety and welfare of the City and its residents, and this Agreement is an essential element in the achievement of those goals.

10.3 Future Conflicting Local Laws. If any City law, including ordinances, resolutions, rules, regulations, standards, policies, conditions and specifications (collectively "City Laws") are enacted or imposed by a citizen-sponsored initiative or referendum, or by the City Council directly or indirectly in connection with any proposed initiative or referendum, which City Law would conflict with this Agreement, such City Law shall not apply to the Project Site or Project. The Parties, however, acknowledge that the City's approval of this Agreement and the City Approvals are legislative actions subject to referendum.

10.3.1 Without limiting the generality of the foregoing, no moratorium or other limitation whether relating to the rate, timing, phasing or sequencing of development affecting subdivision maps, building permits, or other Subsequent Approvals shall apply to the Project. Owner agrees and understands that the City does not have authority or jurisdiction over another public agency's authority to grant a moratorium or to impose any other limitation that may affect the Project.

11. Specific Criteria Applicable to Development of the Project.

11.1 Applicable Ordinances. Except as set forth in the Project Approvals and subject to the provisions of Section 10.2 below, the Existing Land Use Ordinances shall govern the development of the Site hereunder and the granting or withholding of all permits or approvals required to develop the Site; provided, however, that (a) Owner shall be subject to all changes in processing, inspection and plan-check fees and charges imposed by City in connection with the processing of applications for development and construction upon the Site so long as such fees and charges are of general application and are not imposed solely with respect to the Project Site, (b) Owner shall abide by the Building Ordinances in effect at the time of such applications, (c) Development Impact Fees to be paid by Owner shall be those in effect at the time permits are issued subject to those fees, and (d) development shall be consistent with current Operating Standards.

11.2 Amendment to Applicable Ordinances. Any change to the Existing Land Use Ordinances that conflicts with the Project Approvals shall nonetheless apply to the Project if, and only if (i) it is consented to in writing by Owner in Owner's sole and absolute discretion; (ii) it is determined by City and evidenced through findings adopted by the City Council that the change or provision is reasonably required in order to prevent a condition dangerous to the public health or safety; (iii) it is required by changes in State or Federal law; (iv) it consists of changes in, or new fees permitted by, Section 4.1; or (v) it is otherwise expressly permitted by this Agreement. The Parties anticipate that the City shall subsequently adopt Operating Standards that govern this type of use, which Regulations, and any amendments thereto, shall apply to the Project.

11.3 Applicability of Zoning Amendments. In the event that the City zoning ordinance is amended by the City in a manner which provides more favorable site development standards for the Project Site or any part thereof than those in effect as of the Effective Date, Owner shall have the right to notify the City in writing of its desire to be subject to all or any such new standards for the remaining term of this Agreement. If City agrees, by resolution of the City Council, such new standards shall become applicable to the Project. Should City thereafter amend such new standards, upon the effective date of such amendment, the original new standards shall continue to apply to the Project as provided above, but Owner may notify City in writing of its desire to be subject to all or any such amended new standards and City shall agree in the manner above provided to apply such amended new standards to the Project.

12. Permitted Delays; Supersedure by Subsequent Laws.

12.1 Permitted Delays. In addition to any other provisions of this Agreement with respect to delay, Owner and City shall be excused from performance of their obligations hereunder during any period of delay caused by acts of mother nature, civil commotion, riots, strikes, picketing, or other labor disputes, shortage of materials or supplies, or damage to or prevention of work in process by reason of fire, floods, earthquake, or other casualties, litigation, acts or neglect of the other party, any referendum elections held on the Enacting Ordinance, or the Land Use Ordinances, or any other ordinance effecting the Project or the approvals, permits or other entitlements related thereto, or restrictions imposed or mandated by governmental or quasi-governmental entities, enactment of conflicting provisions of the Constitution or laws of the United States of America or the State of California or any codes, statutes, regulations or executive mandates promulgated thereunder (collectively, "Laws"), orders of courts of competent jurisdiction, or any other cause similar or dissimilar to the foregoing beyond the reasonable control of City or Owner, as applicable. Each Party shall promptly notify the other Party of any delay hereunder as soon as possible after the same has been ascertained. The time of performance of such obligations shall be extended by the period of any delay hereunder.

12.2 Supersedure of Subsequent Laws or Judicial Action.

12.2.1 The provisions of this Agreement shall, to the extent feasible, be modified or suspended as may be necessary to comply with any new Law or decision issued by a court of competent jurisdiction (a "Decision"), enacted or made after the Effective Date which prevents or precludes compliance with one or more provisions of this Agreement. Promptly after enactment of any such new Law, or issuance of such Decision, the Parties shall meet and confer in good faith to determine the feasibility of any such modification or suspension based on the effect such modification or suspension would have on the purposes and intent of this Agreement. In addition, Owner and City shall have the right to challenge the new Law or the Decision preventing compliance with the terms of this Agreement. In the event that such challenge is successful, this Agreement shall remain unmodified and in full force and effect, except that the Term shall be extended, in accordance with Section 2.1 above, for a period of time equal to the length of time the challenge was pursued, to extent such challenge delayed the implementation of the project.

13. Operating Memoranda. The provisions of this Agreement require a close degree of cooperation between the City and the Owner. It is anticipated due to the term of this Agreement that refinements to the approvals may be appropriate with respect to the details of performance of the City and the Owner. To the extent allowable by law, the Owner shall retain a certain degree of flexibility as provided herein with respect to all matters, items and provisions covered in general under this Agreement. When and if the Owner finds it necessary or appropriate to make changes, adjustments or clarifications, the Parties shall enter into memoranda ("Operating Memoranda") approved by the Parties in writing, which reference this Section of the Agreement. Operating Memoranda are not intended to constitute an amendment to this Agreement but mere ministerial clarifications; therefore, public notices and hearings shall not be required. The City Attorney shall be authorized upon consultation with the Owner, to determine whether a requested clarification may be effectuated pursuant to this Section or

whether the requested clarification is of such character to constitute an amendment to the Agreement which requires compliance with the provisions of this Agreement pertaining to amendments. The authority to enter into such Operating Memoranda is hereby delegated to the City Manager, and the City Manager is hereby authorized to execute any operating Memoranda hereunder without further City Council action.

14. CEQA. All procedures of the California Environmental Quality Act (“CEQA”), California Public Resources Code §21000 *et seq.*, and the CEQA guidelines, Title 14 of the California Code of Regulations, chapter 3, §15000 *et seq.* have been satisfied based on the Project being categorically exempt.

15. Building Permits. Nothing set forth herein shall impair or interfere with the right of City to require the processing of building permits as required by law relating to any specific improvements proposed for the Project pursuant to the applicable provisions of the City’s municipal code, inclusive of such California and International Codes as have been adopted in accord therewith, that are in effect at the time such permits are applied for; provided, however, no such permit processing shall authorize or permit City to impose any condition on and/or withhold approval of any proposed improvement the result of which would be inconsistent with this Agreement.

16. Assignment and Transfer of Rights. Except as otherwise provided in this Section, the burdens of this Agreement are binding upon, and the benefits of this Agreement inure to, all successors-in-interest of the Parties and constitute covenants that run with the Site. Owner, for itself, its heirs, distributees, executors, administrators, legal representatives, successors and assigns, shall not, at any time during the Term, assign, convey, lease, sell or otherwise transfer all or any portion of its rights under this Agreement (“Assignable Rights”) to a third party, a subordinate entity, or a related entity (make an “Assignment”) without the prior written consent of City in each instance, which consent may be withheld in City’s sole discretion. Any assignment in violation of this Section will be void. No permitted assignee of this Agreement may further assign this Agreement without City’s prior written consent.

17. Review for Compliance.

17.1 Periodic Review. Pursuant to CGC §65865.1, City shall engage in an annual review this Agreement, on or before the anniversary of the date of execution, in order to ascertain Owner’s good faith compliance with its terms (the “Periodic Review”). In the event City fails to formally conduct such annual review, Owner shall be deemed to be in full compliance with the Agreement.

18. Amendment or Cancellation. This Agreement may be amended or canceled in whole or in part only by mutual consent of the Parties or in the manner provided in CGC §65865.1 or CGC §65868 and subsection 3.2 above.

18.1 Provide Notice. Provide the other Party with written notice of such State or Federal law or regulation, a copy of such law or regulation and a statement identifying how such law regulation conflicts with the provisions of this Agreement.

18.2 Meet and Confer. Upon notice by one Party to another as to preemption or frustration of this Agreement by law or regulation, the Parties shall promptly meet and confer in good faith and make a reasonable attempt to modify or suspend this Agreement to comply with such applicable Federal or State law or regulation. If the Parties cannot agree on a manner or method to comply with such Federal or State law or regulation, the Parties may, but shall not be required to, engage in alternative dispute resolution.

19. Notices. All notices or other communications required or permitted hereunder shall be in writing and shall be either personally delivered (which shall include delivery by means of professional overnight courier service which confirms receipt in writing [such as Federal Express or UPS]), sent by telecopier or facsimile (“Fax”) machine capable of confirming transmission and receipt, or sent by certified or registered mail, return receipt requested, postage prepaid to the following parties at the following addresses or numbers:

If to City: City of Clearlake
14050 Olympic Drive
Clearlake CA 95422
Attention: City Manager

With copy to: Jones & Mayer, City Attorney

8150 Sierra College Blvd., Suite 190
Roseville California 95661
Attention: Ryan R. Jones, Esq.

If to Owner: Chandra Martinez
Po Box 4643
Clearlake, CA 95422

Notices sent in accordance with this Section shall be deemed delivered upon the: **(a)** date of delivery as indicated on the written confirmation of delivery (if sent by overnight courier service); **(b)** date of actual receipt (if personally delivered by other means); **(c)** date of transmission (if sent by email or telecopier, so long as sender receives actual confirmation that the transmission was received); or **(d)** date of delivery as indicated on the return receipt (if sent

by certified or registered mail, return receipt requested). Notice of change of address shall be given by written notice in the manner detailed in this Section.

20. Breach and Remedies. Notwithstanding any provision of this Agreement to the contrary, Owner shall not be deemed to be in default under this Agreement with respect to any obligation owed solely to City, and City may not terminate or modify Owner's rights under this Agreement, unless City shall have first delivered a written notice of any alleged default to Owner that specifies the nature of such default. If such default is not cured by Owner within sixty (60) days after receipt of such notice of default, or with respect to defaults that cannot be cured within such period, Owner fails to commence to cure the default within thirty (30) days after receipt of the notice of default, or thereafter fails to diligently pursue the cure of such default, City may terminate Owner's rights under this Agreement. Default by any Assignee or Owner's successor in interest shall affect only that portion of the Site owned by such Assignee or successor, and shall not cancel or diminish in any way Owner's rights with respect to any portion of the Site not owned by such Assignee or successor. In the event that a breach of this Agreement occurs, irreparable harm is likely to occur to the non-breaching Party and damages will be an inadequate remedy. To the extent permitted by law, therefore, it is expressly recognized that injunctive relief and specific enforcement of this Agreement are proper and desirable remedies, and it is agreed that any claim by Owner against City for an alleged breach of this Agreement shall be remedied by injunctive relief or an appropriate action for specific enforcement of this Agreement and not by a claim or action for monetary damages.

21. Entire Agreement. This Agreement and the Exhibits herein contain the entire integrated agreement among the Parties. The Parties intend that this Agreement state their agreement in full to each and every one of its provisions. Any prior agreements, understandings, promises, negotiations or representations respecting the matters dealt with herein or the duties of any Party in relation thereto, not expressly set forth in this Agreement, are agreed by all Parties to be null and void.

22. Severability. If any term, provision, condition, or covenant of this Agreement, or the application thereof to any Party or circumstance, shall to any extent be held invalid or unenforceable, the remainder of the instrument, or the application of such term, provision, condition or covenant to persons or circumstances other than those as to whom or which it is held invalid or unenforceable, shall not be affected thereby and each term and provision of this Agreement shall be valid and enforceable to the fullest extent permitted by law.

23. Attorneys' Fees. If the services of any attorney are required by any party to secure the performance of this Agreement or otherwise upon the breach or default of another party, or

if any judicial remedy or arbitration is necessary to enforce or interpret any provisions of this Agreement or the rights and duties of any person in relation to this Agreement, the prevailing party shall be entitled to reasonable attorneys' fees, costs and other expenses, in addition to any other relief to which such party may be entitled. Prevailing party includes (a) a party who dismisses an action in exchange for sums allegedly due; (b) the party that receives performance from the other party of an alleged breach of covenant or a desired remedy, if it is substantially equal to the relief sought in an action; or (c) the party determined to be prevailing by a court of law.

Whenever provision is made in this Agreement for the payment of attorney's fees, such fees shall be payable whether the legal services are rendered by a salaried employee for the party or by independent counsel and shall include such fees as are incurred in connection with any pretrial proceeding, trial or appeal of the action. Any award of damages following judicial remedy or arbitration as a result of the breach of this Agreement or any of its provisions shall include an award of prejudgment interest from the date of the breach at the maximum amount of interest allowed by law.

24. Counterparts. This Agreement may be executed in one or more counterparts, each of which will be deemed an original, but all of which constitute one and the same instrument.

25. Execution of Agreement. The Parties shall sign this Agreement on or within five (5) business days of approval.

26. Authority to Execute. All persons executing this Agreement on behalf of a party warrant that they have the authority to execute this Agreement on behalf of that party.

27. Estoppel Certificate. City shall, at any time and from time to time within ten (10) days after receipt of written notice from Owner so requesting, execute, acknowledge and deliver to Owner a statement in writing: **(a)** certifying that this Agreement is unmodified and in full force and effect (or, if modified, stating the nature of such modification and certifying that this Agreement, as so modified, is in full force and effect); and **(b)** acknowledging that there are no uncured defaults on the part of Owner hereunder or specifying such defaults if any are claimed. Any such statement may be relied upon by any prospective purchaser or encumbrancer of all or any portion of the Site. Upon Owner's written request, City shall issue a certificate of performance evidencing completion of any of Owner's obligation(s) under this Agreement.

28. Encumbrances on Real Property.

28.1 Discretion to Encumber. The Parties hereto agree that this Agreement shall not prevent or limit Owner, in any manner, at Owner's sole discretion, from encumbering the Site or any portion thereof or any improvements thereon then owned by such person with any mortgage, deed of trust or other security device ("Mortgage") securing financing with respect to the Site or such portion. City acknowledges that the lenders providing such financing may require certain modifications, and City agrees, upon request, from time to time, to meet with Owner and/or representatives of such lenders to negotiate in good faith any such request for modification. City further agrees that it will not unreasonably withhold its consent to any such requested modification. Any mortgagee or trust deed beneficiary of the Site or any portion thereof or any improvements thereon and its successors and assigns ("Mortgagee") shall be entitled to the following rights and privileges.

28.2 Lender Requested Modification/Interpretation. City acknowledges that the lenders providing financing to Owner may request certain interpretations and modifications of this Agreement. City therefore agrees upon request, from time to time, to meet with the Owner and representatives of such lenders to negotiate in good faith any such request for interpretation or modification. The City will not unreasonably withhold its consent to any such requested interpretation or modification provided such interpretation or modification is consistent with the intent and purposes of this Agreement, provided, further, that any modifications of this Agreement are subject to the provisions of this Agreement relative to modifications or amendments.

28.3 Mortgage Protection. This Agreement shall be superior and senior to the lien of any Mortgage. Notwithstanding the foregoing, no breach of this Agreement shall defeat, render invalid, diminish or impair the lien of any Mortgage made in good faith and for value, and any acquisition or acceptance of title or any right or interest in or with respect to the Site or any portion thereof by a Mortgagee (whether pursuant to a Mortgage, foreclosure, trustee's sale, deed in lieu of foreclosure or otherwise) shall be subject to all of the terms and conditions of this Agreement.

28.4 Mortgagee Not Obligated. Notwithstanding the provisions of Section 26.2, no Mortgagee will have any obligation or duty under this Agreement to perform the obligations of Owner or other affirmative covenants of Owner hereunder, or to guarantee such performance, except that to the extent that Mortgagee opts to receive the benefits of the Agreement, including the right to operate, any covenant to be performed by Owner is a condition to the performance of a covenant by City, the performance thereof shall continue to be a condition precedent to City's performance hereunder. No Mortgagee will be liable for any monetary defaults arising prior to its acquisition of title to the Site or any portion thereof. Uncured monetary defaults will terminate the Agreement and Mortgagee's right to operate.

28.5 Written Notice of Default. Each Mortgagee shall be entitled to receive written notice from City of any default by Owner under this Agreement, if such default is not

cured within thirty (30) days, provided such Mortgagee has delivered a written request to City for such notice. Each Mortgagee shall have a further right, but not the obligation, to cure such default for a period of thirty (30) days after receipt of such notice of default. Any non-curable defaults of Owner of any obligation owed solely to City arising prior to Mortgagee's acquisition of title to the Site or any portion thereof shall be waived; provided, however, the non-payment of money shall not be deemed a non-curable default.

29. Binding Effect. This Agreement shall be binding on and inure to the benefit of the Parties to this Agreement and, subject to City's written consent, their heirs, personal representatives, successors, and assigns, except as otherwise provided in this Agreement.

30. Governing Law and Venue. This Agreement and the legal relations between the Parties shall be governed by and construed in accordance with the laws of the State of California. Furthermore, the Parties agree to venue in the Superior Court of Lake County, California.

31. Mutual Covenants. The covenants contained herein, including those contained in the Recitals herein, are mutual covenants and also constitute conditions to the concurrent or subsequent performance by the party benefited thereby of the covenants to be performed hereunder by such benefited party.

32. Successors in Interest. The burdens of this Agreement shall be binding upon, and the benefits of this Agreement shall inure to, all successors in interest to the Parties to this Agreement ("Successors"). Furthermore, the rights and remedies, together with the benefits and burdens of this Agreement of each Party to this Agreement shall be coextensive with those of its Successors. All provisions of this Agreement shall be enforceable as equitable servitude's and constitute covenants running with the land. Each covenant to do or refrain from doing some act hereunder with regard to development of the Site: (a) is for the benefit of and is a burden upon every portion of the Site; (b) runs with the Site and each portion thereof; and, (c) is binding upon each Party and each Successor during ownership of the Site or any portion thereof. From and after recordation of this Agreement, the Agreement shall impute notice to all persons and entities in accord with the recording laws of this State.

33. No Third Party Beneficiaries. This Agreement is made and entered into for the sole protection and benefit of the Parties and their Successors and Assignees. No other person or entity shall have any right of action based upon any provision of this Agreement.

34. Waiver. Failure by a Party to insist upon the strict performance of any of this

Agreement's provisions by the other party, or the failure by a Party to exercise its rights upon the default of the other Party, shall not constitute a waiver of such Party's right to insist and demand strict compliance by the other Party with the terms of this Agreement thereafter. The waiver by any party to this Agreement of a breach of any provision of this Agreement shall not be deemed a continuing waiver or a waiver of any subsequent breach of that or any other provision of this Agreement.

35. Time of Essence. Time is of the essence in the performance of the provisions of this Agreement as to which time is an element.

36. Recordation of Agreement. This Agreement and any amendment or cancellation thereof shall be recorded with the County Recorder by the City Clerk within the period required by Government Code Section 65868.5.

37. Headings. The headings in this Agreement are inserted for convenience only. They do not constitute part of this Agreement and shall not be used in its construction.

38. Jointly Drafted. It is agreed among the parties that this Agreement was jointly negotiated and jointly drafted by the Parties and their respective counsel, and that it shall not be interpreted or construed in favor of or against any party solely on the ground that it drafted the Agreement. It is also agreed and represented by all Parties that said Parties were of equal or relatively equal bargaining power and that in no way whatsoever shall this Agreement be deemed to be a contract of adhesion, or unreasonable or unconscionable.

39. Independent Legal Counsel. Each party acknowledges that it has been represented by independent legal counsel of its own choice throughout all of the negotiations that preceded the execution of this Agreement or has knowingly and voluntarily declined to consult legal counsel, and that each Party has executed this Agreement with the consent and on the advice of such independent legal counsel.

40. Further Cooperation. The parties herein agree to execute any and all agreements, documents or instruments as may be reasonably necessary in order to fully effectuate the agreements and covenants of the Parties contained in this Agreement, or to evidence this Agreement as a matter of public record, if required to fulfill the purposes of this Agreement. The Parties further agree to mutually cooperate with one another in carrying out the purposes of this

Agreement.

41. Enforceability. This Agreement shall not become binding and shall have no force and effect whatsoever until such time as it has been fully executed by and delivered to all of the parties hereto.

IN WITNESS WHEREOF, the undersigned have executed this Agreement as of the Execution Date.

"CITY"

CITY OF CLEARLAKE, CA a California
Municipal Corporation

Date: _____, 2021

By: _____

Mayor

Attest:

By: _____

City Clerk

Approved as to form:

Jones & Mayer

By: _____

Ryan R. Jones, Esq.

City Attorney

“OWNER”

Chandra Martinez

By: _____

Date: _____, 2021

Chandra Martinez

EXHIBIT A
LEGAL DESCRIPTION
To be inserted later

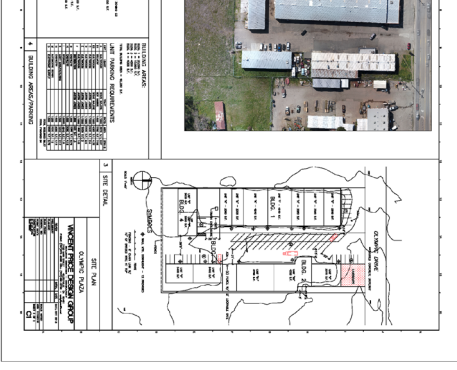

EXHIBIT C
SITE LEASE

To be inserted later

ACKNOWLEDGEMENT

A notary public or other officer completing this certificate verifies only the identity of the individual who signed the document to which this certificate is attached, and not the truthfulness, accuracy, or validity of that document.

STATE OF CALIFORNIA }

COUNTY OF _____ }

On _____ before me,

(insert name and title of the officer)

personally _____ appeared
_____ , who proved to me on the
basis of satisfactory evidence to be the person(s) whose name(s) is/are subscribed to the
within instrument and acknowledged to me that he/she/they executed the same in
his/her/their authorized capacity(ies), and that by his/her/their signature(s) on the
instrument the person(s), or the entity upon behalf of which the person(s) acted, executed
the instrument.

I certify under PENALTY OF PERJURY under the laws of the State of California
that the foregoing paragraph is true and correct.

WITNESS my hand and official seal.

Signature of Notary