

***DRAFT***

## **GEOTECHNICAL REPORT**

**Camas Business Center  
4707 and 4723 – Northwest Lake Road  
Camas, Washington**

**Project No. T-8553**

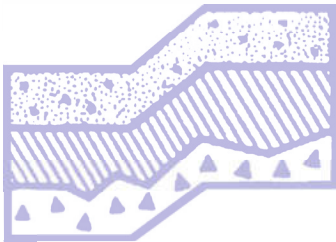

**Terra Associates, Inc.**

**Prepared for:**

**Panattoni Development Company  
Tacoma, Washington**

**July 12, 2021**

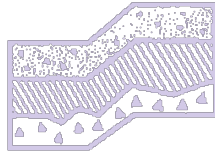

# TERRA ASSOCIATES, Inc.

Consultants in Geotechnical Engineering, Geology  
and  
Environmental Earth Sciences

July 12, 2021  
Project No. T-8553

Mr. Bjorn Brynstad  
Panattoni Development Company  
1821 Dock Street, Suite 100  
Tacoma, Washington 98402

**DRAFT**

Subject: Geotechnical Report  
Camas Business Center  
4707 and 4723 – Northwest Lake Road  
Camas, Washington

Dear Mr. Brynstad:

As requested, we have conducted a geotechnical engineering study for the subject project. The attached report presents our findings and recommendations for the geotechnical aspects of project design and construction.

Our field exploration indicates the site is generally underlain by 1 to 11 inches of organic topsoil overlying medium stiff to very stiff silts with varying amounts of sand and gravel to the termination of the test pits. Test pits in the central and south-central portions of the site terminated in deposits of medium dense sands with varying silt and gravel contents. Additionally, Columbia River Basalt was encountered in the north and north-central portions of the site within the upper three to nine feet. Groundwater was observed in 28 of the 80 test pits at depths of 2.5 to 12 feet.

In our opinion, soil and groundwater conditions at the site will be suitable for support of the development as planned, provided recommendations contained herein are incorporated into project design and construction specifications.

We trust the information provided in the attached report is sufficient for your current needs. If you have any questions or need additional information, please call.

Sincerely yours,  
**TERRA ASSOCIATES, INC.**

Michael J. Xenos, E.I.T.  
Staff Engineer

**DRAFT**

Carolyn S. Decker, P.E.  
Project Engineer

## TABLE OF CONTENTS

	<u>Page No.</u>
1.0	Project Description..... 1
2.0	Scope of Work ..... 1
3.0	Site Conditions..... 2
3.1	Surface ..... 2
3.2	Soils..... 2
3.3	Groundwater ..... 3
3.4	Geologic Hazards..... 3
3.4.1	Erosion Hazard Areas ..... 3
3.4.2	Landslide Hazard Areas ..... 5
3.4.3	Seismic Hazard Areas ..... 5
3.5	Seismic Site Class ..... 6
4.0	Discussion and Recommendations..... 6
4.1	General..... 6
4.2	Site Preparation and Grading ..... 7
4.3	Preload/Surcharge ..... 8
4.4	Excavations ..... 9
4.5	Foundations..... 9
4.6	Floor Slabs ..... 10
4.7	Stormwater Facilities ..... 11
4.8	Infiltration Feasibility ..... 12
4.9	Drainage..... 12
4.10	Utilities..... 13
4.11	Pavements ..... 13
5.0	Additional Services ..... 14
6.0	Limitations ..... 115

### Figures

Vicinity Map.....	Figure 1
Exploration Location Plan.....	Figure 2
Settlement Marker Detail.....	Figure 3
Typical Wall Drainage Detail.....	Figure 4

### Appendices

Field Exploration and Laboratory Testing.....	Appendix A
---	------------

# **Geotechnical Report Camas Business Center 4707 and 4723 – Northwest Lake Road Camas, Washington**

## **1.0 PROJECT DESCRIPTION**

The project consists of developing the site with six industrial buildings with dock-high loading, along with a stormwater pond, associated access, parking, and utility improvements. Based on preliminary site plans prepared by Synthesis PLLC dated February 23, 2021, final floor areas are expected to range from approximately 35,775 square feet to 301,500 square feet. The preliminary site plans also show a stormwater pond in the northwestern portion of the site. Grading plans were not available at the time of this report. Based on the existing site topography we expect cuts and fills of up to approximately 10 feet will be required to achieve final pad elevations across the building area.

We anticipate the building will be constructed using precast reinforced concrete tilt-up perimeter wall panels with interior isolated columns supporting a steel or wood-truss roof system. We expect structural loads will be light, about 100 to 150 kips for isolated columns and 4 to 6 kips per foot for continuous perimeter bearing walls. Maximum product loading on the floors is not expected to exceed 350 pounds per square foot (psf).

The recommendations contained in the following sections of this report are based on the above design features. If actual features vary or changes are made, we should review them in order to modify our recommendations, as required. We should review the final design drawings and specifications to verify our recommendations have been properly interpreted and incorporated into project design and construction.

## **2.0 SCOPE OF WORK**

Our work was completed in accordance with our authorized proposal dated January 21, 2021. Accordingly, on May 24, 2021, through May 26, 2021, we observed soil and groundwater conditions at 80 test pits excavated to maximum depths of 6 to 12 feet below current site grades. Using the information obtained from this subsurface exploration, we performed analyses to develop geotechnical recommendations for development at the site.

Specifically, this report addresses the following:

- Soil and groundwater conditions.
- Seismic design parameters per the current International Building Code (IBC).
- Geologic Hazards per the City of Camas Municipal Code.
- Site preparation and grading.
- Building preload/surcharge program.
- Excavations.



- Foundations including foundation alternatives.
- Slab-on-grade floors.
- Stormwater facilities.
- Infiltration feasibility.
- Drainage.
- Utilities.
- Pavements.

Recommendations outlined in this report regarding drainage are associated with soil strength, design earth pressures, erosion, and stability. Design and performance issues with respect to moisture as it relates to the structure environment are beyond Terra Associates, Inc.'s purview. A building envelope specialist or contractor should be consulted to address these issues, as needed.

### **3.0 SITE CONDITIONS**

#### **3.1 Surface**

The site consists of 2 tax parcels totaling approximately 74 acres located at 4707 and 4723 NW Lake Road in Camas, Washington. The approximate site location is shown on Figure 1.

The site is currently occupied by 3 structures in the south-central portion of the site along with associated access and landscaping. The remainder of the site is vacant and predominately covered with brush and weeds, with the exception of the northwestern portion, which is covered with mature trees. Site topography in the southern portion of the site generally consists of a slope that descends from the east to the west with an overall relief of approximately 42 feet. At the approximate midpoint of the site from north to south, there is a moderate-to-steep slope that descends from the south to the north with an overall relief of approximately 48 feet. The grade then transitions to a slight slope, that continues to descend to the north with an overall relief of approximately 20 feet.

#### **3.2 Soils**

In general, the soil conditions at the site consist of approximately 1 to 11 inches of organic topsoil overlying 3 to 12 feet of medium stiff to very stiff silt with varying amounts of sand and gravel to the termination of the test pits. There were instances, most notably in the central and south-central portions of the site, where the test pits terminated in deposits of medium dense sand with silt and silty sand (with varying gravel contents), and similar deposits were occasionally exposed in the very north and southwest portions of the site. Additionally, Columbia River Basalt was encountered in the north and north-central portions of the site within the upper 3 to 9 feet. Test Pits TP-21 and TP-35, as well as several test pits located in the southwest of the site, also contained one to 6 feet of gravel with silt and sand to silty gravel with sand material underlying the upper silts. We observed, approximately 3 feet of fill material in Test Pit TP-78 with occasional organic and construction debris.

The *Geologic Map of the Camas Quadrangle, Clark County, Washington*, by R.C. Evarts and J.E. O'Connor (2008) maps the site as Quarternary-tertiary Sedimentary Conglomerate (Qt<sub>c</sub>). This map unit is consistent with the underlying basalt bedrock observed in our field explorations. However, the upper silts, sands, and gravels observed in the test pits are more consistent with Sand and Silt Facies (Qf<sub>s</sub>), and Gravel Facies (Qfg), which are mapped roughly 1,000 feet to the southwest and 2,000 feet to the northeast, respectively.

The preceding discussion is intended to be a brief review of the soil conditions observed at the site. More detailed descriptions are presented on the Test Pit Logs attached in Appendix A. The approximate location of the test pits is shown on attached Figure 2.

### **3.3 Groundwater**

We observed minor to moderate groundwater seepage in 8 of the 80 test pits excavated. Groundwater was primarily observed in the test pits north of the wetland area, as well as in test pits located in the central, south-central, and southwest portions of the site at depths ranging from approximately 2.5 to 12 feet below existing grades. The observed seepage was typically observed within sandy or gravelly deposits, or perched within sandy seams or around pockets of gravel contained within the silt deposits.

Our observations in the test pits indicate observed groundwater levels correspond with the local groundwater table associated with Lacamas Creek located approximately 2,400 feet to the northeast. Groundwater seepage depth observations were made during the late spring, so groundwater is expected to be between seasonal high and seasonal low levels.

Mottled soils were observed throughout many of the test pits which indicated the presence of perched groundwater throughout much of the site. The occurrence of shallow perched groundwater is typical for sites underlain by fine-grained soils or relatively shallow bedrock. Fluctuations in the static groundwater level will occur seasonally. Typically, groundwater will reach maximum levels during the wet winter months. Based on our experience with groundwater conditions in the area, we would expect the seasonal high groundwater level to reach up to existing site grades.

### **3.4 Geologic Hazards**

Chapter 16.59.010 of the City of Camas Municipal Code (CMC) defines geologic hazards as "...areas susceptible to erosion hazard, landslide hazard, seismic hazard, mine hazard, and other geologic events." We have evaluated the site for these hazards in the following sections below.

#### ***3.4.1 Erosion Hazard Areas***

Chapter 16.59.020.A of the CMC defines erosion hazard areas as "...areas where there is not a mapped or designated landslide hazard, but where there are steep slopes equal to or greater than forty percent slope. Steep slopes which are less than ten feet in vertical height and not part of a larger steep slope system, and steep slopes created through previous legal grading activity are not regulated steep slope hazard areas."

The majority of the soils observed on the site are classified as Hesson clay loam, 0 to 8 percent slopes, in the south and northeast, and Powel silt loam, 0 to 8 percent slopes in the north by the United States Department of Agriculture Natural Resources Conservation Service (NRCS). Additionally, pockets of soils classified as Cove silty clay loam, thin solum, 0 to 3 percent slopes are located throughout the site. Over the site with existing slope gradients, these soils will have a slight to moderate potential for erosion when exposed.

The soils classified as Hesson clay loam, 8 to 20 percent slopes located at the approximate north-south midpoint along the moderate-to-steep slope will have a severe potential for erosion when exposed. Therefore, it is our opinion that an erosion hazard exists along the moderate-to-steep slope in the approximate center of the site.

Implementation of temporary and permanent Best Management Practices (BMPs) for preventing and controlling erosion will be required and will mitigate the erosion hazard. At a minimum, we recommend implementing the following erosion and sediment control BMPs prior to, during, and immediately following construction activities at the site.

### ***Prevention***

- Limit site clearing and grading activities to the relatively dry months (typically May through September).
- Limit disturbance to areas where construction is imminent.
- Locate temporary stockpiles of excavated soils no closer than ten feet from the crest of the slope.
- Provide temporary cover for cut slopes and soil stockpiles during periods of inactivity. Temporary cover may consist of durable plastic sheeting is securely anchored to the ground surface or straw mulch.
- Establish permanent cover by seeding, in conjunction with a mulch cover or appropriate hydroseeding, over exposed areas that will not be disturbed for a period of 30 days or more.

### ***Containment***

- Install a silt fence along site margins and downslope of areas that will be disturbed. The silt fence should be in place before clearing and grading is initiated.
- Intercept surface water flow and route the flow away from the slope to a stabilized discharge point. Surface water must not discharge at the top or onto the face of the steep slope.
- Provide onsite sediment retention for collected runoff.

The contractor should perform a daily review and maintenance of all erosion and sedimentation control measures at the site.

### **3.4.2 *Landslide Hazard Areas***

Chapter 16.59.020.B of the CMC defines landslide hazard areas as "...areas potentially subject to landslides based on a combination of geologic, topographic, and hydrologic factors. They include areas susceptible because of any combination of bedrock, soil, slope (gradient), slope aspect, structure, hydrology, or other factors. Examples of these may include, but are not limited to the following:

1. Areas of pervious slope failures including areas of unstable old or recent landslides;
2. Areas with all three of the following characteristics:
  - a. Slopes steeper than 15 percent,
  - b. Hillsides intersecting geologic contacts with permeable sediments overlying a low permeability sediment or bedrock, and
  - c. Any springs or ground water seepage;
3. Slopes that are parallel or sub-parallel to planes of weakness, such as bedding planes, joint systems and fault planes in subsurface materials;
4. Areas mapped by:
  - a. Washington Department of Natural Resources Open File Report: Slope Stability of Clark County, 1975, as having potential instability, historical or active landslides, or as older landslide debris, and
  - b. The Washington Department of Natural Resources Open File Report: Geologic Map of the Vancouver Quadrangle, Washington and Oregon, 1987, as landslides;
5. Slopes greater than eighty percent, subject to rock fall during earthquake shaking;
6. Areas potentially unstable as a result of rapid stream incision, stream bank erosion, and stream undercutting the toe of the slope;
7. Areas located in a canyon or on an active alluvial fan, presently or potentially subject to inundation by debris flows, debris torrents, or catastrophic flooding."

The onsite slopes do not match any of the above descriptions nor is the site located on the Washington Department of Natural Resources' Geologic Landslide Hazard Map. Therefore, in our opinion, the site does not present a landslide hazard as defined by the CMC in our opinion.

### **3.4.3 *Seismic Hazard Areas***

Chapter 16.59.020.C of the CMC defines seismic hazard areas as "... areas that are subject to severe risk of damage as a result of earthquake-induced soil liquefaction, ground shaking amplification, slope failure, settlement, or surface faulting. Relative seismic hazard is mapped on the NEHRP site class map of Clark County, published by the Washington Department of Natural Resources."

Liquefaction is a phenomenon where there is a reduction or complete loss of soil strength due to an increase in water pressure induced by vibrations. Liquefaction mainly affects geologically recent deposits of fine-grained sands underlying the groundwater table. Soils of this nature derive their strength from intergranular friction. The generated water pressure or pore pressure essentially separates the soil grains and eliminates this intergranular friction; thus, eliminating the soil's strength.

The NEHRP Site Class Map of Clark County, published by the Washington State DNR and dated September 2004, classifies the site as Seismic Site Class B to C, which typically present negligible risk for soil liquefaction. Additionally, based on the soil and groundwater conditions we observed, the risk for soil liquefaction occurring at the site is negligible due to the relative density of the soils and amount of cohesive material that would be sufficient to resist the cyclical loading of a seismic event. Columbia River Basalt likely underlies most of the site as evidenced by the north and north-central test pits. Therefore, in our opinion, the site would not be considered a seismic hazard area as defined by the CMC.

### **3.5 Seismic Site Class**

Based on soil conditions observed in the test pits and our knowledge of the area geology, per Chapter 16 of the 2018 International Building Code (IBC), Site Class "C" should be used in structural design.

## **4.0 DISCUSSION AND RECOMMENDATIONS**

### **4.1 General**

Based on our study, development of the site as proposed is feasible from a geotechnical engineering standpoint. The primary geotechnical concern at the site is the presence of soil strata susceptible to consolidation under the planned building loads. The compressible soils consist of layers of medium stiff to very stiff silts that vary in thickness across the site. These soils are compressible and, if not mitigated, will likely experience unacceptable levels of differential settlement under proposed project loads.

Given the depth to the compressible silt layers, in our opinion, the potential post-construction building settlements can be mitigated by implementing a preload/surcharge program. This would entail raising site grades to finish floor elevation for a period of time to induce settlements prior to application of building loads. Building construction can begin after completion of the preload/surcharge program. The building can be supported on conventional spread footings bearing on the preload structural fill. Floor slabs can be similarly supported on the preload structural fill and pavements can be supported on structural fill or compacted native soils.

If building schedules do not allow for a surcharge program to take place, the building can be supported on ground improved by installing vibrated stone columns, which would preclude the need for a fill surcharge program.

The upper silt soils and lower silty sand to silty gravel soils observed at the site contain a significant amount of fines and will be difficult to compact as structural fill when too wet. The ability to use native soil soils from site excavations as structural fill will depend on its moisture content and the prevailing weather conditions at the time of construction. If grading activities will take place during winter, the owner should be prepared to import clean granular material for use as structural fill and backfill. Alternatively, stabilizing the moisture in the native and existing fill soils with cement or lime can be considered.

Detailed recommendations regarding these issues and other geotechnical design considerations are provided in the following sections. These recommendations should be incorporated into the final design drawings and construction specifications.

#### **4.2 Site Preparation and Grading**

To prepare the site for construction, all vegetation, organic surface soils, and other deleterious material should be stripped and removed from the site. Surface stripping depths of 1 to 11 inches should be expected to remove the organic surface soils and vegetation. In the developed portions of the site, demolition of existing structures should include removal of existing foundations and buried asphalt, and abandonment of underground septic systems and other buried utilities. Abandoned utility pipes that fall outside of new building areas can be left in place, provided they are sealed to prevent intrusion of groundwater seepage and soil. Organic topsoil will not be suitable for use as structural fill, but may be used for limited depths in nonstructural areas.

Once clearing and stripping operations are complete, cut and fill operations can be initiated to establish desired building grades. Prior to placing fill, all exposed bearing surfaces should be observed by a representative of Terra Associates, Inc. to verify soil conditions are as expected and suitable for support of new fill or building elements. Our representative may request a proofroll using heavy rubber-tired equipment to determine if any isolated soft and yielding areas are present. If excessively yielding areas are observed and they cannot be stabilized in place by compaction, the affected soils should be excavated and removed to firm bearing and grade restored with new structural fill. If the depth of excavation to remove unstable soils is excessive, the use of geotextile fabrics such as Mirafi 500X or an equivalent fabric can be used in conjunction with clean granular structural fill. Our experience has shown, in general, a minimum of 18 inches of a clean, granular structural fill placed and compacted over the geotextile fabric should establish a stable bearing surface.

Our study indicates a majority of the native soils contain a sufficient percentage of fines (silt- and clay-sized particles) that will make them difficult to compact as structural fill if they are too wet or too dry. Accordingly, the ability to use these upper native soils from site excavations as structural fill will depend on their moisture content and the prevailing weather conditions when site grading activities take place. Soils that are too wet to properly compact could be dried by aeration during dry weather conditions or mixed with an additive such as cement or lime to stabilize the soil and facilitate compaction. If an additive is used, additional Best Management Practices (BMPs) for its use will need to be incorporated into the Temporary Erosion and Sedimentation Control plan (TESC) for the project.

Additionally, the bedrock soils will be difficult to reuse as structural fill. If bedrock is used, it will need to be crushed into pieces that are smaller than 6 inches in diameter and then compacted in 6 inch lifts.

If grading activities are planned during the wet winter months, or if they are initiated during the summer and extend into fall and winter, the contractor should be prepared to import wet-weather structural fill. For this purpose, we recommend importing a granular soil that meets the following grading requirements:

<b>U.S. Sieve Size</b>	<b>Percent Passing</b>
6 inches	100
No. 4	75 maximum
No. 200	5 maximum*

\*Based on the 3/4-inch fraction.

Prior to use, Terra Associates, Inc. should examine and test all materials to be imported to the site for use as structural fill.

Structural fill should be placed in uniform loose layers not exceeding 6 or 12 inches and compacted to a minimum of 95 percent of the soil's maximum dry density, as determined by American Society for Testing and Materials (ASTM) Test Designation D-698 (Standard Proctor). The moisture content of the soil at the time of compaction should be within two percent of its optimum, as determined by this ASTM standard. In nonstructural areas, the degree of compaction can be reduced to 90 percent.

#### **4.3 Preload/Surcharge**

We recommend preloading the building area to limit building and floor slab settlements to tolerable levels. For this procedure, we recommend placing structural fill in the building areas to the design floor elevation, and delaying building construction until settlement under this fill load has occurred. The preload fill should extend a minimum of two feet beyond the building perimeter. A minimum fill depth of five feet is recommended.

Total settlement under the preload/surcharge fill is estimated in the range of 8 to 13 inches. These settlements are expected to occur in about 4 to 6 weeks following full application of the building fill.

To verify the amount of settlement and the time rate of movement, the preload program should be monitored by installing settlement markers. The settlement markers should be installed on the existing grade prior to placing any building or preload fills. Once installed, elevations of both the fill height and marker should be taken daily until the full height of the preload is in place. Once fully preloaded, readings should continue weekly until the anticipated settlements have occurred. A typical settlement marker detail is provided as Figure 3.

It is critical that the grading contractor recognize the importance of the settlement marker installations. All efforts must be made to protect the markers from damage during fill placement. It is difficult, if not impossible, to evaluate the progress of the preload program if the markers are damaged or destroyed by construction equipment. As a result, it may be necessary to install new markers and extend the surcharging time period in order to ensure that settlements have ceased and building construction can begin.

#### **4.4 Excavations**

All excavations at the site associated with confined spaces, such as those for utility construction, must be completed in accordance with local, state, or federal requirements. Based on current Washington Industrial Safety and Health Act (WISHA) regulations, the lower medium dense sands and medium dense to dense gravels found on the project site would be classified as Type C soils. The upper, medium stiff to very stiff silts would be classified as Type B soil.

Accordingly, temporary excavations in Type C soils should have their slopes laid back at an inclination of 1.5:1 (Horizontal:Vertical) or flatter, from the toe to the crest of the slope. Side slopes in Type B soils can be laid back at a slope inclination of 1:1 or flatter. If there is insufficient space to complete the excavations in this manner, or if excavations greater than 20 feet in depth are planned, temporary shoring to support the excavations may be required. Properly designed and installed shoring trench boxes can be used to support utility trench excavations where required.

Based on our study, groundwater should be anticipated within excavations extending below depths of about 7 to 12 feet below native surface grades. Excavations extending below this depth may encounter groundwater with volumes and flow rates sufficient to require some level of dewatering. Shallow excavations that do not extend more than two to three feet below the groundwater table can likely be dewatered by conventional sump-pumping procedures along with a system of collection trenches. Deeper excavations will require dewatering by well points or isolated deep-pump wells. The utility subcontractor should be prepared to implement excavation dewatering by well point or deep-pump wells, as needed. This will be an especially critical consideration for any deep excavations such for lift stations and sanitary sewer tie-ins.

This information is provided solely for the benefit of the owner and other design consultants and should not be construed to imply that Terra Associates, Inc. assumes responsibility for job site safety. It is understood that job site safety is the sole responsibility of the project contractor.

#### **4.5 Foundations**

Following the completion of the preload program. The building may be supported on conventional spread footing foundations bearing on subgrade prepared as recommended in Section 4.2 of this report. Perimeter foundations exposed to the weather should bear at a minimum depth of 1.5 feet below final exterior grades for frost protection. Interior foundations can be constructed at any convenient depth below the floor slab.

Building foundations should bear on a minimum of two feet of structural fill that replaces the native silt soils.

We recommend designing foundations bearing on two feet of structural fill for a net allowable bearing capacity of 2,500 psf. For short-term loads, such as wind and seismic, a one-third increase in this allowable capacity can be used. Following successful completion of the preload/surcharge program, with structural loading as anticipated and this bearing stress applied, estimated total foundation settlements of about one-inch and differential settlement of ½-inch should be expected.



For designing foundations to resist lateral loads, a base friction coefficient of 0.35 can be used. Passive earth pressures acting on the sides of the footings can also be considered. We recommend calculating this lateral resistance using an equivalent fluid weight of 300 pounds per cubic foot (pcf). We recommend not including the upper 12 inches of soil in this computation because it can be affected by weather or disturbed by future grading activity. This value assumes the foundations will be backfilled with structural fill as described in Section 4.2 of this report. The values recommended include a safety factor of 1.5.

### ***Ground Improvement***

As an alternative to the surcharging the building foundations, the buildings can be supported on improved ground using vibrated stone columns. This method creates highly densified columns of graded aggregate that would extend through the upper medium stiff soils into the underlying medium dense to dense sands and gravels. Due to the methods used to construct the columns, some improvement of the adjacent soils is also realized. Moreover, these methods can provide liquefaction mitigation by providing drainage paths and reduced pore pressures during ground shaking, and by constructing stiff, non-liquefiable inclusions in the soils. Once constructed, conventional spread footing foundations can be designed to bear immediately above the stone columns.

These ground improvement techniques are typically completed on a design/build approach with both design and construction completed by a specialty contractor. We can assist in contracting and selecting the specialty contractor, if desired.

### **4.6 Floor Slabs**

Slab-on-grade floors may be supported on subgrade prepared as recommended in Section 4.2 of this report. Immediately below the floor slabs, we recommend placing a four-inch-thick capillary break layer of clean, free-draining, coarse sand or fine gravel that has less than five percent passing the No. 200 sieve. This material will reduce the potential for upward capillary movement of water through the underlying soil and subsequent wetting of the floor slabs.

The capillary break layer will not prevent moisture intrusion through the slab caused by water vapor transmission. Where moisture by vapor transmission is undesirable, such as covered floor areas, a common practice is to place a durable plastic membrane on the capillary break layer, then cover the membrane with a layer of clean sand or fine gravel to protect it from damage during construction and aid in uniform curing of the concrete slab. It should be noted, if the sand or gravel layer overlying the membrane is saturated prior to pouring the slab, it will be ineffective in assisting in uniform curing of the slab and can actually serve as a water supply for moisture transmission through the slab and affecting floor coverings. Therefore, in our opinion, covering the membrane with a layer of sand or gravel should be avoided if floor slab construction occurs during the wet winter months and the layer cannot be effectively drained. We recommend floor designers and contractors refer to the current American Concrete Institute (ACI) Manual of Concrete Practice for further information regarding vapor barrier installation below slab-on-grade floors.

With the subgrade prepared as recommended, design of the floor slab for storage rack loading and lift truck vehicle traffic, a subgrade modulus of 100 pounds per square inch per inch of deflection (pci) can be used.

#### **4.7 Stormwater Facilities**

No stormwater plans were available at the time of this report.

##### ***Detention Vault***

If onsite detention will be provided by a buried vault, we expect that the bottom of the excavation would likely expose native, medium dense sands with silt, medium dense to dense silty gravels with sand, stiff to very stiff silts, and/or hard, moderately weathered Columbia River Basalt. Vault foundations supported by these native soils may be designed for an allowable bearing capacity of 4,000 psf provided that the foundation subgrade is at least 8 feet below current site grades. For short-term loads, such as seismic, a one-third increase in this allowable capacity can be used. Wet subgrade conditions that are easily disturbed by construction traffic will be exposed at the bottom of the vault excavation. To maintain a stable foundation subgrade, the native soils should be overexcavated a minimum depth of 12 inches below foundation grade and restored with clean 1 ¼-inch to 2-inch crushed rock.

Vault walls should be designed as below-grade retaining walls. The magnitude of earth pressure development on engineered retaining walls will partly depend on the quality of the wall backfill. We recommend placing and compacting wall backfill as structural fill as described in Section 4.2 of this report. To prevent overstressing the walls during backfilling, heavy construction machinery should not be operated within 5 feet of the wall. Wall backfill in this zone should be compacted with hand-operated equipment. To prevent hydrostatic pressure development, wall drainage must also be installed. A typical wall drainage detail is shown on Figure 4.

With the recommended wall backfill and drainage, we recommend designing the vault walls for an earth pressure imposed by an equivalent fluid weighing 50 pcf. Any portion of the wall for which drainage cannot be provided should be designed for an earth pressure equivalent to a fluid weighing 85 pcf. For evaluating walls under seismic loading, an additional uniform earth pressure equivalent to  $8H$  psf, where  $H$  is the height of the below-grade wall in feet, can be used. These values assume a horizontal backfill condition. Where applicable, a uniform horizontal traffic value of 75 psf should be included in design of vault walls.

The detention vault will be subject to uplift pressures if drainage is not provided for the detention vault walls. For design, uplift forces should be based on a groundwater elevation equal to the current ground surface. The weight of the structure and the weight of the soil above its foundation will provide resistance to uplift. A soil unit weight of 120 pcf can be used in designing the structure to resist uplift forces.

##### ***Detention Pond***

If fill berms will be constructed, the berm locations should be stripped of topsoil, duff, and soils containing organic material prior to the placement of fill. The fill berms should be constructed by placing structural fill in accordance with recommendations outlined in Section 4.2 of this report. Material used to construct pond berms should consist of predominately granular soils with a maximum size of 3 inches and a minimum of 20 percent fines.

Terra Associates, Inc. should examine and test all onsite or imported materials proposed for use as berm fill prior to their use.

It is possible that pockets of sandy or gravelly soils may be exposed within the pond area. Therefore, it may be necessary to line the dead storage portion of the pond for water quality purposes depending on the final grades and exposed soils.

Due to the exposure to fluctuating stored water levels and wave action, soils exposed on the interior side slopes of the ponds may be subject to some risk of periodic shallow instability or sloughing. Establishing interior slopes at a 3:1 gradient will significantly reduce or eliminate this potential. Exterior berm slopes and interior slopes above the maximum water surface should be graded to a finished inclination no steeper than 2:1. Finished slope faces should be thoroughly compacted and vegetated to guard against erosion.

We should review the stormwater plans when they are completed and revise our recommendations, if required.

#### **4.8 Infiltration Feasibility**

Based on our study, subsurface conditions are generally not favorable for infiltration of site stormwater. The surficial silt soils and relatively shallow silty sand soils observed at the site contain a high percentage of soil fines that would impede any downward migration of site stormwater. Additionally, the relatively shallow bedrock observed in the north and north-central portions of the site likely underlies the rest of the site and would not be a suitable receptor of site stormwater. Even low impact development (LID) techniques would likely fill up and overtop during rain events and cause minor local flooding. While zones of sands with silt and gravels were observed below the upper silts in the southwest and north portions of the site, there is an insufficient volume of material to support infiltration and many of these soils contained observable groundwater seepage which indicates site stormwater could not properly infiltrate into these deposits. Based on these soil conditions, infiltration at the site is not feasible and the stormwater should be managed using a conventional system.

#### **4.9 Drainage**

##### ***Surface***

Final exterior grades should promote free and positive drainage away from the site at all times. Water must not be allowed to pond or collect adjacent to foundations or within the immediate building areas. We recommend providing a positive drainage gradient away from the building perimeters. If this gradient cannot be provided, surface water should be collected adjacent to the structures and directed to appropriate storm facilities.

##### ***Subsurface***

In our opinion, with floor slabs at or elevated above the adjacent exterior grade, and positive drainage away from the structure maintained, installation of conventional perimeter foundation drains would not be necessary for the industrial grade building.

If positive drainage away from the building perimeters is not provided, or where landscaping is completed adjacent to the buildings, we recommend installing a continuous drain along the outside lower edge of the perimeter building foundations. The drains can be laid to grade at an invert elevation equivalent to the bottom of footing grade. The drains can consist of four-inch diameter perforated PVC pipe that is enveloped in washed half- to three-quarter-inch gravel-sized drainage aggregate. The aggregate should extend six inches above and to the sides of the pipe. The foundation drains and roof downspouts should be tightlined separately to an approved point of controlled discharge. All drains should be provided with cleanouts at easily accessible locations and should be serviced at least once each year.

#### **4.10 Utilities**

Utility pipes should be bedded and backfilled in accordance with American Public Works Association (APWA), or City of Camas specifications. As a minimum, trench backfill should be placed and compacted as structural fill, as described in Section 4.2 of this report. As noted, the native soils are moisture sensitive and close moisture control will be required to facilitate proper compaction. If utility construction takes place during the wet winter months, it will likely be necessary to import suitable wet weather fill for utility trench backfilling.

The utility contractor should also be prepared for encountering unstable soft alluvial soils below the pipe invert elevations. If not removed from below the pipe and replaced with crushed rock or additional bedding material, pipe deflections may occur as a result of the soil yielding and compressing in response to loading imposed during trench backfilling. The need to overexcavate and stabilize the pipe foundation before backfilling should be evaluated by observation and testing during construction. We recommend utilizing pipe connections that can accommodate the anticipated settlements discussed above.

#### **4.11 Pavements**

Pavement subgrades should be prepared as described in Section 4.2 of this report. Regardless of the degree of relative compaction achieved, the subgrade must be firm and relatively unyielding before paving. The subgrade should be proofrolled with heavy rubber-tired construction equipment such as a loaded 10-yard dump truck to verify this condition.

The pavement design section is dependent upon the supporting capability of the subgrade soils and the traffic conditions to which it will be subjected. We expect traffic at the facility will consist of cars and light trucks, along with heavy traffic in the form of tractor-trailer rigs. For design considerations, we have assumed traffic in parking and in car/light truck access pavement areas can be represented by an 18-kip Equivalent Single Axle Loading (ESAL) of 50,000 over a 20-year design life. For heavy traffic pavement areas, we have assumed an ESAL of 300,000 would be representative of the expected loading. These ESALs represent loading approximately equivalent to 3 and 18, loaded (80,000-pound GVW) RV rigs traversing the pavement daily in each area, respectively.

With a stable subgrade prepared as recommended, we recommend the following options for pavement sections:

Light Traffic and Parking:

- Two inches of hot mix asphalt (HMA) over six inches of crushed rock base (CRB)
- Full depth HMA – 4 inches

Heavy Traffic:

- Three inches of HMA over 8 inches of CRB
- Full depth HMA – 5.5 inches

For exterior Portland cement concrete (PCC) pavement, we recommend the following:

- 6 inches of PCC over two inches of CRB
  - 28-day compressive strength – 4,000 psi
  - Control joints spaced at a maximum of 15 feet.

Soil cement stabilization or constructing a soil cement base for support of the pavement section can also be considered as an alternative to the above conventional pavement sections. Assuming a properly constructed soil cement base having a minimum thickness of 12 inches and a minimum 7-day compressive strength of 100 pounds per square inch (psi), a minimum HMA pavement thickness of 3 inches would be required for the heavy traffic areas. The design of the soil cement base should be completed using samples of the subgrade exposed at the time of construction.

The paving materials used should conform to the Washington State Department of Transportation (WSDOT) specifications for half-inch class HMA, PCC, and CRB.

Long-term pavement performance will depend on surface drainage. A poorly drained pavement section will be subject to premature failure resulting from surface water infiltrating the subgrade soils and reducing their supporting capability. For optimum performance, we recommend surface drainage gradients of at least two percent. Some degree of longitudinal and transverse cracking of the pavement surface should be expected over time. Regular maintenance should be planned to seal cracks as they occur.

## **5.0 ADDITIONAL SERVICES**

Terra Associates, Inc. should review project designs and specifications to verify that earthwork and foundation recommendations have been properly interpreted and incorporated into project design. We should also provide geotechnical services during construction to observe compliance with our design concepts, specifications, and recommendations. This will allow for expedient design changes if subsurface conditions differ from those anticipated prior to the start of construction.

## **6.0 LIMITATIONS**

We prepared this report in accordance with generally accepted geotechnical engineering practices. No other warranty, expressed or implied, is made. This report is the copyrighted property of Terra Associates, Inc. and is intended for specific application to the Camas Business Center in Camas, Washington. This report is for the exclusive use of Panattoni Development Company and their authorized representatives.

The analyses and recommendations presented in this report are based on data obtained from the subsurface explorations completed onsite. Variations in soil conditions can occur, the nature and extent of which may not become evident until construction. If variations appear evident, Terra Associates, Inc. should be requested to reevaluate the recommendations in this report prior to proceeding with construction.

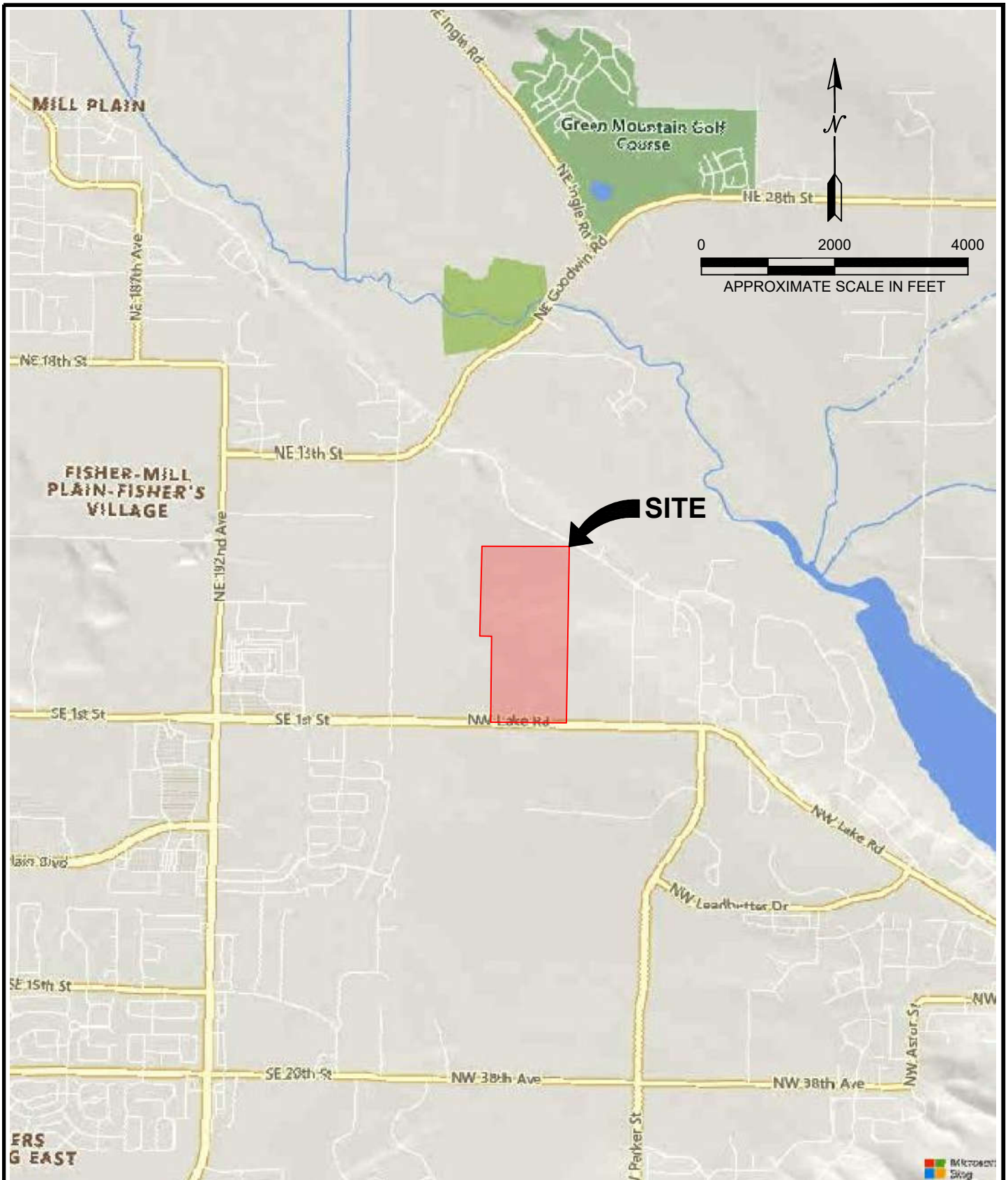

REFERENCE: <https://www.bing.com/maps>

ACCESSED 6/11/2021

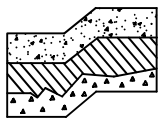

**Terra Associates, Inc.**  
 Consultants in Geotechnical Engineering  
 Geology and  
 Environmental Earth Sciences

VICINITY MAP  
 CAMAS BUSINESS CENTER  
 VANCOUVER, WASHINGTON

Proj.No. T-8553

Date: JUNE 2021

Figure 1

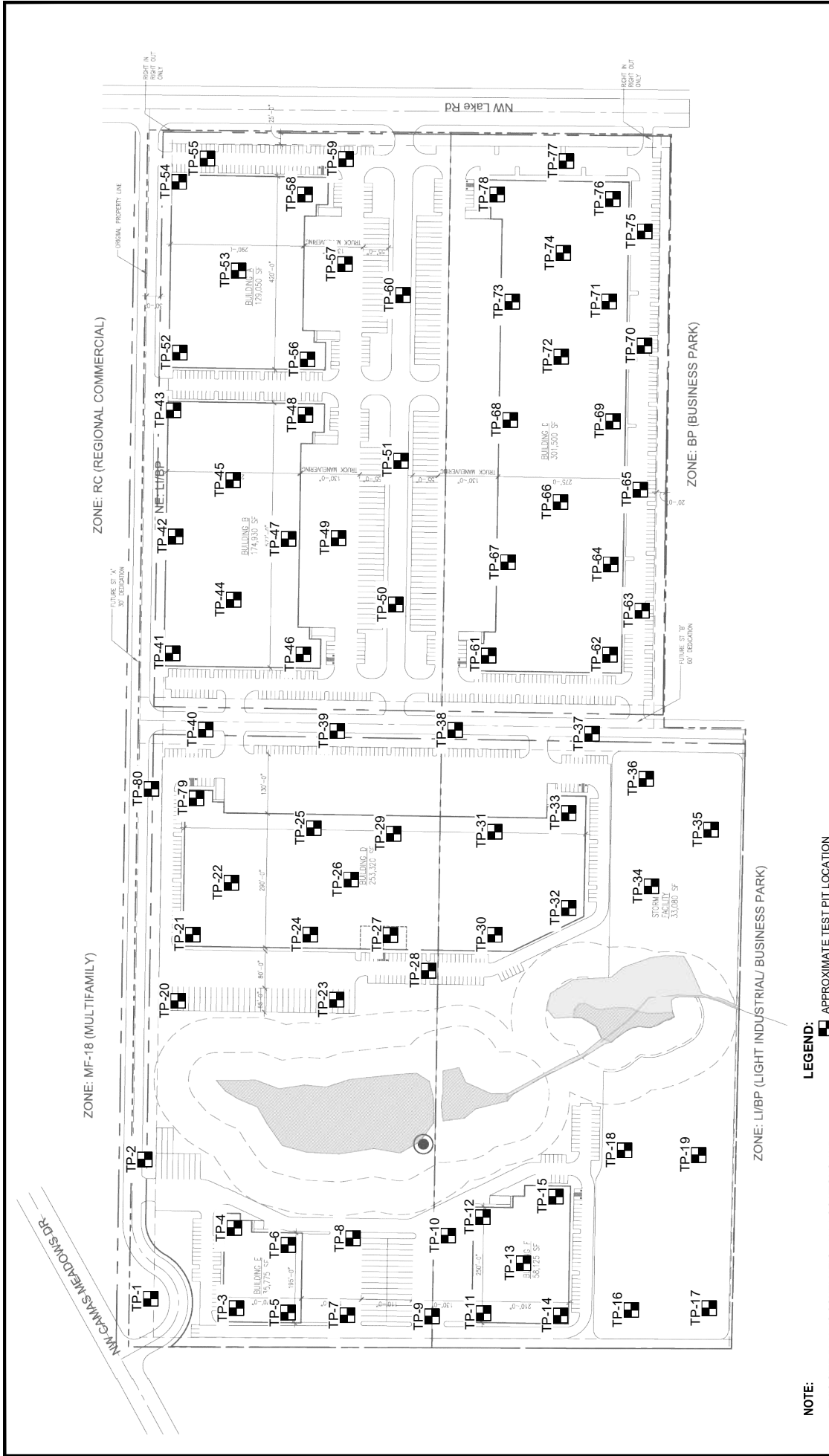



**Terra Associates Inc.**  
Consultants in Geotechnical Engineering  
Construction Management  
Environmental Earth Sciences

**EXPLORATION LOCATION PLAN**  
CAMAS BUSINESS CENTER  
VANCOUVER, WASHINGTON

Proj.No. T-8553      Date: JUNE 2021      Figure 2

**NOTE:**  
THIS SITE PLAN IS SCHEMATIC. ALL LOCATIONS AND DIMENSIONS ARE APPROXIMATE. IT IS INTENDED FOR REFERENCE ONLY AND SHOULD NOT BE USED FOR DESIGN OR CONSTRUCTION PURPOSES.  
**REFERENCE:** SITE PLAN PROVIDED BY PANATTONI.

**LEGEND:**  APPROXIMATE TEST PIT LOCATION

0      200      400  
APPROXIMATE SCALE IN FEET



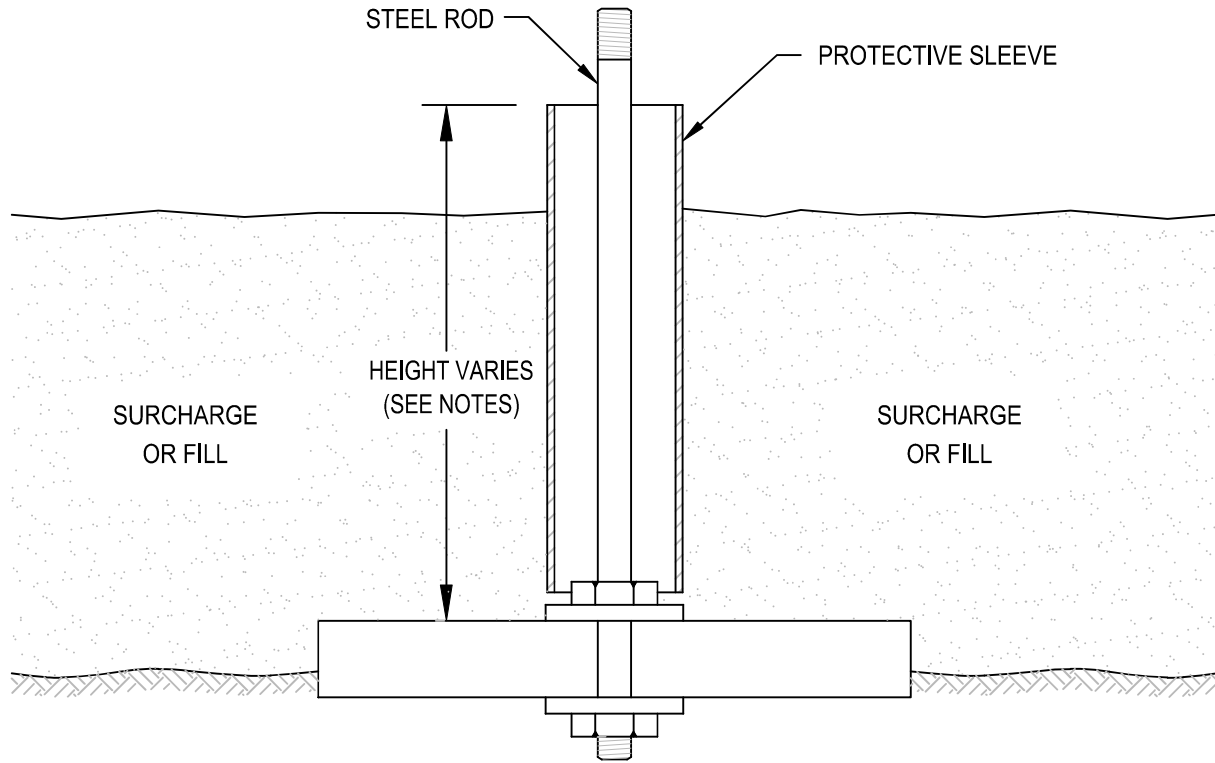

NOT TO SCALE

**NOTES:**

1. BASE CONSISTS OF 3/4" THICK, 2'x2' PLYWOOD WITH CENTER DRILLED 5/8" DIAMETER HOLE.
2. BEDDING MATERIAL, IF REQUIRED, SHOULD CONSIST OF CLEAN COARSE SAND.
3. MARKER ROD IS 1/2" DIAMETER STEEL ROD THREADED AT BOTH ENDS.
4. MARKER ROD IS ATTACHED TO BASE BY NUT AND WASHER ON EACH SIDE OF BASE.
5. PROTECTIVE SLEEVE SURROUNDING MARKER ROD SHOULD CONSIST OF 2" DIAMETER PLASTIC TUBING. SLEEVE IS NOT ATTACHED TO ROD OR BASE.
6. ADDITIONAL SECTIONS OF STEEL ROD CAN BE CONNECTED WITH THREADED COUPLINGS.
7. ADDITIONAL SECTIONS OF PLASTIC PROTECTIVE SLEEVE CAN BE CONNECTED WITH PRESS-FIT PLASTIC COUPLINGS.
8. STEEL MARKER ROD SHOULD EXTEND AT LEAST 6" ABOVE TOP OF PLASTIC PROTECTIVE SLEEVE.
9. PLASTIC PROTECTIVE SLEEVE SHOULD EXTEND AT LEAST 1" ABOVE TOP OF FILL SURFACE.

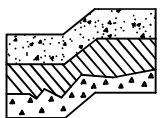

**Terra Associates, Inc.**  
 Consultants in Geotechnical Engineering  
 Geology and  
 Environmental Earth Sciences

SETTLEMENT MARKER DETAIL  
 CAMAS BUSINESS CENTER  
 VANCOUVER, WASHINGTON

Proj.No. T-8553

Date: JUNE 2021

Figure 3

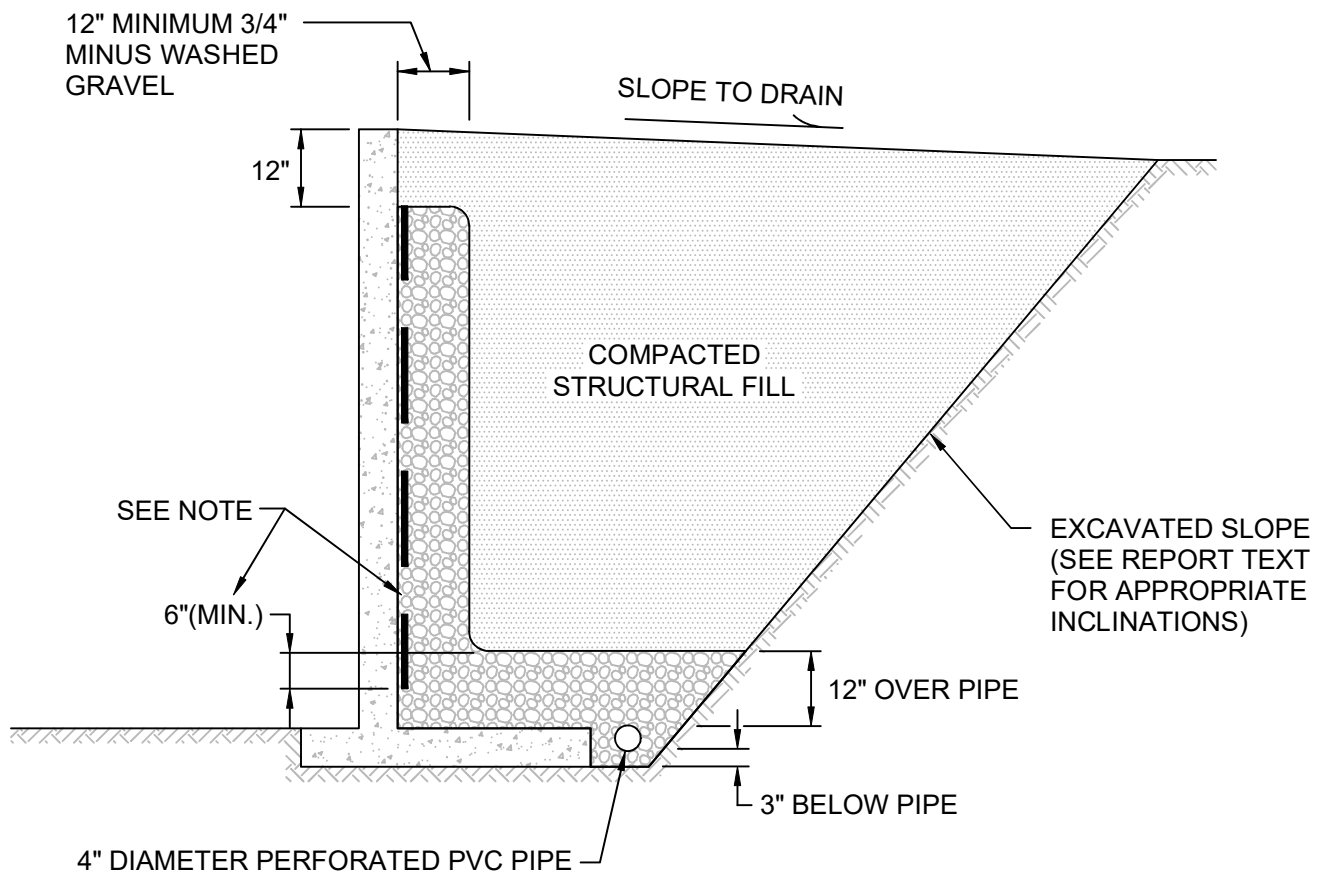

**NOT TO SCALE**

**NOTE:**

MIRADRAIN G100N PREFABRICATED DRAINAGE PANELS OR SIMILAR PRODUCT CAN BE SUBSTITUTED FOR THE 12-INCH WIDE GRAVEL DRAIN BEHIND WALL. DRAINAGE PANELS SHOULD EXTEND A MINIMUM OF SIX INCHES INTO 12-INCH THICK DRAINAGE GRAVEL LAYER OVER PERFORATED DRAIN PIPE.

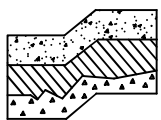

**Terra Associates, Inc.**  
 Consultants in Geotechnical Engineering  
 Geology and  
 Environmental Earth Sciences

TYPICAL WALL DRAINAGE DETAIL  
 CAMAS BUSINESS CENTER  
 VANCOUVER, WASHINGTON

Proj.No. T-8553

Date: JUNE 2021

Figure 4

**APPENDIX A**  
**FIELD EXPLORATION AND LABORATORY TESTING**

**Camas Business Center**  
**Camas, Washington**



On May 24, 2021, through May 26, 2021, we completed our site exploration by observing soil conditions at 80 test pits. The test pits were excavated using a track-mounted excavator to maximum depths of approximately 6 to 12 feet below existing site grades. Test pit locations were determined in the field by measuring from existing site features. The approximate location of the test pits is shown on the attached Exploration Location Plan, Figure 2. Test Pit Logs are presented on Figures A-2 through A-81.

A geotechnical engineer from our office conducted the field exploration. Our representative classified the soil conditions encountered, maintained a log of each test pit, obtained representative soil samples, and recorded water levels observed during excavation. All soil samples were visually classified in accordance with the Unified Soil Classification System (USCS) described on Figure A-1.

Representative soil samples obtained from the test pits were placed in sealed plastic bags and taken to our laboratory for further examination and testing. The moisture content of selected samples was measured and is reported on the corresponding Test Pit Logs. Grain size analyses were also performed on select samples. The results are shown on Figures A-82 and A-83.

MAJOR DIVISIONS			LETTER SYMBOL	TYPICAL DESCRIPTION	
<b>COARSE GRAINED SOILS</b>	More than 50% material larger than No. 200 sieve size	<b>GRAVELS</b> More than 50% of coarse fraction is larger than No. 4 sieve	Clean Gravels (less than 5% fines)	GW	Well-graded gravels, gravel-sand mixtures, little or no fines.
				GP	Poorly-graded gravels, gravel-sand mixtures, little or no fines.
		Gravels with fines	GM	Silty gravels, gravel-sand-silt mixtures, non-plastic fines.	
			GC	Clayey gravels, gravel-sand-clay mixtures, plastic fines.	
	More than 50% of coarse fraction is smaller than No. 4 sieve	<b>SANDS</b> More than 50% of coarse fraction is smaller than No. 4 sieve	Clean Sands (less than 5% fines)	SW	Well-graded sands, sands with gravel, little or no fines.
				SP	Poorly-graded sands, sands with gravel, little or no fines.
		Sands with fines	SM	Silty sands, sand-silt mixtures, non-plastic fines.	
			SC	Clayey sands, sand-clay mixtures, plastic fines.	
<b>FINE GRAINED SOILS</b>	More than 50% material smaller than No. 200 sieve size	<b>SILTS AND CLAYS</b> Liquid Limit is less than 50%	ML	Inorganic silts, rock flour, clayey silts with slight plasticity.	
			CL	Inorganic clays of low to medium plasticity. (Lean clay)	
			OL	Organic silts and organic clays of low plasticity.	
	<b>SILTS AND CLAYS</b> Liquid Limit is greater than 50%	MH	Inorganic silts, elastic.		
		CH	Inorganic clays of high plasticity. (Fat clay)		
		OH	Organic clays of high plasticity.		
<b>HIGHLY ORGANIC SOILS</b>			PT	Peat.	

### DEFINITION OF TERMS AND SYMBOLS

<b>COHESIONLESS</b>	<u>Density</u>	<u>Standard Penetration Resistance in Blows/Foot</u>		2" OUTSIDE DIAMETER SPILT SPOON SAMPLER
	Very Loose Loose Medium Dense Dense Very Dense	0-4 4-10 10-30 30-50 >50		2.4" INSIDE DIAMETER RING SAMPLER OR SHELBY TUBE SAMPLER
<b>COHESIVE</b>	<u>Consistency</u>	<u>Standard Penetration Resistance in Blows/Foot</u>		WATER LEVEL (Date)
	Very Soft Soft Medium Stiff Stiff Very Stiff Hard	0-2 2-4 4-8 8-16 16-32 >32	Tr	TORVANE READINGS, tsf
			Pp	PENETROMETER READING, tsf
			DD	DRY DENSITY, pounds per cubic foot
			LL	LIQUID LIMIT, percent
			PI	PLASTIC INDEX
			N	STANDARD PENETRATION, blows per foot

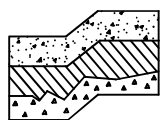

**Terra Associates, Inc.**  
 Consultants in Geotechnical Engineering  
 Geology and  
 Environmental Earth Sciences

UNIFIED SOIL CLASSIFICATION SYSTEM  
 CAMAS BUSINESS CENTER  
 VANCOUVER, WASHINGTON

Proj.No. T-8553

Date: JUNE 2021

Figure A-1

# LOG OF TEST PIT NO. TP-1

FIGURE A-2

**PROJECT NAME:** Camas Business Center      **PROJ. NO:** T-8553      **LOGGED BY:** MJX

**LOCATION:** Camas, Washington      **SURFACE CONDITIONS:** Grass      **APPROX. ELEV:** NA

**DATE LOGGED:** May 26, 2021      **DEPTH TO GROUNDWATER:** NA      **DEPTH TO CAVING:** NA

Depth (ft)	Sample No.	Description	Consistency/ Relative Density	W (%)
0		(7-inches organic TOPSOIL)		
1		Brown SILT, moist, scattered rootlets, occasional cobble, weak cementation. (ML)		24.6
2				
3		Brown SILT with sand, fine to coarse sand, moist, mottled. (ML)	medium stiff	34.1
4				
5				
6				
7		BEDROCK: Moderate strength, brown to gray, fine to coarse, moderately weathered. (Columbia River Basalt)		60.0
8				
9		Test Pit terminated at approximately 9 feet. No groundwater seepage observed. No caving observed.		61.2
10				
11				

NOTE: This subsurface information pertains only to this test pit location and should not be interpreted as being indicative of other locations at the site.



**Terra  
Associates, Inc.**  
Consultants in Geotechnical Engineering  
Geology and  
Environmental Earth Sciences

# LOG OF TEST PIT NO. TP-2

FIGURE A-3

**PROJECT NAME:** Camas Business Center      **PROJ. NO:** T-8553      **LOGGED BY:** MJX

**LOCATION:** Camas, Washington      **SURFACE CONDITIONS:** Tall Grass      **APPROX. ELEV:** NA

**DATE LOGGED:** May 26, 2021      **DEPTH TO GROUNDWATER:** NA      **DEPTH TO CAVING:** NA

Depth (ft)	Sample No.	Description	Consistency/ Relative Density	W (%)
0		(7-inches organic TOPSOIL)		
1		Brown SILT, moist, trace rootlets, weak cementation. (ML)		28.4
2				
3		Brown SILT with sand, fine to coarse sand, moist, mottled. (ML)	medium stiff	51.5
4				
5				
6		BEDROCK: Moderate strength, brown to gray, fine to coarse, moderately weathered. (Columbia River Basalt)		58.2
7				
8		Test Pit terminated at approximately 8 feet. No groundwater seepage observed. No caving observed.		52.5
9				
10				

NOTE: This subsurface information pertains only to this test pit location and should not be interpreted as being indicative of other locations at the site.

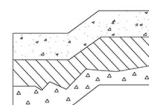

**Terra**  
**Associates, Inc.**  
 Consultants in Geotechnical Engineering  
 Geology and  
 Environmental Earth Sciences

# LOG OF TEST PIT NO. TP-3

FIGURE A-4

**PROJECT NAME:** Camas Business Center      **PROJ. NO:** T-8553      **LOGGED BY:** MJX

**LOCATION:** Camas, Washington      **SURFACE CONDITIONS:** Blackberries      **APPROX. ELEV:** NA

**DATE LOGGED:** May 26, 2021      **DEPTH TO GROUNDWATER:** NA      **DEPTH TO CAVING:** NA

Depth (ft)	Sample No.	Description	Consistency/ Relative Density	W (%)
0		(9-inches organic TOPSOIL)		
1		Brown SILT, moist, trace rootlets, weak cementation. (ML)		29.0
2		Brown SILT with sand to sandy SILT, fine to coarse sand, moist, mottled below 8 feet, moderate cementation. (ML)		
3			medium stiff	35.0
4				
5				
6				35.8
7				
8			very stiff	
9				
10				35.9
11		Test Pit terminated at approximately 10 feet. No groundwater seepage observed. No caving observed.		
12				

NOTE: This subsurface information pertains only to this test pit location and should not be interpreted as being indicative of other locations at the site.

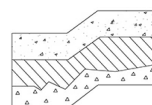

**Terra Associates, Inc.**  
 Consultants in Geotechnical Engineering  
 Geology and  
 Environmental Earth Sciences

# LOG OF TEST PIT NO. TP-4

FIGURE A-5

**PROJECT NAME:** Camas Business Center      **PROJ. NO:** T-8553      **LOGGED BY:** MJX

**LOCATION:** Camas, Washington      **SURFACE CONDITIONS:** Blackberries      **APPROX. ELEV:** NA

**DATE LOGGED:** May 26, 2021      **DEPTH TO GROUNDWATER:** 9 ft      **DEPTH TO CAVING:** NA

Depth (ft)	Sample No.	Description	Consistency/ Relative Density	W (%)
0		(8-inches organic TOPSOIL)		
1		Brown SILT with sand, fine sand, moist, scattered rootlets, weak cementation. (ML)		
2			medium stiff	29.9
3				
4		Brown sandy SILT, fine to coarse sand, moist to wet, weak to moderate cementation. (ML)		
5			stiff	29.0
6				
7				
8				30.6
9				
10				41.1
11		Test Pit terminated at approximately 10 feet. Minor groundwater seepage observed at approximately 9 feet. No caving observed.		
12				

NOTE: This subsurface information pertains only to this test pit location and should not be interpreted as being indicative of other locations at the site.



**Terra Associates, Inc.**  
 Consultants in Geotechnical Engineering  
 Geology and Environmental Earth Sciences



# LOG OF TEST PIT NO. TP-5

FIGURE A-6

**PROJECT NAME:** Camas Business Center      **PROJ. NO:** T-8553      **LOGGED BY:** MJX

**LOCATION:** Camas, Washington      **SURFACE CONDITIONS:** Blackberries      **APPROX. ELEV:** NA

**DATE LOGGED:** May 26, 2021      **DEPTH TO GROUNDWATER:** NA      **DEPTH TO CAVING:** NA

Depth (ft)	Sample No.	Description	Consistency/ Relative Density	W (%)
0		(7-inches organic TOPSOIL)		
1		Brown SILT, moist, trace rootlets, weak cementation. (ML)		20.3
2				
3		----- Brown SILT with sand, fine to coarse sand, moist, moderate cementation. (ML)	medium stiff	34.5
4				
5				
6				
7				34.4
8			stiff	
9		----- Brownish-gray sandy SILT, fine to coarse sand, moist, weak cementation. (ML)		
10				26.3
11		Test Pit terminated at approximately 10 feet. No groundwater seepage observed. No caving observed.		
12				

NOTE: This subsurface information pertains only to this test pit location and should not be interpreted as being indicative of other locations at the site.



**Terra Associates, Inc.**  
 Consultants in Geotechnical Engineering  
 Geology and  
 Environmental Earth Sciences

# LOG OF TEST PIT NO. TP-6

FIGURE A-7

**PROJECT NAME:** Camas Business Center      **PROJ. NO:** T-8553      **LOGGED BY:** MJX

**LOCATION:** Camas, Washington      **SURFACE CONDITIONS:** Tall Grass      **APPROX. ELEV:** NA

**DATE LOGGED:** May 26, 2021      **DEPTH TO GROUNDWATER:** 10 ft      **DEPTH TO CAVING:** NA

Depth (ft)	Sample No.	Description	Consistency/ Relative Density	W (%)
0		(8-inches organic TOPSOIL)		
1		Brown SILT, dry to moist, trace rootlets, weak cementation. (ML)		13.8
2				
3				
4		Brown sandy SILT, moist, fine to coarse sand, moist to wet, weak to moderate cementation. (ML)	medium stiff	24.9
5				
6				
7				
8				30.7
9			stiff	
10				35.1
11		Test Pit terminated at approximately 11 feet. Minor groundwater seepage observed at approximately 10 feet. No caving observed.		
12				
13				

NOTE: This subsurface information pertains only to this test pit location and should not be interpreted as being indicative of other locations at the site.

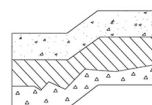

**Terra Associates, Inc.**  
 Consultants in Geotechnical Engineering  
 Geology and  
 Environmental Earth Sciences

# LOG OF TEST PIT NO. TP-7

FIGURE A-8

**PROJECT NAME:** Camas Business Center      **PROJ. NO:** T-8553      **LOGGED BY:** MJX

**LOCATION:** Camas, Washington      **SURFACE CONDITIONS:** Tall Grass      **APPROX. ELEV:** NA

**DATE LOGGED:** May 26, 2021      **DEPTH TO GROUNDWATER:** 10 ft      **DEPTH TO CAVING:** NA

Depth (ft)	Sample No.	Description	Consistency/ Relative Density	W (%)
0		(8-inches organic TOPSOIL)		
1		Brown SILT, moist, trace rootlets, weak cementation. (ML)		
2			medium stiff	13.8
3		Brown SILT with sand, fine to coarse sand, moist. (ML)		
4			stiff	31.4
5		Brown sandy SILT, fine to coarse sand, moist, weak to moderate cementation. (ML)		
6			stiff	27.2
7				
8			stiff	36.9
9				
10		Brownish-gray sandy SILT, fine to medium sand, moist to wet, weak cementation. (ML)		
11		Test Pit terminated at approximately 11 feet. Minor groundwater seepage observed at approximately 10 feet. No caving observed.		
12				
13				

NOTE: This subsurface information pertains only to this test pit location and should not be interpreted as being indicative of other locations at the site.

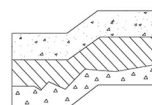

**Terra Associates, Inc.**  
 Consultants in Geotechnical Engineering  
 Geology and Environmental Earth Sciences

# LOG OF TEST PIT NO. TP-8

FIGURE A-9

**PROJECT NAME:** Camas Business Center      **PROJ. NO:** T-8553      **LOGGED BY:** MJX

**LOCATION:** Camas, Washington      **SURFACE CONDITIONS:** Tall Grass      **APPROX. ELEV:** NA

**DATE LOGGED:** May 26, 2021      **DEPTH TO GROUNDWATER:** 9 ft      **DEPTH TO CAVING:** NA

Depth (ft)	Sample No.	Description	Consistency/ Relative Density	W (%)
0		(10-inches organic TOPSOIL)		
1		Brown SILT, dry to moist, trace rootlets, weak cementation. (ML)		13.8
2				
3		Brown SILT with sand, fine sand, moist, occasional rootlet. (ML)	medium stiff	23.1
4				
5		Brown sandy SILT, fine to coarse sand, moist, weak cementation. (ML)		26.7
6				
7			stiff	
8				
9		Brownish-gray silty SAND, fine to medium sand, wet. (SM)	medium dense	37.1
10				
11		Test Pit terminated at approximately 10 feet. Minor groundwater seepage observed at approximately 9 feet. No caving observed.		
12				

NOTE: This subsurface information pertains only to this test pit location and should not be interpreted as being indicative of other locations at the site.



**Terra Associates, Inc.**  
 Consultants in Geotechnical Engineering  
 Geology and  
 Environmental Earth Sciences

# LOG OF TEST PIT NO. TP-9

FIGURE A-10

**PROJECT NAME:** Camas Business Center      **PROJ. NO:** T-8553      **LOGGED BY:** MJX

**LOCATION:** Camas, Washington      **SURFACE CONDITIONS:** Tall Grass      **APPROX. ELEV:** NA

**DATE LOGGED:** May 26, 2021      **DEPTH TO GROUNDWATER:** 10 ft      **DEPTH TO CAVING:** NA

Depth (ft)	Sample No.	Description	Consistency/ Relative Density	W (%)
0		(9-inches organic TOPSOIL)		
1		Brown SILT, moist, trace rootlets, weak cementation. (ML)	medium stiff	15.0
2				
3		Brown SILT with sand to sandy SILT, fine to coarse sand, moist to wet, weak cementation. (ML)		
4			stiff to very stiff	31.1
5				
6				
7		Brownish-gray sandy SILT, fine sand, moist to wet, weak cementation, interbedded silty SAND seams. (ML)		42.0
8			stiff	34.7
9				
10				
11		Test Pit terminated at approximately 11 feet. Minor groundwater seepage observed at approximately 10 feet. No caving observed.		37.7
12				
13				

NOTE: This subsurface information pertains only to this test pit location and should not be interpreted as being indicative of other locations at the site.

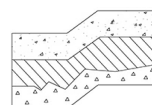

**Terra Associates, Inc.**  
 Consultants in Geotechnical Engineering  
 Geology and  
 Environmental Earth Sciences

# LOG OF TEST PIT NO. TP-10

FIGURE A-11

**PROJECT NAME:** Camas Business Center      **PROJ. NO:** T-8553      **LOGGED BY:** MJX

**LOCATION:** Camas, Washington      **SURFACE CONDITIONS:** Tall Grass      **APPROX. ELEV:** NA

**DATE LOGGED:** May 26, 2021      **DEPTH TO GROUNDWATER:** 7 ft      **DEPTH TO CAVING:** NA

Depth (ft)	Sample No.	Description	Consistency/ Relative Density	W (%)
0		(10-inches organic TOPSOIL)		
1		Brown SILT, moist, trace rootlets, weak cementation. (ML)		19.7
2				
3		Brown to brownish-gray SILT with sand, fine to coarse sand, moist to wet, weak cementation. (ML)	medium stiff	34.2
4				
5				
6				
7				
8			stiff	35.6
9				
10				38.3
11		Test Pit terminated at approximately 10 feet. Minor groundwater seepage observed at approximately 7 feet. No caving observed.		
12				

NOTE: This subsurface information pertains only to this test pit location and should not be interpreted as being indicative of other locations at the site.

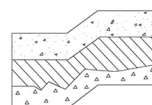

**Terra Associates, Inc.**  
 Consultants in Geotechnical Engineering  
 Geology and  
 Environmental Earth Sciences

# LOG OF TEST PIT NO. TP-11

FIGURE A-12

**PROJECT NAME:** Camas Business Center      **PROJ. NO:** T-8553      **LOGGED BY:** MJX

**LOCATION:** Camas, Washington      **SURFACE CONDITIONS:** Tall Grass      **APPROX. ELEV:** NA

**DATE LOGGED:** May 26, 2021      **DEPTH TO GROUNDWATER:** 11 ft      **DEPTH TO CAVING:** NA

Depth (ft)	Sample No.	Description	Consistency/ Relative Density	W (%)
0		(11-inches organic TOPSOIL)		
1		Brown SILT, dry to moist, trace rootlets, occasional cobble, weak cementation. (ML)		14.4
2				
3		----- Brown SILT with sand, fine to medium sand, moist. (ML)	medium stiff	22.0
4				
5				
6		----- Gray sandy SILT, fine sand, moist to wet, mottled, alternating layers of brown silty SAND. (ML)		39.4
7				
8				33.4
9			stiff	
10				
11				
12				42.2
13		Test Pit terminated at approximately 12 feet. Moderate groundwater seepage observed at approximately 11 feet. No caving observed.		
14				

NOTE: This subsurface information pertains only to this test pit location and should not be interpreted as being indicative of other locations at the site.

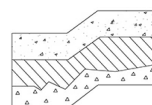

**Terra Associates, Inc.**  
 Consultants in Geotechnical Engineering  
 Geology and  
 Environmental Earth Sciences

# LOG OF TEST PIT NO. TP-12

FIGURE A-13

**PROJECT NAME:** Camas Business Center      **PROJ. NO:** T-8553      **LOGGED BY:** MJX

**LOCATION:** Camas, Washington      **SURFACE CONDITIONS:** Tall Grass      **APPROX. ELEV:** NA

**DATE LOGGED:** May 26, 2021      **DEPTH TO GROUNDWATER:** 9 ft      **DEPTH TO CAVING:** NA

Depth (ft)	Sample No.	Description	Consistency/ Relative Density	W (%)
0		(8-inches organic TOPSOIL)		
1		Gray SILT with sand, fine sand, moist, mottled, occasional rootlet. (ML)		
2			medium stiff	21.9
3				
4				
5		Brownish-gray sandy SILT, fine to coarse sand, moist to wet, mottled. (ML)		38.2
6				
7			stiff	
8				
9		BEDROCK: Moderate strength, brown to gray, fine to coarse, moderately weathered. (Columbia River Basalt)		58.2
10				
11		Test Pit terminated at approximately 10 feet. Minor groundwater seepage observed at approximately 9 feet. No caving observed.		
12				

NOTE: This subsurface information pertains only to this test pit location and should not be interpreted as being indicative of other locations at the site.

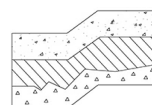

**Terra Associates, Inc.**  
 Consultants in Geotechnical Engineering  
 Geology and Environmental Earth Sciences



# LOG OF TEST PIT NO. TP-13

FIGURE A-14

**PROJECT NAME:** Camas Business Center      **PROJ. NO:** T-8553      **LOGGED BY:** MJX

**LOCATION:** Camas, Washington      **SURFACE CONDITIONS:** Grass/shrubs      **APPROX. ELEV:** NA

**DATE LOGGED:** May 26, 2021      **DEPTH TO GROUNDWATER:** 10 ft      **DEPTH TO CAVING:** NA

Depth (ft)	Sample No.	Description	Consistency/ Relative Density	W (%)
0		(11-inches organic TOPSOIL)		
1		Brownish-gray SILT with sand, fine sand, moist, mottled, occasional rootlet. (ML)		
2				19.6
3			medium stiff	
4				
5				36.6
6				
7		Brownish-gray sandy SILT, fine to coarse sand, moist to wet, mottled, weak cementation. (ML)		36.8
8			stiff	
9				
10				37.3
11		Test Pit terminated at approximately 10 feet. Minor groundwater seepage observed at approximately 10 feet. No caving observed.		
12				

NOTE: This subsurface information pertains only to this test pit location and should not be interpreted as being indicative of other locations at the site.

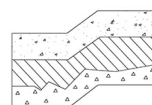

**Terra Associates, Inc.**  
 Consultants in Geotechnical Engineering  
 Geology and  
 Environmental Earth Sciences

# LOG OF TEST PIT NO. TP-14

FIGURE A-15

**PROJECT NAME:** Camas Business Center      **PROJ. NO:** T-8553      **LOGGED BY:** MJX

**LOCATION:** Camas, Washington      **SURFACE CONDITIONS:** Blackberries      **APPROX. ELEV:** NA

**DATE LOGGED:** May 26, 2021      **DEPTH TO GROUNDWATER:** 9 ft      **DEPTH TO CAVING:** NA

Depth (ft)	Sample No.	Description	Consistency/ Relative Density	W (%)
0		(10-inches organic TOPSOIL)		
1		Gray SILT, moist, trace rootlets, occasional gravel, weak cementation. (ML)	medium stiff	22.2
2				
3		Brownish-gray to gray SILT with sand, moist, mottled, occasional rootlet. (ML)		28.1
4				
5			stiff	
6				
7				
8		Brownish-gray SAND with silt, fine to coarse sand, moist to wet, interbedded mottled sandy SILT seams. ( SP-SM)		
9			medium dense	
10				41.4
11		Test Pit terminated at approximately 10 feet. Minor groundwater seepage observed at approximately 9 feet. No caving observed.		
12				

NOTE: This subsurface information pertains only to this test pit location and should not be interpreted as being indicative of other locations at the site.

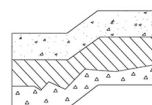

**Terra Associates, Inc.**  
 Consultants in Geotechnical Engineering  
 Geology and  
 Environmental Earth Sciences

# LOG OF TEST PIT NO. TP-15

FIGURE A-16

**PROJECT NAME:** Camas Business Center      **PROJ. NO:** T-8553      **LOGGED BY:** MJX

**LOCATION:** Camas, Washington      **SURFACE CONDITIONS:** Grass/shrubs      **APPROX. ELEV:** NA

**DATE LOGGED:** May 26, 2021      **DEPTH TO GROUNDWATER:** 10 ft      **DEPTH TO CAVING:** NA

Depth (ft)	Sample No.	Description	Consistency/ Relative Density	W (%)
0		(9-inches organic TOPSOIL)		
1		Gray SILT with sand, fine sand, moist, mottled. (ML)		
2			medium stiff	26.3
3				
4				
5		Brownish-gray sandy SILT, fine to coarse sand, moist to wet, mottled, weak cementation. (ML)		34.7
6				
7			stiff	
8				
9				
10				47.8
11		Test Pit terminated at approximately 11 feet. Minor groundwater seepage observed at approximately 10 feet. No caving observed.		
12				
13				

NOTE: This subsurface information pertains only to this test pit location and should not be interpreted as being indicative of other locations at the site.

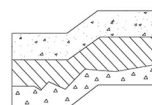

**Terra Associates, Inc.**  
 Consultants in Geotechnical Engineering  
 Geology and Environmental Earth Sciences

# LOG OF TEST PIT NO. TP-16

FIGURE A-17

**PROJECT NAME:** Camas Business Center      **PROJ. NO:** T-8553      **LOGGED BY:** MJX

**LOCATION:** Camas, Washington      **SURFACE CONDITIONS:** Blackberries      **APPROX. ELEV:** NA

**DATE LOGGED:** May 26, 2021      **DEPTH TO GROUNDWATER:** 7 ft      **DEPTH TO CAVING:** NA

Depth (ft)	Sample No.	Description	Consistency/ Relative Density	W (%)
0		(10-inches organic TOPSOIL)		
1		Gray SILT, dry to moist, trace rootlets, occasional gravel, weak cementation. (ML)	medium stiff	24.9
2				
3		Brownish-gray to gray SILT with sand, fine sand, moist, mottled. (ML)		25.2
4				
5		Brownish-gray to gray sandy SILT, fine to coarse sand, moist to wet, interbedded SAND with silt seams below 7 feet. (ML)		33.2
6				
7			stiff	38.5
8				
9				
10				
11				
12		Test Pit terminated at approximately 12 feet. Minor groundwater seepage observed at approximately 7 feet. No caving observed.		34.1
13				
14				

NOTE: This subsurface information pertains only to this test pit location and should not be interpreted as being indicative of other locations at the site.

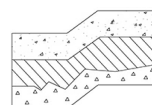

**Terra Associates, Inc.**  
 Consultants in Geotechnical Engineering  
 Geology and  
 Environmental Earth Sciences

# LOG OF TEST PIT NO. TP-17

FIGURE A-18

**PROJECT NAME:** Camas Business Center      **PROJ. NO:** T-8553      **LOGGED BY:** MJX

**LOCATION:** Camas, Washington      **SURFACE CONDITIONS:** Grass/shrubs      **APPROX. ELEV:** NA

**DATE LOGGED:** May 26, 2021      **DEPTH TO GROUNDWATER:** 8 ft      **DEPTH TO CAVING:** NA

Depth (ft)	Sample No.	Description	Consistency/ Relative Density	W (%)
0		(8-inches organic TOPSOIL)		
1		Dark gray SILT, moist, trace rootlets, weak cementation. (ML)	medium stiff	21.4
2		Gray SILT with sand, fine sand, moist, mottled, occasional rootlet, occasional gravel. (ML)		28.9
3				
4				
5			stiff	37.3
6				
7				
8		Gray SAND with silt, fine to coarse sand, wet, interbedded SILT seams. (SP-SM)	medium dense	33.7
9		BEDROCK: Moderate strength, brown to gray, fine to coarse, moderately weathered. (Columbia River Basalt)		
10				34.2
11		Test Pit terminated at approximately 10 feet. Minor groundwater seepage observed at approximately 8 feet. No caving observed.		
12				

NOTE: This subsurface information pertains only to this test pit location and should not be interpreted as being indicative of other locations at the site.

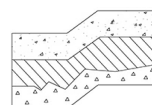

**Terra Associates, Inc.**  
 Consultants in Geotechnical Engineering  
 Geology and Environmental Earth Sciences

# LOG OF TEST PIT NO. TP-18

FIGURE A-19

**PROJECT NAME:** Camas Business Center      **PROJ. NO:** T-8553      **LOGGED BY:** MJX

**LOCATION:** Camas, Washington      **SURFACE CONDITIONS:** Grass/shrubs      **APPROX. ELEV:** NA

**DATE LOGGED:** May 26, 2021      **DEPTH TO GROUNDWATER:** 9 ft      **DEPTH TO CAVING:** NA

Depth (ft)	Sample No.	Description	Consistency/ Relative Density	W (%)
0		(9-inches organic TOPSOIL)		
1		Brown SILT, moist, trace rootlet, weak cementation. (ML)		22.6
2				
3		Brownish-gray sandy SILT, fine to medium sand, moist, mottled, occasional gravel. (ML)	medium stiff	
4				28.9
5				
6		Brown to brownish-gray sandy SILT, fine to coarse sand, moist, weak cementation. (ML)		40.0
7			stiff	
8				
9		Brown SAND with silt, fine to coarse sand, wet, interbedded SILT seams. (SP-SM)		
10			medium dense	37.4
11		Test Pit terminated at approximately 11 feet. Minor seepage observed at approximately 9 feet. No caving observed.		
12				
13				

NOTE: This subsurface information pertains only to this test pit location and should not be interpreted as being indicative of other locations at the site.

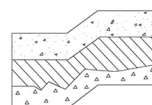

**Terra Associates, Inc.**  
 Consultants in Geotechnical Engineering  
 Geology and  
 Environmental Earth Sciences

# LOG OF TEST PIT NO. TP-19

FIGURE A-20

**PROJECT NAME:** Camas Business Center      **PROJ. NO:** T-8553      **LOGGED BY:** MJX

**LOCATION:** Camas, Washington      **SURFACE CONDITIONS:** Grass/shrubs      **APPROX. ELEV:** NA

**DATE LOGGED:** May 26, 2021      **DEPTH TO GROUNDWATER:** NA      **DEPTH TO CAVING:** NA

Depth (ft)	Sample No.	Description	Consistency/ Relative Density	W (%)
0		(8-inches organic TOPSOIL)		
1		Brown SILT, moist, trace rootlets, occasional gravel, weak cementation. (ML)		21.8
2				
3		Brown SILT with sand, fine sand, moist, occasional rootlet. (ML)	medium stiff	24.0
4				
5		Brownish-gray sandy SILT, fine to coarse sand, moist, mottled. (ML)		40.1
6				
7		Brownish-gray SILT with sand, fine sand, moist, mottled. (ML)		36.5
8			stiff	
9		Brownish-gray sandy SILT, fine to coarse sand, moist, mottled. (ML)		44.5
10				
11		Test Pit terminated at approximately 10 feet. No groundwater seepage observed. No caving observed.		
12				

NOTE: This subsurface information pertains only to this test pit location and should not be interpreted as being indicative of other locations at the site.

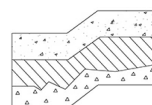

**Terra Associates, Inc.**  
 Consultants in Geotechnical Engineering  
 Geology and Environmental Earth Sciences

# LOG OF TEST PIT NO. TP-20

FIGURE A-21

**PROJECT NAME:** Camas Business Center      **PROJ. NO:** T-8553      **LOGGED BY:** MJX

**LOCATION:** Camas, Washington      **SURFACE CONDITIONS:** Tall Grass      **APPROX. ELEV:** NA

**DATE LOGGED:** May 25, 2021      **DEPTH TO GROUNDWATER:** NA      **DEPTH TO CAVING:** NA

Depth (ft)	Sample No.	Description	Consistency/ Relative Density	W (%)
0		(4-inches organic TOPSOIL)		
1		Brown SILT, dry, trace rootlets. (ML)		14.4
2		Brown SILT with sand, fine to coarse sand, moist, trace gravel. (ML)		
3			medium stiff	37.5
4				
5				
6		BEDROCK: Moderate strength, brown to gray, fine to coarse, moderately weathered. (Columbia River Basalt)		53.2
7				
8				
9		Test Pit terminated at approximately 9 feet. No groundwater seepage observed. No caving observed.		54.7
10				

NOTE: This subsurface information pertains only to this test pit location and should not be interpreted as being indicative of other locations at the site.

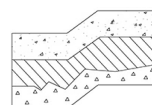

**Terra**  
**Associates, Inc.**  
 Consultants in Geotechnical Engineering  
 Geology and  
 Environmental Earth Sciences



# LOG OF TEST PIT NO. TP-21

FIGURE A-22

**PROJECT NAME:** Camas Business Center      **PROJ. NO:** T-8553      **LOGGED BY:** MJX

**LOCATION:** Camas, Washington      **SURFACE CONDITIONS:** Tall Grass      **APPROX. ELEV:** NA

**DATE LOGGED:** May 25, 2021      **DEPTH TO GROUNDWATER:** NA      **DEPTH TO CAVING:** NA

Depth (ft)	Sample No.	Description	Consistency/ Relative Density	W (%)
0		(6-inches organic TOPSOIL)		
1		Brown SILT, dry, occasional rootlet, weak cementation. (ML)	medium stiff	22.7
2				
3		----- Reddish-brown SILT, moist, trace sand, occasional cobble, weak cementation. (ML)		23.7
4			stiff	
5				
6		----- Brown silty GRAVEL with sand, fine to coarse sand, fine to coarse gravel, moist, scattered cobbles. (GM)	dense	51.9
7		----- BEDROCK: Moderate strength, brown to gray, fine to coarse, moderately weathered. (Columbia River Basalt)		
8				55.3
9		Test Pit terminated at approximately 8 feet. No groundwater seepage observed. No caving observed.		
10				

NOTE: This subsurface information pertains only to this test pit location and should not be interpreted as being indicative of other locations at the site.

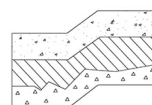

**Terra Associates, Inc.**  
 Consultants in Geotechnical Engineering  
 Geology and  
 Environmental Earth Sciences

# LOG OF TEST PIT NO. TP-22

FIGURE A-23

**PROJECT NAME:** Camas Business Center      **PROJ. NO:** T-8553      **LOGGED BY:** MJX

**LOCATION:** Camas, Washington      **SURFACE CONDITIONS:** Tall Grass      **APPROX. ELEV:** NA

**DATE LOGGED:** May 25, 2021      **DEPTH TO GROUNDWATER:** 2.5 ft      **DEPTH TO CAVING:** NA

Depth (ft)	Sample No.	Description	Consistency/ Relative Density	W (%)
0		(10-inches organic TOPSOIL)		
1		Brown SILT, moist, occasional rootlet, weak cementation. (ML)	medium stiff	33.2
2				
3		Light brown SILT with sand and gravel, fine to coarse sand, fine to coarse gravel, moist, weak cementation. (ML)		65.8
4			stiff	
5		BEDROCK: Moderate strength, brown to gray, fine to coarse, moderately weathered. (Columbia River Basalt)		
6		Test Pit terminated at approximately 6 feet. Minor groundwater seepage observed at approximately 2.5 feet. No caving observed.		56.6
7				
8				

NOTE: This subsurface information pertains only to this test pit location and should not be interpreted as being indicative of other locations at the site.

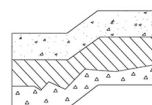

**Terra Associates, Inc.**  
 Consultants in Geotechnical Engineering  
 Geology and  
 Environmental Earth Sciences

# LOG OF TEST PIT NO. TP-23

FIGURE A-24

**PROJECT NAME:** Camas Business Center      **PROJ. NO:** T-8553      **LOGGED BY:** MJX

**LOCATION:** Camas, Washington      **SURFACE CONDITIONS:** Tall Grass      **APPROX. ELEV:** NA

**DATE LOGGED:** May 25, 2021      **DEPTH TO GROUNDWATER:** NA      **DEPTH TO CAVING:** NA

Depth (ft)	Sample No.	Description	Consistency/ Relative Density	W (%)
0		(4-inches organic TOPSOIL)		
1		Brown SILT, dry, scattered rootlets, moderate cementation. (ML)		14.8
2				
3		Brown SILT with sand, fine to coarse sand, moist. (ML)	medium stiff	41.4
4				
5				
6				
7		BbEDROCK: Moderate strength, brown to gray, fine to coarse, moderately weathered. (Columbia River Basalt)		51.6
8		Test Pit terminated at approximately 8 feet. No groundwater seepage observed. No caving observed.		
9				
10				

NOTE: This subsurface information pertains only to this test pit location and should not be interpreted as being indicative of other locations at the site.

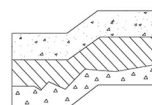

**Terra Associates, Inc.**  
 Consultants in Geotechnical Engineering  
 Geology and  
 Environmental Earth Sciences

# LOG OF TEST PIT NO. TP-24

FIGURE A-25

**PROJECT NAME:** Camas Business Center      **PROJ. NO:** T-8553      **LOGGED BY:** MJX

**LOCATION:** Camas, Washington      **SURFACE CONDITIONS:** Tall Grass      **APPROX. ELEV:** NA

**DATE LOGGED:** May 25, 2021      **DEPTH TO GROUNDWATER:** NA      **DEPTH TO CAVING:** NA

Depth (ft)	Sample No.	Description	Consistency/ Relative Density	W (%)
0		(6-inches organic TOPSOIL)		
1		Brown SILT with sand, fine to coarse sand, dry to moist, trace gravel. (ML)		11.6
2				
3			medium stiff	53.5
4				
5				
6				57.0
7		BEDROCK: Moderate strength, brown to gray, fine to coarse, moderately weathered. (Columbia River Basalt)		59.9
8				
9				54.9
10		Test Pit terminated at approximately 9 feet. No groundwater seepage observed. No caving observed.		
11				

NOTE: This subsurface information pertains only to this test pit location and should not be interpreted as being indicative of other locations at the site.

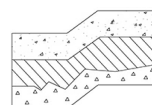

**Terra Associates, Inc.**  
 Consultants in Geotechnical Engineering  
 Geology and  
 Environmental Earth Sciences

# LOG OF TEST PIT NO. TP-25

FIGURE A-26

**PROJECT NAME:** Camas Business Center      **PROJ. NO:** T-8553      **LOGGED BY:** MJX

**LOCATION:** Camas, Washington      **SURFACE CONDITIONS:** Tall Grass      **APPROX. ELEV:** NA

**DATE LOGGED:** May 24, 2021      **DEPTH TO GROUNDWATER:** NA      **DEPTH TO CAVING:** NA

Depth (ft)	Sample No.	Description	Consistency/ Relative Density	W (%)
0		(6-inches organic TOPSOIL)		
1		Brown SILT, dry to moist, trace rootlets, weak cementation. (ML)		19.7
2				
3		-----		
4		Brown SILT with sand, fine to coarse sand, moist, slightly mottled. (ML)	medium stiff	35.4
5				
6				
7				
8		-----		
9		Brownish-gray to gray sandy SILT, fine to medium sand, moist, mottled. (ML)	stiff	38.6
10				
11		Test Pit terminated at approximately 10 feet. No groundwater seepage observed. No caving observed.		32.9
12				

NOTE: This subsurface information pertains only to this test pit location and should not be interpreted as being indicative of other locations at the site.

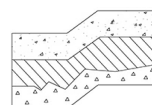

**Terra Associates, Inc.**  
 Consultants in Geotechnical Engineering  
 Geology and  
 Environmental Earth Sciences

# LOG OF TEST PIT NO. TP-26

FIGURE A-27

**PROJECT NAME:** Camas Business Center      **PROJ. NO:** T-8553      **LOGGED BY:** MJX

**LOCATION:** Camas, Washington      **SURFACE CONDITIONS:** Tall Grass      **APPROX. ELEV:** NA

**DATE LOGGED:** May 25, 2021      **DEPTH TO GROUNDWATER:** NA      **DEPTH TO CAVING:** NA

Depth (ft)	Sample No.	Description	Consistency/ Relative Density	W (%)
0		(7-inches organic TOPSOIL)		
1		Brown SILT with sand, fine to coarse sand, moist, mottled, occasional gravel. (ML)	medium stiff	24.3
2				
3		BEDROCK: Moderate strength, brown to gray, fine to coarse, moderately weathered. (Columbia River Basalt)		29.9
4				
5				
6		Test Pit terminated at approximately 6 feet. No groundwater seepage observed. No caving observed.		29.5
7				
8				

NOTE: This subsurface information pertains only to this test pit location and should not be interpreted as being indicative of other locations at the site.

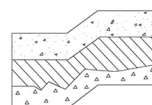

**Terra Associates, Inc.**  
 Consultants in Geotechnical Engineering  
 Geology and  
 Environmental Earth Sciences

# LOG OF TEST PIT NO. TP-27

FIGURE A-28

**PROJECT NAME:** Camas Business Center      **PROJ. NO:** T-8553      **LOGGED BY:** MJX

**LOCATION:** Camas, Washington      **SURFACE CONDITIONS:** Tall Grass      **APPROX. ELEV:** NA

**DATE LOGGED:** May 25, 2021      **DEPTH TO GROUNDWATER:** NA      **DEPTH TO CAVING:** NA

Depth (ft)	Sample No.	Description	Consistency/ Relative Density	W (%)
0		(11-inches organic TOPSOIL)		
1		Brown SILT, dry, scattered rootlets, moderate cementation. (ML)		18.4
2				
3		Brown SILT with sand, fine to coarse sand, moist. (ML)	medium stiff	47.4
4				
5				
6				
7		BEDROCK: Moderate strength, brown to gray, fine to coarse, moderately weathered. (Columbia River Basalt)		
8				53.6
9				
10		Test Pit terminated at approximately 9 feet. No groundwater seepage observed. No caving observed.		
11				

NOTE: This subsurface information pertains only to this test pit location and should not be interpreted as being indicative of other locations at the site.

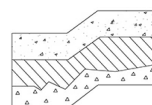

**Terra Associates, Inc.**  
 Consultants in Geotechnical Engineering  
 Geology and  
 Environmental Earth Sciences

# LOG OF TEST PIT NO. TP-28

FIGURE A-29

**PROJECT NAME:** Camas Business Center      **PROJ. NO:** T-8553      **LOGGED BY:** MJX

**LOCATION:** Camas, Washington      **SURFACE CONDITIONS:** Tall Grass      **APPROX. ELEV:** NA

**DATE LOGGED:** May 25, 2021      **DEPTH TO GROUNDWATER:** NA      **DEPTH TO CAVING:** NA

Depth (ft)	Sample No.	Description	Consistency/ Relative Density	W (%)
0		(5-inches organic TOPSOIL)		
1		Brown SILT, dry to moist, trace rootlets, weak cementation. (ML)	medium stiff	16.7
2				
3		Brownish-gray sandy SILT, fine sand, moist, moderate cementation. (ML)		37.0
4			medium stiff to stiff	
5				
6		BEDROCK: Moderate strength, brown to gray, fine to coarse, moderately weathered. (Columbia River Basalt)		54.0
7				
8		Test Pit terminated at approximately 8 feet. No groundwater seepage observed. No caving observed.		
9				
10				

NOTE: This subsurface information pertains only to this test pit location and should not be interpreted as being indicative of other locations at the site.

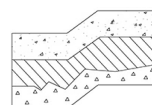

**Terra Associates, Inc.**  
 Consultants in Geotechnical Engineering  
 Geology and  
 Environmental Earth Sciences



# LOG OF TEST PIT NO. TP-29

FIGURE A-30

**PROJECT NAME:** Camas Business Center      **PROJ. NO:** T-8553      **LOGGED BY:** MJX

**LOCATION:** Camas, Washington      **SURFACE CONDITIONS:** Tall Grass      **APPROX. ELEV:** NA

**DATE LOGGED:** May 25, 2021      **DEPTH TO GROUNDWATER:** 9 ft      **DEPTH TO CAVING:** NA

Depth (ft)	Sample No.	Description	Consistency/ Relative Density	W (%)
0		(4-inches organic TOPSOIL)		
1		Reddish-brown SILT, moist, trace rootlets. (ML)		26.9
2				
3		----- Brown SILT with sand, fine to coarse sand, moist, some mottling. (ML)		35.0
4			medium stiff	
5				
6				39.0
7				
8				
9		----- Dark gray silty SAND, fine to coarse sand, wet. (SM)		
10			medium dense	53.9
11		Test Pit terminated at approximately 11 feet. No groundwater seepage observed. No caving observed.		
12				
13				

NOTE: This subsurface information pertains only to this test pit location and should not be interpreted as being indicative of other locations at the site.

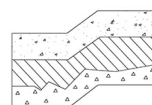

**Terra Associates, Inc.**  
 Consultants in Geotechnical Engineering  
 Geology and Environmental Earth Sciences

# LOG OF TEST PIT NO. TP-30

FIGURE A-31

**PROJECT NAME:** Camas Business Center      **PROJ. NO:** T-8553      **LOGGED BY:** MJX

**LOCATION:** Camas, Washington      **SURFACE CONDITIONS:** Blackberries      **APPROX. ELEV:** NA

**DATE LOGGED:** May 25, 2021      **DEPTH TO GROUNDWATER:** NA      **DEPTH TO CAVING:** NA

Depth (ft)	Sample No.	Description	Consistency/ Relative Density	W (%)
0		(11-inches organic TOPSOIL)		
1		Brown SILT, moist, trace rootlets. (ML)		29.9
2				
3			medium stiff	
4		----- Brown SILT with sand, fine to coarse sand, moist, mottled. (ML)		34.9
5				
6				
7		----- BEDROCK: Moderate strength, brown to gray, fine to coarse, moderately weathered. (Columbia River Basalt)		33.4
8				
9				
10				56.2
11		Test Pit terminated at approximately 10 feet. No groundwater seepage observed. No caving observed.		
12				

NOTE: This subsurface information pertains only to this test pit location and should not be interpreted as being indicative of other locations at the site.

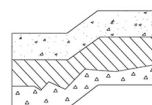

**Terra Associates, Inc.**  
 Consultants in Geotechnical Engineering  
 Geology and  
 Environmental Earth Sciences

# LOG OF TEST PIT NO. TP-31

FIGURE A-32

**PROJECT NAME:** Camas Business Center      **PROJ. NO:** T-8553      **LOGGED BY:** MJX

**LOCATION:** Camas, Washington      **SURFACE CONDITIONS:** Blackberries      **APPROX. ELEV:** NA

**DATE LOGGED:** May 25, 2021      **DEPTH TO GROUNDWATER:** 8 ft      **DEPTH TO CAVING:** NA

Depth (ft)	Sample No.	Description	Consistency/ Relative Density	W (%)
0		(10-inches organic TOPSOIL)		
1		Brown SILT, moist, trace rootlets. (ML)		24.6
2				
3		Brown SILT with sand, fine to coarse sand, moist. (ML)	medium stiff	32.5
4				
5				
6		Gray SILT with sand, fine to coarse sand, moist, mottled. (ML)	stiff	37.9
7				
8		Dark gray silty SAND, fine to coarse sand, wet, occasional gravel, occasional SILT seam. (SM)		58.7
9				
10			medium dense	
11				
12		Test Pit terminated at approximately 12 feet. Minor groundwater seepage observed at approximately 8 feet. No caving observed.		54.4
13				
14				

NOTE: This subsurface information pertains only to this test pit location and should not be interpreted as being indicative of other locations at the site.

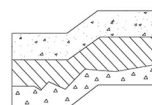

**Terra Associates, Inc.**  
 Consultants in Geotechnical Engineering  
 Geology and  
 Environmental Earth Sciences

# LOG OF TEST PIT NO. TP-32

FIGURE A-33

**PROJECT NAME:** Camas Business Center      **PROJ. NO:** T-8553      **LOGGED BY:** MJX

**LOCATION:** Camas, Washington      **SURFACE CONDITIONS:** Blackberries      **APPROX. ELEV:** NA

**DATE LOGGED:** May 25, 2021      **DEPTH TO GROUNDWATER:** 3 ft      **DEPTH TO CAVING:** NA

Depth (ft)	Sample No.	Description	Consistency/ Relative Density	W (%)
0		(10-inches organic TOPSOIL)		
1		Dark brown SILT, moist, trace sand, trace rootlets. (ML)	medium stiff	27.0
2				
3		Reddish-brown SILT, moist. (ML)		33.7
4			stiff	
5				
6				39.2
7			very stiff	
8		BEDROCK: Moderate strength, brown to gray, fine to coarse, moderately weathered. (Columbia River Basalt)		48.1
9				
10				
11		Test Pit terminated at approximately 10 feet. Minor groundwater seepage observed at approximately 3 feet. No caving observed.		
12				

NOTE: This subsurface information pertains only to this test pit location and should not be interpreted as being indicative of other locations at the site.

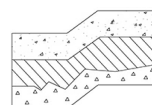

**Terra Associates, Inc.**  
 Consultants in Geotechnical Engineering  
 Geology and  
 Environmental Earth Sciences

# LOG OF TEST PIT NO. TP-33

FIGURE A-34

**PROJECT NAME:** Camas Business Center      **PROJ. NO:** T-8553      **LOGGED BY:** MJX

**LOCATION:** Camas, Washington      **SURFACE CONDITIONS:** Blackberries      **APPROX. ELEV:** NA

**DATE LOGGED:** May 25, 2021      **DEPTH TO GROUNDWATER:** NA      **DEPTH TO CAVING:** NA

Depth (ft)	Sample No.	Description	Consistency/ Relative Density	W (%)
0		(9-inches organic TOPSOIL)		
1		Reddish-brown SILT, moist, trace rootlets. (ML)		
2			medium stiff	21.7
3		----- Brown SILT with sand, fine to coarse sand, moist, mottled. (ML)		40.3
4				
5		----- BEDROCK: Moderate strength, brown to gray, fine to coarse, moderately weathered. (Columbia River Basalt)		24.6
6				
7				22.9
8				24.7
9		Test Pit terminated at approximately 8 feet. No groundwater seepage observed. No caving observed.		
10				

NOTE: This subsurface information pertains only to this test pit location and should not be interpreted as being indicative of other locations at the site.

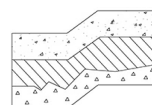

Terra  
Associates, Inc.

Consultants in Geotechnical Engineering  
Geology and  
Environmental Earth Sciences

# LOG OF TEST PIT NO. TP-34

FIGURE A-35

**PROJECT NAME:** Camas Business Center      **PROJ. NO:** T-8553      **LOGGED BY:** MJX

**LOCATION:** Camas, Washington      **SURFACE CONDITIONS:** Blackberries      **APPROX. ELEV:** NA

**DATE LOGGED:** May 25, 2021      **DEPTH TO GROUNDWATER:** NA      **DEPTH TO CAVING:** NA

Depth (ft)	Sample No.	Description	Consistency/ Relative Density	W (%)
0		(10-inches organic TOPSOIL)		
1		Brown SILT, moist, trace rootlets, occasional organic. (ML)	medium stiff	24.9
2				
3		----- Brown SILT with sand, fine to coarse sand, moist, mottled. (ML)	stiff	30.8
4				
5		----- Gray SILT, moist, mottled, interbedded SAND seams. (ML)		
6			stiff	23.0
7				
8				
9				
10				
11				
11		Test Pit terminated at approximately 11 feet. No groundwater observed.	stiff	41.8
12		No caving observed.		
13				

NOTE: This subsurface information pertains only to this test pit location and should not be interpreted as being indicative of other locations at the site.

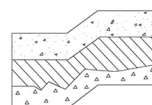

**Terra Associates, Inc.**  
 Consultants in Geotechnical Engineering  
 Geology and Environmental Earth Sciences

# LOG OF TEST PIT NO. TP-35

FIGURE A-36

**PROJECT NAME:** Camas Business Center      **PROJ. NO:** T-8553      **LOGGED BY:** MJX

**LOCATION:** Camas, Washington      **SURFACE CONDITIONS:** Blackberries      **APPROX. ELEV:** NA

**DATE LOGGED:** May 25, 2021      **DEPTH TO GROUNDWATER:** NA      **DEPTH TO CAVING:** NA

Depth (ft)	Sample No.	Description	Consistency/ Relative Density	W (%)
0		(9-inches organic TOPSOIL)		
1		Dark brown to brown SILT, moist, trace rootlets. (ML)		34.0
2			medium stiff	
3				
4		----- Brown SILT with sand, fine to coarse sand, moist, mottled. (ML)		36.4
5				
6		----- Brown silty GRAVEL with sand, fine to coarse sand, fine to coarse gravel, moist, mottled, scattered cobbles. (GM)		23.3
7			dense	
8		----- Brown to gray SILT, moist, mottled, interbedded SAND with silt seams. (ML)		31.9
9			stiff	
10				
11		----- Test Pit terminated at approximately 11 feet. No groundwater seepage observed. No caving observed.		31.4
12				
13				

NOTE: This subsurface information pertains only to this test pit location and should not be interpreted as being indicative of other locations at the site.

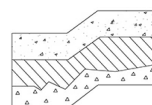

**Terra Associates, Inc.**  
 Consultants in Geotechnical Engineering  
 Geology and  
 Environmental Earth Sciences

# LOG OF TEST PIT NO. TP-36

FIGURE A-37

**PROJECT NAME:** Camas Business Center      **PROJ. NO:** T-8553      **LOGGED BY:** MJX

**LOCATION:** Camas, Washington      **SURFACE CONDITIONS:** Grass/shrubs      **APPROX. ELEV:** NA

**DATE LOGGED:** May 25, 2021      **DEPTH TO GROUNDWATER:** 9 ft      **DEPTH TO CAVING:** NA

Depth (ft)	Sample No.	Description	Consistency/ Relative Density	W (%)
0		(4-inches organic TOPSOIL)		
1		Brown SILT, dry, trace rootlets, occasional gravel, weak cementation. (ML)		14.8
2				
3		Brown to gray SILT with sand, fine to coarse sand, moist, mottled. (ML)	medium stiff	36.4
4				
5				
6				
7		Reddish-brown SILT, moist to wet, trace sand. (ML)	stiff	35.1
8				
9		Gray clayey SILT, moist. (ML)	very stiff	32.9
10				
11		Test Pit terminated at approximately 11 feet. Moderate groundwater seepage observed at approximately 9 feet. No caving observed.		
12				
13				

NOTE: This subsurface information pertains only to this test pit location and should not be interpreted as being indicative of other locations at the site.

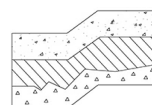

**Terra Associates, Inc.**  
 Consultants in Geotechnical Engineering  
 Geology and  
 Environmental Earth Sciences



# LOG OF TEST PIT NO. TP-37

FIGURE A-38

**PROJECT NAME:** Camas Business Center      **PROJ. NO:** T-8553      **LOGGED BY:** MJX

**LOCATION:** Camas, Washington      **SURFACE CONDITIONS:** Grass/shrubs      **APPROX. ELEV:** NA

**DATE LOGGED:** May 25, 2021      **DEPTH TO GROUNDWATER:** NA      **DEPTH TO CAVING:** NA

Depth (ft)	Sample No.	Description	Consistency/ Relative Density	W (%)
0		(2-inches organic TOPSOIL)		
1		Brown SILT, moist, trace rootlets, weak cementation. (ML)		24.2
2				
3		Brown SILT with sand, fine to coarse sand, moist, mottled, occasional gravel. (ML)	medium stiff	
4				33.4
5				
6		Reddish-brown SILT, moist. (ML)		
7				30.2
8			stiff	
9				
10				29.5
11		Test Pit terminated at approximately 10 feet. No groundwater seepage observed. No caving observed.		
12				

NOTE: This subsurface information pertains only to this test pit location and should not be interpreted as being indicative of other locations at the site.

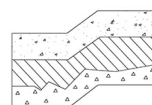

**Terra Associates, Inc.**  
 Consultants in Geotechnical Engineering  
 Geology and  
 Environmental Earth Sciences

# LOG OF TEST PIT NO. TP-38

FIGURE A-39

**PROJECT NAME:** Camas Business Center      **PROJ. NO:** T-8553      **LOGGED BY:** MJX

**LOCATION:** Camas, Washington      **SURFACE CONDITIONS:** Grass/shrubs      **APPROX. ELEV:** NA

**DATE LOGGED:** May 25, 2021      **DEPTH TO GROUNDWATER:** NA      **DEPTH TO CAVING:** NA

Depth (ft)	Sample No.	Description	Consistency/ Relative Density	W (%)
0		(5-inches organic TOPSOIL)		
1		Brown SILT, moist, trace rootlets, weak cementation. (ML)		22.4
2				
3				
4		Brown to gray SILT with sand, fine to coarse sand, moist, mottled. (ML)	medium stiff	32.8
5				
6				
7				36.0
8			stiff	
9				
10				33.3
11		Test Pit terminated at approximately 10 feet. No groundwater seepage observed. No caving observed.		
12				

NOTE: This subsurface information pertains only to this test pit location and should not be interpreted as being indicative of other locations at the site.

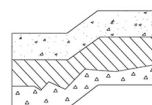

**Terra Associates, Inc.**  
 Consultants in Geotechnical Engineering  
 Geology and Environmental Earth Sciences

# LOG OF TEST PIT NO. TP-39

FIGURE A-40

**PROJECT NAME:** Camas Business Center      **PROJ. NO:** T-8553      **LOGGED BY:** MJX

**LOCATION:** Camas, Washington      **SURFACE CONDITIONS:** Tall Grass      **APPROX. ELEV:** NA

**DATE LOGGED:** May 24, 2021      **DEPTH TO GROUNDWATER:** 10 ft      **DEPTH TO CAVING:** NA

Depth (ft)	Sample No.	Description	Consistency/ Relative Density	W (%)
0		(5-inches organic TOPSOIL)		
1		Brown SILT, moist, trace rootlets, weak cementation. (ML)		20.8
2			medium stiff	
3				
4		----- Brownish-gray to gray sandy SILT, fine to coarse sand, moist, mottled. (ML)		38.5
5				
6				
7				
8			stiff	
9				
10		----- Blueish-gray silty SAND with gravel, fine to coarse sand, fine to coarse gravel, wet. (SM)		68.3
11			medium dense	
12				
13		Test Pit terminated at approximately 12 feet. Moderate groundwater seepage observed at approximately 10 feet. No caving observed.		
14				

NOTE: This subsurface information pertains only to this test pit location and should not be interpreted as being indicative of other locations at the site.

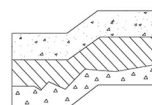

**Terra Associates, Inc.**  
 Consultants in Geotechnical Engineering  
 Geology and  
 Environmental Earth Sciences

# LOG OF TEST PIT NO. TP-40

FIGURE A-41

**PROJECT NAME:** Camas Business Center      **PROJ. NO:** T-8553      **LOGGED BY:** MJX

**LOCATION:** Camas, Washington      **SURFACE CONDITIONS:** Tall Grass      **APPROX. ELEV:** NA

**DATE LOGGED:** May 24, 2021      **DEPTH TO GROUNDWATER:** NA      **DEPTH TO CAVING:** NA

Depth (ft)	Sample No.	Description	Consistency/ Relative Density	W (%)
0		(6-inches organic TOPSOIL)		
1		Brown SILT, dry to moist, trace rootlets, weak cementation. (ML)		
2				
3				
4		Brown SILT with sand to clayey SILT with sand, fine to coarse sand, moist, slightly mottled. (ML)	medium stiff	14.5
5				
6				
7				
8				
9		Brownish-gray to gray sandy SILT, fine to coarse sand, moist, mottled. (ML)	stiff	35.2
10				
11		Test Pit terminated at approximately 10 feet. No groundwater seepage observed. No caving observed.		35.8
12				

NOTE: This subsurface information pertains only to this test pit location and should not be interpreted as being indicative of other locations at the site.

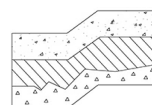

**Terra Associates, Inc.**  
 Consultants in Geotechnical Engineering  
 Geology and Environmental Earth Sciences

# LOG OF TEST PIT NO. TP-41

FIGURE A-42

**PROJECT NAME:** Camas Business Center      **PROJ. NO:** T-8553      **LOGGED BY:** MJX

**LOCATION:** Camas, Washington      **SURFACE CONDITIONS:** Tall Grass      **APPROX. ELEV:** NA

**DATE LOGGED:** May 24, 2021      **DEPTH TO GROUNDWATER:** NA      **DEPTH TO CAVING:** NA

Depth (ft)	Sample No.	Description	Consistency/ Relative Density	W (%)
0		(6-inches organic TOPSOIL)		
1		Brown SILT, dry to moist, trace rootlets, weak cementation. (ML)		14.9
2			medium stiff	
3				
4		Brown SILT with sand to clayey SILT with sand, fine to coarse sand, moist, slightly mottled. (ML)		35.1
5				
6				
7		Brownish-gray to gray sandy SILT, fine to coarse sand, moist, mottled, occasional gravel. (ML)		33.3
8			stiff	
9				
10		Test Pit terminated at approximately 10 feet. No groundwater seepage observed.		35.1
11		No caving observed.		
12				

NOTE: This subsurface information pertains only to this test pit location and should not be interpreted as being indicative of other locations at the site.

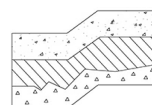

**Terra Associates, Inc.**  
 Consultants in Geotechnical Engineering  
 Geology and  
 Environmental Earth Sciences

# LOG OF TEST PIT NO. TP-42

FIGURE A-43

**PROJECT NAME:** Camas Business Center      **PROJ. NO:** T-8553      **LOGGED BY:** MJX

**LOCATION:** Camas, Washington      **SURFACE CONDITIONS:** Tall Grass      **APPROX. ELEV:** NA

**DATE LOGGED:** May 24, 2021      **DEPTH TO GROUNDWATER:** NA      **DEPTH TO CAVING:** NA

Depth (ft)	Sample No.	Description	Consistency/ Relative Density	W (%)
0		(6-inches organic TOPSOIL)		
1		Brown SILT, dry to moist, scattered rootlets, weak cementation. (ML)		
2				
3				
4		Brown SILT with sand, fine to coarse sand, moist, slightly mottled. (ML)	medium stiff	36.4
5				
6				
7		Gray sandy SILT, fine sand, moist, mottled. (ML)		36.8
8			stiff	
9				
10				36.5
11		Test Pit terminated at approximately 10 feet. No groundwater seepage observed. No caving observed.		
12				

NOTE: This subsurface information pertains only to this test pit location and should not be interpreted as being indicative of other locations at the site.

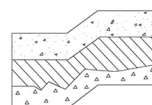

**Terra Associates, Inc.**  
 Consultants in Geotechnical Engineering  
 Geology and Environmental Earth Sciences

# LOG OF TEST PIT NO. TP-43

FIGURE A-44

**PROJECT NAME:** Camas Business Center      **PROJ. NO:** T-8553      **LOGGED BY:** MJX

**LOCATION:** Camas, Washington      **SURFACE CONDITIONS:** Tall Grass      **APPROX. ELEV:** NA

**DATE LOGGED:** May 24, 2021      **DEPTH TO GROUNDWATER:** NA      **DEPTH TO CAVING:** NA

Depth (ft)	Sample No.	Description	Consistency/ Relative Density	W (%)
0		(6-inches organic TOPSOIL)		
1		Brown SILT, moist, trace rootlets, weak cementation. (ML)		
2				
3				
4			medium stiff	
5		Brown SILT with sand to clayey SILT with sand, fine to medium sand, moist, slightly mottled. (ML)		31.7
6				
7				
8			stiff	
9				
10				38.4
11		Test Pit terminated at approximately 10 feet. No groundwater seepage observed. No caving observed.		
12				

NOTE: This subsurface information pertains only to this test pit location and should not be interpreted as being indicative of other locations at the site.

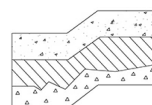

**Terra Associates, Inc.**  
 Consultants in Geotechnical Engineering  
 Geology and  
 Environmental Earth Sciences

# LOG OF TEST PIT NO. TP-44

FIGURE A-45

**PROJECT NAME:** Camas Business Center      **PROJ. NO:** T-8553      **LOGGED BY:** MJX

**LOCATION:** Camas, Washington      **SURFACE CONDITIONS:** Tall Grass      **APPROX. ELEV:** NA

**DATE LOGGED:** May 24, 2021      **DEPTH TO GROUNDWATER:** NA      **DEPTH TO CAVING:** NA

Depth (ft)	Sample No.	Description	Consistency/ Relative Density	W (%)
0		(6-inches organic TOPSOIL)		
1		Brown SILT, moist, trace rootlets, weak cementation. (ML)		27.3
2				
3				
4		Brown SILT with sand, fine to coarse sand, moist, slightly mottled. (ML)	medium stiff	38.0
5				
6				
7		Brownish-gray to gray sandy SILT, fine sand, moist, mottled. (ML)		38.0
8				
9			stiff	
10				35.8
11		Test Pit terminated at approximately 10 feet. No groundwater seepage observed. No caving observed.		
12				

NOTE: This subsurface information pertains only to this test pit location and should not be interpreted as being indicative of other locations at the site.

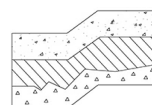

**Terra Associates, Inc.**  
 Consultants in Geotechnical Engineering  
 Geology and Environmental Earth Sciences



# LOG OF TEST PIT NO. TP-45

FIGURE A-46

**PROJECT NAME:** Camas Business Center      **PROJ. NO:** T-8553      **LOGGED BY:** MJX

**LOCATION:** Camas, Washington      **SURFACE CONDITIONS:** Tall Grass      **APPROX. ELEV:** NA

**DATE LOGGED:** May 24, 2021      **DEPTH TO GROUNDWATER:** NA      **DEPTH TO CAVING:** NA

Depth (ft)	Sample No.	Description	Consistency/ Relative Density	W (%)
0		(6-inches organic TOPSOIL)		
1		Brown SILT, moist, trace rootlets, weak cementation. (ML)		
2				
3				
4		Brown SILT with sand to clayey SILT with sand, fine to medium sand, moist, slightly mottled. (ML)	medium stiff	20.8
5				
6				
7				
8			stiff	
9				
10		Gray silty SAND, fine to coarse sand, moist, mottled, occasional gravel. (SM)	medium dense	
11				
12		Test Pit terminated at approximately 10 feet. No groundwater seepage observed. No caving observed.		37.9

NOTE: This subsurface information pertains only to this test pit location and should not be interpreted as being indicative of other locations at the site.

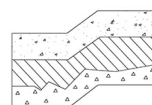

**Terra Associates, Inc.**  
 Consultants in Geotechnical Engineering  
 Geology and Environmental Earth Sciences

# LOG OF TEST PIT NO. TP-46

FIGURE A-47

**PROJECT NAME:** Camas Business Center      **PROJ. NO:** T-8553      **LOGGED BY:** MJX

**LOCATION:** Camas, Washington      **SURFACE CONDITIONS:** Tall Grass      **APPROX. ELEV:** NA

**DATE LOGGED:** May 24, 2021      **DEPTH TO GROUNDWATER:** NA      **DEPTH TO CAVING:** NA

Depth (ft)	Sample No.	Description	Consistency/ Relative Density	W (%)
0		(6-inches organic TOPSOIL)		
1		Red SILT, moist, scattered rootlets, weak cementation. (ML)	medium stiff	17.6
2				
3				
4		Gray clayey SILT, moist, mottled, trace sand. (ML)	stiff	34.0
5				
6				
7				
8				
9				
10		Blueish-gray clayey SILT, moist, mottled, trace sand. (ML)	stiff	52.4
11				
12				
13		Test Pit terminated at approximately 12 feet. No groundwater seepage observed. No caving observed.		
14				

NOTE: This subsurface information pertains only to this test pit location and should not be interpreted as being indicative of other locations at the site.

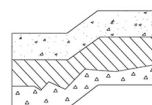

**Terra Associates, Inc.**  
 Consultants in Geotechnical Engineering  
 Geology and Environmental Earth Sciences

# LOG OF TEST PIT NO. TP-47

FIGURE A-48

**PROJECT NAME:** Camas Business Center      **PROJ. NO:** T-8553      **LOGGED BY:** MJX

**LOCATION:** Camas, Washington      **SURFACE CONDITIONS:** Tall Grass      **APPROX. ELEV:** NA

**DATE LOGGED:** May 24, 2021      **DEPTH TO GROUNDWATER:** NA      **DEPTH TO CAVING:** NA

Depth (ft)	Sample No.	Description	Consistency/ Relative Density	W (%)
0		(9-inches organic TOPSOIL)		
1		Brown SILT, moist, trace rootlets, weak cementation. (ML)	medium stiff	19.4
2				
3				
4		Brown SILT with sand, fine to coarse sand, moist, mottled. (ML)	stiff	29.3
5		Gray sandy SILT, fine sand, moist, mottled. (ML)		
6				
7				
8		Blueish-gray silty SAND, fine to coarse sand, moist, trace organics, interbedded SILT seams. (SM)	medium dense	52.7
9				
10				
11		Test Pit terminated at approximately 10 feet. No groundwater seepage observed. No caving observed.		
12				

NOTE: This subsurface information pertains only to this test pit location and should not be interpreted as being indicative of other locations at the site.

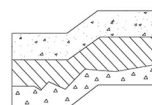

**Terra Associates, Inc.**  
 Consultants in Geotechnical Engineering  
 Geology and  
 Environmental Earth Sciences

# LOG OF TEST PIT NO. TP-48

FIGURE A-49

**PROJECT NAME:** Camas Business Center      **PROJ. NO:** T-8553      **LOGGED BY:** MJX

**LOCATION:** Camas, Washington      **SURFACE CONDITIONS:** Tall Grass      **APPROX. ELEV:** NA

**DATE LOGGED:** May 24, 2021      **DEPTH TO GROUNDWATER:** NA      **DEPTH TO CAVING:** NA

Depth (ft)	Sample No.	Description	Consistency/ Relative Density	W (%)
0		(7-inches organic TOPSOIL)		
1		Brown SILT, dry to moist, trace rootlets, weak cementation. (ML)		15.7
2				
3				
4		Brown SKT with sand, fine to coarse sand, moist, mottled. (ML)	medium stiff	36.0
5				
6				
7				
8		Blueish-gray silty SAND, fine to coarse sand, wet, interbedded SILT seams. (SM)		
9			medium dense	40.8
10				
11		Test Pit terminated at approximately 10 feet. No groundwater seepage observed. No caving observed.		
12				

NOTE: This subsurface information pertains only to this test pit location and should not be interpreted as being indicative of other locations at the site.

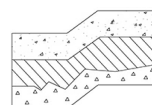

**Terra Associates, Inc.**  
 Consultants in Geotechnical Engineering  
 Geology and Environmental Earth Sciences

# LOG OF TEST PIT NO. TP-49

FIGURE A-50

**PROJECT NAME:** Camas Business Center      **PROJ. NO:** T-8553      **LOGGED BY:** MJX

**LOCATION:** Camas, Washington      **SURFACE CONDITIONS:** Tall Grass      **APPROX. ELEV:** NA

**DATE LOGGED:** May 24, 2021      **DEPTH TO GROUNDWATER:** NA      **DEPTH TO CAVING:** NA

Depth (ft)	Sample No.	Description	Consistency/ Relative Density	W (%)
0		(7-inches organic TOPSOIL)		
1		Brown SILT, moist, scattered rootlets, weak cementation. (ML)		18.6
2				
3		----- Brown SILT with sand, fine to coarse sand, moist, mottled, occasional gravel. (ML)	medium stiff	31.5
4				
5				
6		----- Gray sandy SILT, fine sand, moist, mottled. (ML)		
7			stiff	42.1
8		----- Blueish-gray silty SAND, fine to medium sand, moist, interbedded SILT seams. (SM)		
9			medium dense	
10				71.2
11		Test Pit terminated at approximately 10 feet. No groundwater seepage observed. No caving observed.		
12				

NOTE: This subsurface information pertains only to this test pit location and should not be interpreted as being indicative of other locations at the site.

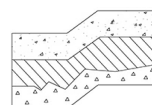

**Terra Associates, Inc.**  
 Consultants in Geotechnical Engineering  
 Geology and  
 Environmental Earth Sciences

# LOG OF TEST PIT NO. TP-50

FIGURE A-51

**PROJECT NAME:** Camas Business Center      **PROJ. NO:** T-8553      **LOGGED BY:** MJX

**LOCATION:** Camas, Washington      **SURFACE CONDITIONS:** Tall Grass      **APPROX. ELEV:** NA

**DATE LOGGED:** May 24, 2021      **DEPTH TO GROUNDWATER:** NA      **DEPTH TO CAVING:** NA

Depth (ft)	Sample No.	Description	Consistency/ Relative Density	W (%)
0		(6-inches organic TOPSOIL)		
1		Red SILT, moist, scattered rootlets, weak cementation. (ML)		18.6
2				
3		----- Brown SILT with sand, fine to coarse sand, moist, mottled. (ML)	medium stiff	
4				40.8
5				
6		----- Gray sandy SILT, fine to meduim sand, moist, mottled. (ML)		37.7
7			stiff	
8		----- Blueish-gray silty SAND, fine to coarse sand, moist to wet, interbbbed SILT layers. (SM)		
9			medium dense	
10				60.4
11		Test Pit terminated at approximately 10 feet. No groundwater seepage observed. No caving observed.		
12				

NOTE: This subsurface information pertains only to this test pit location and should not be interpreted as being indicative of other locations at the site.

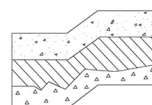

**Terra Associates, Inc.**  
 Consultants in Geotechnical Engineering  
 Geology and  
 Environmental Earth Sciences

# LOG OF TEST PIT NO. TP-51

FIGURE A-52

**PROJECT NAME:** Camas Business Center      **PROJ. NO:** T-8553      **LOGGED BY:** MJX

**LOCATION:** Camas, Washington      **SURFACE CONDITIONS:** Tall Grass      **APPROX. ELEV:** NA

**DATE LOGGED:** May 24, 2021      **DEPTH TO GROUNDWATER:** 12 ft      **DEPTH TO CAVING:** NA

Depth (ft)	Sample No.	Description	Consistency/ Relative Density	W (%)
0		(10-inches organic TOPSOIL)		
1		Brown SILT, moist, scattered rootlets, weak cementation. (ML)		21.3
2				
3				
4		----- Grayish-brown SILT with sand to sandy SILT, fine to medium sand, moist, mottled. (ML)	medium stiff	40.1
5				
6				
7		----- Blueish-gray silty SAND, fine to coarse sand, moist to wet, interbedded SILT layers. (SM)		69.6
8				
9			medium dense	
10				
11				
12				31.9
13		Test Pit terminated at approximately 12 feet. Minor groundwater seepage observed at approximately 12 feet. No caving observed.		
14				

NOTE: This subsurface information pertains only to this test pit location and should not be interpreted as being indicative of other locations at the site.

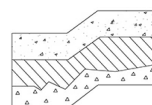

**Terra Associates, Inc.**  
 Consultants in Geotechnical Engineering  
 Geology and  
 Environmental Earth Sciences

# LOG OF TEST PIT NO. TP-52

FIGURE A-53

**PROJECT NAME:** Camas Business Center      **PROJ. NO:** T-8553      **LOGGED BY:** MJX

**LOCATION:** Camas, Washington      **SURFACE CONDITIONS:** Tall Grass      **APPROX. ELEV:** NA

**DATE LOGGED:** May 24, 2021      **DEPTH TO GROUNDWATER:** NA      **DEPTH TO CAVING:** NA

Depth (ft)	Sample No.	Description	Consistency/ Relative Density	W (%)
0		(6-inches organic TOPSOIL)		
1		Brown SILT, dry to moist, trace rootlets, weak cementation. (ML)		
2				
3				
4			medium stiff	
5		Brown SILT with sand to clayey SILT with sand, fine to coarse sand, moist, slightly mottled. (ML)		14.6
6				
7				
8			stiff	
9				
10				34.6
11		Test Pit terminated at approximately 10 feet. No groundwater seepage observed. No caving observed.		
12				39.5

NOTE: This subsurface information pertains only to this test pit location and should not be interpreted as being indicative of other locations at the site.

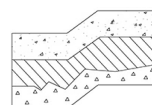

**Terra Associates, Inc.**  
 Consultants in Geotechnical Engineering  
 Geology and Environmental Earth Sciences



# LOG OF TEST PIT NO. TP-53

FIGURE A-54

**PROJECT NAME:** Camas Business Center      **PROJ. NO:** T-8553      **LOGGED BY:** MJX

**LOCATION:** Camas, Washington      **SURFACE CONDITIONS:** Tall Grass      **APPROX. ELEV:** NA

**DATE LOGGED:** May 24, 2021      **DEPTH TO GROUNDWATER:** NA      **DEPTH TO CAVING:** NA

Depth (ft)	Sample No.	Description	Consistency/ Relative Density	W (%)
0		(5-inches organic TOPSOIL)		
1		Brown SILT, moist, scattered rootlets, weak cementation. (ML)		
2				
3			medium stiff	
4				
5				
6		Brown SILT with sand to clayey SILT with sand, fine to coarse sand, moist, slightly mottled. (ML)		38.2
7				
8			stiff	
9				
10				38.2
11		Test Pit terminated at approximately 10 feet. No groundwater seepage observed. No caving observed.		
12				

NOTE: This subsurface information pertains only to this test pit location and should not be interpreted as being indicative of other locations at the site.

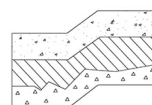

**Terra Associates, Inc.**  
 Consultants in Geotechnical Engineering  
 Geology and  
 Environmental Earth Sciences

# LOG OF TEST PIT NO. TP-54

FIGURE A-55

**PROJECT NAME:** Camas Buisness Center      **PROJ. NO:** T-8553      **LOGGED BY:** MJX

**LOCATION:** Camas, Washington      **SURFACE CONDITIONS:** Tall Grass      **APPROX. ELEV:** NA

**DATE LOGGED:** May 24, 2021      **DEPTH TO GROUNDWATER:** NA      **DEPTH TO CAVING:** NA

Depth (ft)	Sample No.	Description	Consistency/ Relative Density	W (%)
0		(5-inches organic TOPSOIL)		
1		Brown SILT, dry to moist, scattered rootlets, weak cementation, occasional clayey SILT seam. (ML)		15.6
2				
3				
4			medium stiff	
5				36.1
6				
7				
8				
9		Brown SILT with sand, fine to coarse sand, moist, occasional gravel. (ML)	medium stiff to stiff	
10				33.6
11		Test Pit terminated at approximately 10 feet. No groundwater seepage observed. No caving observed.		
12				

NOTE: This subsurface information pertains only to this test pit location and should not be interpreted as being indicative of other locations at the site.

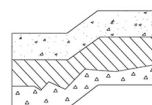

**Terra Associates, Inc.**  
 Consultants in Geotechnical Engineering  
 Geology and Environmental Earth Sciences

# LOG OF TEST PIT NO. TP-55

FIGURE A-56

**PROJECT NAME:** Camas Business Center      **PROJ. NO:** T-8553      **LOGGED BY:** MJX

**LOCATION:** Camas, Washington      **SURFACE CONDITIONS:** Tall Grass      **APPROX. ELEV:** NA

**DATE LOGGED:** May 24, 2021      **DEPTH TO GROUNDWATER:** NA      **DEPTH TO CAVING:** NA

Depth (ft)	Sample No.	Description	Consistency/ Relative Density	W (%)
0		(4-inches organic TOPSOIL)		
1		Brown SILT, moist, slightly mottled, trace rootlets, weak cementation. (ML)		16.9
2				
3				31.7
4			medium stiff	
5				
6				
7				
8		Brown silty SAND, fine to coarse sand, moist, trace gravel. (SM)		
9			medium dense	
10				30.1
11		Test Pit terminated at approximately 10 feet. No groundwater seepage observed. No caving observed.		
12				

NOTE: This subsurface information pertains only to this test pit location and should not be interpreted as being indicative of other locations at the site.

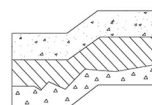

**Terra Associates, Inc.**  
 Consultants in Geotechnical Engineering  
 Geology and  
 Environmental Earth Sciences

# LOG OF TEST PIT NO. TP-56

FIGURE A-57

**PROJECT NAME:** Camas Business Center      **PROJ. NO:** T-8553      **LOGGED BY:** MJX

**LOCATION:** Camas, Washington      **SURFACE CONDITIONS:** Tall Grass      **APPROX. ELEV:** NA

**DATE LOGGED:** May 24, 2021      **DEPTH TO GROUNDWATER:** NA      **DEPTH TO CAVING:** NA

Depth (ft)	Sample No.	Description	Consistency/ Relative Density	W (%)
0		(7-inches organic TOPSOIL)		
1		Brown SILT, dry to moist, scattered rootlets, weak cementation. (ML)	medium stiff	13.6
2				
3				
4		Brownish-gray to gray SILT with sand, fine to medium sand, moist, mottled. (ML)	stiff	48.0
5				
6				
7		Blueish-gray sandy SILT, fine to coarse sand, moist to wet, trace organics. (ML)		47.8
8				
9				55.4
10				
11		Test Pit terminated at approximately 10 feet. No groundwater seepage observed. No caving observed.		
12				

NOTE: This subsurface information pertains only to this test pit location and should not be interpreted as being indicative of other locations at the site.

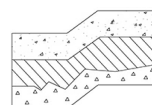

Terra  
Associates, Inc.

Consultants in Geotechnical Engineering  
Geology and  
Environmental Earth Sciences

# LOG OF TEST PIT NO. TP-57

FIGURE A-58

**PROJECT NAME:** Camas Business Center      **PROJ. NO:** T-8553      **LOGGED BY:** MJX

**LOCATION:** Camas, Washington      **SURFACE CONDITIONS:** Tall Grass      **APPROX. ELEV:** NA

**DATE LOGGED:** May 24, 2021      **DEPTH TO GROUNDWATER:** 10 ft      **DEPTH TO CAVING:** NA

Depth (ft)	Sample No.	Description	Consistency/ Relative Density	W (%)
0		(7-inches organic TOPSOIL)		
1		Brown SILT, moist, trace rootlets, weak cementation. (ML)		17.5
2			medium stiff	
3				
4				
5		Brown to gray SILT with sand, fine to coarse sand, moist to wet, mottled. (ML)		34.7
6				
7				
8			stiff	35.1
9				
10				34.6
11		Test Pit terminated at approximately 10 feet. Minor groundwater seepage observed at approximately 10 feet. No caving observed.		
12				

NOTE: This subsurface information pertains only to this test pit location and should not be interpreted as being indicative of other locations at the site.

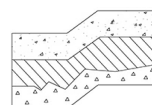

**Terra Associates, Inc.**  
 Consultants in Geotechnical Engineering  
 Geology and  
 Environmental Earth Sciences

# LOG OF TEST PIT NO. TP-58

FIGURE A-59

**PROJECT NAME:** Camas Business Center      **PROJ. NO:** T-8553      **LOGGED BY:** MJX

**LOCATION:** Camas, Washington      **SURFACE CONDITIONS:** Tall Grass      **APPROX. ELEV:** NA

**DATE LOGGED:** May 24, 2021      **DEPTH TO GROUNDWATER:** NA      **DEPTH TO CAVING:** NA

Depth (ft)	Sample No.	Description	Consistency/ Relative Density	W (%)
0		(8-inches organic TOPSOIL)		
1		Brown SILT, dry to moist, scattered rootlets, weak cementation. (ML)	medium stiff	16.9
2				
3				
4		Brown to gray SILT with sand, fine to coarse sand, moist, mottled. (ML)	stiff	35.1
5				
6				
7				
8				
9				
10				34.9
11		Test Pit terminated at approximately 10 feet. No groundwater seepage observed. No caving observed.		
12				

NOTE: This subsurface information pertains only to this test pit location and should not be interpreted as being indicative of other locations at the site.

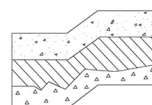

Terra  
Associates, Inc.

Consultants in Geotechnical Engineering  
Geology and  
Environmental Earth Sciences

# LOG OF TEST PIT NO. TP-59

FIGURE A-60

**PROJECT NAME:** Camas Business Center      **PROJ. NO:** T-8553      **LOGGED BY:** MJX

**LOCATION:** Camas, Washington      **SURFACE CONDITIONS:** Tall Grass      **APPROX. ELEV:** NA

**DATE LOGGED:** May 24, 2021      **DEPTH TO GROUNDWATER:** NA      **DEPTH TO CAVING:** NA

Depth (ft)	Sample No.	Description	Consistency/ Relative Density	W (%)
0		(6-inches organic TOPSOIL)		
1		Brown SILT, moist, trace rootlets, weak cementation. (ML)		
2				
3				
4		Brown to gray SILT with sand, fine to coarse sand, moist, mottled. (ML)	medium stiff	35.1
5				
6				
7				
8				
9			stiff	38.9
10				
11		Test Pit terminated at approximately 10 feet. No groundwater seepage observed. No caving observed.		38.4
12				

NOTE: This subsurface information pertains only to this test pit location and should not be interpreted as being indicative of other locations at the site.

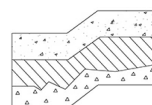

**Terra Associates, Inc.**  
 Consultants in Geotechnical Engineering  
 Geology and  
 Environmental Earth Sciences

# LOG OF TEST PIT NO. TP-60

FIGURE A-61

**PROJECT NAME:** Camas Business Center      **PROJ. NO:** T-8553      **LOGGED BY:** MJX

**LOCATION:** Camas, Washington      **SURFACE CONDITIONS:** Tall Grass      **APPROX. ELEV:** NA

**DATE LOGGED:** May 24, 2021      **DEPTH TO GROUNDWATER:** 8 ft      **DEPTH TO CAVING:** NA

Depth (ft)	Sample No.	Description	Consistency/ Relative Density	W (%)
0		(8-inches organic TOPSOIL)		
1		Red SILT, moist, trace rootlets, weak cementation. (ML)		22.5
2			medium stiff	
3				
4		Brownish-gray to gray clayey SILT with sand, fine to coarse sand, moist, mottled, trace gravel. (ML)		37.0
5				
6			stiff	34.2
7				
8		Blueish-gray silty SAND with gravel, fine to coarse sand, fine to coarse gravel, wet. (SM)		
9			medium dense	30.1
10				
11		Test Pit terminated at approximately 10 feet. Minor groundwater seepage observed at approximately 8 feet. No caving observed.		
12				

NOTE: This subsurface information pertains only to this test pit location and should not be interpreted as being indicative of other locations at the site.

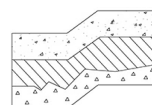

**Terra Associates, Inc.**  
 Consultants in Geotechnical Engineering  
 Geology and Environmental Earth Sciences



# LOG OF TEST PIT NO. TP-61

FIGURE A-62

**PROJECT NAME:** Camas Business Center      **PROJ. NO:** T-8553      **LOGGED BY:** MJX

**LOCATION:** Camas, Washington      **SURFACE CONDITIONS:** Duff/understory      **APPROX. ELEV:** NA

**DATE LOGGED:** May 25, 2021      **DEPTH TO GROUNDWATER:** NA      **DEPTH TO CAVING:** NA

Depth (ft)	Sample No.	Description	Consistency/ Relative Density	W (%)
0		(5-inches organic TOPSOIL)		
1		Brown SILT, moist, trace rootlets, weak cementation. (ML)		19.6
2				
3		Brown SILT with sand, fine to coarse sand, moist, mottled. (ML)	medium stiff	
4				36.2
5				
6		Gray SILT with sand and gravel, fine to coarse sand, fine to coarse gravel, moist, mottled. (ML)		
7			stiff	40.1
8				
9		Blueish-gray to dark gray SILT to SILT with sand, fine to coarse sand, moist, trace gravel. (ML)		49.1
10			very stiff	41.7
11		Test Pit terminated at approximately 11 feet. No groundwater seepage observed.		
12		No caving observed.		
13				

NOTE: This subsurface information pertains only to this test pit location and should not be interpreted as being indicative of other locations at the site.

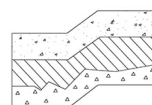

**Terra  
Associates, Inc.**  
Consultants in Geotechnical Engineering  
Geology and  
Environmental Earth Sciences

# LOG OF TEST PIT NO. TP-62

FIGURE A-63

**PROJECT NAME:** Camas Business Center      **PROJ. NO:** T-8553      **LOGGED BY:** MJX

**LOCATION:** Camas, Washington      **SURFACE CONDITIONS:** Duff/understory      **APPROX. ELEV:** NA

**DATE LOGGED:** May 25, 2021      **DEPTH TO GROUNDWATER:** NA      **DEPTH TO CAVING:** NA

Depth (ft)	Sample No.	Description	Consistency/ Relative Density	W (%)
0		(6-inches organic TOPSOIL)		
1		Brown SILT, moist, numerous roots, scattered rootlets. (ML)		18.7
2				
3		Brown SILT with sand, fine to coarse sand, moist, mottled, occasional organic. (ML)	medium stiff	30.4
4				
5				
6				
7		Brown to gray GRAVEL with silt and sand, fine to coarse sand, fine to coarse gravel, moist, mottled, trace cobbles. (GP-GM)	medium dense	41.4
8				
9				
10				
11		Test Pit terminated at approximately 11 feet. No groundwater seepage observed. No caving observed.		36.3
12				
13				

NOTE: This subsurface information pertains only to this test pit location and should not be interpreted as being indicative of other locations at the site.

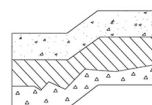

**Terra Associates, Inc.**  
 Consultants in Geotechnical Engineering  
 Geology and  
 Environmental Earth Sciences

# LOG OF TEST PIT NO. TP-63

FIGURE A-64

**PROJECT NAME:** Camas Business Center      **PROJ. NO:** T-8553      **LOGGED BY:** MJX

**LOCATION:** Camas, Washington      **SURFACE CONDITIONS:** Tall Grass      **APPROX. ELEV:** NA

**DATE LOGGED:** May 25, 2021      **DEPTH TO GROUNDWATER:** 7 ft      **DEPTH TO CAVING:** NA

Depth (ft)	Sample No.	Description	Consistency/ Relative Density	W (%)
0		(7-inches organic TOPSOIL)		
1		Dark brown SILT, moist, mottled, occasional rootlet. (ML)	medium stiff	18.0
2				
3		Gray SILT with sand, fine to coarse sand, moist, mottled. (ML)	stiff	35.0
4		Gray SILT, moist, mottled. (ML)		
5		Brown to gray GRAVEL with silt and sand, fine to coarse sand, fine to coarse gravel, moist to wet, mottled, scattered cobbles. (GP-GM)	medium dense	38.9
6				
7				
8				
9				
10				
11		Test Pit terminated at approximately 11 feet. Moderate groundwater seepage observed at approximately 7 feet. No caving observed.		50.4
12				
13				

NOTE: This subsurface information pertains only to this test pit location and should not be interpreted as being indicative of other locations at the site.

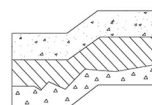

**Terra Associates, Inc.**  
 Consultants in Geotechnical Engineering  
 Geology and Environmental Earth Sciences

# LOG OF TEST PIT NO. TP-64

FIGURE A-65

**PROJECT NAME:** Camas Business Center      **PROJ. NO:** T-8553      **LOGGED BY:** MJX

**LOCATION:** Camas, Washington      **SURFACE CONDITIONS:** Tall Grass      **APPROX. ELEV:** NA

**DATE LOGGED:** May 25, 2021      **DEPTH TO GROUNDWATER:** NA      **DEPTH TO CAVING:** NA

Depth (ft)	Sample No.	Description	Consistency/ Relative Density	W (%)
0		(6-inches organic TOPSOIL)		
1		Brown SILT, moist, numerous rootlets, weak cementation. (ML)	medium stiff	19.7
2		Gray to dark gray SILT, moist, mottled, occasional rootlet. (ML)		22.1
3				
4				
5				37.4
6			stiff	
7				41.0
8				
9				
10				
11				54.0
12		Test Pit terminated at approximately 11 feet. No groundwater seepage observed. No caving observed.		
13				

NOTE: This subsurface information pertains only to this test pit location and should not be interpreted as being indicative of other locations at the site.

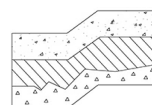

**Terra Associates, Inc.**  
 Consultants in Geotechnical Engineering  
 Geology and  
 Environmental Earth Sciences

# LOG OF TEST PIT NO. TP-65

FIGURE A-66

**PROJECT NAME:** Camas Business Center      **PROJ. NO:** T-8553      **LOGGED BY:** MJX

**LOCATION:** Camas, Washington      **SURFACE CONDITIONS:** Grass      **APPROX. ELEV:** NA

**DATE LOGGED:** May 25, 2021      **DEPTH TO GROUNDWATER:** NA      **DEPTH TO CAVING:** NA

Depth (ft)	Sample No.	Description	Consistency/ Relative Density	W (%)
0		(4-inches organic TOPSOIL)		
1		Brown SILT, moist, trace rootlets, weak cementation. (ML)	medium stiff	15.0
2		Gray to dark gray SILT, moist, mottled, occasional rootlet. (ML)		33.6
3			stiff	
4				
5		Brown to gray GRAVEL with silt and sand, fine to coarse sand, fine to coarse gravel, moist, mottled, scattered cobbles. (GP-GM)		25.4
6				
7			medium dense	
8				
9				
10				36.0
11		Test Pit terminated at approximately 10 feet. No groundwater seepage observed. No caving observed.		
12				

NOTE: This subsurface information pertains only to this test pit location and should not be interpreted as being indicative of other locations at the site.

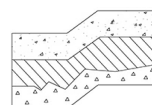

**Terra Associates, Inc.**  
 Consultants in Geotechnical Engineering  
 Geology and Environmental Earth Sciences

# LOG OF TEST PIT NO. TP-66

FIGURE A-67

**PROJECT NAME:** Camas Business Center      **PROJ. NO:** T-8553      **LOGGED BY:** MJX

**LOCATION:** Camas, Washington      **SURFACE CONDITIONS:** Grass      **APPROX. ELEV:** NA

**DATE LOGGED:** May 25, 2021      **DEPTH TO GROUNDWATER:** NA      **DEPTH TO CAVING:** NA

Depth (ft)	Sample No.	Description	Consistency/ Relative Density	W (%)
0		(6-inches organic TOPSOIL)		
1		Brown SILT, moist, trace rootlets, weak cementation. (ML)		16.6
2				
3		Brown to gray SILT with sand, fine to medium sand, moist, mottled. (ML)	medium stiff	30.4
4				
5				
6				
7		Brown to gray silty GRAVEL with sand, fine to coarse sand, fine to coarse gravel, moist, mottled. (GM)	medium dense	47.8
8				
9				
10				48.0
11		Test Pit terminated at approximately 10 feet. No groundwater seepage observed. No caving observed.		
12				

NOTE: This subsurface information pertains only to this test pit location and should not be interpreted as being indicative of other locations at the site.

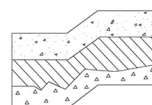

**Terra Associates, Inc.**  
 Consultants in Geotechnical Engineering  
 Geology and Environmental Earth Sciences

# LOG OF TEST PIT NO. TP-67

FIGURE A-68

**PROJECT NAME:** Camas Business Center      **PROJ. NO:** T-8553      **LOGGED BY:** MJX

**LOCATION:** Camas, Washington      **SURFACE CONDITIONS:** Grass      **APPROX. ELEV:** NA

**DATE LOGGED:** May 25, 2021      **DEPTH TO GROUNDWATER:** NA      **DEPTH TO CAVING:** NA

Depth (ft)	Sample No.	Description	Consistency/ Relative Density	W (%)
0		(6-inches organic TOPSOIL)		
1		Brown SILT, moist, trace rootlets, weak cementation. (ML)		21.1
2				
3		----- Brown SILT with sand, fine to coarse sand, moist, mottled. (ML)	medium stiff	
4				33.5
5				
6		----- Gray SILT with sand, fine to medium sand, moist, mottled. (ML)		38.9
7			stiff	
8				
9		----- Brown to gray SILT, moist, mottled. (ML)		
10			very stiff	
11		Test Pit terminated at approximately 10 feet. No groundwater seepage observed. No caving observed.		31.5
12				

NOTE: This subsurface information pertains only to this test pit location and should not be interpreted as being indicative of other locations at the site.

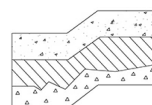

Terra  
Associates, Inc.

Consultants in Geotechnical Engineering  
Geology and  
Environmental Earth Sciences

# LOG OF TEST PIT NO. TP-68

FIGURE A-69

**PROJECT NAME:** Camas Business Center      **PROJ. NO:** T-8553      **LOGGED BY:** MJX

**LOCATION:** Camas, Washington      **SURFACE CONDITIONS:** Grass      **APPROX. ELEV:** NA

**DATE LOGGED:** May 25, 2021      **DEPTH TO GROUNDWATER:** NA      **DEPTH TO CAVING:** NA

Depth (ft)	Sample No.	Description	Consistency/ Relative Density	W (%)
0		(5-inches organic TOPSOIL)		
1		Brown SILT, moist, trace rootlets, weak cementation. (ML)		20.1
2				
3		Brown SILT with sand, fine to coarse sand, moist, mottled. (ML)	medium stiff	43.8
4				
5				
6				
7		Gray SILT with sand to sandy SILT, fine sand, moist. (ML)		39.6
8				
9		Blueish-gray SILT to SILT with sand, fine sand, moist. (ML)	stiff	44.6
10				
11		Test Pit terminated at approximately 11 feet. No groundwater seepage observed. No caving observed.		32.3
12				
13				

NOTE: This subsurface information pertains only to this test pit location and should not be interpreted as being indicative of other locations at the site.

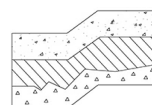

**Terra Associates, Inc.**  
 Consultants in Geotechnical Engineering  
 Geology and  
 Environmental Earth Sciences



# LOG OF TEST PIT NO. TP-69

FIGURE A-70

**PROJECT NAME:** Camas Business Center      **PROJ. NO:** T-8553      **LOGGED BY:** MJX

**LOCATION:** Camas, Washington      **SURFACE CONDITIONS:** Grass      **APPROX. ELEV:** NA

**DATE LOGGED:** May 25, 2021      **DEPTH TO GROUNDWATER:** NA      **DEPTH TO CAVING:** NA

Depth (ft)	Sample No.	Description	Consistency/ Relative Density	W (%)
0		(7-inches organic TOPSOIL)		
1		Brown SILT, moist, trace rootlets, occasional organic, weak cementation. (ML)		21.0
2				
3		-----		
4		Brown SILT with sand, fine to coarse sand, moist, mottled. (ML)	medium stiff	35.7
5				
6				
7		-----		25.4
8		Brown to gray SILT with gravel, fine to coarse gravel, moist, mottled, scattered cobbles. (ML)		
9		-----		
10		Brown to gray SILT with sand and gravel, fine to coarse sand, fine to coarse gravel, moist, mottled, trace cobbles. (ML)	stiff	56.3
11		-----		57.2
12		Test Pit terminated at approximately 11 feet. No groundwater seepage observed. No caving observed.		
13				

NOTE: This subsurface information pertains only to this test pit location and should not be interpreted as being indicative of other locations at the site.

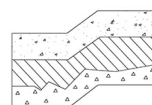

**Terra Associates, Inc.**  
 Consultants in Geotechnical Engineering  
 Geology and  
 Environmental Earth Sciences

# LOG OF TEST PIT NO. TP-70

FIGURE A-71

**PROJECT NAME:** Camas Business Center      **PROJ. NO:** T-8553      **LOGGED BY:** MJX

**LOCATION:** Camas, Washington      **SURFACE CONDITIONS:** Grass      **APPROX. ELEV:** NA

**DATE LOGGED:** May 25, 2021      **DEPTH TO GROUNDWATER:** 9 ft      **DEPTH TO CAVING:** NA

Depth (ft)	Sample No.	Description	Consistency/ Relative Density	W (%)
0		(7-inches organic TOPSOIL)		
1		Brown SILT, dry to moist, trace rootlets, weak cementation. (ML)		13.8
2			medium stiff	
3				
4		----- Brown SILT with sand, fine to coarse sand, moist, mottled. (ML)		33.6
5				
6				
7		----- Brown GRAVEL with silt and sand, fine to coarse sand, fine to coarse gravel, moist, mottled, trace cobbles. (GP-GM)		39.9
8			medium dense	
9				
10				
11		Test Pit terminated at approximately 11 feet. Minor groundwater seepage observed at approximately 9 feet. No caving observed.		26.3
12				
13				

NOTE: This subsurface information pertains only to this test pit location and should not be interpreted as being indicative of other locations at the site.

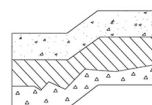

**Terra Associates, Inc.**  
 Consultants in Geotechnical Engineering  
 Geology and  
 Environmental Earth Sciences

# LOG OF TEST PIT NO. TP-71

FIGURE A-72

**PROJECT NAME:** Camas Business Center      **PROJ. NO:** T-8553      **LOGGED BY:** MJX

**LOCATION:** Camas, Washington      **SURFACE CONDITIONS:** Grass      **APPROX. ELEV:** NA

**DATE LOGGED:** May 25, 2021      **DEPTH TO GROUNDWATER:** 9 ft      **DEPTH TO CAVING:** NA

Depth (ft)	Sample No.	Description	Consistency/ Relative Density	W (%)
0		(6-inches organic TOPSOL)		
1		Brown SILT, moist, trace rootlets, weak cementation. (ML)	medium stiff	17.2
2				
3				
4		Brown SILT with sand, fine to coarse sand, moist, mottled. (ML)		
5				37.7
6				
7		Brown GRAVEL with silt and sand, fine to coarse sand, fine to coarse gravel, moist to wet, mottled, trace cobbles, occasional boulder. (GP-GM)		17.8
8				
9			medium dense	
10				
11				
12				39.8
13		Test Pit terminated at approximately 12 feet. Moderate groundwater seepage observed at approximately 9 feet. No caving observed.		
14				

NOTE: This subsurface information pertains only to this test pit location and should not be interpreted as being indicative of other locations at the site.

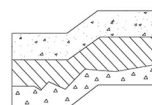

Terra  
Associates, Inc.

Consultants in Geotechnical Engineering  
Geology and  
Environmental Earth Sciences

# LOG OF TEST PIT NO. TP-72

FIGURE A-73

**PROJECT NAME:** Camas Business Center      **PROJ. NO:** T-8553      **LOGGED BY:** MJX

**LOCATION:** Camas, Washington      **SURFACE CONDITIONS:** Grass      **APPROX. ELEV:** NA

**DATE LOGGED:** May 25, 2021      **DEPTH TO GROUNDWATER:** 10 ft      **DEPTH TO CAVING:** NA

Depth (ft)	Sample No.	Description	Consistency/ Relative Density	W (%)
0		(7-inches organic TOPSOIL)		
1		Brown SILT, moist, trace rootlets, weak cementation. (ML)		20.5
2			medium stiff	
3				
4		----- Brown SILT with sand, fine to coarse sand, moist, mottled. (ML)		35.3
5				
6				
7		----- Gray sandy SILT, fine sand, moist, slightly mottled. (ML)		36.0
8			stiff	
9				
10		----- Brown to gray GRAVEL with silt and sand, fine to coarse sand, fine to coarse gravel, moist to wet, mottled. (GP-GM)		40.1
11			medium dense	
12		Test Pit terminated at approximately 11 feet. Minor groundwater seepage observed at approximately 10 feet. No caving observed.		
13				

NOTE: This subsurface information pertains only to this test pit location and should not be interpreted as being indicative of other locations at the site.

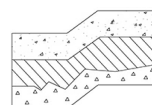

**Terra Associates, Inc.**  
 Consultants in Geotechnical Engineering  
 Geology and  
 Environmental Earth Sciences

# LOG OF TEST PIT NO. TP-73

FIGURE A-74

**PROJECT NAME:** Camas Business Center      **PROJ. NO:** T-8553      **LOGGED BY:** MJX

**LOCATION:** Camas, Washington      **SURFACE CONDITIONS:** Grass      **APPROX. ELEV:** NA

**DATE LOGGED:** May 24, 2021      **DEPTH TO GROUNDWATER:** NA      **DEPTH TO CAVING:** NA

Depth (ft)	Sample No.	Description	Consistency/ Relative Density	W (%)
0		(6-inches organic TOPSOIL)		
1		Brown SILT, moist, trace rootlets, occasional cobble, occasional organic, weak cementation. (ML)	medium stiff	20.8
2				
3				
4		Brown to gray SILT with sand, fine to medium sand, moist, mottled. (ML)		34.5
5				
6				35.1
7				
8		Blueish-gray SILT with sand to sandy SILT, fine to medium sand, moist. (ML)	stiff	31.7
9				
10				
11		Test Pit terminated at approximately 10 feet. No groundwater seepage observed. No caving observed.		
12				

NOTE: This subsurface information pertains only to this test pit location and should not be interpreted as being indicative of other locations at the site.

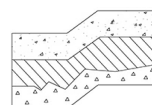

**Terra Associates, Inc.**  
 Consultants in Geotechnical Engineering  
 Geology and  
 Environmental Earth Sciences

# LOG OF TEST PIT NO. TP-74

FIGURE A-75

**PROJECT NAME:** Camas Business Center      **PROJ. NO:** T-8553      **LOGGED BY:** MJX

**LOCATION:** Camas, Washington      **SURFACE CONDITIONS:** Grass      **APPROX. ELEV:** NA

**DATE LOGGED:** May 24, 2021      **DEPTH TO GROUNDWATER:** NA      **DEPTH TO CAVING:** NA

Depth (ft)	Sample No.	Description	Consistency/ Relative Density	W (%)
0		(6-inches organic TOPSOIL)		
1		Brown SILT, dry to moist, trace rootlets, weak cementation. (ML)		16.6
2				
3				
4		Brown to gray SILT with sand, fine to coarse sand, moist, mottled. (ML)	medium stiff	42.6
5				
6				
7				
8		Brown silty GRAVEL with sand, fine to coarse sand, fine to coarse gravel, moist, scattered cobbles. (GM)		30.2
9			medium dense	
10				
11		Test Pit terminated at approximately 10 feet. No groundwater seepage observed. No caving observed.		
12				

NOTE: This subsurface information pertains only to this test pit location and should not be interpreted as being indicative of other locations at the site.

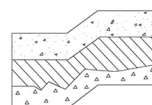

**Terra Associates, Inc.**  
 Consultants in Geotechnical Engineering  
 Geology and Environmental Earth Sciences

# LOG OF TEST PIT NO. TP-75

FIGURE A-76

**PROJECT NAME:** Camas Business Center      **PROJ. NO:** T-8553      **LOGGED BY:** MJX

**LOCATION:** Camas, Washington      **SURFACE CONDITIONS:** Grass      **APPROX. ELEV:** NA

**DATE LOGGED:** May 24, 2021      **DEPTH TO GROUNDWATER:** NA      **DEPTH TO CAVING:** NA

Depth (ft)	Sample No.	Description	Consistency/ Relative Density	W (%)
0		(8-inches organic TOPSOIL)		
1		Brown SILT, moist, trace rootlets, weak cementation. (ML)		19.5
2			medium stiff	
3				
4				
5		Brown to gray SILT with sand, fine to coarse sand, moist, mottled. (ML)		40.9
6				
7				35.3
8			stiff	
9				
10				39.1
11		Test Pit terminated at approximately 10 feet. No groundwater seepage observed. No caving observed.		
12				

NOTE: This subsurface information pertains only to this test pit location and should not be interpreted as being indicative of other locations at the site.

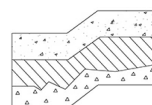

**Terra Associates, Inc.**  
 Consultants in Geotechnical Engineering  
 Geology and Environmental Earth Sciences

# LOG OF TEST PIT NO. TP-76

FIGURE A-77

**PROJECT NAME:** Camas Business Center      **PROJ. NO:** T-8553      **LOGGED BY:** MJX

**LOCATION:** Camas, Washington      **SURFACE CONDITIONS:** Grass      **APPROX. ELEV:** NA

**DATE LOGGED:** May 24, 2021      **DEPTH TO GROUNDWATER:** 7 ft      **DEPTH TO CAVING:** NA

Depth (ft)	Sample No.	Description	Consistency/ Relative Density	W (%)
0		(9-inches organic TOPSOIL)		
1		Brown SILT with gravel, dry to moist, fine to coarse gravel, trace rootlets, weak cementation. (ML)		17.3
2			medium stiff	
3				
4				
5		Brown to gray SILT with sand, fine to coarse sand, moist, mottled, occasional gravel. (ML)		36.9
6				
7		Brown SAND with silt, fine to medium sand, moist to wet, interbedded silt seams. (SP-SM)		37.7
8			medium dense	
9		Gray SILT, moist. (ML)		49.6
10			stiff	
11		Test Pit terminated at approximately 10 feet. Moderate groundwater seepage observed at approximately 7 feet. No caving observed.		
12				

NOTE: This subsurface information pertains only to this test pit location and should not be interpreted as being indicative of other locations at the site.

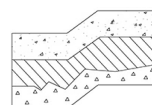

**Terra Associates, Inc.**  
 Consultants in Geotechnical Engineering  
 Geology and Environmental Earth Sciences



# LOG OF TEST PIT NO. TP-77

FIGURE A-78

**PROJECT NAME:** Camas Business Center      **PROJ. NO:** T-8553      **LOGGED BY:** MJX

**LOCATION:** Camas, Washington      **SURFACE CONDITIONS:** Grass      **APPROX. ELEV:** NA

**DATE LOGGED:** May 24, 2021      **DEPTH TO GROUNDWATER:** 11 ft      **DEPTH TO CAVING:** NA

Depth (ft)	Sample No.	Description	Consistency/ Relative Density	W (%)
0		(11-inches organic TOPSOIL)		
1		Brown SILT, moist, trace rootlets, weak cementation. (ML)		19.2
2				
3				
4		Brown SILT with sand, fine to coarse sand, moist, mottled, occasional gravel. (ML)		41.5
5			medium stiff	
6				
7				
8				
9				
10				
11		Brown silty SAND with gravel, fine to coarse sand, fine to coarse gravel, wet, occasional cobble. (SM)	medium dense	48.8
12		Test Pit terminated at approximately 12 feet. Minor groundwater seepage observed at approximately 11 feet. No caving observed.		
13				
14				

NOTE: This subsurface information pertains only to this test pit location and should not be interpreted as being indicative of other locations at the site.

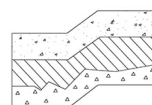

**Terra Associates, Inc.**  
 Consultants in Geotechnical Engineering  
 Geology and Environmental Earth Sciences

# LOG OF TEST PIT NO. TP-78

FIGURE A-79

**PROJECT NAME:** Camas Business Center      **PROJ. NO:** T-8553      **LOGGED BY:** MJX

**LOCATION:** Camas, Washington      **SURFACE CONDITIONS:** Grass      **APPROX. ELEV:** NA

**DATE LOGGED:** May 24, 2021      **DEPTH TO GROUNDWATER:** NA      **DEPTH TO CAVING:** NA

Depth (ft)	Sample No.	Description	Consistency/ Relative Density	W (%)
0		(11-inches organic TOPSOIL)		
1		FILL: Brown SILT, moist, trace rootlets, occasional organic, occasional metal debris, occasional plastic debris. (ML)		22.9
2				
3		----- Brown to gray SILT with sand, fine to coarse sand, moist, mottled. (ML)	medium stiff	33.7
4				
5				
6				39.5
7			stiff	
8		----- Gray SILT, moist, mottled. (ML)		
9			very stiff	
10				27.5
11		Test Pit terminated at approximately 10 feet. No groundwater seepage observed. No caving observed.		
12				

NOTE: This subsurface information pertains only to this test pit location and should not be interpreted as being indicative of other locations at the site.

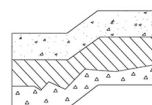

**Terra Associates, Inc.**  
 Consultants in Geotechnical Engineering  
 Geology and  
 Environmental Earth Sciences

# LOG OF TEST PIT NO. TP-79

FIGURE A-80

**PROJECT NAME:** Camas Business Center      **PROJ. NO:** T-8553      **LOGGED BY:** MJX

**LOCATION:** Camas, Washington      **SURFACE CONDITIONS:** Tall Grass      **APPROX. ELEV:** NA

**DATE LOGGED:** May 24, 2021      **DEPTH TO GROUNDWATER:** NA      **DEPTH TO CAVING:** NA

Depth (ft)	Sample No.	Description	Consistency/ Relative Density	W (%)
0		(6-inches organic TOPSOIL)		
1		Brown SILT, dry to moist, scattered rootlets, weak cementation. (ML)		18.0
2				
3		-----		
4		Brown SILT with sand to clayey SILT with sand, fine to coarse sand, moist, slightly mottled. (ML)	medium stiff	34.4
5				
6				
7				
8		-----		
9		Brownish-gray sandy SILT, fine to coarse sand, moist, mottled. (ML)	stiff	46.0
10		-----		
11		Gray SILT with sand, fine to coarse sand, moist to wet, mottled, alternating layers of blueish-gray SILT with sand. (ML)	medium stiff to stiff	50.6
12				
13		Test Pit terminated at approximately 12 feet. No groundwater seepage observed. No caving observed.		
14				

NOTE: This subsurface information pertains only to this test pit location and should not be interpreted as being indicative of other locations at the site.

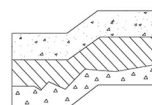

**Terra Associates, Inc.**  
 Consultants in Geotechnical Engineering  
 Geology and  
 Environmental Earth Sciences

# LOG OF TEST PIT NO. TP-80

FIGURE A-81

**PROJECT NAME:** Camas Business Center      **PROJ. NO:** T-8553      **LOGGED BY:** MJX

**LOCATION:** Camas, Washington      **SURFACE CONDITIONS:** Tall Grass      **APPROX. ELEV:** NA

**DATE LOGGED:** May 24, 2021      **DEPTH TO GROUNDWATER:** NA      **DEPTH TO CAVING:** NA

Depth (ft)	Sample No.	Description	Consistency/ Relative Density	W (%)
0		(6-inches organic TOPSOIL)		
1		Brown SILT, moist, trace rootlets, weak cementation. (ML)		25.2
2				
3		Brown SILT with sand to clayey SILT with sand, fine to coarse sand, moist, slightly mottled. (ML)	medium stiff	
4				33.7
5				
6				
7				
8			stiff	
9		Brownish-gray sandy SILT, fine to coarse sand, moist, mottled. (ML)		
10				35.7
11		Test Pit terminated at approximately 10 feet. No groundwater seepage observed. No caving observed.		
12				

NOTE: This subsurface information pertains only to this test pit location and should not be interpreted as being indicative of other locations at the site.

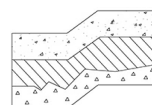

Terra  
Associates, Inc.

Consultants in Geotechnical Engineering  
Geology and  
Environmental Earth Sciences

# Particle Size Distribution Report

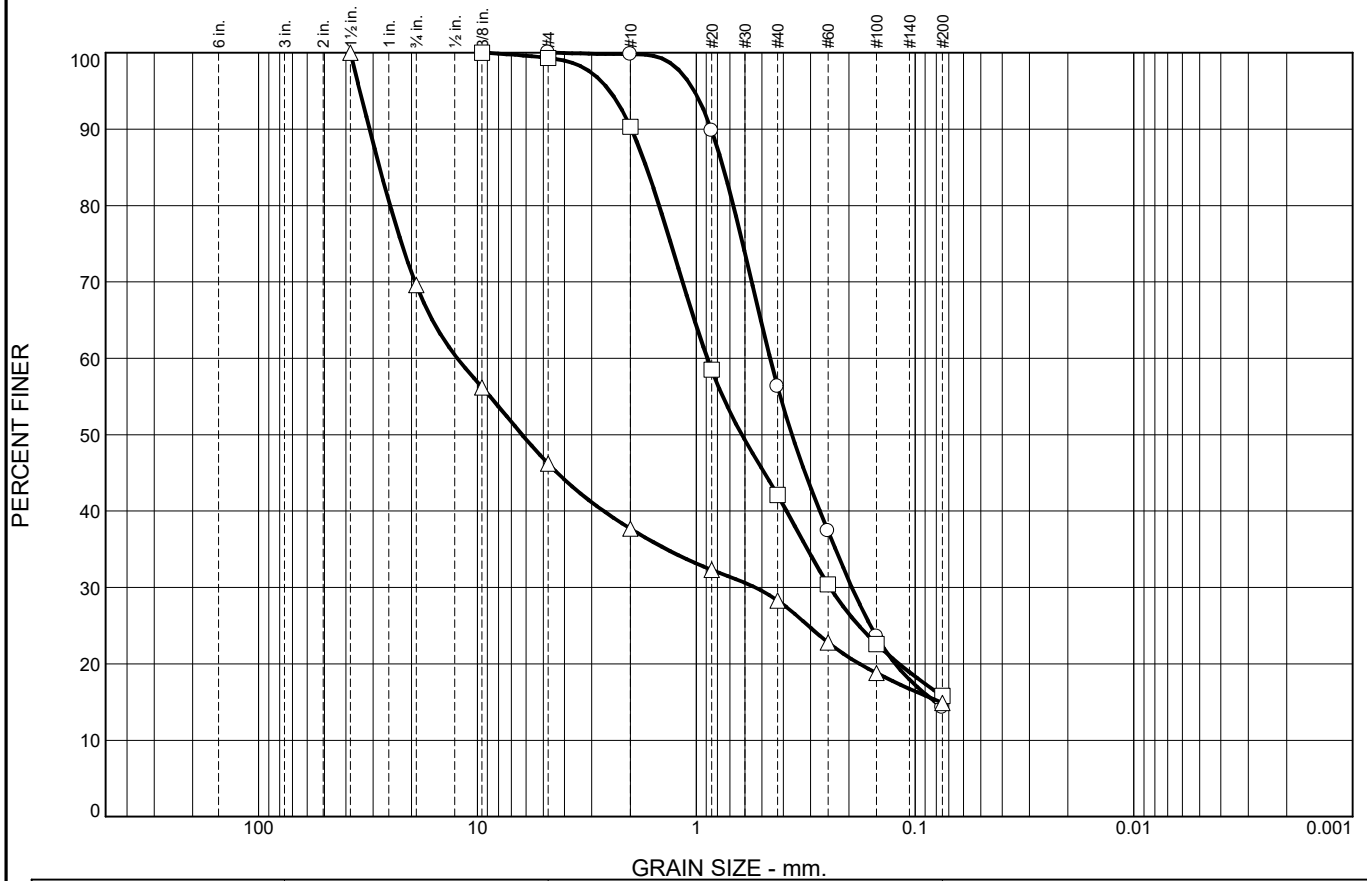

	% +3"	% Gravel		% Sand			% Fines			
		Coarse	Fine	Coarse	Medium	Fine	Silt	Clay		
○	0.0	0.0	0.0	0.2	43.5	42.0	14.3			
□	0.0	0.0	0.7	9.0	48.2	26.3	15.8			
△	0.0	30.4	23.4	8.5	9.4	13.4	14.9			
×	LL	PL	D85	D60	D50	D30	D15	D10	C <sub>c</sub>	C <sub>u</sub>
○			0.7536	0.4595	0.3654	0.1943	0.0807			
□			1.6902	0.8889	0.6189	0.2449				
△			28.0367	12.3693	6.2492	0.5373	0.0764			

Material Description	USCS	AASHTO
○ silty SAND	SM	
□ silty SAND	SM	
△ silty GRAVEL with sand	GM	

<b>Project No.</b> T-8553 <b>Client:</b> Panattoni Development Company <b>Project:</b> East Vancouver E-Commerce Center	<b>Remarks:</b> ○ Tested on June 8, 2021 □ Tested on June 8, 2021 △ Tested on June 8, 2021
○ <b>Location:</b> Test Pit TP-11 <b>Depth:</b> 8 ft <b>Sample Number:</b> 4 □ <b>Location:</b> Test Pit TP-31 <b>Depth:</b> 8 ft <b>Sample Number:</b> 4 △ <b>Location:</b> Test Pit TP-35 <b>Depth:</b> 6 ft <b>Sample Number:</b> 3	
<b>Terra Associates, Inc.</b>  <b>Kirkland, WA</b>	

Figure A-82

Tested By: FQ

# Particle Size Distribution Report

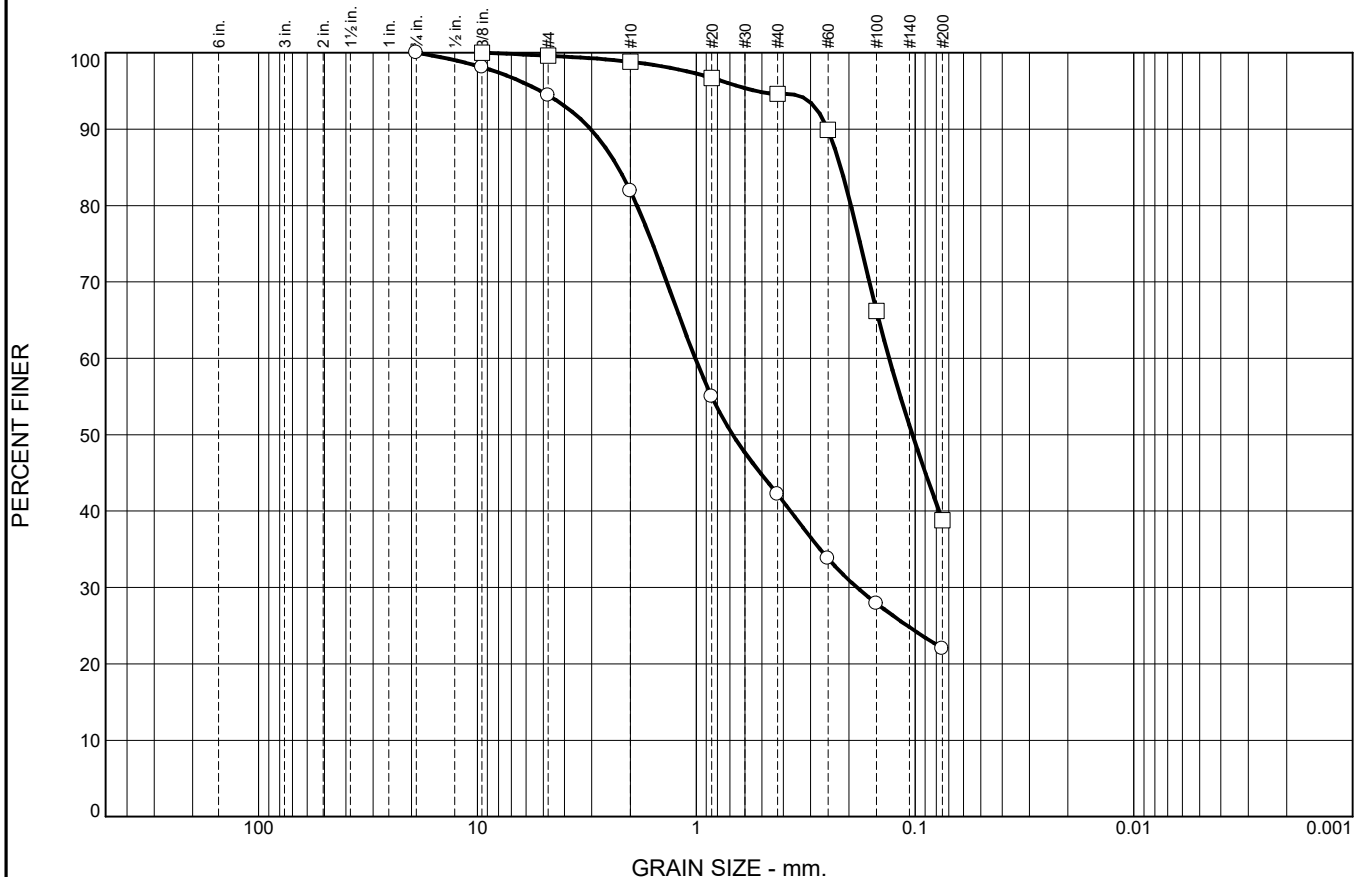

	% +3"	% Gravel		% Sand			% Fines	
		Coarse	Fine	Coarse	Medium	Fine	Silt	Clay
○	0.0	0.0	5.6	12.5	39.7	20.2	22.0	
□	0.0	0.0	0.4	0.8	4.2	55.8	38.8	

	LL	PL	D85	D60	D50	D30	D15	D10	Cc	Cu
○			2.2786	1.0101	0.6816	0.1842				
□			0.2186	0.1314	0.1027					

Material Description	USCS	AASHTO
○ silty SAND with gravel	SM	
□ silty SAND	SM	

<b>Project No.</b> T-8553 <b>Client:</b> Panattoni Development Company <b>Project:</b> East Vancouver E-Commerce Center	<b>Remarks:</b> ○ Tested on June 8, 2021 □ Tested on June 8, 2021
○ <b>Location:</b> Test Pit TP-39 <b>Depth:</b> 10 ft <b>Sample Number:</b> 3 □ <b>Location:</b> Test Pit TP-45 <b>Depth:</b> 10 ft <b>Sample Number:</b> 3	
<b>Terra Associates, Inc.</b>  <b>Kirkland, WA</b>	

Figure A-83

Tested By: FQ