



PUBLIC WORKS DEPARTMENT

BID SPECIFICATIONS

AND

CONTRACT DOCUMENTS

FOR

**STREET LIGHT POLE REPLACEMENT,
MAINTENANCE AND REPAIR
(UNIT PRICED PUBLIC WORKS CONTRACT)**

CITY PROJECT NUMBER:

UPC2201

MAY 2022

TABLE OF CONTENTS

<u>SECTION</u>	<u>PAGE</u>
CALL FOR BIDS	3
PART ONE – BIDDING DOCUMENTS	6
BIDDER’S INFORMATION PAGE	
PROPOSAL	
MANDATORY BIDDER RESPONSIBILITY CRITERIA	
SUBCONTRACTOR MANDATORY BIDDER RESPONSIBILITY CRITERIA	
BIDDER’S CHECKLIST	
ACKNOWLEDGEMENT OF CONTRACTOR LAWFUL HIRING	
COMPLIANCE ENROLLMENT	
NON-COLLUSION DECLARATION	
NOTICE TO ALL BIDDERS	
BID BOND ACKNOWLEDGEMENT	
PART TWO – GENERAL INFORMATION	16
GENERAL INFORMATION	
PREPARING AND SUBMITTING A BID	
EVALUATION AND CONTRACT AWARD	
SCOPE OF WORK AND TECHNICAL REQUIREMENTS	
PART THREE – CONTRACT DOCUMENTS	29
CONTRACT	
DECLARATION OF OPTION FOR INVESTMENT OF RETAINED PERCENTAGE	
CONTRACT BOND	
STANDARD TITLE VI/ NON-DISCRIMINATION ASSURANCES	
PART FOUR - AMENDMENTS TO THE STANDARD SPECIFICATIONS	38
PART FIVE – STATE MINIMUM HOURLY PREVAILING WAGE RATES	39
PART SIX – AFFIDAVIT OF E-VERIFY COMPLIANCE	40
PART SEVEN – EQUIPMENT SPECIFICATIONS AND STANDARD DETAILS	42
PART EIGHT – APPENDICES	47
APPENDIX A - UNIT PRICED CONTRACT QUOTE FORM	
APPENDIX B – CITY OF CAMAS GENERAL ENCROACHMENT PERMIT	

**CITY OF CAMAS PUBLIC WORKS DEPARTMENT
CITY PROJECT NO. UPC2201
STREET LIGHT POLE REPLACEMENT,
MAINTENANCE AND REPAIR**

CALL FOR BIDS

Sealed bids will be received by the City of Camas, Administrative Services, 616 NE 4th Avenue, Camas, Washington, until 2:00 p.m. on June 10, 2022, and will then and there be publicly read. Eligible Contractors shall be listed with MSRC Rosters on the Small Works Roster as of May 23, 2022, under Electrical and Communications, Lighting-Street. Bid Specifications will be emailed to eligible Contractors.

All Bid Proposals shall be accompanied by a Bid Proposal deposit in cash, certified check, cashier's check, or surety bond in an amount equal to \$17,500. This figure is based on five percent of the Contract Total amount of \$350,000, which is the not-to-exceed amount for the life of the Contract. Should the successful Bidder fail to enter into such contract and furnish satisfactory contract bond within the time stated in the most current updated version of the Washington State Department of Transportation (WSDOT) Standard Specifications for Road, Bridge, and Municipal Construction (standard specifications), the Bid Proposal deposit shall be forfeited to the City of Camas.

The improvement for which bids will be received follows:

Statement of Work:

Repairs include, but are not limited to street light pole replacements, light adjustments, power diagnosis and repair, fuse replacements, photocell replacements and related work.

**For questions, please contact Will Noonan, Public Works Operations Manager,
via email at wnoonan@cityofcamas.us at the City of Camas.**

The Contractor is obligated to pay Washington State Department of Labor and Industries Prevailing Wages, Rates for Clark County, effective June 10, 2022.

American Made:

In an effort to maximize the creation of American jobs and restoring economic growth, the City of Camas encourages the use of products and services that are made in the United States of America whenever and wherever possible.

Disadvantaged Businesses:

The City of Camas encourages the solicitation and recruitment, to the extent possible, of certified minority-owned (MBE), women-owned (WBE), emerging small (ESB) businesses, and other disadvantaged companies in the construction of this project.

Civil Rights Act:

The City of Camas is an Equal Employment Opportunity employer.

The City of Camas, in accordance with the provisions of Title VI of the Civil Rights Act of 1964 (78 Stat. 252, 42 U.S.C. §§ 2000d to 2000d-4) and the Regulations, hereby notifies all bidders that it will affirmatively ensure that any contract entered into pursuant to this advertisement, all contractors will be afforded full and fair opportunity to submit bids in response to this invitation and will not be discriminated against on the grounds

of the owner's race, color, national origin, sex, age, disability, income-level, or Limited English Proficiency in consideration for an award.

The Contractor will comply with all federal, state and local laws prohibiting discrimination on the basis of age, sex, sexual orientation, marital status, race, creed, color, national origin, disability, or familial status. These requirements are specified in Section 109 of the Housing and Community Development Act of 1974 (42 USC Section 5309); Civil Rights Act of 1964, Title VII (42 USC Section 2000e); Civil Rights Act of 1968, Title VIII (Fair Housing Act) (42 USC Sections 3601 - 3639); Executive Order 11063 (Equal Opportunity in Housing); Executive Order 11246, as amended (Equal Employment Opportunity); Architectural Barriers Act of 1968 (42 USC 4151, et seq.); Americans with Disabilities Act (42 U.S.C. 12101, et seq.); and Section 3 of the Housing and Urban Development Act of 1968, and 24 CFR 570.601.

The Contractor will not discriminate against any resident of the project service area by denying benefit from or participation in any block grant funded activity on the basis of race, color, sex, sexual orientation, national origin, disability, age, marital status and familial status. (Civil Rights Act of 1964, Title VI; Civil Rights Act of 1968, Title VII; Architectural Barriers Act of 1968; Americans with Disabilities Act; Section 109, Housing and Community Development Act of 1974; Section 504, Rehabilitation Act of 1973 as amended).

E-Verify Requirements:

Per City of Camas Ordinance No. 2626, as a condition for the award or renewal of any contract after January 1, 2012, the Contractor shall enroll in the E-Verify program through the United States Department of Homeland Security and thereafter shall provide the City with a copy of the Memorandum of Understanding (issued by Homeland Security), submitted with their bid proposal, affirming their enrollment and participation in the program. The Contractor shall be required to continue their participation in the program throughout the course of their contract with the City. Prime contractors shall require and verify that each of their subcontractors and lower tiered subcontractors are also enrolled and participants in the E-Verify program. This is intended to be used exclusively for employees hired after award and for the duration of the contract with the City of Camas. Please go to the Engineering page of the City of Camas web site at www.cityofcamas.us for additional information and to view Ordinance No. 2626.

E-Verify, is an Internet based system operated by the Department of Homeland Security in partnership with the Social Security Administration at no charge. E-Verify has been determined to be a suitable means for determining employment eligibility of new hires and the validity of their Social Security numbers. Please visit the Department of Homeland Security's web site at <http://www.dhs.gov/index.shtm> and select E-Verify to learn more or to enroll in this program.

This document and all associated public records will be released where required by the Public Records Act, Chapter 42.56 RCW (the "Act"). To the extent that public records then in the custody of the Contractor are needed for the City to respond to a request under the Act, as determined by the City, the Contractor agrees to make them promptly available to the City. If the Contractor considers any portion of any record provided to the City under this Agreement, whether in electronic or hard copy form, to be protected from disclosure under law, the Contractor shall clearly identify any specific information that it claims to be confidential or proprietary. If the City receives a request under the Act to inspect or copy the information so identified by the Contractor and the City determines that release of the information is required by the Act or otherwise appropriate, the City's sole obligation shall be to notify the Contractor (a) of the request and (b) of the date that such information will be released to the requester unless the Contractor obtains a court order to enjoin that disclosure pursuant to RCW 42.56.540. If the Contractor fails to timely obtain a court order enjoining disclosure, the City will release the requested information on the date specified.

The City of Camas expressly reserves the right to reject any or all Proposals and to waive minor irregularities or informalities and to Award the Project to the lowest responsive, responsible bidder as it best serves the interests of the City.

DocuSigned by:
Bernie Bacon
4F14EBF72D0F4FF...
Bernie Bacon
City Clerk

PART ONE

BIDDING DOCUMENTS

BIDDER'S INFORMATION PAGE

CITY PROJECT NO. UPC2201

**STREET LIGHT POLE REPLACEMENT, MAINTENANCE
AND REPAIR**

Proposal Submitted By:

City Electric Co of wa

CONTRACTOR

Andrew Muonio, President

NAME OF AUTHORIZED COMPANY REPRESENTATIVE (Type or Print)

PO Box 930

andym@cityelectricnw.com

CONTRACTOR MAILING ADDRESS

EMAIL ADDRESS

La Center

WA

98629

360-901-1473

CITY

STATE

ZIP CODE

PHONE NO.

CITYEEC838C8

02/28/2023

WASHINGTON STATE CONTRACTORS LICENSE #

EXPIRATION

BID OPENING: June 10, 2022, at 2:00 p.m.

City of Camas City Hall
616 NE 4th Avenue
Camas, Washington 98607

Contacts: **City of Camas**
Will Noonan
Phone: 360-817-1563
E-mail: wnoonan@cityofcamas.us

PROPOSAL

To the Office of the City Clerk
Camas, Washington

The undersigned hereby certifies that they have examined the location of:

**PROJECT NO. UPC2201
STREET LIGHT POLE REPLACEMENT, MAINTENANCE AND REPAIR
(UNIT PRICED PUBLIC WORKS CONTRACT)**

and that the Plans, Specifications and contract governing the work embraced in this improvement, and the method by which payment will be made for said work is understood. The undersigned hereby proposes to undertake and complete the work embraced in this improvement, or as much thereof as can be completed with the money available in accordance with the said Plans, Specifications and contract, and the following schedule of rates and prices:

(Note: Unit prices for all items, all extensions, and total amount of bid should be shown. All entries must be typed or entered in ink.)

SCHEDULE A: LABOR

Item No.	Qty.	Unit	Description	Unit Price	Total
1	20	LIGHTS	Bulb Replacement – Acorn	\$ 250.00	\$ 5000.00
2	10	LIGHTS	Bulb Replacement – Cobra Head	\$ 250.00	\$ 2500.00
3	20	LIGHTS	Street Light Repair	\$ 250.00	\$ 5000.00
4	8	LIGHTS	Street Light Replacement – Acorn	\$ 2000.00	\$ 16,000.00
5	2	LIGHTS	Street Light Replacement – Cobra Head	\$ 2500.00	\$ 5000.00
6	20	HRS	Traffic Control	\$ 85.00	\$ 1700.00
7	10	HRS	Overtime	\$ 125.00	\$ 1250.00
8	1	LS	Minor Changes (minimum bid \$7,500)	\$ 7500.00	\$ 7500.00
Schedule A Labor Subtotal					\$ 43950.00
9	1	PERCENT	Markup Percentage (maximum 29%) Schedule A Subtotal X Markup %	%	\$ 12,745.50
Schedule A Labor Total					\$ 56,695.50

SCHEDULE B: MATERIALS

Item No.	Qty.	Unit	Description	Unit Price	Total
10	1	LS	Materials (Necessary to Complete Scope of Work, to include: incidental materials, fuses, minor wiring, photocells, etc.)		\$42,000.00
11	1	CALC	Markup Percentage (maximum 21%) Schedule B Subtotal X Markup %	%	\$ 8820.00
Schedule B Materials Total					\$ 50,820.00

SCHEDULE C: EQUIPMENT

Item No.	Qty.	Unit	Description	Unit Price	Total
12	1	LS	Equipment (Necessary to Complete Scope of Work)		\$2,500.00
13	1	CALC	Markup Percentage (maximum 21%) Schedule C Subtotal X Markup %	%	\$ 525.00
Schedule C Equipment Total					\$ 3025.00

Subtotal Schedules A (Non-Taxable)	\$ 56,695.50
Subtotal Schedules B+C (Taxable)	\$ 53,845.00
Schedules B+C Washington State Sales Tax (8.4%)	\$ 4522.98
TOTAL (Basis of Award)	\$ 115,063.48

Digitally signed by Andrew Muonio
 DN: C=US,
 E=andym@cityelectricnw.com, O=City
 Electric Co, CN=Andrew Muonio
 Date: 2022.07.26 07:35:22-07'00'

Andrew Muonio

Signature of Owner or Authorized Corporate Officer
(This is required for a valid bid)

**LISTED QUANTITIES SHALL NOT BE CONSIDERED FIRM ESTIMATES
 OF REQUIREMENTS FOR THE YEAR.
QUANTITIES ARE BASED ON ANTICIPATED ANNUAL NEEDS.**

By signing the Bid Proposal, the bidder hereby declares, under penalty of perjury under the laws of the United States that the Non-Collusion Declaration and Notice to All Bidders statements, as provided in these Bid Specifications and Contract Documents, are true and correct.

The City of Camas expressly reserves the right to reject any or all Proposals and to waive minor irregularities or informalities and to Award the Project to the lowest responsible bidder as it best serves the interests of the City. The City of Camas also reserves the right to delete any or all portions of individual bid items.

BIDDER'S CHECK LIST

The bidder's attention is especially called to the following forms, which must be executed in full as required and submitted at the bid opening:

- A. **PROPOSAL**
Unit prices for all items, all extensions, and total amount of bid must be shown, except those items designated in the estimate of quantities to be paid for as lump sum. Any item shown on the Plans that does not have a bid item shall be considered incidental to the project and the costs thereof shall be included in other bid items of the project. Pay special attention to the Non-Collusion Declaration before signing the proposal. An unsigned bid may be considered a non-responsive bid.

- B. **BID BOND**
Proposals must be accompanied by cash, a certified check, a cashier's check drawn on a bank of good standing, or a bid bond issued by a surety company authorized to issue such bonds in the State of Washington, in an amount of not less than five percent (5%) of the total amount of the bid submitted. The full amount will be returned within five (5) days after the contract has been executed.

- C. **DID YOU COMPLETE AND SUBMIT THE BIDDER'S INFORMATION PAGE?**

- D. **DID YOU SIGN AND SUBMIT YOUR BID PROPOSAL?**

- E. **DID YOU COMPLETE AND SUBMIT THE MANDATORY BIDDER RESPONSIBILITY CRITERIA INFORMATION FORM?**

- F. **DID YOU COMPLETE AND SUBMIT THE BID BOND ACKNOWLEDGEMENT FORM?**

- G. **IF APPLICABLE, DID YOU ACKNOWLEDGE RECEIPT OF ADDENDUMS?**

- H. **DID YOU COMPLETE AND SUBMIT THE ACKNOWLEDGEMENT OF CONTRACTOR LAWFUL HIRING COMPLIANCE ENROLLMENT FORM (E-VERIFY)?**

- I. **DID YOU SUBMIT A FULL AND COMPLETED COPY OF THE MEMBORANDUM OF UNDERSTANDING (MOU) ISSUED BY HOMELAND SECURITY IN ITS ENTIRETY WITH YOUR BID?**

- J. **DID YOU READ THE 'NON-COLLUSION DECLARATION' AND 'NOTICE TO ALL BIDDERS' STATEMENTS?**

The following forms are to be executed and submitted to the contracting agency by the successful bidder after the contract is awarded:

- A. CONTRACT**
This agreement is to be executed by the successful bidder.
- B. CONTRACT BOND**
This form is to be executed by the successful bidder and his surety company.
- C. DECLARATION OF OPTION FOR INVESTMENT OF RETAINED PERCENTAGE**
This agreement is to be executed by the successful bidder.
- D. WAGE LAW INTENT AND AFFIDAVIT**
This shall be completed in accordance with State Law.
- E. PUBLIC LIABILITY AND PROPERTY DAMAGE INSURANCE**
This is to be executed by the successful bidder.
- F. SUBMITTAL OF WEEKLY CERTIFIED PAYROLL REPORTS FOR ALL WORKERS ON THE PROJECT**
Failure to submit correct and timely certified payrolls will delay payment.
- G. AFFIDAVIT OF E-VERIFY COMPLIANCE**
To be completed prior to final payment

ACKNOWLEDGEMENT OF CONTRACTOR LAWFUL HIRING COMPLIANCE ENROLLMENT

**Re: City of Camas Public Work Contractor Lawful Hiring Compliance
(Also referred to as E-Verify)**

Per City of Camas Ordinance No. 2626, as a condition for the award or renewal of any contract after January 1, 2012, the Contractor shall enroll in the E-Verify program through the United States Department of Homeland Security and thereafter shall provide the City with a copy of the Memorandum of Understanding in its entirety (issued by Homeland Security), submitted with their bid proposal, affirming their enrollment and participation in the program. The Contractor shall be required to continue their participation in the program throughout the course of their contract with the City. Prime contractors shall require and verify that each of their subcontractors and lower tiered subcontractors are also enrolled and participants in the E-Verify program. This is intended to be used exclusively for employees hired after award and for the duration of the contract with the City of Camas.

BIDDERS MUST SUBMIT A COPY OF THEIR MEMO OF UNDERSTANDING IN ITS ENTIRETY FROM THE UNITED STATES DEPARTMENT OF HOMELAND SECURITY PROVING THAT THEIR COMPANY IS ENROLLED IN THE E-VERIFY PROGRAM. THIS IS REQUIRED AS A CONDITION OF CONSIDERATION OF YOUR BID.

Your signature below indicates acceptance of these terms:

Andrew Muonio  Digitally signed by Andrew Muonio
DN: cn=US,
E=andym@cityelectricnw.com, O=City
Electric Co, CN=Andrew Muonio
Date: 2022.07.26 07:35:40-07'00

7-26-2022

Signature of Owner or Authorized Corporate Officer

Date

Andrew Muonio, President

Company Owner/Officer's name printed

City Electric Co of wa

Company

NON-COLLUSION DECLARATION

I, by signing the Proposal, hereby declare, under penalty of perjury under the laws of the United States that the following statements are true and correct:

1. That the undersigned person(s), firm, association or corporation has (have) not, either directly or indirectly, entered into any agreement, participated in any collusion, or otherwise taken any action in restraint of free competitive bidding in connection with the project for which this proposal is submitted.
2. **That by signing the signature page of this proposal, I am deemed to have signed and have agreed to the provisions of this declaration.**

NOTICE TO ALL BIDDERS

To report bid rigging activities call:

1-800-424-9071

The U.S. Department of Transportation (USDOT) operates the above toll-free "hotline" Monday through Friday, 8:00 a.m. to 5:00 p.m., Eastern Time. Anyone with knowledge of possible bid rigging, bidder collusion, or other fraudulent activities should use the "hotline" to report such activities.

The "hotline" is part of USDOT's continuing effort to identify and investigate highway construction contract fraud and abuse and is operated under the direction of the USDOT Inspector General. All information will be treated confidentially and caller anonymity will be respected.

DOT 272-0361 EF

**BID BOND
ACKNOWLEDGEMENT**

The bidder is hereby advised that by signature of this proposal they are deemed to have acknowledged all requirements and signed all certificates contained herein.

A proposal guaranty in an amount of five percent (5%) of the total bid, based upon the approximate estimate of quantities at the above prices and in the form as indicated below, is attached hereto:

_____ CASH	IN THE AMOUNT OF \$17,500 (based on Contract Total)
_____ CASHIER'S CHECK	Seventeen Thousand Five Hundred DOLLARS
_____ CERTIFIED CHECK	PAYABLE TO THE CITY TREASURER
_____ PROPOSAL BOND	OF CAMAS, WASHINGTON, IN
	THE AMOUNT OF 5% OF THE BID (anticipated Contract Total).

Receipt is hereby acknowledged of Addendum(s) No. (s) _____, _____ & _____.

SIGNATURE OF OWNER OR AUTHORIZED CORPORATE OFFICER

FIRM NAME _____

ADDRESS _____

Notes:

- 1) This proposal form is not transferable and any alteration of the firm's name entered hereon without prior permission from the City Engineer will be cause for considering the proposal irregular and subsequent rejection of the bid.
- 2) Please refer to Section 1-02.6 of the standard Specifications, re: "Preparation of Proposal", or "Article 4" of the Instructions to Bidders for building construction jobs.
- 3) Should it be necessary to modify this proposal either in writing or by electronic means, please make reference to the following proposal number in your communication: **Street Light Pole Replacement, Maintenance and Repair, City of Camas Project No. UPC2201.**

PART TWO

GENERAL INFORMATION

I. GENERAL INFORMATION

1. **Purpose**

It is the intent and purpose of these specifications to describe the Unit Priced Public Works Contract for Street Light Pole Replacement, Maintenance and Repair in sufficient detail to secure bids on comparable units, equipment parts and material. All parts, which are necessary in order to provide a complete unit, ready for operation, shall be included in the bid and shall conform in strength, quality of workmanship and material to that which is usually provided the trade in general. Any variance from the specifications or standards of quality must be clearly pointed out in writing by the Bidder.

This Unit-Price Contract is not to be used with Federal funds and shall be used for replacement, maintenance and repair work only. It shall not be used to complete a major project, or a budgeted Capital project.

2. **No Obligation to Contract**

This Bid does not obligate the City to contract for service(s), or product(s) specified herein. City reserves the right to cancel or reissue this Bid in whole or in part, for any reason prior to the issuance of a Notice of Award. The City does not guarantee to purchase any specific quantity or dollar amount. Bids that stipulate that the City shall guarantee a specific quantity or dollar amount will be disqualified (e.g., "all-or-none").

3. **New and Used**

All units, equipment, parts and material shall be new, unused, manufacturer's current model year and in current production. All materials shall have physical and chemical properties to withstand the intended purpose. Equipment design shall have sufficient excess capacity for durability and safety.

4. **Best Management Practices**

All work shall be performed and completed in accordance with the best modern practices, further, no detail necessary for safe and regular operation shall be omitted, although specific mention thereof may not be made in these specifications.

5. **Equal/Approved Equal**

These specifications are intended to be precise where a specific make, model or trade name is requested. Whenever a make, model or trade name is used, it shall be that or equal, or approved equal. Equal or approved equal means that the make, model or trade name will be given consideration if they fulfill the same performance requirements. The City reserves the right to make the decision on acceptability. Each bidder shall clearly identify make, model or trade name of equipment bid on the bid form. Any equipment proposed as an equal to that herein specified must be substantiated with supporting data to justify such request for substitution.

6. **Exceptions**

Specifications of the services and/or work bid shall be equal to or better than the specifications stated herein and all exceptions to these specifications shall be so listed on a separate sheet headed "EXCEPTIONS TO THE SPECIFICATIONS". Any Bid submitted without exceptions will be required to meet every detail of these specifications regardless of cost to the successful bidder.

Where "NO EXCEPTIONS" are shown, none will be allowed. No exceptions will be considered that may tend to devalue the equipment or give an individual bidder who is offering a lesser item a distinct advantage.

7. More or Less

Quantities are estimated only and shall be bid on a MORE OR LESS basis. For the purpose of comparison, bids shall be made in the quantities listed in this specification. Listed quantities shall not be considered firm estimates of requirements for the year, nor shall the City be bound or limited to quantities listed. Payment will be made only for quantities actually ordered, delivered, and accepted, whether greater or less than the stated amounts.

8. Contract Term

The period of this contract shall be for a period of three (3) years from its effective date. Contract may be extended on the anniversary date for one (1) additional one (1) year period. Contract is not to exceed a total of four (4) years or \$350,000, whichever comes first.

9. Pricing and Discount

The City qualifies for governmental discounts. Unit prices shall reflect these discounts.

Prices of materials, equipment and services set forth herein do not exceed those charged by the Contractor to any other customer purchasing the same goods or services under similar conditions and in like or similar quantities.

10. Price Clarifications

The City reserves the right to clarify any pricing discrepancies related to assumptions on the part of Bidders. Such clarifications will be solely to provide consistent assumptions from which an accurate cost comparison can be achieved.

Unit prices shown on the Bid or contract shall be the price per unit of sale (e.g., gal., cs., doz., ea.) as stated on the bid form. For any given item, the quantity multiplied by the unit price shall establish the extended price, the unit price shall govern in the Bid evaluation and contract administration.

11. Price Increases

Any increase proposed shall be submitted to the Public Works Operations Manager, thirty (30) calendar days before the proposed effective date of the price increase, and shall be limited to fully documented cost increases to the Contractor which are demonstrated to be industry-wide. The conditions under which price increases may be granted shall be expressed in Bid documents and contracts or agreements.

Pricing shall be prepared with the following terms. The Public Works Operations Manager may exempt these requirements for extraordinary conditions that could not have been known by either party at the time of bid or other circumstances beyond the control of both parties, as determined in the opinion of the Public Works Operations Manager. Prices shall remain firm for the first twelve-month period of the contract.

Requests for Rate Increases must be delivered to the Public Works Operations Manager, in accordance with the rules below. No other employee may accept a rate increase request on behalf of the City. Any invoice that is sent to the City with pricing above that specified by the City in writing within this Contract or specified within an official written change issued by Purchasing to this contract, shall be invalid. Payment of an erroneous invoice does not constitute acceptance of the erroneous pricing, and the City

would seek reimbursement of the overpayment or would withhold such overpayment from future invoices.

In order to protect the interest of the City and to give the contractor a reasonable basis for quoting, a price adjustment feature is hereby incorporated into the specifications and contract documents and shall be binding on the contractor and the City.

In submitting a bid, Contractor shall set forth the amount they will accept for the first year (12-months) in payment for services and materials on the Proposal Form in accordance with the contract.

If contractor requests the City to do so, payment under this contract may be adjusted each succeeding year effective on the contract anniversary date.

Materials: If requested by the Contractor in writing thirty (30) days prior to the anniversary date of each year of the contract, the City will consider increasing the Contractor's rates per the Portland Area Consumer Price Index for Urban Wage Earners and Clerical Workers (CPI-U) for the previous twelve months. The City, in its sole discretion, will decide whether to approve or deny the rate increase request or any part thereof within 30 days of receipt of the request. If approved, increase shall take effect 30 days after approval. The yearly increase shall not exceed 3.5%. All such requests shall be submitted in writing to the Public Works Operations Manager.

12. Expansion Clause

Any resultant contract may be further expanded by the Public Works Director in writing to include any other item normally offered by the bidder, as long as the price of such additional products is based on the same cost/profit formula as the listed item(s). At any time during the term of this contract, other City departments may be added, if both parties agree.

13. Warranty

Unless otherwise specifically stated by the Bidder, all goods and services furnished shall be warranted against defects or faulty workmanship and materials by the Contractor for one (1) year following inspection and acceptance of the products by the City. Warranty shall include all costs incurred, including shipping, for repair or replacement except that which is damaged by misuse or abuse. This one (1) year warranty shall in no way affect normal extended or manufacturer's warranty exceeding this one (1) year period. Contractor warrants that all goods and services furnished under this Agreement are new, conform strictly to the specifications herein, are merchantable, good workmanship, free from defect, comply with all applicable safety and health standards established for such products, all goods are properly packaged, and all appropriate instructions or warnings are supplied. If a defect is found, a component failure occurs, or workmanship is found to cause failure, the Vendor shall replace the product at their own expense, including shipping charges. Any replacement product will be warrantied for one (1) year from the date it is delivered and/or installed. All implied and expressed warranty provisions of the Uniform Commercial Code are incorporated into this Agreement. Contractor further warrants that no violation of any federal, state or local law, statute, rule, regulation, ordinance or order will result from the manufacturer, production, sale, shipment, installation or use of any other goods. Contractor's warranties (and any more favorable warranties, service policies, or similar undertaking of Contractor) shall survive delivery, installation, inspection, and acceptance of the goods or services.

14. Regulations and Codes

To the extent applicable, all equipment, supplies, materials, and all projects shall be performed in a manner that is in compliance with all applicable Federal, State and Local Laws and Regulations, including, but not limited to, Washington State vehicle regulations (WSDOT/HMTUSA/other), environmental laws

and regulations (EPA/WDOE/local), and health and safety laws and regulations (OSHA/WISHA/City Safety Codes).

15. Payments

Upon final inspection and acceptance of the work by the City, Contractor is to submit properly completed itemized invoice(s), the prices stipulated herein for work performed (less deductions, if any), in accordance with all payment and retainage instructions herein to:

City of Camas, Public Works Operations Manager, 616 NE 4th Avenue, Camas, WA 98607 or via email to wnoonan@cityofcamas.us

To ensure prompt payment each itemized invoice should not only include the Contractor's name and return remittance address but also cite project title and number, purchase order number, bid item and Service(s) description, quantity, unit and total price, retainage (if applicable), and location of work and date work was completed.

No Progress payments will be made.

16. Acceptance of Terms

Acceptance of a City Purchase Order (PO) for any units and/or projects affiliated with this purchase constitutes acceptance of, and agreement with, all of the general and specific requirements and stipulations listed in this boiler plate, and in the attached specification(s); including all penalties mentioned.

17. Sales Tax

The City of Camas Tax rate is currently 8.4%. However, the amount of sales tax will not be considered in determining which bid is the lowest and best bid.

18. Clarifications and/or Revisions to Specification and Requirements

If a Bidder discovers any significant ambiguity, error, conflict, discrepancy, omission, or other deficiency in this solicitation, the Bidder has a duty to immediately notify the Public Works Operations Manager of such concern and request modification or clarification of the Bid document.

Unless instructions are specifically provided elsewhere in this document, any questions, exceptions, or additions concerning the subject matter of the Bid document(s) shall not be considered unless submitted via e-mail (no phone calls) to the Public Works Operations Manager, a minimum of five (5) business days prior to the submittal due date.

In the event that it becomes necessary to provide additional clarifying data or information, or to revise any part of this Bid, supplements or revisions will be provided to all known Bidders in the form of an Addendum.

If any requirements of the Bid are unacceptable to any prospective Bidder, they may choose not to submit a Bid.

19. Incurring Costs

The City is not liable for any cost incurred by a Bidder in the process of responding to this Bid, including but not limited to the cost of preparing and submitting a response, in the conduct of a presentation, in facilitating site visits or any other activities related to responding to this Bid.

20. Retention of Rights

The City retains the right to accept or reject any or all Bids or accept any presented which meet or exceeds these specifications, and which would be in the best interest of the City and will not necessarily be bound to accept the low bid.

All Bids become the property of City upon receipt. All rights, title and interest in all materials and ideas prepared by the Bidder for the Bid to City shall be the exclusive property of City and may be used by the City at its option.

21. Points Not Addressed

Bidders are encouraged to list any points not addressed in these specifications that they feel improve or enhance the operation of their units.

22. Materials Bought from Different Supplier

Should the Contractor be unable to or refuse to supply materials, on any given day, against this predetermined delivery schedule to which the supplier has agreed and the City is forced to do the work with materials bought from a different supplier, the difference in the Bid price of the materials and that paid the new supplier, in order to do the work, shall be charged to and paid for by the Contractor holding the Bid award for these products on the condition that such delay is at no fault of Contractor in any respect, including the following:

- Unavoidable mechanical breakdowns
- Strikes
- Inability to secure component materials
- Acts of God
- Fire

Provided the Public Works Operations Manager is notified in writing by the Contractor of such pending or actual delay. In the event of any delay, the date of delivery shall be extended for a period equal to the time lost due to the reason for the delay.

23. Re-Award

When the contract is terminated by the City or the Contractor upon providing the written notice as herein required, the City, may re-award the contract to the next most responsible bidder within 120 days from original award.

24. Errors and Omissions

The City reserves the right to correct obvious ambiguities and errors in the Bidder's proposal and to waive non-material irregularities and/or omissions. In this regard, if the unit price does not compute to the extended total price, the unit price shall govern.

II. PREPARING AND SUBMITTING A BID

1. General Instructions

Failure to conform to the Bid specifications and respond to each of the submittal requirements may be the basis for rejection of a bid. Refer to Bidder's Checklist, to ensure your Bid is responsive.

2. Submitting a Bid

Bidders shall submit one original (so marked) Bid. Bids shall be submitted to the address listed on Page 3 of this solicitation no later than the date and time listed on Page 3 of this Bid. Late Bids will not be accepted, unless it can be proven the Bid was in the hands of a third-party package delivery company and should have been delivered on time, thus showing no advantage over other Bidders. All Bids shall list the information on the outside of the package as specified on Page 3 of this Bid.

If City Hall is closed for business at the time scheduled for opening, for whatever reasons, Bidder's response will be accepted and opened on the next business day of the City, at the originally scheduled hour.

Bids are not considered to be confidential per Washington State Public Records Act (RCW 42.56 et seq.). All sections of the response shall be made available to the public immediately after contract opening.

3. Public Works Project

This is a Prevailing Wage contract. The State of Washington prevailing wage rates applicable for this public works project, which is located in Clark County, may be found at the following website address of the Department of Labor and Industries: <https://lni.wa.gov/licensing-permits/public-works-projects/prevailing-wage-rates/>. Based on the bid submittal deadline for this project, the applicable effective (start) date for prevailing wages for this contract is June 10, 2022. A copy of the applicable prevailing wage rates are also available for viewing at the office of the City, located at 616 NE 4th Avenue, Camas, WA 98607

Intent to Pay Prevailing Wages, and Affidavit of Prevailing Wages paid will be required.

- An Intent to Pay Prevailing Wages is required to be filed on the anniversary date of each year.
- An Affidavit of Wages Paid is filed at the end of each contract year.
 - The prevailing rate of wage in effect on the date the anniversary date for that year must be used.

4. Bid Bond

A bid bond from a State-licensed surety company on a form acceptable to the City, or certified or cashier's check, equal to percent (5%) of the bid in the amount of \$17,500 (anticipated Contract Total) shall be included with the bid and shall be retained as liquidated damages should the successful vendor, after formal notification of award, fail to enter into a contract with the City to perform the Work. The certified or cashier's check will be deposited in a non-interest bearing checking account and will be returned to the unsuccessful bidders by a City of Camas. The successful vendor's check will be retained by the City until the Contract Bond is received and approved by the Public Works Operations Manager at which time he/she will be reimbursed by a City of Camas. The City will pay no interest on any check held in lieu of a bond under this requirement.

5. Prohibition of Bidder Terms & Conditions

A Bidder may not submit the Bidder's own contract terms and conditions in a response to this Call for Bids. If a Bid contains such terms and conditions, the City, at its sole discretion, may determine the Bid to be a nonresponsive counteroffer, and the Bid may be rejected.

6. Withdrawal of Bids

Bidders may withdraw or supplement their Bid at any time up to the bid closing date and time. If a previously submitted bid is withdrawn before the bid due date and time, the Bidder may submit another

Bid at any time up to the bid closing date and time. After bid closing date and time, all submitted Bids shall be irrevocable until contract award.

III. EVALUATION AND CONTRACT AWARD

1. Bid Evaluation

The evaluation and selection of a Bidder will be based on the information submitted in the Bid. Award will be made to the lowest responsive, responsible bidder as it best serves the interests of the City.

2. Offer in Effect for Ninety (90) Days

A Bid may not be modified, withdrawn or canceled by the Bidder for a ninety (90) day period following the deadline for Bid due date, or receipt of best and final offer, if required, and Bidder so agrees by submittal of a bid.

The City of Camas expressly reserves the right to reject any or all Proposals and to waive minor irregularities or informalities and to Award the Project to the lowest responsible bidder as it best serves the interests of the City. The City of Camas also reserves the right to delete any or all portions of individual bid items.

IV. SCOPE OF WORK AND TECHNICAL REQUIREMENTS

It is the intent of these specifications to describe Street Light Pole Replacement, Maintenance and Repair Unit-Price Public Works Contract in sufficient detail to secure bids on comparable work. Any variance from the specifications or standards of quality must be clearly pointed out in writing by the bidder.

1. Scope of Work

The work under this Contract shall include the furnishing of all labor, materials, equipment, permits, and inspections necessary for or incidental to Street Light Pole Replacement, Maintenance and Repair as indicated in these specifications and the completion of all work indicated in the Contract Documents.

Repairs include, but are not limited to street light pole replacements, light adjustments, power diagnosis and repair, fuse replacements, photocell replacements and related work as determined by the City. "Related Work" to include, but not be limited to, the following:

Mobilization	Restoration
Parts/Materials	Vehicles/Equipment
Labor	Concrete Work

Backfill trenches within sidewalk area and around bases of replaced or straightened light standards with compacted 5/8" minus gravel. Backfill other trenches and areas behind curb with native material. Compact the trench and restore to pre-existing condition. Note: All driveways must be pushed or bored. Concrete footing must be replaced if structural integrity has been compromised.

Restoration of lawns, landscape and shrubs to the satisfaction of the customer. Contractor to exercise reasonable care to minimize damage to lawns, landscape and shrubs.

It shall not be the responsibility of the City to provide engineering or other services to protect the Contractor from additional costs accrued from performing this Contract.

2. Mandatory Bidder Responsibility Criteria

Per RCW 39.04.350, before award of a public works contract, a bidder must meet the defined mandatory bidder responsibility criteria to be considered a responsible bidder and qualified to be awarded a public works project. It is the intent of the City to award a Contract to the lowest responsive, responsible Bidder. The Bidder must submit with their bid response the Mandatory Bidder Responsibility Criteria Form on page 11, demonstrating compliance with the criteria.

3. Workmanship

Where not more specifically described in these specifications, workmanship shall conform to all of the methods and operations of best standards and accepted practices of the trade or trades involved. All work shall be executed by personnel skilled in their respective lines of work. All materials provided for individual projects will be per the current edition of the National Electrical Code. Construction will be performed per the current edition of the National Electrical Code and City standards. Only the best and safest methods of operation will be allowed. Any variance from the specifications or standards of quality must be clearly pointed out in writing by the bidder.

4. Regulatory Requirements and Codes

To the extent applicable, all equipment, supplies, materials, and all projects shall be performed in a manner that is in compliance with all applicable Federal, State and Local Laws and Regulations, including, but not limited to, Washington State vehicle regulations (WSDOT/HMTUSA/other), environmental laws and regulations (EPA/WDOE/local), health and safety laws and regulations (OSHA/WISHA/City Safety Codes), and the most recent edition of the ANSI/TIA/EIA and NEC Standards.

5. Licenses and Permits

Bidders must have a valid Washington State Electrical License **at the time of opening of the bids** and throughout the life of the resulting contract.

The Contractor must procure all required permits and licenses required for all phases of this project, including but not limited to building permits, electrical permits, etc.

City of Camas General Encroachment Permit. Per CMC 12.12.010, a general encroachment permit is required for construction or maintenance activity within the public right-of-way (ROW). The Site Development Encroachment Permit is applicable to this project. There is no fee for this type of permit. Please review Part Eight, Appendix B, which provides application instructions, insurance requirements and copies of the forms.

6. Additional Work

Any additional work found necessary that is not specified in this Bid specification shall be listed on a separate sheet entitled "Additional Materials/Labor Required".

7. Work Start and Completion

The work is on an on-call basis with the start and completion dates to be determined by the City of Camas Project Manager at the time work is requested. Scheduled electrical services shall be performed during a regular eight (8) hour business day between the hours of 7:00 AM and 4:00 PM, Monday through Friday. Contractor agrees to mobilize and be available to perform scheduled work within a maximum of two (2) days of each request. There may be occasions when job completion runs beyond normal working hours or when a Contractor is called in for an after-hour's emergency. Contractor agrees to mobilize and be available to perform Emergency work within sixty (60) minutes of call out.

8. Project Quote

Contractor is to provide the Project Manager a quote for each project/call-out using the City of Camas Unit Priced Contract Quote Form (Appendix A).

9. Manufacturer's Instructions

All materials and equipment shall be applied, installed, connected, erected, used, cleaned, and conditioned in accordance with the instructions of the applicable manufacturer, fabricator, supplier, or distributor, except as otherwise specifically provided in the contract documents.

10. No Disturbance

The contractor shall not disturb grounds or materials outside the sphere of the contracted project.

11. Mobilization and Demobilization

Mobilization shall be included in the base unit price for each purchase order and shall consist of preparatory work and operations performed by Contractor, including his personnel, equipment, supplies and incidentals to the project site. No separate measurement or payment will be made for costs associated with mobilization and demobilization.

12. Repair or Replacement

The work shall consist of repair of any incidental damages to walls, moldings, electrical, flooring, landscaping, sidewalk, fencing, paved areas, topsoil, turf, or other miscellaneous items within or adjacent to the project area. This includes complete replacement of items that are beyond repair as determined by the City.

Should adjacent property be damaged in any manner, Contractor shall immediately contact the Project Manager. Contractor shall promptly repair damages caused to adjacent areas, rooms, facilities, property, streets, and sidewalks by construction operations as directed by the City and at no cost to the City.

13. Protection of Existing Utilities

Identification and location of all underground utilities are the responsibility of the Contractor. The Contractor shall:

- a. Notify the Project Manager in writing, on each occasion, of the intent to work near underground utility services or structures. Submit proposed work "procedure for approval" to assure safe and continuous operation of the services.
- b. Proceed with sufficient caution to preclude damaging any utilities known or unknown. In the event unidentified utilities are encountered, the Contractor must notify the Project Manager IMMEDIATELY.
- c. In the event utilities are damaged during construction, temporary services and/or repairs must be made immediately, at the Contractor's expense, to maintain continuity of services.

14. Contractor's Responsibility for Fire Prevention and Protection

The Contractor shall take the following precautions:

- a. The contractor shall perform all work in a fire safe manner.

- b. Contractor shall supply and maintain on the site adequate fire-fighting equipment capable of extinguishing incipient fires.
- c. Contractor shall comply with applicable Federal, local, and State fire prevention regulations. Where these regulations do not apply, applicable parts of the National Fire Prevention Standard for Safeguarding building Construction Operations (NFPA No. 241) shall be followed.
- d. Contractor shall provide passageways around the areas of construction to ensure safe passage of persons in the area.
- e. No part of the buildings may be left in an unsafe condition. If any danger is imminent, the contractor shall rope off or place barricades around the area and notify the appropriate authorities.

15. Waste Materials

All refuse and waste material must be disposed of by the Contractor off the City's property, at the Contractor's expense. The Contractor must immediately clean up any spilled material from buildings, roads, etc.

16. Public Convenience and Safety

The Contractor must so conduct operations as to offer the least possible obstruction and inconvenience to the public, and shall have under construction no greater length or amount of work than can be performed with due regard to the rights of the public.

The Contractor must provide and maintain such fences, barriers, directional signs, lights, and flag persons as are necessary to give adequate warning to the public at all times of any dangerous conditions to be encountered as a result of the work and to give directions to the public.

Sound Control - If possible, limit sound during working hours.

17. Dust/Debris Control

The Contractor must take whatever steps, procedures or means as are required to prevent abnormal dust and debris conditions being caused by the operation in connection with the work. Dust control must be incidental to this project and in accordance with Clean Air Laws.

All areas where personnel are, or will be present during the course of work, shall be thoroughly cleaned of debris and garbage daily. Specific areas are adjacent buildings, walkways and parking areas.

18. Contractor's Vehicles

Contractor and employee vehicles, and all other vehicles entering City's property to perform work, must use an access route approved by the City. All such vehicles must park in a designated parking area approved by the City.

19. Traffic

Contractor is to conduct demolition operations and the removal of debris in a way to ensure minimum interference with roads, streets, walkways, and other adjacent occupied or used facilities.

Contractor is not to close or obstruct streets, walks, or other occupied or used facilities without permission from authorities having jurisdiction. Provide alternate routes around closed or obstructed traffic ways, if required by governing regulations.

Barricades shall conform to the requirements of the MUTCD supplemented by the further requirements of the Standard Plans and the City of Camas Street Detail ST35.

The contractor shall maintain traffic in the project area to the satisfaction of the City. Unless otherwise specified within the Contract Documents, the Contractor must maintain pedestrian and vehicular traffic. The Contractor shall observe and obey all local and state laws, ordinances, regulations, and permits in relation to the obstruction of a street, keeping passageways open and protecting pedestrians.

The Contractor will be held responsible for any damages that the local public agency, City, their heirs or assigns may have to pay as consequence of the contractor's failure to protect the public from injury, and the same may be deducted from any payments that are due, or may become due, to the contractor under this contract.

20. Contract Bond

Contract Bond: The successful bidder shall furnish a duly-executed bond, equal to 100% of the total contract value including sales tax, upon a form approved by the City, signed by approved surety or sureties in the amount of \$350,000 (anticipated Contract Total), conditioned upon the faithful performance of the contract by the Contractor within the time prescribed thereon.

21. Insurance Requirements

- a. The Contractor shall deliver to the Contracting Agency a Certificate(s) of Insurance and endorsements for each policy of insurance meeting the requirements set forth herein when the Contractor delivers the signed Contract for the work. The certificate and endorsements must conform to the following requirements:
 - An ACORD certificate or a form determined by the Contracting Agency to be equivalent.
 - Any other amendatory endorsements to show the coverage required herein.
 - All insurance policies, with the exemption of Professional Liability and Workers Compensation, shall name the following entities as additionally insured(s):
 - ◇ Contracting Agency and its officer, elected officials, employees, agents, and volunteers.
 - ◇ The listed entity above shall be additional insured(s) for the full available limits of liability maintained by the Contractor, whether primary, excess, contingent or otherwise, irrespective of whether such limits maintained by the Contractor are greater than those required by this Contract, and irrespective of whether the Certificate of Insurance provided by the Contractor describes limits lower than those maintained by the Contractor.
 - The insurance shall provide the minimum coverages and limits set forth below. Providing coverage in these stated minimum limits shall not be construed to relieve the Contractor from liability in excess of such limits. All deductibles and self-insured retentions must be disclosed and are subject to approval by the Contracting Agency. The cost of any claim payments falling within the deductible shall be the responsibility of the Contractor.
- b. Commercial General Liability insurance shall be at least as broad as ISO occurrence form CG 00 01 and shall cover liability arising from premises, operations, independent contractors, products-completed operations, stop gap liability, personal injury and advertising injury, and liability assumed under an insured contract. The Commercial General Liability insurance shall be endorsed to provide a per project general aggregate limit using ISO form CG 25 03 05 09 or an endorsement providing at least as broad coverage. There shall be no exclusion for liability arising from explosion,

collapse or underground property damage. The Public Entity shall be named as an additional insured under the Contractor's Commercial General Liability insurance policy with respect to the work performed for the Public Entity using ISO Additional Insured endorsement CG 20 10 10 01 and Additional Insured-Completed Operations endorsement CG 20 37 10 01 or substitute endorsements providing at least as broad coverage.

Such policy must provide the following minimum limits:

- \$2,000,000 Each Occurrence
- \$2,000,000 General Aggregate
- \$2,000,000 Products & Completed Operations Aggregate
- \$1,000,000 Personal & Advertising Injury, each offence

Stop Gap / Employers' Liability

- \$1,000,000 Each Accident
- \$1,000,000 Disease - Policy Limit
- \$1,000,000 Disease - Each Employee

- c. Automobile Liability insurance covering all owned, non-owned, hired, and leased vehicles. Coverage shall be at least as broad as ISO form CA 00 01. For Construction and Services Contracts add: Pollution Liability coverage at least as broad as that provided under ISO Pollution Liability Broadened Coverage for Covered Autos Endorsement CA 99 48 shall be provided, and the Motor Carrier Act Endorsement (MCS 90) shall be attached.

\$1,000,000 Minimum combined single limit for bodily injury and property damage per incident

- d. Worker's Compensation insurance. The Contractor shall comply with Workers' Compensation coverage as required by the Industrial Insurance laws of the state of Washington.

22. Retainage

RCW 60.28.011 states that public improvement contracts shall provide, and public bodies shall reserve, contract retainage not to exceed five (5) percent of the monies earned by the Awarded Contractor as a trust fund for the protection and payment of claims and taxes.

23. Final Inspection and Acceptance

When the Contractor considers the work physically complete and ready for final inspection, the Contractor shall request the City's Project Manager to inspect the work. The City will notify the Contractor of any deficiencies in the work after inspection. The Contractor shall immediately take such corrective measures as are necessary to remedy the listed deficiencies. Corrective work shall be pursued vigorously, diligently, and without interruption until physical completion of the listed deficiencies. This process will continue until the City is satisfied the listed deficiencies have been corrected.

PART THREE

CONTRACT DOCUMENTS

CONTRACT

THIS AGREEMENT, made and entered into this _____ day of _____, 20____, between the City of Camas under and by virtue of Title 35A RCW (cities and towns), as amended

And, _____, hereinafter called the Contractor.

WITNESSETH:

That in consideration of the terms and conditions contained herein and attached and made a part of this agreement, the parties hereto covenant and agree as follows:

I. The Contractor shall do all work and furnish all tools, materials and equipment for **Street Light Pole Replacement, Maintenance and Repair, Unit Priced Public Works Contract City of Camas Project No. UPC2201**, in accordance with and as described in the attached plans and specifications, and the standard specifications of the Washington State Department of Transportation which are by the reference incorporated herein and made part hereof and, shall perform any changes in the work in accord with the Contract Documents.

The Contractor shall provide and bear the expense of all equipment, work and labor, of any sort whatsoever that may be required for the transfer of materials and for constructing and completing the work provided for in these Contract Documents except those items mentioned therein to be furnished by the City of Camas. In all respects, the Contractor is an independent Contractor, and not an employee of the City of Camas.

II. The City of Camas hereby promises and agrees with the Contractor to employ, and does employ the Contractor to provide the materials and to do and cause to be done the above described work and to complete and finish the same in accord with the attached plans and specifications and the terms and conditions herein contained and hereby contracts to pay for the same according to the attached specifications and the schedule of unit or itemized prices at the time and in manner and upon the conditions provided for in this contract.

III. The Contractor for himself/herself, and for his/her heirs, executors, administrators, successors, assigns, does hereby agree to the full performance of all the covenants herein contained upon the part of the Contractor.

IV. The Contractor shall defend, indemnify and hold the City of Camas, its officers, officials, employees and volunteers harmless from any and all claims, injuries, damages, losses or suits including attorney fees, arising out of or in connection with the performance of this Agreement, except for injuries and damages caused by the sole negligence of the City of Camas.

However, should a court of competent jurisdiction determine that this Agreement is subject to RCW 4.24.115, then in the event of liability for damages arising out of bodily injury to persons or damages to property caused by or resulting from the concurrent negligence of the Contractor and the City, its officers, officials, employees, and volunteers, the Contractor's liability hereunder shall be only to the extent of the Contractor's negligence. It is further specifically and expressly understood that the indemnification provided herein constitutes the Contractor's waiver of immunity under Industrial Insurance, Title 51 RCW, solely for the purposes of this indemnification. This waiver has been mutually negotiated by the parties. The provisions of this section shall survive the expiration or termination of this Agreement.

V. The Contractor shall provide a material, labor, and equipment guarantee for the work performed under this contract for a period of one year from the Date of Acceptance as shown on the Notice of Completion for Public Works Projects. All work shall be free of defect in workmanship or materials. Upon notice, the Contractor shall make all repairs promptly at no cost to the City. Failure to repair or replace defects in a manner satisfactory to the Engineer will constitute a breach of this contract.

VI. The Contractor is obligated to affirm its enrollment and participation in the E-Verify program as written in these specifications and per Camas Ordinance 2626.

VII. As provided by Title VI of the Civil Rights Act of 1964, and the Civil Rights Restoration Act of 1987, the contractor, with regard to the work performed by it during the contract, shall not discriminate on the grounds of race, color, sex or national origin in the selection and retention of sub-contractors, including procurement of materials and leases of equipment.

City of Camas, Washington in accordance with the provisions of Title VI of the Civil Rights Act of 1964 (78 Stat. 42 U.S.C. §§ 2000d to 2000d-4) and the Regulations, hereby notified all bidders that it will affirmatively ensure that any contract entered into pursuant to this advertisement, all contractors will be afforded full and fair opportunity to submit bids in response to this invitation and will not be discriminated against on the grounds of the owner's race, color, national origin, sex, age, disability, income-level, or LEP in consideration for an award.

VIII. The Contractor is obligated to pay Washington State Department of Labor and Industries Prevailing Wage Rates for Clark County effective June 10, 2022.

IX. The Contractor further acknowledges the following provisions and agrees to comply with the conditions as set forth therein:

THIS PROJECT REQUIRES A CONTRACT BOND FOR 100% OF THE CONTRACT AMOUNT.

X. The Contractor shall certify that they are not presently debarred, suspended, proposed for debarment, declared ineligible, or voluntarily excluded from participating in covered transactions by any State or Federal department or agency.

XI. The Contractor shall not propose or contract with any person or entity that is currently debarred, suspended, and ineligible contractors and grantees.

XII. It is further provided that no liability shall attach to the City of Camas by reason of entering into this contract, except as provided herein.

XIII. The Contractor shall maintain its records and accounts so as to facilitate audit requirements as established by the Office of the State Auditor and shall require subcontractors to do the same.

IN WITNESS WHEREOF, the Contractor has executed this instrument, on the day and year first below written and the Mayor of the City of Camas has caused this instrument to be executed by and in the name of the said City of Camas the day and year first above written.

Executed by the Contractor _____, 20____.

Contractor

Executed by the Local Agency _____, 20____.

Mayor

Approved as to Form

City of Camas Attorney

**DECLARATION OF OPTION FOR INVESTMENT OF RETAINED
PERCENTAGE**

I hereby elect to have the retained percentage of this contract held in a fund by the City of Camas until thirty (30) days following final acceptance of the work.

Signed _____

Date _____

I hereby elect to have the City of Camas invest the retained percentage of this contract from time to time as such retained percentage accrues and in accordance with RCW 60.28.020. The City will select the repository.

I hereby further agree to be fully responsible for payment of all costs or fees incurred as a result of placing said retained percentage in escrow and investing it as authorized by statute. The City of Camas shall not be liable in any way for any costs or fees in connection herewith.

Signed _____

Date _____

CONTRACT BOND

KNOW ALL PERSONS BY THESE PRESENTS, That

of _____, as Principal, and _____

as Surety, are jointly and severally held and bound unto the City of Camas, Washington,

in the penal sum of Dollars Three Hundred Fifty Thousand (\$350,000), for the payment of which we jointly and severally bind ourselves, our heirs, executors, administrators, and assigns, and successors and assigns, firmly by these presents.

THE CONDITION of this bond is such that whereas, on the _____

day of _____ A.D., 20____, the said _____

Principal, herein, executed a certain contract with the City of Camas, Washington,

by the terms, conditions and provisions of which contract the said _____,

Principal, herein, agree to furnish all material and do certain work, to wit: That

_____ will undertake and

complete the construction of these **Street Light Pole Replacement, Maintenance and Repair a Unit Priced Public Works Contract, City of Camas Project No. UPC2201**, according to the maps, plans and specifications made a part of said contract, which contract as so executed, is hereunto attached, is now referred to and by reference is incorporated herein and made a part hereof as fully for all purposes as if here set forth at length. The bond shall cover all approved change orders as if they were in the original contract.

NOW, THEREFORE, if the Principal herein shall faithfully and truly observe and comply with the terms, conditions and provisions of said contract in all respects and shall well and truly and fully do and perform all matters and things by the Contract Completion Date or when the Not-to-Exceed limit has been reached, whichever comes first, undertaken to be performed under said contract, upon the terms proposed therein, and within the time prescribed therein, and until the same is accepted, and shall pay all laborers, mechanics, subcontractors and material men, and all persons who shall supply such contractor or subcontractor with provisions and supplies for the carrying on of such work, and shall in all respects faithfully perform said contract according to law, then this obligation to be void, otherwise to remain in full force and effect.

WITNESS our hands this _____ day of _____, 20__

PRINCIPAL

ATTORNEY-IN-FACT, SURETY

NAME AND ADDRESS, LOCAL OFFICE OF AGENT

APPROVED:

CITY OF CAMAS, WASHINGTON

BY: _____
Mayor

DATE: _____, 20__

SURETY BOND NUMBER _____

The United States Department of Transportation
Appendix A of the
Standard Title VI/ Non-Discrimination Assurances
DOT Order No. 1050.2A

During the performance of this contract, the contractor, for itself, its assignees, and successors in interest (hereinafter referred to as the "contractor") agrees as follows:

1. **Compliance with Regulations:** The contractor (hereinafter includes consultants) will comply with the Acts and the Regulations relative to Non-discrimination in Federally-assisted programs of the U.S. Department of Transportation, Federal Highway Administration (FHWA), as they may be amended from time to time, which are herein incorporated by reference and made a part of this contract.
2. **Non-discrimination:** The contractor, with regard to the work performed by it during the contract, will not discriminate on the grounds of race, color, national origin, sex, age, disability, income-level, or Limited English Proficiency (LEP) in the selection and retention of subcontractors, including procurements of materials and leases of equipment. The contractor will not participate directly or indirectly in the discrimination prohibited by the Acts and the Regulations as set forth in Appendix E, including employment practices when the contract covers any activity, project, or program set forth in Appendix B of 49 C.F.R. Part 21.
3. **Solicitations for Subcontracts, Including Procurements of Materials and Equipment:** In all solicitations, either by competitive bidding, or negotiation made by the contractor for work to be performed under a subcontract, including procurements of materials, or leases of equipment, each potential subcontractor or supplier will be notified by the contractor of the contractor's obligations under this contract and the Acts and the Regulations relative to Non-discrimination on the grounds of race, color, national origin, sex, Age, disability, income-level or LEP.
4. **Information and Reports:** The contractor will provide all information and reports required by the Acts, the Regulations and directives issued pursuant thereto and will permit access to its books, records, accounts, other sources of information, and its facilities as may be determined by the Recipient or the FHWA to be pertinent to ascertain compliance with such Acts, Regulations and instructions. Where any information required of a contractor is in the exclusive possession of another who fails or refuses to furnish the information, the contractor will so certify to the Recipient or the FHWA, as appropriate, and will set forth what efforts it has made to obtain the information.
5. **Sanctions for Noncompliance:** In the event of a contractor's noncompliance with the Non-discrimination provisions of this contract, the Recipient will impose such contract sanctions as it or the FHWA may determine to be appropriate, including, but not limited to:
 - a. withholding payments to the contractor under the contract until the contractor complies; and/or
 - b. cancelling, terminating, or suspending a contract, in whole or in part.

Incorporation of Provisions: The contractor will include the provisions of paragraphs one through six in every subcontract, including procurements of materials and leases of equipment, unless exempt by the Acts, the Regulations and directives issued pursuant thereto. The contractor will take action with respect to any subcontract or procurement as the Recipient or the FHWA may direct as a means of enforcing such provisions including sanctions for noncompliance. Provided, that if the contractor becomes involved in, or is threatened with litigation by a subcontractor, or supplier because of such direction, the contractor may request the Recipient to enter into any litigation to protect the interests of the Recipient. In addition, the contractor may request the United States to enter into the litigation to protect the interests of the United States.

The United States Department of Transportation
Appendix E of the
Standard Title VI/ Non-Discrimination Assurances
DOT Order No. 1050.2A

During the performance of this contract, the contractor, for itself, its assignees, and successors in interest (hereinafter referred to as the "contractor") agrees to comply with the following non-discrimination statutes and authorities, including, but not limited to:

Pertinent Non-Discrimination Authorities:

- Title VI of the Civil Rights Act of 1964 (42 U.S.C. § 2000d *et seq.*, 78 stat.252), prohibits discrimination on the basis of race, color, national origin); and 49 CFR Part 21.
- The Uniform Relocation Assistance and Real Property Acquisition Policies Act of 1970, (42 U.S.C. § 4601), (prohibits unfair treatment of persons displaced or whose property has been acquired because of Federal or Federal-aid programs and projects);
- Federal-Aid Highway Act of 1973, (23 U.S.C. § 324 *et seq.*), prohibits discrimination on the basis of sex);
- Section 504 of the Rehabilitation Act of 1973, (29 U.S.C. § 794 *et seq.*), as amended, prohibits discrimination on the basis of disability; and 49 CFR Part 27;
- The Age Discrimination Act of 1975, as amended, (42 U.S.C. § 6101 *et seq.*), prohibits discrimination on the basis of age);
- Airport and Airway Improvement Act of 1982, (49 U.S.C. § 471, Section 47123, as amended, (prohibits discrimination based on race, creed, color, national origin, or sex);
- The Civil Rights Restoration Act of 1987, (PL 100-209), Broadened the scope, coverage and applicability of Title VI of the Civil Rights Act of 1964, The Age Discrimination Act of 1975 and Section 504 of the Rehabilitation Act of 1973, by expanding the definition of the terms "programs or activities" to include all of the programs or activities of the Federal-aid recipients, sub-recipients and contractors, whether such programs or activities are Federally funded or not);
- Titles II and III of the Americans with Disabilities Act, which prohibit discrimination on the basis of disability in the operation of public entities, public and private transportation systems, places of public accommodation, and certain testing entities (42 U.S.C. §§ 12131 – 12189) as implemented by Department of Transportation regulations 49 C.F.R. parts 37 and 38.
- The Federal Aviation Administration's Non-discrimination statute (49 U.S.C. § 47123) (prohibits discrimination on the basis of race, color, national origin, and sex);
- Executive Order 12898, Federal Actions to Address Environmental Justice in Minority Populations and Low-Income Populations, which ensures discrimination against minority populations by discouraging programs, policies, and activities with disproportionately high and adverse human health or environmental effects on minority and low-income populations;
- Executive Order 13166, Improving Access to Services for Persons with Limited English Proficiency, and resulting agency guidance, national origin discrimination includes discrimination because of limited English proficiency (LEP). To ensure compliance with Title VI, you must take reasonable steps to ensure that LEP persons have meaningful access to your programs (70 Fed. Reg. at 74087 to 74100);

Title IX of the Education Amendments of 1972, as amended, which prohibits you from discriminating because of sex in education programs or activities (20 U.S.C. 1681 *et seq.*).

PART FOUR

AMENDMENTS TO THE STANDARD SPECIFICATIONS

INTRODUCTION

The following Amendments and Special Provisions shall be used in conjunction with the current updated version of the 2022 Standard Specifications for Road, Bridge, and Municipal Construction, as of the Call for Bids date.

AMENDMENTS TO THE STANDARD SPECIFICATIONS

WSDOT manuals and publications are updated continuously and revisions are issued periodically. It is the responsibility of bidders to make sure they have the current versions, regardless of the manual format or means of transmission. Publications on the WSDOT web page are the most recent versions and can be downloaded and printed without charge. Please check Standard Specifications Manual at <https://wsdot.wa.gov/Publications/Manuals/M41-10.htm> for the most current specifications.

PART FIVE

WASHINGTON STATE HOURLY PREVAILING WAGE RATES

- Journey level wage rates are NOT included in this packet. Journey and apprentice rates applicable to this project can be looked up at the Washington State Department of Labor and Industries web site at www.lni.wa.gov/TradesLicensing/PrevWage/WageRates/
 - Washington State LNI wage rates for Clark County effective date June 10, 2022.
 - A printed copy of the wages rates are available for viewing in the Public Works Department at Camas City Hall.
 - The City of Camas will mail a hard copy of the applicable prevailing wage rates upon request.

PART SIX

AFFIDAVIT OF E-VERIFY COMPLIANCE

AFFIDAVIT OF COMPLIANCE WITH
PUBLIC WORK CONTRACTOR LAWFUL HIRING
COMPLIANCE (E-VERIFY)

**COMPLETE AND RETURN THIS FORM
AT COMPLETION OF THIS PROJECT**

_____ being first duly sworn, on her/his oath says that Contractor, Subcontractors, and all Lower Tiered Subcontractors have complied with the terms and conditions for the E-Verify program as written in the contract and project specifications for:

**Street Light Pole Replacement, Maintenance and Repair
City of Camas, Project No. UPC2201**

Contractor

Subscribed and sworn to before me this ____ day of _____, 20____.

Notary Public in and for
State of Washington, residing in

My commission expires:

**Prior to issuance of final payment, this form must be signed,
Notarized, and submitted to the City of Camas.**

PART SEVEN

STANDARD DETAILS AND

EQUIPMENT SPECIFICATIONS

CITY OF CAMAS

ENGINEERING DESIGN STANDARDS FOR STREET LIGHTING

ALL INFORMATION IS INTENDED TO PRODUCE A LIGHTING DESIGN WITH LUMINANCE LEVELS AND LUMINANCE UNIFORMITY WHICH MEETS OR EXCEEDS THOSE IN THE I.E.S. "RECOMMENDED MAINTAINED LUMINANCE FOR ROADWAYS" FROM THE I.E.S. LIGHTING HANDBOOK. INSTALLATION OF ADDITIONAL LIGHTS MAY BE NECESSARY TO MEET THE INTENT OF THIS STANDARD.

1. WHERE THE AVERAGE RESIDENTIAL DENSITY IS GREATER THAN 12 DWELLING UNITS PER ACRE, USE COMMERCIAL OR INTERMEDIATE FOR LAND USE.
2. AVERAGE MAINTAINED LUMINANCE IS MEASURED IN FOOT CANDELAS PER SQUARE METER.
3. AT SIGNALIZED INTERSECTIONS, THE AVERAGE MAINTAINED LUMINANCE SHALL BE OF THE AVERAGE FOR THE TWO INTERSECTING STREETS.
4. LUMINANCE UNIFORMITY IS THE RATIO OF AVERAGE OR MAXIMUM MAINTAINED LUMINANCE TO MINIMUM LUMINANCE. LUMINANCE VALUES OUTSIDE THE ROADWAY SHALL NOT BE INCLUDED IN THE RATIO. ALL SIDEWALK AREAS AND THE AREA BETWEEN THE SIDEWALK AND THE STREET CURB SHALL BE INCLUDED WHEN DETERMINING THE MAINTAINED LUMINANCE.
5. LIGHTING LAYOUTS WILL REQUIRE APPROVAL AND POSSIBLE ADJUSTMENT TO MEET THE CITY OF CAMAS LIGHTING OBJECTIVES AND I.E.S. STANDARDS. THIS MAY INCLUDE ADJUSTMENT TO THE POLE SPACING AS LISTED AND MAY RESULT IN ADDITIONAL OR FEWER LIGHTS.
6. ALL LIGHTING FIXTURES SHALL BE LIGHT EMITTING DIODE (LED). LIGHTING CIRCUITS SHALL BE 120 VOLTS.
7. THE MOUNTING HEIGHT OF THE FIXTURE IS MEASURED FROM THE ROADWAY SURFACE TO THE CENTER OF THE LIGHT SOURCE WITH THE FIXTURE LOCATED OVER THE BIKE LANE LINE OR SIX FEET FROM THE FACE OF CURB.
8. ALTERNATIVE LIGHTING LAYOUTS MAY BE SUBMITTED FOR REVIEW. WHERE LIGHTING IS REQUIRED ON BOTH SIDES, DESIGNS SHALL BE "OPPOSITE LIGHTING" ON MAJOR ROADWAYS 46 FEET OR GREATER IN WIDTH. THE USE OF STAGGERED LIGHTING SHALL ONLY BE USED WHERE "OPPOSITE LIGHTING" IS NOT PRACTICAL. LIGHTING LAYOUTS ON LOCAL RESIDENTIAL STREETS WITHIN A SUBDIVISION MAY VARY FROM SIDE TO SIDE.
9. COBRA STYLE LIGHT POLES ARE REQUIRED ON ALL COLLECTOR AND ARTERIAL ROADWAYS.
10. MAXIMUM POLE HEIGHT SHALL BE LIMITED TO 30 FEET.
11. A LIGHTING DESIGN CONSISTENT WITH THESE REQUIREMENTS AND APPROVED BY CLARK PUBLIC UTILITY DISTRICT SHALL BE SUBMITTED FOR FINAL REVIEW AND APPROVAL TO THE CITY PRIOR TO INSTALLATION.

12. STREET LIGHTS ON LOCAL AND NEIGHBORHOOD LEVEL STREETS SHALL BE LOCATED AT PROPERTY LINES.
13. THE STREET LIGHTS SHALL BE LOCATED IN THE PLANTER STRIP UNLESS OTHERWISE APPROVED BY THE CITY.

Ornamental Light Standards

Lighting poles and arm assemblies shall be Hapco 30' Decorative Lighting Poles (Hapco Drawing Number B29351), or equal. Design and fabrication shall meet or exceed the requirements of the latest AASHTO Standard Specifications for Structural Supports for Highway Signs, Luminaires and Traffic Signals.

Light pole manufacturers are required to submit structural design calculations.

Finish: Poles shall be powder coat textured black per Hapco specification 73737-T01.

Anchorage: Included for each pole shall be a minimum of four steel anchor bolts, complete with double hex nuts and washers. Nuts, washers and threaded areas of anchor bolts shall be hot-dip galvanized to ASTM - A153. Anchor bolts shall have a 55,000 psi minimum yield strength. Anchor bolts and bolt template shall be delivered on site to the contractor within two (2) weeks of receipt of a purchase order.

Foundation: Ornamental light standard foundations shall be Type B and shall meet the requirements of Standard Plan J-28.30-02 and Section 8-20.3(4) with a four anchor bolt pattern. Anchor bolts shall meet the requirements specified in the Anchorage section of these Special Provisions. Contractor shall verify anchor bolt pattern with the pole manufacturer prior to fabrication of foundations.

Wind Resistance: Entire luminaire, pole and arm assembly to be rated to withstand AASHTO requirements for 90 mile an hour wind load with a 30% gust factor.

Welds: All welds shall meet the requirements of AWS D1.1.

Material Certification: Material certifications shall be provided for all ASTM numbers referred to in this specification.

Pole: The pole shall consist of a tapered shaft fabricated from aluminum alloy 6063-T6 with a wall thickness of 0.188".

The base plate shall be arranged to accept (4) anchor bolts on an 11" to 12" bolt circle.

The pole shaft shall be furnished with a 4" x 6" length reinforcing hand hole frame with cover and stainless steel screws.

Ornamental Base Assembly: The base shall be a Hapco Two Piece Decorative Base Cover (Part Number 79012-003) constructed of Alloy 356 with stainless steel screws.

Complete calculations for the structural design, including anchor bolt details, shall be prepared by a professional engineer licensed under Title 18 RCW State of Washington, in the branch of Civil or Structural Engineering. All shop drawings and cover page of all calculations submittals shall carry signature, original seal, registration number and date of expiration. The cover page shall include the contract number, contract title and sequential index to calculation page numbers. Two copies of the associated design calculation shall be submitted for approval along with shop drawings.

Luminaire Arm: The ornamental arm shall be a Hapco 2-1/2" schedule 80 pipe (2-7/8" outside diameter) Alloy 6063-T6 with 4'-8" rise.

Conventional Roadway Luminaires: Roadway luminaires shall be an American Electric Lighting (AEL) Autobahn Series ATB2, part numbers ATB2 60BLEDE10 MVOLT R2 and ATB2 40BLEDE10 MVOLT R4 or an approved equal.

Photoelectric Controls: The photoelectric control shall be Ripley LongLife II Photocontrol Model 6390L-BK or approved equal. An approved equal shall meet the following requirements:

The photoelectric relay shall attach to a three-pole three-wire locking receptacle by a twisting motion.

The photo cell shall be a silicon phototransistor with an infrared-filter.

The factory set turn-on shall be 1.5 foot-candle plus or minus 0.25 foot-candle at 120 V AC. The factory set turn-off shall be 2.25 foot-candle at 120 V AC. The maximum off-to-on ratio shall be 1.5:1. A time-delay control circuit shall prevent false turn-offs by transient light conditions. Time delay off shall be 3 to 5 seconds. The turn-on response time shall be less than 0.5 seconds.

Provide a fail-safe circuit for the lighting load to remain on, or become energized, if any functional failure of the photoelectric control circuit occurs.

Normal operation shall be designed for dual voltage operation of 105 V – 305 V, 60 Hz. At the designated voltage, the relay shall be capable of controlling a minimum lamp load of 1000 W.

Power consumption shall be less than 0.5 W.

Operating temperature range shall be from -40° F to 158° F.

The unit shall have built-in surge protection for high-voltage of 640 Joule MOV rated at 40,000 amps with secondary protection.

The unit shall provide cross switching for protection from high inrush currents found in LED technology.

The dielectric strength shall be 5000 V between parts carrying current and metal surfaces.

The unit shall meet or exceed the requirements of ANSI C136.10.

The unit shall be RoHS compliant.

The unit shall have a design life of 20 years or more. The warranty shall be 12 years or more.

The gasket must be stable and have 0% shrinkage.

W:\2018\18-03-000-Camas-Central-Workshop-2018-Improvements\18-03-000.dwg

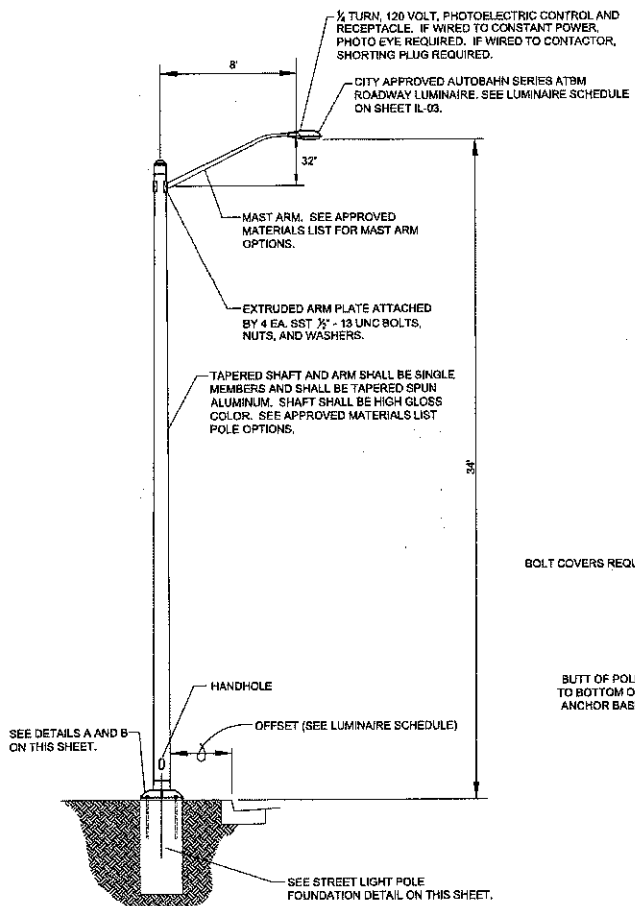

LIGHT POLE DETAIL

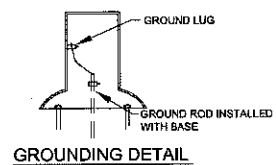
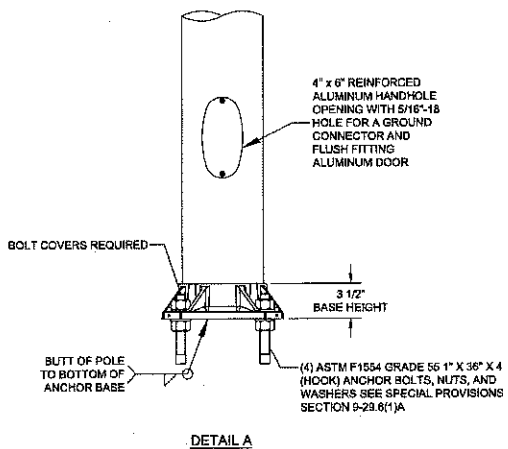
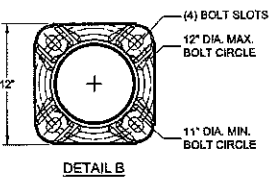
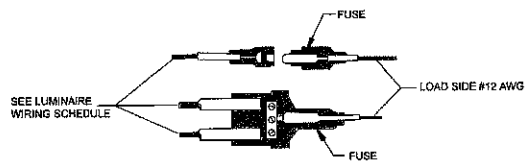

NOTE:
1. FOUNDATION HAS BEEN DESIGNED TO ACCOMMODATE (2) - 2'-0" WIDE X 5'-0" TALL BANNER SIGN MOUNTED 15'-0" FROM FINISHED GRADE TO BOTTOM OF BANNER AND (2) 8'-0" SPAN LUMINAIRE ARMS.

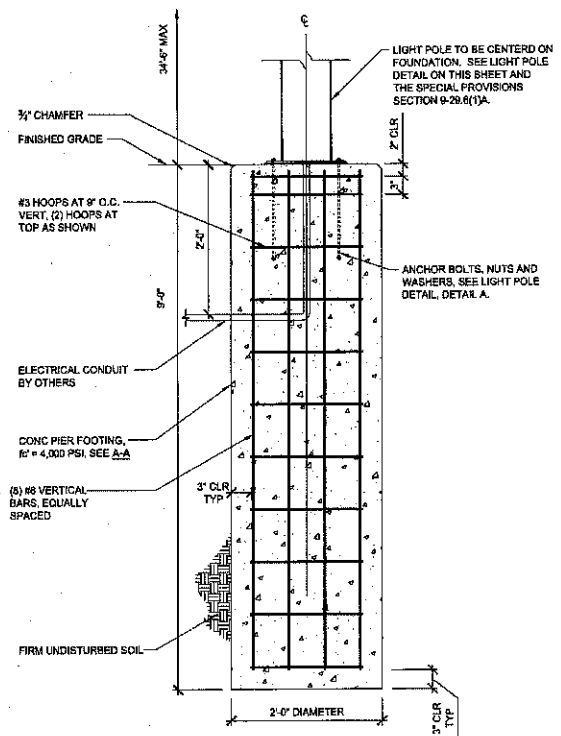
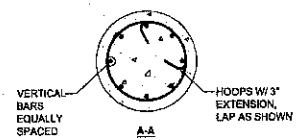

STREET LIGHT POLE FOUNDATION

CALL 2 BUSINESS DAYS BEFORE YOU DIG
1-800-424-5555
It's the law!
CLATSOP COUNTY UTILITIES COORDINATING COUNCIL

DATES	
DESIGN DATE	JUNE 2018
AS-BUILT DATE	
SCALE	AS SHOWN
HORIZONTAL	AS SHOWN
VERTICAL	N/A
CONTACTS	
DESIGNED BY	ROBERT SPERLING
APPROVED BY	DANA BROWN
PROJECT NAME	DANA BROWN



DEPARTMENT OF PUBLIC WORKS
ENGINEERING DEPARTMENT
LARKSPUR STREET IMPROVEMENTS
ILLUMINATION DETAILS



CAMAS PROJECT NUMBER #S-604	
STATUS	PAGE
<input checked="" type="checkbox"/> DRAFT	49 OF 58
<input type="checkbox"/> IN CONSTRUCTION	
<input type="checkbox"/> FINAL	
CAMAS DRAWING NUMBER IL-05	
CAMAS CATALOG NUMBER	

GLOBAL Transportation Engineering
227 SW Pine St, Suite 329
Portland, Oregon 97204

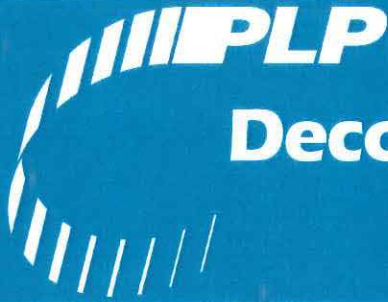

Decorative Pole Specifications

PLP Model# Dom-DB-FL-14.5-BL-CI

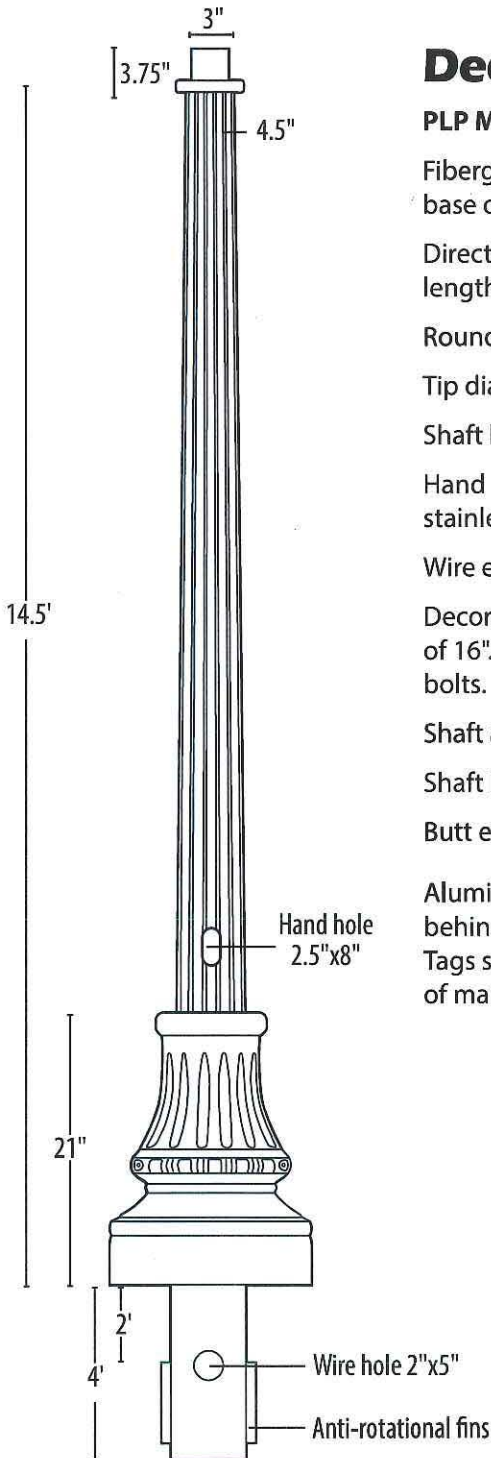

Decorative Pole Specifications

PLP Model# Dom-DB-FL-14.5-BL-CI

Fiberglass reinforced composite fluted shaft with decorative 2-piece (clam shell) base of casting urethane.

Direct burial (embedded) style with a 14.5' mounting height and an overall length of 18.5' allowing 4 feet to be buried below grade.

Round tapered fluted shaft.

Tip diameter is 4.5" and ground level diameter is 6.5".

Shaft hand hole is 2.5"x8" above the decorative base.

Hand hole is equipped with a non-conductive cover with vandal resistant 1/4-20 stainless steel screws.

Wire entrance hole of 2"x5" with nylon grommet 2' below grade.

Decorative base for the PLP "Dominion" design is 21" high with a base diameter of 16". The 2-piece "clam shell" design is secured together with stainless steel bolts.

Shaft and decorative base are black with a textured satin "cast iron" finish.

Shaft has a post top steel tenon of 3"x3.75"

Butt end of the shaft has anti-rotational/anti-lift fins.

Aluminum identification tags are fixed to the shaft behind the base and on the inside of the base itself. Tags show manufacturer, model number and date of manufacture.

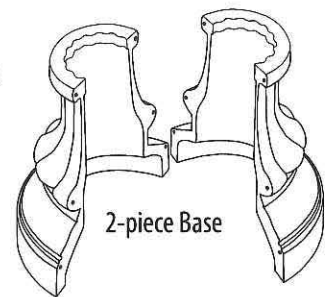

2-piece Base

Project/Customer: _____

Date: _____

Revision: _____

Drawing Number: _____

PLP Composite Technologies, Inc.

57 Creamery Road • PO Box 429 • Fitzwilliam, NH 03447 • Tel: 603-585-9100 • Fax: 603-585-3470 • www.plpcomp.com

- Notes:
- 1) Short And Bracket Heat Treated To -78 Temper After Welding.
 - 2) Pole Designed To Meet The Latest AASHTO Standard Specifications For Structural Supports For Highway Signs, Luminaires, and Traffic Signals (Except Breakaway) For A 60 mph Wind Velocity And A Maximum Luminaires Size Of 2.0' x 4.0' E.A. And 80 Lbs. And Tails 3 1/2' x 5' Maximum On Tower Saver Arms.
 - 3) Pole, Arm, Base, Cover, And Luminaires Heat Seal to Powder Coated Textured Black For HAPCO Specification 73737-101.

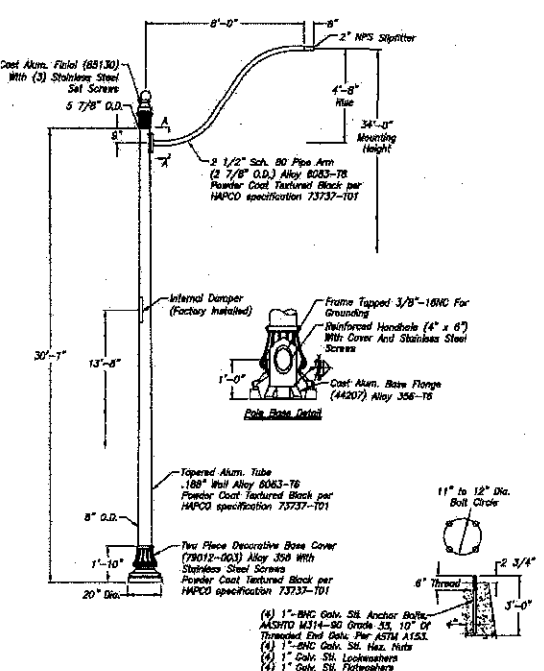

ORNAMENTAL STREET LIGHTING STANDARD

SERVICE CABINET AT 6TA 10+90 ADJACENT TO EXISTING WSDOT SERVICE POLE			
MAIN	MAIN BREAKER	200 AMP	N/A
C1-A	ILLUMINATION NE SIDE OF 6TH AVENUE	20 AMP	30 AMP
C1-B	ILLUMINATION BE SIDE OF 6TH AVENUE	20 AMP	30 AMP
C1-C	ILLUMINATION WEST SIDE OF ROUNDABOUT	20 AMP	30 AMP
C1-D	POWER TO ROUNDABOUT CENTRAL ISLAND	30 AMP	N/A

BREAKER SCHEDULE

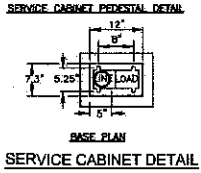
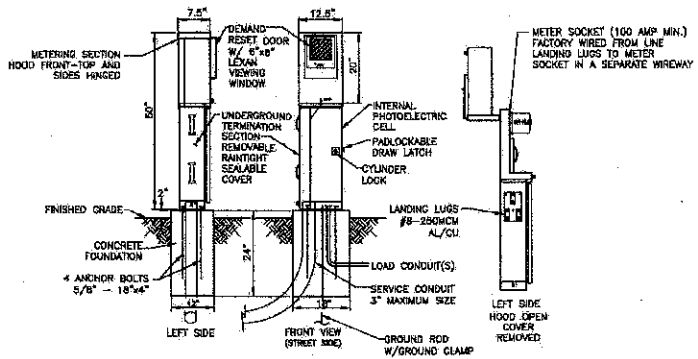

Autobahn Series ATBM

Autobahn Series ATBM technical specifications. The product is a street lighting fixture. It has a maximum height of 12.5 feet. It has a maximum width of 7.5 feet. It has a maximum depth of 12.5 feet. It has a maximum weight of 100 pounds. It has a maximum wind speed of 60 mph. It has a maximum temperature of 100 degrees Fahrenheit. It has a maximum humidity of 100%. It has a maximum salt crystallization of 100%. It has a maximum sulfur dioxide of 100%. It has a maximum nitrogen dioxide of 100%. It has a maximum ozone of 100%. It has a maximum carbon monoxide of 100%. It has a maximum carbon dioxide of 100%. It has a maximum particulate matter of 100%. It has a maximum noise level of 100 dB. It has a maximum vibration level of 100 g. It has a maximum shock level of 100 g. It has a maximum impact level of 100 ft-lb. It has a maximum drop level of 100 feet. It has a maximum fire level of 100 minutes. It has a maximum theft level of 100 minutes. It has a maximum vandalism level of 100 minutes. It has a maximum graffiti level of 100 minutes. It has a maximum graffiti removal level of 100 minutes. It has a maximum graffiti resistance level of 100 minutes. It has a maximum graffiti resistance level of 100 minutes.

ORNAMENTAL STREET LIGHTING FIXTURE

ILLUMINATION NOTES:

GENERAL NOTES:
SEE SHEETS 2 AND 3 FOR GENERAL NOTES, LEGEND & ABBREVIATIONS.
1. THIS DRAWING PROVIDES A SCHEMATIC OF THE STREET LIGHT SYSTEM ONLY. ALL JUNCTION BOXES, CABINETS AND CONDUIT MUST BE INSTALLED AROUND CONDUCTING UTILITIES THAT MAY NOT BE SHOWN ON THIS PLAN.

ILLUMINATION SYSTEM

- 01 - #2 CONDUIT SERVICE NUMBER AND BRANCH LETTER
- 02 - INSTALL (N) AVG. NO. (3) CONDUCTORS.
- 03 - INSTALL (N) AVG. NO. (3) STRANDED COPPER WIRE (GROUNDING).
- 04 - CIRCUIT ASSOCIATED WITH LIGHTING STANDARD.
- 05 - INSTALL (M) WATT LED STREET LIGHTING.
- 06 - INSTALL ORNAMENTAL STREET LIGHTING STANDARD WITH 8' MAST AND SEE STREET LIGHT POLE SCHEDULE AND DETAIL THIS SHEET.
- 07 - INSTALL TYPE 1 JUNCTION BOX WITH NONLOCKING LID. SEE WSDOT STANDARD PLAN J-44.10-02.
- 08 - INSTALL TYPE 2 JUNCTION BOX WITH NONLOCKING LID. SEE WSDOT STANDARD PLAN J-44.10-02.
- 09 - LIGHTING STANDARD POLE NUMBER (N) SHOWN. SEE POLE SCHEDULE. LIGHTING STANDARD SHALL BE INSTALLED WITH AUTOMAHN SERIES ATBM 15W LED FIXTURE ON MAST ARM (ATBM H MULTY RS BK FOR ORNAMENTAL POLES).
- 10 - INSTALL (S) INCHES SCHEDULE 40 PVC ELECTRICAL CONDUIT. (X) DENOTES NUMBER OF CONDUITS IF GREATER THAN ONE. CONDUIT LOCATION IS APPROXIMATE ONLY. FINAL LOCATION TO BE DETERMINED IN THE FIELD AND APPROVED BY THE ENGINEER.
- 11 - REMOVE EXISTING COBRA HEAD FIXTURE AND INSTALL NEW AUTOMAHN SERIES ATBM 15W LED FIXTURE ON EXISTING MAST ARM (ATBM H MULTY RS BK).
- 12 - REMOVE EXISTING LIGHT STANDARD AND ASSOCIATED OVERHEAD WIRING.
- 13 - REMOVE EXISTING LIGHT STANDARD FROM FOUNDATION. RELOCATE AND INSTALL LIGHT STANDARD ON NEW FOUNDATION WITH ASSOCIATED WIRING.
- 14 - INSTALL NEW CABINET - CITY ILLUMINATION SYSTEM.
- 15 - CONNECT TO EXISTING CONTACTOR CABINET FOR WSDOT ILLUMINATION SYSTEM.
- 16 - CONNECT TO EXISTING POWER SOURCE. COORDINATE WITH CLARK PLUD.
- 17 - INSTALL NEW STREET LIGHT CONTACTOR CABINET.
- 18 - PROTECT EXISTING WSDOT CONTACTOR CABINET.

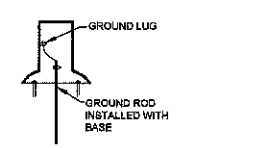

GROUNDING DETAIL

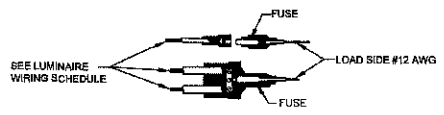

"V" DISCONNECT - FUSED FOR A.W.G.

HDJ DESIGN GROUP logo and contact information: 314 W 15th Street, Vancouver, WA 98660-2927, 509765-5400, 509764-4000, 360666-5767 fax, www.hdjg.com

CALL 2 BUSINESS DAYS BEFORE YOU DIG 1-800-424-5555 "It's the low" CLARK COUNTY UTILITIES COORDINATING COUNCIL

DESIGN DATE:	DATES:	DESIGN DATE:	DATES:
AS-BUILT DATE:	AS-BUILT DATE:	AS-BUILT DATE:	AS-BUILT DATE:
HORIZONTAL:	VERTICAL:	HORIZONTAL:	VERTICAL:
DESIGNED BY:	APPROVED BY:	DESIGNED BY:	APPROVED BY:
CHECKED BY:	CHECKED BY:	CHECKED BY:	CHECKED BY:

CAMAS PUBLIC WORKS DEPARTMENT NW 6TH AVE AND NORWOOD INTERSECTION ILLUMINATION LEGEND & DETAILS

CLARK COUNTY UTILITIES COORDINATING COUNCIL logo

CAMAS PROJECT NUMBER	
S-584	
STATUS:	PAGE:
DRAFT	60 of 82
CAMAS DRAWING NUMBER	
ILO4	
CAMAS CATALOG NUMBER	

LPS-663-60-122 -- Light Pole Foundation

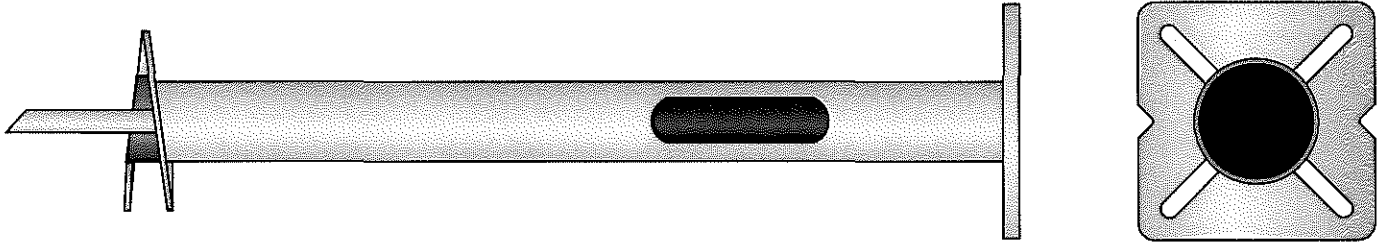

Product Specifications

Product Type	Lighting Foundation
Foundation Diameter	6.63" (168 mm)
Foundation Length	60" (1524 mm)
Base Plate Shape	Square
Bolt Hole Type	Slotted
Bolt Circle/ Slot Dimensions	8" (203 mm) - 14" (356 mm)
Number of Bolt Holes/ Slots	4 Slots
Base Plate Thickness	1" (25.4 mm)
Base Plate Dimensions	12" (305 mm) x 12" (305 mm)
Center Hole Dimension	6.06" (153.9 mm)
Helix Diameter	12" (305 mm)
Coating	Hot-Dip Galvanized
Standard Package	1
Standard Package Unit	Each
Weight/Ea.	148 lbs

Notes

Lighting Foundation 6.63" Diameter x 60" Long with 12" Base

Autobahn Series ATBS

Roadway & Security Lighting



Consistent with LEED® goals & Green Globes™ criteria for light pollution reduction

PRODUCT OVERVIEW

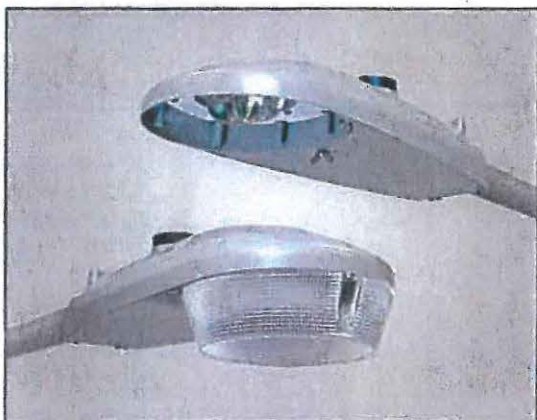

Applications:

Residential streets
Parking lots
General security lighting

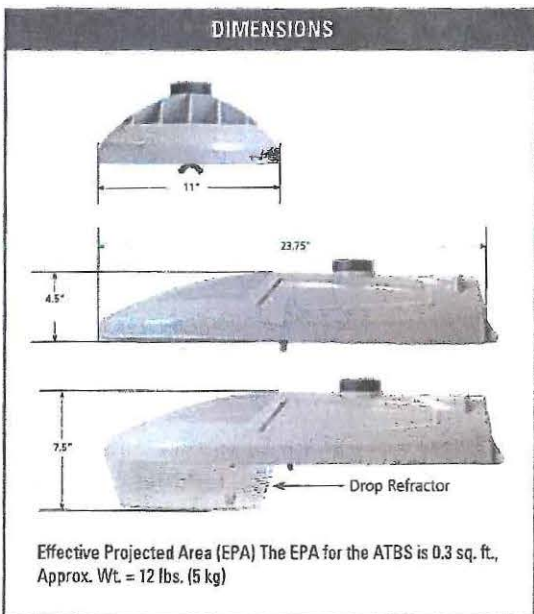

Features:

OPTICAL

Same Light: Performance is comparable to 50W – 150W HPS and up to 175W Mercury Vapor roadway and security lighting luminaires.

White Light: Correlated color temperature - standard 4000K, 70 CRI minimum or optional 5000K, 70 CRI minimum.

IP66 rated borosilicate glass optics ensure longevity and minimize dirt depreciation. Unique IP66 rated LED light engines provide 0% uplight and restrict backlight to within sidewalk depth, providing optimal application coverage and optimal pole spacing.

Available distributions are Type II, III, and V roadway distributions. When used with the optional acrylic refractor the unit provides approximately 10% uplight and increased vertical foot-candles

ELECTRICAL

Expected Life: LED light engines are rated >100,000 hours at 25°C, L70. Electronic driver has an expected life of 100,000 hours at a 25°C ambient.

Lower Energy: Saves an expected 40-60% over comparable HID luminaires.

Robust Surge Protection: Three different surge protection options provide a minimum of IEEE/ANSI C62.41 Category C (10kV/5kA) protection.

MECHANICAL

Includes standard AEL lineman-friendly features such as tool-less entry, 3 station terminal block and quick disconnects. Bubble level located inside the electrical compartment for easy leveling at installation.

Rugged die-cast aluminum housing and door are polyester powder-coated for durability and corrosion resistance. Rigorous five-stage pre-treating and painting process yields a finish that achieves a scribe creepage rating of B (per ASTM D1654) after over 5000 hours exposure to salt fog chamber (operated per ASTM B117).

Mount arm is adjustable for arms from 1-1/4" to 2" (1-5/8" to 2-3/8" O.D.) diameter. The 2 – bolt clamping mechanism provides 3G vibration rating per ANSI C136.

The Wildlife shield is cast into the housing (not a separate piece).

CONTROLS

NEMA 3 pin photocontrol receptacle is standard, with the Acuity designed ANSI standard 5 pin and 7 pin receptacles optionally available.

Premium solid state locking-style photocontrol – PCSS (10 year rated life)
Extreme long life solid state locking-style photocontrol – PCL1 (20 year rated life)

Optional onboard Adjustable Output module allows the light output and input wattage to be modified to meet site specific requirements, and also can allow a single fixture to be flexibly applied in many different applications.

WARRANTY & STANDARDS

5 year limited warranty. Full warranty terms located at http://www.acuitybrands.com/Libraries/Terms_and_Conds/ABL_LED_Commerical_Outdoor.sflb.ashx

Rated for -40°C to 40°C ambient

CSA Certified to U.S. and Canadian standards

Complies with ANSI: C136.2, C136.10, C136.14,

C136.31, C136.15, C136.37

Note: Specifications subject to change without notice. Actual performance may differ as a result of end-user environment and application.

Autobahn Series ATBS

Roadway & Security Lighting

ORDERING INFORMATION

Example: ATBS A MVOLT R2

ATBM	D	MVOLT	R3
Series	Performance Packages	Voltage	Optics
ATBS Autobahn LED Roadway & Security	A 1,800 lumens B 2,400 lumens E 4,000 lumens F 4,600 lumens G 5,600 lumens H 6,300 lumens	MVOLT Multi-volt, 120-277V	R2 Roadway Type II R3 Roadway Type III R5 Roadway Type V D2 Type II, Drop Refractor included D3 Type III, Drop Refractor included D5 Type V, Drop Refractor included

Options		
Color Temperature (CCT) (Blank) 4000K CCT, 70 CRI Min. (standard) 5K 5000K CCT, 70 CRI Min.	Controls (Blank) 3 Pin NEMA Photocontrol Receptacle NR1 No Photocontrol Receptacle DM 0V-10V Dimmable Driver P5 5 Pin Photocontrol Receptacle (dimmable driver included) P7 7 Pin Photocontrol Receptacle (dimmable driver included) PCSS1 DTL DSS Photocontrol PCL11 DTL DLL Photocontrol 120-277V A0 Field Adjustable Output SH Shorting Cap	Accessories ATBSREF Drop Refractor for field installation ATBSHSS House Side Shield for field installation ATBSLTS Light Trespass Shield for field installation
Paint Blank Gray (Standard) BK Black WH White BZ Bronze	Install Packages PKGS DTL DSS Photocontrol PKGL DTL DLL Photocontrol Packages ship with selected photocontrol, 24", 1 1/4" diameter arm, 5' of prewire and mounting hardware	
Surge Protection Blank Acuity SPD-10kV/5kA with inductive filter (Standard) MP MOV Pack IL SPD with Indicator Light		
Misc. HSS House Side Shield NL NEMA Label XL Not CSA Certified		

Notes

1. Not available with Install Packages.



AEL Headquarters, 3825 Columbus Road, Granville, OH 43023
 www.americanelectricalighting.com
 © 2014-2015 Acuity Brands Lighting, Inc. All Rights Reserved. 07/15/15

Warranty Five-year limited warranty. Complete warranty terms located at: www.acuitybrands.com/CustomerResources/Terms_and_conditions.aspx
 Actual performance may differ as a result of end-user environment and application. All values are design or typical values, measured under laboratory conditions at 25 °C. Specifications subject to change without notice.

Please contact your sales representative for the latest product information.

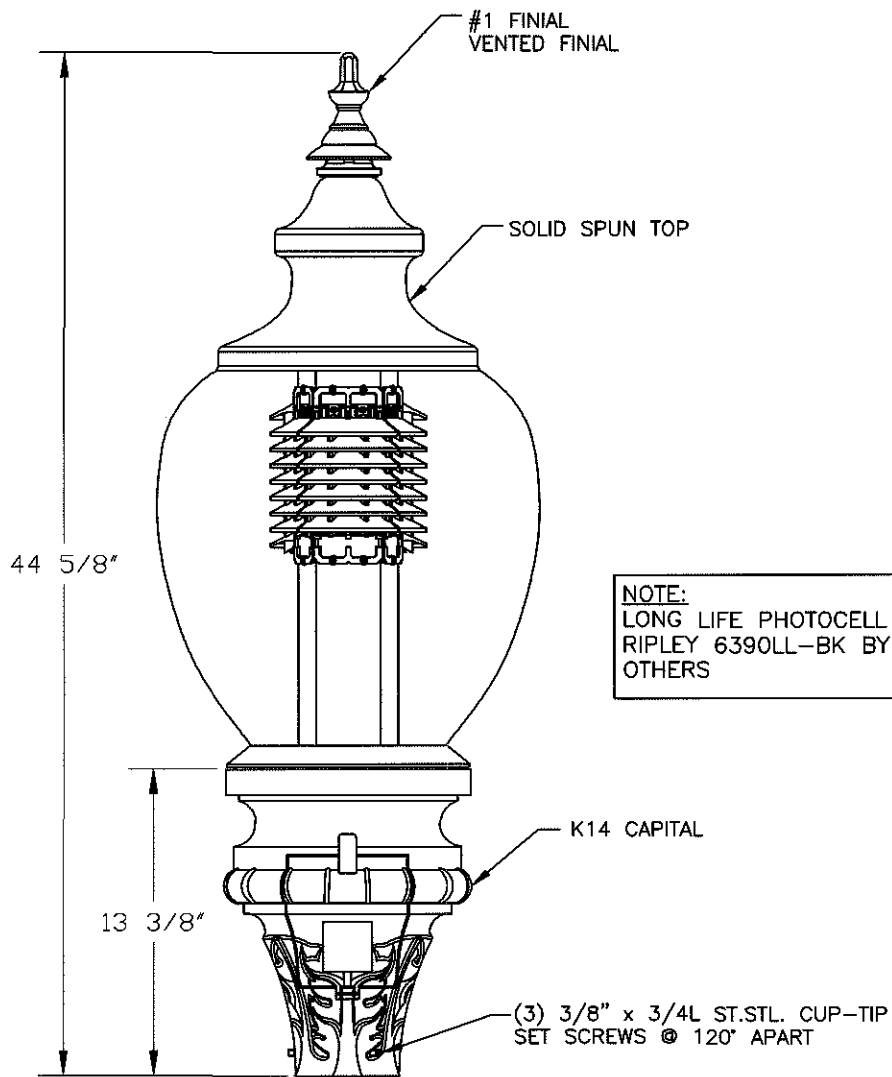

44 5/8"

13 3/8"

TO ACCEPT 3 1/2" O.D.
3 1/2" LONG TENON

NOTE:
LONG LIFE PHOTOCELL
RIPLEY 6390LL-BK BY
OTHERS

REV.	ALTERATION	DATE	BY
A	NOT ADDED	04/19/16	T.B
B	LONG LIFE PHOTOCELL SPECIFIED AS 6390LL-BK BY RIPLEY LIGHTING CONTROLS.	5/3/16	M.Y
C	OPTICS WAS R1AR WITH TYPE III DISTRIBUTION	06/06/16	T.B

LUMINAIRE SPECIFICATIONS

CATALOGUE NO.: K118R-B3AR-IV-60(SSL)
-1036-120:277V-K14-PR7-SST

QUANTITY:
POLE ADAPTOR: K14
OPTICAL SYSTEM: BAFFLED ARRAY ACRYLIC RIPPLED
IES LTG. CLASS.: TYPE IV
INPUT WATTS: 60W
SOLID STATE LIGHTING

SERIES: 1036
CCT / DIODE: 4000K / HE5
LINE VOLTAGE: 120:277V
PAINT: TEXTURED BLACK
OPTIONS: C/W SOLID SPUN TOP &
7-PRONG TWISTLOCK PHOTOCELL
RECEPTACLE ANSI STANDARD
C136.41 (PHOTO-EYE BY OTHERS)

OPTIONS



QUICK DISCONNECT

NOTE:

"NOTE THAT THIS FIXTURE IS BY DEFAULT SHIPPED IN 'NON-ADAPTIVE MODE'. THE FIXTURE IS FIELD SWITCHABLE TO 'ADAPTIVE-MODE' IF ADAPTIVE TECHNOLOGY IS TO BE UTILIZED. NOTE THAT SWITCHING TO 'ADAPTIVE MODE' MAY INCREASE THE NOMINAL INPUT POWER OF THE FIXTURE. PLEASE CONTACT THE FACTORY FOR FURTHER DETAILS"

CUSTOMER APPROVAL & DATE:

CUSTOMER ORDER No:
STRESSCRETE ORDER No:
KMFG. ORDER No:
KING U.S. ORDER No:

  King Luminaire • StressCrete • Est. 1953 STRESSCRETE GROUP	Manufacturing Locations: Burlington, Ontario 1-800-268-7809 Northport, Alabama 1-800-435-8563 Atchison, Kansas 1-800-837-1024 Jefferson, Ohio 1-800-268-7809
	PROJECT/CUSTOMER: CITY OF CAMAS, WA
DRAWN BY: TASHI B. AT: SC1 CHECKED BY: DATE: 02/29/16 REVISION: C	DRAWING TYPE: APPROVAL/MFG. DWG. DRAWING NUMBER: CAMAS-1

Catalog Number:

Date:

Project:

OVERVIEW

With a design life of 20+ years and superior in-rush current and surge-protection features, the DLL Elite support the extended life and low maintenance benefits associated with LED fixtures.

FEATURES

APPLICATIONS

- LED lighting fixtures that require dusk to dawn control
- High inrush current fixtures
- Designed to last as long as your LED lighting system, 20 + years
- LED inrush protection with triac assisted relay
- Extreme surge protection of 1280J/40kA utility or 2120J/40kA UL listed
- Double thick enclosure and lens with additional UV inhibitor
- High temp base plastic tested to 140°C
- Long life capacitors
- Full wave rectified power supply
- Dual zener diodes for long life
- Solid brass contact blades
- Double sided, thru hole plated .062" FR4 circuit board
- Conformal coated printed circuit board
- Sealed packaging for extended storage

SPECIFICATIONS

REGULATORY LISTINGS

- ANSI C136.10
- ROHS compliant
- UL listed to U.S. and Canadian safety standards
- Surge rated in excess of ANSI C136.10 to 20kV/10kA

OPERATING CHARACTERISTICS

- Voltage 120 to 480 VAC, 60Hz
- Load rating: 1000 watts, 1800 VA ballast
- Average power consumption: <0.5 watts @ 120V

Warranty

Ten-year limited warranty. Complete warranty terms located at:

www.acuitybrands.com/CustomerResources/Terms_and_conditions.aspx

Note: Actual performance may differ as a result of end-user environment and application.

Specifications subject to change without notice.



DTL®

DLL Elite

Electronic Locking Type Photocontrol



DIMENSIONS

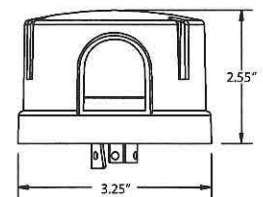

DLL STANDARD COLORS

	Non-UL	UL
120-277V	Green	Blue
347V	Green	Green
480V	Yellow	Yellow

ORDERING INFORMATION

DLL PHOTOCONTROL							Example: DLL127 1.5 J50
Series & Voltage	Failure Mode	Turn-On Level (fc)	Filter	Certification	Cover Color	Pkg. Qty.	
DLL127 120-277V	[blank] Fail On	1.5 ANSI Std.	[blank] Std. Operation	[blank] Std.	[blank] Std. ¹	JU 1 Unit	
DLL347 340V	F Fail Off		IR IR Filtered Silicon	CUL CULus	BK Black ²	J12 12 Units	
DLL480 480V					BR Brown ²	J50 50 Units	
					GR Green ²		
					GY Gray ²		
					BL Blue ²		
					YL Yellow ²		

NOTES

1. No color substitutions for UL models.

2. Non-standard custom colors are non-stock items. Available in J12 and J50 only. Consult customer service.

DTL-DLL

PART EIGHT

APPENDICES

APPENDIX A

SAMPLE UNIT PRICED CONTRACT
QUOTE FORM

CITY OF CAMAS
Unit Priced Contract Quote Form

Project Title and Number	Project Lead	Contractor/Vendor:	Contract Term
Purchase Order # (P.O.)	Manager	Department/Division	Purchase Order Date
P.O. Total	Contract Balance	Delivery/Completion (est. Calendar Days)	Contract Amount Remaining
			0.00

Project Name: _____

Scope of Work: _____

Item	Discription	QTY	Contrated Unit Price	Total
1				\$0.00
2				\$0.00
3				\$0.00
4				\$0.00
5				\$0.00
6				\$0.00
7				\$0.00
8				\$0.00
9				
10				
SUBTOTAL (Parts and Materials):				\$0.00
Tax:				\$0.00
Shipping/Handling/Mobilization:				Included
PROJECT TOTAL:				\$0.00
Retainage Amount :				\$0.00
PAYMENT AMOUNT:				\$0.00

*** Approval Authority ***

Contractor

Where this project quote cannot be accommodated on this form; use as a cover, noting "See Attached" in the appropriate spaces above. Any substitute format must include all elements of this form for item of work.

APPENDIX B

GENERAL ENCROACHMENT PERMIT



**GENERAL ENCROACHMENT PERMIT
APPLICATION INSTRUCTIONS**

A general encroachment permit is required for construction or maintenance activity within the public right-of-way (ROW). Per CMC 12.12.010.

1. Check the type of encroachment activity, at the top of page 1 of the General Encroachment Permit form. An explanation of types of general encroachment activities are listed below (#4).
2. Complete the following contact information:
 - Application Information: This is the owner of the property to be worked on or the equipment to be installed.
 - Contractor Information: All work in the right-of-way must be done by a licensed and bonded contractor. The contractor's business and contact information goes here.
 - Agent Information: If the applicant is using a third party, such as an engineering consultant to apply for the permit, their contact information would be included.
 - Job Site Information: Address and a brief description of the work to be done.
3. Submit the completed 'General Encroachment Permit' form on page 1. Sign and date the 'Standard Conditions' on page 2. Include the following items for a complete submittal:
 - Project plans or Sketch;
 - Traffic Control Plan (TCP), if required;
 - Contractor's estimate of work and material costs, including traffic control (if applicable).

The completed form and applicable items can be email to the Building Department at permits@cityofcamas.us. For questions or payments, call 360.817.1568.

4. General encroachment fees are calculated based on the current City fee schedule. (CMC 12.12.020)
 - 2021 Base fee: \$35.00 for estimate of work less than \$1,500.00
 - Fee for work estimated at \$1,500.00 or greater: \$30.00 plus 2.5% of estimate of work
5. Types of Permits:
 - Sidewalk-Driveway-Tree Applies to removal & replacement of existing sidewalks, driveway approaches, street trees or trees in the right-of-way, and retrofitting of existing driveway approaches.
 - Other Work in ROW Applies to any of the following activities in the ROW: temporary placement of dumpsters and/or PODs, tents, material storage, potholing, etc.
 - Site Developments Applies to new construction for subdivisions, short plats, commercial, industrial, multi-family, duplexes, tri-plexes, 4-plexes, etc. For use by Development Engineering. To be submitted at pre-construction meetings, along with the signed Insurance Requirements form and a Certificate of Insurance Liability. See Item #6 below for additional documentation requirements.
6. Additional Documentation for Site Developments:
 - General Encroachment Permit, including Standard Conditions (ESC/Construction Debris Cleanup & Indemnification and Hold Harmless Agreement)
 - Insurance Requirements Form, with *Certificate of Insurance* attached.
Insurance requirements shall include the following liabilities:



**GENERAL ENCROACHMENT PERMIT
APPLICATION INSTRUCTIONS**

- 1) **Commercial General Liability** insurance of a least \$1,000,000 per occurrence and no less than \$2,000,000 general aggregate, and \$2,000,000 products-completed operations aggregate limit, naming the City of Camas as an additional insured. Coverage shall not exclude explosion, collapse and underground (XCU) where applicable. Coverage shall include, but not be limited to, contractual, completed operations and stop gap (employer's) liability.
- 2) **Automobile Liability** insurance with a minimum combined single limit for bodily injury and property damage of \$1,000,000 per accident.

Applicant to provide a copy of endorsement: ISO Additional Insured, State or Political Subdivisions, Permits CG 20 12 005 09, or a substitute endorsement providing equivalent or better coverage.

Additional Information:

Per CMC Section 12.12.040: Any person, firm or corporation engaged in any kind of work which tends to obstruct the streets, highways or public places, or which takes place within the city's right-of-way may, in lieu of the certificate of liability insurance, provide an annual insurance certificate in such amount as may be fixed by the Director of Public Works and approved by the City Attorney.



GENERAL ENCROACHMENT PERMIT FORM

Submit via email: permits@cityofcamas.us

616 NE 4th Ave, Camas, WA 98607
 Questions Call: 360.817.1568

City Permit Number

- SIDEWALK-DRIVEWAY-TREE REMOVE & REPLACE
- OTHER WORK IN ROW (E.G. DUMPSTERS, PODS, TENTS, MATERIAL STORAGE, ETC.)
- SITE DEVELOPMENTS – ENGINEERING USE ONLY (E.G. SUBDIVISIONS, SP, COMMERCIAL, ETC.)

Engineering Inspection Requests:
 Call 360.834.8860, Option 2

Date Submitted: _____

APPLICANT INFORMATION

Owner or Business _____

Address _____

City _____ State _____ Zip _____

Contact Name _____ Title _____

Phone _____ Email _____

Applicant Project No. (if applicable)

CONTRACTOR / AGENT INFORMATION

Company Name _____

Address _____

City _____ State _____ Zip _____

Contact Name _____ Title _____

Phone _____ Email _____

W.C.L. # _____ Expires _____ Tax ID Number _____

Contractor / Agent Project No. (if applicable)

JOB SITE INFORMATION

Work Location / Address: _____

Description of Work: _____

_____ Pavement Cut(s) Plans Attached Value of work and material in right-of-way: \$ _____

_____ Sidewalk Cut(s) TCP Attached

Project Start Date _____ End Date _____

Signed _____ Date _____

Initial & Date Page 2
 On Reverse Side

SITE REQUIREMENTS (if applicable)

<input type="checkbox"/> Engineering Plan Req'd	<input type="checkbox"/> Drawings Rec'd	Approved By: _____	Date Approved: _____
<input type="checkbox"/> Traffic Control Plan Req'd	<input type="checkbox"/> TCP Received	Approved By: _____	Date Approved: _____
<input type="checkbox"/> Standard Conditions Signed & Attached / on File		Permit Fee \$ _____	
<input type="checkbox"/> Special Conditions Attached		Other Fees \$ _____	
<input type="checkbox"/> Fee(s) Paid	NOTE: Permit is not valid until paid.	Total Fees \$ _____	

CITY USE ONLY

Receipt Number _____ By _____ Date Paid _____

Approved by: _____ Date Approved: _____ Expires: _____

EROSION SEDIMENT CONTROL / CONSTRUCTION DEBRIS CLEANUP & DISPOSAL

The applicant (or owner's representative) acknowledges by signing this Permit that he/she has read the contents of Section 14.06 Erosion Control Plan and Section 15.36 Construction Debris Cleanup and Disposal of the Camas Municipal Code. The applicant agrees to familiarize himself/herself with the applicable City of Camas standards, specifications, codes, and ordinances and will abide by the same. The applicant understands that nonconformance with these documents may result in rejection, removal of the work, "stop work orders"; and the costs associated with the same will be the responsibility of the applicant. The applicant is assuming all responsibility of constructing the improvements in compliance with City of Camas standards, specification, and ordinances.

The City requires all flag persons on City streets or right of ways to be certified by the State of Washington per WAC 296-155-305.

Excavators shall notify pipeline operator immediately if their work damages a pipeline and to call 911 or other local emergency response numbers immediately if the damage results in a release of natural gas or other hazardous substance or potentially endangers life, health, or property.

I understand that it is my responsibility to ensure all persons involved in this project comply with the requirements of the Camas Municipal Code.

Applicant's Initial: _____ Date: _____

INDEMNIFICATION AND HOLD HARMLESS AGREEMENT

The Applicant/Contractor shall defend, indemnify and hold the City of Camas, its officers, officials, employees and volunteers harmless from any and all claims, injuries, damages, losses or suits including attorney fees, arising out of or in connection with the performance of this Permit, except for injuries and damages caused by the sole negligence of the City of Camas.

Should a court of competent jurisdiction determine that this Agreement is subject to RCW 4.24.115, then in the event of liability for damages arising out of bodily injury to persons or damages to property caused by or resulting from the concurrent negligence of the Applicant/Contractor and the City, its officers, officials, employees, and volunteers, the Applicant/Contractor's liability hereunder shall be only to the extent of the Applicant/Contractor's negligence. It is further specifically and expressly understood that the indemnification provided herein constitutes the Applicant/Contractor's waiver of immunity under Industrial Insurance, Title 51 RCW, solely for the purposes of this indemnification. This waiver has been mutually negotiated by the parties. The provisions of this section shall survive the expiration or termination of this Permit.

Applicant's Initial: _____ Date: _____



Certificate of Insurance Attached.

Date Submitted: _____

Expiration Date: _____

**ENCROACHMENT PERMIT
INSURANCE REQUIREMENTS
(Required for Permanent Structures & Site Developments)**

Applicant to provide certificate of insurance evidencing:

1) Commercial General Liability insurance of at least \$1,000,000 per occurrence and no less than \$2,000,000 general aggregate, and \$2,000,000 products-completed operations aggregate limit, naming the City of Camas as an additional insured. Coverage shall not exclude explosion, collapse and underground (XCU) where applicable. Coverage shall include, but not be limited to, contractual, completed operations and stop gap (employer's) liability.

2) Automobile Liability insurance with a minimum combined single limit for bodily injury and property damage of \$1,000,000 per accident.

Applicant to provide a copy of endorsement: ISO Additional Insured, State or Political Subdivisions, Permits CG 20 12 005 09, or a substitute endorsement providing equivalent or better coverage.

Per CMC Section 12.12.040: Any person, firm or corporation engaged in any kind of work which tends to obstruct the streets, highways or public places, or which takes place within the city's right-of-way may, in lieu of the certificate of liability insurance, provide an annual insurance certificate in such amount as may be fixed by the Director of Public Works and approved by the City Attorney.

Company / Agency Name: _____

Annual Certification (Keep on File)

Permit Specific – Permit No. _____



GENERAL ENCROACHMENT PERMIT

Certificate of Insurance Attached.

Date Submitted: _____

Expiration Date: _____

INSURANCE REQUIREMENTS

Applicant to provide certificate of insurance evidencing:

1) Commercial General Liability insurance of at least \$1,000,000 per occurrence and no less than \$2,000,000 general aggregate, and \$2,000,000 products-completed operations aggregate limit, naming the City of Camas as an additional insured. Coverage shall not exclude explosion, collapse and underground (XCU) where applicable. Coverage shall include, but not be limited to, contractual, completed operations and stop gap (employer's) liability.

2) Automobile Liability insurance with a minimum combined single limit for bodily injury and property damage of \$1,000,000 per accident.

Applicant to provide a copy of endorsement: ISO Additional Insured, State or Political Subdivisions, Permits CG 20 12 005 09, or a substitute endorsement providing equivalent or better coverage.

Additional Information:

Per CMC Section 12.12.040: Any person, firm or corporation engaged in any kind of work which tends to obstruct the streets, highways or public places, or which takes place within the city's right-of-way may, in lieu of the certificate of liability insurance, provide an annual insurance certificate in such amount as may be fixed by the Director of Public Works and approved by the City Attorney.

Company / Agency Name: _____

Annual Certification (Keep on File)

Permit Specific – Permit No. _____