



LICENSE REQUEST: SIDEWALK ALCOHOL SERVICE
LICENSE RENEWAL - Expires: May 31,

PETITION TO THE TOWN COUNCIL

To the Honorable Town Council of the Town of Bristol:
The undersigned hereby respectfully requests of
your Honorable Body to be granted a

SIDEWALK ALCOHOL SERVICE LICENSE RENEWAL

NAME OF ESTABLISHMENT: Pearl Holdings, LLC d/b/a The Nest

ADDRESS: 29 State Street, Bristol, RI 02809

APPLICANT NAME: Pearl Holdings, LLC

HOURS OF OPERATION: 11 am to 1 am

- Sidewalk Use License Petition
- Certificate of Liability Insurance
- Food/Alcohol Sales Ratio Affidavit (must be notarized)
- Sketch of area planned for use
- 4th Quarter taxes must be paid (call 253-7000 for amount due)

MAY 13 11 51 AM '26
TOWN OF BRISTOL

Please attend the Council Meeting on

MAY 13, 2026

Petition must be returned by

APR 27, 2026

Petition mailed on

Date Received: _____

*SIGNATURE: _____

NAME: Pearl Holdings, LLC by Andrew Breslin

ADD _____

TOW _____

DATE _____

BUSI _____

HOM _____

EMAIL _____

TAX STAMP

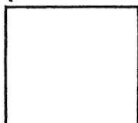

TO BE USED BY FINANCE DEPARTMENT

*BY SIGNING THIS PETITION, I CONSENT TO THE
RELEASE OF RECORDS AND INFORMATION REGARDING MY
BACKGROUND, INCLUDING POLICE RECORDS, EDUCATIONAL
INFORMATION, RESIDENCE RECORDS, AND ANY COURT RECORDS.

PEARL HOLDGINS, LLC (formerly Tinkers)

THE NEST

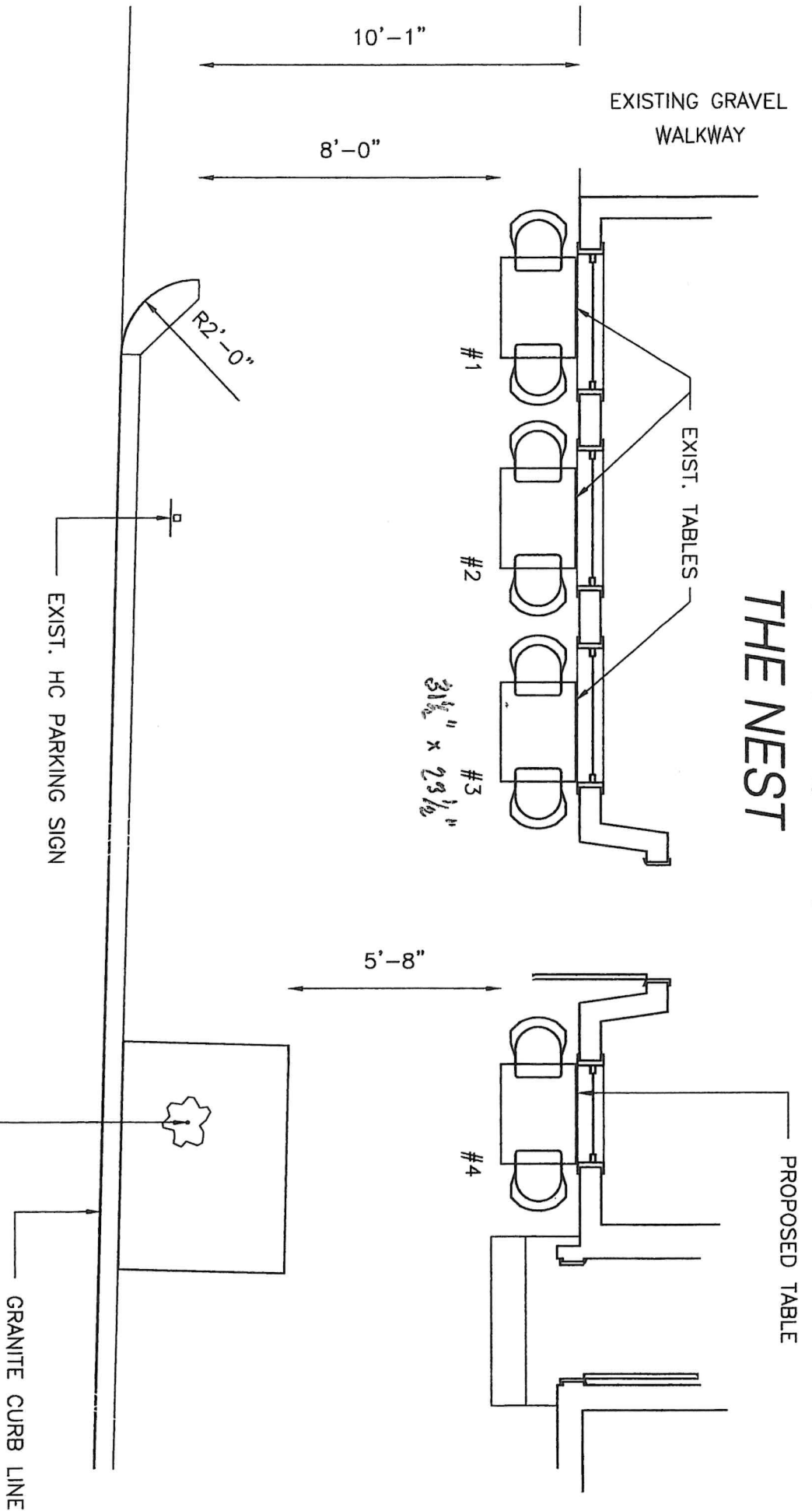

- STATE STREET -

29 State Street, Bristol, RI 02809





LICENSE REQUEST: SIDEWALK ALCOHOL SERVICE
LICENSE RENEWAL - Expires: May 31,

PETITION TO THE TOWN COUNCIL

To the Honorable Town Council of the Town of Bristol:
The undersigned hereby respectfully requests of
your Honorable Body to be granted a

SIDEWALK ALCOHOL SERVICE LICENSE RENEWAL

NAME OF ESTABLISHMENT: *Bristol House of Pizza*

ADDRESS: *55 STATE ST*

APPLICANT NAME: *Gregory Gatros*

HOURS OF OPERATION: *11-10*

FEE \$100-

- Sidewalk Use License Petition
- Certificate of Liability Insurance
- Food/Alcohol Sales Ratio Affidavit (must be notarized)
- Sketch of area planned for use
- 4th Quarter taxes must be paid (call 253-7000 for amount due)

Please attend the Council Meeting on

MAY 13, 2026

Petition must be returned by

APRIL 29, 2026

Petition mailed on

*SIGNATURE: _____

NAME: _____

Gregory Gatros

ADD _____

TOW _____

DAT _____

BUS _____

HOU _____

EM _____

Date Received: _____

TAX STAMP



TO BE USED BY FINANCE DEPARTMENT

*BY SIGNING THIS PETITION, I CONSENT TO THE
RELEASE OF RECORDS AND INFORMATION REGARDING MY
BACKGROUND, INCLUDING POLICE RECORDS, EDUCATIONAL
INFORMATION, RESIDENCE RECORDS, AND ANY COURT RECORDS.

2026 APR 30 AM 10:07
TOWN OF BRISTOL
RHODE ISLAND

Hope

St.

ramp

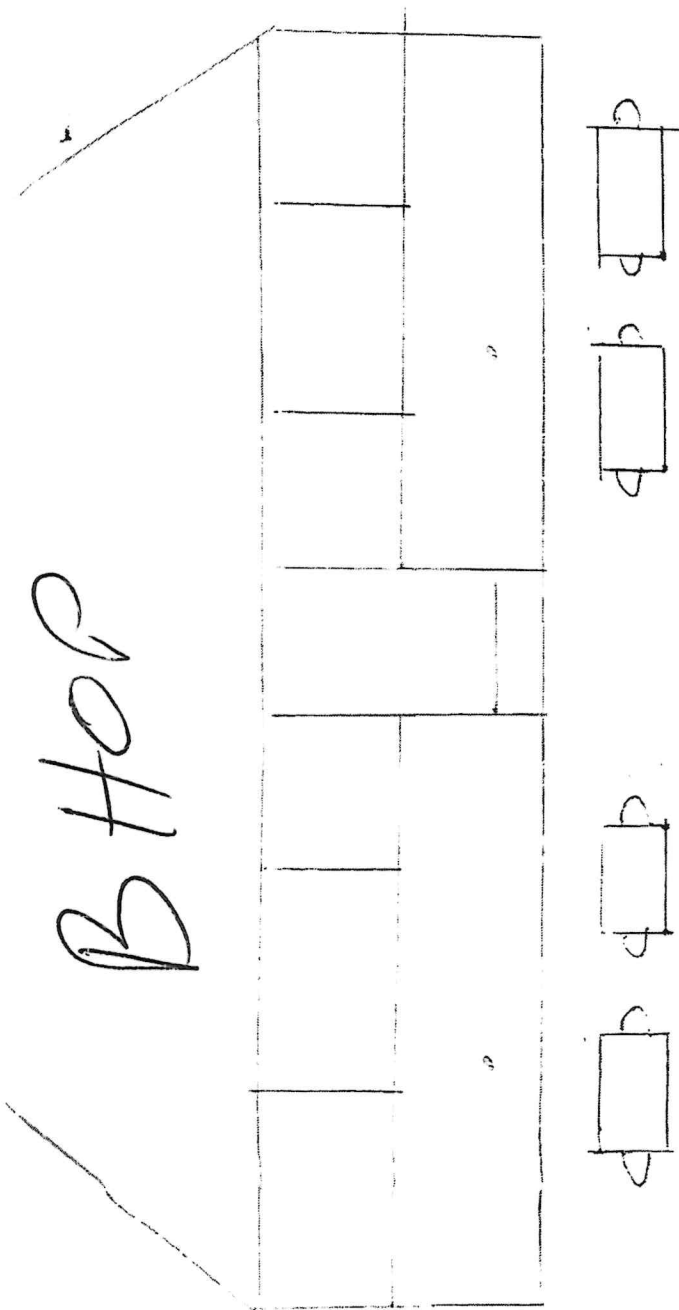

BHOP

Drive way

state st



LICENSE REQUEST: SIDEWALK ALCOHOL SERVICE
LICENSE RENEWAL - Expires: May 31,

PETITION TO THE TOWN COUNCIL

To the Honorable Town Council of the Town of Bristol:

The undersigned hereby respectfully requests of
your Honorable Body to be granted a

SIDEWALK ALCOHOL SERVICE LICENSE RENEWAL

NAME OF ESTABLISHMENT: *Foglia*

ADDRESS: *31 STATE STREET*

APPLICANT NAME: *PETER CARVELLI*

HOURS OF OPERATION: *THURSDAY - MONDAY 5p.m. - 9p.m.*

FREE \$100-

- Sidewalk Use License Petition
- Certificate of Liability Insurance
- Food/Alcohol Sales Ratio Affidavit (must be notarized)
- Sketch of area planned for use
- 4th Quarter taxes must be paid (call 253-7000 for amount due)

Please attend the Council Meeting on

MAY 13, 2026

Petition must be returned by

APRIL 29, 2026

Petition mailed on

*SIGNATURE: _____

NAME: _____

Peter Carvelli

AI

TC

DI

BL

HC

EM

Date Received: _____

TAX STAMP

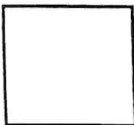

TO BE USED BY FINANCE DEPARTMENT

*BY SIGNING THIS PETITION, I CONSENT TO EXAMINATION AND RELEASE OF RECORDS AND INFORMATION REGARDING MY BACKGROUND, INCLUDING POLICE RECORDS, EDUCATIONAL INFORMATION, RESIDENCE RECORDS, AND ANY COURT RECORDS.

RECEIVED
TOWN CLERK'S OFFICE
MAY 13 2026

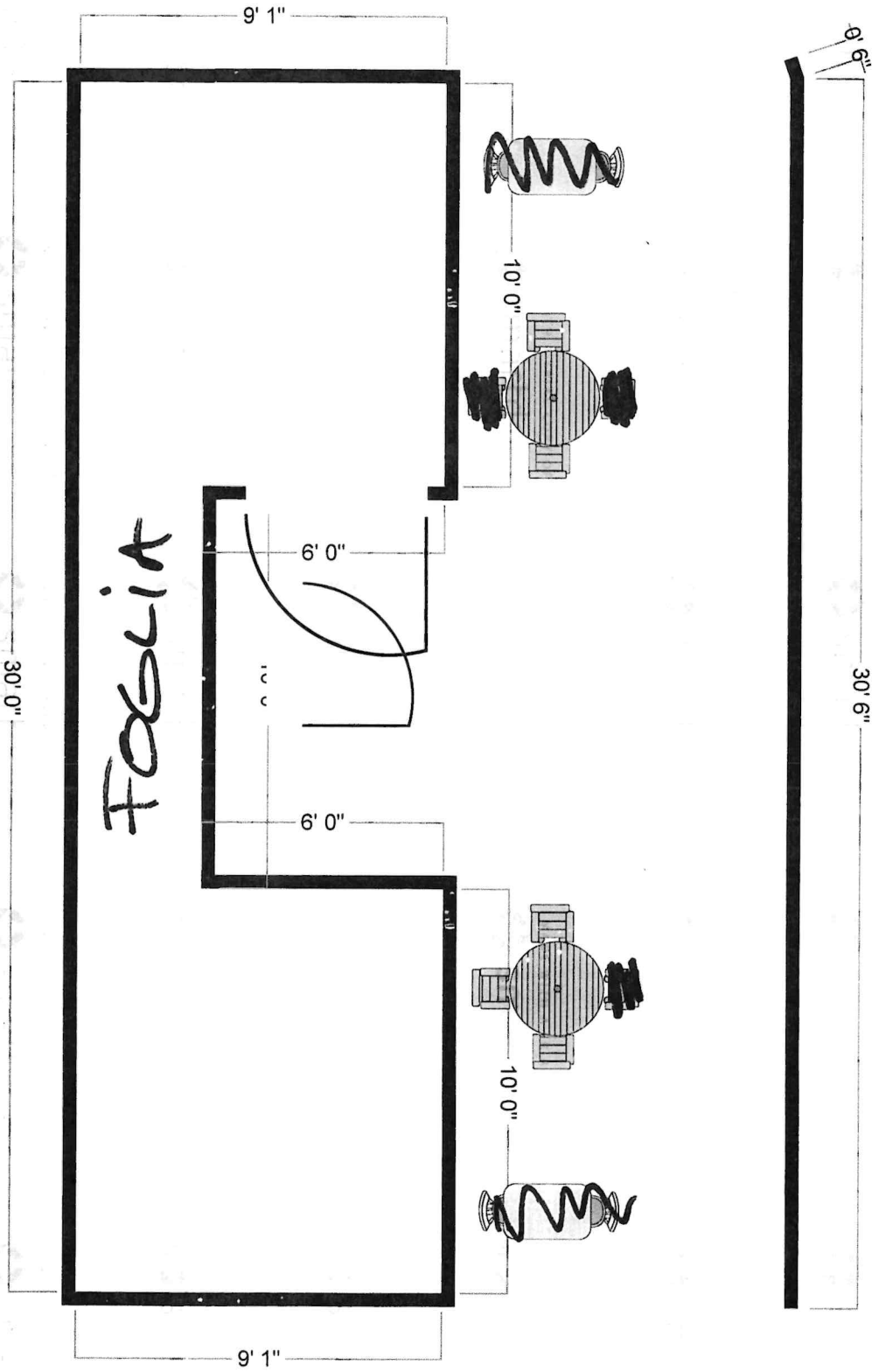



LICENSE REQUEST: SIDEWALK ALCOHOL SERVICE
LICENSE RENEWAL - Expires: May 31,

PETITION TO THE TOWN COUNCIL

To the Honorable Town Council of the Town of Bristol:
The undersigned hereby respectfully requests of
your Honorable Body to be granted a

SIDEWALK ALCOHOL SERVICE LICENSE RENEWAL

NAME OF ESTABLISHMENT: *Judge Roy Bean Saloon*

ADDRESS: *1 State Street*

APPLICANT NAME: *CRUZ GALER*

HOURS OF OPERATION: *W-Sun - 11:30 - 1pm*

FEE *M & T - 5pm - 1am*

- Sidewalk Use License Petition
- Certificate of Liability Insurance
- Food/Alcohol Sales Ratio Affidavit (must be notarized)
- Sketch of area planned for use
- 4th Quarter taxes must be paid (call 253-7000 for amount due)

2026 APR 29 11:01
TOWN OF BRISTOL

Please attend the Council Meeting on

MAY 13, 2026

Petition must be returned by

APRIL 29, 2026

Petition mailed on

*SIGNATURE: *[Signature]* - *CRUZ GALER*

NAME: *Korcia Culmy Consulting DBA Judge Roy*

AD
TO
DA
BU
HO
EM

Date Received: _____

TAX STAMP

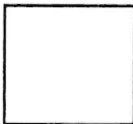

TO BE USED BY FINANCE DEPARTMENT

*BY SIGNING THIS PETITION, I CONSENT TO EXAMINATION AND RELEASE OF RECORDS AND INFORMATION REGARDING MY BACKGROUND, INCLUDING POLICE RECORDS, EDUCATIONAL INFORMATION, RESIDENCE RECORDS, AND ANY COURT RECORDS.

Submitted

sidewalk 11 wide

5' clear

Emergency Exit

Judge Roy
Bean
Saloon

4' wide
clear path
for Egress

Front Door

State Street

Scale = 1 Block = 1 Foot

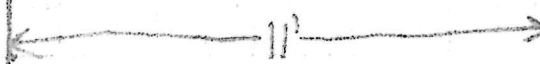
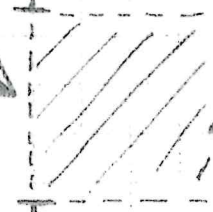

1 Block = 1 Foot

Thomas Street





LICENSE REQUEST: SIDEWALK ALCOHOL SERVICE
LICENSE RENEWAL - Expires: May 31,

PETITION TO THE TOWN COUNCIL

To the Honorable Town Council of the Town of Bristol:
The undersigned hereby respectfully requests of
your Honorable Body to be granted a

SIDEWALK ALCOHOL SERVICE LICENSE RENEWAL

NAME OF ESTABLISHMENT: Leo's Ristorante

ADDRESS: 365 Hope St.

APPLICANT NAME: Paul Mancieri

HOURS OF OPERATION: Tue-Thu 12:00pm - 8:00pm
Fri-Sat 12:00pm - 9:00pm
Sun 12:00pm - 8:00pm

FEE

- Sidewalk Use License Petition
- Certificate of Liability Insurance
- Food/Alcohol Sales Ratio Affidavit (must be notarized)
- Sketch of area planned for use
- 4th Quarter taxes must be paid (call 253-7000 for amount due)

Please attend the Council Meeting on

May 13, 2026

Petition must be returned by

April 29, 2026

Petition mailed on

Date Received: _____

*SIGNATURE: _____

NAME: Paul Mancieri

ADD _____

TOW _____

DATE _____

BUSI _____

HOM _____

EMA _____

TAX STAMP



TO BE USED BY FINANCE DEPARTMENT

*BY SIGNING THIS PETITION, I CONSENT TO THE
RELEASE OF RECORDS AND INFORMATION REGARDING MY
BACKGROUND, INCLUDING POLICE RECORDS, EDUCATIONAL
INFORMATION, RESIDENCE RECORDS, AND ANY COURT RECORDS.

2026 APR 29 PM 2:10

104-44-2026
2026 APR 29 PM 2:10



LICENSE REQUEST: **SIDEWALK ALCOHOL SERVICE**
LICENSE RENEWAL - Expires: May 31,

PETITION TO THE TOWN COUNCIL

To the Honorable Town Council of the Town of Bristol:
The undersigned hereby respectfully requests of
your Honorable Body to be granted a

SIDEWALK ALCOHOL SERVICE LICENSE RENEWAL

NAME OF ESTABLISHMENT: *ROBERTUS RESTAURANT AND CAFE*

ADDRESS: *450 Hope ST.*

APPLICANT NAME: *Paula Palumbo*

HOURS OF OPERATION: *8-3 Mon - Sun*

FEE \$100 *5-9-T-Thy* *5-10 FRI/SAT*

- Sidewalk Use License Petition
- Certificate of Liability Insurance
- Food/Alcohol Sales Ratio Affidavit (must be notarized)
- Sketch of area planned for use
- 4th Quarter taxes must be paid (call 253-7000 for amount due)

2026 MAY -1 PM 12:01
JANUARY 2026

Please attend the Council Meeting on
MAY 13, 2026
Petition must be returned by
APRIL 29, 2026
Petition mailed on

*SIGNATURE: *Paul A. Palumbo*
NAME: *PAUL A. PALUMBO*

Date Received: _____

TAX STAMP

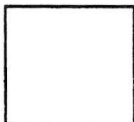

TO BE USED BY FINANCE DEPARTMENT

*BY SIGNING THIS PETITION, I CONSENT TO EXAMINATION AND RELEASE OF RECORDS AND INFORMATION REGARDING MY BACKGROUND, INCLUDING POLICE RECORDS, EDUCATIONAL INFORMATION, RESIDENCE RECORDS, AND ANY COURT RECORDS.









LICENSE REQUEST: SIDEWALK ALCOHOL SERVICE

LICENSE RENEWAL - Expires: May 31,

PETITION TO THE TOWN COUNCIL

To the Honorable Town Council of the Town of Bristol:

The undersigned hereby respectfully requests of your Honorable Body to be granted a

SIDEWALK ALCOHOL SERVICE LICENSE RENEWAL

NAME OF ESTABLISHMENT:

Bristol Sunset Cafe

ADDRESS:

499 Hope St.

APPLICANT NAME:

Fabio Lopes

HOURS OF OPERATION:

7:30 AM TO 2PM.

- Sidewalk Use License Petition
- Certificate of Liability Insurance
- Food/Alcohol Sales Ratio Affidavit (must be notarized)
- Sketch of area planned for use
- 4th Quarter taxes must be paid (call 253-7000 for amount due)
- FEE \$100-

Please attend the Council Meeting on

May 13, 2026

Petition must be returned by

April 29, 2026

Petition mailed on

Date Received: _____

*SIGNATURE:

[Handwritten Signature]

NAME:

Fabio Lopes

- A
- T
- C
- B
- F
- E

TAX STAMP



TO BE USED BY FINANCE DEPARTMENT

*BY SIGNING THIS PETITION, I CONSENT TO EXAMINATION AND RELEASE OF RECORDS AND INFORMATION REGARDING MY BACKGROUND, INCLUDING POLICE RECORDS, EDUCATIONAL INFORMATION, RESIDENCE RECORDS, AND ANY COURT RECORDS.







SUNSET CAFE

Window

Window

Double Fire
Upstairs

FRONT
Door



10 1/2 Feet

9 Feet

SIDEWALK

CURB

HOPE STREET

NEW
SIDEWALK
CAMP

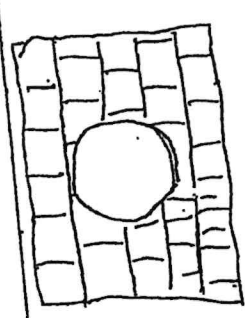



LICENSE REQUEST: SIDEWALK ALCOHOL SERVICE

LICENSE RENEWAL - Expires: May 31,

PETITION TO THE TOWN COUNCIL

To the Honorable Town Council of the Town of Bristol:
The undersigned hereby respectfully requests of
your Honorable Body to be granted a

SIDEWALK ALCOHOL SERVICE LICENSE RENEWAL

NAME OF ESTABLISHMENT: FOLKLORE PROVISIONS

ADDRESS: 301 HOPE ST. BRISTOL, RI 02809

APPLICANT NAME: ELI DUNN

HOURS OF OPERATION: WED 8 - 2 P.M. / THUR 8 - 2 P.M. 5 P.M. - 9 P.M.

- Fee \$100
- Certificate of Liability Insurance
- Food/Alcohol Sales Ratio Affidavit (must be notarized)
- Sketch of area planned for use
- 4th Quarter taxes must be paid (call 253-7000 for amount due)

FRI 8 - 2 P.M. 5 P.M. - 9 P.M. / SAT 8 - 2 P.M. 5 P.M. - 9 P.M.
SUN 9 A.M. - 2 P.M.

2026 MAY -1 AM 11:50
TOWN CLERK
BRISTOL, RHODE ISLAND

Please attend the Council Meeting on

*SIGNATURE: [Signature]

Petition must be returned by

NAME: ELI DUNN

Petition mailed on

- ADC
- TC
- DA
- BU
- HC
- EM

Date Received: _____

TAX STAMP

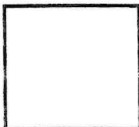

TO BE USED BY FINANCE DEPARTMENT

*BY SIGNING THIS PETITION, I CONSENT TO EXAMINATION AND RELEASE OF RECORDS AND INFORMATION REGARDING MY BACKGROUND, INCLUDING POLICE RECORDS, EDUCATIONAL INFORMATION, RESIDENCE RECORDS, AND ANY COURT RECORDS.

SIDEWALK/HOPE ST.

FRONT OF ORIGINAL SPACE ENTRANCE FRONT OF NEW DINING AREA

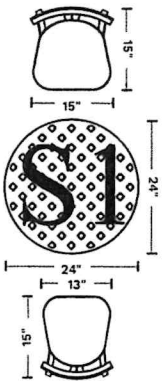
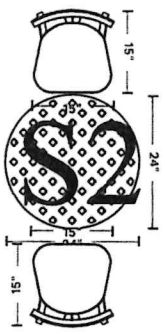
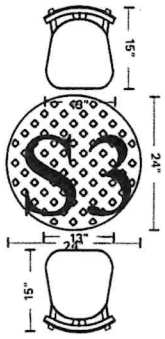
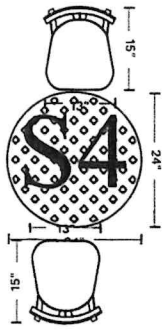

spods



