

<p>RECORDING REQUESTED BY: CITY CLERK</p> <p>WHEN RECORDED RETURN TO:</p> <p>City Clerk City of Beaumont 550 E. 6th Street Beaumont, CA 92223</p>	<p>SPACE ABOVE THIS LINE FOR RECORDER'S USE</p>
--	---

**CITY OF BEAUMONT
SUBDIVISION IMPROVEMENT AGREEMENT
TRACT NO. 31462-25**

DATE OF AGREEMENT: <u>March 7th, 2022</u>		
NAME OF SUBDIVIDER: <u>Meritage Homes of California, Inc., a California Corporation</u> . (hereinafter referred to as "Subdivider").		
NAME/NUMBER OF DEVELOPMENT: <u>PA 22D</u> subdivision consisting of <u>54</u> residential lots, _____, originally approved on _____, and Tentative Tract <u>31462</u> ("Tract" or "Tentative Tract Map"), originally approved on <u>September 8th, 2016</u> .		
FINAL TRACT MAP _____ APPROVED ON _____ RECORDED ON _____ AS INSTRUMENT NUMBER: _____ ("Final Tract Map").		
PROPERTY SUBJECT TO AGREEMENT: The real property which is the subject of this Agreement is located in the City of Beaumont, County of Riverside and is described in Exhibit "A" attached hereto and incorporated herein (hereinafter the "Property").		
EST. TOTAL COST OF PUBLIC IMPROVEMENTS: \$ <u>\$433,473.60</u> (see Exhibit "B")	EST. TOTAL COST OF PRIVATE IMPROVEMENTS: \$ _____ (see Exhibit "B")	EST. TOTAL COST OF MONUMENTATION: \$ _____ (see Exhibit "B")
BOND NUMBERS: <u>Bond No. 30148215 for PA 22D Street Improvements</u>		
LETTER OF CREDIT NUMBERS: _____		

FINANCIAL INSTITUTION: _____

THIS SUBDIVISION IMPROVEMENT AGREEMENT ("Agreement") is made and entered into by and between the City of Beaumont, a California municipal corporation (hereinafter referred to as "City"), and Meritage Homes of California, Inc., a California Corporation, (hereinafter referred to as "Subdivider"). City and Subdivider are sometimes referred to hereinafter individually as a "Party", and collectively as the "Parties".

RECITALS

A. Subdivider is the owner of certain real property located in the City of Beaumont legally described on Exhibit "A" attached hereto and incorporated and made part of this Agreement by this reference (the "Property").

B. The conditions of approval of the above referenced Tentative Tract Map and any related entitlements, which are hereby incorporated herein by this reference, require that prior to the issuance of building permits, the Subdivider and the City shall enter into a subdivision improvement agreement, secured with sufficient security, as a guarantee of the construction and completion of all public and private improvements and land development work required by said conditions of approval and by the City subdivision laws and codes.

D. In consideration of the approval of a final map by the City Council, Subdivider desires to enter into this Agreement, whereby Subdivider promises to install and complete, at Subdivider's own expense, all the public improvement work required by City in connection with the proposed subdivisoion. Subdivider has secured this Agreement by improvement security required by the Subdivision Laws.

E. Improvement Plans (the "Plans") for the construction, installation, and completion of the public and private improvements are being or have been prepared by Subdivider and will be subject to approval by the Director of Engineering/Public Works ("City Engineer"). The City has adopted standards (hereinafter "Standards") for the construction and installation of improvements within the City, and the Plans will be prepared in conformance with the Standards in effect on the date of the approval of the Application. The Plans will be on file in the Office of the City Engineer and are incorporated into this Agreement by this reference as if set forth fully herein. All references in this Agreement to the Plans shall be deemed to include reference to any specifications for all of the improvements as approved by the City Engineer.

F. An estimate of the cost for construction of the public and private improvements and performing the land development work according to the Plans has been made and approved by the City Engineer. The estimated cost of these improvements is set forth on Page One (1) of this Agreement, and the basis for the estimate is attached hereto as Exhibit "B" and incorporated and

made part of this Agreement by this reference. The amounts of the Improvement Securities required to be posted with this Agreement are also based upon the estimate in Exhibit "B".

G. For the purposes of this Agreement, the term "Public Improvements" means all those improvements within the Tract intended for transfer or conveyance to the City or other public agency. The estimated cost of their construction is included in the above estimate included herein as Exhibit "B".

NOW, THEREFORE, in consideration of the issuance of the Final Tract map, Subdivider and City hereby agree as follows:

1. Subdivider's Obligation to Construct Improvements.

(a) In constructing and installing the improvements, Subdivider shall comply with all of the requirements and conditions of approval of in the Tentative Tract Map, related entitlements as well as the provisions of the Municipal Code and Subdivision Laws.

(b) Subdivider shall complete, at its own expense, all the public and private improvements and related work on the Development, as required by the conditions of approval of the Tentative Map and related entitlements in conformance with the approved Plans and City Standards, including without limitation, those improvements set forth in Exhibit "B" (hereinafter collectively the "Improvements") within twenty-four (24) months of the date of this Agreement, unless a time extension is granted by the City as authorized by Section 20 of this Agreement.

(c) Notwithstanding the time limits specified in Section 1(b) above, no single family dwelling unit or group of units shall be given final inspection and clearance for occupancy by City unless the private and public streets providing access to and fronting such units are completed, the final lifts of pavement on the streets are in place, and all wet and dry utility services (e.g. sewer, water, electrical power, telephone, gas, etc.) to such units are in place and are operational.

(d) Subdivider shall furnish the necessary materials for completion of the Improvements in conformity with the Plans and City Standards.

(e) Subdivider shall acquire and dedicate, or pay the cost of acquisition by the City, of all right-of-way, easements and other interests in real property required for construction or installation of the Improvements, free and clear of all liens and encumbrances. Subdivider's obligations relating to acquisition by City of off-site rights-of-way, easements and other interests in real property shall be subject to a separate agreement between Subdivider and City. Subdivider shall also be responsible for obtaining any public or private drainage easements or authorizations therefor to accommodate the Development.

(f) Subdivider shall furnish and install all monuments, stakes and property corners on the lots and streets in the Property as specified on the final recorded tract maps for the Development in accordance with the provisions of the Subdivision Laws, and shall submit centerline tie sheets to City, within thirty (30) days after completion of the Improvements, or as

specified in any separate monument agreement with the City, but in any event prior to their acceptance by the City.

2. Improvement Securities.

(a) Subdivider agrees to secure this Agreement with good and sufficient improvement securities in a form approved by the City Attorney (referred collectively hereinafter as "Improvement Securities" and individually as "Improvement Security") to guarantee the construction and completion of all the improvements in the Development. All such improvement securities shall be posted with the City prior to the City's final building inspection and issuance of a Certificate of Occupancy for any single family dwelling constructed by Subdivider, its agents, assigns or contractors, on any lot within the Development, as described in Exhibit "A". Said securities are estimated at this time in Exhibit "B" to be in the following amounts, and shall be for the purposes described as follows:

(i) \$433,473.60 and 00/100 DOLLARS (\$XXX,XXX.XX) to ensure faithful performance of the construction and installation of the public and private Improvements required by this Agreement ("Performance Security"), which amount is 100% of the estimated cost of the Improvements as set forth in Exhibit "B"; and

(ii) _____ and 00/100 DOLLARS (\$XXX,XXX.XX) to secure payment to any contractor, subcontractor, persons renting equipment or furnishing labor materials for the Improvements required to be constructed or installed pursuant to this Agreement ("Labor & Materials Security"), which amount is one-hundred percent (100%) of the estimated cost of the Improvements; and

(iii) _____ and 00/100 DOLLARS (\$ XX,XXX.XX) in the form of a Warranty Bond or cash deposit with the City to guarantee or warranty the Improvement work done pursuant to this Agreement for a period of one (1) year following acceptance/certification thereof by City, against any defective work or labor done or defective materials furnished ("Warranty Security"). The Warranty Security is 10% of the estimated cost of the Performance Security amount described above, and such Warranty Security must be provided by Subdivider to City prior to the City's release of any bonds or Improvement Securities filed with this Agreement.

(iv) _____ and 00/100 Dollars (\$X,XXX.XX) in the form of a cash deposit, which is 100% of the estimated cost of setting all final subdivision monuments, boundary corners, front and rear lot corners and centerline ties not previously set or submitted on the lots and streets within the Property as described in Exhibit "A", and for the preparation and recordation of any related Certificate of Correction, as required by Section 66469 of the State Subdivision Map Act.

(b) The Improvement Securities required by this Agreement shall be kept on file with the City Clerk. If surety bonds are used, they must be issued by a surety company currently admitted to transact surety insurance business in California by the California Department of

Insurance, with a Best's Insurance Guide rating of no less than A-. The terms of any documents evidencing such Improvement Securities as set forth in this Section 2 or referenced on Page One (1) of this Agreement, are incorporated into this Agreement by this reference as if set forth fully herein. If any Improvement Security is replaced by another type or kind of approved Improvement Security, subject to the approval of the form thereof by the City Attorney, the replacement shall be filed with City Clerk and, upon filing, shall be deemed to have been made a part of and incorporated into this Agreement. Upon filing of a satisfactory replacement Improvement Security with the City Clerk, the former Improvement Security shall be released.

(c) Subdivider agrees to keep its Improvement Securities in full force and effect until they are reduced or released by City. If any Improvement Security provided by Subdivider is cancelled or terminated for any reason by the action of a surety, financial institution or other party, it shall be the responsibility of the Subdivider to immediately, upon written notice from City, provide a substitute Improvement Security which conforms to all the requirements of this Section 2 in the same amount or amounts.

(d) Any additions, changes, alterations, or modifications of this Agreement or to the Plans, Specifications and Improvements referred to herein, including any extension of time within which the work hereunder may be completed, shall not release or exonerate any surety or sureties on the Improvement Security given in connection with this Agreement.

3. Alterations to Improvement Plans; Modification of City Standards.

(a) Any changes, alterations or additions to the Plans or to the Improvements, not exceeding 10% of the original estimated cost of the Improvements, which are mutually agreed upon by City and Subdivider, shall not require Subdivider to increase any Improvement Securities provided under this Agreement. In the event such changes, alterations, or additions exceed 10% of the original estimated cost of the Improvements, Subdivider shall provide additional Performance Security as required by Section 2 of this Agreement for 100% of the total estimated cost of the Improvements as changed, altered, or amended, minus any completed partial releases allowed by Section 7 of this Agreement. Subdivider shall also provide additional Labor & Materials Security as required by Section 2 of this Agreement for 50 % of the total estimated cost of the Improvements as changed, altered, or amended.

(b) Subdivider shall construct all Improvements in a good and workman like manner and in accordance with the City Standards in effect as of the date of the Approval Action specified on Page One (1) hereof. The City reserves the right to modify the Standards applicable to the Subdivision and this Agreement, when necessary to protect the public safety or welfare or to comply with applicable State or Federal law or City zoning ordinances. If Subdivider requests and is granted an extension of time for completion of the Improvements, the City may apply the Standards in effect at the time the extension is granted.

4. Modification of Drainage Plan. Subdivider agrees that if during the course of construction and installation of Improvements it shall be determined by the City Engineer that

revision of the drainage plan is necessary in the public interest, it will undertake such design and construction changes as may be reasonable and as are indicated by the City Engineer and approved by City. Said changes, if any, shall be confined to the Property.

5. Reserved.

6. Inspections; Final Acceptance and Certification of Improvements.

(a) Subdivider shall at all times maintain proper facilities and safe access for inspection of the Improvements by City inspectors and to the shops wherein any work is in preparation.

(b) Upon completion of the Improvements covered in this Agreement, the Subdivider shall request a final inspection by the City Engineer or his/her authorized representative. Following receipt of such request, the City Engineer shall inspect the Improvements, make certain determinations and take certain actions as follows:

(i) If the City Engineer, or his/her authorized representative, determines that the Public Improvements requiring acceptance by another public agency have been completed in accordance with this Agreement, then the City Engineer shall request said agency to make a final inspection of such improvements and certify to the City that such improvements have been completed and installed to the satisfaction of said agency. Upon receipt of such certification, the City Engineer may release or reduce the securities held for such improvements. Any certification and/or acceptance of the Public Improvements shall not constitute a waiver of any defects by City.

(ii) For Improvements not requiring dedication to or acceptance by the a public agency (the "Private Improvements"), the City Engineer or his/her authorized representative shall inspect such improvements, and/or shall have the discretion to accept a certification from Subdivider's registered civil engineer stating that the Private Improvements have been completed in accordance with the approved Plans, City Standards and the Tentative Map. If the City Engineer, or his/her authorized representative, makes a finding, based on his/her own inspection (and/or any certification submitted by Subdivider's registered civil engineer) that the Private Improvements have been installed and constructed in accordance with the approved Plans, City Standards and the Tentative Map, the City Engineer shall recommend certification of the completion of the Private Improvements by placing an item on the next most convenient City Council agenda requesting certification and authorization to release the Improvement Securities. Said determination by the City Engineer and agendization of the certification and release shall not be unreasonably withheld or delayed.

(c) Subdivider shall bear all costs of inspection and certification of the Improvements.

7. Release of Improvement Securities.

(a) The Performance Security shall be fully released only upon the final completion and certification of all Private Improvements and Public Improvements. Partial releases may be

permitted subject to the provisions of Subsections (a)(i) and (a)(ii) hereof. Upon final completion of the Public and Private Improvements under this Agreement, and after City Council acceptance/certification, the City shall file a Notice of Completion in accordance with the California Civil Code.

(i) The City Engineer may release a portion of the Performance Security, as work on the Improvements progresses, upon written application thereof by the Subdivider; provided, however, that no such release shall be considered by City for an amount less the cost estimate of the remaining work does not exceed twenty percent (20%) or less of the estimate of the total amount of work to be done as shown in Exhibit "B". Upon approval of a partial release or the reduction of Performance Security, the City shall not reduce such Performance Security to an amount less than two-hundred- percent (200%) of the value of the work remaining to be done. City and Subdivider agree that not more than two requests for reduction or partial release of Performance Security shall be considered between the start of construction and the completion and acceptance/certification of the Improvements by the City.

(ii) In no event shall the City Engineer authorize a release or reduction of the Performance Security which would reduce such security to an amount below that required to guarantee the completion of the Improvements and any other obligations imposed upon Subdivider by this Agreement.

(iii) No partial reduction or release of the Performance Security shall constitute or be construed as the City's acceptance or certification of any Improvements or related work. Such partial reductions or releases (if any) will merely reflect that a certain portion of the required work has been done.

(b) The Labor & Materials Security shall, ninety (90) days after the City's recordation of the Notice of Completion described in Subsection 7(a), be reduced to an amount equal to the total claimed by all claimants for whom liens have been filed and of which notice has been given to City, plus an amount reasonably determined by the City Engineer to be required to assure the performance of any other obligations secured by the Labor & Materials Security and to cover related legal costs. The balance shall be released upon the settlement of all claims and obligations for which the Labor & Materials Security was given. If no claims or liens have been filed and no notice has been given to City within said ninety (90) day period, then the Labor & Materials Security shall be released in full.

(c) The Warranty Security shall not be released until after the expiration of the one-year (1-year) warranty period and until any claims filed during the warranty period have been settled. As provided in Section 11, below, the warranty period shall not commence until final acceptance/certification of the Improvements and related work by the City Council.

(d) The Monumentation Security may be released in full by the City Engineer in accordance with the terms of the separate monument agreement with the City, or if there is none, upon submittal of the following:

(i) a written certification from the professional engineer or surveyor responsible for setting the monuments stating that all the final monuments for the Subdivision have been set in accordance with the Professional Land Surveyors Act and the Subdivision Map Act, and that the professional engineer or surveyor has been paid in full by Subdivider for such services; and

(ii) centerline tie sheets prepared in a manner acceptable to the City Engineer showing the locations of centerline monuments in existing public or private streets; and

(iii) any Record of Survey required by this Agreement has been filed with the County of Riverside and recorded.

(e) The City may retain from any Improvement Securities released an amount sufficient to cover costs and reasonable expenses and fees, including reasonable attorneys' fees.

8. Injury to Public Improvements, Public Property or Public Utilities Facilities.

Subdivider shall replace or repair, or cause the repair or replacement of any and all public or private improvements, public utilities facilities and survey or subdivision monuments which are destroyed or damaged as a result of any work under this Agreement. Subdivider shall bear the entire cost of replacement or repairs of any and all public or private improvements or utility property damaged or destroyed by reason of any work done under this Agreement, whether such property is owned by the United States or any agency thereof, or the State of California, or any agency or political subdivision thereof, or by the City or any public or private utility corporation or by any combination of such owners. Any repair or replacement shall be made to the reasonable satisfaction, and subject to the approval of the City Engineer and the owner of any such public or private improvement.

9. Permits. Subdivider shall, at Subdivider's expense, obtain all necessary permits and licenses for the construction and installation of the Improvements, give all necessary notices and pay all fees and taxes required by law.

10. Notice of Breach/Default of Subdivider.

(a) Default of Subdivider shall include, but not be limited to: (1) Subdivider's failure to timely complete construction of the Improvements; (2) Subdivider's unwarranted failure to timely cure any defect in the Improvements; (3) Subdivider's failure to perform substantial construction work for a period of twenty (20) consecutive calendar days after commencement of the work; (4) Subdivider's insolvency, appointment of a receiver, or the filing of any petition in bankruptcy either voluntary or involuntary which Subdivider fails to discharge within thirty (30) days; (5) the commencement of a foreclosure action against the Property or a portion thereof, or any conveyance in lieu or in avoidance of foreclosure; (6) Subdivider's failure to keep the Improvement

Securities in full force and effect; (7) Subdivider's failure to notify the City of any sale, transfer or other disposition of the Property to a purported new Subdivider; (8) Subdivider's failure to maintain insurance; or (9) the failure of Subdivider or Subdivider's contractors, subcontractors, agents or employees to comply with any other terms and provisions of this Agreement.

(b) In the event of any such default, the City Engineer or the City Council may serve written notice to Subdivider specifying in reasonable detail the nature of the default. Subdivider shall have thirty (30) days from receipt of said notice to cure the default; provided that, if the default is not reasonably susceptible to being cured within said thirty (30) days, Subdivider shall have a reasonable period of time to cure the default so long as Subdivider commences to cure the default within said thirty (30) days and diligently prosecutes the cure to completion.

(c) If following service of such written notice of default, Subdivider fails to cure or commence curing the default to the satisfaction of City within the cure period specified in Subsection 10(b), above, the City Engineer or the City Council may serve notice of Subdivider's default upon Subdivider and where applicable Subdivider's surety, or the holder(s) of any other Improvement Securities, in accordance with the notice provisions set forth in Section 22 of this Agreement.

(d) In the event of service of the notice of default specified in Subsection 10(c), above, Subdivider's surety shall have the duty to take over and complete the Improvements and related work required under this Agreement; provided; however, that if the surety, within twenty (20) days after the serving upon it of such notice of default, does not give the City written notice of its intention to take over the construction of said Improvements or does not, within ten (10) days after giving City notice of such election, commence to complete the Improvements, City may take over the work and prosecute the Improvements to completion, by contract or by any other method City may deem advisable, for the account and at the expense of Subdivider, and Subdivider's surety shall be liable to City for any costs or damages occasioned City thereby; and, in such event, City, without liability for so doing, may take possession of, and utilize in completing the Improvements, such materials, appliances, plant and other property belonging to Subdivider as may be on the site of the work and necessary for the completion of same.

(e) The City reserves to itself all remedies available to it at law or in equity for Subdivider's default under this Agreement. The City shall have the right, subject to this Section, to draw upon or utilize the appropriate Improvement Securities to mitigate City's damages in event of default by Subdivider. The right of City to draw upon or utilize the Improvement Securities is additional to and not in lieu of any other remedy available to City. It is specifically recognized that the estimated costs and amounts of Improvement Securities may not reflect the actual cost of construction or installation of the Improvements, and therefore, City's damages for Subdivider's default shall be measured by the actual cost of completing the required Improvements. The sums provided by the Improvement Securities may be used by City for the completion of the Improvements in accordance with the Plans.

(f) Failure of Subdivider to comply with the terms of this Agreement, including but not limited to, construction of all the Improvements as set forth herein and as required by the Tentative Map, shall constitute Subdivider's consent to: (1) the filing by City of a notice of violation against all of the lots in the Subdivision; (2) withholding of Building permits, utility connections and/or Certificates of Occupancy. The remedies provided by this Subsection (f) are in addition to and not in lieu of any other remedies available to City at law or in equity. Subdivider agrees that the choice of remedy or remedies for Subdivider's default or breach shall be in the sole discretion of City.

(g) In the event that Subdivider fails to perform any obligation hereunder, Subdivider agrees to pay all costs and expenses incurred by City in securing performances of such obligations, including costs of suit and reasonable attorney's fees.

(h) The failure of City to take an enforcement action with respect to a default, or to declare a default or breach, shall not be construed as a waiver of that default or breach, or of any subsequent default or breach of Subdivider. Any failure by the City to enforce any provision of this Agreement shall not be construed as a waiver of the right to compel enforcement of such provision(s) and further shall not act to release any surety from its obligations under this Agreement.

11. Warranty.

(a) For a period of one (1) year after final acceptance/certification by the City Council of the Improvements, Subdivider shall guarantee or warranty all the Improvements against any defective work or labor done or defective materials furnished. If within the warranty period any work relating to the Improvements or any part of thereof furnished, installed, constructed or caused to be done, furnished, installed or constructed by Subdivider fails to fulfill any of the requirements of this Agreement or the Plans, Subdivider shall without delay and without any cost to City, commence to repair or replace or reconstruct any defective or otherwise unsatisfactory part or parts of the work or structure within thirty (30) days of receiving written notice from City of the defect and diligently prosecute the repair or replacement work to completion.

(b) Should Subdivider fail to act promptly or in accordance with the repair/replacement requirements set forth herein, Subdivider hereby authorizes City, at City's option, to perform the repair/replacement work twenty (20) days after mailing written notice to Subdivider and to Subdivider's surety, and Subdivider agrees to pay City for the cost of such work.

(c) Should the City determine that an emergency or a threat to the public safety and welfare exists from the condition of the Improvements which require repairs, replacements or remedial measures to be made before Subdivider can be notified, City may, in its sole discretion, make the necessary repairs or replacements or perform the necessary work and Subdivider shall pay to City the cost of such repairs.

12. **Subdivider Not Agent of City.** Neither Subdivider nor any of Subdivider's agents, officers, employees, or contractors are or shall be considered to be agents of City in connection with the performance of Subdivider's obligations under this Agreement.

13. **Injury to Improvement Work; Risk of Loss.** Until such time as the Public Improvements are accepted by City, Subdivider shall be responsible for and bear the risk of loss to any of the Public Improvements constructed or installed and shall be responsible for the care, maintenance of and any damage to such Public Improvements. Neither City, nor any of its agents, officers or employees shall be liable or responsible for any accident, loss or damage, regardless of cause, happening or occurring to the Public Improvements specified in this Agreement prior to the completion and acceptance of the Public Improvements by City. All such risks shall be the responsibility of and are hereby assumed by Subdivider. Subdivider is responsible for and shall bear the risk of loss for all Private Improvements at all times.

14. **Other Agreements.** Nothing contained in this Agreement shall preclude City from expending monies pursuant to agreements concurrently or previously executed between the Parties, or from entering into agreements with other Subdividers for the apportionment of costs of water and sewer mains, or other improvements, pursuant to the provisions of City ordinances providing therefor, nor shall anything in this Agreement commit to any such apportionment.

15. **Subdivider's Obligation to Warn Public During Construction.** Until final acceptance/certification of the Public Improvements pursuant to Section 6(b)(i), and final certification of construction of the Private Improvements pursuant to Section 6(b)(ii), Subdivider shall give good and adequate warning to the public of each and every dangerous condition existent in said Improvements, and will take all reasonable actions to protect the public from such dangerous conditions in, on or around the work site.

16. **Vesting of Ownership.** Upon acceptance of the Public Improvements and related work on behalf of the City, and after recordation of the Notice of Completion, ownership of the Public Improvements constructed within the Private streets in the Development shall vest in the name of the City, or applicable government agency or utility company, and any improvement constructed on any public street pursuant to this Agreement shall vest in City.

17. **Indemnity/Hold Harmless.**

(a) Neither the City, nor any official, officer, employee, contractor or agent thereof, shall be liable for any injury to persons or property occasioned by reason of the acts or omissions of Subdivider, its agents, subcontractors or employees in the performance of this Agreement. Subdivider hereby agrees to, and shall defend and hold harmless City, its elective and appointive boards, commissions and officers, and its agents, contractors and employees from and against any and all claims, demands, causes of action, damages, costs, expenses, actual attorneys' fees, consultant's fees, expert's fees, losses or liability, in law or in equity, of every kind and nature whatsoever arising out of or in connection with Subdivider's operations, or any subcontractor's operations, to be performed under this Agreement for Subdivider's or subcontractor's tort

negligence including active or passive, or strict negligence, including but not limited to personal injury including, but not limited to bodily injury, emotional injury, sickness or disease, or death to persons and/or damage to property of anyone, including loss of use thereof, caused or alleged to be caused by any act or omission of Subdivider or any subcontractor, or anyone directly or indirectly employed by any of them or anyone for the full period of time allowed by law, with the exception of the sole negligence or willful misconduct of City.

(b) Subdivider's indemnity, defense and hold harmless obligations under this Section 17 are not conditioned or dependent upon whether City, or its elective and appointive boards, commissions and officers, or its agents, contractors and employees, prepared, supplied or reviewed any Plans or related specifications in connection with the Improvements, or whether City or Subdivider has insurance or other indemnification covering any of these matters.

(c) Subdivider's obligation to indemnify, hold harmless and defend City shall extend to injuries to persons and damages to or alleged taking of property resulting from the design or construction of the Improvements. City's acceptance and/or certification of the Improvements shall not constitute an assumption by City of any responsibility or liability for any damage or alleged taking of property referenced herein. City shall not be responsible or liable for the design or construction of the Improvements constructed or installed pursuant to the Plans, unless the particular Improvement design was required by City over the written objection of Subdivider, which objection stated that the Improvement design was potentially dangerous or defective and set forth a safe and feasible alternative design. After City's acceptance/certification of the Improvements, Subdivider shall remain obligated to correct or eliminate all dangerous conditions caused by defects in design or construction; provided, however, that the Subdivider shall not be responsible for routine maintenance. Subdivider acknowledges and agrees that Subdivider shall be responsible and liable for the design and construction of the Improvements and other work done pursuant to this Agreement, and except as may be provided above, City shall not be liable for any acts or omissions in approving, reviewing, checking, correcting or modifying any Plans, or in inspecting, reviewing or approving any work or construction of Improvements. Subdivider's Improvement Securities shall not be required to secure Subdivider's obligations under this Section 17.

18. Sale or Disposition of Subdivision; Assignment.

(a) Subdivider acknowledges and agrees that sale, transfer or other disposition of the Property prior to completion of the Improvements required hereunder will not relieve Subdivider from the obligations set forth in this Agreement, and Subdivider shall be required to notify City sixty (60) days in advance of any sale or transfer of ownership of the Property or any proposed assignment of this Agreement. If Subdivider sells or otherwise transfers the Property to any other person or entity prior to final completion of the Improvements, or wishes to assign this Agreement, Subdivider may request a novation of this Agreement and a substitution of Improvement Securities by the new owner or proposed assignee (hereinafter collectively for purposes of this Section, "Successor"). Subdivider shall be required to provide any documentation reasonably required by City to determine the appropriateness of any proposed Successor.

(b) Any proposed Successor must demonstrate to the City its ability to perform and complete the obligations of Subdivider under this Agreement, as determined by objective standards of financial capability, creditworthiness and experience required for such performance, and the City shall have the right to compel the Successor to disclose all documents, information and other material which, in City's sole reasonable discretion, may establish or tend to establish that the proposed Successor meets the standards specified herein. Following approval by City and full execution of a novation (or other such release or assignment and assumption agreement(s) entered into by Subdivider, Successor and City), posting of satisfactory Improvement Securities and submission of required insurance by Successor, City shall release or reduce the securities posted by Subdivider in accordance with the provisions of such novation and release Subdivider of its obligations under this Agreement. Nothing in the novation (or other such release or assignment and assumption agreement entered into by Subdivider, Successor and City) shall relieve Subdivider of its obligations under any other Section of this Agreement for work or Improvements performed by Subdivider prior to the novation.

19. Time of the Essence. Time is of the essence in this Agreement.

20. Time for Completion of Improvements; Extensions.

(a) Subdivider shall commence and diligently prosecute to completion construction of all the Improvements required by this Agreement. The time for completion of the Improvements as specified in Subsection 1(b) of this Agreement may be extended as permitted by City ordinance. The City Manager may grant an extension of time for such period as may be in the public interest upon the showing of the Subdivider of good cause. Any such extension granted shall be subject to the limitations and conditions set forth in Subsections 20(b) and (c), below, and shall be made by a writing executed by the in a form as approved by the City Attorney.

(b) Any such extension may be granted without notice to Subdivider's surety and shall not affect the validity of this Agreement or release the surety or sureties on any Improvement Securities given for this Agreement. However, City reserves the right to require as part of any extension amendment a written assurance from the surety acceptable to the City Attorney that the Improvement Securities required by Section 2 of this Agreement shall remain enforceable throughout the term of any extension.

(c) The City Manager shall be the sole and final judge as to whether or not good cause has been shown to entitle Subdivider to an extension. In addition, the time for completion of the Improvements shall be extended for any delay resulting from an act of City, or from an act of God, which Subdivider could not have reasonably foreseen, or by storm or inclement weather which prevents the conducting of work, or by strikes, boycotts, similar actions by employees or labor organizations, which prevent the conducting of work, and which were not caused by or contributed to by Subdivider, provided that Subdivider provides City with written notice of the delaying event within fifteen (15) days of the commencement of the delay. In the event of such delaying event, Subdivider shall use all reasonable efforts to remedy same and resume completion of the Improvements as promptly as practicable.

(d) As a condition of granting an extension of time to complete the Improvements required by this Agreement, the City Manager may require Subdivider to furnish new or additional Improvement Securities guaranteeing performance of this Agreement as extended in an increased amount as necessary to compensate for any increase in construction costs as determined by the City Engineer.

21. Notice. All notices required by or provided for under this Agreement shall be in writing and delivered in person or sent by certified or registered mail, postage prepaid and addressed as provided in this Section. Notice shall be effective on the date it is delivered in person, or, if mailed, on the date of deposit in the United States Mail. Notices shall be addressed as follows unless a written change of address is filed with City:

Notice to City: City of Beaumont
550 E. 6th Street
Beaumont, CA 92223
Attn: City Manager

With a Copy to: John Pinkney, Esq.
SBEMP
1800 East Tahquitz Canyon Way
Palm Springs, CA 92262

Notice to Subdivider: Meritage Homes of California, Inc.
5 Peters Canyon Rd, Suite 310
Irvine, CA 92606
Attn: Efreem Joelson

22. Severability. The provisions of this Agreement are severable. If any portion of this Agreement is held invalid by a court of competent jurisdiction, the remainder of the Agreement shall remain in full force and effect unless amended or modified in writing by the mutual consent of the Parties.

23. Captions. The captions of this Agreement are for convenience and reference only and shall not define, explain, modify, limit, exemplify, or aid in the interpretation, construction or meaning of any provisions of this Agreement.

24. Insurance.

(a) Subdivider shall, at all times during the construction of the Improvements, obtain, carry, maintain, and keep in full force and effect, at its sole cost and expense, policies of insurance of the types and in at least the minimum amounts described below:

(i) Commercial General Liability policy with a minimum combined single limit of One Million Dollars (\$1,000,000) for each occurrence and Two Million Dollars (\$2,000,000) in the aggregate for bodily injury, death, personal injury and property damage arising out of or in connection with the activities of the Subdivider and its contractors and subcontractors in performance of the work under this Agreement. Coverage shall be at least as broad as Insurance Services Office Commercial General Liability coverage

(Occurrence Form CG 0001) and shall, in addition to the other coverages specified in this subsection, include coverage for independent contractors, ongoing operations, products and completed operations, contractual liability and personal and advertising injury.

(ii) Commercial Vehicle/Automotive Liability policy covering personal injury and property damage, with minimum limits of One Million Dollars (\$1,000,000) per occurrence, combined single limit, covering any vehicle utilized by Subdivider, its officers, agents, employees, subcontractors or independent contractors in performing the work required by this Agreement.

(iii) Workers' Compensation and Employer's Liability policy for all Subdivider's employees, with Workers' Compensation limits as required by State law and Employer's Liability coverage of \$1,000,000 per accident for bodily injury or disease. In case any work is sublet, Subdivider shall require any contractor or subcontractor similarly to provide Workers' Compensation and Employer's Liability Insurance for all contractor's or subcontractor's employees, unless such employees are covered by the protection afforded by Subdivider.

(1) In case any class of employees engaged in work under this Agreement at the work site(s) is not protected under any Workers' Compensation law, Subdivider shall provide and shall cause each contractor or subcontractor to provide, adequate insurance for the protection of employees not otherwise protected.

(2) Subdivider hereby indemnifies City for any damages or claims resulting from failure of either Subdivider or any contractor or subcontractor to take out or maintain such liability or Workers' Compensation insurance.

(b) Insurer Rating; Acceptability. Except as set forth otherwise herein, the policies required by this Section shall be issued by a California-admitted insurer with a rating of at least a A-; VII in the latest edition of Best's Insurance Guide. A Commercial General Liability policy issued by an insurer that is on the California Department of Insurance's List of Approved Surplus Line Insurers ("LASLI") will be acceptable, if no coverage from an admitted insurer can be obtained by Subdivider, and further provided that such insurer maintains a Best's rating of at least "A-; X" and remains on the LASLI during the term hereof. Workers' Compensation coverage issued by the State Compensation Insurance Fund shall be acceptable if no other coverage can be obtained by Subdivider, and further provided such insurer remains admitted in California and is otherwise financially acceptable to City.

(c) Deductibles. Any deductibles or self-insured retentions must be declared in writing by Subdivider to City and subsequently approved by City prior to its execution of this Agreement and prior to commencement of any work hereunder. At City's option, Subdivider shall either reduce or eliminate the deductibles or self-insured retentions with respect to City, or Subdivider shall procure a bond guaranteeing payment of losses and expenses.

(d) Certificates and Endorsements Verification. Subdivider shall submit to the City original certificates of insurance and endorsements evidencing the coverages required by this Section. The certificates and endorsements for each insurance policy shall be signed by a person authorized by that insurer to bind coverage on its behalf. The City reserves the right to require complete, certified copies of all required insurance policies at any time and/or to require Subdivider to provide reports or status updates to evidence compliance of its contractors and subcontractors with the provisions of this Section.

(e) Required Endorsements.

(i) The Commercial General Liability and Commercial Vehicle/Automotive Liability policies are to contain or be endorsed to contain the following provisions:

(1) Additional Insureds. The City of Beaumont, its officials, officers, employees, agents and independent contractors shall be named as additional insureds with respect to liability arising out of automobiles owned, leased, hired or borrowed by or on behalf of the Subdivider; and with respect to liability arising out of work or operations performed by or on behalf of the Subdivider including materials, parts or equipment furnished in connection with such work or operations.

(2) Primary Insurance. For any claims related to this project, the Subdivider's insurance coverage shall be primary insurance as respects the City of Beaumont, its officials, officers, employees, agents and independent contractors. Any insurance or self-insurance maintained by the City of Beaumont, its officials, officers, employees, agents and independent contractors shall be excess of the Subdivider's insurance and shall not contribute with it. This endorsement is not applicable to the Commercial Vehicle/Automotive Liability Policy.

(3) Waiver of Subrogation. Endorsements waiving all rights of subrogation against the City of Beaumont, its officials, officers, employees, agents and independent contractors shall be provided.

(ii) The Workers' Compensation policy shall be endorsed to waive all rights of subrogation against the City of Beaumont, its officials, officers, employees, agents and independent contractors.

(f) Other Insurance Requirements. All policies required under this Agreement shall contain provisions stating that such policies cannot be canceled or reduced except on at least thirty (30) days prior written notice to Subdivider (ten (10) days' notice for cancellation due to non-payment). Subdivider further agrees to: (1) provide to City copies of any notices relating to cancellation or reduction of insurance within two (2) days of receipt; and (2) cause all certificates of insurance to include language indicating that the issuers or producers of such policies will endeavor to provide copies of any such notices directly to City.

(g) **Commencement of Work.** Subdivider shall not commence work under this Agreement until Subdivider has obtained all insurance required pursuant to this Section, and such insurance has been obtained by Subdivider and approved by City; nor shall Subdivider allow any contractor or subcontractor to commence work on the Improvements until all similar insurance required of the contractor or subcontractor has been obtained. Certificates, endorsements, and where applicable, full copies of policies shall be maintained on file with the City Clerk.

(h) **Higher Limits.** If Subdivider maintains higher limits than the minimums specified in this Section 25, the City requires and shall be entitled to coverage for the higher limits maintained by Subdivider. Any available insurance proceeds in excess of the specified minimum limits of insurance and coverage shall be available to the City.

25. Attorneys' Fees. In the event any action at law or in equity is brought to enforce the terms of this Agreement, the prevailing Party shall be entitled to litigation costs and reasonable attorneys' fees.

26. Incorporation of Recitals. The Recitals to this Agreement are hereby incorporated into in the terms of this Agreement.

27. Entire Agreement. This Agreement constitutes the entire agreement of the Parties and supersedes any prior written or oral agreements between them with respect to the subject matter hereof. All modifications, amendments, or waivers of the terms of this Agreement must be in writing and signed by the appropriate representatives of the Parties.

28. Governing Law; Venue. This Agreement shall be governed by and interpreted in accordance with the laws of the State of California. In the event that suit shall be brought by either Party to this contract, the Parties agree that venue shall be exclusively vested in the State courts of the County of Riverside, California or where appropriate, in the United States District Court, Southern District of California, Riverside, California.

29. Runs with the Land; Recordation.

(a) The Parties agree that the terms and provisions set forth in this Agreement shall be deemed provisions, terms and/or covenants running with the Property in accordance with applicable law, including without limitation, California Civil Code section 1468, and shall pass to and be binding upon the heirs, successors and assigns of the Parties to this Agreement, and on any successor owner of the Property.

(b) The provisions of Subsection 29(a) notwithstanding, Subdivider shall remain jointly and severally liable with its heirs, successors, assigns or successor owners of the Property for the responsibilities and liabilities imposed by this Agreement unless a novation or assignment agreement is executed in accordance with the provisions of Section 18 of this Agreement.

(c) Upon execution, this Agreement shall be recorded in the Official Records of Riverside County, and by such recordation, it is the intention of the Parties to give notice to and bind their successors, heirs and assigns hereto.

30. Authority of Executing Parties. Each person executing this Agreement on behalf of a Party represents and warrants that such person is duly and validly authorized to do so all behalf of the entity it purports to bind and that he/she is authorized to enter into contracts on behalf of Subdivider. The undersigned, on behalf of Subdivider, binds Subdivider, its partners, successors, executors, administrators, and assigns with respect to the terms and provisions of this Agreement.

IN WITNESS WHEREOF, this Agreement is executed by the Parties hereto on the date above first written.

Subdivider:

City:

CITY OF BEAUMONT
a Municipal Corporation

By:  _____

By: _____
City Manager

ATTEST:

City Clerk

APPROVED AS TO FORM:

John Pinkney, City Attorney

APPROVED AS TO CONTENT:

CALIFORNIA ACKNOWLEDGMENT

CIVIL CODE § 1189

A notary public or other officer completing this certificate verifies only the identity of the individual who signed the document to which this certificate is attached, and not the truthfulness, accuracy, or validity of that document.

State of California }
County of Orange }

On March 08, 2022 before me, Andrew Salazar, Notary Public
Date Here Insert Name and Title of the Officer

personally appeared Aaron Talarico
Name(s) of Signer(s)

who proved to me on the basis of satisfactory evidence to be the person(s) whose name(s) is/are subscribed to the within instrument and acknowledged to me that he/she/they executed the same in his/her/their authorized capacity(ies), and that by his/her/their signature(s) on the instrument the person(s), or the entity upon behalf of which the person(s) acted, executed the instrument.

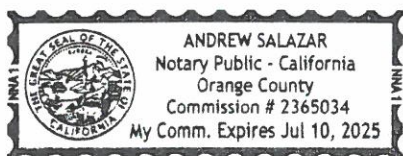

I certify under PENALTY OF PERJURY under the laws of the State of California that the foregoing paragraph is true and correct.

WITNESS my hand and official seal.

Signature [Handwritten Signature]
Signature of Notary Public

Place Notary Seal and/or Stamp Above

OPTIONAL

Completing this information can deter alteration of the document or fraudulent reattachment of this form to an unintended document.

Description of Attached Document

Title or Type of Document: _____

Document Date: _____ Number of Pages: _____

Signer(s) Other Than Named Above: _____

Capacity(ies) Claimed by Signer(s)

Signer's Name: _____ Signer's Name: _____

Corporate Officer – Title(s): _____ Corporate Officer – Title(s): _____

Partner – Limited General Partner – Limited General

Individual Attorney in Fact Individual Attorney in Fact

Trustee Guardian or Conservator Trustee Guardian or Conservator

Other: _____ Other: _____

Signer is Representing: _____ Signer is Representing: _____

Works

Attachments: Exhibit A Legal description of Property
 Exhibit B Cost estimates

(Proper Notarization of Subdivider's Signature is required and shall be attached)

Bond No. 30148215

EXHIBIT "A"

PERFORMANCE BOND

WHEREAS, the City Council of the City of Beaumont, State of California, and _____ Meritage Homes of California, Inc. (hereinafter designated as "Principal") have entered into Agreement To Provide Security For Improvements For Tract Map Or Parcel Map Or Plot Plan, dated _____, 20__, whereby Principal agrees to install and complete certain designated public improvements itemized and described on Tract Map, Parcel Map or Plot Plan No. Tract No. 31462-25, which is hereby incorporated herein and made a part hereof; and

WHEREAS, Principal is required under the terms of the said agreement to furnish a bond for the faithful performance of said agreement.

NOW, THEREFORE, we, the Principal and The Continental Insurance Company, as Surety, are held and firmly bound unto the City of Beaumont (hereinafter called "City"), in the penal sum of Four Hundred Thirty Three Thousand Four Hundred Seventy Three and 60/100 dollars (\$433,473.60) lawful money of the United States, for the payment of which sum well and truly to be made, we bind ourselves, our heirs, successors, executors and administrators, jointly and severally, firmly by these presents.

The condition of this obligation is such that if the above bounded Principal, his or its heirs, executors, administrators, successors or assigns, shall in all things stand to and abide by, and well and truly keep and perform the covenants, conditions and provisions in the said agreement and any alteration thereof made as therein provided, on his or their part to be kept and performed at the time and in the manner therein specified, and in all respects according to their true intent and meaning, and shall indemnify and save harmless the City, its officers, agents and employees as therein stipulated, then this obligation shall become null and void; otherwise it shall be and remain in full force and effect.

As part of the obligation secured hereby and in addition to the face amount specified therefor, there shall be included costs and reasonable expenses and fees, including reasonable attorney's fees, incurred by the City in successfully enforcing such obligation, all to be taxed as costs and included in any judgment therein rendered.

The Surety hereby stipulates and agrees that no change, extension of time, alteration or addition to the terms of the agreement or to the work to be performed thereunder or the specifications accompanying the same shall in any way affect its obligations on this bond, and it does hereby waive notice of any such change, extension of time, alteration or addition to the terms of the agreement or to the work or to the specifications.

[signatures on following page]

IN WITNESS WHEREOF, this instrument has been duly executed by the Principal and Surety above named, on January 21, 2022.

(Seal)

(Seal)

The Continental Insurance Company

Meritage Homes of California, Inc.

SURETY

PRINCIPAL

By: 

By: 

Name: James I Moore

Name: GLEN A. TULK

Title: Attorney-in-Fact

Title: VP-NATIONAL LAND DEVELOPMENT

Address: 151 N. Franklin Street

By: 

Chicago, IL 60606

Name: Hilla Sferrozza

Title: EVP & CFO

Address: 5 Peters Canyon Rd, Ste 310

Irvine, CA 92606

ALL SIGNATURES MUST BE ACKNOWLEDGED BEFORE A NOTARY PUBLIC

ALL-PURPOSE ACKNOWLEDGEMENT

A notary public or other officer completing this certificate verifies only the identity of the individual who signed the document to which this certificate is attached, and not the truthfulness, accuracy, or validity of that document.

STATE OF ARIZONA)SS
COUNTY OF MARICOPA)

On February 1, 2022 before me, Jeanne A. Malys, Notary Public, personally appeared Glen A. Tulk, Vice President - National Land Development of Meritage Homes of California, Inc.

who proved to me on the basis of satisfactory evidence to be the person(s) whose name(s) is/are subscribed to the within instrument and acknowledged to me that he/she/they executed the same in his/her/their authorized capacity(ies), and that by his/her/their signature(s) on the instrument the person(s), or the entity upon behalf of which the person(s) acted, executed the instrument.

I certify under PENALTY OF PERJURY under the laws of the State of Arizona that the foregoing paragraph is true and correct.

WITNESS my hand and official seal.

Signature Jeanne A. Malys

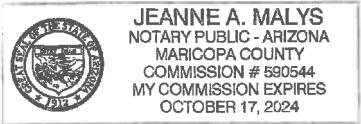

This area for official notarial seal.

**OPTIONAL SECTION - NOT PART OF NOTARY ACKNOWLEDGEMENT
CAPACITY CLAIMED BY SIGNER**

Though statute does not require the Notary to fill in the data below, doing so may prove invaluable to persons relying on the documents.

- INDIVIDUAL
- CORPORATE OFFICER(S) TITLE(S)
- PARTNER(S) LIMITED GENERAL
- ATTORNEY-IN-FACT
- TRUSTEE(S)
- GUARDIAN/CONSERVATOR
- OTHER

SIGNER IS REPRESENTING:

Name of Person or Entity

Name of Person or Entity

OPTIONAL SECTION - NOT PART OF NOTARY ACKNOWLEDGEMENT

Though the data requested here is not required by law, it could prevent fraudulent reattachment of this form.

THIS CERTIFICATE MUST BE ATTACHED TO THE DOCUMENT DESCRIBED BELOW

TITLE OR TYPE OF DOCUMENT: _____

NUMBER OF PAGES _____ DATE OF DOCUMENT _____

SIGNER(S) OTHER THAN NAMED ABOVE _____

ALL-PURPOSE ACKNOWLEDGEMENT

A notary public or other officer completing this certificate verifies only the identity of the individual who signed the document to which this certificate is attached, and not the truthfulness, accuracy, or validity of that document.

STATE OF ARIZONA)
 COUNTY OF MARICOPA)

On February 1, 2022 before me, Jeanne A. Malys, Notary Public, personally appeared

Hilla Sferruzza, Executive Vice President - Chief Financial Officer, Meritage Homes of California, Inc.
 who proved to me on the basis of satisfactory evidence to be the person(s) whose name(s) is/are subscribed to the within instrument and acknowledged to me that he/she/they executed the same in his/her/their authorized capacity(ies), and that by his/her/their signature(s) on the instrument the person(s), or the entity upon behalf of which the person(s) acted, executed the instrument.

I certify under PENALTY OF PERJURY under the laws of the State of Arizona that the foregoing paragraph is true and correct.

WITNESS my hand and official seal.

Signature Jeanne A. Malys

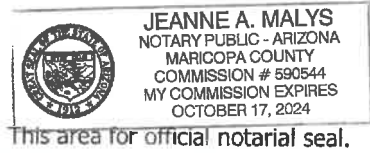

OPTIONAL SECTION - NOT PART OF NOTARY ACKNOWLEDGEMENT CAPACITY CLAIMED BY SIGNER

Though statute does not require the Notary to fill in the data below, doing so may prove invaluable to persons relying on the documents.

- INDIVIDUAL
 CORPORATE OFFICER(S) TITLE(S)
 PARTNER(S) LIMITED GENERAL
 ATTORNEY-IN-FACT
 TRUSTEE(S)
 GUARDIAN/CONSERVATOR
 OTHER

SIGNER IS REPRESENTING:

 Name of Person or Entity

 Name of Person or Entity

OPTIONAL SECTION - NOT PART OF NOTARY ACKNOWLEDGEMENT

Though the data requested here is not required by law, it could prevent fraudulent reattachment of this form.

THIS CERTIFICATE MUST BE ATTACHED TO THE DOCUMENT DESCRIBED BELOW

TITLE OR TYPE OF DOCUMENT: _____

NUMBER OF PAGES _____ DATE OF DOCUMENT _____

SIGNER(S) OTHER THAN NAMED ABOVE _____

STATE OF ILLINOIS

COUNTY OF DUPAGE}

On January 21, 2022, before me, Sinem Nava, a Notary Public in and for said County and State, residing therein, duly commissioned and sworn, personally appeared, James I Moore known to me to be Attorney-in-Fact of The Continental Insurance Company, the corporation described in and that executed the within and foregoing instrument, and known to me to be the person who executed the said instrument in behalf of the said corporation, and duly acknowledged to me that such corporation executed the same.

IN WITNESS WHEREOF, I have hereunto set my hand and affixed my official seal, the day and year stated in this certificate above.

My Commission Expires, August 28, 2025

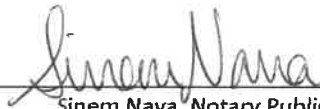

Sinem Nava, Notary Public

Commission No. 859777



POWER OF ATTORNEY APPOINTING INDIVIDUAL ATTORNEY-IN-FACT

Know All Men By These Presents, That The Continental Insurance Company, a Pennsylvania insurance company, is a duly organized and existing insurance company having its principal office in the City of Chicago, and State of Illinois, and that it does by virtue of the signature and seal herein affixed hereby make, constitute and appoint

James I Moore, Stephen T Kazmer, Dawn L Morgan, Melissa Schmidt, Amy Wickett, Kelly A Gardner, Jennifer J Mc Comb, Tariese M Pisciotto, Diane M Rubright, Martin Moss, Individually

of Downers Grove, IL, its true and lawful Attorney(s)-in-Fact with full power and authority hereby conferred to sign, seal and execute for and on its behalf bonds, undertakings and other obligatory instruments of similar nature

- In Unlimited Amounts -

and to bind them thereby as fully and to the same extent as if such instruments were signed by a duly authorized officer of the insurance company and all the acts of said Attorney, pursuant to the authority hereby given is hereby ratified and confirmed.

This Power of Attorney is made and executed pursuant to and by authority of the By-Law and Resolutions, printed on the reverse hereof, duly adopted, as indicated, by the Board of Directors of the insurance company.

In Witness Whereof, The Continental Insurance Company has caused these presents to be signed by its Vice President and its corporate seal to be hereto affixed on this 20th day of June, 2021.



The Continental Insurance Company

Paul T. Bruflat
Paul T. Bruflat Vice President

State of South Dakota, County of Minnehaha, ss:

On this 20th day of June, 2021, before me personally came Paul T. Bruflat to me known, who, being by me duly sworn, did depose and say: that he resides in the City of Sioux Falls, State of South Dakota; that he is a Vice President of The Continental Insurance Company, a Pennsylvania insurance company, described in and which executed the above instrument; that he knows the seal of said insurance company; that the seal affixed to the said instrument is such corporate seal; that it was so affixed pursuant to authority given by the Board of Directors of said insurance company and that he signed his name thereto pursuant to like authority, and acknowledges same to be the act and deed of said insurance company.



My Commission Expires March 2, 2026

M. Bent
M. Bent Notary Public

CERTIFICATE

I, D. Johnson, Assistant Secretary of The Continental Insurance Company, a Pennsylvania insurance company, do hereby certify that the Power of Attorney herein above set forth is still in force, and further certify that the By-Law and Resolution of the Board of Directors of the insurance company printed on the reverse hereof is still in force. In testimony whereof I have hereunto subscribed my name and affixed the seal of the said insurance company this 21st day of January, 2022.



The Continental Insurance Company

D. Johnson
D. Johnson Assistant Secretary

Form F6850-4/2012

Go to www.cnasurety.com > Owner / Obligee Services > Validate Bond Coverage, if you want to verify bond authenticity.

EXHIBIT "B"
PAYMENT BOND

WHEREAS, the City Council of the City of Beaumont, State of California, and Meritage Homes of California, Inc. (hereafter designated as "the Principal") have entered into Agreement To Provide Security For Improvements For Tract Map Or Parcel Map Or Plot Plan, dated _____, 20__, whereby Principal agrees to install and complete certain designated public improvements which is hereby incorporated herein and made a part hereof; and

WHEREAS, under the terms of the said agreement, the Principal is required before entering upon the performance of the work, to file a good and sufficient payment bond with the City of Beaumont to secure the claims to which reference is made in Title 3 (commencing with Section 9000, et seq.) of Part 6 of Division 4 of the Civil Code of the State of California.

NOW, THEREFORE, the Principal and the undersigned as corporate surety, are held firmly bound unto the City of Beaumont and all contractors, subcontractors, laborers, materialmen, and other persons employed in the performance of the said agreement and referred to at Title 3 (commencing with Section 9000, et seq.) of Part 6 of Division 4 of the Civil Code in the sum of Four Hundred Thirty Three Thousand Four Hundred Seventy Three and 60/100 (\$433,473.60) for materials furnished or labor thereon of any kind, or for amounts due under the Unemployment Insurance Act with respect to this work or labor, that the Surety will pay the same in an amount not exceeding the amount hereinabove set forth, and also in case suit is brought upon this bond, will pay, in addition to the face amount thereof, costs and reasonable expenses and fees, including reasonable attorney's fees, incurred by the City in successfully enforcing this obligation, to be awarded and fixed by the court, and to be taxed as costs and to be included in the judgment therein rendered.

It is hereby expressly stipulated and agreed that this bond shall inure to the benefit of any and all persons, companies, and corporations entitled to file claims under Title 3 (commencing with Section 9000, et seq.) of Part 6 of Division 4 of the Civil Code, so as to give a right of action to them or their assigns in any suit brought upon this bond.

Should the condition of this bond be fully performed, then this obligation shall become null and void, otherwise it shall be and remain in full force and effect.

The Surety hereby stipulates and agrees that no change, extension of time, alteration, or addition to the terms of the agreement or the specifications accompanying the same shall in any manner affect its obligations on this bond, and it does hereby waive notice of any such change, extension, alteration, or addition.

[signatures on following page]

IN WITNESS WHEREOF, this instrument has been duly executed by the Principal and Surety above named, on January 21, 2022.

(Seal)

(Seal)

The Continental Insurance Company

Meritage Homes of California, Inc.

SURETY

PRINCIPAL

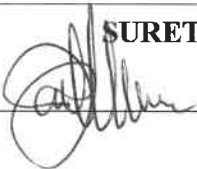
By:  _____

By:  _____

Name: James I Moore

Name: GLEN A. TULK

Title: Attorney-in-Fact

Title: VP-NATIONAL LAND DEVELOPMENT

Address: 151 N. Franklin Street

By:  _____

Chicago, IL 60606

Name: Hilda Sferozza

Title: EVP & CFO

Address: 5 Peters Canyon Rd, Ste 310

Irvine, CA 92606

ALL SIGNATURES MUST BE ACKNOWLEDGED BEFORE A NOTARY PUBLIC

ALL-PURPOSE ACKNOWLEDGEMENT

A notary public or other officer completing this certificate verifies only the identity of the individual who signed the document to which this certificate is attached, and not the truthfulness, accuracy, or validity of that document.

STATE OF ARIZONA)SS
COUNTY OF MARICOPA)

On February 1, 2022 before me, Jeanne A. Malys, Notary Public, personally appeared Glen A. Tulk, Vice President - National Land Development of Meritage Homes of California, Inc.

who proved to me on the basis of satisfactory evidence to be the person(s) whose name(s) is/are subscribed to the within instrument and acknowledged to me that he/she/they executed the same in his/her/their authorized capacity(ies), and that by his/her/their signature(s) on the instrument the person(s), or the entity upon behalf of which the person(s) acted, executed the instrument.

I certify under PENALTY OF PERJURY under the laws of the State of Arizona that the foregoing paragraph is true and correct.

WITNESS my hand and official seal.

Signature Jeanne A. Malys

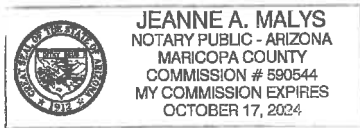

This area for official notarial seal.

**OPTIONAL SECTION - NOT PART OF NOTARY ACKNOWLEDGEMENT
CAPACITY CLAIMED BY SIGNER**

Though statute does not require the Notary to fill in the data below, doing so may prove invaluable to persons relying on the documents.

- INDIVIDUAL
- CORPORATE OFFICER(S) TITLE(S)
- PARTNER(S) LIMITED GENERAL
- ATTORNEY-IN-FACT
- TRUSTEE(S)
- GUARDIAN/CONSERVATOR
- OTHER

SIGNER IS REPRESENTING:

Name of Person or Entity Name of Person or Entity

OPTIONAL SECTION - NOT PART OF NOTARY ACKNOWLEDGEMENT

Though the data requested here is not required by law, it could prevent fraudulent reattachment of this form.

THIS CERTIFICATE MUST BE ATTACHED TO THE DOCUMENT DESCRIBED BELOW

TITLE OR TYPE OF DOCUMENT: _____

NUMBER OF PAGES _____ DATE OF DOCUMENT _____

SIGNER(S) OTHER THAN NAMED ABOVE _____

ALL-PURPOSE ACKNOWLEDGEMENT

A notary public or other officer completing this certificate verifies only the identity of the individual who signed the document to which this certificate is attached, and not the truthfulness, accuracy, or validity of that document.

STATE OF ARIZONA)SS
COUNTY OF MARICOPA)

On February 1, 2022 before me, Jeanne A. Malys, Notary Public, personally appeared Hilla Sferruzza, Executive Vice President - Chief Financial Officer, Meritage Homes of California, Inc.

who proved to me on the basis of satisfactory evidence to be the person(s) whose name(s) is/are subscribed to the within instrument and acknowledged to me that he/she/they executed the same in his/her/their authorized capacity(ies), and that by his/her/their signature(s) on the instrument the person(s), or the entity upon behalf of which the person(s) acted, executed the instrument.

I certify under PENALTY OF PERJURY under the laws of the State of Arizona that the foregoing paragraph is true and correct.

WITNESS my hand and official seal.

Signature Jeanne A. Malys



This area for official notarial seal.

**OPTIONAL SECTION - NOT PART OF NOTARY ACKNOWLEDGEMENT
CAPACITY CLAIMED BY SIGNER**

Though statute does not require the Notary to fill in the data below, doing so may prove invaluable to persons relying on the documents.

- INDIVIDUAL
- CORPORATE OFFICER(S) TITLE(S)
- PARTNER(S) LIMITED GENERAL
- ATTORNEY-IN-FACT
- TRUSTEE(S)
- GUARDIAN/CONSERVATOR
- OTHER

SIGNER IS REPRESENTING:

Name of Person or Entity

Name of Person or Entity

OPTIONAL SECTION - NOT PART OF NOTARY ACKNOWLEDGEMENT

Though the data requested here is not required by law, it could prevent fraudulent reattachment of this form.

THIS CERTIFICATE MUST BE ATTACHED TO THE DOCUMENT DESCRIBED BELOW

TITLE OR TYPE OF DOCUMENT: _____

NUMBER OF PAGES _____ DATE OF DOCUMENT _____

SIGNER(S) OTHER THAN NAMED ABOVE _____

STATE OF ILLINOIS

COUNTY OF DUPAGE}

On January 21, 2022, before me, Sinem Nava, a Notary Public in and for said County and State, residing therein, duly commissioned and sworn, personally appeared, James I Moore known to me to be Attorney-in-Fact of The Continental Insurance Company, the corporation described in and that executed the within and foregoing instrument, and known to me to be the person who executed the said instrument in behalf of the said corporation, and duly acknowledged to me that such corporation executed the same.

IN WITNESS WHEREOF, I have hereunto set my hand and affixed my official seal, the day and year stated in this certificate above.

My Commission Expires, August 28, 2025

Commission No. 859777

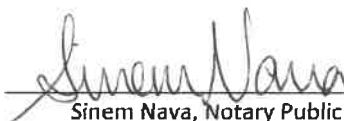
Sinem Nava, Notary Public



POWER OF ATTORNEY APPOINTING INDIVIDUAL ATTORNEY-IN-FACT

Know All Men By These Presents, That The Continental Insurance Company, a Pennsylvania insurance company, is a duly organized and existing insurance company having its principal office in the City of Chicago, and State of Illinois, and that it does by virtue of the signature and seal herein affixed hereby make, constitute and appoint

James I Moore, Stephen T Kazmer, Dawn L Morgan, Melissa Schmidt, Amy Wickett, Kelly A Gardner, Jennifer J Mc Comb, Tariese M Pisciotto, Diane M Rubright, Martin Moss, Individually

of Downers Grove, IL, its true and lawful Attorney(s)-in-Fact with full power and authority hereby conferred to sign, seal and execute for and on its behalf bonds, undertakings and other obligatory instruments of similar nature

- In Unlimited Amounts -

and to bind them thereby as fully and to the same extent as if such instruments were signed by a duly authorized officer of the insurance company and all the acts of said Attorney, pursuant to the authority hereby given is hereby ratified and confirmed.

This Power of Attorney is made and executed pursuant to and by authority of the By-Law and Resolutions, printed on the reverse hereof, duly adopted, as indicated, by the Board of Directors of the insurance company.

In Witness Whereof, The Continental Insurance Company has caused these presents to be signed by its Vice President and its corporate seal to be hereto affixed on this 20th day of June, 2021.



The Continental Insurance Company

Paul T. Bruflat
Paul T. Bruflat Vice President

State of South Dakota, County of Minnehaha, ss:

On this 20th day of June, 2021, before me personally came Paul T. Bruflat to me known, who, being by me duly sworn, did depose and say: that he resides in the City of Sioux Falls, State of South Dakota; that he is a Vice President of The Continental Insurance Company, a Pennsylvania insurance company, described in and which executed the above instrument; that he knows the seal of said insurance company; that the seal affixed to the said instrument is such corporate seal; that it was so affixed pursuant to authority given by the Board of Directors of said insurance company and that he signed his name thereto pursuant to like authority, and acknowledges same to be the act and deed of said insurance company.



My Commission Expires March 2, 2026

M. Bent
M. Bent Notary Public

CERTIFICATE

I, D. Johnson, Assistant Secretary of The Continental Insurance Company, a Pennsylvania insurance company, do hereby certify that the Power of Attorney herein above set forth is still in force, and further certify that the By-Law and Resolution of the Board of Directors of the insurance company printed on the reverse hereof is still in force. In testimony whereof I have hereunto subscribed my name and affixed the seal of the said insurance company this 21st day of January, 2022.



The Continental Insurance Company

D. Johnson
D. Johnson Assistant Secretary

Form F6850-4/2012



CITY OF BEAUMONT PUBLIC WORKS DEPARTMENT
CONSTRUCTION COST WORKSHEET
"PLAN CHECK FEE EST"

PARCEL MAP OR TRACT NO.: Street Improvement Plans - Tract No. 31462-25

DATE: 11/3/2021

PP, CUP NO.: _____ BY: George A. Lenfestey

IMPROVEMENTS	FAITHFUL PERFORMANCE	100%
	LABOR & MATERIALS SECURITY	100%

	Construction Costs)	
Streets/Drainage	\$	433,473.60
Sewer	\$	-
Total	\$	433,473.60
Warranty Retention (22.5%)	\$	97,531.56
Street/Drainage Plan Check Fees =	\$	10,836.84
Sewer Plan Check Fees =	\$	500.00
Street Inspection Fees =	\$	17,338.94
Sewer Inspection Fees =	\$	750.00

DESIGN ENGINEERS CALCULATIONS OF IMPROVEMENT BONDING COSTS

Construction items and their quantities as shown on attached sheets are accurate for the improvements required to construct the above project and the mathematical extensions using City's unit costs are accurate for determining bonding, plan check and inspection costs.

Above amounts do include additional 20% for recordation prior to having signed plans

Above amounts do not include additional 20% for recordation prior to having signed plans

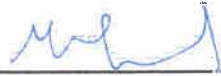

Engineer's Signature

3-Nov-21

Date

George A. Lenfestey

Name typed or printed



Civil Engineer's Stamp

*****PLEASE READ INSTRUCTIONS BELOW*****

- Quantities to be taken from improvement plans, Unit costs to be as provided on "City of Beaumont Construction Cost Worksheet".
- Show Bond Amounts to the nearest \$500.
- For construction items not covered by the Construction Cost Worksheet", Design Engineer is to provide his opinion of construction cost and use of that cost. If City of Beaumont unit costs are determined to be too low in the opinion of the Design Engineer, the higher costs as provided by the Design Engineer should be used.

CITY OF BEAUMONT PUBLIC WORKS DEPARTMENT
IMPROVEMENT REQUIREMENT WORKSHEET

PROJECT: Street Improvement Plans - Tract No. 31462-25

DATE: 3-Nov-21

STREET IMPROVEMENTS (Cont'd.)				
QTY.	UNIT	ITEM	UNIT COST	AMOUNT
	L.F.	Remove Chain Link Fence	\$ 2.50	\$ -
	EA.	Remove Barricade	\$ 200.00	\$ -
1,028	TON	Asphalt Concrete - 144 lbs/cu. Ft. (57,126 SF @ 0.25')	\$ 90.00	\$ 92,544
1,058	C.Y.	Aggregate Base Class II (57,126 SF @ 0.50')	\$ 50.00	\$ 52,894
	TON	Asphalt Emulsion (Fog Seal/Paint Binder) (1 ton = 240 gals) (0 SF)	\$ 600.00	\$ -
		apply at 0.05 + 0.03 = 0.08 gal/SY		\$ -
	S.F.	AC overlay (min. 0.10') If export, provide (a) & (b), a=fill, b=cut-fill If import, provide (a)&(C), a=cut, c=fill-cut (Unit costs for (a), (b) & (C) are 20% of actual costs to assure that work will be corrected to eliminate hazardous conditions.)	\$ 0.90	\$ -
	S.F.	Remove A.C. Pavement	\$ 0.50	\$ -
	L.F.	Curb and Gutter (Wedge Curb)	\$ 8.00	\$ -
3,542	L.F.	Curb and Gutter (Type A-6)	\$ 10.00	\$ 35,420
	L.F.	Curb and Gutter (Type A-8)	\$ 12.00	\$ -
	L.F.	Type "C" Curb	\$ 10.00	\$ -
	L.F.	Type "D" Curb	\$ 15.00	\$ -
	L.F.	A.C. Dike (6") (incl. material & labor)	\$ 8.00	\$ -
	L.F.	A.C. Dike (8") (incl. Material & labor)	\$ 10.00	\$ -
775	S.F.	P.C.C. Cross Gutter and Spandrels	\$ 10.00	\$ 7,750
21,838	S.F.	P.C.C. Sidewalk	\$ 6.00	\$ 131,028
5,184	SF	P.C.C. Drive Approach (54 @ 16' Wide)	\$ 8.00	\$ 41,472
6	EA.	Handicapped Access Ramp	\$ 1,500.00	\$ 9,000
	EA.	P.C.C. Drive Approach (individual lot driveway approach per finished grading plan)	\$ 8.00	\$ -
	S.F.	Join Existing Pavement (Grind & Overlay Exist. A.C.)	\$ 4.00	\$ -
				\$ -
				\$ -
				\$ -

SUBTOTAL = \$ 370,108.56

CITY OF BEAUMONT PUBLIC WORKS DEPARTMENT
IMPROVEMENT REQUIREMENT WORKSHEET

PROJECT: Street Improvement Plans - Tract No. 31462-25

DATE: 3-Nov-21

STREET IMPROVEMENTS (Cont'd.)				
QTY.	UNIT	ITEM	UNIT COST	AMOUNT
3	EA.	Street Name Sign	\$ 250.00	\$ 750
	EA.	Delineators-per Caltrans Std. A73C, Class 1, Type F	\$ 40.00	\$ -
	EA.	Object Markers - Modified Type F Delineators, Riverside County	\$ 40.00	\$ -
	L.F.	Barricades	\$ 28.00	\$ -
	L.F.	Utility Trench, one side (Edison, Telephone, Cable) (1 1/2 Total length of streets)	\$ 10.00	\$ -
	L.F.	Chain Link Fence (6')	\$ 12.00	\$ -
	L.F.	Remove Fence	\$ 4.00	\$ -
	EA.	Remove Power Pole	\$ 1,200.00	\$ -
	EA.	Street Lights (including conduit)	\$ 5,000.00	\$ -
	EA.	Street Trees (15 gallon)	\$ 150.00	\$ -
	EA.	Remove Existing Concrete Bulkhead	\$ 500.00	\$ -
	EA.	Concrete Bulkhead	\$ 200.00	\$ -
	C.Y.	Structural Reinforced Concrete	\$ 400.00	\$ -
	EA.	Slope Anchors for Pipes	\$ 300.00	\$ -
	L.F.	Cut Off Wall (Std. 2')	\$ 5.50	\$ -
	EA.	A.C. Overside Drain	\$ 500.00	\$ -
	EA.	Under Sidewalk Drain	\$ 1,800.00	\$ -
	S.F.	Terrace Drains and Down Drains	\$ 6.50	\$ -
	S.F.	Interceptor Drains	\$ 6.50	\$ -
3	EA.	Gutter Depression for Curb Opening Catch Basin Case B	\$ 1,500.00	\$ 4,500
	EA.	Gutter Depression for Curb Opening Catch Basin Case C	\$ 1,500.00	\$ -
	EA.	Access Driveway for Storm Drain at Cul-de-Sac	\$ 640.00	\$ -
3	EA.	"STOP" Pavement Marking	\$ 200.00	\$ 600
3	EA.	Limit Line	\$ 75.00	\$ 225
3	EA.	R1 "STOP SIGN"	\$ 250.00	\$ 750
	EA.	W14-1 "DEAD END" Sign	\$ 250.00	\$ -
	EA.	S4-5 "SCHOOL ZONE AHEAD" sign	\$ 250.00	\$ -
	EA.	SR4-1(CA) "SCHOOL ZONE" sign	\$ 250.00	\$ -

SUBTOTAL = \$ 6,825.00

CITY OF BEAUMONT PUBLIC WORKS DEPARTMENT
IMPROVEMENT REQUIREMENT WORKSHEET

PROJECT: Street Improvement Plans - Tract No. 31462-25

DATE: 3-Nov-21

STREET IMPROVEMENTS (Cont'd.)				
QTY.	UNIT	ITEM	UNIT COST	AMOUNT
	C.Y.	Rip Rap (1/4 Ton) Method B	\$ 35.00	\$ -
	C.Y.	Rip Rap (1/2 Ton) Method B	\$ 40.00	\$ -
	C.Y.	Rip Rap (1 Ton) Method B	\$ 45.00	\$ -
	C.Y.	Rip Rap (2 Ton) Method B	\$ 50.00	\$ -
	C.Y.	Grouted Rip Rap (1/4 Ton) Method B	\$ 45.00	\$ -
	C.Y.	Grouted Rip Rap (1/2 Ton) Method B	\$ 55.00	\$ -
	C.Y.	Grouted Rip Rap (1Ton) Method B	\$ 60.00	\$ -
	C.Y.	Grouted Rip Rap (2 Ton) Method B	\$ 65.00	\$ -
	L.F.	18" R.C.P.	\$ 60.00	\$ -
	L.F.	24" R.C.P.	\$ 70.00	\$ -
	L.F.	30" R.C.P.	\$ 80.00	\$ -
	L.F.	36" R.C.P.	\$ 90.00	\$ -
	L.F.	42" R.C.P.	\$ 100.00	\$ -
	L.F.	48 " RCP	\$ 110.00	\$ -
	L.F.	54" RCP	\$ 135.00	\$ -
	L.F.	60" RCP	\$ 160.00	\$ -
	L.F.	72" RCP	\$ 200.00	\$ -
	L.F.		\$ 1.00	\$ -
	L.F.		\$ 1.00	\$ -
	EA.	H.D.P.E. Clean Out	\$ 400.00	\$ -
	EA.	Drain Basin	\$ 400.00	\$ -
	EA.	Curb Outlet	\$ 3,000.00	\$ -
	EA.	Fossil Filters	\$ 500.00	\$ -
	EA.	18" C.M.P. Wye	\$ 500.00	\$ -
	EA.	Riprap Headwall	\$ 1,000.00	\$ -
	EA.	Concrete Collar	\$ 250.00	\$ -
	EA.	Outlet Structure	\$ 10,000.00	\$ -
	EA.	Concrete Pipe Anchor & Stabilizer	\$ 250.00	\$ -
	L.F.	12" HDPE Pipe	\$ 31.00	\$ -
	EA.	12" HDPE Misc. Fittings (Bend, coupling & end cap)	\$ 320.00	\$ -

SUBTOTAL = \$ -

CITY OF BEAUMONT PUBLIC WORKS DEPARTMENT
IMPROVEMENT REQUIREMENT WORKSHEET

PROJECT: Street Improvement Plans - Tract No. 31462-25

DATE: 3-Nov-21

STREET IMPROVEMENTS (Cont'd.)				
QTY.	UNIT	ITEM	UNIT COST	AMOUNT
	L.F.	60" C.S.P.	\$ 115.00	\$ -
	EA.	Catch Basin W = 4'	\$ 1,700.00	\$ -
	EA.	Catch Basin W = 7'	\$ 3,000.00	\$ -
	EA.	Catch Basin W = 10'	\$ 4,000.00	\$ -
	EA.	Catch Basin W = 14'	\$ 5,500.00	\$ -
	EA.	Catch Basin W = 21'	\$ 9,000.00	\$ -
	EA.	Type IX Inlet	\$ 2,500.00	\$ -
	EA.	Type X Inlet	\$ 2,500.00	\$ -
	EA.	Junction Structure No. 1	\$ 3,000.00	\$ -
	EA.	Junction Structure No. 2	\$ 2,500.00	\$ -
	EA.	Junction Structure No. 6	\$ 3,700.00	\$ -
	EA.	Transition Structure No. 1	\$ 2,000.00	\$ -
	EA.	Transition Structure No. 3	\$ 2,700.00	\$ -
	EA.	Manhole No. 1	\$ 2,700.00	\$ -
	EA.	Manhole No. 2	\$ 3,300.00	\$ -
	EA.	Manhole No. 3	\$ 2,700.00	\$ -
	EA.	Manhole No. 4	\$ 5,000.00	\$ -
	EA.	Adjust Water Valve (if no water plan)	\$ 150.00	\$ -
	EA.	Adjust MH to grade (if no sewer plan)	\$ 400.00	\$ -
	EA.	Headwall	\$ 5,000.00	\$ -
		Remove & Dispose of Interferring 30" Storm Drain		
	L.S.	and 36" Riser	\$ 500.00	\$ -
	EA.	Remove & Dispose of RCB Headwall & Wingwall	\$ 10,000.00	\$ -
	L.F.	and Concrete Bulkhead	\$ 25.00	\$ -
	EA.	Outlet Structure (Line A & B)	\$ 5,000.00	\$ -
	EA.	Remove Existing Headwall	\$ 1,000.00	\$ -
	L.F.	Catch Basin Trash Rack	\$ 25.00	\$ -
				\$ -
				\$ -
				\$ -
				\$ -
SUBTOTAL =				\$ -

CITY OF BEAUMONT PUBLIC WORKS DEPARTMENT
IMPROVEMENT REQUIREMENT WORKSHEET

PROJECT: Street Improvement Plans - Tract No. 31462-25

DATE: 3-Nov-21

STREET IMPROVEMENTS (Cont'd.)				
QTY.	UNIT	ITEM	UNIT COST	AMOUNT
	EA.	Water Quality Structure	\$ 2,500.00	\$ -
	LS	Concrete Inlet Apron	\$ 11,000.00	\$ -
	LS	Emergency Spillway	\$ 27,000.00	\$ -
	LS	84" Storm Drain Grate	\$ 8,500.00	\$ -
	SF	3' Wide V-Gutter (945 LF)	\$ 4.00	\$ -
				\$ -
				\$ -
				\$ -
				\$ -
				\$ -

Subtotal: \$ -

A. Subtotal \$ 376,934

B. Contingency (15%) \$ 56,540

C. Streets/Drainage Total (A + B) \$ 433,474

CITY OF BEAUMONT PUBLIC WORKS DEPARTMENT
IMPROVEMENT REQUIREMENT WORKSHEET

PROJECT: Street Improvement Plans - Tract No. 31462-25

DATE: 3-Nov-21

SEWER IMPROVEMENTS

Show quantities on this sheet only if project has a sewer plan. If no water plan, then show applicable quantities as part of street improvements.

QTY.	UNIT	ITEM	UNIT COST	AMOUNT
	L.F.	4" PVC. (73 Lots @ 25' Avg. Length & 5' for cleanout)	\$ 15.00	\$ -
	L.F.	4" P.V.C. Force Main & Fittings	\$ 26.00	\$ -
	L.F.	8" PVC	\$ 30.00	\$ -
	L.F.	10" V.C.P.	\$ 35.00	\$ -
	L.F.	12" V.C.P.	\$ 40.00	\$ -
	L.F.	15" V.C.P.	\$ 50.00	\$ -
	EA.	Standard or Terminus Manholes	\$ 2,500.00	\$ -
	EA.	Modified 5' Manholes	\$ 3,000.00	\$ -
	EA.	Drop Manholes	\$ 4,000.00	\$ -
	EA.	Sewer Lateral Connection per RCTD No. 600	\$ 500.00	\$ -
	EA.	Sewer Y's	\$ 25.00	\$ -
	EA.	Chimneys	\$ 300.00	\$ -
	EA.	Adjust M.H. to grade	\$ 340.00	\$ -
	L.F.	Concrete Encasement	\$ 20.00	\$ -
	EA.	4" P.V.C. Misc. Fittings	\$ 120.00	\$ -
	L.F.	Sewer Pipe Sleeving	\$ 36.00	\$ -
	EA.	Sewer Lift Station		\$ -
	EA.	Backflow prevention device	\$ 250.00	\$ -
	EA.	8" P.V.C. Misc. Fittings & Plugs	\$ 190.00	\$ -
	EA.	Remove 8" P.V.C Plug	\$ 190.00	\$ -

A.	Subtotal	\$ -
B.	Contingency (15% x A)	\$ -
C.	Sewer Total (A + B)	\$ -

CITY OF BEAUMONT, CALIFORNIA STREET IMPROVEMENT PLANS TRACT NO. 31462-25

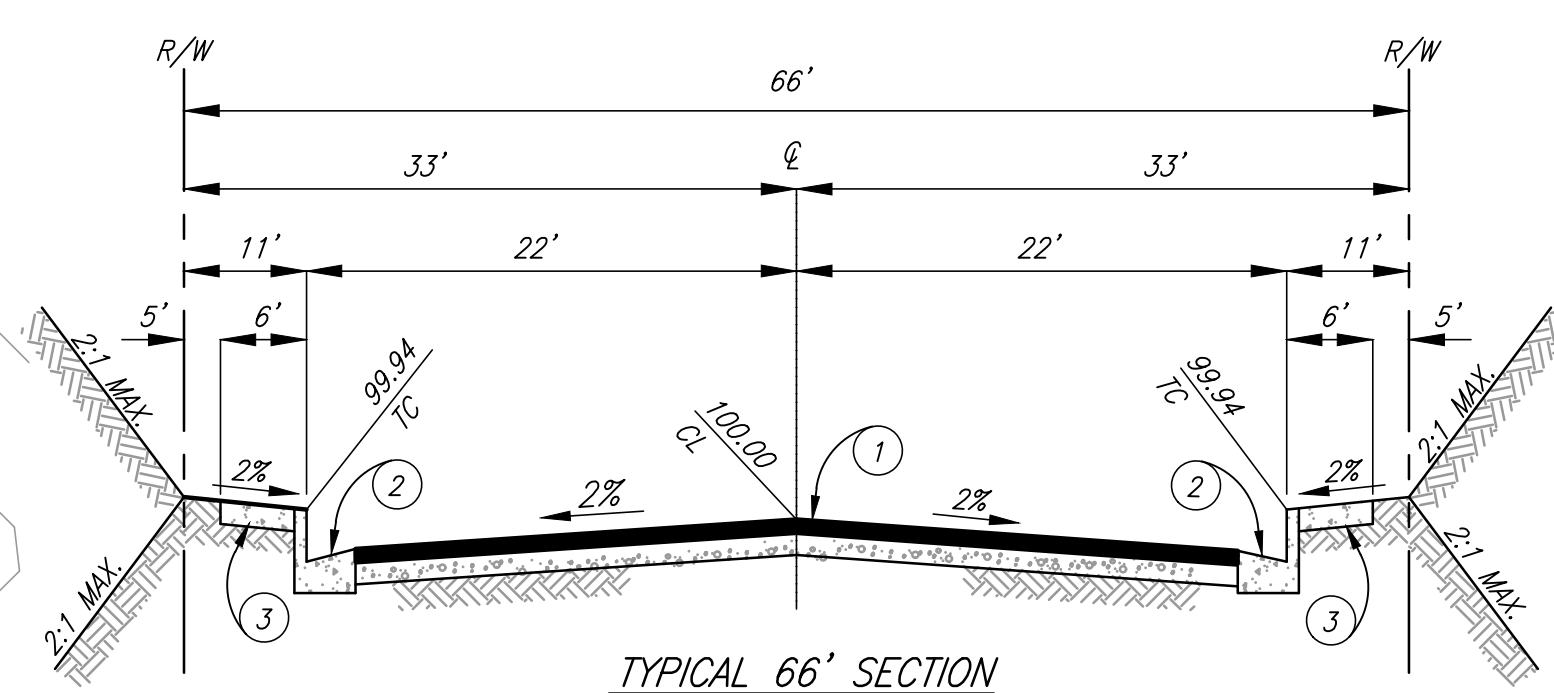
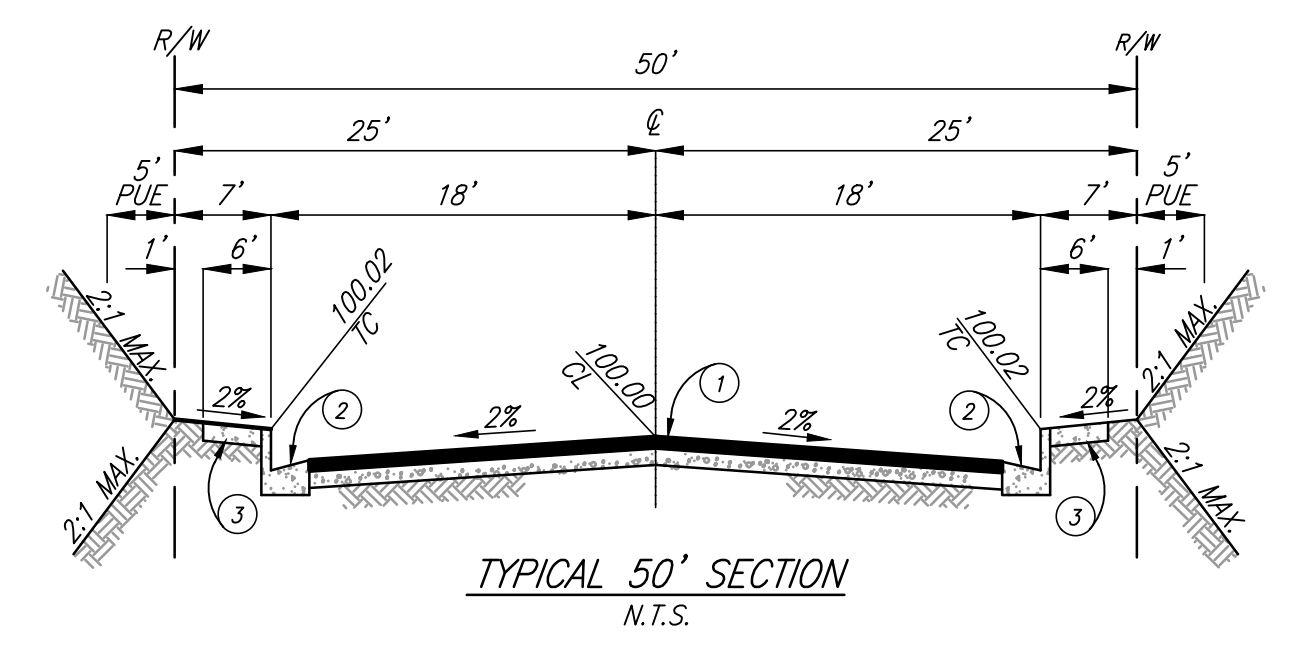
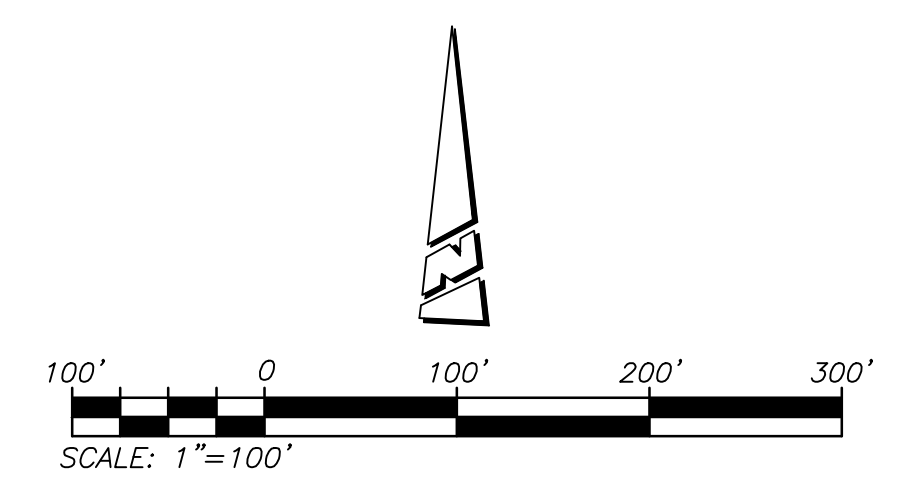
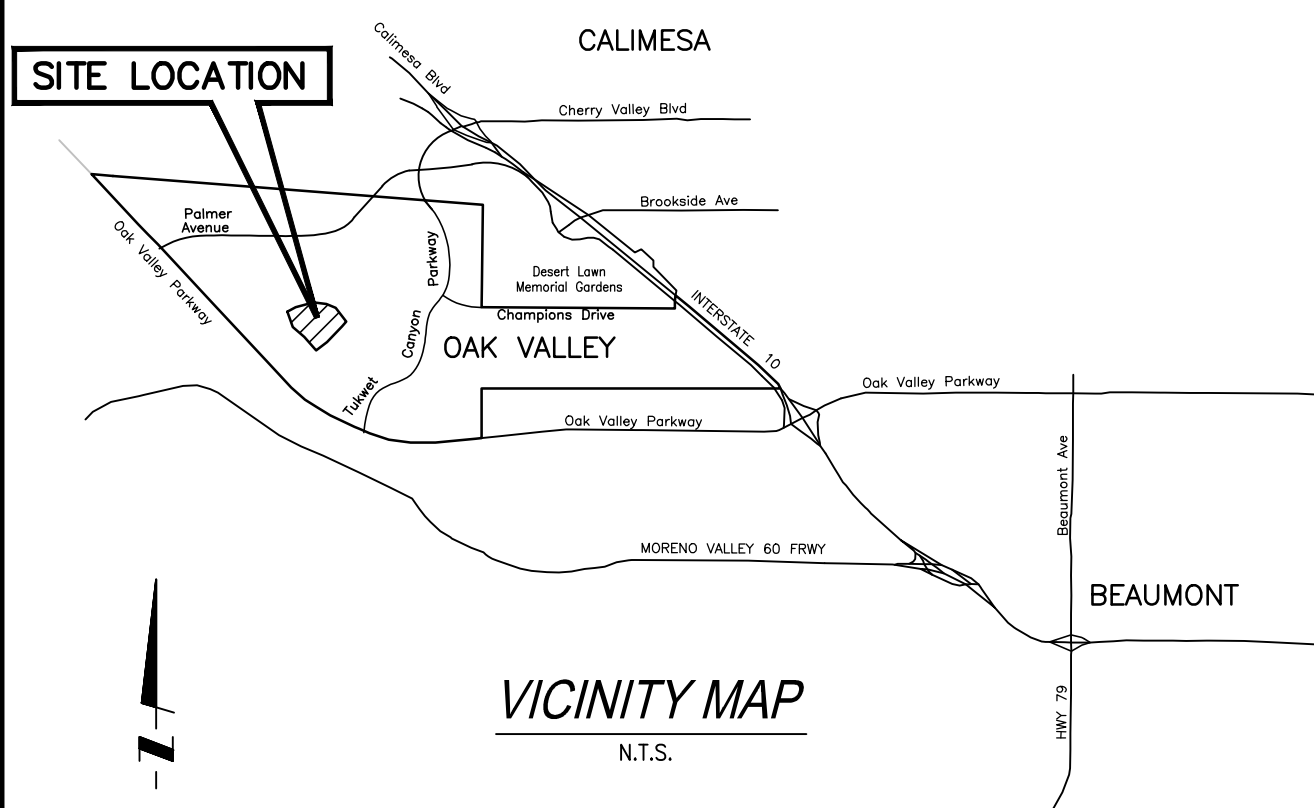

- GENERAL NOTES**
- THE CONTRACTOR SHALL BE RESPONSIBLE FOR THE CLEARING OF THE PROPOSED WORK AREA AND RELOCATION COSTS OF ALL EXISTING UTILITIES. THIS INCLUDES UNDERGROUNDING OF EXISTING OVERHEAD LINES ALONG THE PROJECT FRONTAGE AS REQUIRED BY THE CONDITIONS OF APPROVAL. PERMITTEE MUST INFORM CITY OF CONSTRUCTION SCHEDULE AT LEAST 48 HOURS PRIOR TO BEGINNING OF CONSTRUCTION AT (951) 769-8520.
 - ALL WORK SHALL CONFORM TO THE REQUIREMENTS OF THE STANDARD SPECIFICATIONS FOR PUBLIC WORKS CONSTRUCTION, GREENBOOK, LATEST EDITION AND THE RIVERSIDE COUNTY TRANSPORTATION DEPARTMENT IMPROVEMENT STANDARDS AND SPECIFICATIONS, "LATEST EDITION," COUNTY ORDINANCE NO. 461 AND SUBSEQUENT AMENDMENTS.
 - ALL UNDERGROUND FACILITIES, WITH LATERALS, SHALL BE IN PLACE PRIOR TO PAVING THE STREET SECTION INCLUDING, BUT NOT LIMITED TO, THE FOLLOWING: SEWER, WATER, ELECTRIC, GAS AND STORM DRAIN.
 - IT SHALL BE THE RESPONSIBILITY OF THE CONTRACTOR OR DEVELOPER TO INSTALL AND MAINTAIN ALL CONSTRUCTION, REGULATORY, GUIDE AND WARNING SIGNS WITHIN THE PROJECT LIMITS AND ITS SURROUNDINGS TO PROVIDE SAFE PASSAGE FOR THE TRAVELING PUBLIC AND WORKERS UNTIL THE FINAL COMPLETION AND ACCEPTANCE OF THE PROJECT BY THE CITY. A TRAFFIC CONTROL PLAN MUST BE SUBMITTED WITH APPROVED STREET PLAN FOR REVIEW TO THE PERMITS SECTION OR INSPECTION SECTION (FOR MAP CASES) PRIOR TO OBTAINING AN ENCROACHMENT PERMIT.
 - ANY PRIVATE DRAINAGE FACILITIES SHOWN ON THESE PLANS ARE FOR INFORMATION ONLY. BY SIGNING THESE IMPROVEMENT PLANS, NO REVIEW OR APPROVAL OF THESE PRIVATE FACILITIES ARE IMPLIED OR INTENDED BY CITY OF BEAUMONT PUBLIC WORKS DEPT.
 - THE DEVELOPER WILL INSTALL STREET NAME SIGNS CONFORMING TO R.C.T.D. STANDARD NO. 816.
 - ALL STREET SECTIONS ARE TENTATIVE. ADDITIONAL SOIL TESTS SHALL BE TAKEN AFTER ROUGH GRADING TO DETERMINE THE EXACT STREET SECTION REQUIREMENTS. USE R.C.T.D. STANDARD NO. 401 IF EXPANSIVE SOILS ARE ENCOUNTERED.
 - IT SHALL BE THE RESPONSIBILITY OF THE DEVELOPER TO NOTIFY THE ENGINEER TO INSTALL STREET CENTERLINE MONUMENTS AS REQUIRED BY RIVERSIDE COUNTY ORDINANCE NO. 461. IF CONSTRUCTION CENTERLINE DIFFERS, PROVIDE A TIE TO EXISTING CENTERLINE OF RIGHT-OF-WAY. PRIOR TO ROAD CONSTRUCTION, SURVEY MONUMENTS INCLUDING CENTERLINE MONUMENTS, TIE POINTS, PROPERTY CORNERS AND BENCH MARKS SHALL BE REFERENCED OUT AND CORNER RECORDS FILED WITH THE COUNTY SURVEYOR PURSUANT TO SECTION 8771 OF THE BUSINESS & PROFESSIONAL CODE. SURVEY POINTS DESTROYED DURING CONSTRUCTION SHALL BE RESET, AND A SECOND CORNER RECORD FILED FOR THOSE POINTS PRIOR TO COMPLETION AND ACCEPTANCE OF THE IMPROVEMENTS.
 - ASPHALTIC EMULSION (FOG SEAL) SHALL BE APPLIED NOT LESS THAN FOURTEEN DAYS FOLLOWING PLACEMENT OF THE ASPHALT SURFACING. FOG SEAL AND PAINT BINDER SHALL BE APPLIED AT A RATE OF 0.05 AND 0.03 GALLON PER SQUARE YARD RESPECTIVELY. ASPHALTIC EMULSION SHALL CONFORM TO SECTIONS 37, 39 AND 94 OF THE STATE STANDARD SPECIFICATIONS.
 - PRIME COAT IS REQUIRED PRIOR TO PAVING ALL GRADES IN EXCESS OF TEN PERCENT.
 - CONSTRUCTION PROJECTS DISTURBING MORE THAN ONE ACRE MUST OBTAIN A NATIONAL POLLUTANT DISCHARGE ELIMINATION SYSTEM (NPDES PERMIT) OWNERS/DEVELOPERS ARE REQUIRED TO FILE A NOTICE OF INTENT (NOI) WITH THE STATE WATER RESOURCES CONTROL BOARD (SWRCB), PREPARE A STORM WATER POLLUTION PREVENTION PLAN (SWPPP) AND MONITORING PLAN FOR THE SITE.
 - THE DEVELOPER SHALL BE RESPONSIBLE FOR THE INSTALLATION OF ADDITIONAL SIGNS AND MARKINGS NOT INCLUDED IN THE SIGNING AND STRIPING PLAN WITHIN THE PROJECT AREAS, OR ON ROADWAYS ADJACENT TO THE PROJECT BOUNDARIES, UPON THE REQUEST OF THE DIRECTOR OF PUBLIC WORKS OR HIS DESIGNEE TO IMPROVE TRAFFIC SAFETY ON THE ROADS UNDER THE JURISDICTION OF THE DEVELOPER.
 - IT SHALL BE THE RESPONSIBILITY OF THE DEVELOPER/CONTRACTOR TO APPLY TO THE RIVERSIDE COUNTY FLOOD CONTROL (RCFC) FOR PERMITS WHEN ANY STORM DRAIN PIPE NEEDS TO BE CONNECTED WITH A RCFC FACILITY AND ADD PERMITEE # _____ ON THE PLAN.
 - IT SHALL BE THE RESPONSIBILITY OF THE CONTRACTOR OR DEVELOPER TO APPLY TO THE CALIFORNIA DEPARTMENT OF TRANSPORTATION (CALTRANS) FOR AN ENCROACHMENT PERMIT FOR ALL WORK PERFORMED WITHIN STATE RIGHT-OF-WAY.
 - CURB DEPRESSIONS AND DRIVEWAY APPROACHES WILL BE INSTALLED AND WORK CONSTRUCTED ACCORDING TO COUNTY STANDARDS NO. 206 AND/OR 207, AS DIRECTED IN THE FIELD.
 - STREET LIGHTS SHALL BE INSTALLED IN ACCORDANCE WITH THE APPROVED STREET LIGHTING PLAN PER CITY OF BEAUMONT'S APPROVED STREET LIGHTING SPECIFICATIONS.
 - FOR ALL DRIVEWAY RECONSTRUCTION BEYOND RIGHT-OF-WAY, PROOF OF DRIVEWAY OWNER NOTIFICATION IS REQUIRED PRIOR TO CONSTRUCTION.
 - INSTALL STREET TREES IN ACCORDANCE WITH ORDINANCE 461 AND THE COMPREHENSIVE LANDSCAPING GUIDELINES (CHOOSE THREE SPECIES AND NAME THEM HERE).
 - THE DEVELOPER SHALL HAVE GEOTECHNICAL/SOILS ENGINEERING FIRM OBSERVE TRENCHING, BACKFILLING, & SOIL COMPACTION OF ALL UTILITY TRENCHES WITHIN ALL EASEMENTS & ROAD RIGHTS OF WAY. TWO SETS OF COMPACTION REPORTS CERTIFYING THAT WORKS WERE DONE IN CONFORMANCE TO STANDARDS & GEOTECHNICAL REPORT SHALL BE SUBMITTED AFTER EACH UTILITY TRENCH IS COMPLETED & CERTIFIED. COMPACTION REPORT MUST BE SUBMITTED TO THE DEPT. OF PUBLIC WORKS AT LEAST TWO WORKING DAYS BEFORE AGGREGATE BASE MATERIALS ARE PLACED ONSITE.

UNDERGROUND STRUCTURES
ALL UNDERGROUND UTILITIES OR STRUCTURES REPORTED BY THE OWNER OR OTHERS AND THOSE SHOWN ON THE RECORD EXAMINED ARE INDICATED WITH THEIR APPROXIMATE LOCATION AND EXTENT. THE OWNER BY ACCEPTING THESE PLANS OR PROCEEDING WITH IMPROVEMENTS PURSUANT THERETO AGREES TO ASSUME LIABILITY AND TO HOLD UNDERSIGNED HARMLESS FOR ANY DAMAGES RESULTING FROM THE EXISTENCE OF UNDERGROUND UTILITIES OR STRUCTURES NOT REPORTED TO THE UNDERSIGNED; NOT INDICATED ON THE PUBLIC RECORDS EXAMINED; LOCATED AT VARIANCE WITH THAT REPORTED OR SHOWN ON RECORDS EXAMINED. THE CONTRACTOR IS REQUIRED TO TAKE DUE PRECAUTIONARY MEASURES TO PROTECT THE UTILITIES OR STRUCTURES SHOWN AND ANY OTHER UTILITIES OR STRUCTURES FOUND AT THE SITE. IT SHALL BE THE CONTRACTOR'S RESPONSIBILITY TO NOTIFY THE OWNERS OF THE UTILITIES OR STRUCTURES CONCERNED BEFORE STARTING WORK.

- NOTE**
- APPROVAL OF THESE PLANS APPLIES ONLY WITHIN THE JURISDICTION OF THE CITY OF BEAUMONT.
 - TRENCHING FOR UTILITIES AND STRUCTURES IS NOT ALLOWED UNTIL SOIL COMPACTION REPORT IS SUBMITTED AND APPROVED BY THE PUBLIC WORKS DEPARTMENT.
 - THE CITY RESERVES THE RIGHT TO REQUIRE REVISION OF THE APPROVED PLANS TO CONFORM WITH CURRENT STANDARDS AND TO POST A NEW BOND IF CONSTRUCTION HAS NOT COMMENCED WITHIN TWO YEARS AFTER PLANS WERE APPROVED.
 - SIDEWALK AND DRIVEWAY APPROACHES WILL BE POURED/CONSTRUCTED ONLY AFTER DRIVEWAY LOCATIONS ARE DETERMINED.

OWNER/APPLICANT:
MERITAGE HOMES OF CALIFORNIA
5 PETERS CANYON SUITE 310
IRVINE, CA 92606
(949) 299-3848 OFFICE
(310) 266-8715 MOBILE
CONTACT: EFREM JOELSON

PREPARED BY:
PROACTIVE ENGINEERING CONSULTANTS WEST, INC.
25109 JEFFERSON AVENUE
SUITE 200
MURRIETA, CA 92562
(951) 200-6840

ASSESSOR'S PARCEL NO.
413-790-020

LEGAL DESCRIPTION
TRACT 31462-25, IN THE CITY OF BEAUMONT, COUNTY OF RIVERSIDE, STATE OF CALIFORNIA, AS SHOWN ON MAP FILED IN BOOK _____ PAGES _____ THROUGH _____ INCLUSIVE, OF MAPS IN THE OFFICE OF THE COUNTY RECORDER OF SAID COUNTY.

DECLARATION OF ENGINEER OF RECORD:
I HEREBY DECLARE THAT IN MY PROFESSIONAL OPINION, THE DESIGN OF THE IMPROVEMENTS AS SHOWN ON THESE PLANS COMPLIES WITH THE CURRENT PROFESSIONAL ENGINEERING STANDARDS AND PRACTICES. AS THE ENGINEER IN RESPONSIBLE CHARGE OF THE DESIGN OF THESE IMPROVEMENTS, I ACCEPT FULL RESPONSIBILITY FOR SUCH DESIGN. I UNDERSTAND AND ACKNOWLEDGE THAT THE PLAN CHECK OF THESE PLANS BY THE CITY OF BEAUMONT IS A REVIEW FOR THE LIMITED PURPOSE OF ENSURING THAT THESE PLANS COMPLY WITH THE CITY PROCEDURES AND OTHER APPLICABLE CODES AND ORDINANCES. THE PLAN REVIEW PROCESS IS NOT A DETERMINATION OF THE TECHNICAL ADEQUACY OF THE DESIGN OF THE IMPROVEMENTS. SUCH PLAN CHECK DOES NOT THEREFORE RELIEVE ME OF MY DESIGN RESPONSIBILITY.

AS THE ENGINEER OF RECORD, I AGREE TO DEFEND AND INDEMNIFY THE CITY OF BEAUMONT, ITS OFFICERS, ITS AGENTS, AND ITS EMPLOYEES FROM ANY AND ALL LIABILITY, CLAIMS, DAMAGES, OR INJURIES TO ANY PERSON OR PROPERTY ARISING FROM NEGLIGENT ACTS, ERRORS OR OMISSIONS OF THE ENGINEER OF RECORD, HIS EMPLOYEES, HIS AGENTS OR HIS CONSULTANTS.

GEORGE ALAN LENFESTEY R.C.E. 45920 11/05/21
EXPIRATION DATE 12-31-2022 DATE

- PRIVATE ENGINEERS NOTICE TO CONTRACTORS(S)**
- THE EXISTENCE AND LOCATION OF ANY UNDERGROUND UTILITIES OR STRUCTURES SHOWN ON THESE PLANS ARE OBTAINED BY A SEARCH OF AVAILABLE RECORDS. TO THE BEST OF OUR KNOWLEDGE, THERE ARE NO EXISTING UTILITIES EXCEPT THOSE SHOWN ON THESE PLANS. THE CONTRACTOR IS REQUIRED TO TAKE ALL PRECAUTIONARY MEASURES TO PROTECT THE UTILITIES SHOWN, AND ANY OTHER LINES OR STRUCTURES NOT SHOWN ON THESE PLANS AND IS RESPONSIBLE FOR THE PROTECTION OF, AND ANY DAMAGE TO THESE LINES OR STRUCTURES
 - IT SHALL BE THE CONTRACTORS RESPONSIBILITY TO NOTIFY THE OWNER OF ALL UTILITIES OR STRUCTURES CONCERNED BEFORE STARTING WORK.
 - QUANTITIES SHOWN HEREON ARE PROVIDED FOR BIDDING PURPOSES ONLY. CONTRACTOR SHALL BE RESPONSIBLE FOR VERIFYING ALL QUANTITIES PRIOR TO BIDDING FOR CONSTRUCTION.
 - THE PRIVATE ENGINEER SIGNING THESE PLANS IS RESPONSIBLE FOR ASSURING THE ACCURACY AND ACCEPTABILITY OF THE DESIGN HEREON. IN THE EVENT OF DISCREPANCIES ARISING AFTER CITY APPROVAL OR DURING CONSTRUCTION, THE PRIVATE ENGINEER SHALL BE RESPONSIBLE FOR DETERMINING AN ACCEPTABLE SOLUTION AND REVISING THE PLANS FOR APPROVAL BY THE CITY.

CONSTRUCTION NOTES AND ESTIMATED QUANTITIES ITEM

ITEM	DESCRIPTION	QUANTITY
1	CONSTRUCT 3" A.C. OVER 6" A.B.	57,126 S.F.
2	CONSTRUCT TYPE A-6 CURB PER COUNTY OF RIVERSIDE STANDARD NO. 200	3,542 L.F.
3	CONSTRUCT SIDEWALK PER COUNTY OF RIVERSIDE STANDARD NO. 401 (DRIVEWAY S.F. REMOVED FROM QUANTITY)	21,838 S.F.
4	NOT USED	
5	INSTALL STREET NAME SIGN PER RIVERSIDE STD. NO. 816	3 EA.
6	CONSTRUCT CURB RAMP PER COUNTY OF RIVERSIDE STANDARD NO. 403, CASE A	6 EA.
7	CONSTRUCT CROSS-GUTTER PER COUNTY OF RIVERSIDE STANDARD NO. 209	775 S.F.
8	CONSTRUCT GUTTER DEPRESSION, CASE B, PER RIVERSIDE COUNTY STANDARD NO. 311	3 EA.
9	NOT USED	
10	CONSTRUCT RESIDENTIAL DRIVEWAY PER COUNTY OF RIVERSIDE ST. NO. 207 (W=16) (DRIVEWAY SUBJECT TO CHANGE WHEN FINAL HOME LOCATIONS ARE DETERMINED)	54 EA.
11	INSTALL R1 STOP SIGN ON STREET NAME SIGN POST	3 EA.
12	THERMOPLASTIC WHITE LIMIT LINE PER CALTRANS STANDARD A24E	48 L.F.
13	THERMOPLASTIC "STOP" PAVEMENT MARKING PER CALTRANS STANDARD A24D	3 EA.
14	INSTALL BLUE REFLECTIVE FIRE HYDRANT PAVEMENT MARKERS PER DETAIL A, SHEET 2.	7 EA.

TOTAL WORK TO BE DONE

- THE IMPROVEMENT WORK SHALL BE PERFORMED IN ACCORDANCE WITH THE FOLLOWING DOCUMENTS, CURRENT AT THE TIME OF CONSTRUCTION, AS DIRECTED BY THE CITY ENGINEER.
- BEAUMONT MUNICIPAL CODE.
 - FOR STREETS: RIVERSIDE COUNTY ORDINANCE NO. 461. FLOOD CONTROL FACILITIES: THE RIVERSIDE COUNTY FLOOD CONTROL AND WATER CONSERVATION DISTRICT'S STANDARDS FOR FLOOD CONTROL FACILITIES. SANITARY SEWER FACILITIES: THE EASTERN MUNICIPAL WATER DISTRICT'S STANDARDS FOR SANITARY SEWER FACILITIES. ALL OTHER PUBLIC WORKS: THE STANDARD SPECIFICATIONS FOR PUBLIC WORKS CONSTRUCTION (GREEN BOOK).
 - THIS SET OF PLANS.
 - RESOLUTION NO. _____ DATED _____
 - SOILS REPORT AND RECOMMENDATIONS BY ALTA CALIFORNIA GEOTECHNICAL INC., DATED 8/27/2020.

LEGEND

RIGHT-OF-WAY, R/W	PROP. PROPOSED	PRVC	POINT OF REVERSE VERTICAL CURVE
FUTURE RIGHT-OF-WAY, R/W	EXIST. EXISTING	(1329.02)	EXISTING ELEVATION
TRACT BOUNDARY	CL, C/L CENTERLINE	1479.70	PROPOSED ELEVATION
CENTERLINE, CL	TC TOP OF CURB	LT	LEFT
PROP STORM DRAIN	FL FLOW LINE	RT	RIGHT
EXISTING STORM DRAIN	FS FINISHED SURFACE	FH	FIRE HYDRANT
DIRECTION OF FLOW	EP EDGE OF PAVEMENT	ST	STREET
STOP SIGN ON STREET NAME SIGN	CB CATCH BASIN	R/W	RIGHT OF WAY
CONCRETE	AC ASPHALTIC CONCRETE	D/W	DRIVEWAY
AC PAVING	AB AGGREGATE BASE	V.C.	VERTICAL CURVE
A.C. OVERLAY/JOIN EXISTING	BCR BEGIN CURB RETURN	PI	POINT OF INTERSECTION
PROPOSED STREET TREE	ECR END CURB RETURN	PVI	POINT OF VERTICAL INTERSECTION
PROPOSED CATCH BASIN	BVC BEGIN VERTICAL CURVE	PRC	POINT OF REVERSE CURVE
FIRE HYDRANT	MVC MIDDLE VERTICAL CURVE	PCC	POINT OF COMPOUND CURVE
SD CLEANOUT	EVC END VERTICAL CURVE	STD	STANDARD
CURB & GUTTER			
FLOW LINE			
PROPERTY LINE			
BLUE REFLECTIVE MARKER			
REDUCED SPEED AHEAD SIGN			
INDICATES SET 1" I.D. X 18" I.P. AND TAG "LS 8509", FLUSH. (RV. CO. STD. A MOV.)			

WDDID NO. 833C364442

INDEX OF SHEETS:

SHEET 1 - TITLE SHEET - VICINITY MAP - GENERAL NOTES - LEGEND - CONSTRUCTION NOTES - INDEX MAP TYPICAL SECTIONS - QUANTITIES
SHEET 2 - LOPEZ LANE STA: 10+00.00 TO STA: 17+00.00
SHEET 3 - LOPEZ LANE STA: 17+00.00 TO STA: 20+52.49
SHEET 4 - WEISKOPF WAY STA: 9+95.67 TO STA: 17+81.73
SHEET 5 - SIGNAGE AND STRIPING

DIGALERT
Call 2 Working Days Before You Dig! 811

BENCHMARK:
DESCRIPTION: USGS MONUMENT "REST" BENCHMARK DISK SET IN TOP OF CONCRETE MONUMENT STAMPED "REST 1972" ON DESERT LAWN DRIVE ACROSS THE DRIVE FROM DESERT LAWN CEMETERY 25.3 FT. N.E. OF THE DRIVE CENTERLINE 24.9 FT. S.W. OF THE S.W. EDGE OF THE SOUTH EASTBOUND LANES OF INTERSTATE HIGHWAY 10

ELEV. 2491.44, NGVD 29

BY	MARK	DESCRIPTION	APPR.	DATE
ENGINEER		REVISIONS	CITY	

PROACTIVE ENGINEERING CONSULTANTS WEST, INC.
25109 JEFFERSON AVE. SUITE 200
MURRIETA, CA 92562
(951) 200-6840

GEORGE ALAN LENFESTEY
R.C.E. 45920 EXP. 12-31-2022

DESIGN BY: PEC
DRAWN BY: PEC
CHECKED BY: PEC
SCALE: AS NOTED
DATE: 11/05/21
JOB NUMBER: 06.002.000

CITY OF BEAUMONT
CALIFORNIA
INC. NOV. 18, 1919

Reviewed By: _____ Date: 11/9/2021
Recommended for Approval By: _____ Date: 11/9/2021
Approved By: _____ Date: 11/16/2021

CITY OF BEAUMONT, PUBLIC WORKS DEPARTMENT
ENGINEERING DIVISION

CITY OF BEAUMONT, CALIFORNIA
STREET IMPROVEMENT PLANS
TRACT NO. 31462-25
TITLE SHEET - VICINITY MAP - GENERAL NOTES
LEGEND - CONSTRUCTION NOTES - INDEX MAP - TYPICAL SECTIONS - QUANTITIES

SHEET 1
OF 5 SHEETS
FILE NO: 3409

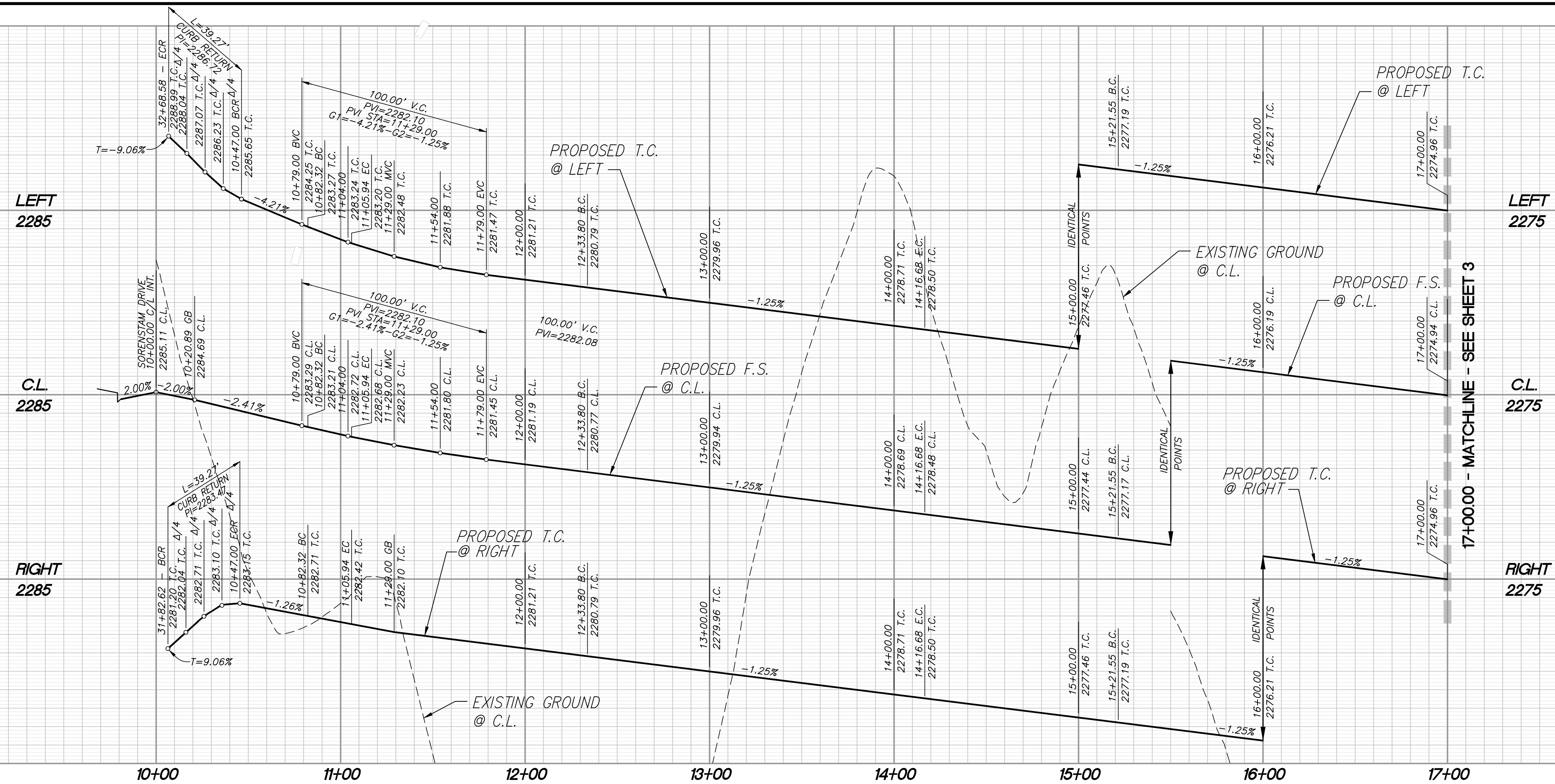

PROFILE SCALE:
HORIZ: 1"=40'
VERT: 1"=4'

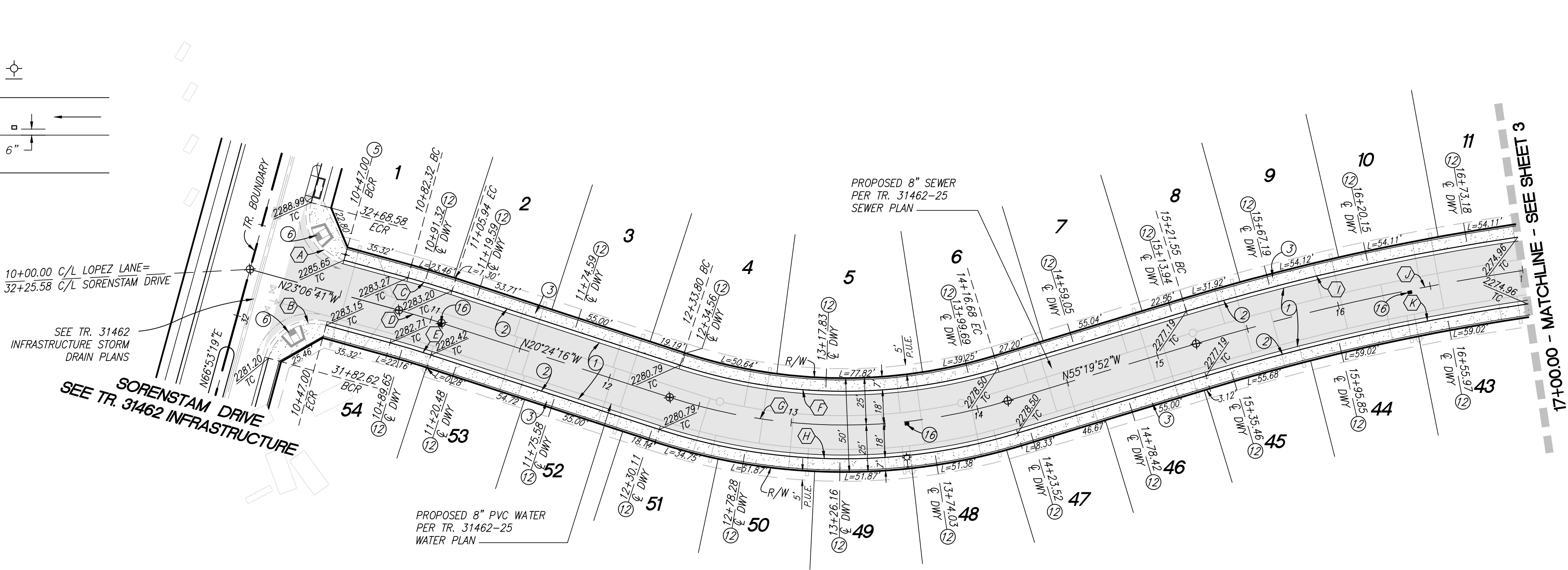
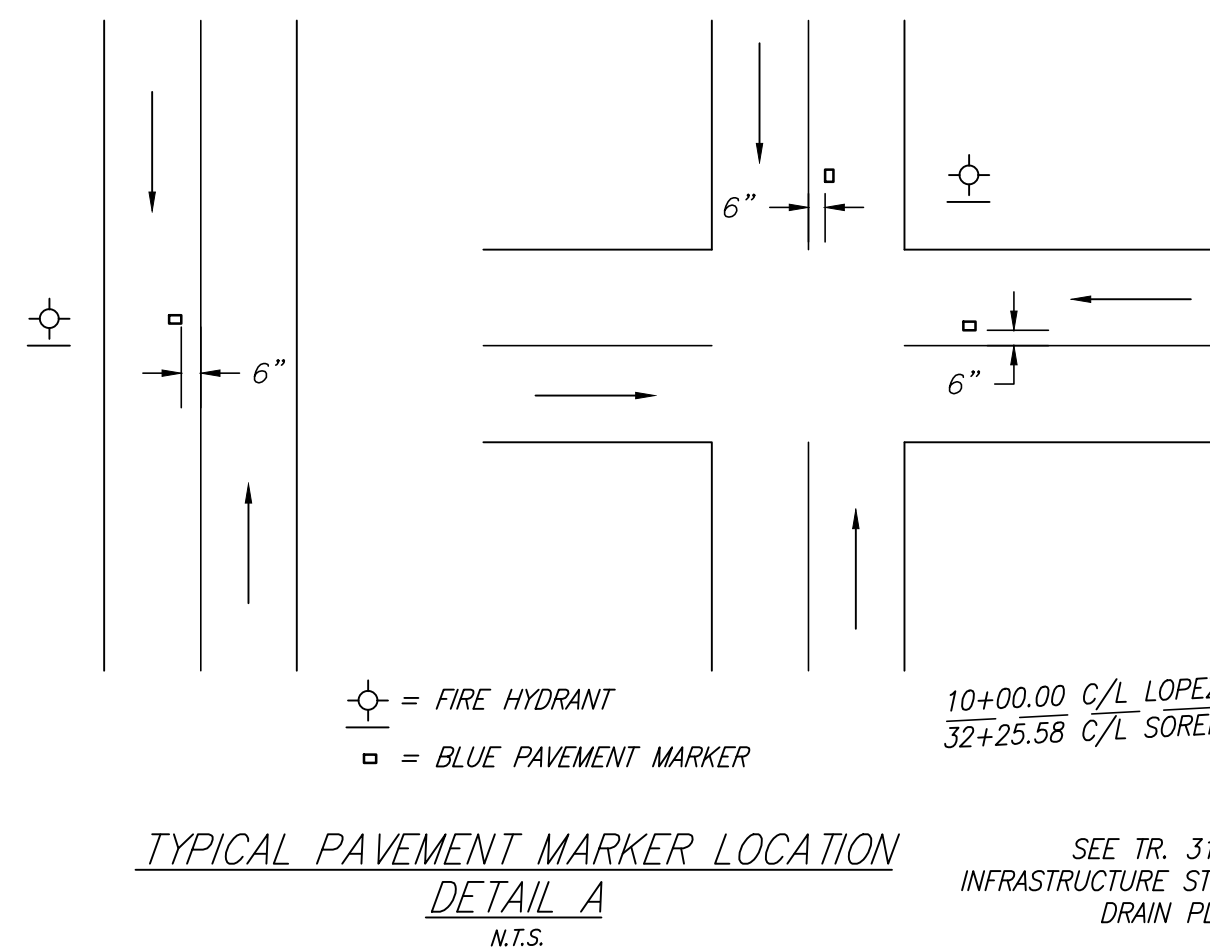

- CONSTRUCTION NOTES:**
- CONSTRUCT 3" A.C. OVER 6" A.B.
 - CONSTRUCT TYPE A-6 CURB PER COUNTY OF RIVERSIDE STANDARD NO. 200
 - CONSTRUCT SIDEWALK PER COUNTY OF RIVERSIDE STANDARD PLAN NO. 401
 - INSTALL STREET NAME SIGN PER RIVERSIDE COUNTY STD. NO. 816
 - CONSTRUCT CURB RAMP PER COUNTY OF RIVERSIDE STANDARD NO. 403, CASE A
 - CONSTRUCT RESIDENTIAL DRIVEWAY PER COUNTY OF RIVERSIDE ST. NO. 207 (W-16) (DRIVEWAY SUBJECT TO CHANGE WHEN FINAL HOME LOCATIONS ARE DETERMINED)
 - INSTALL BLUE REFLECTIVE FIRE HYDRANT PAVEMENT MARKERS PER DETAIL A, SHEET 2.

CURVE DATA			
NO.	BEARING/DELTA	RADIUS	TANGENT
(A)	90°00'00"	25.00'	39.27'
(B)	89°59'16"	25.00'	39.27'
(C)	02°42'25"	518.00'	24.47'
(D)	02°42'25"	500.00'	23.62'
(E)	02°42'25"	482.00'	22.77'
(F)	34°55'36"	282.00'	171.90'
(G)	34°55'36"	300.00'	182.88'
(H)	34°55'36"	318.00'	193.85'
(I)	08°31'13"	1218.00'	181.12'
(J)	08°31'13"	1200.00'	178.45'
(K)	08°31'13"	1182.00'	175.77'

LOPEZ LANE

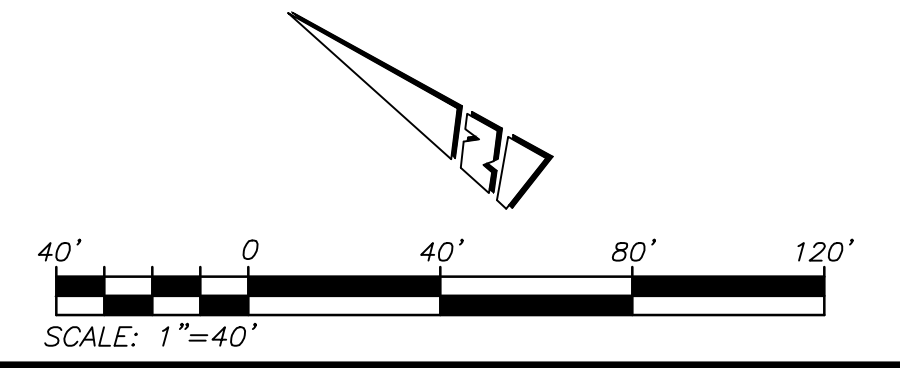

DIGALERT
Call 2 Working Days Before You Dig! 811

BENCHMARK:
DESCRIPTION: USGS MONUMENT "REST" BENCHMARK DISK SET IN TOP OF CONCRETE MONUMENT STAMPED "REST 1972" ON DESERT LAWN DRIVE ACROSS THE DRIVE FROM DESERT LAWN CEMETERY 25.3 FT. N.E. OF THE DRIVE CENTERLINE 24.9 FT. S.W. OF THE S.W. EDGE OF THE SOUTH EASTBOUND LANES OF INTERSTATE HIGHWAY 10
ELEV.2491.44, NGVD 29

BY	MARK	DESCRIPTION	APPR.	DATE
ENGINEER		REVISIONS	CITY	

PROACTIVE ENGINEERING WEST
CONSULTANTS WEST, INC.
25109 JEFFERSON AVE. SUITE 200
MURRIETA, CA 92562
951-200-6840

11/05/21
DATE

REGISTERED PROFESSIONAL ENGINEER
GEORGE ALAN LENFESTEY
No. 45920
Exp. 12/31/22
CIVIL
STATE OF CALIFORNIA

DESIGN BY: PEC
DRAWN BY: PEC
CHECKED BY: PEC
SCALE: AS NOTED
DATE: 11/05/21
JOB NUMBER: 06.002.000



Reviewed By: [Signature] Date: 11/9/2021
Recommended for Approval By: [Signature] Date: 11/9/2021
Approved By: [Signature] Date: 11/16/2021
CITY OF BEAUMONT, PUBLIC WORKS DEPARTMENT
ENGINEERING DIVISION

CITY OF BEAUMONT, CALIFORNIA
STREET IMPROVEMENT PLANS
TRACT NO. 31462-25
LOPEZ LANE
STA: 10+00.00 TO STA: 17+00.00

SHEET
2
OF 5 SHEETS
FILE NO: 3409

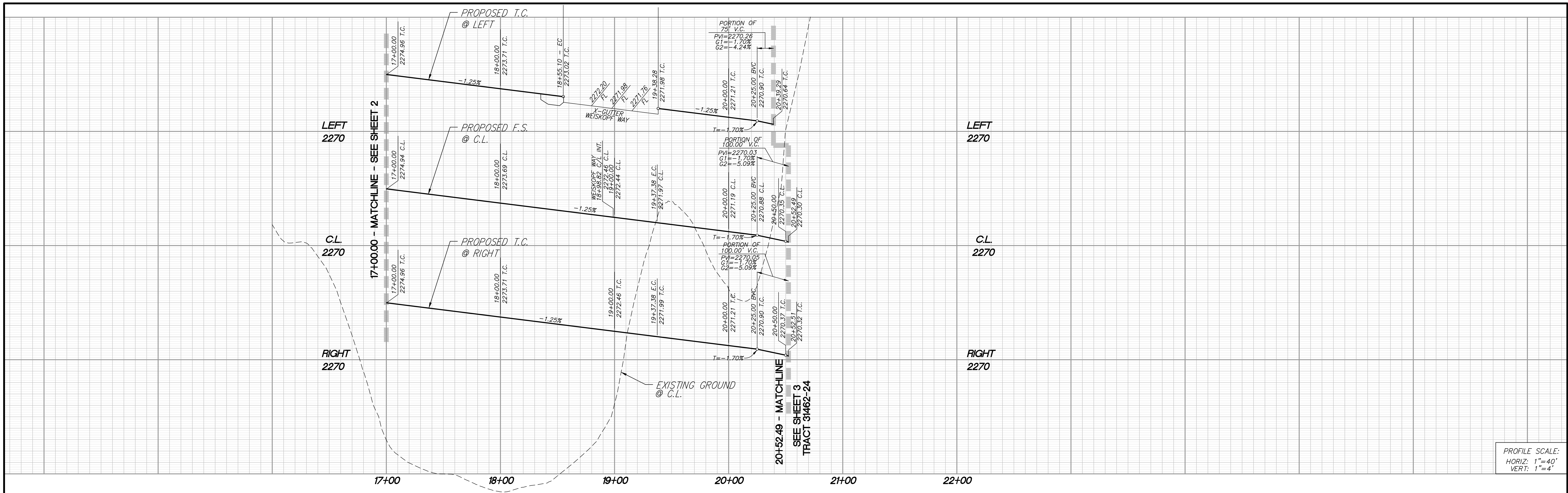

PROFILE SCALE:
 HORIZ: 1"=40'
 VERT: 1"=4'

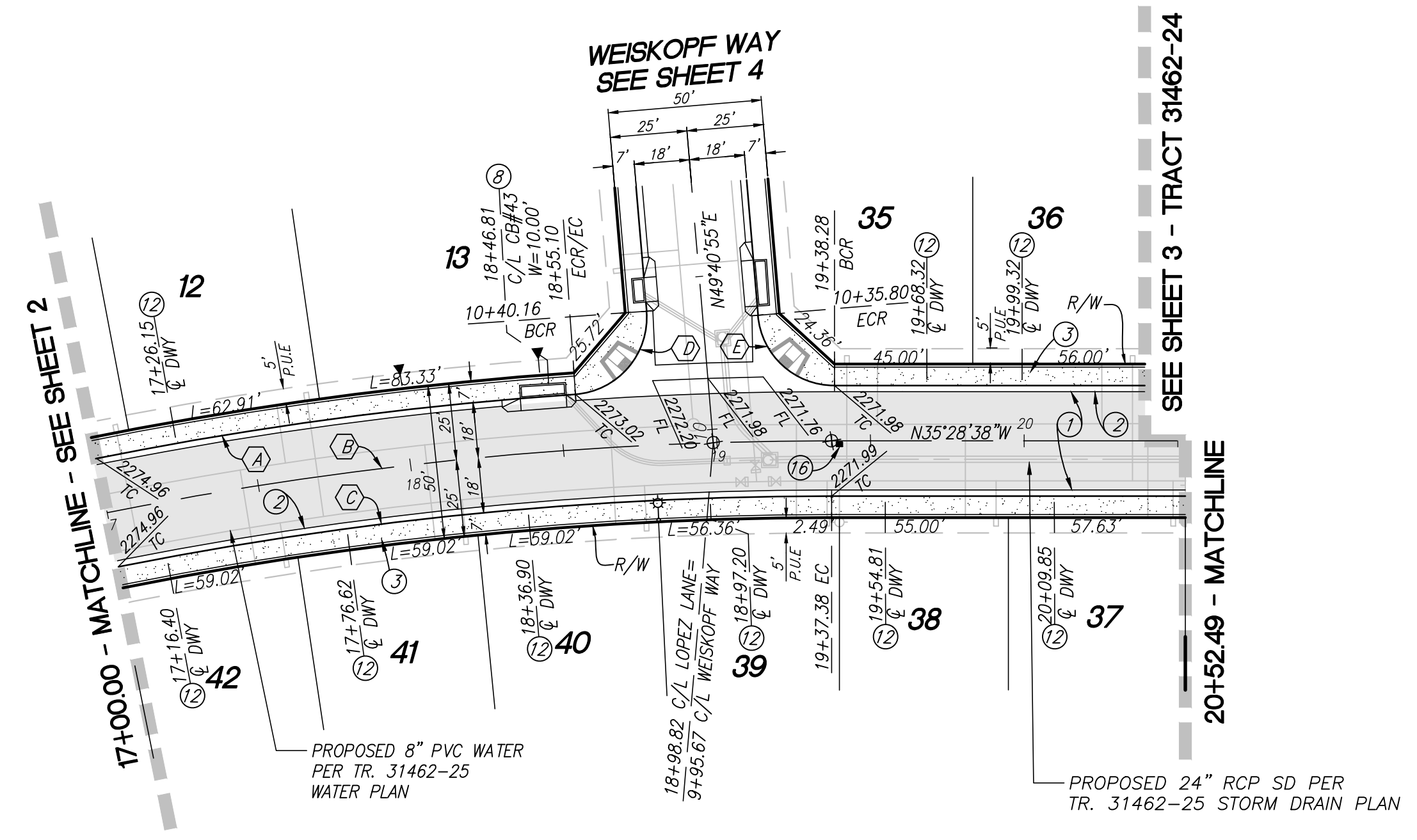

- CONSTRUCTION NOTES:**
- 1 CONSTRUCT 3" A.C. OVER 6" A.B.
 - 2 CONSTRUCT TYPE A-6 CURB PER COUNTY OF RIVERSIDE STANDARD NO. 200
 - 3 CONSTRUCT SIDEWALK PER COUNTY OF RIVERSIDE STANDARD PLAN NO. 401
 - 8 CONSTRUCT GUTTER DEPRESSION, CASE B, PER RIVERSIDE COUNTY STANDARD NO. 311
 - 12 CONSTRUCT RESIDENTIAL DRIVEWAY PER COUNTY OF RIVERSIDE ST. NO. 207 (W=16) (DRIVEWAY SUBJECT TO CHANGE WHEN FINAL HOME LOCATIONS ARE DETERMINED)
 - 16 INSTALL BLUE REFLECTIVE FIRE HYDRANT PAVEMENT MARKERS PER DETAIL A, SHEET 2.

CURVE DATA				
NO.	BEARING/DELTA	RADIUS	LENGTH	TANGENT
(A)	724°20"	1218.00'	157.43'	78.82'
(B)	11°20'00"	1200.00'	237.36'	119.07'
(C)	11°20'00"	1182.00'	233.80'	117.28'
(D)	90°54'46"	25.00'	39.67'	25.40'
(E)	85°09'33"	25.00'	37.16'	22.97'

LOPEZ LANE

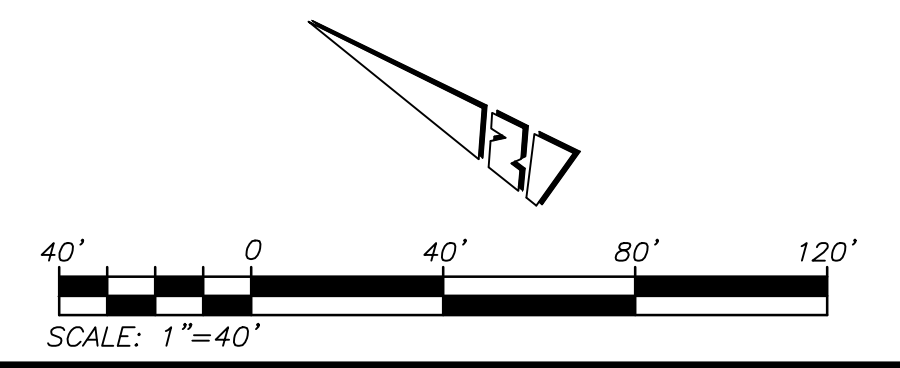

DIGALERT
 Call 2 Working Days Before You Dig!
 811

BENCHMARK:
 DESCRIPTION: USGS MONUMENT "REST"
 BENCHMARK DISK SET IN TOP OF
 CONCRETE MONUMENT STAMPED "REST
 1972" ON DESERT LAWN DRIVE ACROSS
 THE DRIVE FROM DESERT LAWN
 CEMETERY 25.3 FT. N.E. OF THE DRIVE
 CENTERLINE 24.9 FT. S.W. OF THE S.W.
 EDGE OF THE SOUTH EASTBOUND LANES
 OF INTERSTATE HIGHWAY 10
 ELEV. 2491.44, NGVD 29

BY	MARK	DESCRIPTION	APPR.	DATE
ENGINEER		REVISIONS	CITY	

PROACTIVE ENGINEERING WEST
 CONSULTANTS WEST, INC.
 25199 JEFFERSON AVE. SUITE 200
 HUERFANO, CA 92562
 951-200-6660

GEORGE ALAN LENFESTY
 R.C.E. 45920 EXP. 12-31-2022

11/05/21

DESIGN BY: PEC
 DRAWN BY: PEC
 CHECKED BY: PEC
 SCALE: AS NOTED
 DATE: 11/05/21
 JOB NUMBER: 06.002.000

CITY OF BEAUMONT
 CALIFORNIA
 INC. NOV. 18, 1892

Reviewed By: *[Signature]* Staff Engineer Date: 11/9/2021
 Recommended for Approval By: *[Signature]* Administrative Engineer Date: 11/9/2021
 Approved By: *[Signature]* City Engineer/Director of Public Works Date: 11/16/2021

CITY OF BEAUMONT, PUBLIC WORKS DEPARTMENT
 ENGINEERING DIVISION

CITY OF BEAUMONT, CALIFORNIA
 STREET IMPROVEMENT PLANS
 TRACT NO. 31462-25
LOPEZ LANE
 STA: 17+00.00 TO STA: 20+52.49

SHEET
3
 OF 5 SHEETS
 FILE NO: 3409

DWG: N:\06-002.000\Drawings\Street Improvements\VC Phase 4\31462-25 ST IMP PLANS\31462-25-SHT-03.dwg
 Project: Nov 05, 2021 11:53am; mianzema

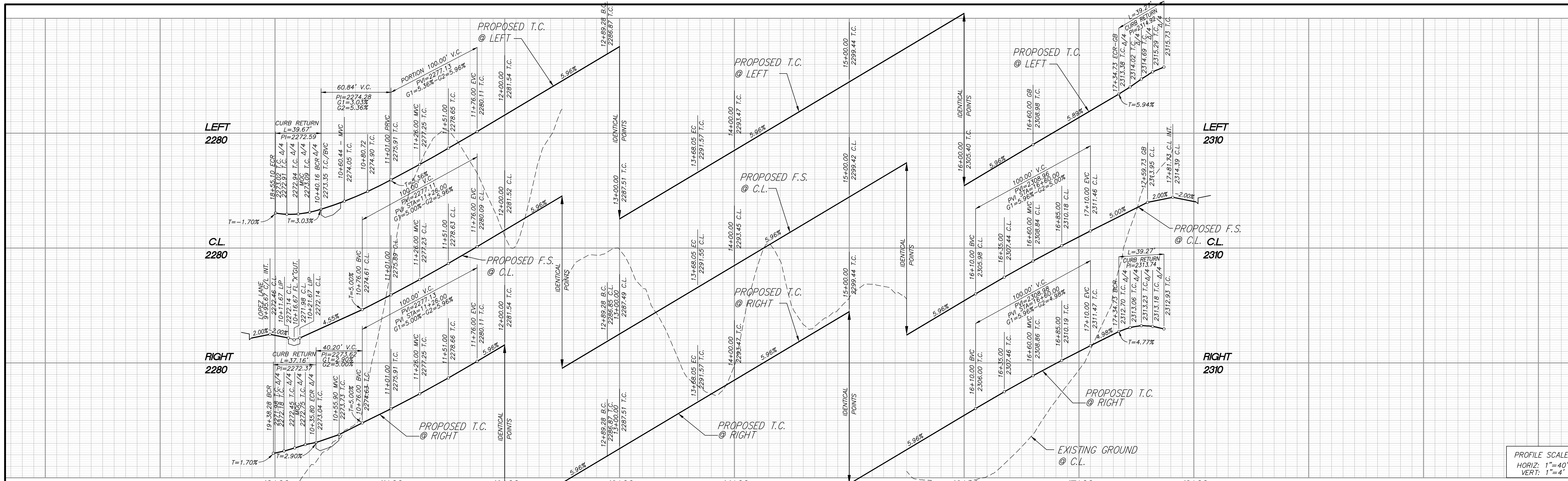

PROFILE SCALE:
HORIZ: 1"=40'
VERT: 1"=4'

CONSTRUCTION NOTES:

- ① CONSTRUCT 3" A.C. OVER 6" A.B.
- ② CONSTRUCT TYPE A-6 CURB PER COUNTY OF RIVERSIDE STANDARD NO. 200
- ③ CONSTRUCT SIDEWALK PER COUNTY OF RIVERSIDE STANDARD PLAN NO. 401
- ④ INSTALL STREET NAME SIGN PER RIVERSIDE COUNTY STD. NO. 816
- ⑤ CONSTRUCT CURB RAMP PER COUNTY OF RIVERSIDE STANDARD NO. 403, CASE A
- ⑥ CONSTRUCT CROSS-GUTTER PER COUNTY OF RIVERSIDE STANDARD NO. 209
- ⑦ CONSTRUCT GUTTER DEPRESSION, CASE B, PER RIVERSIDE COUNTY STANDARD NO. 311
- ⑧ CONSTRUCT RESIDENTIAL DRIVEWAY PER COUNTY OF RIVERSIDE ST. NO. 207 (W=16) (DRIVEWAY SUBJECT TO CHANGE WHEN FINAL HOME LOCATIONS ARE DETERMINED)
- ⑨ INSTALL BLUE REFLECTIVE FIRE HYDRANT PAVEMENT MARKERS PER DETAIL A, SHEET 2.

CURVE DATA				
NO.	BEARING/DELTA	RADIUS	LENGTH	TANGENT
A	90°54'46"	25.00'	39.67'	25.40'
B	85°09'33"	25.00'	37.16'	22.97'
C	4°30'47"	982.00'	77.35'	38.70'
D	4°30'47"	1000.00'	78.77'	39.41'
E	4°30'47"	1018.00'	80.19'	40.11'
F	90°00'00"	25.00'	39.27'	25.00'

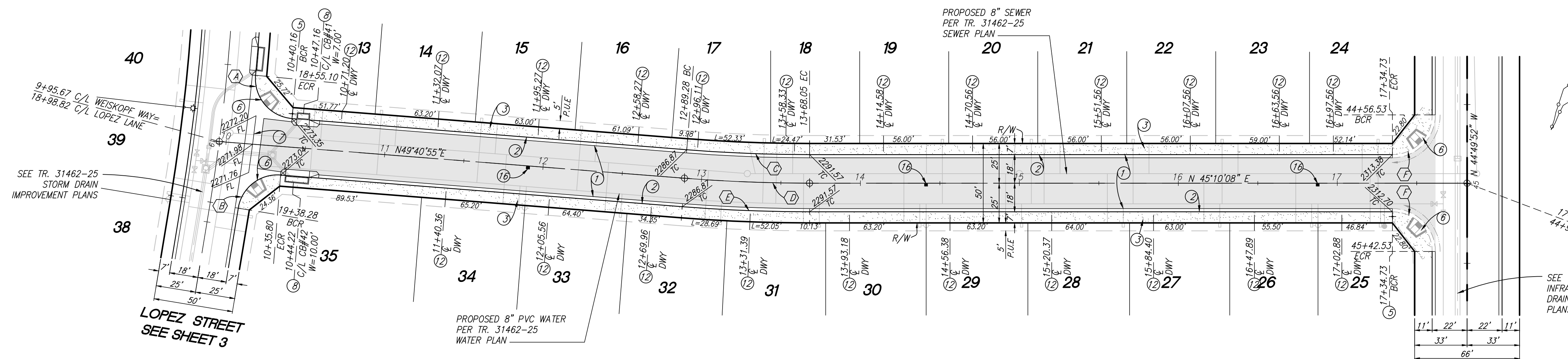

WEISKOPF WAY

SORENSTAM DRIVE
SEE TR. 31462 INFRASTRUCTURE

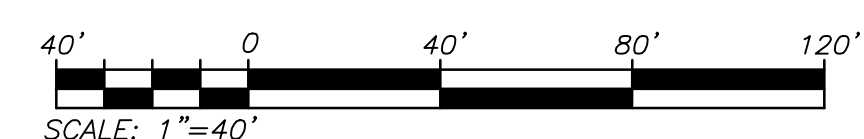

BENCHMARK:
DESCRIPTION: USGS MONUMENT "REST"
BENCHMARK DISK SET IN TOP OF
CONCRETE MONUMENT STAMPED "REST
1972" ON DESERT LAWN DRIVE ACROSS
THE DRIVE FROM DESERT LAWN
CEMETERY 25.3 FT. N.E. OF THE DRIVE
CENTERLINE 24.9 FT. S.W. OF THE S.W.
EDGE OF THE SOUTH EASTBOUND LANES
OF INTERSTATE HIGHWAY 10

ELEV. 2491.44, NGVD 29

BY	MARK	DESCRIPTION	APPR.	DATE
ENGINEER		REVISIONS	CITY	

PROACTIVE ENGINEERING WEST
CONSULTANTS WEST, INC.
25109 JEFFERSON AVE. SUITE 200
MURRIETA, CA 92562
951-200-6840

DESIGNED BY: *George Alan Lenfestey*
DATE: 11/05/21

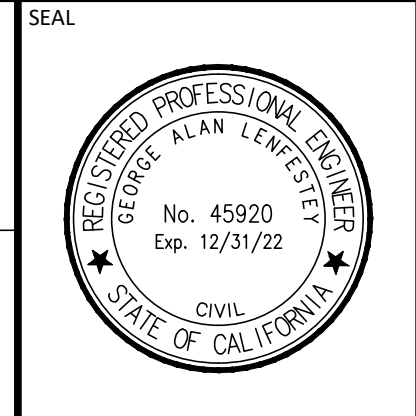

DESIGN BY: PEC
DRAWN BY: PEC
CHECKED BY: PEC
SCALE: AS NOTED
DATE: 11/05/21
JOB NUMBER: 06.002.000



Reviewed By: *[Signature]* Staff Engineer Date: 11/9/2021
Recommended for Approval By: *[Signature]* Administrative Engineer Date: 11/9/2021
Approved By: *[Signature]* City Engineer/ Director of Public Works Date: 11/16/2021

CITY OF BEAUMONT, PUBLIC WORKS DEPARTMENT
ENGINEERING DIVISION

CITY OF BEAUMONT, CALIFORNIA
STREET IMPROVEMENT PLANS
TRACT NO. 31462-25

WEISKOPF WAY
STA: 9+95.67 TO STA: 17+81.73

SHEET
4
OF 5 SHEETS
FILE NO:
3409



SIGNAGE AND STRIPING PER TR. 31462 INFRASTRUCTURE PLANS

GENERAL SIGNAGE/STRIPING NOTES:

1. ALL WORK SHALL BE DONE IN ACCORDANCE WITH THE 2018 CALTRANS DEPARTMENT OF TRANSPORTATION STANDARD SPECIFICATIONS, AND THE RIVERSIDE COUNTY STANDARD PLANS, LATEST EDITION HEREAFTER REFERRED TO AS THE STANDARD SPECIFICATIONS AND STANDARD PLANS UNLESS OTHERWISE SPECIFIED.
2. TRAFFIC STRIPES, RAISED PAVEMENT MARKERS AND SIGNS, (EXCEPT PAVEMENT LEGENDS), SHALL COMPLY WITH THE 2010 MANUAL ON UNIFORM TRAFFIC CONTROL DEVICES (MUTCD).
3. PAVEMENT LEGENDS SHALL EXACTLY MATCH THE CITY OF BEAUMONT STANDARD STENCILS.
4. RAISED PAVEMENT MARKERS SHALL CONFORM TO THE PROVISIONS IN SECTION 85 OF THE CALTRANS DEPARTMENT OF TRANSPORTATION STANDARD SPECIFICATIONS, ENTITLED "PAVEMENT MARKERS". ADHESIVE FOR PAVEMENT MARKERS SHALL CONFORM TO THE PROVISIONS IN SECTION 95-2.04 OF CALTRANS STANDARD SPECIFICATIONS, (2010 EDITION) ENTITLED "RAPID SET EPOXY ADHESIVE FOR PAVEMENT MARKERS".
5. THERMOPLASTIC TRAFFIC STRIPES AND MARKINGS SHALL CONFORM TO THE SECTION 84-2, ENTITLED "THERMOPLASTIC TRAFFIC STRIPES AND PAVEMENT MARKINGS", AS SPECIFIED IN THE CALTRANS DEPARTMENT OF TRANSPORTATION STANDARD SPECIFICATIONS (2010 EDITION).
6. ALL TRAFFIC STRIPING, PAVEMENT LEGENDS AND RAISED PAVEMENT MARKERS THAT CONFLICT OR CONFUSE TRAFFIC AS A RESULT OF THE NEWLY INSTALLED WORK SHOWN ON THIS PLAN SHALL BE REMOVED BY WET SANDBLASTING OR GRINDING AS DIRECTED BY THE ENGINEER.
7. DEBRIS FROM REMOVAL OPERATIONS SHALL BE CONTAINED WITHIN THE WORK AREA AND THE CONTRACTOR SHALL TAKE PRECAUTIONS NECESSARY TO PROTECT PERSONS AND PROPERTY ADJACENT TO THE SANDBLASTING OPERATIONS. THE DEBRIS RESULTING FROM THE SANDBLASTING SHALL BE IMMEDIATELY REMOVED AND DISPOSED OF BY THE CONTRACTOR. DEBRIS WITHIN THE ROADWAY SHALL BE REMOVED BY MECHANICAL SWEEPING OR HIGH-POWER VACUUM.
8. ALL SIGNS SHALL CONFORM TO SECTION 56, ENTITLED "SIGNS", AS SPECIFIED IN THE CALTRANS DEPARTMENT OF TRANSPORTATION STANDARD SPECIFICATIONS (2010 EDITION). SIGNS SHALL BE REFLECTORIZED SHEET ALUMINUM USING HIGH INTENSITY GRADE SHEETING WITH JM #1150 PROTECTIVE OVERLAY FILM OR APPROVED EQUAL. ALL SIGNS SHALL BE MOUNTED WITH THEFT/VANDA-PROOF FASTENERS.
9. ALL SIGNS SHALL BE STANDARD SIZE IN ACCORDANCE WITH THE 2010 MUTCD, EXCEPT PARKING RELATED SIGNS SHALL BE 12' x 18".
10. PER GOVERNMENT CODE SECTION 4216, IF THE WORK IN AN AREA WHICH IS KNOWN, OR REASONABLY SHOULD KNOW, TO CONTAIN SUBSURFACE INSTALLATIONS, CONTRACTOR SHALL CONTACT UNDERGROUND SERVICE ALERT (U.S.A.) AT 1-800-227-2600 AND OBTAIN AN INQUIRY IDENTIFICATION NUMBER AT LEAST TWO WORKING DAYS (48 HOURS) PRIOR TO COMMENCING ANY WORK THAT PENETRATES THE EXISTING SURFACE.
11. STRIPING LAYOUT SHALL BE APPROVED BY THE CITY PUBLIC WORKS DEPARTMENT PRIOR TO APPLICATION OF THE THERMOPLASTIC MATERIAL. CONTACT THE CITY PUBLIC WORKS DEPARTMENT CITY INSPECTOR AT (951) 769-8520 EXT. 250 (BEAUMONT) 2 WORKING DAYS PRIOR TO LAYOUT.
12. STEEL SIGN POSTS INSTALLED IN CONCRETE AREAS SHALL BE INSTALLED IN METAL SLEEVES TO FACILITATE REPLACEMENT. ALL POSTS SHALL BE 2" TELSPAR POSTS UNLESS NOTED OTHERWISE.

CONSTRUCTION NOTES

13. INSTALL R1 STOP SIGN ON STREET NAME SIGN POST
14. THERMOPLASTIC WHITE LIMIT LINE PER CALTRANS STANDARD A24E
15. THERMOPLASTIC "STOP" PAVEMENT MARKING PER CALTRANS STANDARD A24D

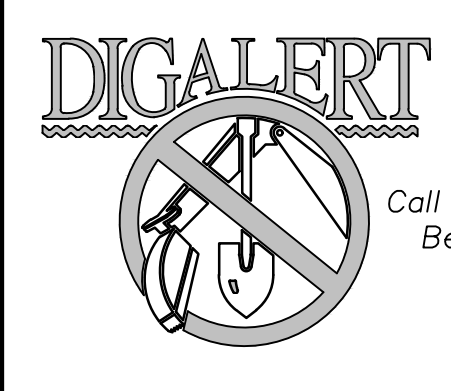
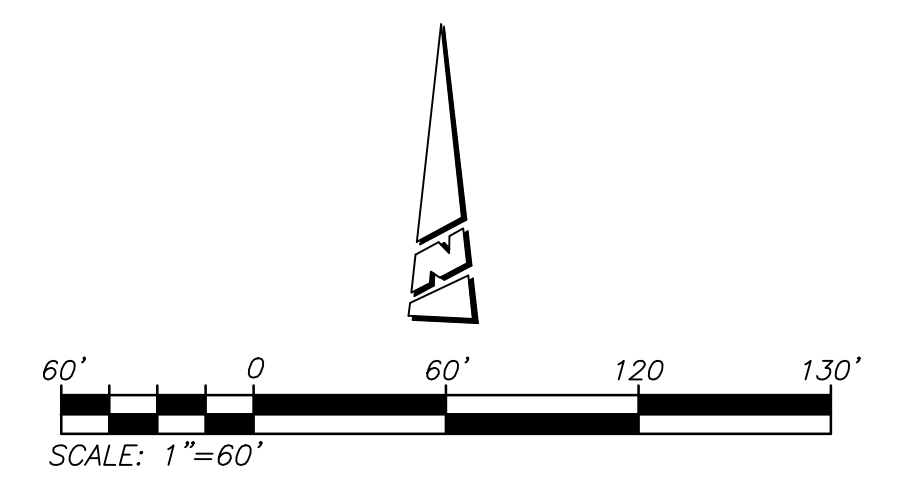

Call 2 Working Days Before You Dig! 811

BENCHMARK:
 DESCRIPTION: USGS MONUMENT "REST" BENCHMARK DISK SET IN TOP OF CONCRETE MONUMENT STAMPED "REST 1972" ON DESERT LAWN DRIVE ACROSS THE DRIVE FROM DESERT LAWN CEMETERY 25.3 FT. N.E. OF THE DRIVE CENTERLINE 24.9 FT. S.W. OF THE S.W. EDGE OF THE SOUTH EASTBOUND LANES OF INTERSTATE HIGHWAY 10
 ELEV. 2491.44, NGVD 29

BY	MARK	DESCRIPTION	APPR.	DATE
ENGINEER		REVISIONS	CITY	

PROACTIVE ENGINEERING WEST
 CONSULTANTS WEST, INC.
 25109 JEFFERSON AVE, SUITE 200
 HUNTERTA, CA 92562
 951-200-0660

George Alan Lenfestey
 No. 45920 Exp. 12/31/22
 CIVIL
 STATE OF CALIFORNIA

11/05/21
 DATE

DESIGN BY: PEC
 DRAWN BY: PEC
 CHECKED BY: PEC
 SCALE: AS NOTED
 DATE: 11/05/21
 JOB NUMBER: 06.002.000

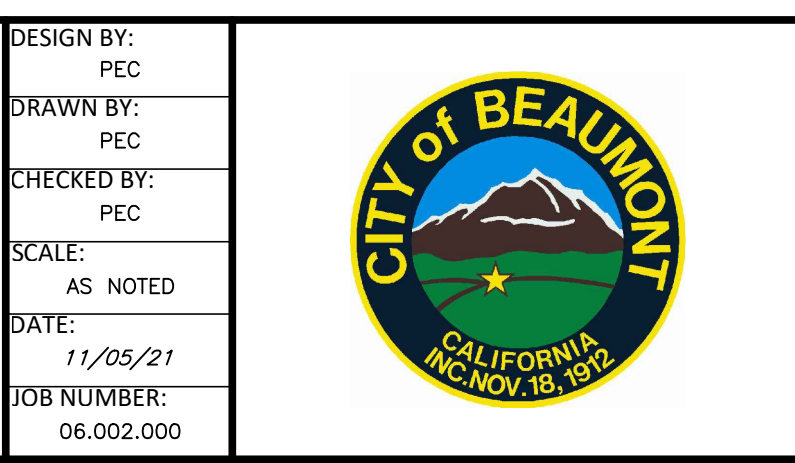

Reviewed By: *[Signature]* Staff Engineer Date: 11/9/2021
 Recommended for Approval By: *[Signature]* Administrative Engineer Date: 11/9/2021
 Approved By: *[Signature]* City Engineer/Director of Public Works Date: 11/16/2021

CITY OF BEAUMONT, PUBLIC WORKS DEPARTMENT
 ENGINEERING DIVISION

CITY OF BEAUMONT, CALIFORNIA
 STREET IMPROVEMENT PLANS
 TRACT NO. 31462-25

SIGNAGE AND STRIPING

SHEET
 5
 OF 5 SHEETS
 FILE NO: 3409

DWG: N:\05-002-000\Drawings\Street Improvements\TC Phase 4\31462-25_ST_IMP_PLANS\31462-25-ST-517-05.dwg
 PLOT: Nov 05, 2021 11:23:06 AM
 mcszama