



St. Croix Recreation Fun Playgrounds Inc.
1826 Tower Dr W | Stillwater, MN 55082 | 651-430-1247

Proposal 100-196665-1 | 2/5/2025



February 05, 2025

Alex Hondl
City of Baxter
13190 Memorywood Dr,
Baxter, MN 56425

Dear Alex Hondl:

St. Croix Recreation Fun Playgrounds Inc. is delighted to provide City of Baxter with this playground equipment proposal.

This design was developed with your specific needs in mind, and we look forward to discussing this project further with you to ensure your complete satisfaction. St. Croix Recreation Fun Playgrounds Inc. is confident that this proposal will satisfy City of Baxter's functional, environmental, and safety requirements -- and most importantly -- bring joy and excitement to the children and families directly benefiting from your new playground.

You have our personal commitment to support this project and your organization in every manner possible, and we look forward to developing a long-standing relationship with City of Baxter. We appreciate your consideration and value this opportunity to earn your business.

Sincerely,

Christopher Armitage
Sales Representative

St. Croix Recreation Fun Playgrounds Inc.
1826 Tower Dr W
Stillwater, MN 55082
www.funplaygrounds.com
www.bciburke.com

Phone: 651-430-1247
Fax: -
ca@stcroixrec.com

COOPERATIVE PURCHASING OPTIONS

PLAYGROUNDS WITHOUT ALL THE PAPERWORK

Purchasing with contracts may sound intimidating, but getting your community playspace doesn't need to be a painful process of writing specifications, issuing RFP's and jumping through hoops – it can be simplified – we promise! As you continue planning for your new playground, review the Purchasing Contracts offered through our partners.

EQUALIS GROUP

Equalis is an innovative cooperative purchasing organization that believes in the power of partnership and that when you work together you achieve more. The basic premise of the Equalis cooperative purchasing organization is to leverage the combined buying power of all members for better pricing and favorable contract terms. Equalis Group uses the lead agency model for competitively bid contracts, provides our participants the savings they expect and offers efficiencies and peace of mind within the procurement process. It is our mission to continuously improve the measurable and meaningful impact of cooperative services for everyone throughout the supply chain.

GOVMVMT

GOVMVMT is a non-profit group purchasing organization that meets the highest industry standards while putting the public's interest at the forefront of everything they do. Each one of GOVMVMT's first-class suppliers has consciously joined their mission to create the most credible, ethical, and public agency-focused non-profit cooperative purchasing program in the country.

GSA

Federal parks, child development programs, military bases and other agencies are a major priority for BCI Burke, and agencies can purchase Burke playgrounds through Burke's GSA contract for installation virtually anywhere in the world.

OMNIA PARTNERS

OMNIA Partners, Public Sector (Subsidiary National IPA) is the largest and most experienced organization in purchasing and supply chain management. Comprised of participants and suppliers in the public sector, we bring together industry-leading buying power and world-class suppliers to offer an extensive portfolio of competitively solicited and publicly awarded contracts and partnerships. OMNIA Partners is proud to offer more value and resources to state and local government, higher education, K-12 education and non-profits.

SOURCEWELL

As a leader in cooperative purchasing, Sourcewell is passionate about helping members fulfill their public service missions. Sourcewell builds strong relationships with members and vendors to develop practical solutions together.

The easiest way to Join Our Movement is to call your local Representative at 800.266.1250 or visit bciburke.com/rep. Our passion is bringing play to communities like yours and we can't wait to help you get started!



FEATURED PLAY EVENTS



Arched Catwalk Bridge

Bridges appeal to kids' imagination and urge to explore while playing on the playground.



Verto Climber 1

Burke's unique Verto Climbers have one, two or three climbing sections that can be combined in various configurations for unlimited adventures!



CONTOUR™ SLIDE

The Contour™ Slide offers the ability for kids to slide together and get a sensory experience all in one place. As they slide, kids can put their hands in the middle to feel how the contours change on the way down!

FEATURED PLAY EVENTS



Hide the Numbers Game

Cognitive development and cooperative play shine with the Hide the Numbers Game! A great way to encourage intergenerational play and help children learn numbers, addition and strategy, this panel will bring educational fun to any playspace!



Freedom Swing Seat

The Freedom inclusive Swing Seat allows children of all abilities to enjoy the childhood joy of swinging in a safe and secure seat.

DESIGN SUMMARY

St. Croix Recreation Fun Playgrounds Inc. is very pleased to present this Proposal for consideration for the Southdale Park located in Baxter. BCI Burke Company, LLC has been providing recreational playground equipment for over 100 years and has developed the right mix of world-class capabilities to meet the initial and continuing needs of City of Baxter. We believe our proposal will meet or exceed your project's requirements and will deliver the greatest value to you.

The following is a summary of some of the key elements of our Proposal:

- Project Name: Southdale Park
- Project Number: 100-196665-1
- User Capacity: 131
- Age Groups: 5 to 12, 2 to 5, 2 to 12
- Dimensions: 75' 8"x59' 9"
- Designer Name: Kathleen Yttri

St. Croix Recreation Fun Playgrounds Inc. has developed a custom playground configuration based on the requirements as they have been presented for the Southdale Park playground project. Our custom design will provide a safe and affordable playground environment that is aesthetically pleasing, full of fun for all users and uniquely satisfies your specific requirements. In addition, proposal # 100-196665-1 has been designed with a focus on safety, and is fully compliant with ASTM F1487 and CPSC playground safety standards.

We invite you to review this proposal for the Southdale Park playground project and to contact us with any questions that you may have.

Thank you in advance for giving us the opportunity to make this project a success.

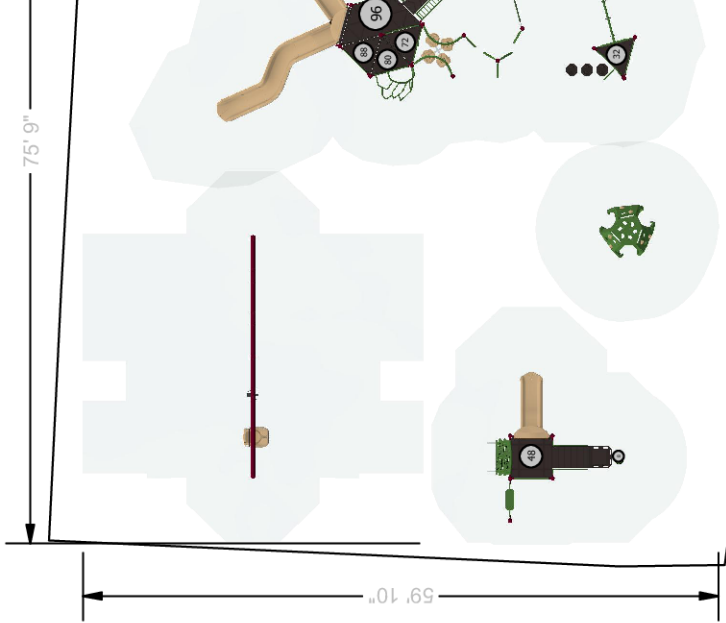

PLAYGROUND ACCESSIBILITY (Provided)

| TOTAL ELEVATED EVENTS | TRANSFER ACCESSIBLE EVENTS | RAMP ACCESSIBLE EVENTS |
|-----------------------|----------------------------|------------------------|
| 23 | 13 / 7 | 0 / 0 |

OVERALL BOUNDING OF USE ZONES **The space requirements shown here are to ASTM standards. Requirements for other standards may be different.

Area: 4531.1 sq.ft.
Perimeter: 271.1 ft.

STRUCTURE SIZE: 10"x75' 9"
POST SIZE(S):

Warning: Accessible safety surfacing material is required beneath and around this equipment that is compliant with A

SOUTHDALE PARK
MN 56425

ke Basics | Nucleus | Intensity

SITE PLAN VIEW

Structure|Freestanding

Southdale Park
Baxter, MN 56425

02/05/2025

AGES:
12



St. Croix Recreation Fun Playgrounds
100-196665-1

Designer: Kathleen Yttri

BCI BURKE COMPANY, LLC | PO BOX 549 FOND DU LAC, WI 54936-0549 | 920.921.9220 | BCIBURKE.COM

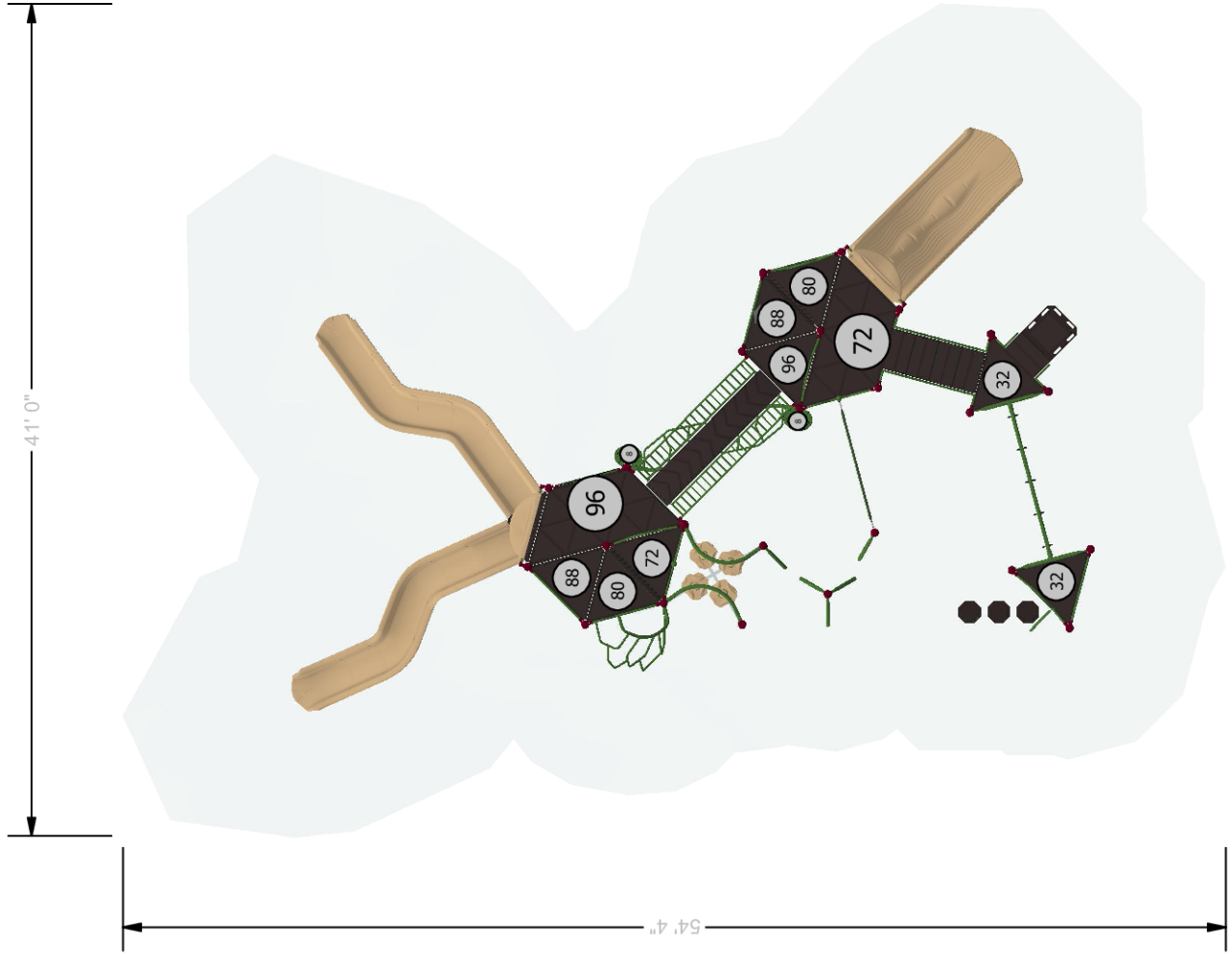

The use and layout of play components identified in this plan conform to the CPSC guidelines. U.S. CPSC recommends the separation of age groups in playground layouts.

| PLAYGROUND ACCESSIBILITY (Provided/Required) | | | |
|--|----------------------------|------------------------|------------------------|
| TOTAL ELEVATED EVENTS | TRANSFER ACCESSIBLE EVENTS | RAMP ACCESSIBLE EVENTS | TYPES OF GROUND EVENTS |
| 23 | 12 / 0 | 0 / 0 | 11 / 4 / 6 / 3 |

OVERALL BOUNDING OF USE ZONES
 Area: 4531.1 sq. ft.
 Perimeter: 271.1 ft.
STRUCTURE SIZE: 10"x75' 9"
POST SIZE(S):

**The space requirements shown here are to ASTM standards. Requirements for other standards may be different.

Warning: Accessible safety surfacing material is required beneath and around this equipment that is compliant with ASTM, CPSC, and ADAAG requirements.

| | |
|--|---|
| SERIES Nucleus Intensity | SITE PLAN VIEW |
| GROUP: 5-12 Structure | 02/05/2025 |
| DESIGNED FOR AGES: 5 to 12 | St. Croix Recreation Fun Playgrounds 100-196665-1 |
| Southdale Park Baxter, MN 56425 | Designer: Kathleen Yttri |
| Burke PLAY THAT MOVES YOU. | |
| BCI BURKE COMPANY, LLC PO BOX 549 FOND DU LAC, WI 54936-0549 920.921.9220 BCIBURKE.COM | |

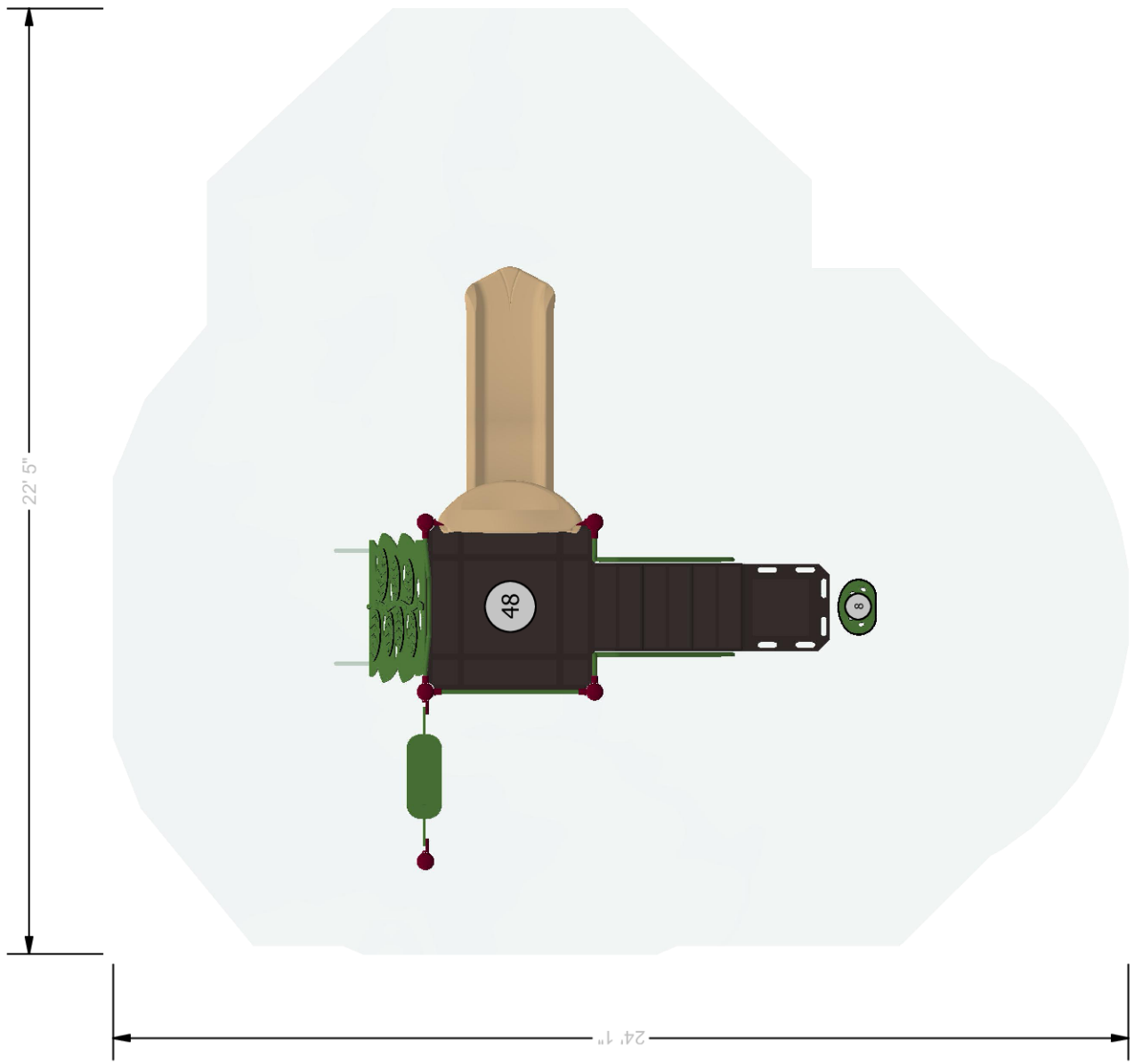

The use and layout of play components identified in this plan conform to the CPSC guidelines. U.S. CPSC recommends the separation of age groups in playground layouts.

| PLAYGROUND ACCESSIBILITY (Provided/Required) | | | |
|--|----------------------------|------------------------|------------------------|
| TOTAL ELEVATED EVENTS | TRANSFER ACCESSIBLE EVENTS | RAMP ACCESSIBLE EVENTS | TYPES OF GROUND EVENTS |
| 23 | 13 / 7 | 0 / 0 | 11 / 4 6 / 3 |

OVERALL BOUNDING OF USE ZONES **The space requirements shown here are to ASTM standards. Requirements for other standards may be different.

Area: 4531.1 sq. ft.
Perimeter: 271.1 ft.
STRUCTURE SIZE: 10'x75' 9"
POST SIZE(S):

Warning: Accessible safety surfacing material is required beneath and around this equipment that is compliant with ASTM, CPSC, and ADAAG requirements.

SERIES Nucleus | Burke Basics

SITE PLAN VIEW

GROUP:
2-5 Structure

Southdale Park
Baxter, MN 56425

02/05/2025

DESIGNED FOR AGES:
2 to 5



St. Croix Recreation Fun Playgrounds
100-196665-1

Designer: Kathleen Yttri

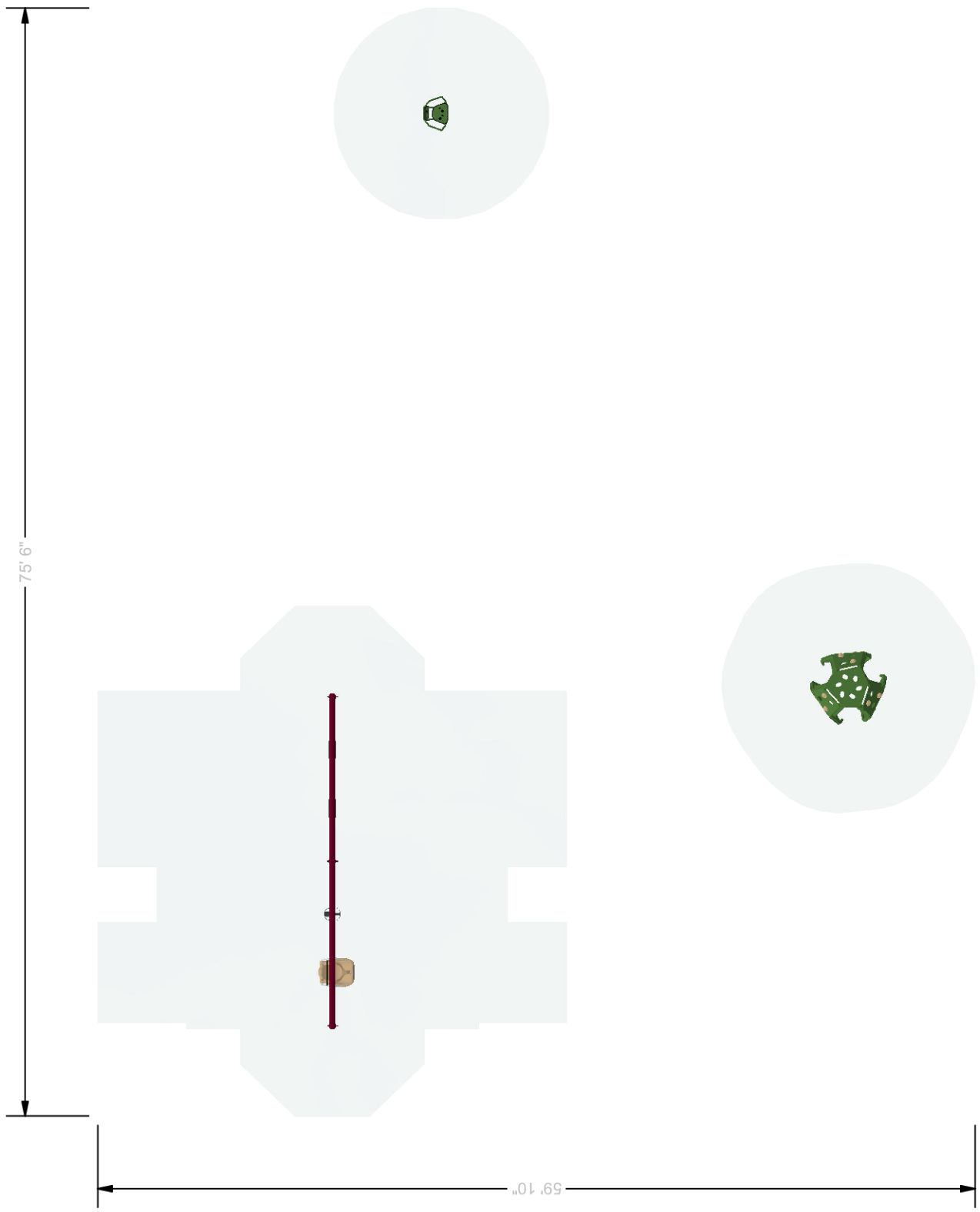

The use and layout of play components identified in this plan conform to the CPSC guidelines. U.S. CPSC recommends the separation of age groups in playground layouts.

| PLAYGROUND ACCESSIBILITY (Provided/Required) | | | |
|--|----------------------------|------------------------|------------------------|
| TOTAL ELEVATED EVENTS | TRANSFER ACCESSIBLE EVENTS | RAMP ACCESSIBLE EVENTS | TYPES OF GROUND EVENTS |
| 23 | 13 / 7 | 0 / 0 | 11 / 4 6 / 3 |

OVERALL BOUNDING OF USE ZONES
 Area: 4531.1 sq. ft.
 Perimeter: 271.1 ft.
STRUCTURE SIZE: 10'x75' 9"
POST SIZE(S):

**The space requirements shown here are to ASTM standards. Requirements for other standards may be different.

Warning: Accessible safety surfacing material is required beneath and around this equipment that is compliant with ASTM, CPSC, and ADAAG requirements.

SERIES Burke Basics

SITE PLAN VIEW

GROUP:
Freestanding

Southdale Park
Baxter, MN 56425

02/05/2025

DESIGNED FOR AGES:
2 to 12



St. Croix Recreation Fun Playgrounds
100-196665-1

Designer: Kathleen Yttri

| ITEM | COMP. | DESCRIPTION |
|------|----------|--------------------------------------|
| 1 | 270-0219 | ARCHED CATWALK BRIDGE 96" |
| 2 | 270-0129 | TRIANGLE PLATFORM |
| 3 | 270-0132 | HALF HEXAGON PLATFORM |
| 4 | 270-0299 | ABSTRACT PLATFORM LADDER 24" |
| 5 | 270-0112 | UNITARY ENCLOSURE |
| 6 | 370-0171 | TRANGO CLIMBER, CENTER MOUNT TO POST |
| 7 | 270-0266 | CENTER MOUNT ENCLOSURE |
| 8 | 370-0854 | VERTO CLIMBER 1 |
| 9 | 370-0469 | 40" TRANSITION STAIR W/BARRIERS |
| 10 | 370-0413 | LONG STR RING SWING OH, DK- DK |
| 11 | 370-0270 | POD WALK 32" |
| 12 | 570-0394 | PIPE WALL |
| 13 | 370-1657 | TRANSFER STATION, HANDRAIL 32" |
| 14 | 470-0803 | CONTOUR SLIDE, 64"-72" |
| 15 | 270-0009 | 8" CLOSURE PLATE, ELLIPSE |
| 16 | 370-0872 | TREE BRANCH CLIMBER 80" |
| 17 | 570-0398 | STEERING WHEEL ASSEMBLY |
| 18 | 370-1683 | S HORIZONTAL LADDER, NUCLEUS |
| 19 | 370-1608 | OVISTEP LAUNCH PAD |
| 20 | 570-2713 | HIDE THE NUMBERS PANEL |
| 21 | 470-0573 | VIPER II SS 96 |
| 22 | 370-1721 | ION CLIMBER 64"-80" |
| 23 | 270-0001 | OFFSET ENCLOSURE |
| 24 | 370-1733 | PODSTEP CLIMBER 64"-72" |
| 25 | 370-0851 | VERTO CLIMBER 3 FS |

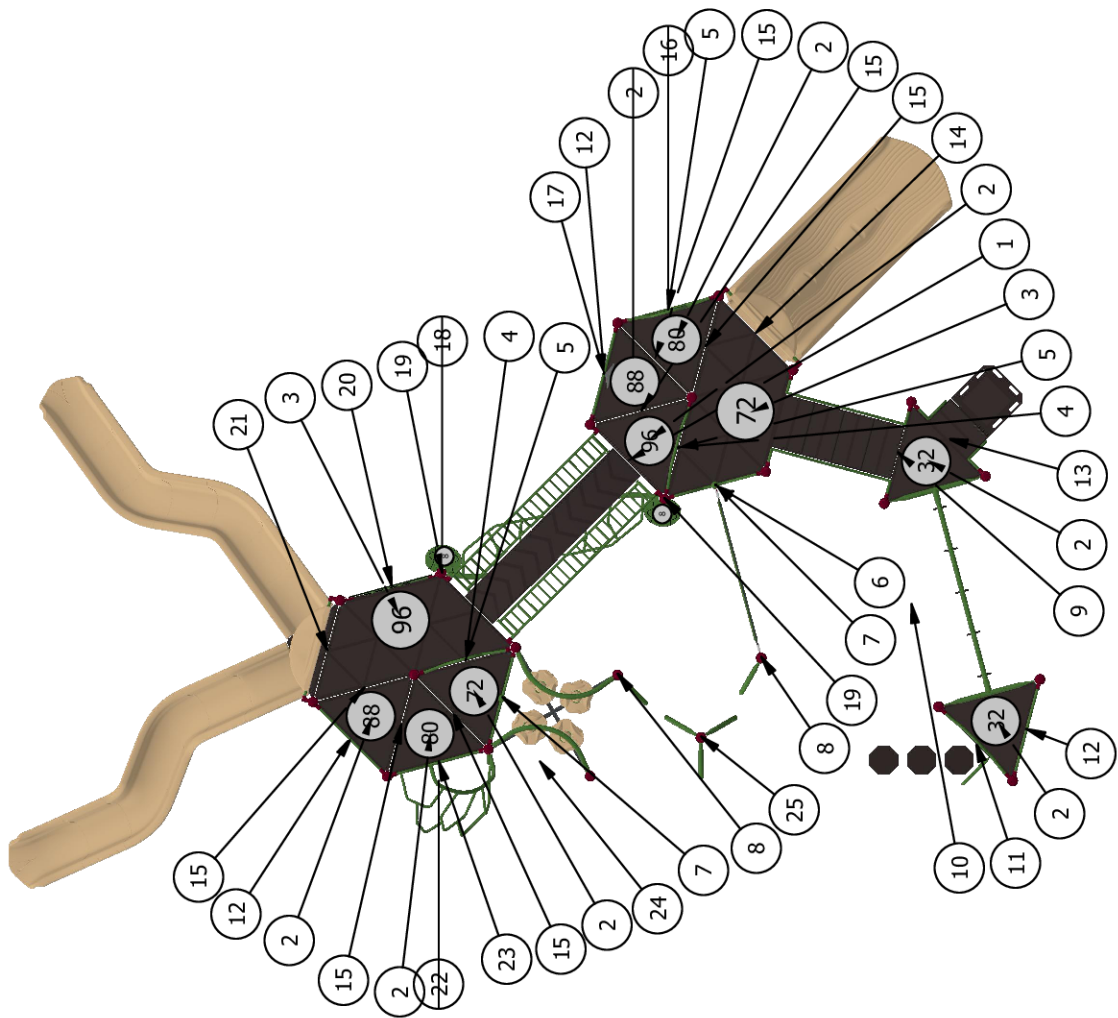

SERIES Nucleus | Intensity

GROUP:
5-12 Structure

DESIGNED FOR AGES:
5 to 12

Southdale Park
Baxter, MN 56425

Burke
PLAY THAT MOVES YOU

COMPONENT VIEW

02/05/2025

St. Croix Recreation Fun Playgrounds
100-19665-1

Designer: Kathleen Yttri

| ITEM | COMP. | DESCRIPTION |
|------|----------|---------------------------------------|
| 1 | 270-0130 | SQUARE PLATFORM |
| 2 | 570-0557 | COUNTER PANEL, BELOW PLATFORM |
| 3 | 570-0394 | PIPE WALL |
| 4 | 370-1662 | TRANSFER STATION, BARRIER 48" |
| 5 | 580-1364 | LIL. NOVO BEAN STEP |
| 6 | 470-0659 | ROCK'N ROLL SLIDE, 40" - 48" W/O HOOD |
| 7 | 470-0967 | SLIDE HOOD, LOW SIDE WALL |
| 8 | 370-0805 | JUNGLE VINE CLIMBER 48" |
| 9 | 270-0112 | UNITARY ENCLOSURE |

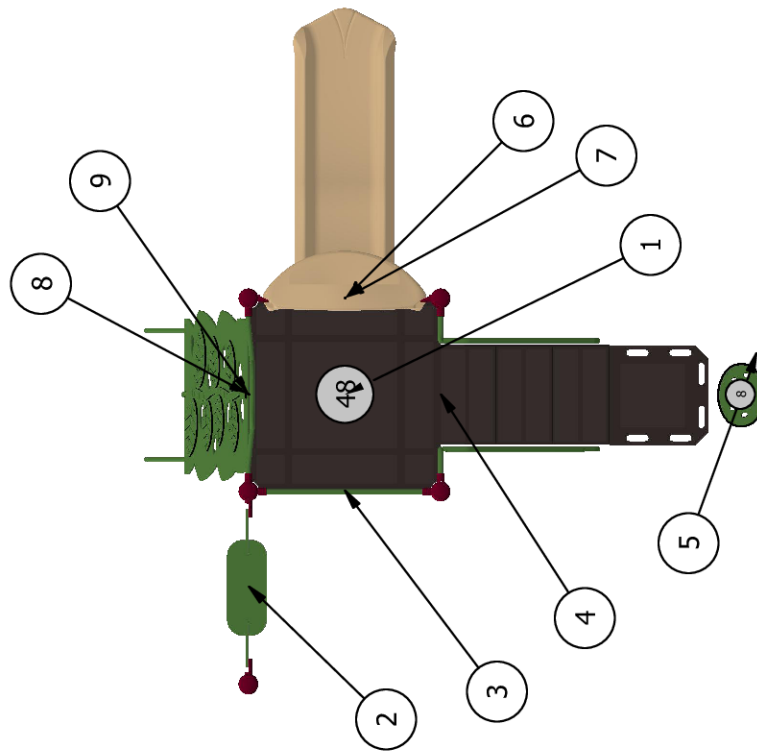

SERIES Nucleus | Burke Basics

COMPONENT VIEW

GROUP:
2-5 Structure

Southdale Park
Baxter, MN 56425

02/05/2025

DESIGNED FOR AGES:
2 to 5

St. Croix Recreation Fun Playgrounds
100-196665-1

Burke
PLAY THAT MOVES YOU

Designer: Kathleen Yttri

| ITEM | COMP. | DESCRIPTION |
|------|----------|--|
| 1 | 550-0201 | SINGLE POST SWING ASSEMBLY 5" OD |
| 2 | 550-0202 | SINGLE POST SWING ADD-ON 5" OD |
| 3 | 550-0111 | BELT SEAT, 8' SINGLE, STD CHAIN |
| 4 | 550-0171 | FREEDOM SWING SEAT, 8' BEAM, STD CHAIN |
| 5 | 550-0099 | TOT SEAT, 7' & 8' SINGLE, STD CHAIN |
| 6 | 560-0061 | FORMIS DOME |
| 7 | 560-2735 | ARO SPINNING CHAIR |

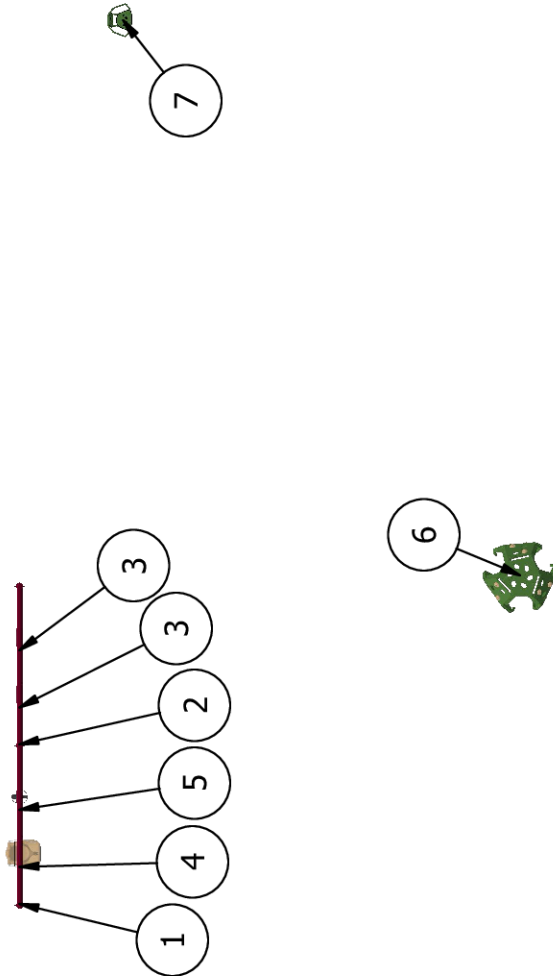

SERIES Burke Basics

COMPONENT VIEW

GROUP:
Freestanding

Southdale Park
Baxter, MN 56425

02/05/2025

DESIGNED FOR AGES:
2 to 12

St. Croix Recreation Fun Playgrounds
100-196665-1

Burke
PLAY THAT MOVES YOU

Designer: Kathleen Yttri

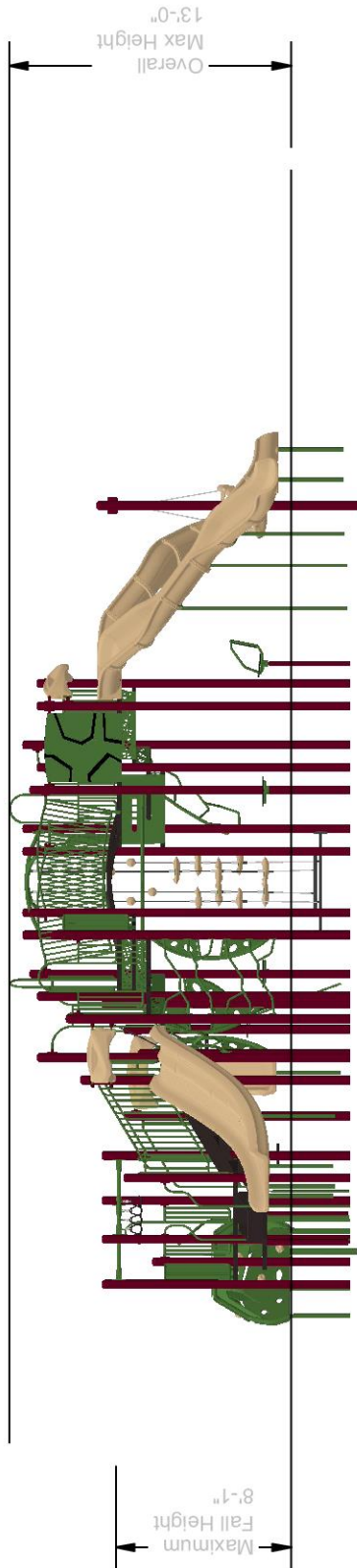

SERIES Burke Basics | Nucleus | Intensity

ELEVATION VIEW

GROUP:
5-12 Structure|2-5 Structure|Freestanding

Southdale Park
Baxter, MN 56425

02/05/2025

DESIGNED FOR AGES:
5 to 12, 2 to 5, 2 to 12

Burke
PLAY THAT MOVES YOU

St. Croix Recreation Fun Playgrounds
100-19665-1

Designer: Kathleen Yttri

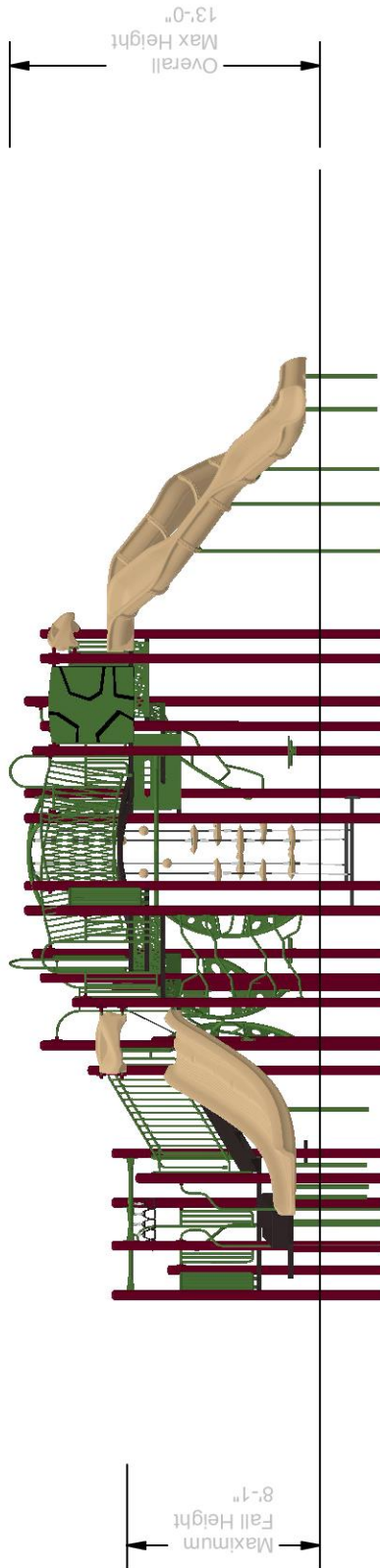

SERIES Nucleus | Intensity

ELEVATION VIEW

GROUP:
5-12 Structure

Southdale Park
Baxter, MN 56425

02/05/2025

DESIGNED FOR AGES:
5 to 12

St. Croix Recreation Fun Playgrounds
100-19665-1

Burke
PLAY THAT MOVES YOU

Designer: Kathleen Yttri

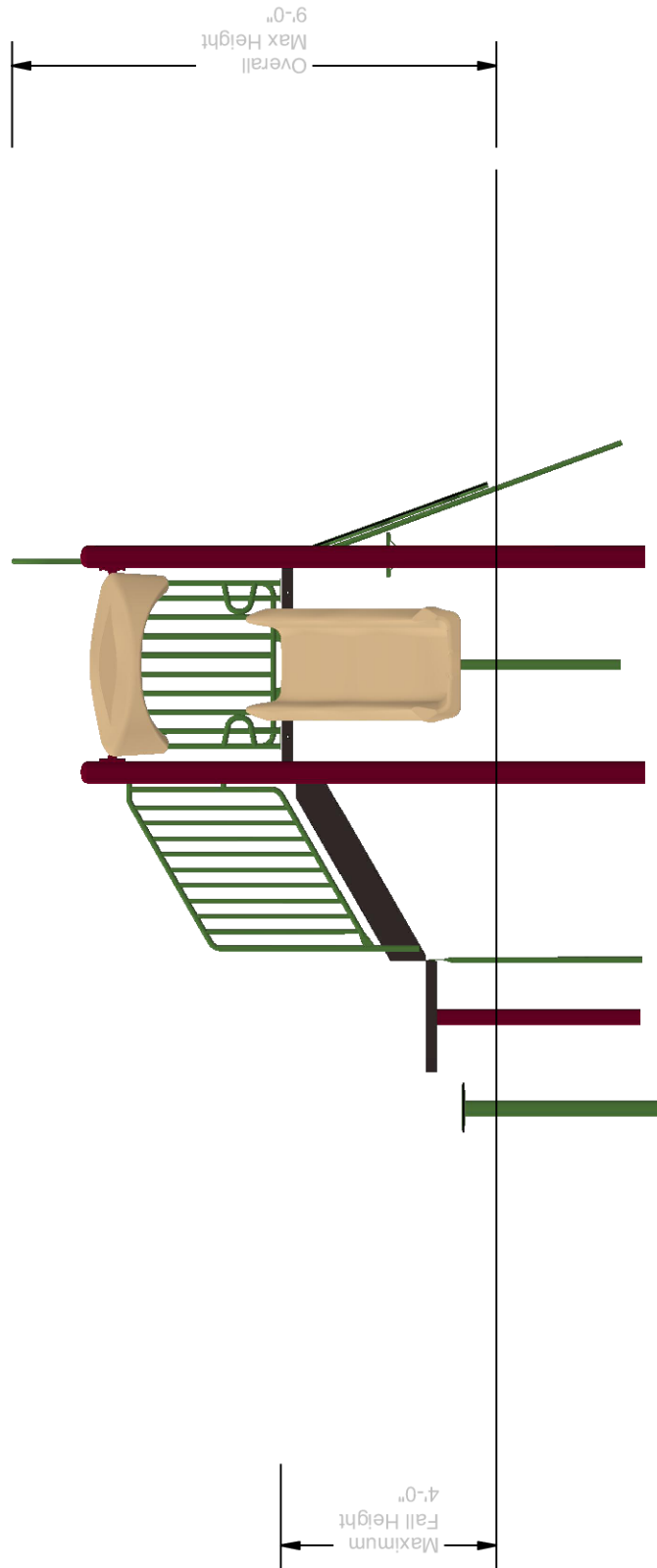

SERIES Nucleus | Burke Basics

ELEVATION VIEW

GROUP:
2-5 Structure

Southdale Park
Baxter, MN 56425

02/05/2025

DESIGNED FOR AGES:
2 to 5

Burke
PLAY THAT MOVES YOU

St. Croix Recreation Fun Playgrounds
100-19665-1

Designer: Kathleen Yttri

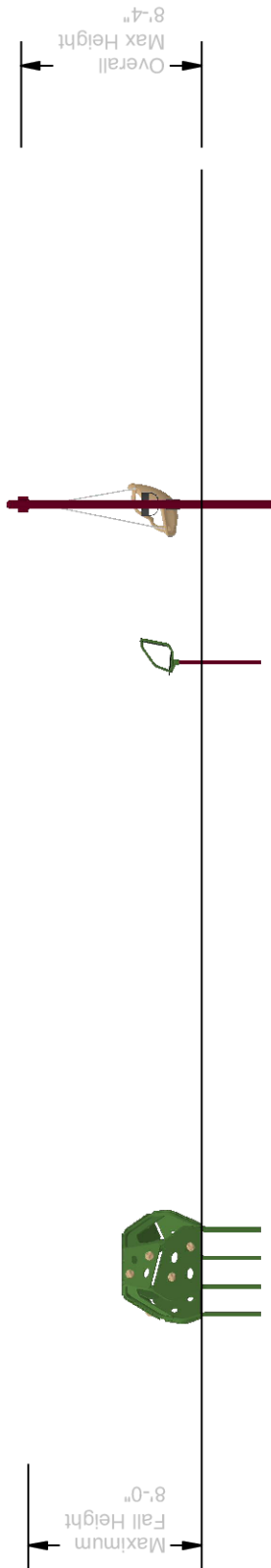

SERIES Burke Basics

ELEVATION VIEW

GROUP:
Freestanding

Southdale Park
Baxter, MN 56425

02/05/2025

DESIGNED FOR AGES:
2 to 12

Burke
PLAY THAT MOVES YOU

St. Croix Recreation Fun Playgrounds
100-19665-1

Designer: Kathleen Yttri

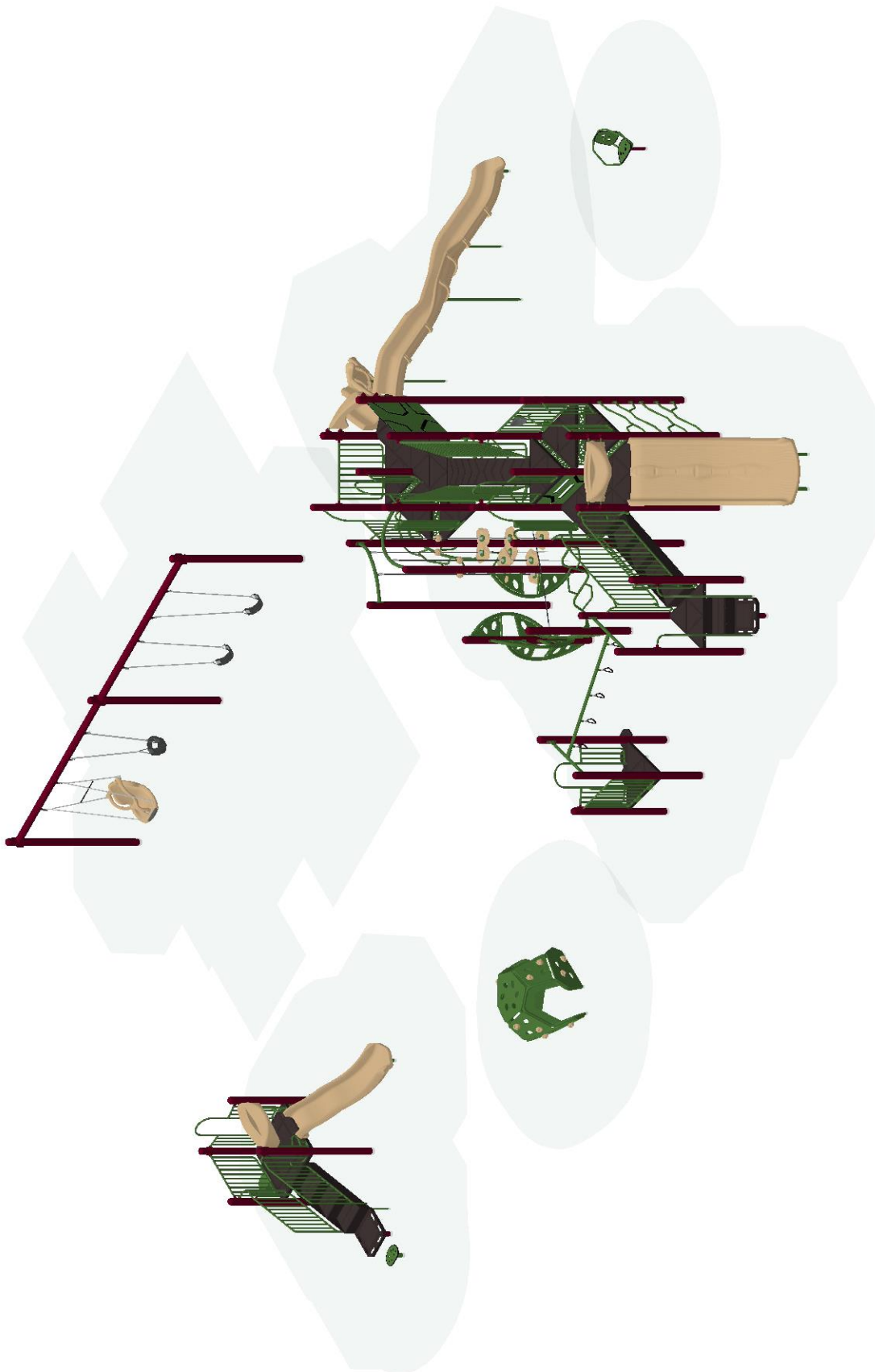

SERIES Burke Basics | Nucleus | Intensity

ISOMETRIC VIEW

GROUP:
5-12 Structure|2-5 Structure|Freestanding

Southdale Park
Baxter, MN 56425

02/05/2025

DESIGNED FOR AGES:
5 to 12, 2 to 5, 2 to 12

St. Croix Recreation Fun Playgrounds
100-196665-1

Designer: Kathleen Yttri

Burke
PLAY THAT MOVES YOU

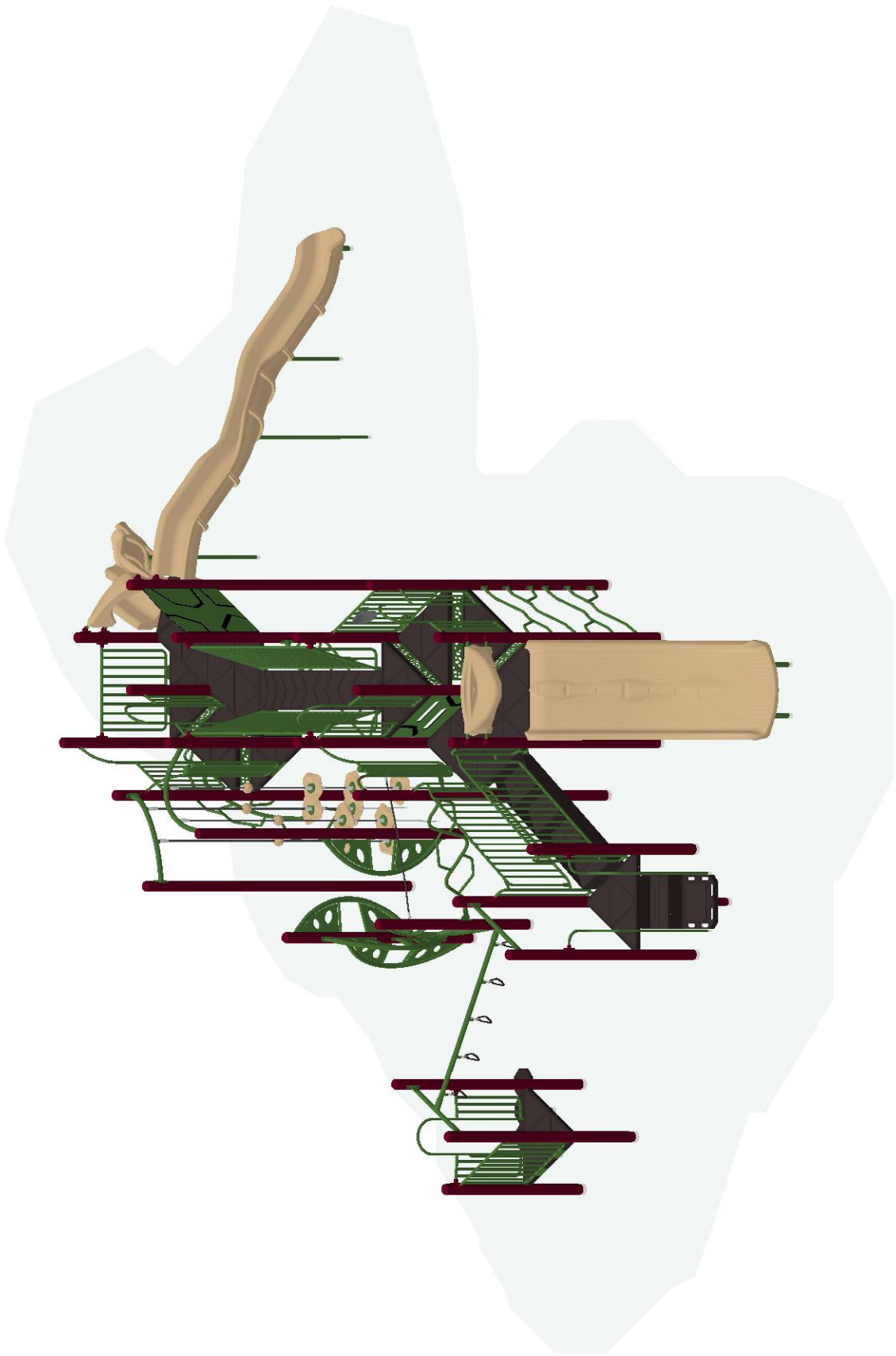

SERIES Nucleus | Intensity

ISOMETRIC VIEW

GROUP:
5-12 Structure

Southdale Park
Baxter, MN 56425

02/05/2025

DESIGNED FOR AGES:
5 to 12

St. Croix Recreation Fun Playgrounds
100-196665-1

Designer: Kathleen Yttri

Burke
PLAY THAT MOVES YOU

BCI BURKE COMPANY, LLC | PO BOX 549 FOND DU LAC, WI 54936-0549 | 920.921.9220 | BCIBURKE.COM

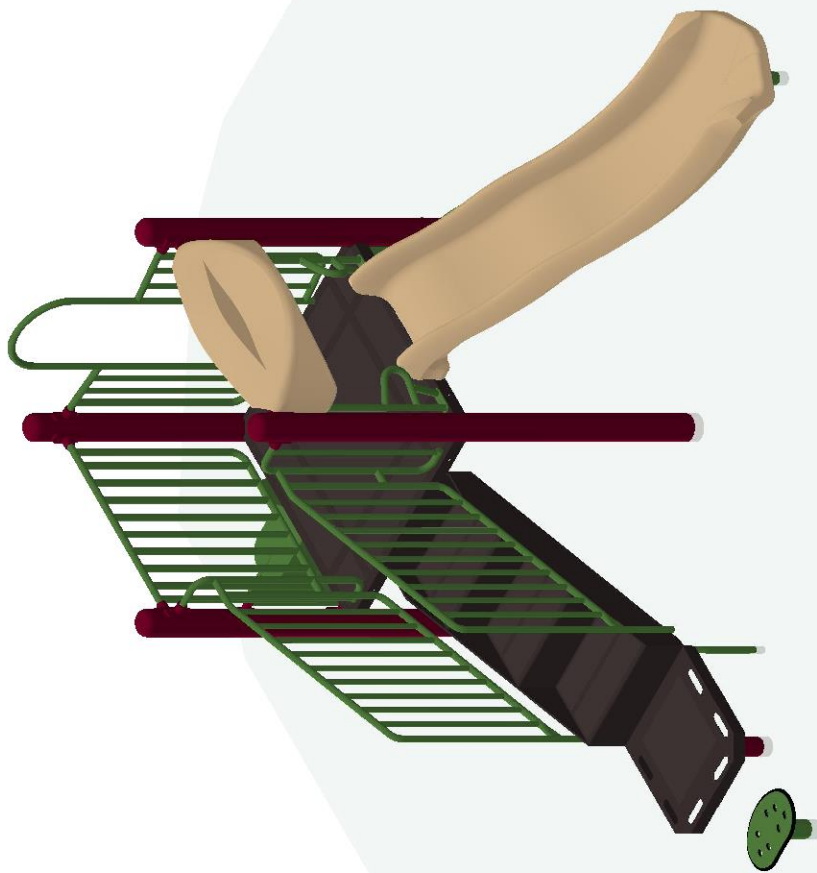

SERIES Nucleus | Burke Basics

GROUP:
2-5 Structure

DESIGNED FOR AGES:
2 to 5

Southdale Park
Baxter, MN 56425

Burke
PLAY THAT MOVES YOU

ISOMETRIC VIEW

02/05/2025

St. Croix Recreation Fun Playgrounds
100-196665-1

Designer: Kathleen Yttri

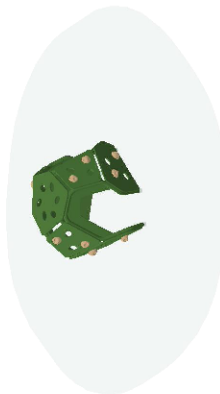
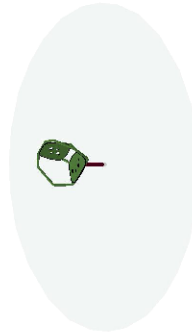
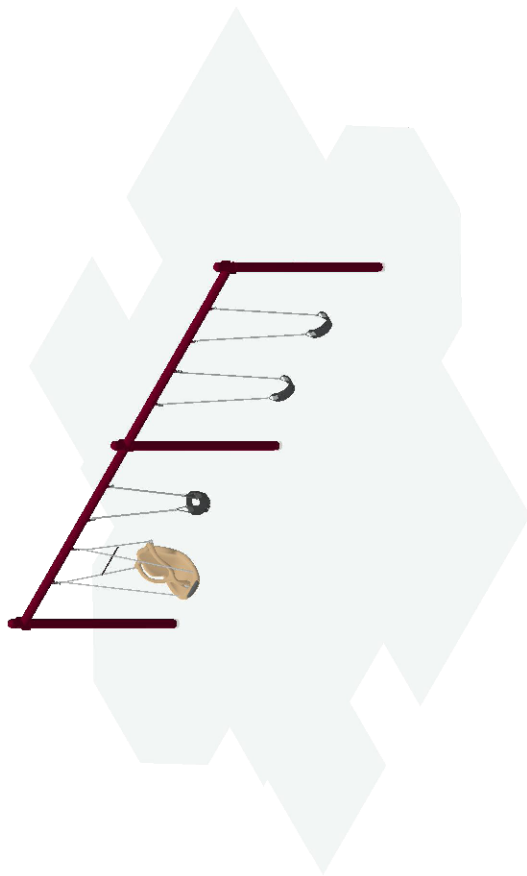

SERIES Burke Basics

GROUP:
Freestanding

DESIGNED FOR AGES:
2 to 12

Southdale Park
Baxter, MN 56425

Burke
PLAY THAT MOVES YOU

ISOMETRIC VIEW

02/05/2025

St. Croix Recreation Fun Playgrounds
100-19665-1

Designer: Kathleen Yttri

Proposal 100-196665-1 | 2/5/2025 | 2025 Pricing

The play components identified in this proposal are IPEMA certified. The use and layout of these components conform to the requirements of ASTM F1487. To verify product certification, visit www.ipema.org.



The space requirements shown in this proposal are to ASTM standards. Requirements for other standards may be different.

5-12 Structure

Nucleus

| Component No. | Description | Qty | User Cap. | Ext. User Cap. | Weight | Ext. Weight |
|---------------|--------------------------------------|-----|-----------|----------------|--------|-------------|
| 072-0500-108C | 5" OD X 108" CAPPED POST | 1 | 0 | 0 | 57 | 57 |
| 072-0500-116C | 5" OD X 116" CAPPED POST | 1 | 0 | 0 | 61 | 61 |
| 072-0500-124C | 5" OD X 124" CAPPED POST | 1 | 0 | 0 | 65 | 65 |
| 072-0500-136C | 5" OD X 136" CAPPED POST | 5 | 0 | 0 | 71 | 355 |
| 072-0500-148C | 5" OD X 148" CAPPED POST | 1 | 0 | 0 | 78 | 78 |
| 072-0500-156C | 5" OD X 156" CAPPED POST | 1 | 0 | 0 | 82 | 82 |
| 072-0500-164C | 5" OD X 164" CAPPED POST | 1 | 0 | 0 | 86 | 86 |
| 072-0500-172C | 5" OD X 172" CAPPED POST | 5 | 0 | 0 | 90 | 450 |
| 072-0500-176C | 5" OD X 176" CAPPED POST | 3 | 0 | 0 | 92 | 276 |
| 072-0500-180C | 5" OD X 180" CAPPED POST | 5 | 0 | 0 | 94 | 470 |
| 270-0001 | OFFSET ENCLOSURE | 1 | 0 | 0 | 30 | 30 |
| 270-0009 | 8" CLOSURE PLATE, ELLIPSE | 6 | 0 | 0 | 8 | 48 |
| 270-0112 | UNITARY ENCLOSURE | 3 | 0 | 0 | 34 | 102 |
| 270-0129 | TRIANGLE PLATFORM | 8 | 2 | 16 | 48 | 384 |
| 270-0132 | HALF HEXAGON PLATFORM | 2 | 6 | 12 | 144 | 288 |
| 270-0219 | ARCHED CATWALK BRIDGE 96" | 1 | 6 | 6 | 368 | 368 |
| 270-0266 | CENTER MOUNT ENCLOSURE | 2 | 0 | 0 | 43 | 86 |
| 270-0299 | ABSTRACT PLATFORM LADDER 24" | 2 | 1 | 2 | 24 | 48 |
| 370-0171 | TRANGO CLIMBER, CENTER MOUNT TO POST | 1 | 5 | 5 | 33 | 33 |
| 370-0270 | POD WALK 32" | 1 | 3 | 3 | 124 | 124 |
| 370-0413 | LONG STR RING SWING OH, DK- DK | 1 | 5 | 5 | 61 | 61 |
| 370-0469 | 40" TRANSITION STAIR W/BARRIERS | 1 | 4 | 4 | 279 | 279 |
| 370-0872 | TREE BRANCH CLIMBER 80" | 1 | 4 | 4 | 33 | 33 |
| 370-1657 | TRANSFER STATION, HANDRAIL 32" | 1 | 4 | 4 | 135 | 135 |
| 370-1721 | ION CLIMBER 64"-80" | 1 | 2 | 2 | 50 | 50 |
| 370-1733 | PODSTEP CLIMBER 64"-72" | 1 | 4 | 4 | 165 | 165 |
| 470-0573 | VIPER II SS 96 | 1 | 8 | 8 | 487 | 487 |
| 470-0803 | CONTOUR SLIDE, 64"-72" | 1 | 4 | 4 | 232 | 232 |
| 570-0394 | PIPE WALL | 3 | 0 | 0 | 36 | 108 |
| 570-0398 | STEERING WHEEL ASSEMBLY | 1 | 1 | 1 | 7 | 7 |
| 570-2713 | HIDE THE NUMBERS PANEL | 1 | 2 | 2 | 69 | 69 |

5-12 Structure

Intensity

| Component No. | Description | Qty | User Cap. | Ext. User Cap. | Weight | Ext. Weight |
|---------------|------------------------------|-----|-----------|----------------|--------|-------------|
| 370-0851 | VERTO CLIMBER 3 FS | 1 | 3 | 3 | 103 | 103 |
| 370-0854 | VERTO CLIMBER 1 | 2 | 1 | 2 | 35 | 70 |
| 370-1608 | OVISTEP LAUNCH PAD | 2 | 1 | 2 | 10 | 20 |
| 370-1683 | S HORIZONTAL LADDER, NUCLEUS | 1 | 6 | 6 | 56 | 56 |

Total User Capacity: 95
Total Weight: 5378 lbs.
Total Price: \$77,705

Freestanding

Burke Basics

| Component No. | Description | Qty | User Cap. | Ext. User Cap. | Weight | Ext. Weight |
|---------------|--|-----|-----------|----------------|--------|-------------|
| 550-0099 | TOT SEAT, 7' & 8' SINGLE, STD CHAIN | 1 | 1 | 1 | 12 | 12 |
| 550-0111 | BELT SEAT, 8' SINGLE, STD CHAIN | 2 | 1 | 2 | 10 | 20 |
| 550-0171 | FREEDOM SWING SEAT, 8' BEAM, STD CHAIN | 1 | 1 | 1 | 38 | 38 |
| 550-0201 | SINGLE POST SWING ASSEMBLY 5" OD | 1 | 0 | 0 | 246.78 | 246.78 |
| 550-0202 | SINGLE POST SWING ADD-ON 5" OD | 1 | 0 | 0 | 160.06 | 160.06 |
| 560-0061 | FORMIS DOME | 1 | 11 | 11 | 312 | 312 |
| 560-2735 | ARO SPINNING CHAIR | 1 | 1 | 1 | 42 | 42 |

Total User Capacity: 16
Total Weight: 833 lbs.
Total Price: \$10,595

2-5 Structure

Nucleus

| Component No. | Description | Qty | User Cap. | Ext. User Cap. | Weight | Ext. Weight |
|---------------|---------------------------------------|-----|-----------|----------------|--------|-------------|
| 072-0500-124C | 5" OD X 124" CAPPED POST | 4 | 0 | 0 | 65 | 260 |
| 072-0500-64C | 5" OD X 64" CAPPED POST | 1 | 0 | 0 | 34 | 34 |
| 270-0112 | UNITARY ENCLOSURE | 1 | 0 | 0 | 34 | 34 |
| 270-0130 | SQUARE PLATFORM | 1 | 6 | 6 | 106 | 106 |
| 370-0805 | JUNGLE VINE CLIMBER 48" | 1 | 2 | 2 | 85 | 85 |
| 370-1662 | TRANSFER STATION, BARRIER 48" | 1 | 6 | 6 | 272 | 272 |
| 470-0659 | ROCK'N ROLL SLIDE, 40" - 48" W/O HOOD | 1 | 1 | 1 | 71 | 71 |
| 470-0967 | SLIDE HOOD, LOW SIDE WALL | 1 | 0 | 0 | 37 | 37 |
| 570-0394 | PIPE WALL | 1 | 0 | 0 | 36 | 36 |
| 570-0557 | COUNTER PANEL, BELOW PLATFORM | 1 | 4 | 4 | 37 | 37 |

2-5 Structure

Burke Basics

| Component No. | Description | Qty | User Cap. | Ext. User Cap. | Weight | Ext. Weight |
|---------------|--------------------|-----|-----------|----------------|--------|-------------|
| 580-1364 | LIL NOVO BEAN STEP | 1 | 1 | 1 | 28 | 28 |

Total User Capacity: 20
 Total Weight: 1000 lbs.
 Total Price: \$13,968

Special Notes:

Prices do not include freight, unloading, material storage, site excavation/preparation, removal of existing equipment, removal of excess soil from footing holes, site security, safety surfacing, installation, or sales tax (if applicable). Prices are based on standard colors per CURRENT YEAR BCI Burke Catalog. Custom colors, where available, would be an extra charge. **Pricing is valid for 30 days from the date of this proposal.**

COLOR SELECTION LIST | Default Color Option

GROUP 1 (Freestanding)

Post: Burgundy
Deck: Brown
Plastic: Tan
Acc: Olive
Flat: Olive
Panel: Olive-Black-Olive

GROUP 2 (5-12 Structure)

Post: Burgundy
Acc: Olive
Deck: Brown
Panel: Olive-Black-Olive
Flat: Olive
Plastic: Tan

GROUP 3 (2-5 Structure)

Deck: Brown
Post: Burgundy
Acc: Olive
Flat: Olive
Panel: Olive-Black-Olive
Plastic: Tan

COLORS THAT MOVE YOU

POWDER COAT PAINT



TRADITIONAL SERIES SITE AMENITIES



PLATFORMS

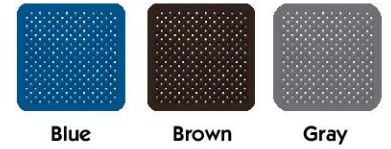

SOLIS HUE TOPPERS



ROCKIT CLIMBERS



HDPE PLASTIC PANELS

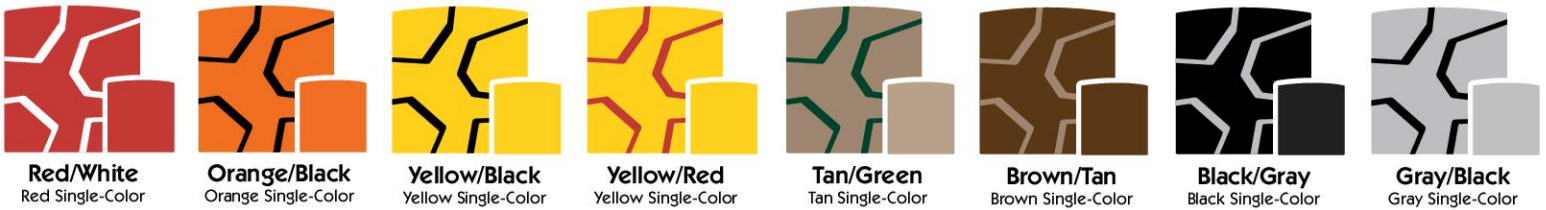

SHADE CANOPIES

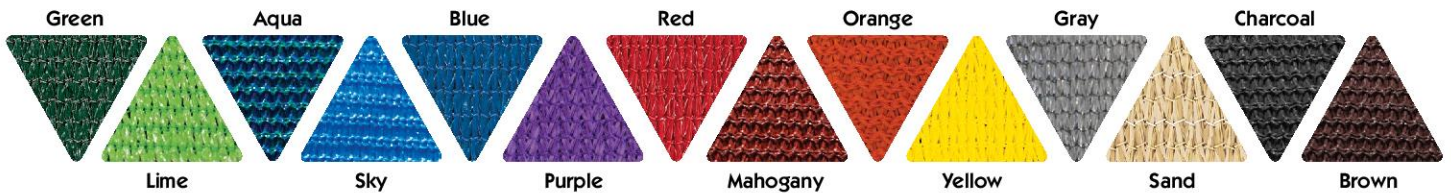

ROTOMOLD PLASTIC

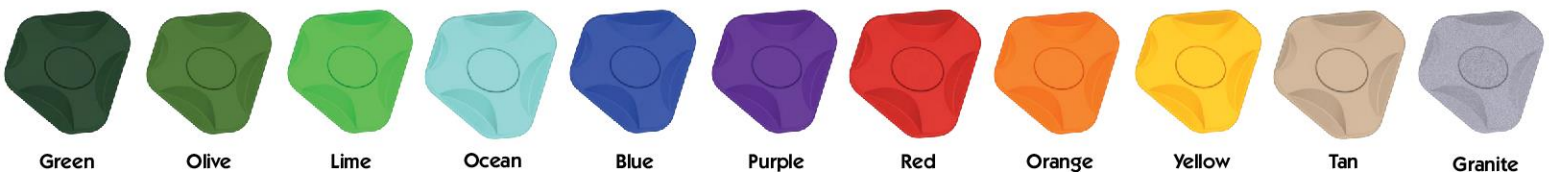

VISIT BCIBURKE.COM/COLOR TO CUSTOMIZE YOUR PLAYGROUND COLORS!

BURKE GENERATIONS WARRANTY®

BCI Burke Company, LLC ("Burke") warrants that all standard products are warranted to be free from defects in materials and workmanship, under normal use and service, for a period of one (1) year from the date of shipment.

We stand behind our products.

In addition, the following products are warranted, under normal use and service from the date of shipment as follows:

- One Hundred (100) Year Limited Warranty on aluminum and steel upright posts (including Nucleus®, Nucleus Evolution®, Nucleus Aspire®, Intensity®, Level X®, Synergy®, Synergy Imagination® & 4ME®) against structural failure due to corrosion, deterioration or workmanship.
- One Hundred (100) Year Limited Warranty on KoreKconnect® Clamp Castings against structural failure due to corrosion, deterioration or workmanship.
- One Hundred (100) Year Limited Warranty on Hardware (nuts, bolts, washers).
- One Hundred (100) Year Limited Warranty on bolt-through and direct-bolt fastening and clamp systems (Synergy®, Intensity®, Nucleus®).
- Twenty-Five (25) Year Limited Warranty on spring assemblies and aluminum cast animals.
- Fifteen (15) Year Limited Warranty on structure platforms and decks, metal roofs, table tops, bench tops, railings and barriers against structural failure due to materials or workmanship.
- Fifteen (15) Year Limited Warranty on all plastic components against structural failure due to materials or workmanship.
- Ten (10) Year Limited Warranty on ShadePlay® Canopies fabric, threads, and cables against degradation, cracking or material breakdown resulting from ultra-violet exposure, natural deterioration or manufacturing defects. This warranty is limited to the design loads as stated in the specifications.
- Ten (10) Year Limited Warranty on NaturePlay® Boulders and GFRC products against structural failure due to natural deterioration or workmanship. Natural wear, which may occur with any concrete product with age, is excluded from this warranty.
- Ten (10) Year Limited Warranty on Full Color Custom Signage against manufacturing defects that cause delamination or degradation of the sign. Full Color Custom Signs also carry a two (2) year warranty against premature fading of the print and graphics on the signs.
- Five (5) Year Limited Warranty on Nucleus®, Intensity®, and RopeVenture® cables against premature wear due to natural deterioration or manufacturing defects. Determination of premature wear will be at the manufacturer's discretion.
- Five (5) Year Limited Warranty on rubber belt material against premature wear due to natural deterioration or manufacturing defects. Determination of premature wear will be at the manufacturer's discretion.
- Five (5) Year Limited Warranty on moving parts, including swing components, against structural failure due to materials or workmanship.
- Five (5) Year Limited Warranty on PlayEnsemble® cables and mallets against defects in materials and workmanship.
- Three (3) Year Limited Warranty on electronic panel speakers, sound chips and circuit boards against electronic failure caused by manufacturing defects.

The warranty stated above is valid only if the equipment is erected in conformity with the layout plan and/or installation instructions furnished by BCI Burke Company, LLC using approved parts; have been maintained and inspected in accordance with BCI Burke Company, LLC instructions. Burke's liability and your exclusive remedy hereunder will be limited to repair or replacement of those parts found in Burke's reasonable judgment to be defective. Any claim made within the above stated warranty periods must be made promptly after discovery of the defect. A part is covered only for the original warranty period of the applicable part. Replacement parts carry the applicable warranty from the date of shipment of the replacement from Burke. After the expiration of the warranty period, you must pay for all parts, transportation and service charges.

Burke reserves the right to accept or reject any claim in whole or in part. Burke will not accept the return of any product without its prior written approval. Burke will assume transportation charges for shipment of the returned product if it is returned in strict compliance with Burke's written instructions.

THE FOREGOING WARRANTIES ARE EXCLUSIVE AND IN LIEU OF ANY OTHER WARRANTY, EXPRESS OR IMPLIED, INCLUDING BUT NOT LIMITED TO ANY IMPLIED WARRANTY OR MERCHANTABILITY OR FITNESS FOR A PARTICULAR PURPOSE. IF THE FOREGOING DISCLAIMER OF ADDITIONAL WARRANTIES IS NOT GIVEN FULL FORCE AND EFFECT, ANY RESULTING ADDITIONAL WARRANTY SHALL BE LIMITED IN DURATION TO THE EXPRESS WARRANTIES AND BE OTHERWISE SUBJECT TO AND LIMITED BY THE TERMS OF BURKE'S PRODUCT WARRANTY. SOME STATES DO NOT ALLOW THE EXCLUSION OF CERTAIN IMPLIED WARRANTIES, SO THE ABOVE LIMITATION MAY NOT APPLY TO YOU.

Warranty Exclusions: The above stated warranties do not cover: "cosmetic" defects, such as scratches, dents, marring, or fading; damage due to incorrect installation, vandalism, misuse, accident, wear and tear from normal use, exposure to extreme weather, immersion in salt or chlorine water, unauthorized repair or modification, abnormal use, lack of maintenance, or other cause not within Burke's control; and

Limitation of Remedies: Burke is not liable for consequential or incidental damages, including but not limited to labor costs or lost profits resulting from the use of or inability to use the products or from the products being incorporated in or becoming a component of any other product. If, after a reasonable number of repeated efforts, Burke is unable to repair or replace a defective or nonconforming product, Burke shall have the option to accept return of the product, or part thereof, if such does not substantially impair its value, and return the purchase price as the buyer's entire and exclusive remedy. Without limiting the generality of the foregoing, Burke will not be responsible for labor costs involved in the removal of products or the installation of replacement products. Some states do not allow the exclusion of incidental damages, so the above exclusion may not apply to you.

The environment near a saltwater coast can be extremely corrosive. Some corrosion and/or deterioration is considered "normal wear" in this environment. Product installed within 500 yards of a saltwater shoreline will only be covered for half the period of the standard product warranty, up to a maximum of five years, for defects caused by corrosion. Products installed in direct contact with saltwater or that are subjected to salt spray are not covered by the standard warranty for any defects caused by corrosion.

Contact your local Burke Representative for warranty information regarding Burke Turf® and Burke Tile products.

Terms of Sale

Pricing: Prices published in this catalog are in USD, are approximate and do not include shipping & handling, surfacing, installation nor applicable taxes. All prices are subject to change without notice. Contact your Burke representative for current pricing. Payments are to be made in USD.

Weights: Weights are approximate and may vary with actual orders.

Installation: All equipment is shipped unassembled. For a list of factory-certified installers in your area, please contact your Burke representative.

Specifications: Product specifications in this catalog were correct at the time of publication. However, product improvements are ongoing at Burke, and we reserve the right to change or discontinue specifications without notice.

Loss or Damage in Transit: A signed bill of lading is our receipt from a carrier that our shipment to you was complete and in good condition upon arrival. Before you sign, please check the Bill of Lading carefully when the shipment arrives to make sure nothing is missing and there are no damages. Once the shipment leaves our plant, we are no longer responsible for any damage, loss or shortage.

For more information regarding the warranty, call Customer Service at 920-921-9220 or 800-356-2070.

01/2025