

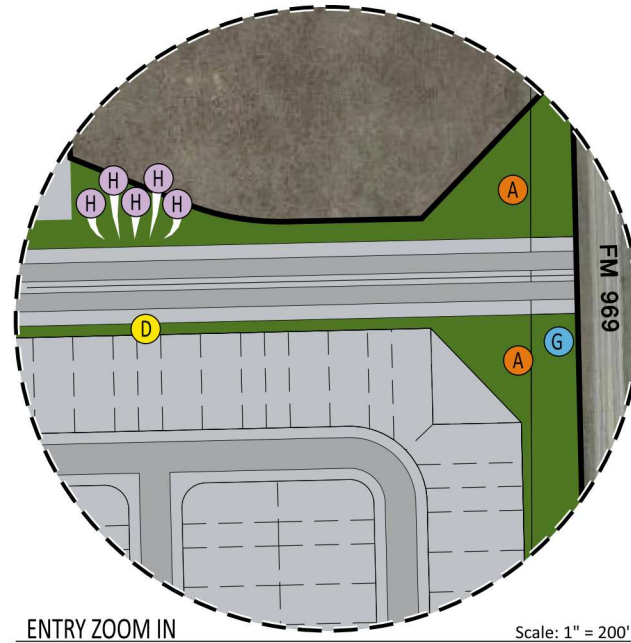

SIGN LEGEND

- A** Entry Monument Sign (2)
- B** Neighborhood Monument Sign (15)
- C** Model Home Sidewalk Sign (7)
- D** New Home Direction Sign (12)
- E** Sold / Available Sign (One per Lot Allowed)
- F** Model Home Information Sign (2)
- G** Temporary Community Entry Sign (1)
- H** Temporary New Home Sign (5)

Zone P-1



ENTRY ZOOM IN

Scale: 1" = 200'



Scale: 1" = 1000'
Date: January 09, 2024

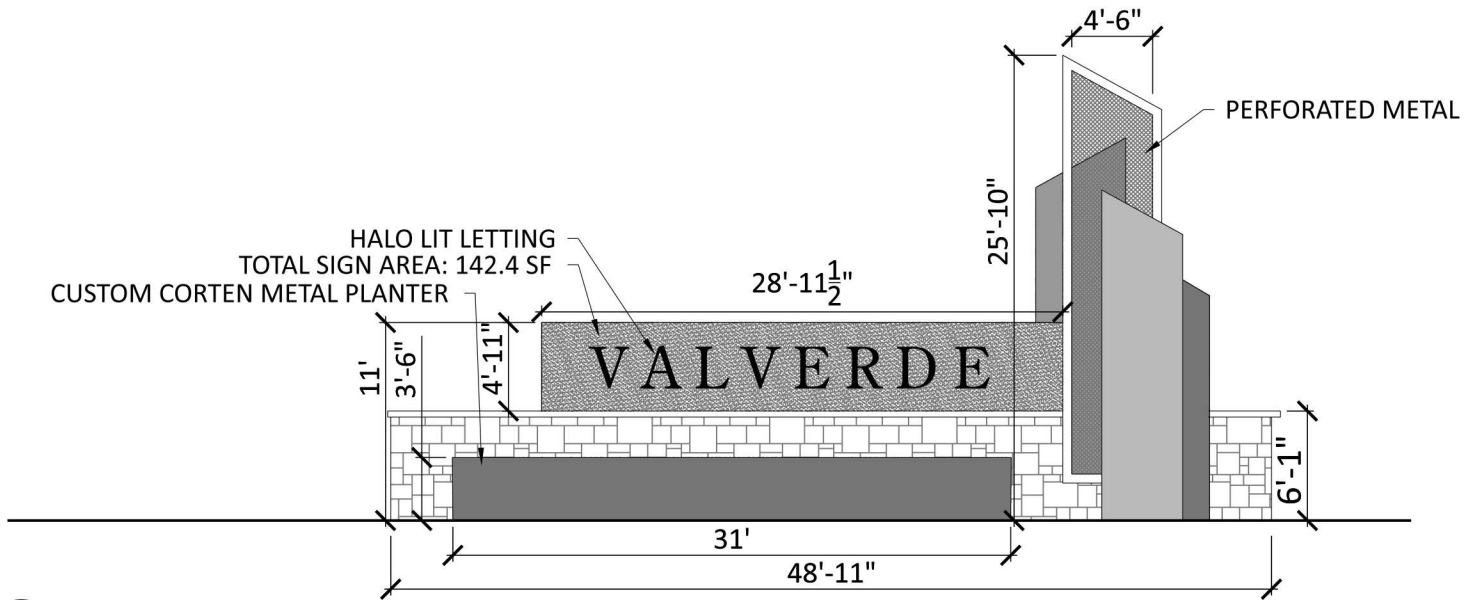

A ENTRY MONUMENT - MONUMENT SIGN
 Scale: 3/32" = 1'-0"

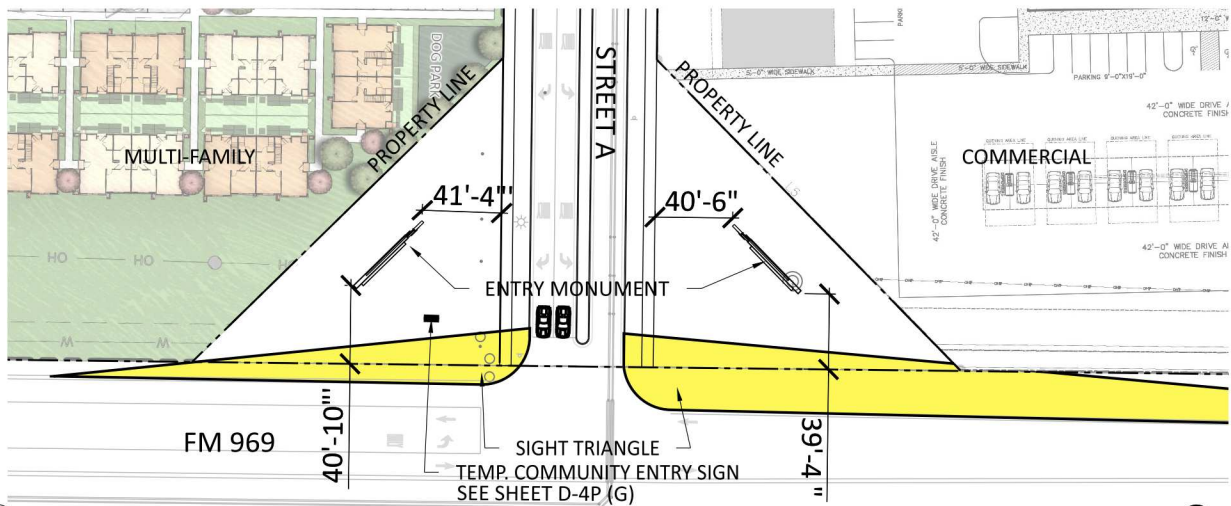

A-1 ENTRY MONUMENT DETAIL PLAN
 Scale: 1" = 100'



A-2 ENTRY MONUMENT - ILLUSTRATION
 Scale: NTS

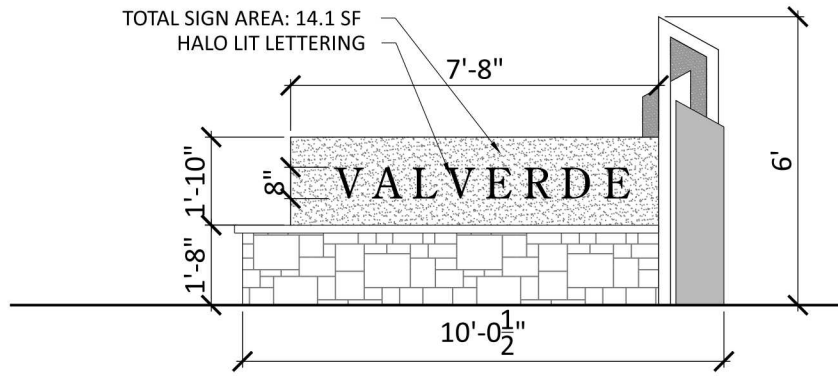

B NEIGHBORHOOD MONUMENT SIGN - MONUMENT SIGN
Scale: 1/4" = 1'-0"



B-1 NEIGHBORHOOD MONUMENT SIGN - ILLUSTRATION
Scale: NTS

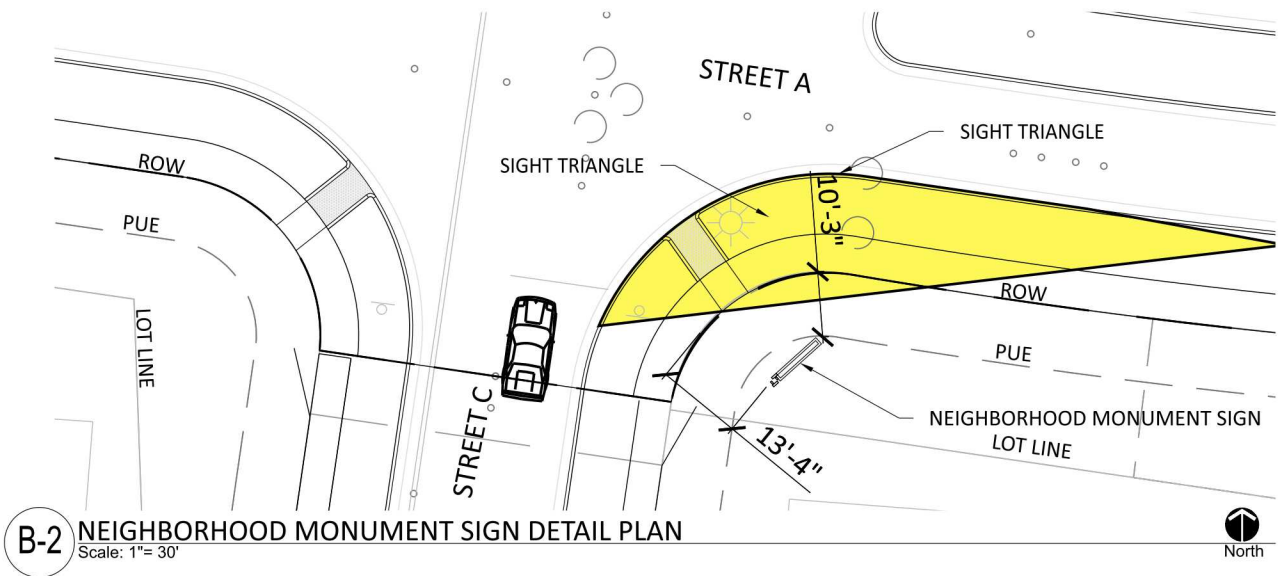

B-2 NEIGHBORHOOD MONUMENT SIGN DETAIL PLAN
Scale: 1" = 30'

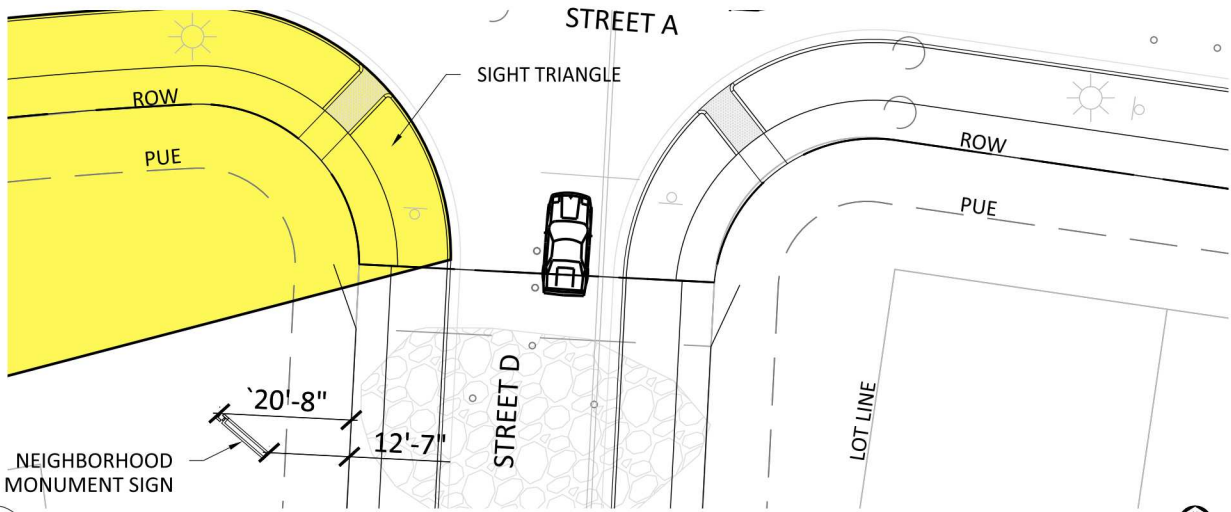

B-3 NEIGHBORHOOD MONUMENT SIGN DETAIL PLAN
Scale: 1"= 30'

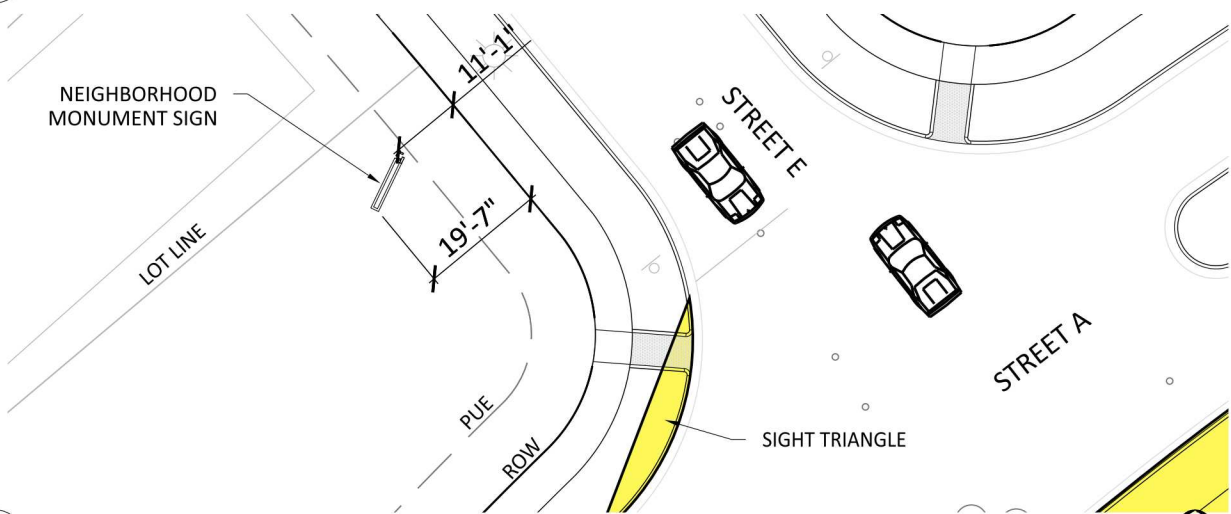

B-4 NEIGHBORHOOD MONUMENT SIGN DETAIL PLAN
Scale: 1"= 30'

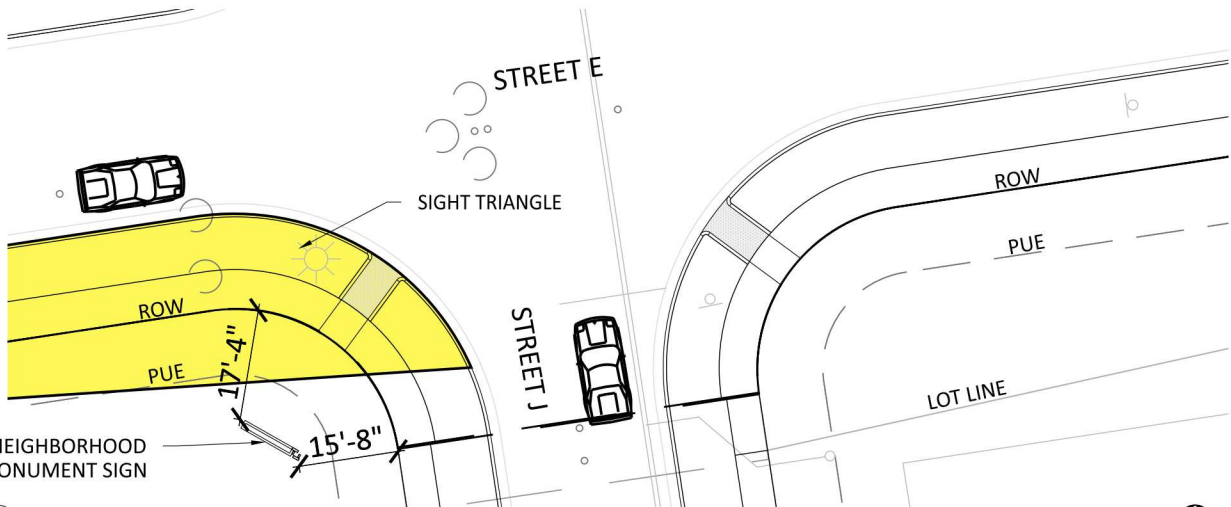

B-5 NEIGHBORHOOD MONUMENT SIGN DETAIL PLAN
Scale: 1"= 30'



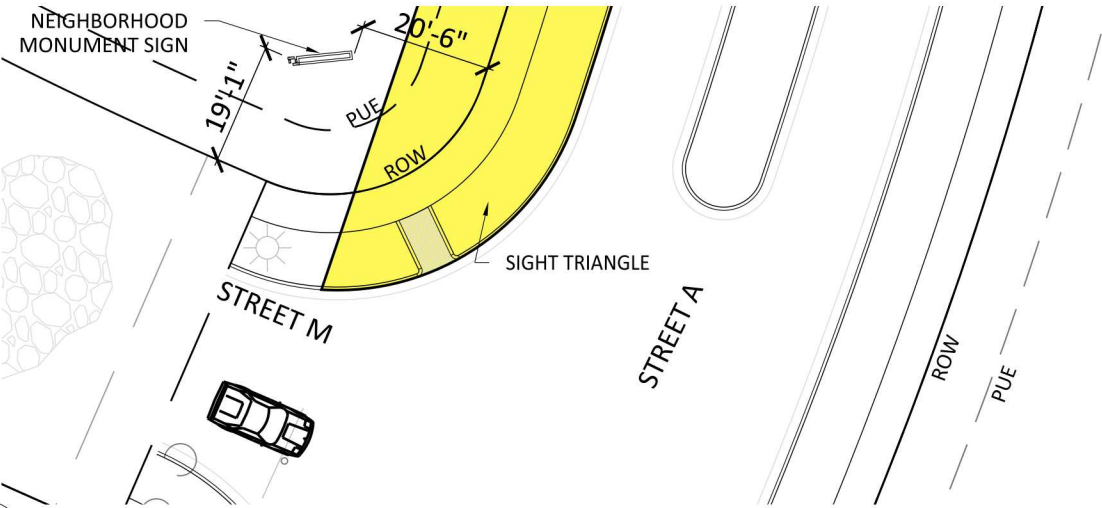

B-6 NEIGHBORHOOD MONUMENT SIGN DETAIL PLAN
Scale: 1" = 30'

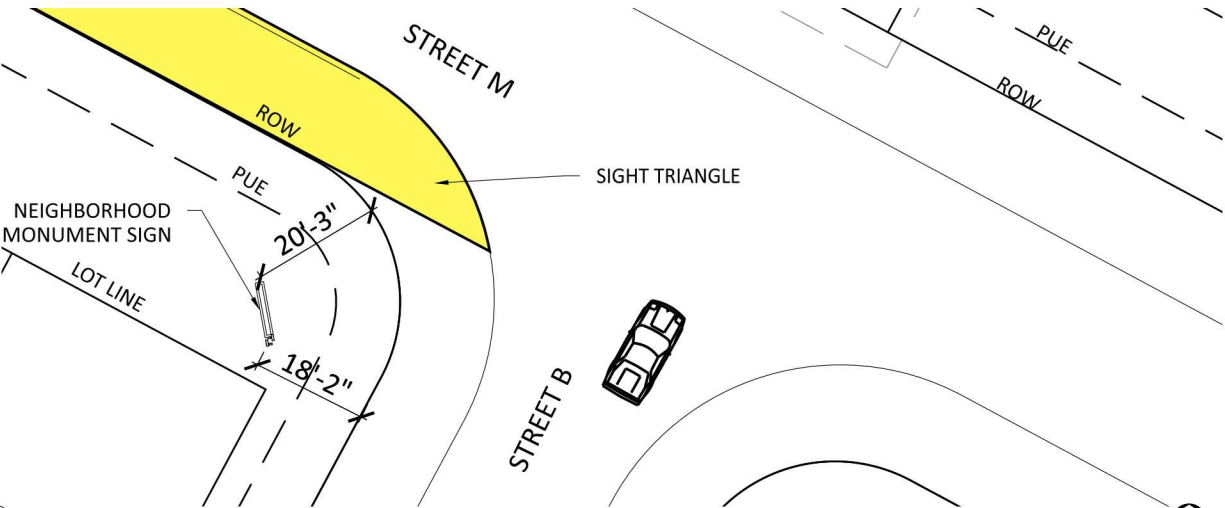

B-7 NEIGHBORHOOD MONUMENT SIGN DETAIL PLAN
Scale: 1" = 30'

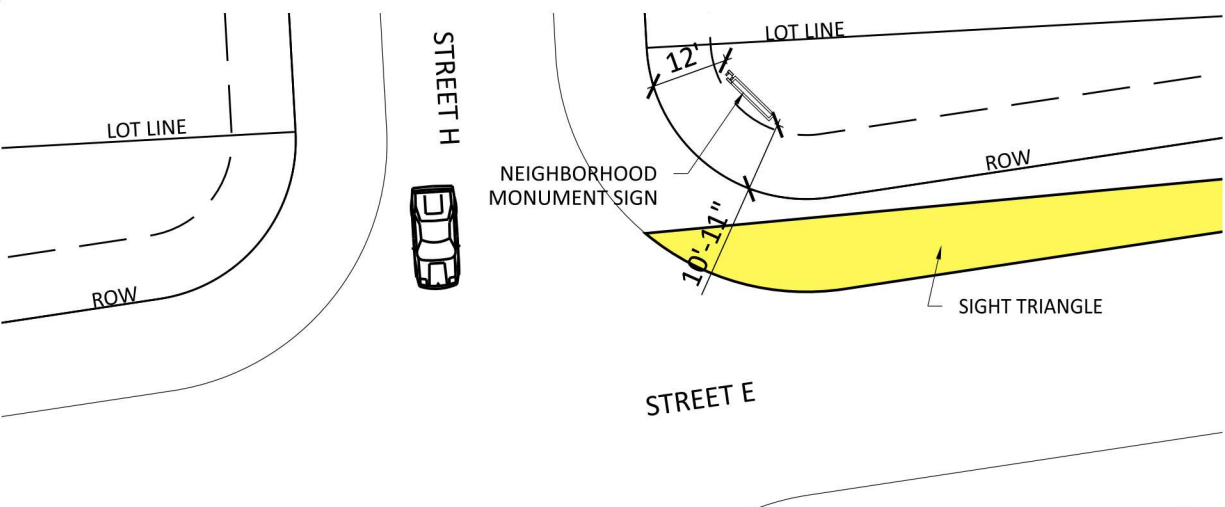

B-8 NEIGHBORHOOD MONUMENT SIGN DETAIL PLAN
Scale: 1" = 30'



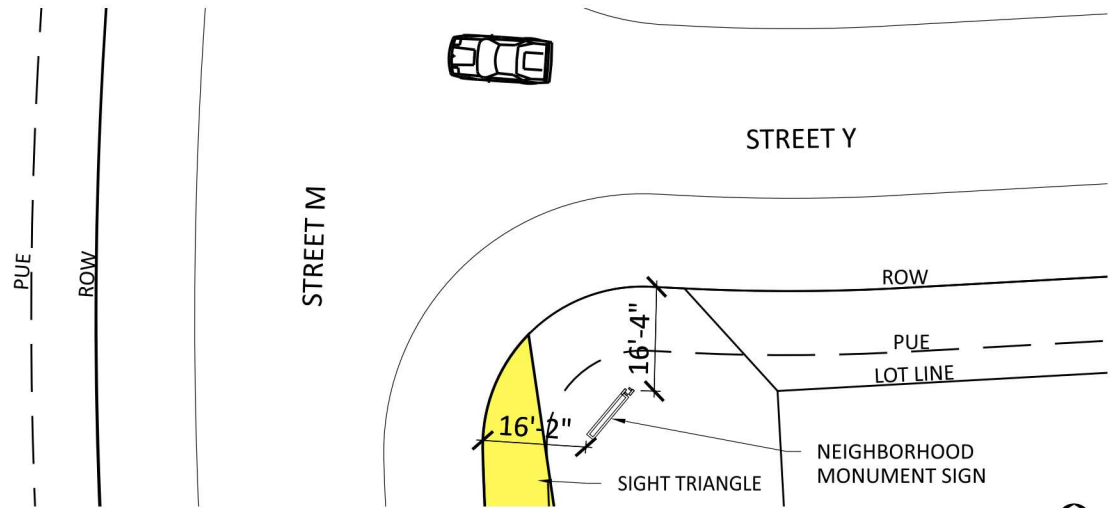

B-9 NEIGHBORHOOD MONUMENT SIGN DETAIL PLAN

Scale: 1"= 30'

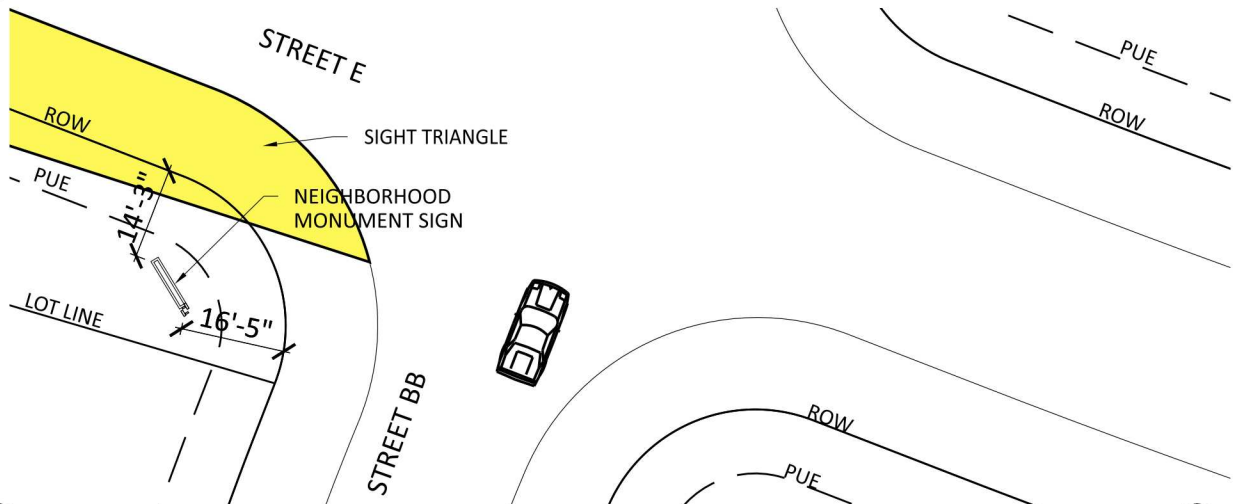

B-10 NEIGHBORHOOD MONUMENT SIGN DETAIL PLAN

Scale: 1"= 30'

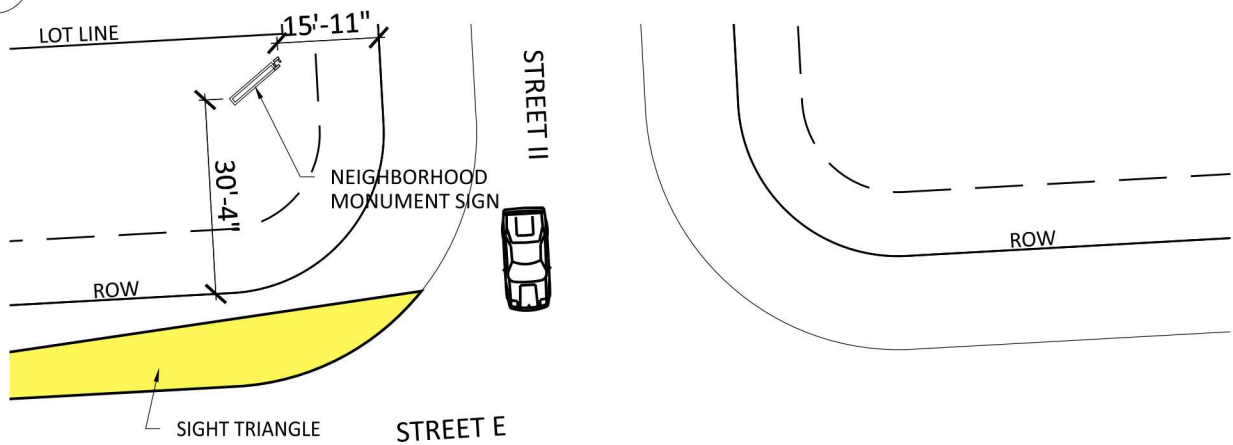

B-11 NEIGHBORHOOD MONUMENT SIGN DETAIL PLAN

Scale: 1"= 30'



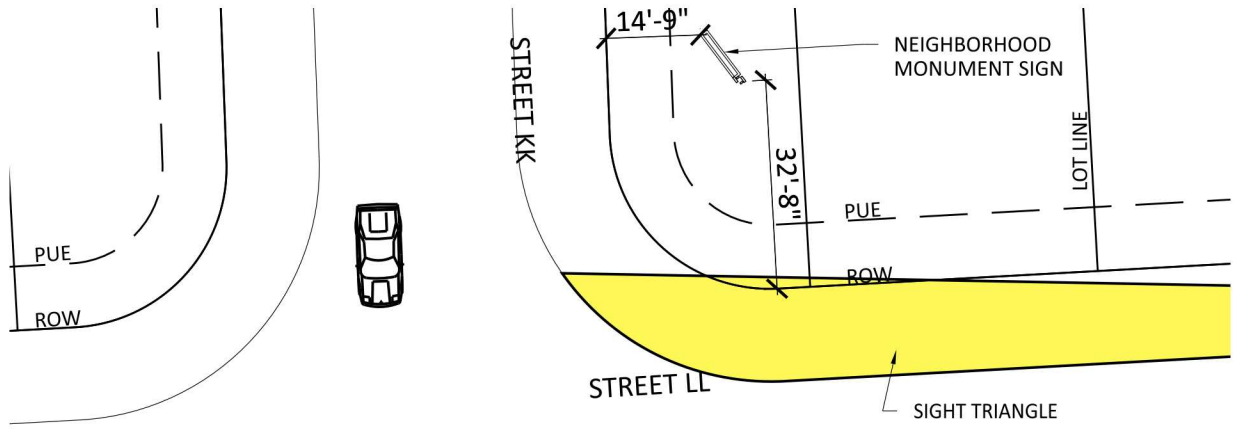

B-12 NEIGHBORHOOD MONUMENT SIGN DETAIL PLAN

Scale: 1"= 30'

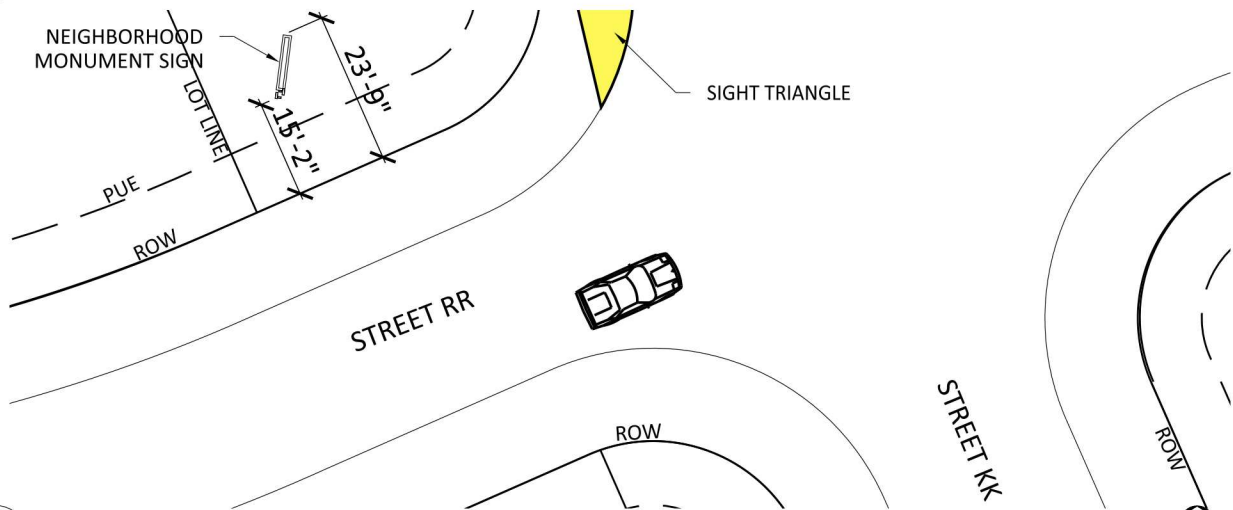

B-13 NEIGHBORHOOD MONUMENT SIGN DETAIL PLAN

Scale: 1"= 30'

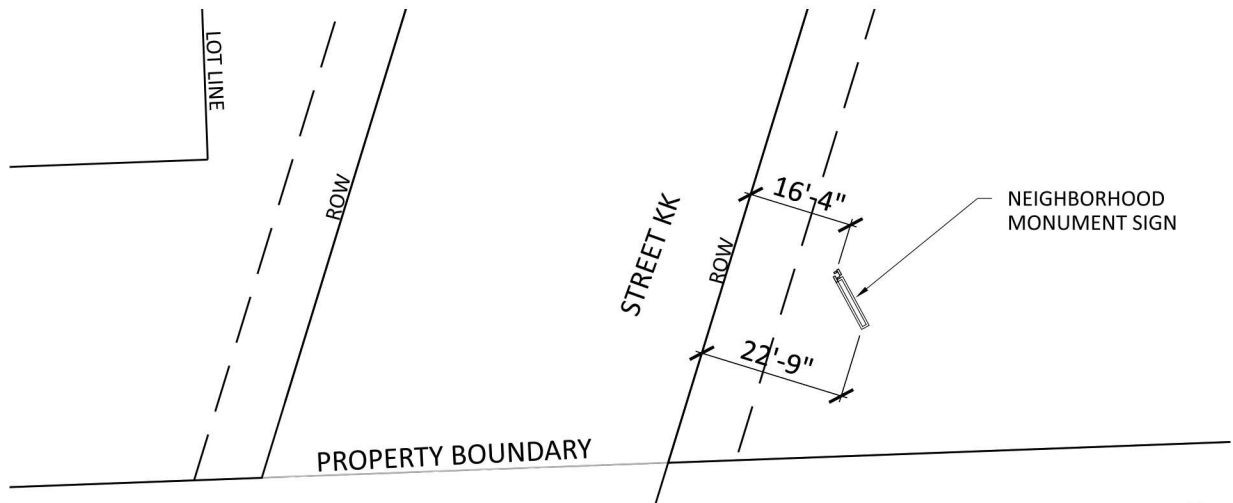

B-14 NEIGHBORHOOD MONUMENT SIGN DETAIL PLAN

Scale: 1"= 30'



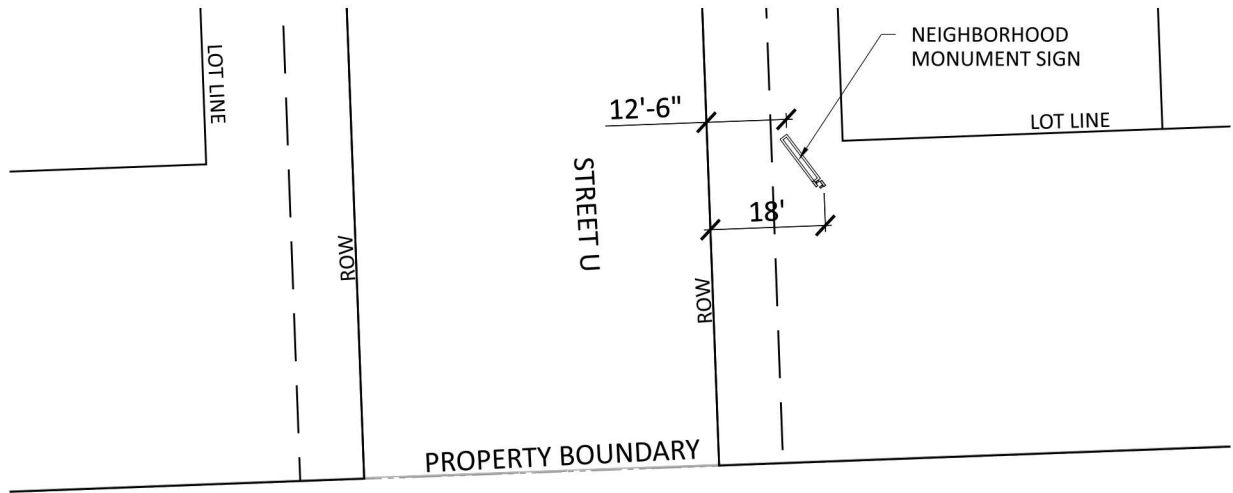

B-15 NEIGHBORHOOD MONUMENT SIGN DETAIL PLAN

Scale: 1"= 30'

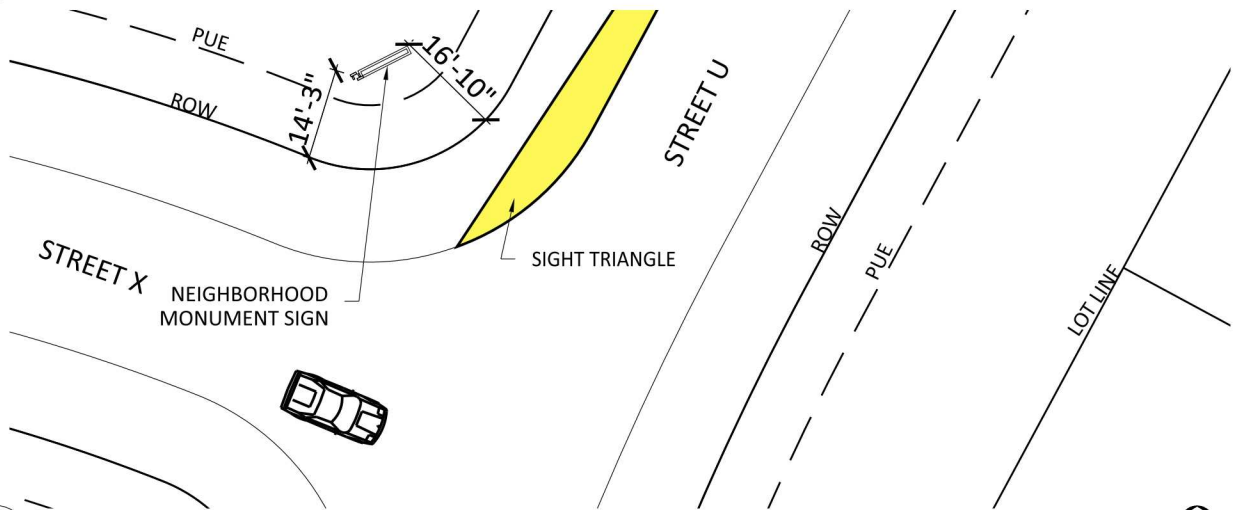

B-16 NEIGHBORHOOD MONUMENT SIGN DETAIL PLAN

Scale: 1"= 30'



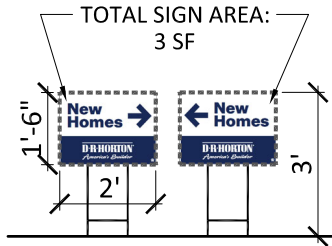
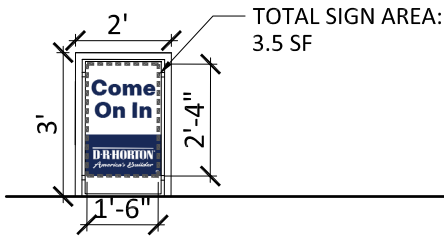

C MODEL HOME SIDEWALK SIGN - REAL ESTATE SIGN Scale: 1/4" = 1'-0"

D NEW HOME DIRECTION SIGN - REAL ESTATE SIGN Scale: 1/4" = 1'-0"

E SOLD / AVAILABLE SIGN - REAL ESTATE SIGN Scale: 1/4" = 1'-0"

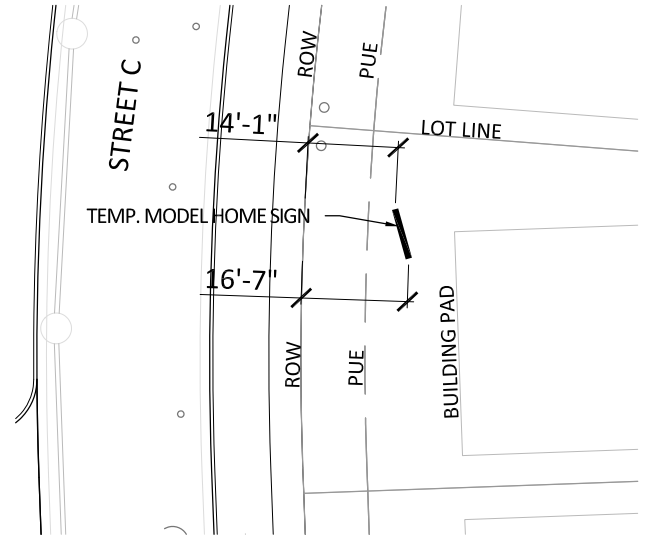
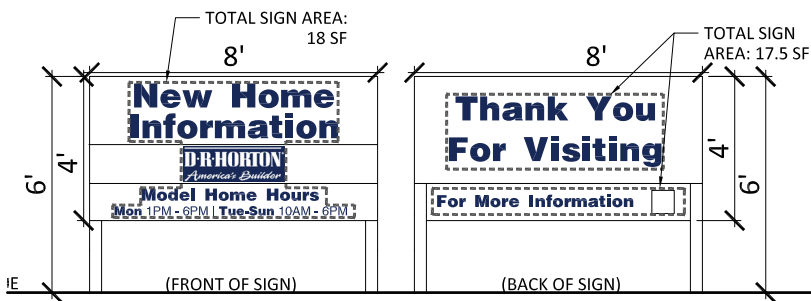

F MODEL HOME INFORMATION SIGN - DEVELOPMENT INFORMATION SIGN Scale: 3/16" = 1'-0"

F-1 MODEL HOME INFORMATION SIGN DETAIL PLAN Scale: 1" = 30' North

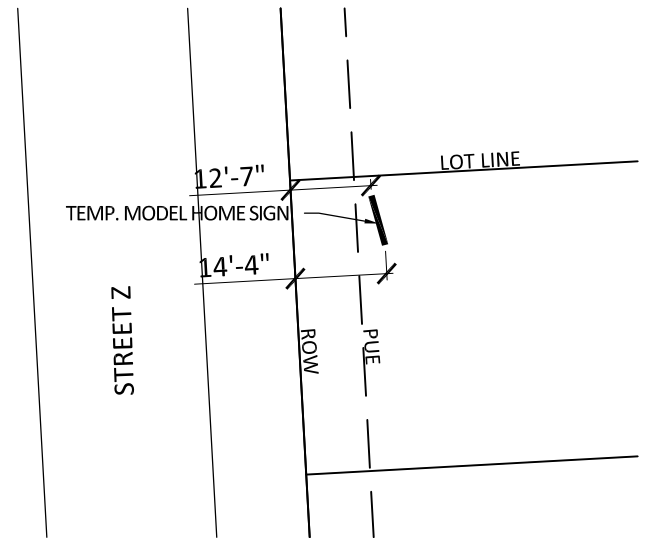

F-2 MODEL HOME INFORMATION SIGN DETAIL PLAN Scale: 1" = 30' North



G TEMPORARY COMMUNITY ENTRY SIGN - CONSTRUCTION SITE SIGN Scale: 1/4" = 1'-0"



G-1 COMMUNITY ENTRY SIGN PROTOTYPICAL DETAIL PLAN Scale: 1" = 100' North

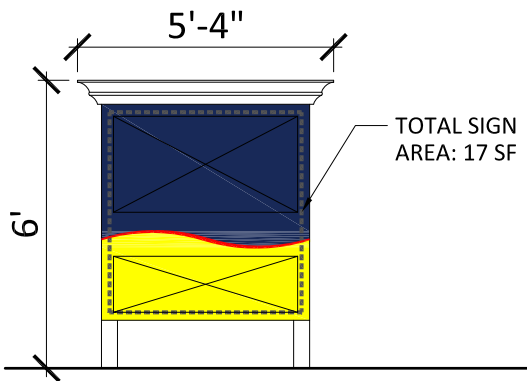

H TEMPORARY NEW HOMES SIGN- DEVELOPMENT INFORMATION SIGN Scale: 1/4" = 1'-0"

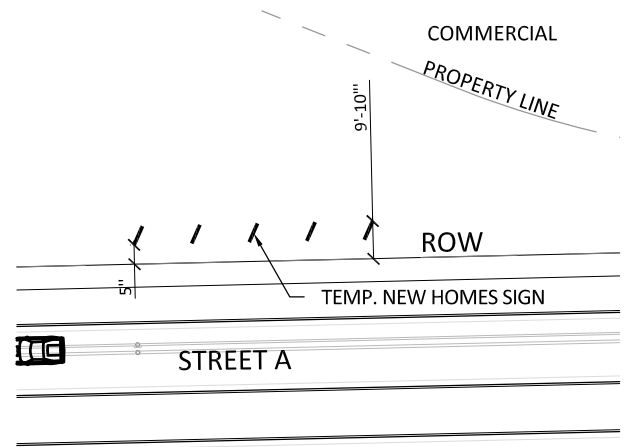

H-1 NEW HOME SIGN - PROTOTYPICAL DETAIL PLAN Scale: 1" = 50' North